

# FCC TEST REPORT (PART 22)



Applicant:	Gosuncn Technology Group Co., Ltd.
Address:	6F, 2819 KaiChuang Blvd., Science Town, Huangpu District, Guangzhou City, Guangdong, China.

Manufacturer or Supplier:	Gosuncn Technology Group Co., Ltd.
Address:	6F, 2819 KaiChuang Blvd., Science Town, Huangpu District, Guangzhou City, Guangdong, China.
Product:	LTE Module
Brand Name:	GOSUNCN
Model Name:	GM500_U1A
FCC ID:	2APNR-GM500U1A
Date of tests:	Apr. 27, 2018 ~ May 29, 2017

The tests have been carried out according to the requirements of the following standard:

- FCC PART 22, Subpart H**
- ANSI/TIA/EIA-603-D**
- ANSI/TIA/EIA-603-E**

**CONCLUSION:** The submitted sample was found to COMPLY with the test requirement

Prepared by Yuqiang Yin Engineer / Mobile Department	Approved by Sam Tung Manager / Mobile Department
 Date: May 30, 2017	 Date: May 30, 2017
<small>This report is governed by, and incorporates by reference, CPS Conditions of Service as posted at the date of issuance of this report at <a href="http://www.bureauveritas.com/home/about-us/our-business/cps/about-us/terms-conditions">http://www.bureauveritas.com/home/about-us/our-business/cps/about-us/terms-conditions</a> and is intended for your exclusive use. Any copying or replication of this report to or for any other person or entity, or use of our name or trademark, is permitted only with our prior written permission. This report sets forth our findings solely with respect to the test samples identified herein. The results set forth in this report are not indicative or representative of the quality or characteristics of the lot from which a test sample was taken or any similar or identical product unless specifically and expressly noted. Our report includes all of the tests requested by you and the results thereof based upon the information that you provided to us. Measurement uncertainty is only provided upon request for accredited tests. You have 60 days from date of issuance of this report to notify us of any material error or omission caused by our negligence or if you require measurement uncertainty; provided, however, that such notice shall be in writing and shall specifically address the issue you wish to raise. A failure to raise such issue within the prescribed time shall constitute your unqualified acceptance of the completeness of this report, the tests conducted and the correctness of the report contents.</small>	



# TABLE OF CONTENTS

<b>RELEASE CONTROL RECORD</b> .....	<b>4</b>
<b>1 SUMMARY OF TEST RESULTS</b> .....	<b>5</b>
1.1 MEASUREMENT UNCERTAINTY .....	5
1.2 TEST SITE AND INSTRUMENTS .....	6
<b>2 GENERAL INFORMATION</b> .....	<b>7</b>
2.1 GENERAL DESCRIPTION OF EUT .....	7
2.2 CONFIGURATION OF SYSTEM UNDER TEST .....	9
2.3 DESCRIPTION OF SUPPORT UNITS .....	10
2.4 TEST ITEM AND TEST CONFIGURATION.....	10
2.5 EUT OPERATING CONDITIONS.....	13
2.6 GENERAL DESCRIPTION OF APPLIED STANDARDS.....	13
<b>3 TEST TYPES AND RESULTS</b> .....	<b>14</b>
3.1 OUTPUT POWER MEASUREMENT .....	14
3.1.1 LIMITS OF OUTPUT POWER MEASUREMENT .....	14
3.1.2 TEST PROCEDURES .....	14
3.1.3 TEST SETUP.....	15
3.1.4 TEST RESULTS .....	16
3.2 FREQUENCY STABILITY MEASUREMENT .....	23
3.2.1 LIMITS OF FREQUENCY STABILITY MEASUREMENT .....	23
3.2.2 TEST PROCEDURE .....	23
3.2.3 TEST SETUP.....	23
3.2.4 TEST RESULTS .....	24
3.3 OCCUPIED BANDWIDTH MEASUREMENT .....	31
3.3.1 TEST PROCEDURES .....	31
3.3.2 TEST SETUP.....	31
3.3.3 TEST RESULTS .....	32
3.4 BAND EDGE MEASUREMENT .....	38
3.4.1 LIMITS OF BAND EDGE MEASUREMENT .....	38
3.4.2 TEST SETUP.....	38
3.4.3 TEST PROCEDURES .....	39
3.4.4 TEST RESULTS .....	40
3.5 CONDUCTED SPURIOUS EMISSIONS.....	45
3.5.1 LIMITS OF CONDUCTED SPURIOUS EMISSIONS MEASUREMENT .....	45
3.5.2 TEST PROCEDURE .....	45
3.5.3 TEST SETUP.....	45
3.5.4 TEST RESULTS .....	46
3.6 RADIATED EMISSION MEASUREMENT.....	53
3.6.1 LIMITS OF RADIATED EMISSION MEASUREMENT .....	53
3.6.2 TEST PROCEDURES .....	53
3.6.3 DEVIATION FROM TEST STANDARD .....	53
3.6.4 TEST SETUP.....	54



**BUREAU  
VERITAS**

**Test Report No.: RF180521W014-1**

3.6.5	TEST RESULTS .....	56
3.7	PEAK TO AVERAGE RATIO .....	88
3.7.1	LIMITS OF PEAK TO AVERAGE RATIO MEASUREMENT .....	88
3.7.2	TEST SETUP .....	88
3.7.3	TEST PROCEDURES .....	88
3.7.4	TEST RESULTS .....	89
<b>4</b>	<b>PHOTOGRAPHS OF THE TEST CONFIGURATION .....</b>	<b>100</b>
<b>5</b>	<b>INFORMATION ON THE TESTING LABORATORIES .....</b>	<b>101</b>
<b>6</b>	<b>APPENDIX A – MODIFICATIONS RECORDERS FOR ENGINEERING CHANGES TO THE EUT BY THE LAB .....</b>	<b>102</b>



**BUREAU**  
**VERITAS**

Test Report No.: RF180521W014-1

## RELEASE CONTROL RECORD

ISSUE NO.	REASON FOR CHANGE	DATE ISSUED
RF180521W014-1	Original release	May 30, 2017

## 1 SUMMARY OF TEST RESULTS

The EUT has been tested according to the following specifications:

APPLIED STANDARD: FCC Part 22 & Part 2			
STANDARD SECTION	TEST TYPE	RESULT	REMARK
2.1046 22.913 (a)	Effective Radiated Power	PASS	Meet the requirement of limit.
2.1055 22.355	Frequency Stability	PASS	Meet the requirement of limit.
2.1049 22.917b	Occupied Bandwidth	PASS	Meet the requirement of limit.
--	Peak to average ratio*	PASS	Meet the requirement of limit.
22.917	Band Edge Measurements	PASS	Meet the requirement of limit.
2.1051 22.917	Conducted Spurious Emissions	PASS	Meet the requirement of limit.
2.1053 22.917	Radiated Spurious Emissions	PASS	Meet the requirement of limit. Minimum passing margin is -20.61dB at1648.000MHz.

\* Refer to KDB 971168 D01 Power Meas License Digital Systems v02r02.

### 1.1 MEASUREMENT UNCERTAINTY

Where relevant, the following measurement uncertainty levels have been estimated for tests performed on the EUT as specified in CISPR 16-4-2:

MEASUREMENT	FREQUENCY	UNCERTAINTY
Conducted emissions	9kHz~30MHz	2.66dB
Radiated emissions	9KHz ~ 30MHz	2.68dB
	30MHz ~ 1GHz	3.26dB
	1GHz ~ 18GHz	4.48dB
	18GHz ~ 40GHz	4.12dB

This uncertainty represents an expanded uncertainty expressed at approximately the 95% confidence level using a coverage factor of k=2.

## 1.2 TEST SITE AND INSTRUMENTS

Equipment	Manufacturer	Model No.	Serial No.	Last Cal.	Next Cal.
MXE EMI Receiver	KEYSIGHT	N9038A-544	MY54450026	Mar. 16,18	Mar. 15,19
EXA Signal Analyzer	KEYSIGHT	N9010A-544	MY54510332	Jun. 28,17	Jun. 27,18
Bilog Antenna 1	ETS-LINDGREN	3143B	00161964	Nov. 26,16	Nov. 25,18
Bilog Antenna 2	ETS-LINDGREN	3143B	00161965	Nov. 26,16	Nov. 25,18
Horn Antenna 1	ETS-LINDGREN	3117	00168728	Nov. 26,16	Nov. 25,18
Horn Antenna 2	ETS-LINDGREN	3117	00168692	Nov. 26,16	Nov. 25,18
Loop antenna	Daze	ZN30900A	0708	Nov. 20,17	Nov. 19,18
Horn Antenna (18GHz-40GHz)	N/A	QWH-SL-18-40 -K-SG/QMS-00 361	15433	Dec. 16,16	Dec. 15,18
Radio Communication Analyzer	ANRITSU	MT8820C	6201465426	Mar. 02,18	Mar. 01,19
Signal Pre-Amplifier	EMSI	EMC 9135	980249	Jul. 24,17	Jul. 23,18
Signal Pre-Amplifier	EMSI	EMC 012645B	980257	Jul. 24,17	Jul. 23,18
Signal Pre-Amplifier	EMSI	EMC 184045B	980259	Jul. 24,17	Jul. 23,18
3m Semi-anechoic Chamber	ETS-LINDGREN	9m*6m*6m	Euroshieldpn- CT0001143-1216	Apr. 21,18	Apr. 20,19
Test Software	E3	V 9.160323	N/A	N/A	N/A
Test Software	ADT	ADT_Radiated _V7.6.15.9.2	N/A	N/A	N/A
10dB Attenuator	JFW/USA	50HF-010-SM A	1505	Jul. 24,17	Jul. 23,18
Power Meter	Anritsu	ML2495A	1506002	Mar. 02,18	Mar. 01,19
Power Sensor	Anritsu	MA2411B	1339352	Mar. 16,18	Mar. 15,19
Humid & Temp Programmable Tester	Juyi	ITH-120-45-CP -AR	IAA1504-001	Jul. 18,17	Jul. 17,18
MXG Analog Microvave Signal Generator	KEYSIGHT	N5183A	MY50143024	Mar. 13,18	Mar. 12,19

- NOTE:**
1. The calibration interval of the above test instruments is 12 months or 24 months and the calibrations are traceable to CEPREI/CHINA, GRGT/CHINA and NIM/CHINA.
  2. The test was performed in 3m Semi-anechoic Chamber and RF Oven Room.
  3. The horn antenna is used only for the measurement of emission frequency above 1GHz if tested.
  4. The FCC Site Registration No. is 525120.

## 2 GENERAL INFORMATION

### 2.1 GENERAL DESCRIPTION OF EUT

<b>EUT</b>	LTE Module	
<b>MODEL NAME</b>	GM500_U1A	
<b>POWER SUPPLY</b>	DC 3.8V	
<b>MODULATION TYPE</b>	<b>GSM/GPRS/EDGE</b>	GMSK
	<b>WCDMA</b>	BPSK,QPSK
	<b>LTE</b>	QPSK, 16QAM
<b>FREQUENCY RANGE</b>	<b>GSM/GPRS/EDGE</b>	824.2MHz ~ 848.8MHz
	<b>WCDMA</b>	826.4MHz ~ 846.6MHz
	<b>LTE Band 5 (Channel Bandwidth: 1.4MHz)</b>	824.7MHz ~ 848.3MHz
	<b>LTE Band 5 (Channel Bandwidth: 3MHz)</b>	825.5MHz ~ 847.5MHz
	<b>LTE Band 5 (Channel Bandwidth: 5MHz)</b>	826.5MHz ~ 846.5MHz
	<b>LTE Band 5 (Channel Bandwidth: 10MHz)</b>	829MHz ~ 844MHz
<b>MAX. ERP POWER</b>	<b>GSM</b>	1701mW
	<b>EDGE</b>	425mW
	<b>WCDMA</b>	228mW
	<b>LTE Band 5 (Channel Bandwidth: 1.4MHz)</b>	406mW
	<b>LTE Band 5 (Channel Bandwidth: 3MHz)</b>	413mW
	<b>LTE Band 5 (Channel Bandwidth: 5MHz)</b>	409mW
	<b>LTE Band 5 (Channel Bandwidth: 10MHz)</b>	346mW
<b>EMISSION DESIGNATOR</b>	<b>GSM</b>	245KGXW
	<b>EDGE</b>	247KG7W
	<b>WCDMA</b>	4M14F9W
	<b>LTE Band 5 (Channel Bandwidth: 1.4MHz)</b>	QPSK: 1M09G7D
		16QAM: 1M09W7D
	<b>LTE Band 5 (Channel Bandwidth: 3MHz)</b>	QPSK: 2M69G7D
		16QAM: 2M68W7D
	<b>LTE Band 5 (Channel Bandwidth: 5MHz)</b>	QPSK: 4M47G7D
16QAM: 4M47W7D		
<b>LTE Band 5 (Channel Bandwidth: 10MHz)</b>	QPSK: 8M95G7D	
	16QAM: 8M94W7D	



**BUREAU**  
**VERITAS**

Test Report No.: RF180521W014-1

<b>ANTENNA TYPE</b>	External antenna with 3.5dBi gain
<b>HW VERSION</b>	GM500-MB_A
<b>SW VERSION</b>	GM500U1A1.0B01
<b>I/O PORTS</b>	Refer to user's manual
<b>DATA CABLE</b>	N/A

**NOTE:**

1. For a more detailed features description, please refer to the manufacturer's specifications or the user's manual.
2. For the test results, the EUT had been tested with all conditions. But only the worst case was shown in test report.



## 2.2 CONFIGURATION OF SYSTEM UNDER TEST

### FOR RADIATION EMISSION

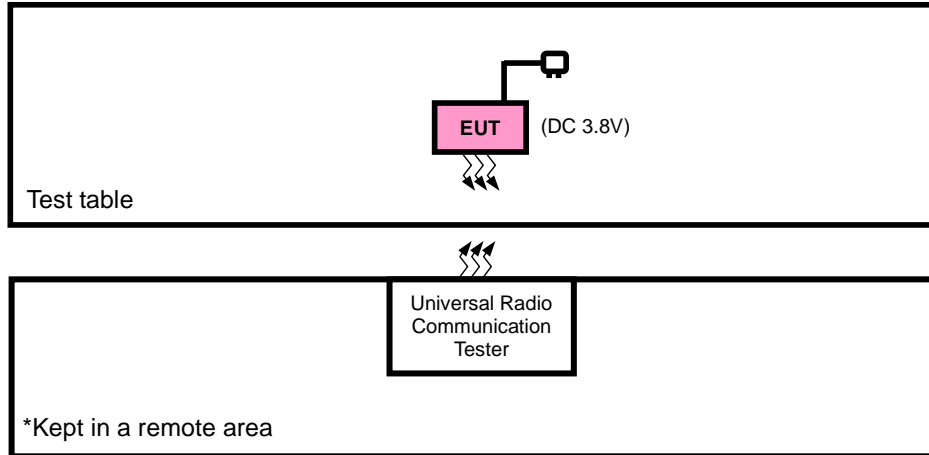

### FOR CONDUCTED & E.R.P. TEST

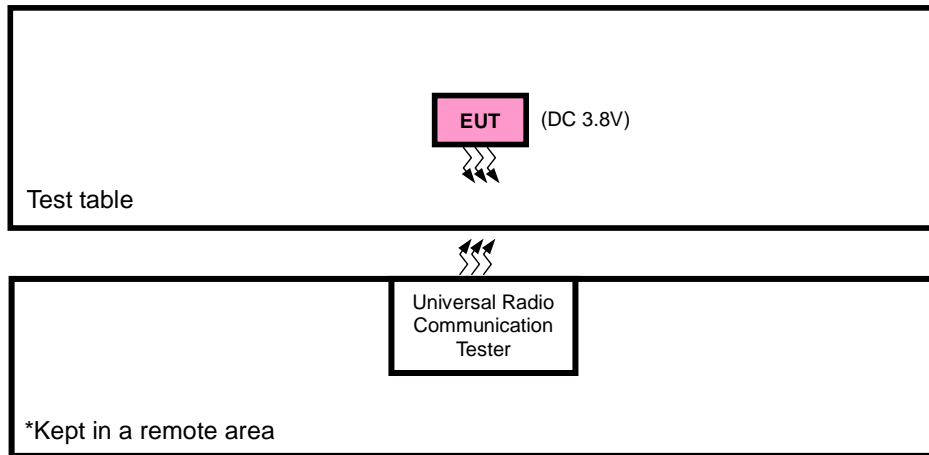

## 2.3 DESCRIPTION OF SUPPORT UNITS

The EUT has been tested as an independent unit together with other necessary accessories or support units. The following support units or accessories were used to form a representative test configuration during the tests.

NO.	PRODUCT	BRAND	MODEL NO.	SERIAL NO.	FCC ID
1	DC source	LONG WEI	PS-6403D	010934269	N/A
2	PC	HP	A6608CN	3CR83825X3	N/A

NO.	SIGNAL CABLE DESCRIPTION OF THE ABOVE SUPPORT UNITS
1	DC Line: Unshielded, Detachable 1.0m
2	AC Line: Unshielded, Detachable 1.5m

**NOTE:**

1. All power cords of the above support units are non shielded (1.8m).

## 2.4 TEST ITEM AND TEST CONFIGURATION

Pre-Scan has been conducted to determine the worst-case mode from all possible combinations between available modulations, data rates, XYZ axis and antenna ports. The worst case in ERP and radiated emission was found when positioned on X-plane for GSM/EDGE/WCDMA/LTE. Following channel(s) was (were) selected for the final test as listed below:

EUT CONFIGURE MODE	DESCRIPTION
-	EUT with GSM ,WCDMA or LTE link

### GSM MODE

EUT CONFIGURE MODE	TEST ITEM	AVAILABLE CHANNEL	TESTED CHANNEL	MODE
-	ERP	128 to 251	128, 189, 251	GSM, EDGE
-	FREQUENCY STABILITY	128 to 251	128, 251	GSM, EDGE
-	OCCUPIED BANDWIDTH	128 to 251	128, 189, 251	GSM, EDGE
-	BAND EDGE	128 to 251	128, 251	GSM, EDGE
-	CONDCUETED EMISSION	128 to 251	128, 189, 251	GSM, EDGE
-	RADIATED EMISSION	128 to 251	128, 189, 251	GSM, EDGE

### WCDMA MODE

EUT CONFIGURE MODE	TEST ITEM	AVAILABLE CHANNEL	TESTED CHANNEL	MODE
-	ERP	4132 to 4233	4132, 4182, 4233	WCDMA
-	FREQUENCY STABILITY	4132 to 4233	4132, 4233	WCDMA
-	OCCUPIED BANDWIDTH	4132 to 4233	4132, 4182, 4233	WCDMA
-	BAND EDGE	4132 to 4233	4132, 4233	WCDMA
-	CONDCUETED EMISSION	4132 to 4233	4132, 4182, 4233	WCDMA
-	RADIATED EMISSION	4132 to 4233	4132, 4182, 4233	WCDMA

### LTE BAND 5 MODE

TEST ITEM	Available Channel	Tested Channel	Channel bandwidth	modulation	mode
ERP	20407 to 20643	20407, 20525, 20643	1.4MHz	QPSK,16QAM	1 RB / 0 RB Offset
	20415 to 20635	20415, 20525, 20635	3MHz	QPSK,16QAM	1 RB / 0 RB Offset
	20425 to 20625	20425, 20525, 20625	5MHz	QPSK,16QAM	1 RB / 0 RB Offset
	20450 to 20600	20450, 20525, 20600	10MHz	QPSK,16QAM	1 RB / 0 RB Offset
FREQUENCY STABILITY	20407 to 20643	20407, 20643	1.4MHz	QPSK,16QAM	1 RB / 0 RB Offset
	20415 to 20635	20415, 20635	3MHz	QPSK,16QAM	1 RB / 0 RB Offset
	20425 to 20625	20425, 20625	5MHz	QPSK,16QAM	1 RB / 0 RB Offset
	20450 to 20600	20450, 20600	10MHz	QPSK,16QAM	1 RB / 0 RB Offset
OCCUPIED BANDWIDTH	20407 to 20643	20407, 20525, 20643	1.4MHz	QPSK	6 RB / 0 RB Offset
				16QAM	6 RB / 0 RB Offset
	20415 to 20635	20415, 20525, 20635	3MHz	QPSK	15 RB / 0 RB Offset
				16QAM	15 RB / 0 RB Offset
	20425 to 20625	20425, 20525, 20625	5MHz	QPSK	25 RB / 0 RB Offset
				16QAM	25 RB / 0 RB Offset
	20450 to 20600	20450, 20525, 20600	10MHz	QPSK	50 RB / 0 RB Offset
				16QAM	50 RB / 0 RB Offset

BAND EDGE	20407 to 20643	20407	1.4 MHz	QPSK	1 RB / 0 RB Offset
					6 RB / 0 RB Offset
	20407 to 20643	20643	1.4 MHz	QPSK	1 RB / 5 RB Offset
					6 RB / 0 RB Offset
	20415 to 20635	20415	3 MHz	QPSK	1 RB / 0 RB Offset
					15 RB / 0 RB Offset
	20415 to 20635	20635	3 MHz	QPSK	1 RB / 14 RB Offset
					15 RB / 0 RB Offset
CONDCUETED EMISSION	20425 to 20625	20425	5MHz	QPSK	1 RB / 0 RB Offset
					25 RB / 0 RB Offset
	20425 to 20625	20625	5MHz	QPSK	1 RB / 24 RB Offset
					25 RB / 0 RB Offset
RADIATED EMISSION	20450 to 20600	20450	10MHz	QPSK	1 RB / 0 RB Offset
					50 RB / 0 RB Offset
	20450 to 20600	20600	10MHz	QPSK	1 RB / 49 RB Offset
					50 RB / 0 RB Offset
CONDCUETED EMISSION	20407 to 20643	20407, 20525, 20643	1.4MHz	QPSK	1 RB / 0 RB Offset
	20415 to 20635	20415, 20525, 20635	3MHz	QPSK	1 RB / 0 RB Offset
	20425 to 20625	20425, 20525, 20625	5MHz	QPSK	1 RB / 0 RB Offset
	20450 to 20600	20450, 20525, 20600	10MHz	QPSK	1 RB / 0 RB Offset
RADIATED EMISSION	20407 to 20643	20525	1.4MHz	QPSK	1 RB / 0 RB Offset
	20415 to 20635	20525	3MHz	QPSK	1 RB / 0 RB Offset
	20425 to 20625	20425, 20525, 20625	5MHz	QPSK	1 RB / 0 RB Offset
	20450 to 20600	20525	10MHz	QPSK	1 RB / 0 RB Offset

TEST ITEM	ENVIRONMENTAL CONDITIONS	INPUT POWER	TESTED BY
ERP	23deg. C, 62%RH	DC 3.8V	Star Le
FREQUENCY STABILITY	23deg. C, 62%RH	DC 3.4V/3.8V/4.2V	Wenliang Wu
OCCUPIED BANDWIDTH	23deg. C, 62%RH	DC 3.8V	Wenliang Wu
BAND EDGE	23deg. C, 62%RH	DC 3.8V	Wenliang Wu
CONDCUETED EMISSION	23deg. C, 62%RH	DC 3.8V	Wenliang Wu
RADIATED EMISSION	25deg. C, 63.6%RH	DC 3.8V	Star Le



## 2.5 EUT OPERATING CONDITIONS

The EUT makes a call to the communication simulator. The communication simulator station system controlled a EUT to export maximum output power under transmission mode and specific channel frequency

## 2.6 GENERAL DESCRIPTION OF APPLIED STANDARDS

The EUT is a RF product. According to the specifications of the manufacturer, it must comply with the requirements of the following standards:

**FCC 47 CFR Part 2**

**FCC 47 CFR Part 22**

**KDB 971168 D01 Power Meas License Digital Systems v03**

**ANSI/TIA/EIA-603-D**

**ANSI/TIA/EIA-603-E**

**ANSI C63.26-2015**

**NOTE:** All test items have been performed and recorded as per the above standards.

### 3 TEST TYPES AND RESULTS

#### 3.1 OUTPUT POWER MEASUREMENT

##### 3.1.1 LIMITS OF OUTPUT POWER MEASUREMENT

Mobile / Portable station are limited to 7 watts e.r.p.

##### 3.1.2 TEST PROCEDURES

###### EIRP / ERP MEASUREMENT:

- a. All measurements were done at low, middle and high operational frequency range. RBW and VBW is 1MHz for GSM, GPRS & EDGE, 5MHz for WCDMA mode and 10MHz for LTE mode.
- b. Substitution method is used for E.I.R.P measurement. In the semi-anechoic chamber, EUT placed on the 0.8m height of Turn Table, rotated the table around 360 degrees to search the maximum radiation power and receiver antenna shall be rotated vertical and horizontal polarization and moved height from 1m to 4m to find the maximum polar radiated power. The “Read Value” is the spectrum reading the maximum power value.
- c. The substitution horn antenna is substituted for EUT at the same position and signals generator export the CW signal to the substitution antenna via a tx cable. Rotated the Turn Table and moved receiving antenna to find the maximum radiation power. Adjust output power level of S.G to get a Value of spectrum reading equal to “Read Value” of step b. Record the power level of S.G
- d.  $EIRP = \text{Output power level of S.G} - \text{TX cable loss} + \text{Antenna gain of substitution horn}$ .  
E.R.P power can be calculated form E.I.R.P power by subtracting the gain of dipole,  
 $E.R.P \text{ power} = E.I.P.R \text{ power} - 2.15\text{dBi}$ .

###### CONDUCTED POWER MEASUREMENT:

The EUT was set up for the maximum power with WCDMA link data modulation and link up with simulator. Set the EUT to transmit under low, middle and high channel and record the power level shown on simulator.

### 3.1.3 TEST SETUP

#### EIRP / ERP Measurement:

<Radiated Emission below or equal 1 GHz>

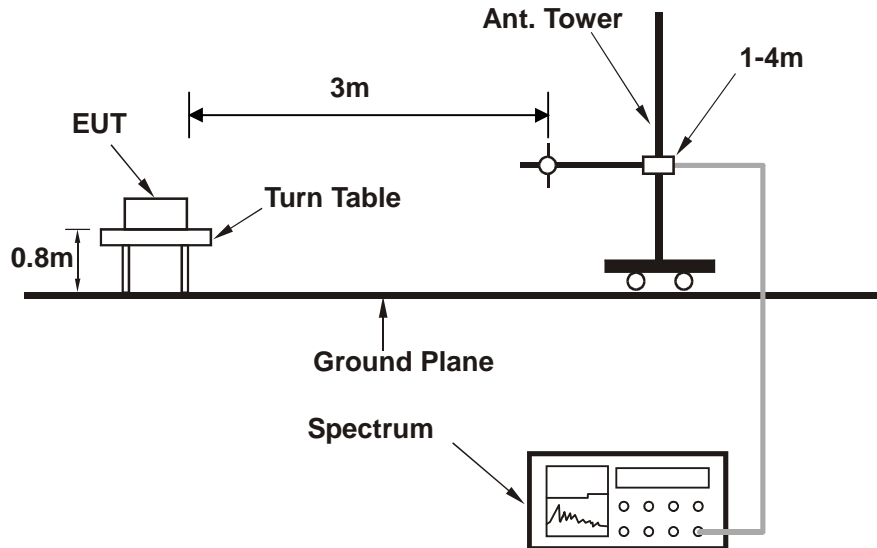

<Radiated Emission above 1 GHz>

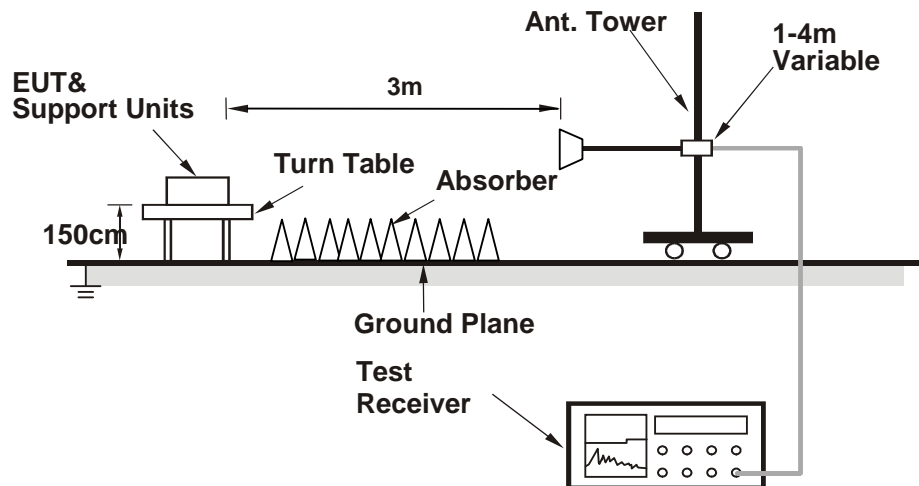

For the actual test configuration, please refer to the attached file (Test Setup Photo).

#### CONDUCTED POWER MEASUREMENT:

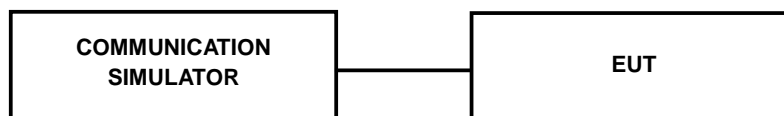



### 3.1.4 TEST RESULTS

#### CONDUCTED OUTPUT POWER (dBm)

Band	GSM850		
Channel	128	189	251
Frequency (MHz)	824.2	836.4	848.8
GPRS 8	33.65	33.54	32.94
GPRS 10	33.33	33.22	32.62
GPRS 11	33.00	32.89	32.29
GPRS 12	32.61	32.50	31.90
EDGE 8 (MCS9)	26.50	26.39	25.79
EDGE 10 (MCS9)	26.28	26.17	25.57
EDGE 11 (MCS9)	25.97	25.86	25.26
EDGE 12 (MCS9)	25.65	25.54	24.94

Band	WCDMA V		
Channel	4132	4182	4233
Frequency (MHz)	826.4	836.4	846.6
RMC 12.2K	23.98	22.62	23.74
HSPA			
HSDPA Subtest-1	23.07	21.71	22.83
HSDPA Subtest-2	23.04	21.68	22.80
HSDPA Subtest-3	22.65	21.29	22.41
HSDPA Subtest-4	22.60	21.24	22.36
HSUPA Subtest-1	23.01	21.65	22.77
HSUPA Subtest-2	21.14	19.78	20.90
HSUPA Subtest-3	22.08	20.72	21.84
HSUPA Subtest-4	21.10	19.74	20.86
HSUPA Subtest-5	23.25	21.89	23.01



LTE Band 5

Band/BW	Modulation	RB Size	RB Offset	Low CH 20407	Mid CH 20525	High CH 20643	3GPP MPR (dB)
				Frequency 824.7 MHz	Frequency 836.5 MHz	Frequency 848.3 MHz	
5/1.4	QPSK	1	0	21.90	22.73	22.51	0
		1	2	21.86	22.69	22.47	0
		1	5	21.49	22.32	22.10	0
		3	0	21.88	22.71	22.49	0
		3	1	21.84	22.67	22.45	0
		3	3	21.47	22.30	22.08	0
	16QAM	6	0	20.97	21.80	21.58	1
		1	0	20.40	21.23	21.01	1
		1	2	20.36	21.19	20.97	1
		1	5	19.39	20.22	20.00	1
		3	0	20.39	21.22	21.00	1
		3	1	20.35	21.18	20.96	1
		3	3	19.38	20.21	19.99	1
		6	0	20.07	20.90	20.68	2

Band/BW	Modulation	RB Size	RB Offset	Low CH 20415	Mid CH 20525	High CH 20635	3GPP MPR (dB)
				Frequency 825.5 MHz	Frequency 836.5 MHz	Frequency 847.5 MHz	
5/3	QPSK	1	0	21.94	22.77	22.55	0
		1	7	21.90	22.73	22.51	0
		1	14	21.53	22.36	22.14	0
		8	0	21.31	22.14	21.92	1
		8	3	21.26	22.09	21.87	1
		8	7	20.88	21.71	21.49	1
		15	0	21.01	21.84	21.62	1
	16QAM	1	0	20.44	21.27	21.05	1
		1	7	20.40	21.23	21.01	1
		1	14	19.43	20.26	20.04	1
		8	0	20.38	21.21	20.99	2
		8	3	20.37	21.20	20.98	2
		8	7	19.76	20.59	20.37	2
		15	0	20.11	20.94	20.72	2



**BUREAU  
VERITAS**

Test Report No.: RF180521W014-1

Band/BW	Modulation	RB Size	RB Offset	Low CH 20425	Mid CH 20525	High CH 20625	3GPP MPR (dB)
				Frequency 826.5 MHz	Frequency 836.5 MHz	Frequency 846.5 MHz	
5/5	QPSK	1	0	22.00	22.83	22.61	0
		1	12	21.96	22.79	22.57	0
		1	24	21.59	22.42	22.20	0
		12	0	21.37	22.20	21.98	1
		12	6	21.32	22.15	21.93	1
		12	13	20.94	21.77	21.55	1
		25	0	21.07	21.90	21.68	1
	16QAM	1	0	20.50	21.33	21.11	1
		1	12	20.46	21.29	21.07	1
		1	24	19.49	20.32	20.10	1
		12	0	20.44	21.27	21.05	2
		12	6	20.43	21.26	21.04	2
		12	13	19.82	20.65	20.43	2
		25	0	20.17	21.00	20.78	2

Band/BW	Modulation	RB Size	RB Offset	Low CH 20450	Mid CH 20525	High CH 20600	3GPP MPR (dB)
				Frequency 829 MHz	Frequency 836.5 MHz	Frequency 844 MHz	
5/10	QPSK	1	0	22.03	<b>22.86</b>	22.64	0
		1	24	21.99	22.82	22.60	0
		1	49	21.62	22.45	22.23	0
		25	0	21.40	22.23	22.01	1
		25	12	21.35	22.18	21.96	1
		25	25	20.97	21.80	21.58	1
		50	0	21.10	21.93	21.71	1
	16QAM	1	0	20.53	21.36	21.14	1
		1	24	20.49	21.32	21.10	1
		1	49	19.52	20.35	20.13	1
		25	0	20.47	21.30	21.08	2
		25	12	20.46	21.29	21.07	2
		25	25	19.85	20.68	20.46	2
		50	0	20.20	21.03	20.81	2



ERP POWER (dBm)

GSM

Channel	Frequency (MHz)	SPA LVL (dBm)	Correction Factor(dB)	ERP(dBm)	ERP(mW)	Polarization (H/V)
128	824.2	-8.32	33.56	23.09	203.66	H
189	836.4	-7.44	33.63	24.04	253.45	H
251	848.8	-8.14	33.57	23.28	212.72	H
128	824.2	-1.08	34.24	31.01	1260.67	V
189	836.4	-0.13	34.59	32.31	<b>1700.59</b>	V
251	848.8	-0.79	34.62	31.68	1473.33	V

**REMARKS:** 1. ERP Output Power (dBm) = SPA LVL (dBm) + Correction Factor (dB) -2.15(dB).  
 2. Correction factor (dB) = Free Space Loss + Antenna Factor + Cable Loss

EDGE

Channel	Frequency (MHz)	SPA LVL (dBm)	Correction Factor(dB)	ERP(dBm)	ERP(mW)	Polarization (H/V)
128	824.2	-14.05	33.56	17.36	54.44	H
189	836.4	-13.55	33.63	17.93	62.07	H
251	848.8	-14.22	33.57	17.20	52.46	H
128	824.2	-7.16	34.24	24.93	310.89	V
189	836.4	-6.39	34.59	26.05	402.35	V
251	848.8	-6.19	34.62	26.28	<b>424.91</b>	V

**REMARKS:** 1. ERP Output Power (dBm) = SPA LVL (dBm) + Correction Factor (dB) -2.15(dB).  
 2. Correction factor (dB) = Free Space Loss + Antenna Factor + Cable Loss

WCDMA

Channel	Frequency (MHz)	SPA LVL (dBm)	Correction Factor(dB)	ERP(dBm)	ERP(mW)	Polarization (H/V)
4132	826.4	-17.16	33.56	14.25	26.60	H
4182	836.4	-16.96	33.63	14.52	28.31	H
4233	846.6	-16.76	33.57	14.66	29.23	H
4132	826.4	-10.76	34.24	21.33	135.71	V
4182	836.4	-9.86	34.59	22.58	180.97	V
4233	846.6	-8.89	34.62	23.58	<b>228.19</b>	V

**REMARKS:** 1. ERP Output Power (dBm) = SPA LVL (dBm) + Correction Factor (dB) -2.15(dB).  
 2. Correction factor (dB) = Free Space Loss + Antenna Factor + Cable Loss



**LTE BAND 5**

**CHANNEL BANDWIDTH: 1.4MHz QPSK**

Channel	Frequency (MHz)	SPA LVL (dBm)	Correction Factor(dB)	ERP(dBm)	ERP(mW)	Polarization (H/V)	LIMIT (W)
20407	824.7	-14.44	33.67	17.08	51.09	H	7
20525	836.5	-13.46	33.62	18.01	63.30	H	7
20643	848.3	-13.50	33.65	18.00	63.02	H	7
20407	824.7	-6.94	34.25	25.16	327.94	V	7
20525	836.5	-6.76	34.60	25.69	370.51	V	7
20643	848.3	-6.39	34.63	26.09	<b>406.44</b>	V	7

**CHANNEL BANDWIDTH: 1.4MHz 16QAM**

Channel	Frequency (MHz)	SPA LVL (dBm)	Correction Factor(dB)	ERP(dBm)	ERP(mW)	Polarization (H/V)	LIMIT (W)
20407	824.7	-15.27	33.67	16.25	42.20	H	7
20525	836.5	-14.48	33.62	16.99	50.05	H	7
20643	848.3	-14.60	33.65	16.90	48.92	H	7
20407	824.7	-7.77	34.25	24.33	270.89	V	7
20525	836.5	-7.78	34.60	24.67	292.95	V	7
20643	848.3	-7.49	34.63	24.99	315.50	V	7

**CHANNEL BANDWIDTH: 3MHz QPSK**

Channel	Frequency (MHz)	SPA LVL (dBm)	Correction Factor(dB)	ERP(dBm)	ERP(mW)	Polarization (H/V)	LIMIT (W)
20415	825.5	-14.25	33.72	17.32	53.96	H	7
20525	836.5	-13.40	33.62	18.07	64.18	H	7
20635	847.5	-13.37	33.65	18.13	65.00	H	7
20415	825.5	-6.75	34.30	25.40	346.82	V	7
20525	836.5	-6.70	34.60	25.75	375.66	V	7
20635	847.5	-6.26	34.57	26.16	<b>413.14</b>	V	7

**CHANNEL BANDWIDTH: 3MHz 16QAM**

Channel	Frequency (MHz)	SPA LVL (dBm)	Correction Factor(dB)	ERP(dBm)	ERP(mW)	Polarization (H/V)	LIMIT (W)
20415	825.5	-15.40	33.72	16.17	41.41	H	7
20525	836.5	-14.50	33.62	16.97	49.82	H	7
20635	847.5	-14.53	33.65	16.97	49.76	H	7
20415	825.5	-7.90	34.30	24.25	266.13	V	7
20525	836.5	-7.80	34.60	24.65	291.61	V	7
20635	847.5	-7.42	34.57	25.00	316.30	V	7

**CHANNEL BANDWIDTH: 5MHz QPSK**

Channel	Frequency (MHz)	SPA LVL (dBm)	Correction Factor(dB)	ERP(dBm)	ERP(mW)	Polarization (H/V)	LIMIT (W)
20425	826.5	-14.26	33.69	17.28	53.51	H	7
20525	836.5	-13.47	33.62	18.00	63.15	H	7
20625	846.5	-13.44	33.66	18.07	64.14	H	7
20425	826.5	-6.76	34.85	25.94	392.55	V	7
20525	836.5	-6.77	34.60	25.68	369.66	V	7
20625	846.5	-6.33	34.59	26.11	<b>408.70</b>	V	7

**CHANNEL BANDWIDTH: 5MHz 16QAM**

Channel	Frequency (MHz)	SPA LVL (dBm)	Correction Factor(dB)	ERP(dBm)	ERP(mW)	Polarization (H/V)	LIMIT (W)
20425	826.5	-15.12	33.69	16.42	43.89	H	7
20525	836.5	-14.34	33.62	17.13	51.69	H	7
20625	846.5	-14.29	33.66	17.22	52.74	H	7
20425	826.5	-7.62	34.85	25.08	322.03	V	7
20525	836.5	-7.64	34.60	24.81	302.55	V	7
20625	846.5	-7.18	34.59	25.26	336.05	V	7

**CHANNEL BANDWIDTH: 10MHz QPSK**

Channel	Frequency (MHz)	SPA LVL (dBm)	Correction Factor(dB)	ERP(dBm)	ERP(mW)	Polarization (H/V)	LIMIT (W)
20450	829	-14.84	33.73	16.74	47.15	H	7
20525	836.5	-13.92	33.62	17.55	56.94	H	7
20600	844	-14.02	33.51	17.34	54.24	H	7
20450	829	-7.34	34.54	25.05	319.60	V	7
20525	836.5	-7.22	34.60	25.23	333.27	V	7
20600	844	-6.91	34.46	25.40	<b>346.34</b>	V	7

**CHANNEL BANDWIDTH: 10MHz 16QAM**

Channel	Frequency (MHz)	SPA LVL (dBm)	Correction Factor(dB)	ERP(dBm)	ERP(mW)	Polarization (H/V)	LIMIT (W)
20450	829	-15.77	33.73	15.81	38.06	H	7
20525	836.5	-14.99	33.62	16.48	44.50	H	7
20600	844	-14.85	33.51	16.51	44.80	H	7
20450	829	-8.27	34.54	24.12	257.99	V	7
20525	836.5	-8.29	34.60	24.16	260.50	V	7
20600	844	-7.74	34.46	24.57	286.09	V	7

**REMARKS:** 1. ERP Output Power (dBm) = SPA LVL (dBm) + Correction Factor (dB) -2.15(dB).  
2. Correction factor (dB) = Free Space Loss + Antenna Factor + Cable Loss

## 3.2 FREQUENCY STABILITY MEASUREMENT

### 3.2.1 LIMITS OF FREQUENCY STABILITY MEASUREMENT

1.5 ppm is for base and fixed station. 2.5 ppm is for mobile station.

### 3.2.2 TEST PROCEDURE

- Device is placed at the oven room. The oven room could control the temperatures and humidity. Power warm up is at least 15 min and power applied should perform before recording frequency error.
- EUT is connected the external power supply to control the DC input power. The test voltage range is from minimum to maximum working voltage. Each step shall be record the frequency error rate.
- The temperature range step is 10 degrees in this test items. All temperature levels shall be hold the  $\pm 0.5^{\circ}\text{C}$  during the measurement testing. The each temperature step shall be at least 0.5 hours, consider the EUT could be test under the stability condition.

**NOTE:** The frequency error was recorded frequency error from the communication simulator.

### 3.2.3 TEST SETUP

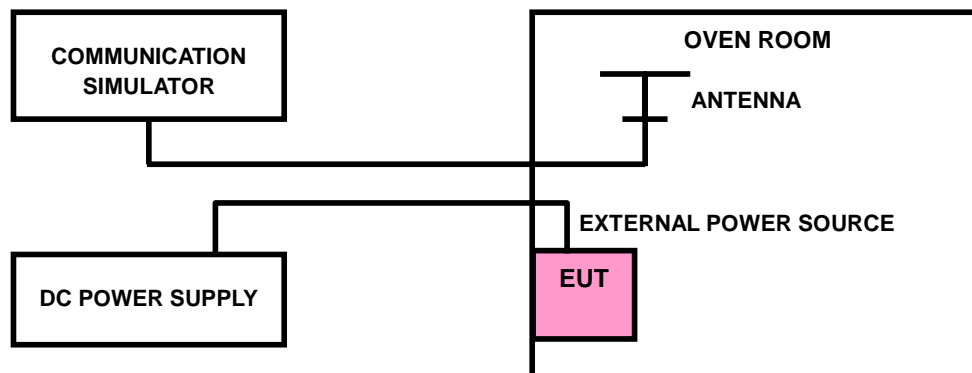



### 3.2.4 TEST RESULTS

#### GSM 850

##### FREQUENCY ERROR VS. VOLTAGE

VOLTAGE (Volts)	FREQUENCY ERROR (ppm)		LIMIT (ppm)
	Low Channel	High Channel	
3.8	0.0027	0.0035	2.5
3.4	0.0026	0.0028	2.5
4.2	0.0023	0.0023	2.5

**NOTE:** The applicant defined the normal working voltage of the battery is from 3.4Vdc to 4.2Vdc.

##### FREQUENCY ERROR vs. TEMPERATURE.

TEMP. (°C)	FREQUENCY ERROR (ppm)		LIMIT (ppm)
	Low Channel	High Channel	
-30	-0.0132	-0.0125	2.5
-20	-0.0125	-0.0118	2.5
-10	-0.0105	-0.0099	2.5
0	-0.0096	-0.0090	2.5
10	-0.0076	-0.0071	2.5
20	-0.0062	-0.0058	2.5
30	-0.0052	-0.0049	2.5
40	-0.0045	-0.0042	2.5
50	-0.0037	-0.0035	2.5





**EDGE 850**

**FREQUENCY ERROR VS. VOLTAGE**

VOLTAGE (Volts)	FREQUENCY ERROR (ppm)		LIMIT (ppm)
	Low Channel	High Channel	
3.8	0.0037	0.0037	2.5
3.4	0.0026	0.0032	2.5
4.2	0.0024	0.0028	2.5

**NOTE:** The applicant defined the normal working voltage of the battery is from 3.4Vdc to 4.2Vdc.

**FREQUENCY ERROR vs. TEMPERATURE.**

TEMP. (°C)	FREQUENCY ERROR (ppm)		LIMIT (ppm)
	Low Channel	High Channel	
-30	-0.0132	-0.0125	2.5
-20	-0.0125	-0.0118	2.5
-10	-0.0117	-0.0111	2.5
0	-0.0112	-0.0106	2.5
10	-0.0087	-0.0083	2.5
20	-0.0073	-0.0069	2.5
30	-0.0055	-0.0052	2.5
40	-0.0049	-0.0047	2.5
50	-0.0038	-0.0037	2.5



**WCDMA Band V**

**FREQUENCY ERROR VS. VOLTAGE**

VOLTAGE (Volts)	FREQUENCY ERROR (ppm)		LIMIT (ppm)
	Low Channel	High Channel	
3.8	0.0037	0.0036	2.5
3.4	0.0031	0.0031	2.5
4.2	0.0025	0.0024	2.5

**NOTE:** The applicant defined the normal working voltage of the battery is from 3.4Vdc to 4.2Vdc.

**FREQUENCY ERROR vs. TEMPERATURE.**

TEMP. (°C)	FREQUENCY ERROR (ppm)		LIMIT (ppm)
	Low Channel	High Channel	
-30	-0.0118	-0.0128	2.5
-20	-0.0112	-0.0121	2.5
-10	-0.0095	-0.0104	2.5
0	-0.0081	-0.0090	2.5
10	-0.0070	-0.0078	2.5
20	-0.0063	-0.0070	2.5
30	-0.0048	-0.0054	2.5
40	-0.0037	-0.0043	2.5
50	-0.0031	-0.0036	2.5



**LTE Band 5**

**FREQUENCY ERROR VS. VOLTAGE**

VOLTAGE (Volts)	1.4MHz		LIMIT (ppm)
	FREQUENCY ERROR (ppm)		
	Low Channel	High Channel	
3.8	0.0043	0.0047	2.5
3.4	0.0038	0.0040	2.5
4.2	0.0033	0.0029	2.5

**NOTE:** The applicant defined the normal working voltage of the battery is from 3.4Vdc to 4.2Vdc.

**FREQUENCY ERROR vs. TEMPERATURE.**

TEMP. (°C)	1.4MHz		LIMIT (ppm)
	FREQUENCY ERROR (ppm)		
	Low Channel	High Channel	
-30	-0.0151	-0.0138	2.5
-20	-0.0137	-0.0127	2.5
-10	-0.0118	-0.0117	2.5
0	-0.0104	-0.0102	2.5
10	-0.0090	-0.0085	2.5
20	-0.0083	-0.0074	2.5
30	-0.0060	-0.0059	2.5
40	-0.0048	-0.0045	2.5
50	-0.0035	-0.0039	2.5

**FREQUENCY ERROR VS. VOLTAGE**

VOLTAGE (Volts)	3MHz		LIMIT (ppm)
	FREQUENCY ERROR (ppm)		
	Low Channel	High Channel	
3.8	0.0042	0.0029	2.5
3.4	0.0034	0.0039	2.5
4.2	0.0028	0.0031	2.5

**NOTE:** The applicant defined the normal working voltage of the battery is from 3.4Vdc to 4.2Vdc.

**FREQUENCY ERROR vs. TEMPERATURE.**

TEMP. (°C)	3MHz		LIMIT (ppm)
	FREQUENCY ERROR (ppm)		
	Low Channel	High Channel	
-30	-0.0153	-0.0139	2.5
-20	-0.0131	-0.0127	2.5
-10	-0.0116	-0.0117	2.5
0	-0.0104	-0.0094	2.5
10	-0.0088	-0.0090	2.5
20	-0.0083	-0.0082	2.5
30	-0.0062	-0.0073	2.5
40	-0.0054	-0.0062	2.5
50	-0.0042	-0.0052	2.5

**FREQUENCY ERROR VS. VOLTAGE**

VOLTAGE (Volts)	5MHz		LIMIT (ppm)
	FREQUENCY ERROR (ppm)		
	Low Channel	High Channel	
3.8	0.0039	0.0041	2.5
3.4	0.0036	0.0036	2.5
4.2	0.0027	0.0031	2.5

**NOTE:** The applicant defined the normal working voltage of the battery is from 3.4Vdc to 4.2Vdc.

**FREQUENCY ERROR vs. TEMPERATURE.**

TEMP. (°C)	5MHz		LIMIT (ppm)
	FREQUENCY ERROR (ppm)		
	Low Channel	High Channel	
-30	-0.0146	-0.0143	2.5
-20	-0.0137	-0.0134	2.5
-10	-0.0118	-0.0115	2.5
0	-0.0108	-0.0106	2.5
10	-0.0097	-0.0095	2.5
20	-0.0077	-0.0075	2.5
30	-0.0061	-0.0060	2.5
40	-0.0055	-0.0053	2.5
50	-0.0041	-0.0041	2.5

**FREQUENCY ERROR VS. VOLTAGE**

VOLTAGE (Volts)	10MHz		LIMIT (ppm)
	FREQUENCY ERROR (ppm)		
	Low Channel	High Channel	
3.8	0.0037	0.0043	2.5
3.4	0.0030	0.0032	2.5
4.2	0.0023	0.0027	2.5

**NOTE:** The applicant defined the normal working voltage of the battery is from 3.4Vdc to 4.2Vdc.

**FREQUENCY ERROR vs. TEMPERATURE.**

TEMP. (°C)	10MHz		LIMIT (ppm)
	FREQUENCY ERROR (ppm)		
	Low Channel	High Channel	
-30	-0.0152	-0.0140	2.5
-20	-0.0139	-0.0130	2.5
-10	-0.0127	-0.0121	2.5
0	-0.0116	-0.0106	2.5
10	-0.0112	-0.0096	2.5
20	-0.0091	-0.0083	2.5
30	-0.0075	-0.0064	2.5
40	-0.0058	-0.0051	2.5
50	-0.0055	-0.0045	2.5

### 3.3 OCCUPIED BANDWIDTH MEASUREMENT

#### 3.3.1 TEST PROCEDURES

The EUT makes a call to the communication simulator. All measurements were done at low, middle and high operational frequency range. The communication simulator station system controlled a EUT to export maximum output power under transmission mode and specific channel frequency. Use OBW measurement function of Spectrum analyzer to measure 99 % occupied bandwidth.

#### 3.3.2 TEST SETUP

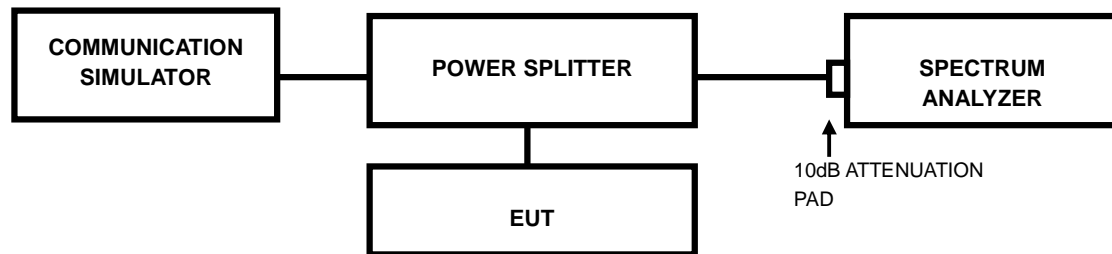



**BUREAU  
VERITAS**

Test Report No.: RF180521W014-1

### 3.3.3 TEST RESULTS

CHANNEL	Frequency (MHz)	99% OCCUPIED Bandwidth (kHz)		CHANNEL	Frequency (MHz)	99% OCCUPIED Bandwidth (MHz)
		GSM	EDGE			WCDMA
128	824.2	245.26	245.00	4132	826.4	4.13
189	836.4	245.00	247.00	4182	836.4	4.14
251	848.8	244.00	241.00	4233	846.6	4.13

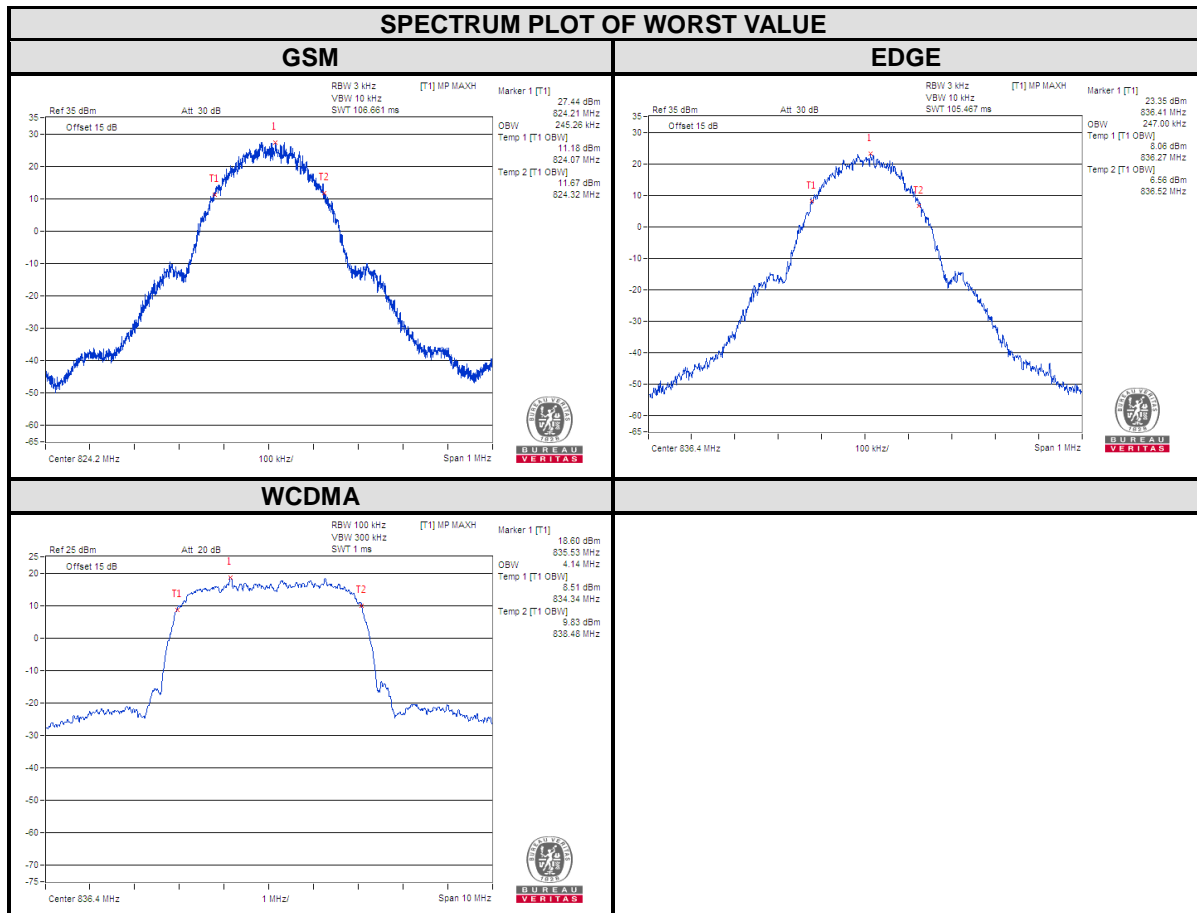



CHANNEL	Frequency (MHz)	26dB Bandwidth (kHz)		CHANNEL	Frequency (MHz)	26dB Bandwidth (MHz)
		GSM	EDGE			WCDMA
128	824.2	317.89	315.88	4132	826.4	4.71
189	836.4	313.32	316.51	4182	836.4	4.71
251	848.8	318.98	321.52	4233	846.6	4.71

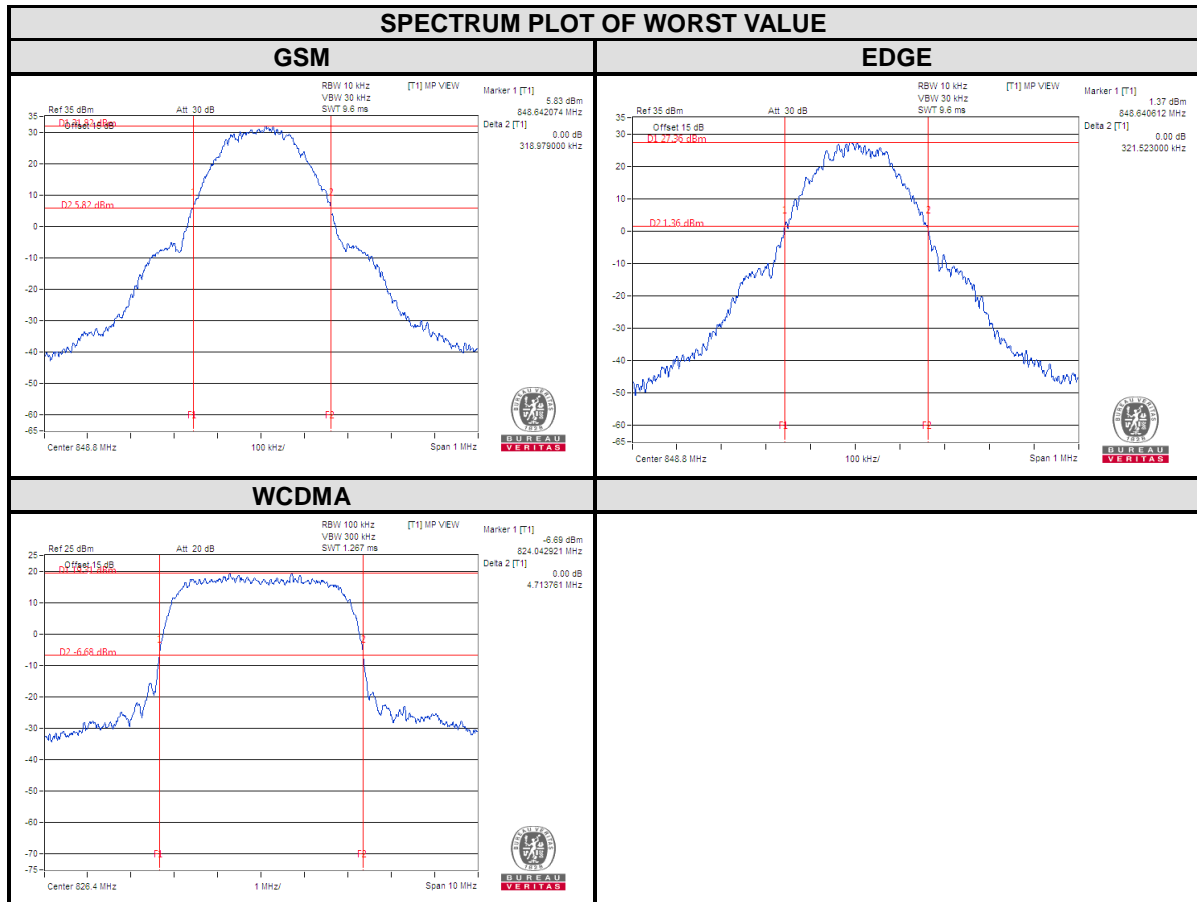

LTE band 5							
Channel Bandwidth : 1.4MHz							
Channel	Frequency (MHz)	99% Occupied bandwidth (MHz)		Channel	Frequency (MHz)	26 dB bandwidth (MHz)	
		QPSK	16QAM			QPSK	16QAM
20407	824.7	1.08	1.09	20407	824.7	1.25	1.26
20525	836.5	1.09	1.08	20525	836.5	1.26	1.27
20643	848.3	1.09	1.08	20643	848.3	1.26	1.26

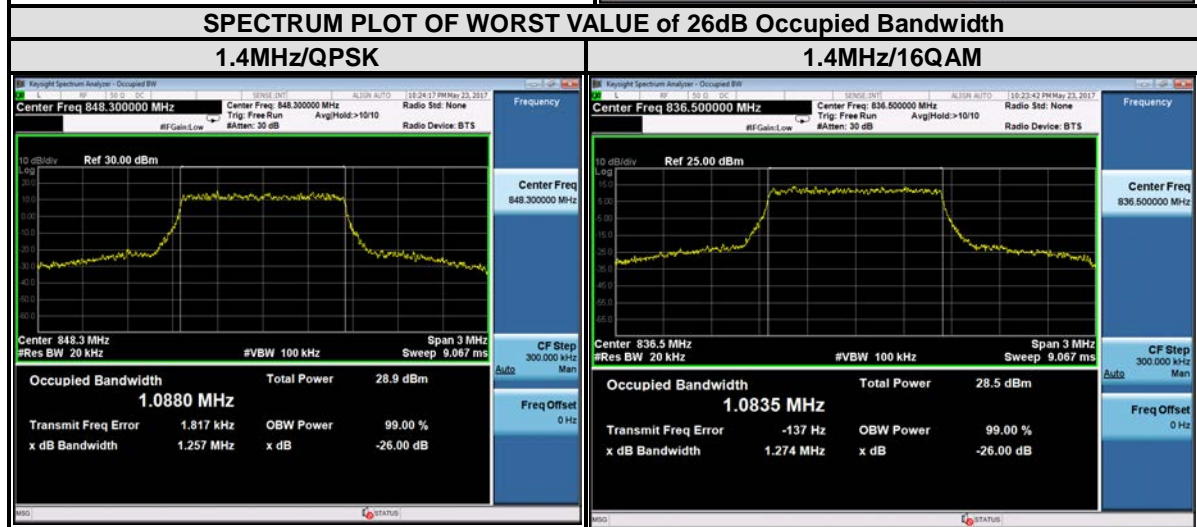
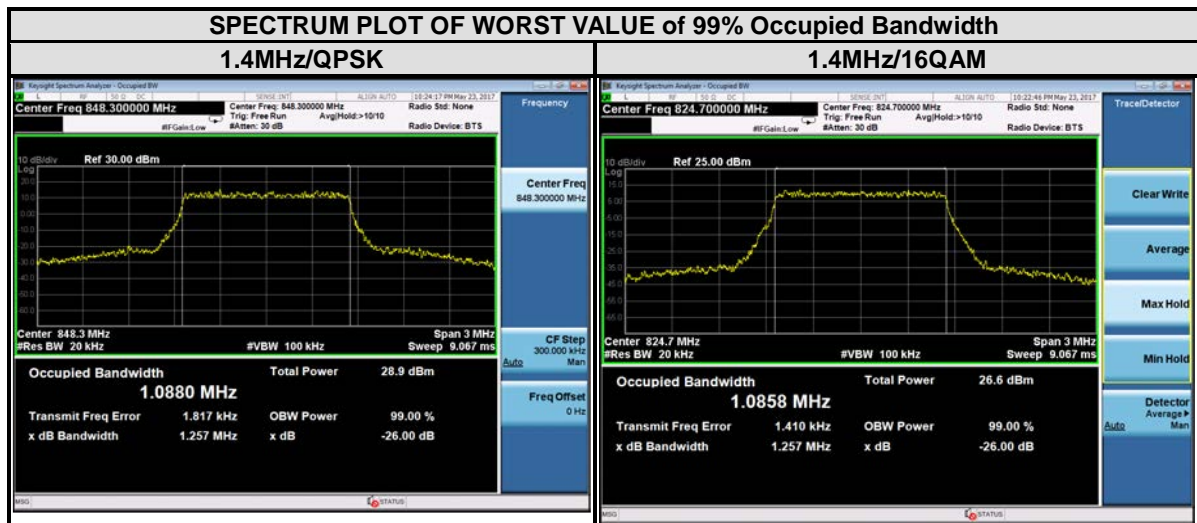



LTE band 5							
Channel Bandwidth : 3MHz							
Channel	Frequency (MHz)	99% Occupied bandwidth (MHz)		Channel	Frequency (MHz)	26 dB bandwidth (MHz)	
		QPSK	16QAM			QPSK	16QAM
20415	825.5	2.68	2.68	20415	825.5	2.89	2.90
20525	836.5	2.69	2.68	20525	836.5	2.93	2.91
20635	847.5	2.67	2.68	20635	847.5	2.88	2.93

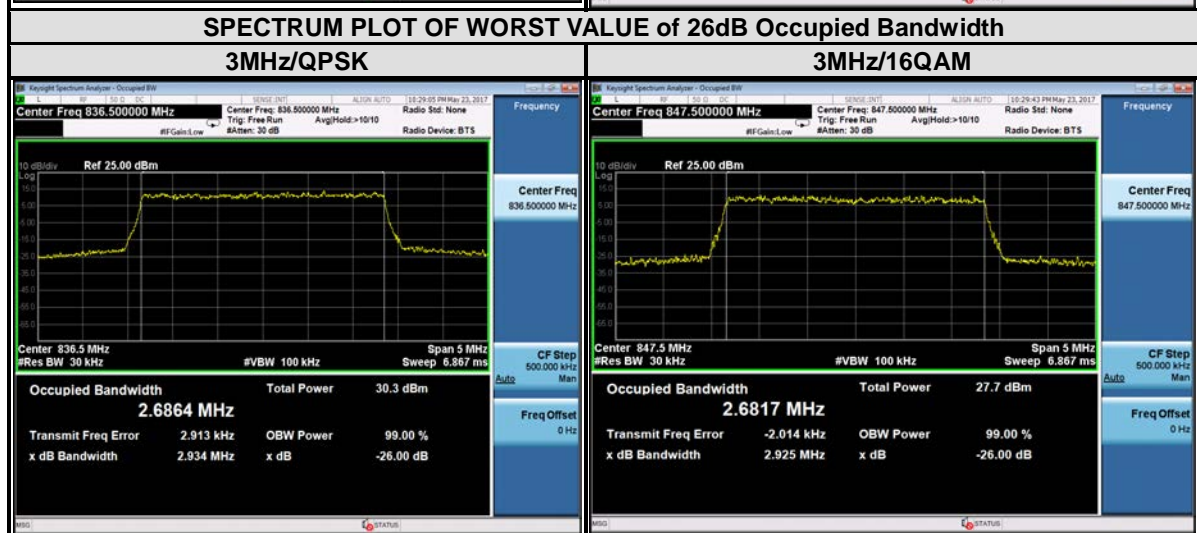
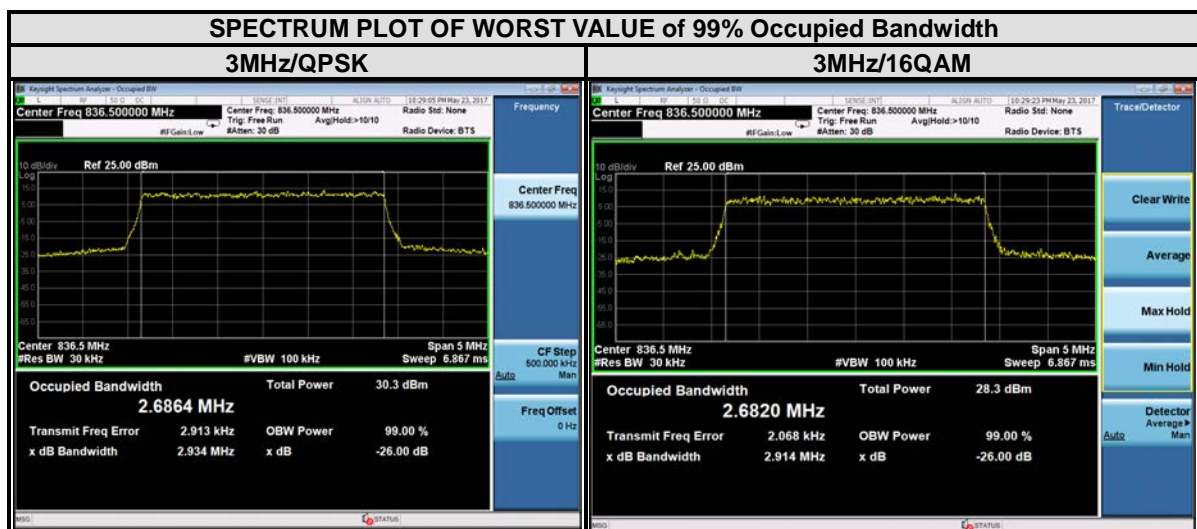



LTE band 5							
Channel Bandwidth : 5 MHz							
Channel	Frequency (MHz)	99% Occupied bandwidth (MHz)		Channel	Frequency (MHz)	26 dB bandwidth (MHz)	
		QPSK	16QAM			QPSK	16QAM
20425	826.5	4.47	4.47	20425	826.5	4.85	4.82
20525	836.5	4.47	4.47	20525	836.5	4.85	4.84
20625	846.5	4.47	4.46	20625	846.5	4.84	4.84

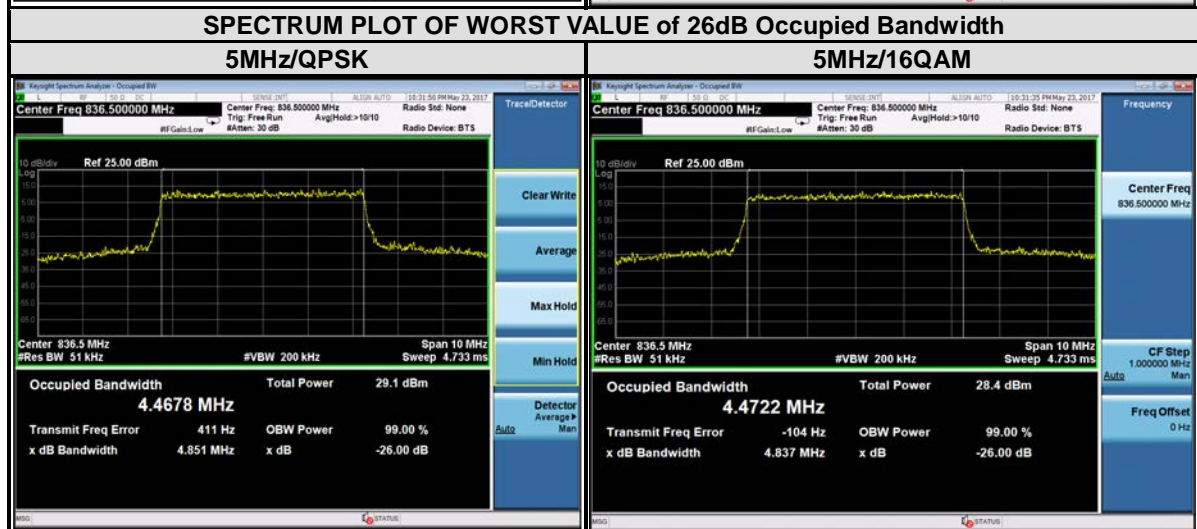
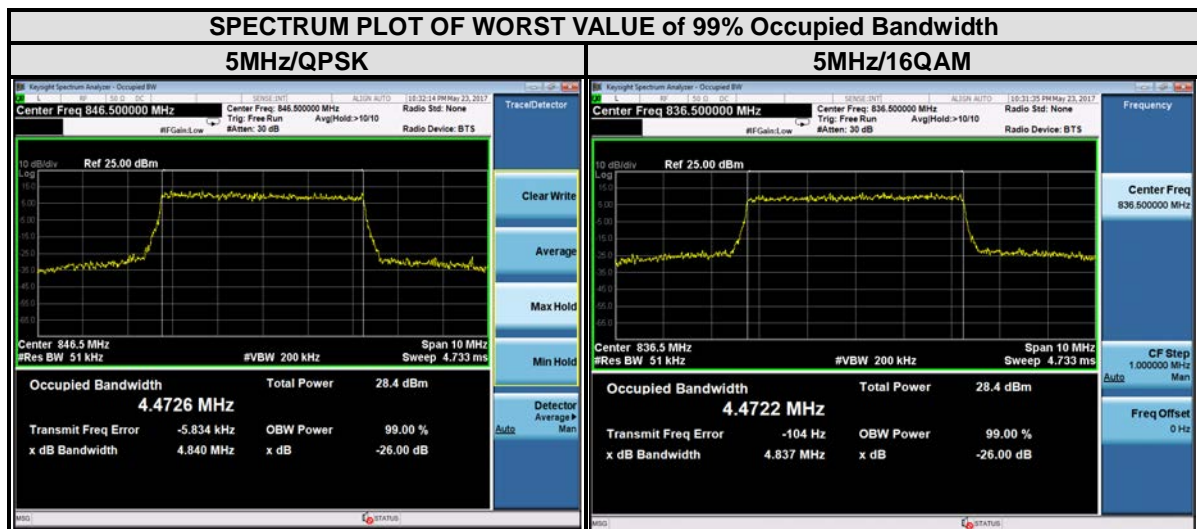

LTE band 5							
Channel Bandwidth : 10 MHz							
Channel	Frequency (MHz)	99% Occupied bandwidth (MHz)		Channel	Frequency (MHz)	26 dB bandwidth (MHz)	
		QPSK	16QAM			QPSK	16QAM
20450	829	8.93	8.89	20450	829	9.62	9.60
20525	836.5	8.95	8.94	20525	836.5	9.71	9.66
20600	844	8.87	8.91	20600	844	9.50	9.54

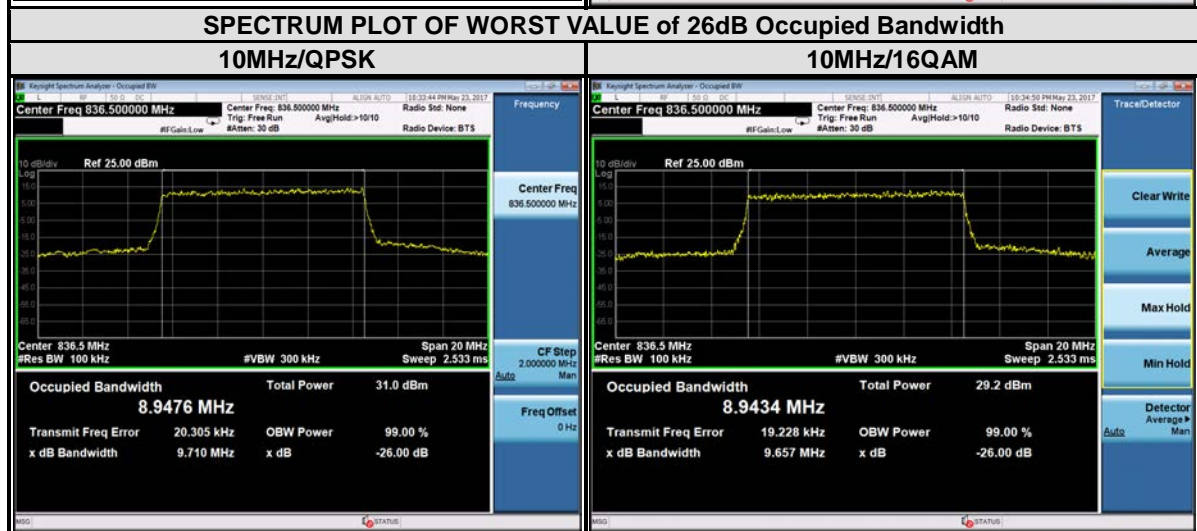
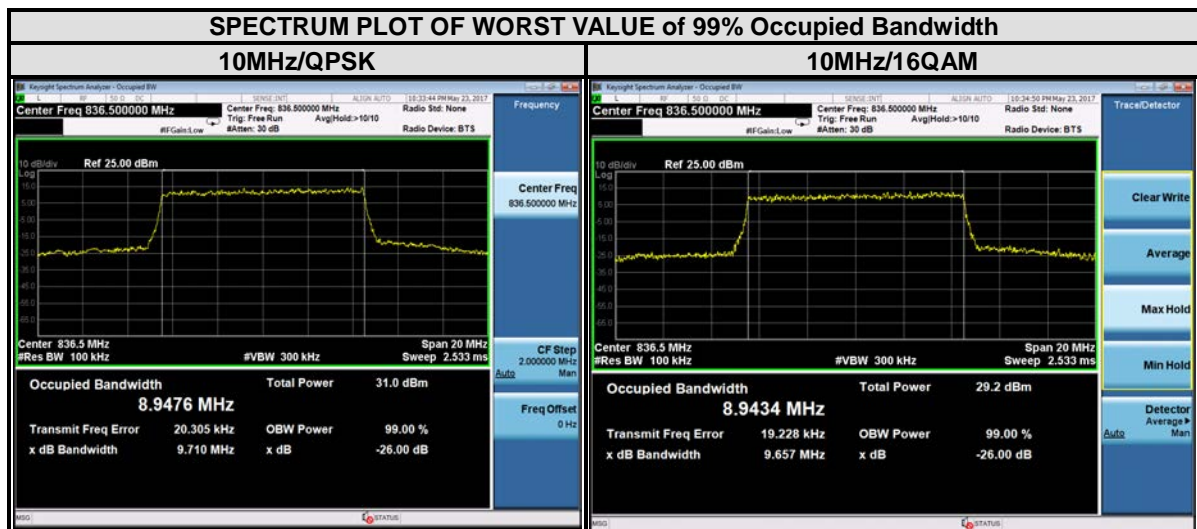

### 3.4 BAND EDGE MEASUREMENT

#### 3.4.1 LIMITS OF BAND EDGE MEASUREMENT

Power of any emission outside of the authorized operating frequency ranges must be attenuated below the transmitting power (P) by a factor of at least  $43 + 10 \log(P)$  dB. In the 1 MHz bands immediately outside and adjacent to the frequency block a resolution bandwidth of at least one percent of the emission bandwidth of the fundamental emission of the transmitter may be employed.

#### 3.4.2 TEST SETUP

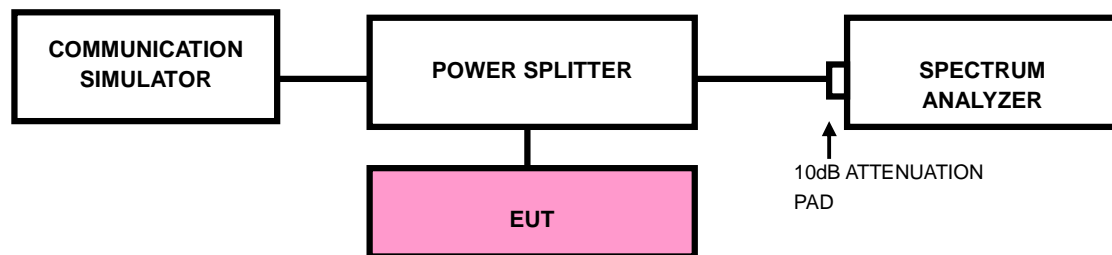

### 3.4.3 TEST PROCEDURES

- a. All measurements were done at low and high operational frequency range.
- b. The center frequency of spectrum is the band edge frequency and span is 1.5MHz.  
RBW of the spectrum is 10kHz and VBW of the spectrum is 30kHz (GSM/GPRS/EDGE).
- c. The center frequency of spectrum is the band edge frequency and span is 10MHz.  
RBW of the spectrum is 100kHz and VBW of the spectrum is 300kHz (WCDMA).
- d. The center frequency of spectrum is the band edge frequency and span is 1~5 MHz.  
RBW of the spectrum is 20kHz and VBW of the spectrum is 100 kHz. (LTE bandwidth 1.4MHz).
- e. The center frequency of spectrum is the band edge frequency and span is 1~5 MHz.  
RBW of the spectrum is 30kHz and VBW of the spectrum is 100kHz. (LTE bandwidth 3MHz)
- f. The center frequency of spectrum is the band edge frequency and span is 1~5 MHz.  
RBW of the spectrum is 50kHz and VBW of the spectrum is 200kHz. (LTE bandwidth 5MHz)
- g. The center frequency of spectrum is the band edge frequency and span is 1~5 MHz.  
RBW of the spectrum is 100kHz and VBW of the spectrum is 300kHz. (LTE bandwidth 10MHz)
- h. Record the max trace plot into the test report.

### 3.4.4 TEST RESULTS

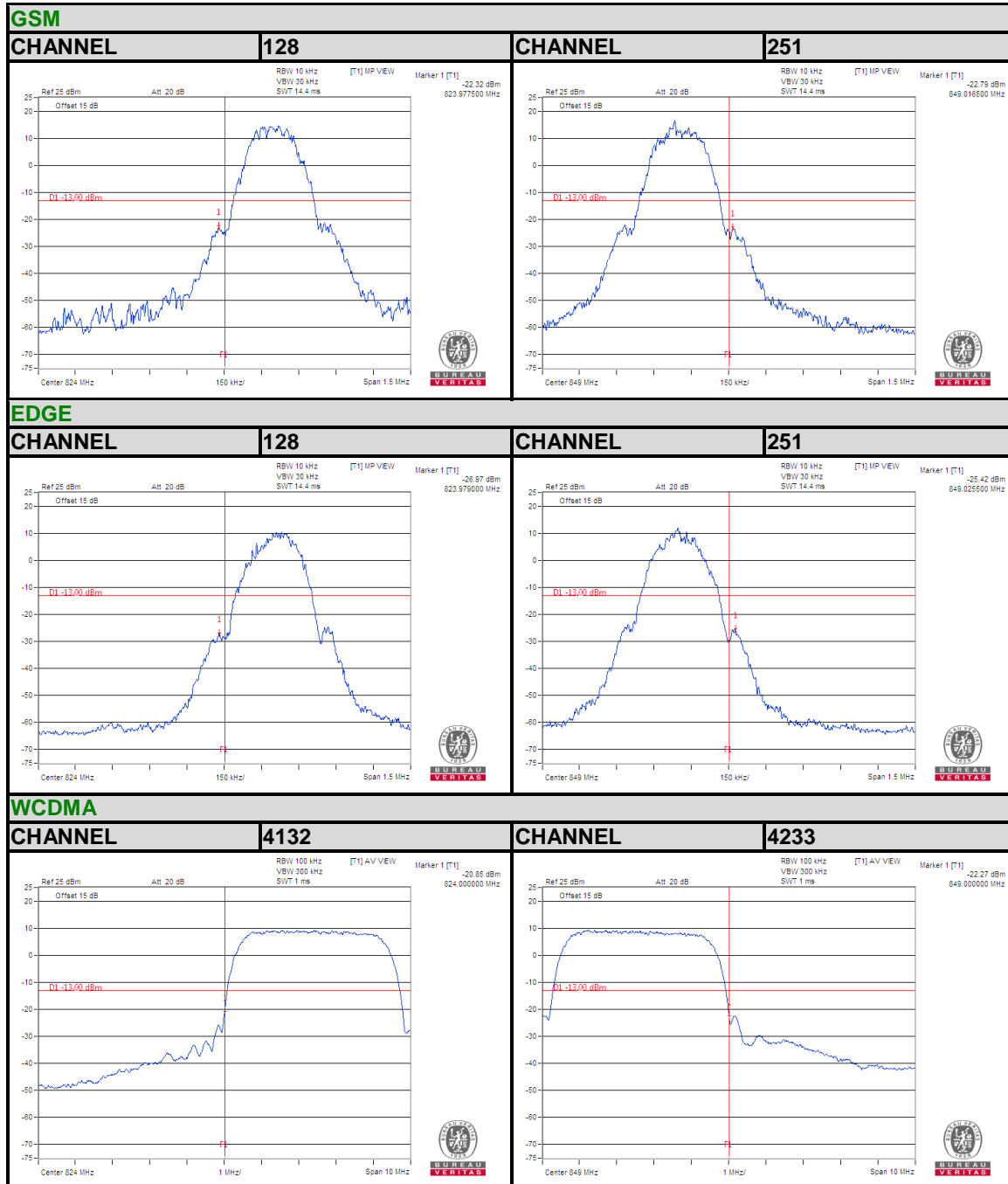





BUREAU VERITAS

Test Report No.: RF180521W014-1

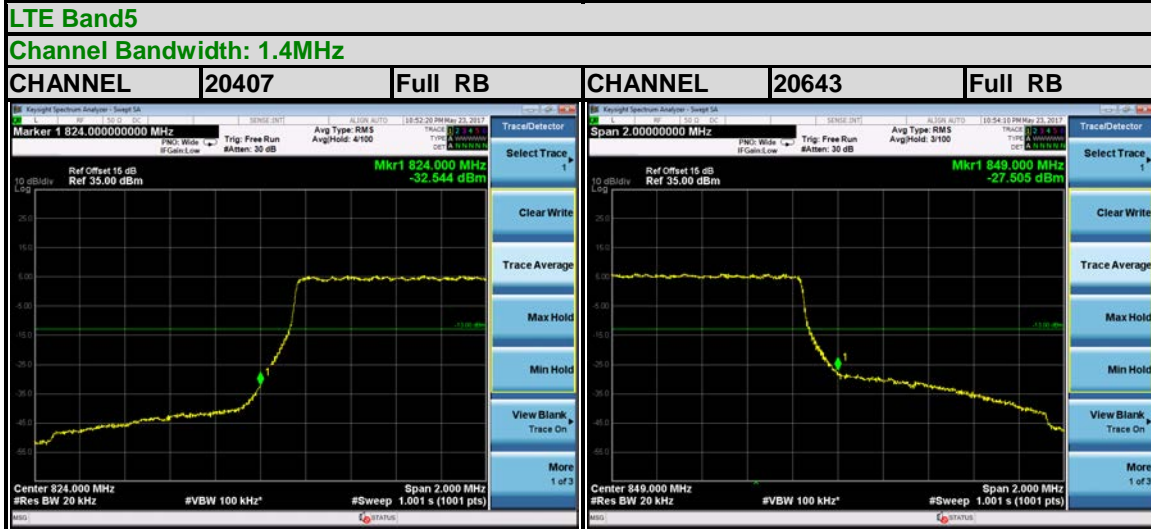
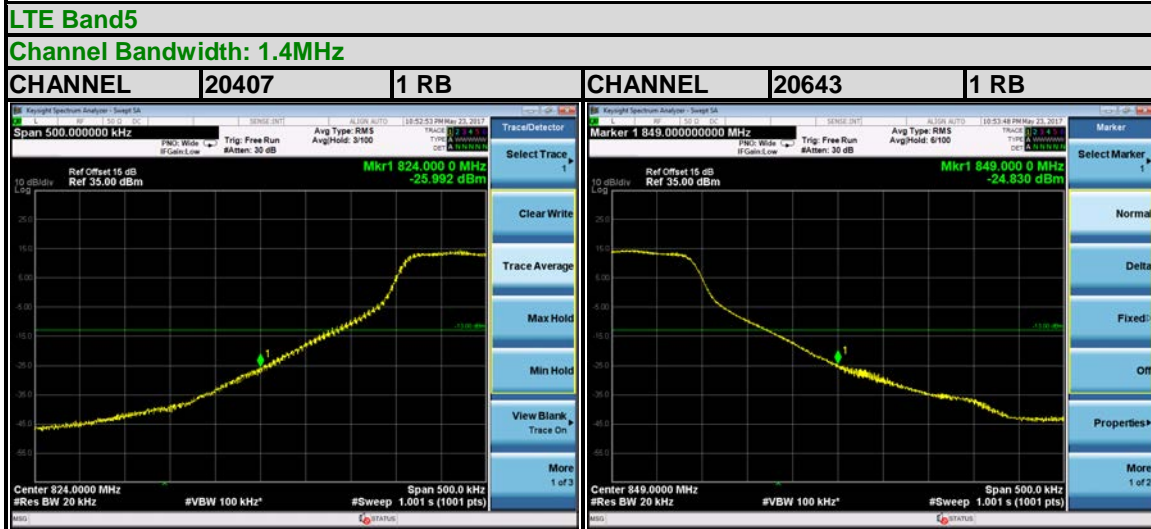



BUREAU VERITAS

Test Report No.: RF180521W014-1

**LTE Band5**

**Channel Bandwidth: 3MHz**

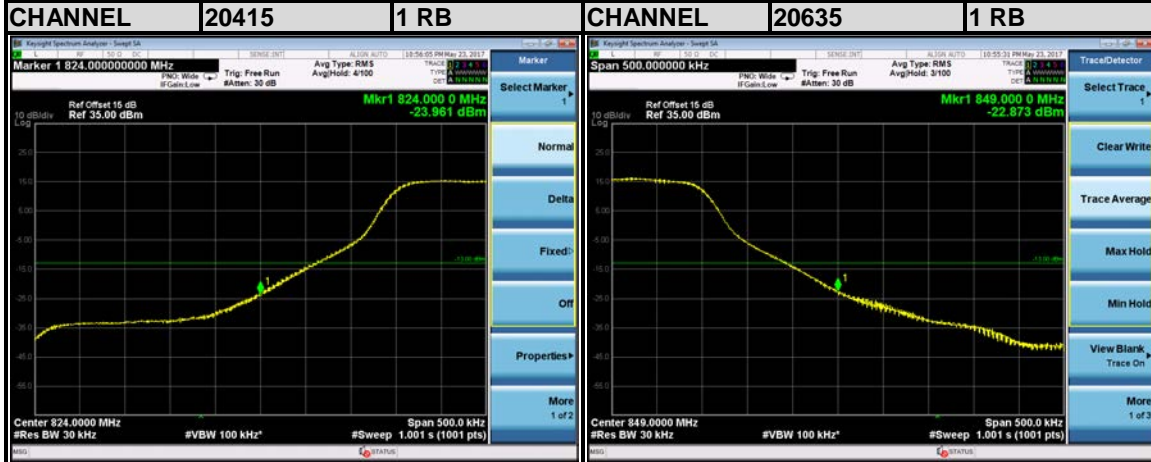

**LTE Band5**

**Channel Bandwidth: 3MHz**





BUREAU VERITAS

Test Report No.: RF180521W014-1

**LTE Band5**

**Channel Bandwidth: 5MHz**

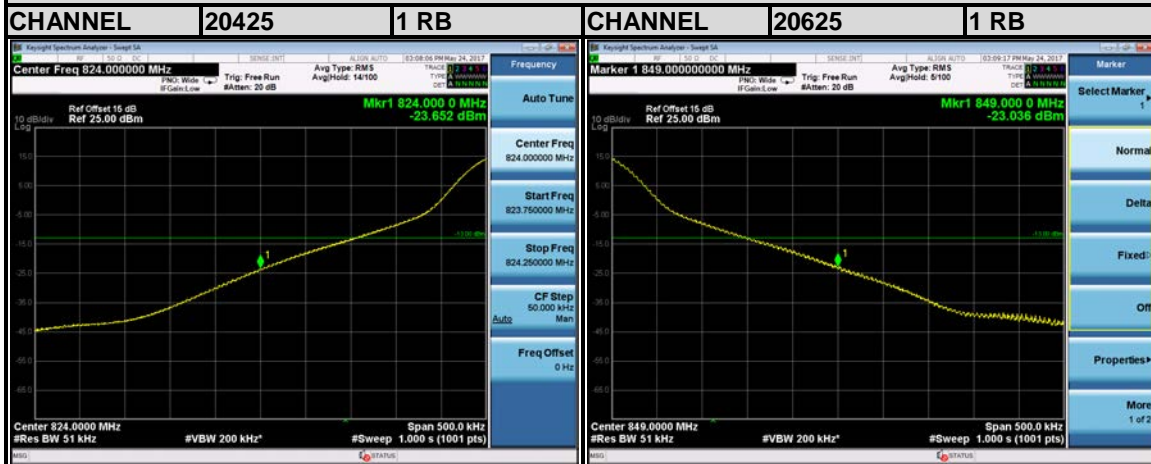

**LTE Band5**

**Channel Bandwidth: 5MHz**

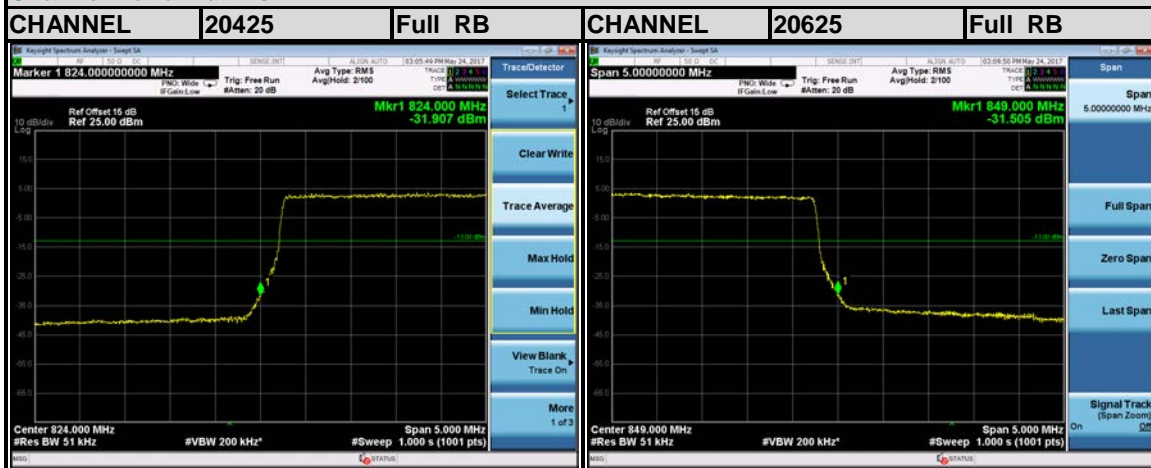



BUREAU VERITAS

Test Report No.: RF180521W014-1

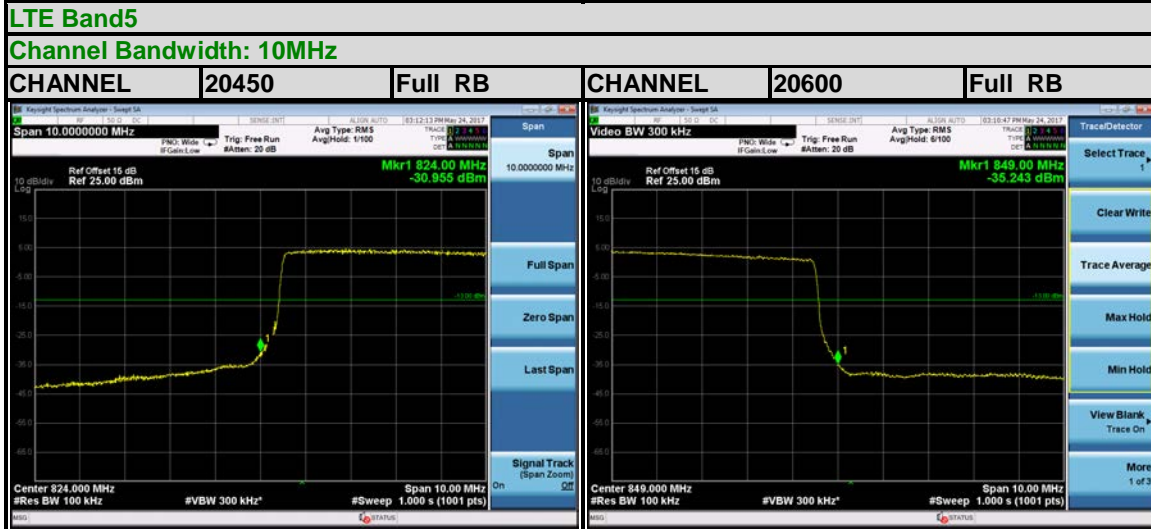
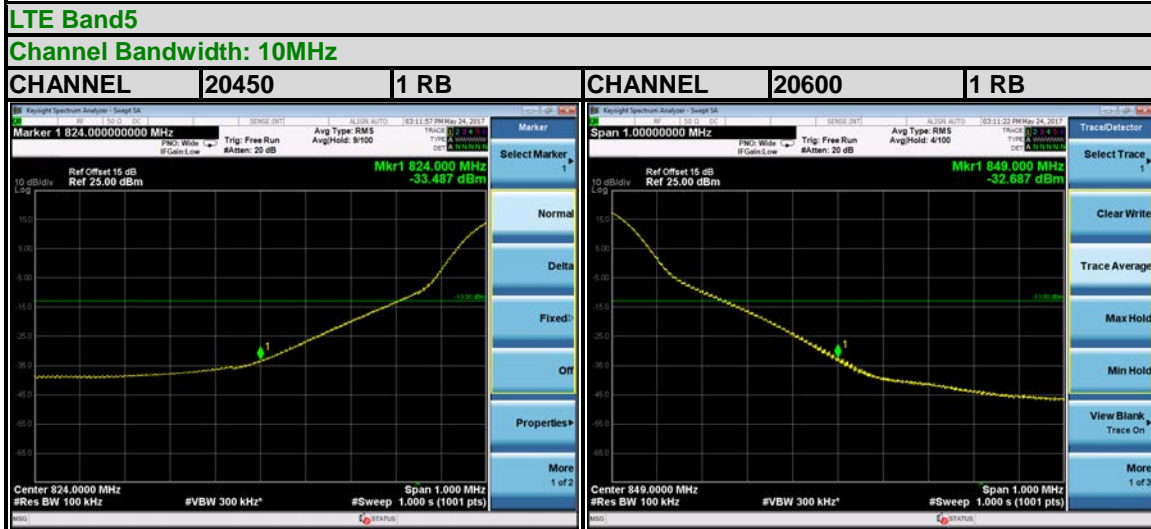

### 3.5 CONDUCTED SPURIOUS EMISSIONS

#### 3.5.1 LIMITS OF CONDUCTED SPURIOUS EMISSIONS MEASUREMENT

The power of any emission outside of the authorized operating frequency ranges must be attenuated below the transmitting power (P) by a factor of at least  $43 + 10 \log(P)$  dB. The emission limit equal to  $-13\text{dBm}$ .

#### 3.5.2 TEST PROCEDURE

- a. The EUT makes a phone call to the communication simulator. All measurements were done at low, middle and high operational frequency range.
- b. Measuring frequency range is from 9 kHz to 9GHz. 10dB attenuation pad is connected with spectrum. RBW=1MHz and VBW=3MHz is used for conducted emission measurement.

#### 3.5.3 TEST SETUP

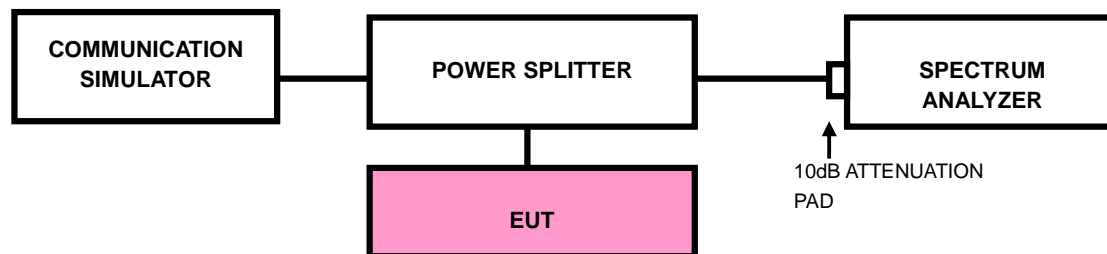



BUREAU VERITAS

Test Report No.: RF180521W014-1

### 3.5.4 TEST RESULTS

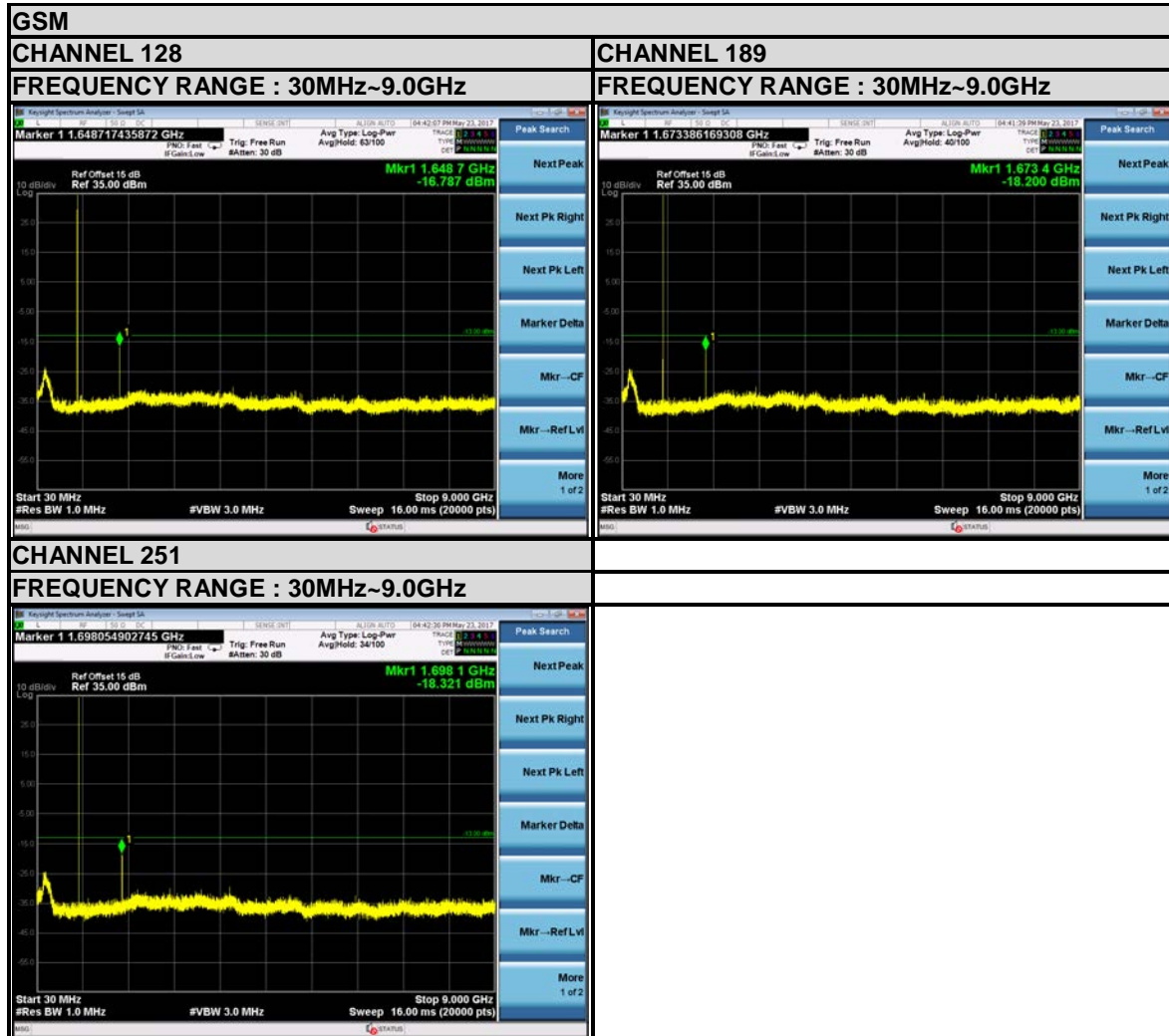



BUREAU VERITAS

Test Report No.: RF180521W014-1





BUREAU VERITAS

Test Report No.: RF180521W014-1

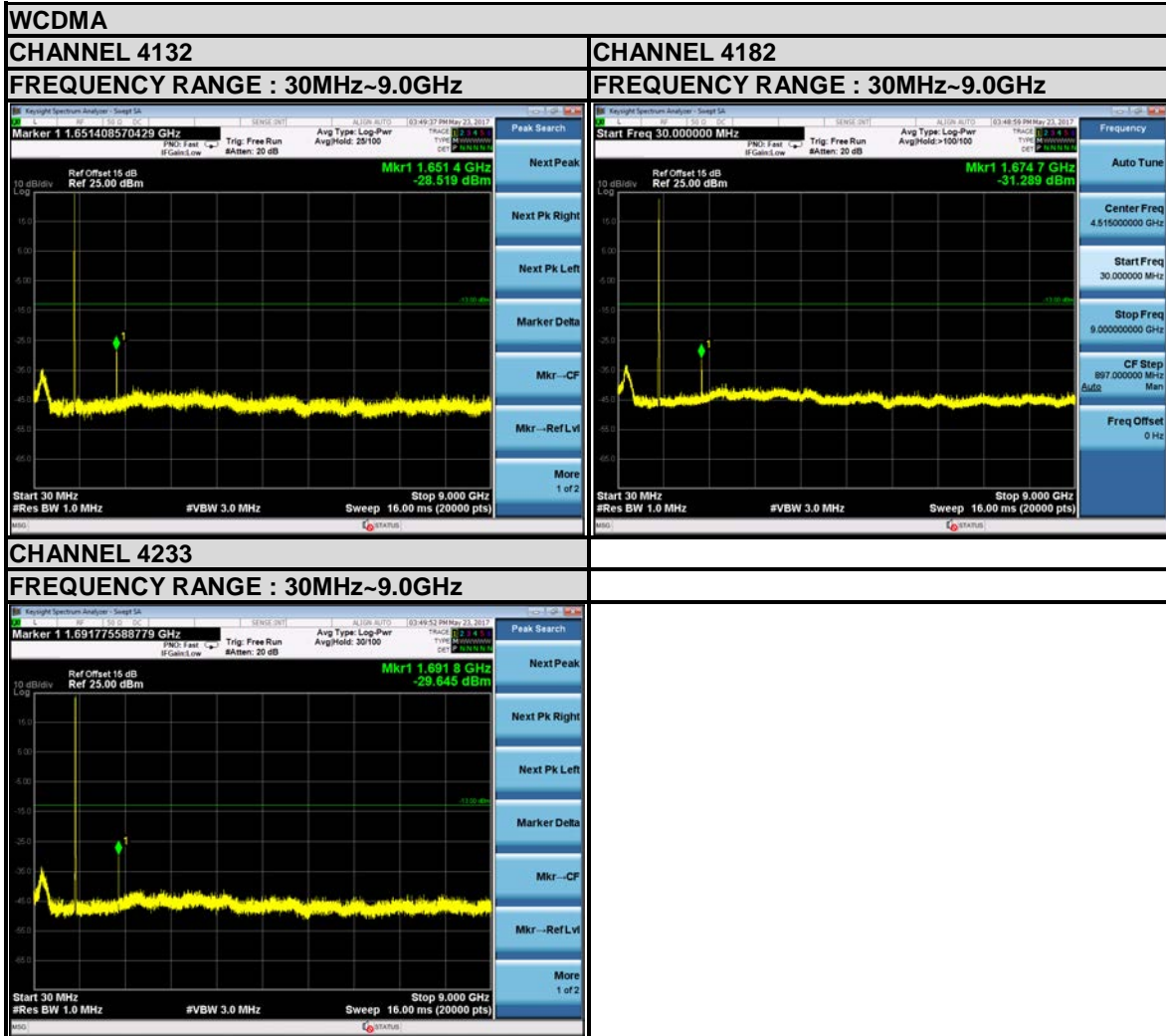





Test Report No.: RF180521W014-1





BUREAU VERITAS

Test Report No.: RF180521W014-1

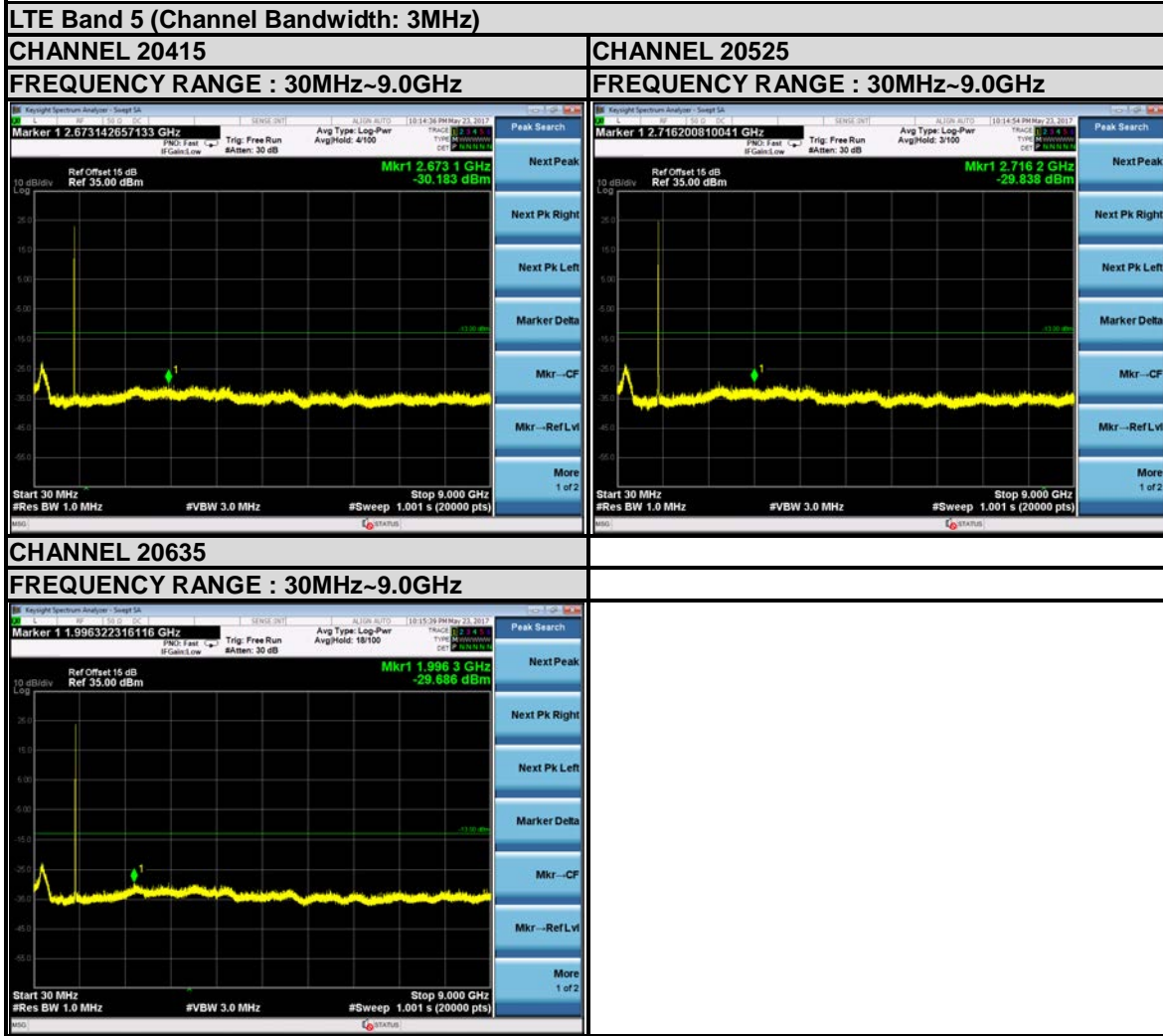





BUREAU VERITAS

Test Report No.: RF180521W014-1

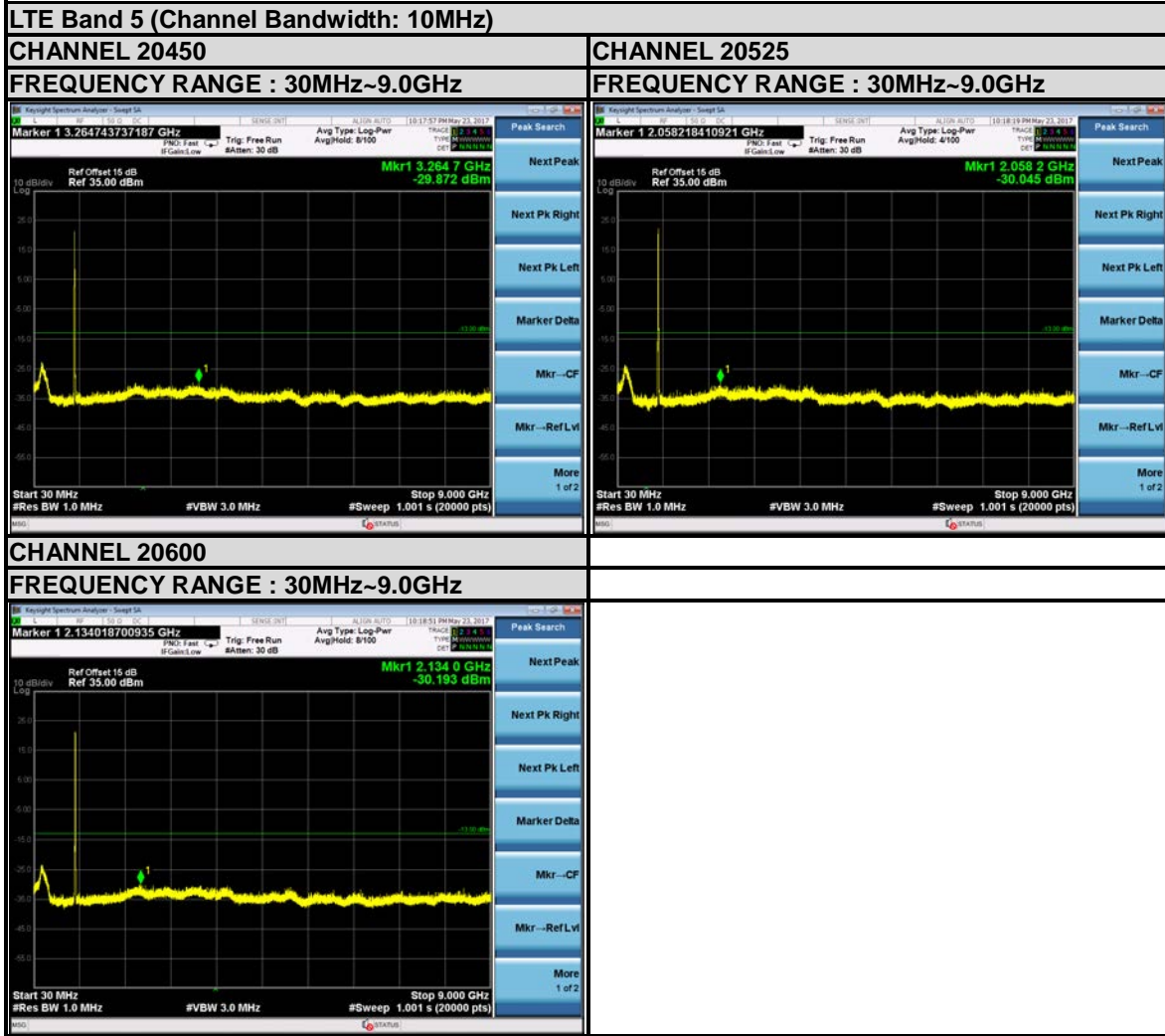

### 3.6 RADIATED EMISSION MEASUREMENT

#### 3.6.1 LIMITS OF RADIATED EMISSION MEASUREMENT

The power of any emission outside of the authorized operating frequency ranges must be attenuated below the transmitting power (P) by a factor of at least  $43 + 10 \log(P)$  dB. The emission limit equal to  $-13\text{dBm}$ .

#### 3.6.2 TEST PROCEDURES

- a. Substitution method is used for E.I.R.P measurement. In the semi-anechoic chamber, EUT placed on the 0.8m height of Turn Table, rotated the table around 360 degrees to search the maximum radiation power and receiver antenna shall be rotated vertical and horizontal polarization and moved height from 1m to 4m to find the maximum polar radiated power. The “Read Value” is the spectrum reading the maximum power value.
- b. The substitution horn antenna is substituted for EUT at the same position and signals generator export the CW signal to the substitution antenna via a TX cable. Rotated the Turn Table and moved receiving antenna to find the maximum radiation power. Adjust output power level of S.G to get a Value of spectrum reading equal to “Read Value” of step a. Record the power level of S.G
- c.  $\text{EIRP} = \text{Output power level of S.G} - \text{TX cable loss} + \text{Antenna gain of substitution horn}$ .
- d. E.R.P power can be calculated form E.I.R.P power by subtracting the gain of dipole,  
 $\text{E.R.P power} = \text{E.I.P.R power} - 2.15\text{dBi}$ .

**NOTE:** The resolution bandwidth and video bandwidth of test receiver/spectrum analyzer is 1MHz/3MHz.

#### 3.6.3 DEVIATION FROM TEST STANDARD

No deviation

### 3.6.4 TEST SETUP

#### <Below 30MHz>

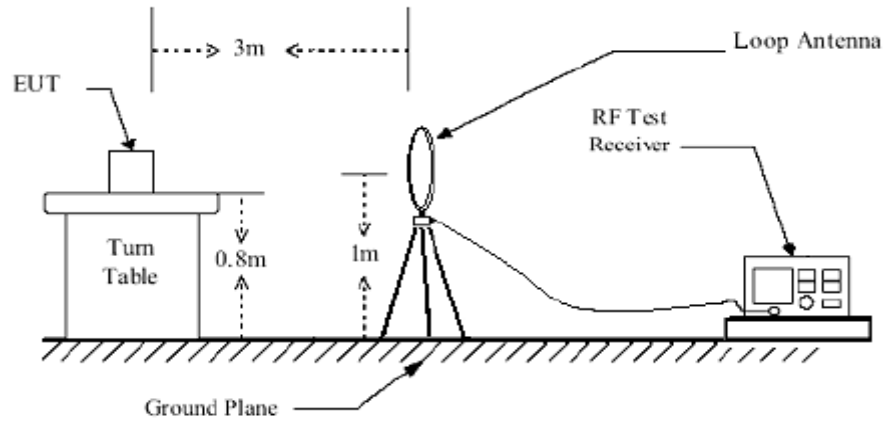

#### < Frequency Range 30MHz~1GHz >

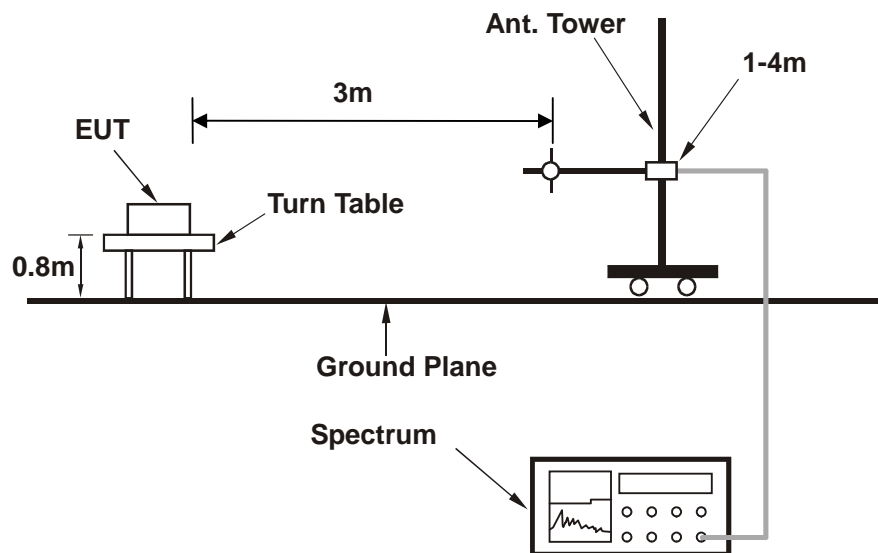

< Frequency Range above 1GHz >

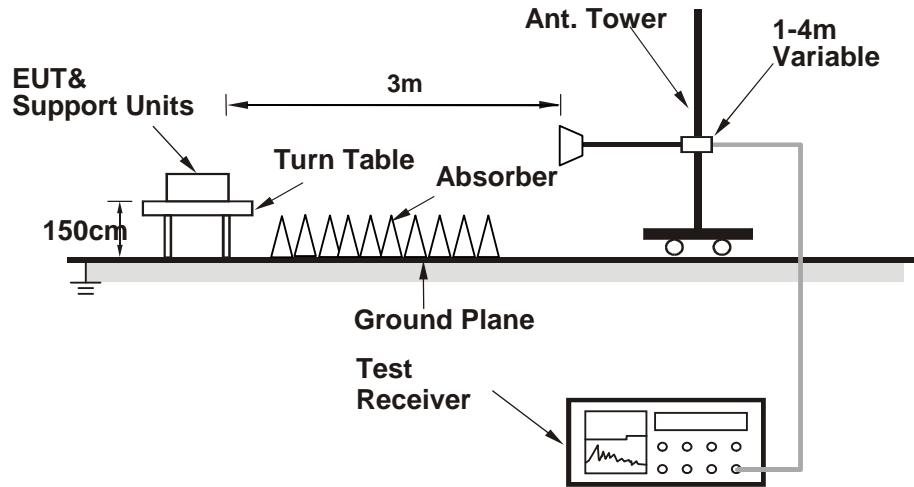

For the actual test configuration, please refer to the attached file (Test Setup Photo).



### 3.6.5 TEST RESULTS

#### BELOW 1GHz WORST-CASE DATA

**9 KHz – 30 KHz data:** the amplitude of spurious emissions attenuated more than 20 dB below the permissible value is not required in the report.

**30 MHz – 1GHz data:**

**GSM 850:**

<b>MODE</b>	TX channel 189	<b>FREQUENCY RANGE</b>	Below 1000MHz
<b>ENVIRONMENTAL CONDITIONS</b>	23deg. C, 70%RH	<b>INPUT POWER</b>	DC 3.8V
<b>TESTED BY</b>	Star Le		
<b>ANTENNA POLARITY &amp; TEST DISTANCE: HORIZONTAL AT 3 M</b>			

	Freq	Level	Read Level	Limit Line	Over Limit	Factor	Remark	Pol/Phase
	MHz	dBm/m	dBm	dBm/m	dB	dB/m		
1	PP	42.610	-42.26	-52.04	-13.00	-29.26	9.78 Peak	Horizontal
2		76.560	-63.70	-54.44	-13.00	-50.70	-9.26 Peak	Horizontal
3		135.730	-55.48	-37.50	-13.00	-42.48	-17.98 Peak	Horizontal
4		179.380	-57.80	-40.02	-13.00	-44.80	-17.78 Peak	Horizontal
5		199.750	-64.86	-47.62	-13.00	-51.86	-17.24 Peak	Horizontal
6		256.980	-67.13	-51.20	-13.00	-54.13	-15.93 Peak	Horizontal

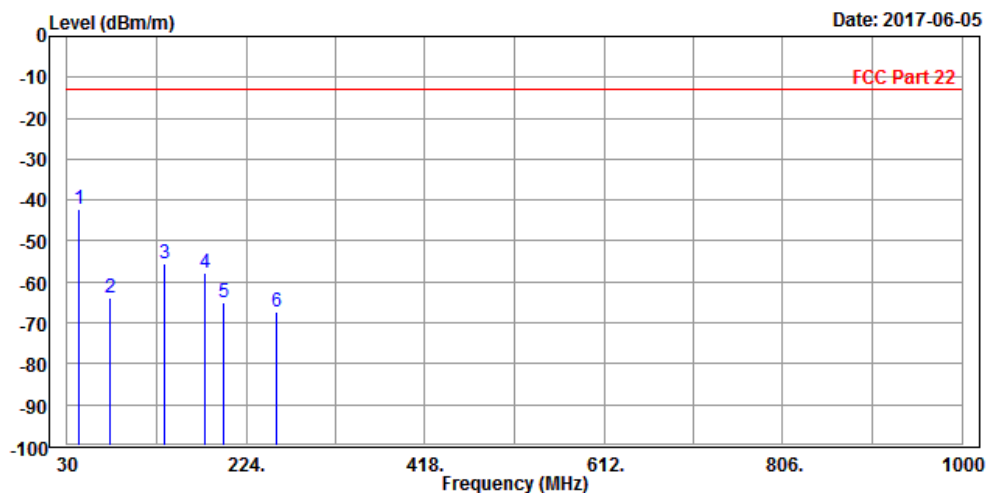





Test Report No.: RF180521W014-1

<b>MODE</b>	TX channel 189	<b>FREQUENCY RANGE</b>	Below 1000MHz
<b>ENVIRONMENTAL CONDITIONS</b>	23deg. C, 70%RH	<b>INPUT POWER</b>	DC 3.8V
<b>TESTED BY</b>	Star Le		
<b>ANTENNA POLARITY &amp; TEST DISTANCE: VERTICAL AT 3 M</b>			

	Freq	Level	Read Level	Limit Line	Over Limit	Factor	Remark	Pol/Phase
	MHz	dBm/m	dBm	dBm/m	dB	dB/m		
1	46.490	-39.51	-35.87	-13.00	-26.51	-3.64	Peak	Vertical
2	76.560	-54.49	-42.41	-13.00	-41.49	-12.08	Peak	Vertical
3	137.670	-54.37	-39.55	-13.00	-41.37	-14.82	Peak	Vertical
4	164.830	-54.67	-39.91	-13.00	-41.67	-14.76	Peak	Vertical
5	201.690	-65.98	-55.32	-13.00	-52.98	-10.66	Peak	Vertical
6	247.280	-74.60	-63.13	-13.00	-61.60	-11.47	Peak	Vertical

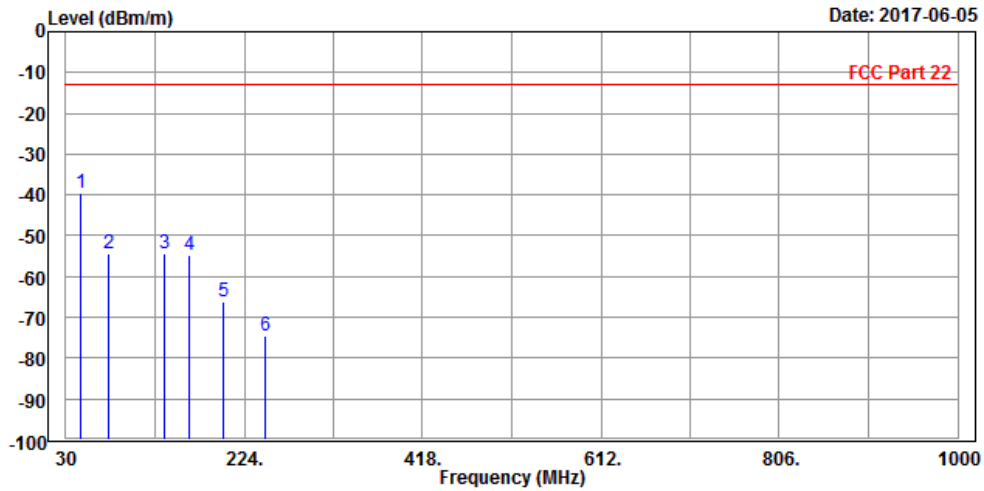



**BUREAU  
VERITAS**

**Test Report No.: RF180521W014-1**

**ABOVE 1GHz DATA**

**Note:** For higher frequency, the emission is too low to be detected.

**GSM 850**

**CH 128:**

<b>MODE</b>	TX channel 128	<b>FREQUENCY RANGE</b>	Above 1000MHz
<b>ENVIRONMENTAL CONDITIONS</b>	23deg. C, 70%RH	<b>INPUT POWER</b>	DC 3.8V
<b>TESTED BY</b>	Star Le		
<b>ANTENNA POLARITY &amp; TEST DISTANCE: HORIZONTAL AT 3 M</b>			

	Freq	Level	Read Level	Limit Line	Over Limit	Factor	Remark	Pol/Phase
	MHz	dBm/m	dBm	dBm/m	dB	dB/m		
1	1648.000	-44.59	-39.62	-13.00	-31.59	-4.97	Peak	Horizontal
2 PP	2476.000	-42.58	-40.93	-13.00	-29.58	-1.65	Peak	Horizontal

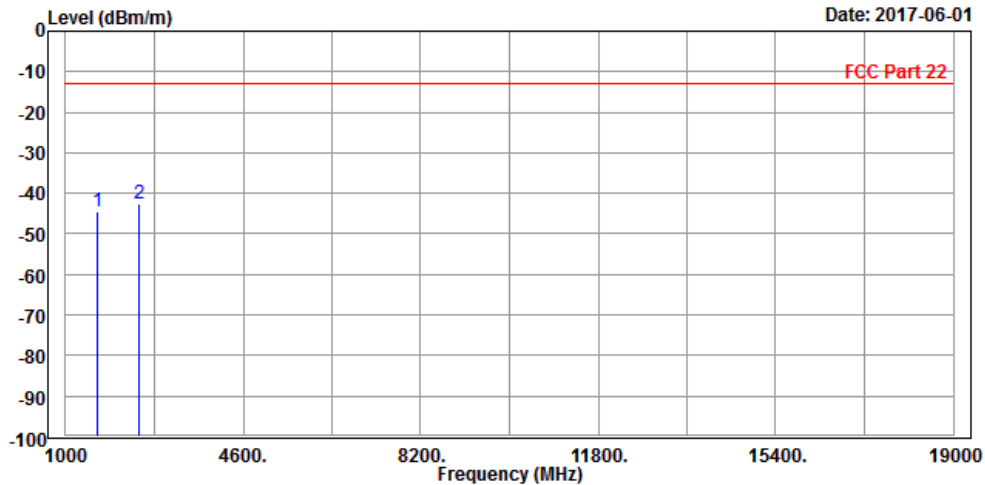



Test Report No.: RF180521W014-1

<b>MODE</b>	TX channel 128	<b>FREQUENCY RANGE</b>	Above 1000MHz
<b>ENVIRONMENTAL CONDITIONS</b>	23deg. C, 70%RH	<b>INPUT POWER</b>	DC 3.8V
<b>TESTED BY</b>	Star Le		
<b>ANTENNA POLARITY &amp; TEST DISTANCE: VERTICAL AT 3 M</b>			

	Freq	Level	Read Level	Limit Line	Over Limit	Factor	Remark	Pol/Phase
	MHz	dBm/m	dBm	dBm/m	dB	dB/m		
1	1648.000	-57.18	-53.63	-13.00	-44.18	-3.55	Peak	Vertical
2	PP 2476.000	-54.57	-54.40	-13.00	-41.57	-0.17	Peak	Vertical

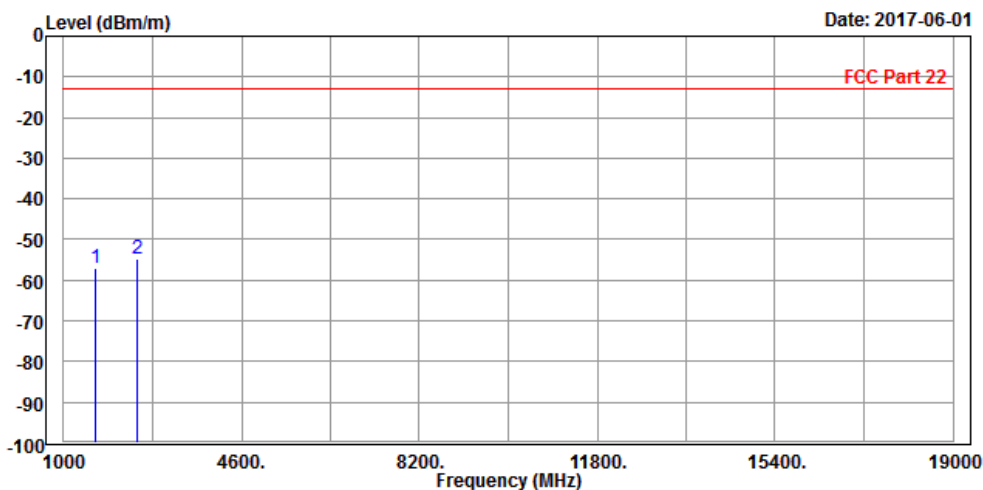



Test Report No.: RF180521W014-1

CH 189:

<b>MODE</b>	TX channel 189	<b>FREQUENCY RANGE</b>	Above 1000MHz
<b>ENVIRONMENTAL CONDITIONS</b>	23deg. C, 70%RH	<b>INPUT POWER</b>	DC 3.8V
<b>TESTED BY</b>	Star Le		
<b>ANTENNA POLARITY &amp; TEST DISTANCE: HORIZONTAL AT 3 M</b>			

	Freq	Level	Read Level	Limit Line	Over Limit	Factor	Remark	Pol/Phase
	MHz	dBm/m	dBm	dBm/m	dB	dB/m		
1	PP 1666.000	-41.50	-36.68	-13.00	-28.50	-4.82	Peak	Horizontal
2	2512.000	-47.25	-45.66	-13.00	-34.25	-1.59	Peak	Horizontal

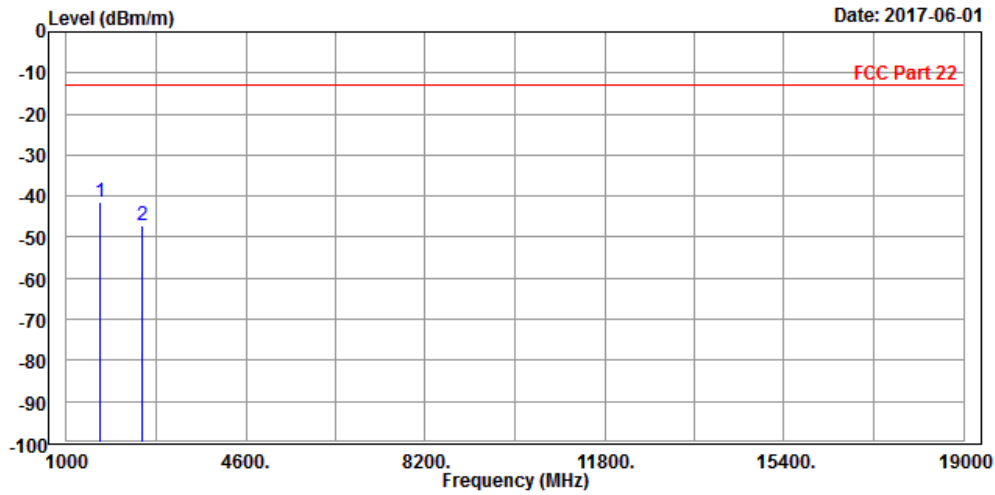



Test Report No.: RF180521W014-1

<b>MODE</b>	TX channel 189	<b>FREQUENCY RANGE</b>	Above 1000MHz
<b>ENVIRONMENTAL CONDITIONS</b>	23deg. C, 70%RH	<b>INPUT POWER</b>	DC 3.8V
<b>TESTED BY</b>	Star Le		
<b>ANTENNA POLARITY &amp; TEST DISTANCE: VERTICAL AT 3 M</b>			

	Freq	Level	Read Level	Limit Line	Over Limit	Factor	Remark	Pol/Phase
	MHz	dBm/m	dBm	dBm/m	dB	dB/m		
1	PP 1666.000	-41.94	-38.56	-13.00	-28.94	-3.38	Peak	Vertical
2	2512.000	-42.03	-41.91	-13.00	-29.03	-0.12	Peak	Vertical

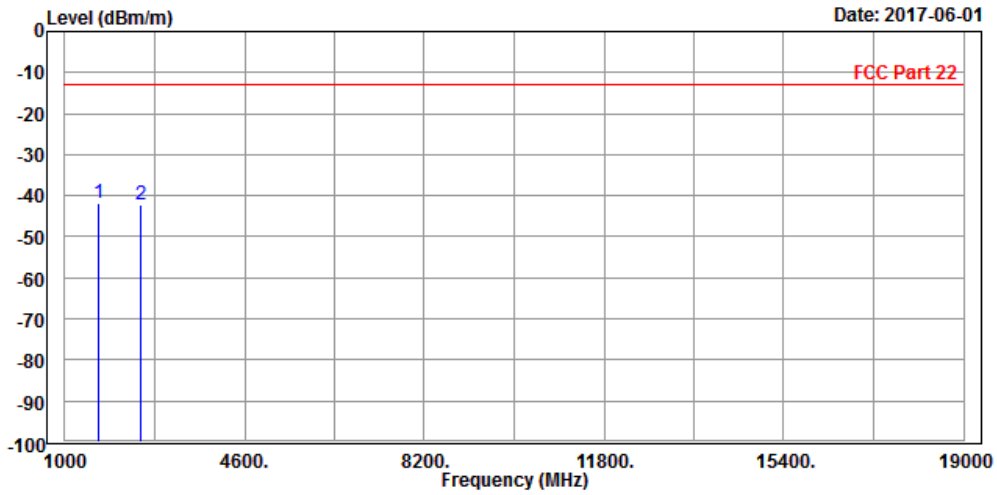



BUREAU VERITAS

Test Report No.: RF180521W014-1

CH 251:

MODE	TX channel 251	FREQUENCY RANGE	Above 1000MHz
ENVIRONMENTAL CONDITIONS	23deg. C, 70%RH	INPUT POWER	DC 3.8V
TESTED BY	Star Le		
<b>ANTENNA POLARITY &amp; TEST DISTANCE: HORIZONTAL AT 3 M</b>			

	Freq	Level	Read Level	Limit	Over Limit	Factor	Remark	Pol/Phase
	MHz	dBm/m	dBm	dBm/m	dB	dB/m		
1	1702.000	-59.05	-54.53	-13.00	-46.05	-4.52	Peak	Horizontal
2	PP 2548.000	-55.80	-54.35	-13.00	-42.80	-1.45	Peak	Horizontal

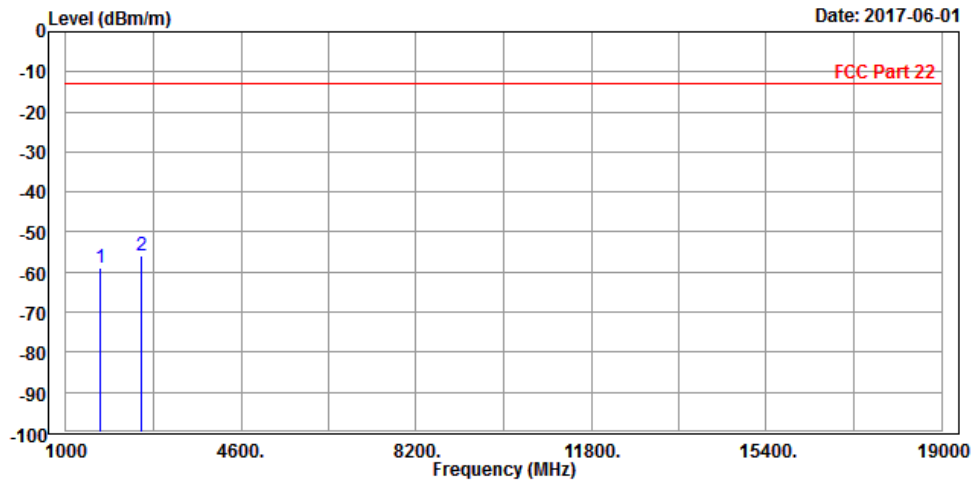



Test Report No.: RF180521W014-1

<b>MODE</b>	TX channel 251	<b>FREQUENCY RANGE</b>	Above 1000MHz
<b>ENVIRONMENTAL CONDITIONS</b>	23deg. C, 70%RH	<b>INPUT POWER</b>	DC 3.8V
<b>TESTED BY</b>	Star Le		
<b>ANTENNA POLARITY &amp; TEST DISTANCE: VERTICAL AT 3 M</b>			

	Freq	Level	Read Level	Limit Line	Over Limit	Factor	Remark	Pol/Phase
	MHz	dBm/m	dBm	dBm/m	dB	dB/m		
1	1702.000	-56.84	-53.79	-13.00	-43.84	-3.05	Peak	Vertical
2	PP 2548.000	-54.00	-54.03	-13.00	-41.00	0.03	Peak	Vertical

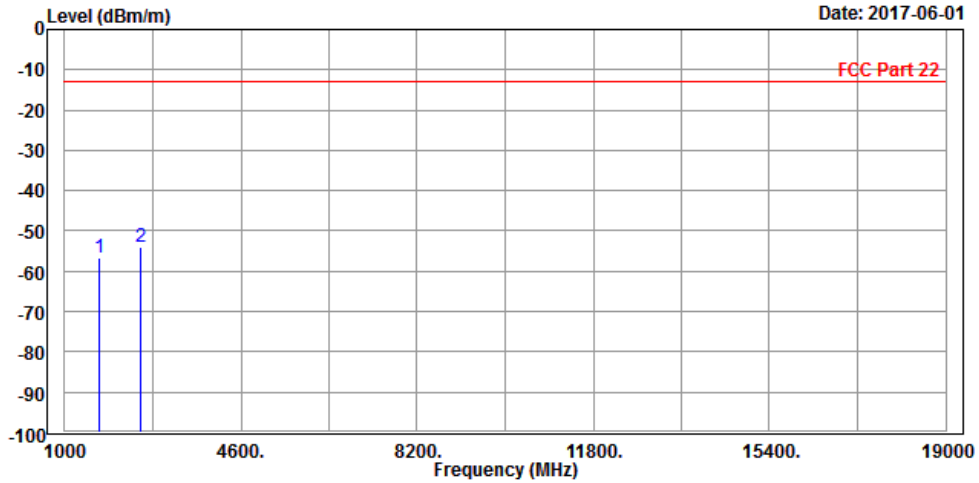



**BUREAU  
VERITAS**

Test Report No.: RF180521W014-1

EDGE 850:

CH 128:

<b>MODE</b>	TX channel 128	<b>FREQUENCY RANGE</b>	Above 1000MHz
<b>ENVIRONMENTAL CONDITIONS</b>	23deg. C, 70%RH	<b>INPUT POWER</b>	DC 3.8V
<b>TESTED BY</b>	Star Le		
<b>ANTENNA POLARITY &amp; TEST DISTANCE: HORIZONTAL AT 3 M</b>			

	Freq	Level	Read Level	Limit Line	Over Limit	Factor	Remark	Pol/Phase
	MHz	dBm/m	dBm	dBm/m	dB	dB/m		
1	PP 1648.000	-54.21	-49.24	-13.00	-41.21	-4.97	Peak	Horizontal
2	2476.000	-55.10	-53.45	-13.00	-42.10	-1.65	Peak	Horizontal

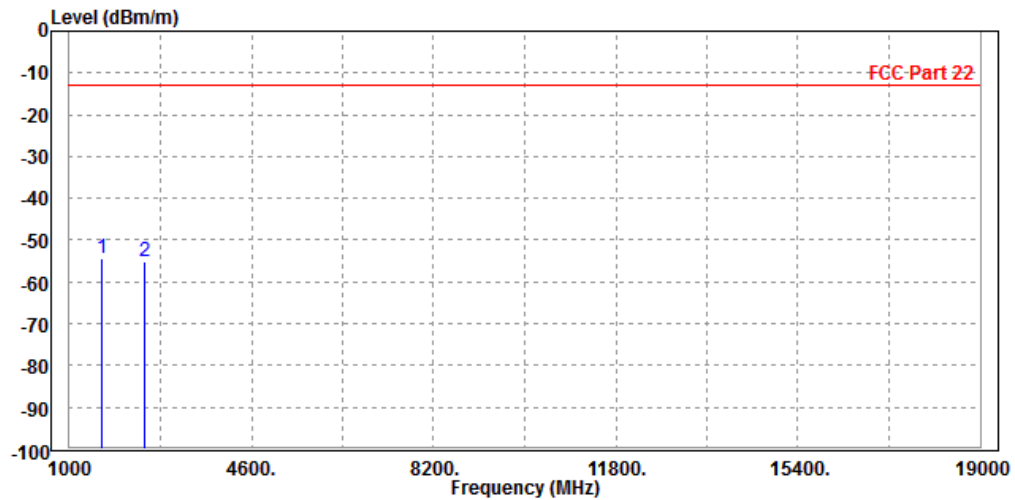





Test Report No.: RF180521W014-1

MODE	TX channel 128	FREQUENCY RANGE	Above 1000MHz
ENVIRONMENTAL CONDITIONS	23deg. C, 70%RH	INPUT POWER	DC 3.8V
TESTED BY	Star Le		
ANTENNA POLARITY & TEST DISTANCE: VERTICAL AT 3 M			

	Freq	Level	Read Level	Limit Line	Over Limit	Factor	Remark	Pol/Phase
	MHz	dBm/m	dBm	dBm/m	dB	dB/m		
1	PP 1648.000	-46.06	-42.51	-13.00	-33.06	-3.55	Peak	Vertical
2	2476.000	-48.52	-48.35	-13.00	-35.52	-0.17	Peak	Vertical

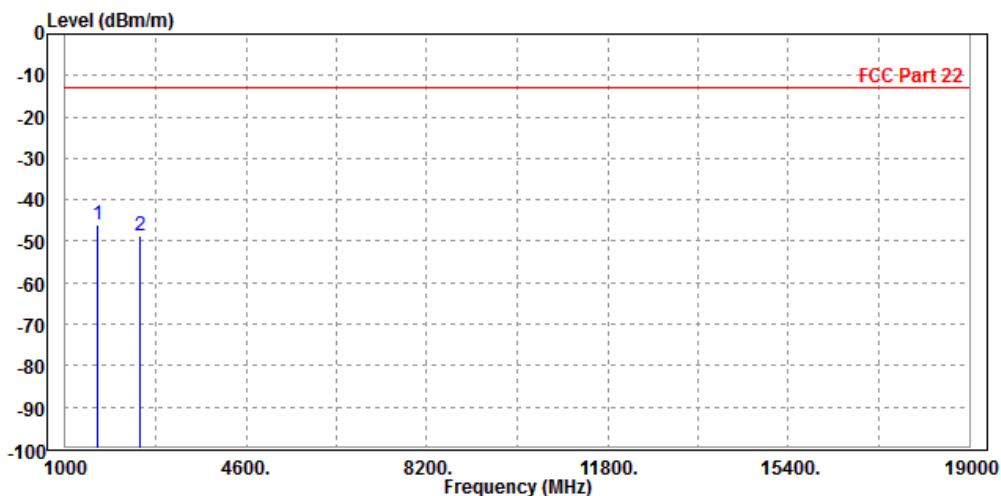



Test Report No.: RF180521W014-1

CH 189:

<b>MODE</b>	TX channel 189	<b>FREQUENCY RANGE</b>	Above 1000MHz
<b>ENVIRONMENTAL CONDITIONS</b>	23deg. C, 70%RH	<b>INPUT POWER</b>	DC 3.8V
<b>TESTED BY</b>	Star Le		
<b>ANTENNA POLARITY &amp; TEST DISTANCE: HORIZONTAL AT 3 M</b>			

	Freq	Level	Read Level	Limit Line	Over Limit	Factor	Remark	Pol/Phase
	MHz	dBm/m	dBm	dBm/m	dB	dB/m		
1	1666.000	-58.59	-53.77	-13.00	-45.59	-4.82	Peak	Horizontal
2	PP 2512.000	-55.09	-53.50	-13.00	-42.09	-1.59	Peak	Horizontal

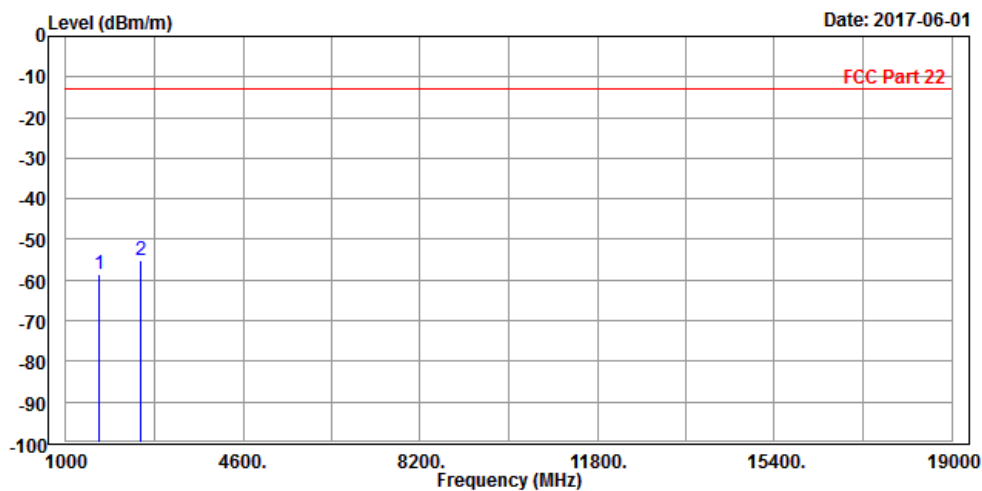



Test Report No.: RF180521W014-1

<b>MODE</b>	TX channel 189	<b>FREQUENCY RANGE</b>	Above 1000MHz
<b>ENVIRONMENTAL CONDITIONS</b>	23deg. C, 70%RH	<b>INPUT POWER</b>	DC 3.8V
<b>TESTED BY</b>	Star Le		
<b>ANTENNA POLARITY &amp; TEST DISTANCE: VERTICAL AT 3 M</b>			

	Freq	Level	Read Level	Limit Line	Over Limit	Factor	Remark	Pol/Phase
	MHz	dBm/m	dBm	dBm/m	dB	dB/m		
1	1666.000	-58.08	-54.70	-13.00	-45.08	-3.38	Peak	Vertical
2	PP 2512.000	-53.65	-53.53	-13.00	-40.65	-0.12	Peak	Vertical

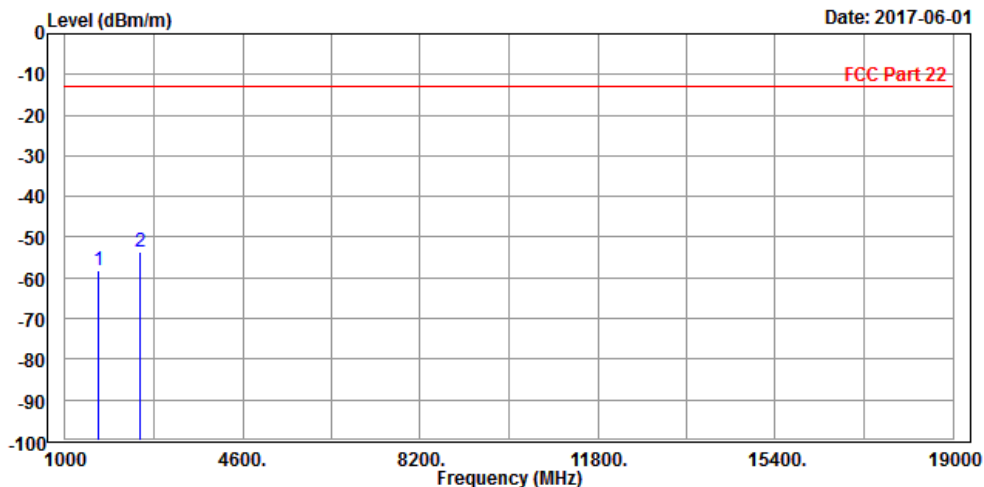



**BUREAU  
VERITAS**

Test Report No.: RF180521W014-1

CH 251:

<b>MODE</b>	TX channel 251	<b>FREQUENCY RANGE</b>	Above 1000MHz
<b>ENVIRONMENTAL CONDITIONS</b>	23deg. C, 70%RH	<b>INPUT POWER</b>	DC 3.8V
<b>TESTED BY</b>	Star Le		
<b>ANTENNA POLARITY &amp; TEST DISTANCE: HORIZONTAL AT 3 M</b>			

	Read	Limit	Over				
Freq	Level	Level	Line	Limit	Factor	Remark	Pol/Phase
MHz	dBm/m	dBm	dBm/m	dB	dB/m		
1	1702.000	-57.92	-53.40	-13.00	-44.92	-4.52 Peak	Horizontal
2	PP 2548.000	-56.11	-54.66	-13.00	-43.11	-1.45 Peak	Horizontal

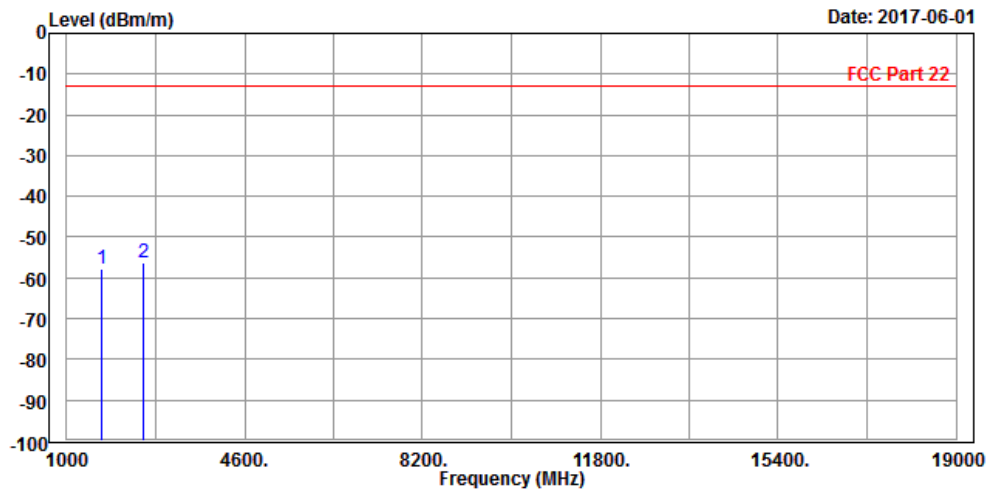



Test Report No.: RF180521W014-1

<b>MODE</b>	TX channel 251	<b>FREQUENCY RANGE</b>	Above 1000MHz
<b>ENVIRONMENTAL CONDITIONS</b>	23deg. C, 70%RH	<b>INPUT POWER</b>	DC 3.8V
<b>TESTED BY</b>	Star Le		
<b>ANTENNA POLARITY &amp; TEST DISTANCE: VERTICAL AT 3 M</b>			

	Freq	Level	Read Level	Limit Line	Over Limit	Factor	Remark	Pol/Phase
	MHz	dBm/m	dBm	dBm/m	dB	dB/m		
1	1702.000	-56.18	-53.13	-13.00	-43.18	-3.05	Peak	Vertical
2	PP 2548.000	-54.12	-54.15	-13.00	-41.12	0.03	Peak	Vertical

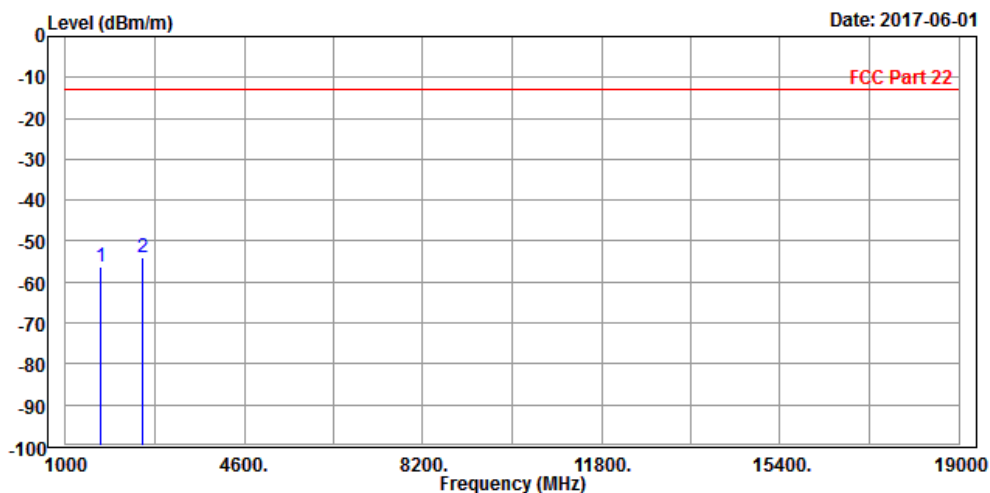



BUREAU VERITAS

Test Report No.: RF180521W014-1

WCDMA Band V:

CH 4132:

MODE	TX channel 4132	FREQUENCY RANGE	Above 1000MHz
ENVIRONMENTAL CONDITIONS	23deg. C, 70%RH	INPUT POWER	DC 3.8V
TESTED BY	Star Le		
<b>ANTENNA POLARITY &amp; TEST DISTANCE: HORIZONTAL AT 3 M</b>			

	Freq	Level	Read Level	Limit Line	Over Limit	Factor	Remark	Pol/Phase
	MHz	dBm/m	dBm	dBm/m	dB	dB/m		
1	PP 1648.000	-45.54	-40.57	-13.00	-32.54	-4.97	Peak	Horizontal
2	2476.000	-58.23	-56.58	-13.00	-45.23	-1.65	Peak	Horizontal

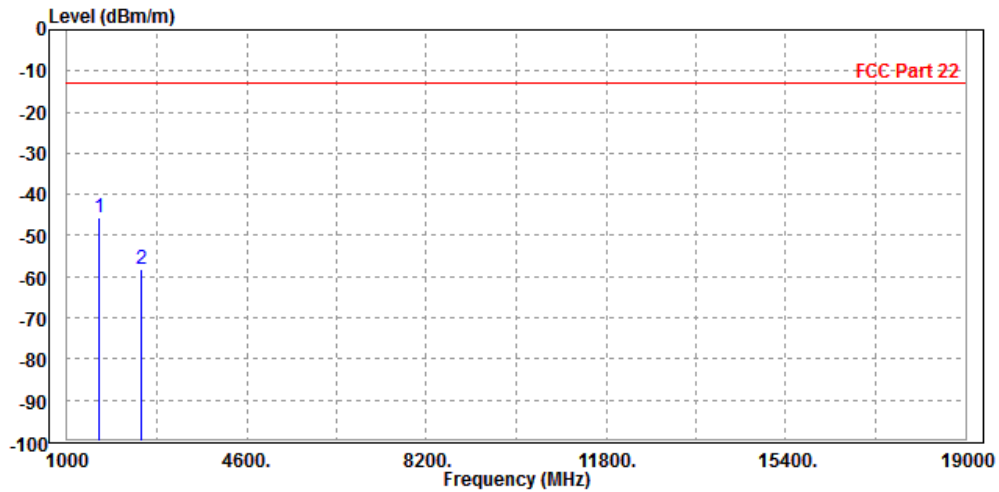



Test Report No.: RF180521W014-1

MODE	TX channel 4132	FREQUENCY RANGE	Above 1000MHz
ENVIRONMENTAL CONDITIONS	23deg. C, 70%RH	INPUT POWER	DC 3.8V
TESTED BY	Star Le		
<b>ANTENNA POLARITY &amp; TEST DISTANCE: VERTICAL AT 3 M</b>			

	Read	Limit	Over			
Freq	Level	Level	Line	Limit	Factor	Remark
MHz	dBm/m	dBm	dBm/m	dB	dB/m	Pol/Phase
1 PP 1648.000	-40.88	-37.33	-13.00	-27.88	-3.55	Peak Vertical
2 2476.000	-56.86	-56.69	-13.00	-43.86	-0.17	Peak Vertical

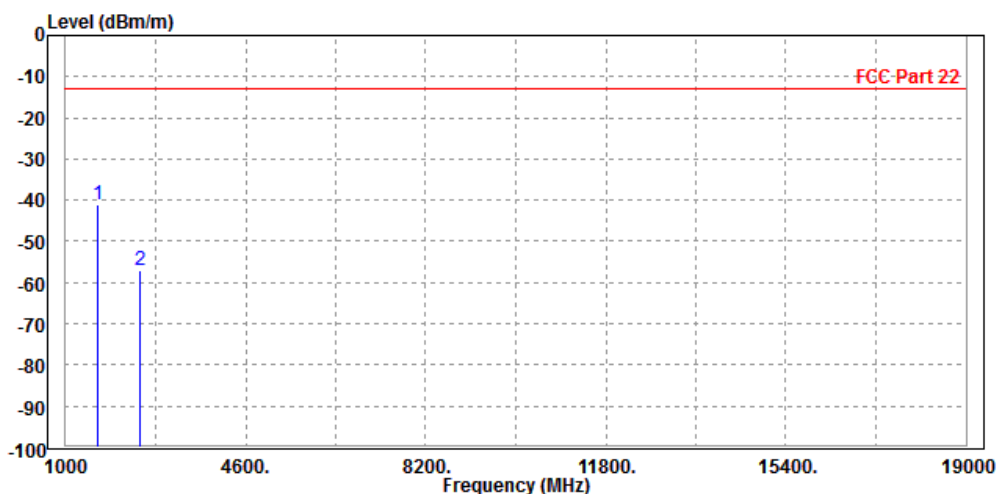



Test Report No.: RF180521W014-1

CH 4182:

<b>MODE</b>	TX channel 4182	<b>FREQUENCY RANGE</b>	Above 1000MHz
<b>ENVIRONMENTAL CONDITIONS</b>	23deg. C, 70%RH	<b>INPUT POWER</b>	DC 3.8V
<b>TESTED BY</b>	Star Le		
<b>ANTENNA POLARITY &amp; TEST DISTANCE: HORIZONTAL AT 3 M</b>			

	Read	Limit	Over				
Freq	Level	Level	Line	Limit	Factor	Remark	Pol/Phase
MHz	dBm/m	dBm	dBm/m	dB	dB/m		
1 PP 1666.000	-55.32	-50.50	-13.00	-42.32	-4.82	Peak	Horizontal
2 2512.000	-55.37	-53.78	-13.00	-42.37	-1.59	Peak	Horizontal

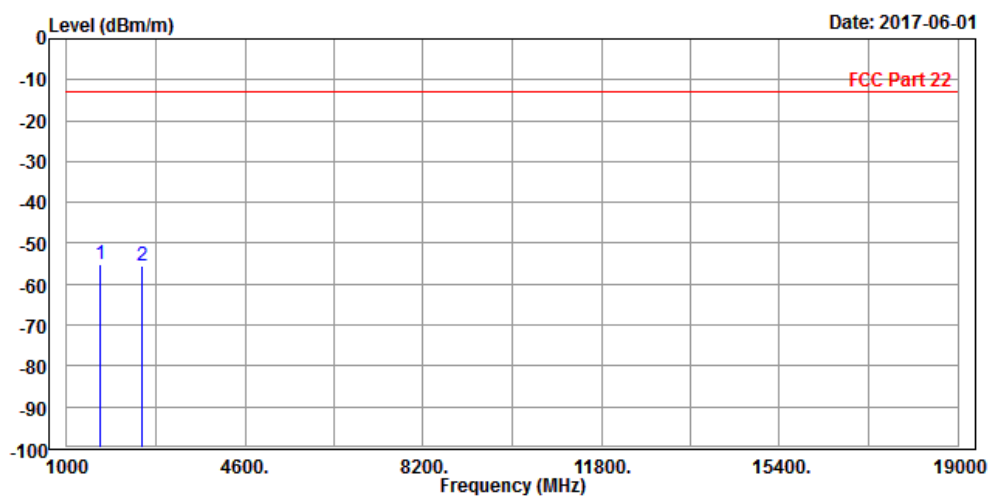





Test Report No.: RF180521W014-1

<b>MODE</b>	TX channel 4182	<b>FREQUENCY RANGE</b>	Above 1000MHz
<b>ENVIRONMENTAL CONDITIONS</b>	23deg. C, 70%RH	<b>INPUT POWER</b>	DC 3.8V
<b>TESTED BY</b>	Star Le		
<b>ANTENNA POLARITY &amp; TEST DISTANCE: VERTICAL AT 3 M</b>			

	Freq	Level	Read Level	Limit	Over Limit	Factor	Remark	Pol/Phase
	MHz	dBm/m	dBm	dBm/m	dB	dB/m		
1	1666.000	-54.10	-50.72	-13.00	-41.10	-3.38	Peak	Vertical
2 PP	2512.000	-52.89	-52.77	-13.00	-39.89	-0.12	Peak	Vertical

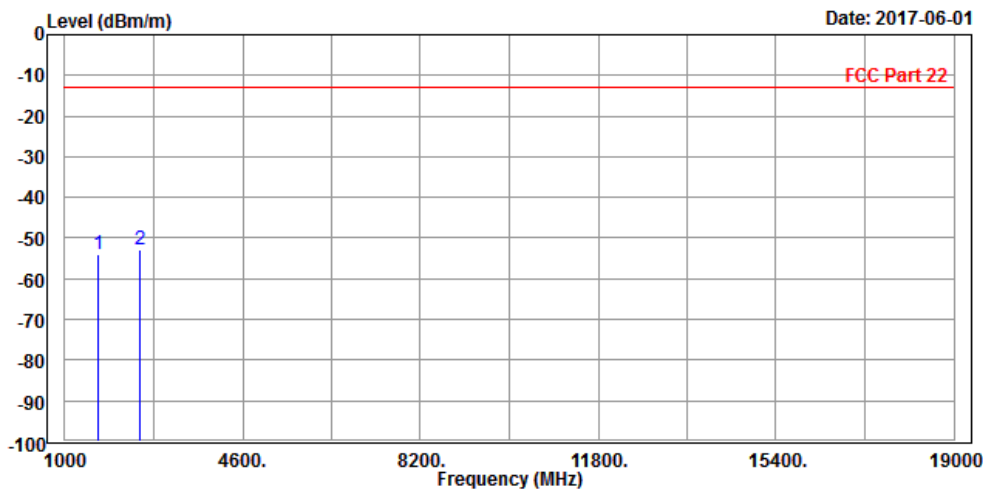



BUREAU VERITAS

Test Report No.: RF180521W014-1

CH 4233:

MODE	TX channel 4233	FREQUENCY RANGE	Above 1000MHz
ENVIRONMENTAL CONDITIONS	23deg. C, 70%RH	INPUT POWER	DC 3.8V
TESTED BY	Star Le		
<b>ANTENNA POLARITY &amp; TEST DISTANCE: HORIZONTAL AT 3 M</b>			

	Read	Limit	Over				
Freq	Level	Level	Line	Limit	Factor	Remark	Pol/Phase
MHz	dBm/m	dBm	dBm/m	dB	dB/m		
1 PP 1702.000	-54.32	-49.80	-13.00	-41.32	-4.52	Peak	Horizontal
2 2548.000	-55.24	-53.79	-13.00	-42.24	-1.45	Peak	Horizontal

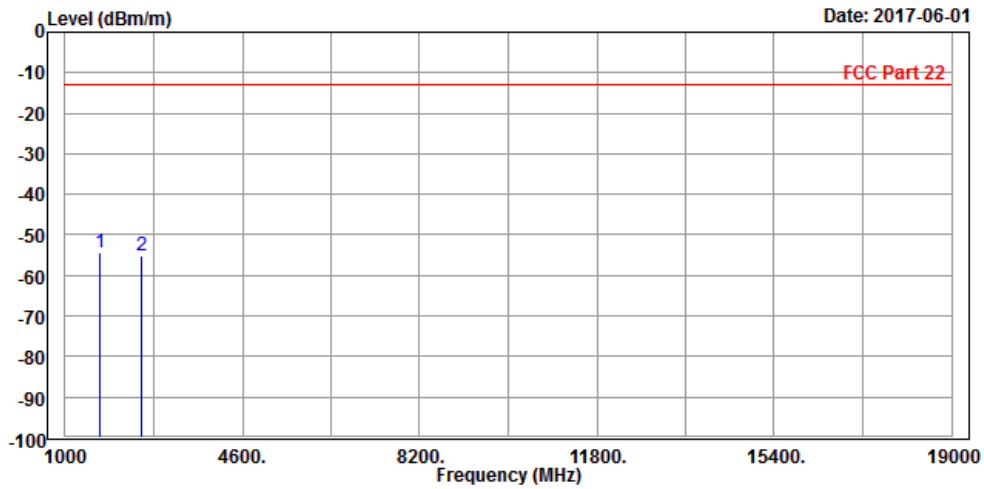



Test Report No.: RF180521W014-1

<b>MODE</b>	TX channel 4233	<b>FREQUENCY RANGE</b>	Above 1000MHz
<b>ENVIRONMENTAL CONDITIONS</b>	23deg. C, 70%RH	<b>INPUT POWER</b>	DC 3.8V
<b>TESTED BY</b>	Star Le		
<b>ANTENNA POLARITY &amp; TEST DISTANCE: VERTICAL AT 3 M</b>			

	Freq	Level	Read Level	Limit Line	Over Limit	Factor	Remark	Pol/Phase
	MHz	dBm/m	dBm	dBm/m	dB	dB/m		
1	1702.000	-53.94	-50.89	-13.00	-40.94	-3.05	Peak	Vertical
2	PP 2548.000	-52.94	-52.97	-13.00	-39.94	0.03	Peak	Vertical

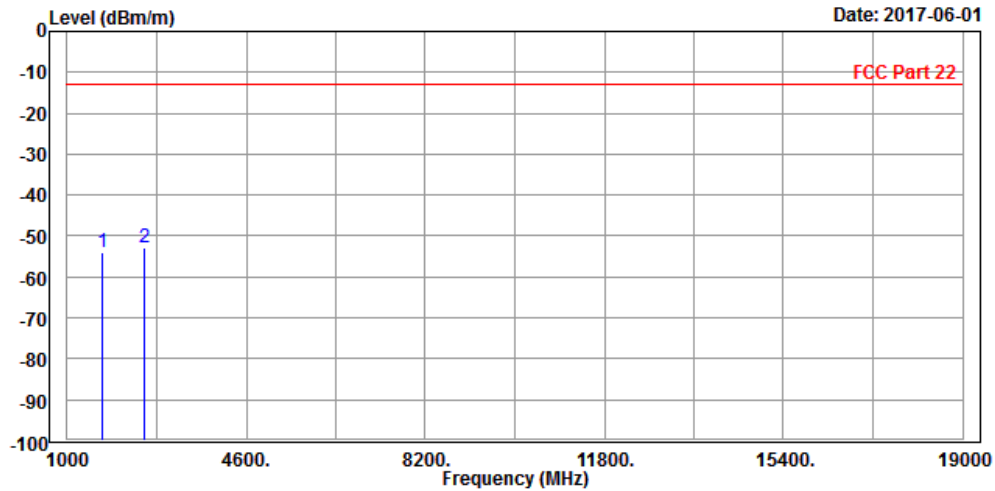



**BUREAU  
VERITAS**

Test Report No.: RF180521W014-1

LTE Band 5

CHANNEL BANDWIDTH: 1.4MHz / QPSK

<b>MODE</b>	TX channel 20525	<b>FREQUENCY RANGE</b>	Above 1000MHz
<b>ENVIRONMENTAL CONDITIONS</b>	26deg. C, 56%RH	<b>INPUT POWER</b>	DC 3.8V
<b>TESTED BY</b>	Star Le		
<b>ANTENNA POLARITY &amp; TEST DISTANCE: HORIZONTAL AT 3 M</b>			

	Freq	Level	Read Level	Limit Line	Over Limit	Factor	Remark	Pol/Phase
	MHz	dBm/m	dBm	dBm/m	dB	dB/m		
1	1666.000	-58.55	-53.73	-13.00	-45.55	-4.82	Peak	Horizontal
2 PP	2512.000	-55.25	-53.66	-13.00	-42.25	-1.59	Peak	Horizontal

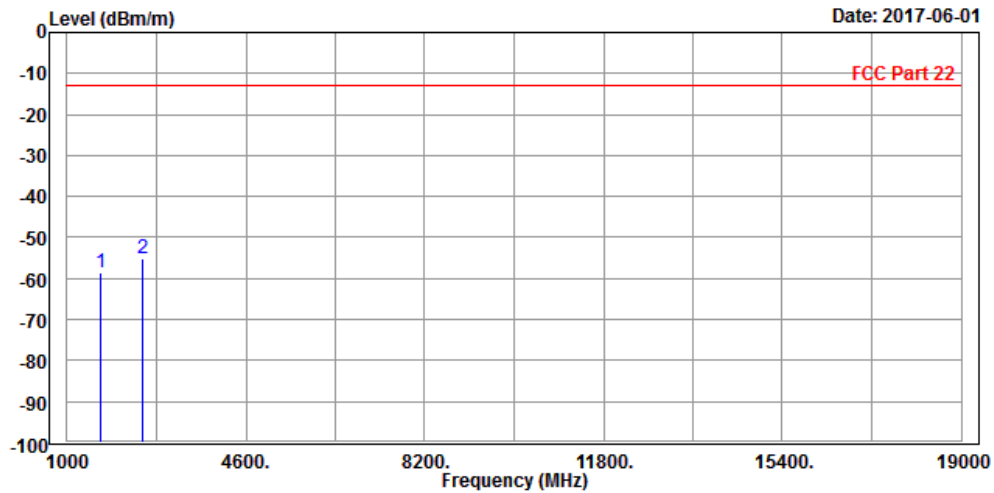



Test Report No.: RF180521W014-1

<b>MODE</b>	TX channel 20525	<b>FREQUENCY RANGE</b>	Above 1000MHz
<b>ENVIRONMENTAL CONDITIONS</b>	26deg. C, 56%RH	<b>INPUT POWER</b>	DC 3.8V
<b>TESTED BY</b>	Star Le		
<b>ANTENNA POLARITY &amp; TEST DISTANCE: VERTICAL AT 3 M</b>			

	Freq	Level	Read Level	Limit Line	Over Limit	Factor	Remark	Pol/Phase
	MHz	dBm/m	dBm	dBm/m	dB	dB/m		
1	1666.000	-56.99	-53.61	-13.00	-43.99	-3.38	Peak	Vertical
2	PP 2512.000	-54.34	-54.22	-13.00	-41.34	-0.12	Peak	Vertical

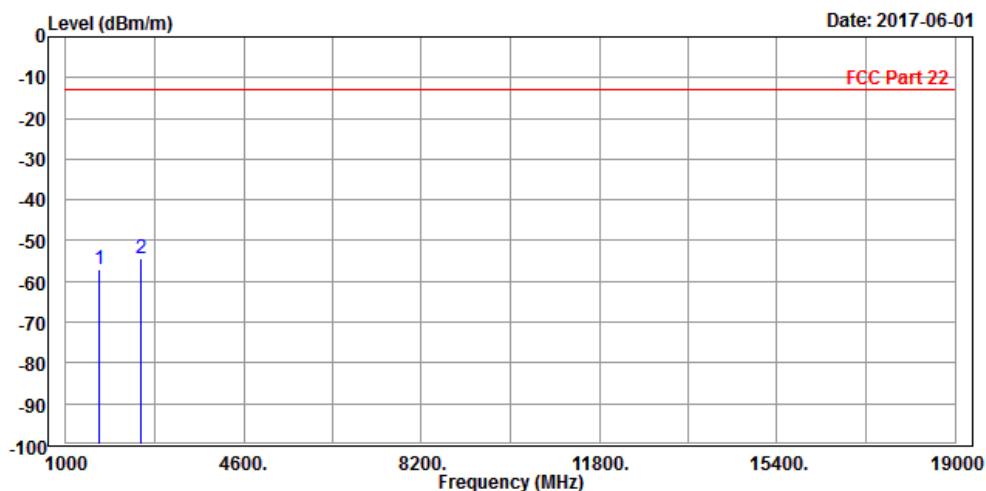



BUREAU VERITAS

Test Report No.: RF180521W014-1

CHANNEL BANDWIDTH: 3MHz / QPSK

MODE	TX channel 20525	FREQUENCY RANGE	Above 1000MHz
ENVIRONMENTAL CONDITIONS	26deg. C, 56%RH	INPUT POWER	DC 3.8V
TESTED BY	Star Le		
ANTENNA POLARITY & TEST DISTANCE: HORIZONTAL AT 3 M			

	Freq	Level	Read Level	Limit Line	Over Limit	Factor	Remark	Pol/Phase
	MHz	dBm/m	dBm	dBm/m	dB	dB/m		
1	PP 1666.000	-50.14	-45.32	-13.00	-37.14	-4.82	Peak	Horizontal
2	2512.000	-54.89	-53.30	-13.00	-41.89	-1.59	Peak	Horizontal

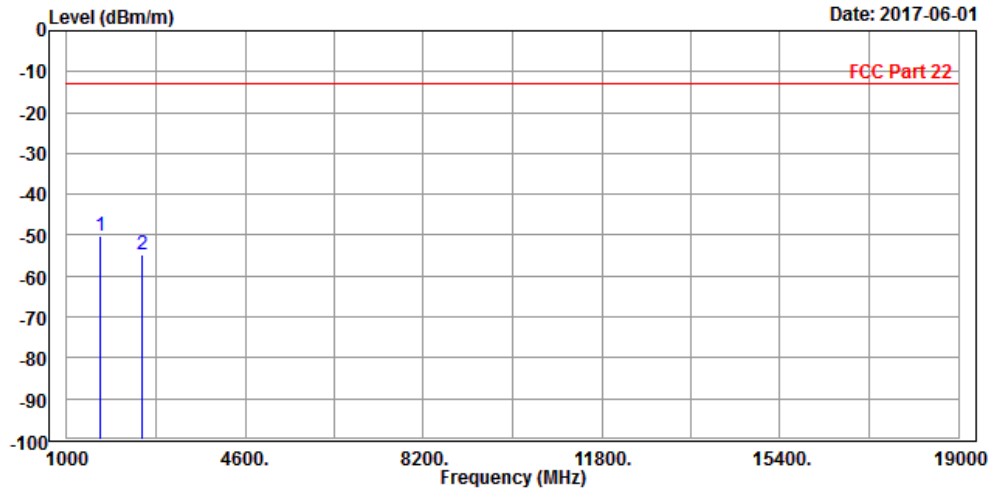



Test Report No.: RF180521W014-1

<b>MODE</b>	TX channel 20525	<b>FREQUENCY RANGE</b>	Above 1000MHz
<b>ENVIRONMENTAL CONDITIONS</b>	26deg. C, 56%RH	<b>INPUT POWER</b>	DC 3.8V
<b>TESTED BY</b>	Star Le		
<b>ANTENNA POLARITY &amp; TEST DISTANCE: VERTICAL AT 3 M</b>			

	Freq	Level	Read Level	Limit Line	Over Limit	Factor	Remark	Pol/Phase
	MHz	dBm/m	dBm	dBm/m	dB	dB/m		
1	1666.000	-49.00	-45.62	-13.00	-36.00	-3.38	Peak	Vertical
2	PP 2512.000	-48.26	-48.14	-13.00	-35.26	-0.12	Peak	Vertical

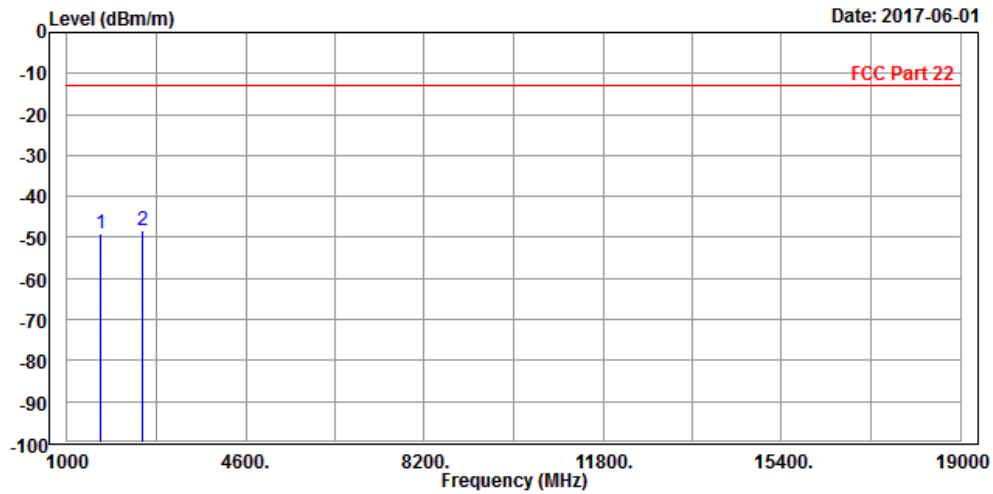



BUREAU VERITAS

Test Report No.: RF180521W014-1

CHANNEL BANDWIDTH: 5MHz / QPSK

CH 20425

MODE	TX channel 20425	FREQUENCY RANGE	Above 1000MHz
ENVIRONMENTAL CONDITIONS	23deg. C, 70%RH	INPUT POWER	DC 3.8V
TESTED BY	Star Le		
<b>ANTENNA POLARITY &amp; TEST DISTANCE: HORIZONTAL AT 3 M</b>			

	Freq	Level	Read Level	Limit Line	Over Limit	Factor	Remark	Pol/Phase
	MHz	dBm/m	dBm	dBm/m	dB	dB/m		
1	PP 1648.000	-38.45	-33.48	-13.00	-25.45	-4.97	Peak	Horizontal
2	2476.000	-56.58	-54.93	-13.00	-43.58	-1.65	Peak	Horizontal

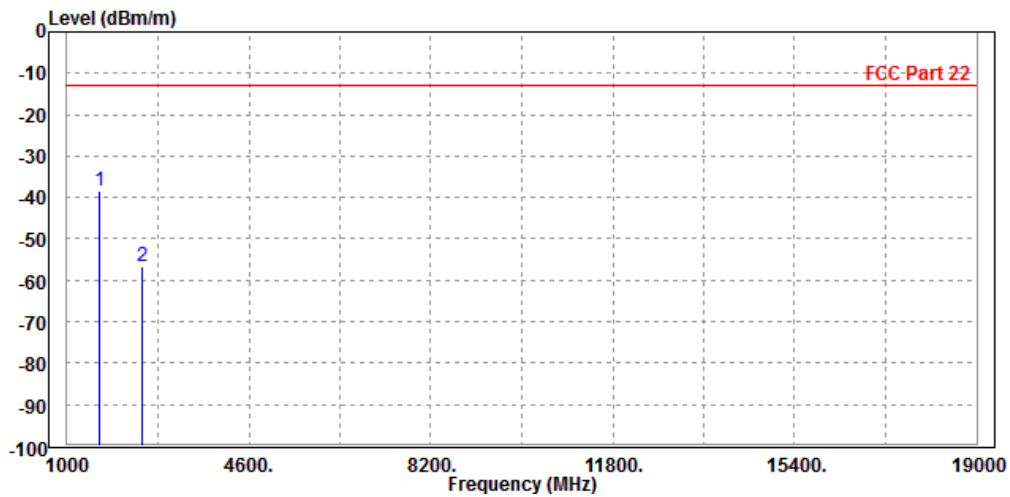





Test Report No.: RF180521W014-1

MODE	TX channel 20425	FREQUENCY RANGE	Above 1000MHz
ENVIRONMENTAL CONDITIONS	23deg. C, 70%RH	INPUT POWER	DC 3.8V
TESTED BY	Star Le		
<b>ANTENNA POLARITY &amp; TEST DISTANCE: VERTICAL AT 3 M</b>			

	Read	Limit	Over			
Freq	Level	Level	Line	Limit	Factor	Remark
MHz	dBm/m	dBm	dBm/m	dB	dB/m	Pol/Phase
1 PP 1648.000	-33.61	-30.06	-13.00	-20.61	-3.55	Peak Vertical
2 2476.000	-51.81	-51.64	-13.00	-38.81	-0.17	Peak Vertical

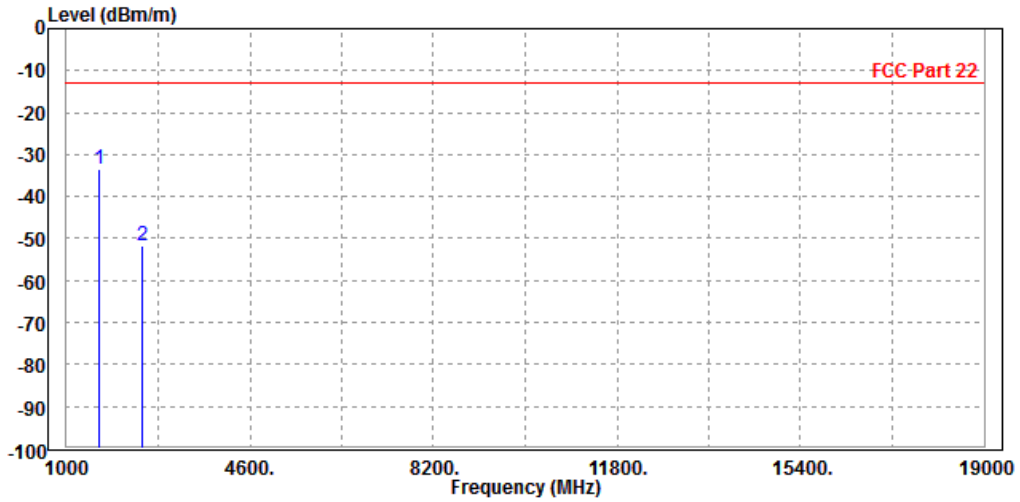



Test Report No.: RF180521W014-1

CH 20525

<b>MODE</b>	TX channel 20525	<b>FREQUENCY RANGE</b>	Above 1000MHz
<b>ENVIRONMENTAL CONDITIONS</b>	23deg. C, 70%RH	<b>INPUT POWER</b>	DC 3.8V
<b>TESTED BY</b>	Star Le		
<b>ANTENNA POLARITY &amp; TEST DISTANCE: HORIZONTAL AT 3 M</b>			

	Freq	Read Level	Limit Level	Over Limit	Factor	Remark	Pol/Phase
	MHz	dBm/m	dBm	dBm/m	dB	dB/m	
1	1666.000	-52.63	-47.81	-13.00	-39.63	-4.82 Peak	Horizontal
2 PP	2512.000	-52.62	-51.03	-13.00	-39.62	-1.59 Peak	Horizontal

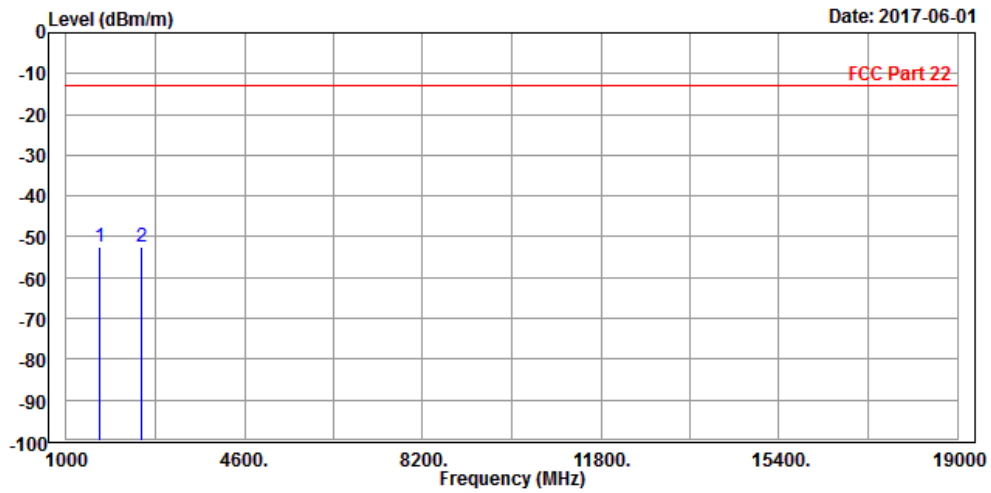



Test Report No.: RF180521W014-1

<b>MODE</b>	TX channel 20525	<b>FREQUENCY RANGE</b>	Above 1000MHz
<b>ENVIRONMENTAL CONDITIONS</b>	23deg. C, 70%RH	<b>INPUT POWER</b>	DC 3.8V
<b>TESTED BY</b>	Star Le		
<b>ANTENNA POLARITY &amp; TEST DISTANCE: VERTICAL AT 3 M</b>			

	Freq	Level	Read Level	Limit Line	Over Limit	Factor	Remark	Pol/Phase
	MHz	dBm/m	dBm	dBm/m	dB	dB/m		
1	1666.000	-48.23	-44.85	-13.00	-35.23	-3.38	Peak	Vertical
2	PP 2512.000	-48.13	-48.01	-13.00	-35.13	-0.12	Peak	Vertical

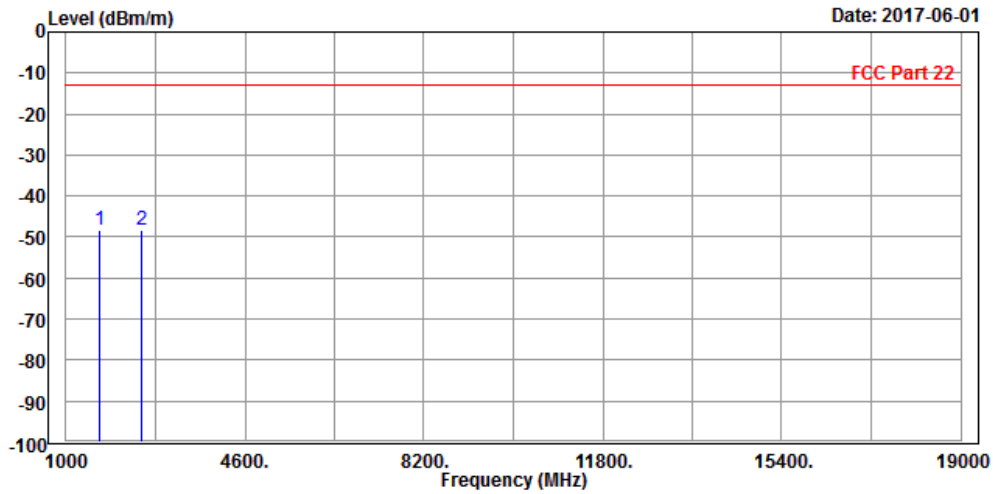



Test Report No.: RF180521W014-1

CH 20625

<b>MODE</b>	TX channel 20625	<b>FREQUENCY RANGE</b>	Above 1000MHz
<b>ENVIRONMENTAL CONDITIONS</b>	23deg. C, 70%RH	<b>INPUT POWER</b>	DC 3.8V
<b>TESTED BY</b>	Star Le		
<b>ANTENNA POLARITY &amp; TEST DISTANCE: HORIZONTAL AT 3 M</b>			

	Read	Limit	Over			
Freq	Level	Level	Line	Limit	Factor	Remark
MHz	dBm/m	dBm	dBm/m	dB	dB/m	Pol/Phase
1 PP 1684.000	-54.24	-49.57	-13.00	-41.24	-4.67	Peak Horizontal
2 2548.000	-55.00	-53.55	-13.00	-42.00	-1.45	Peak Horizontal

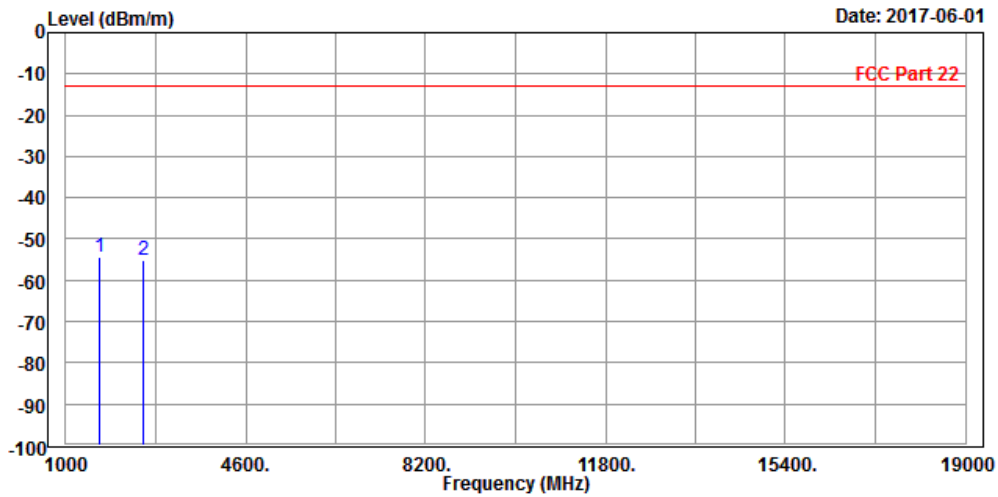



Test Report No.: RF180521W014-1

<b>MODE</b>	TX channel 20625	<b>FREQUENCY RANGE</b>	Above 1000MHz
<b>ENVIRONMENTAL CONDITIONS</b>	23deg. C, 70%RH	<b>INPUT POWER</b>	DC 3.8V
<b>TESTED BY</b>	Star Le		
<b>ANTENNA POLARITY &amp; TEST DISTANCE: VERTICAL AT 3 M</b>			

	Freq	Level	Read Level	Limit Line	Over Limit	Factor	Remark	Pol/Phase
	MHz	dBm/m	dBm	dBm/m	dB	dB/m		
1	PP 1684.000	-51.86	-48.65	-13.00	-38.86	-3.21	Peak	Vertical
2	2548.000	-54.11	-54.14	-13.00	-41.11	0.03	Peak	Vertical

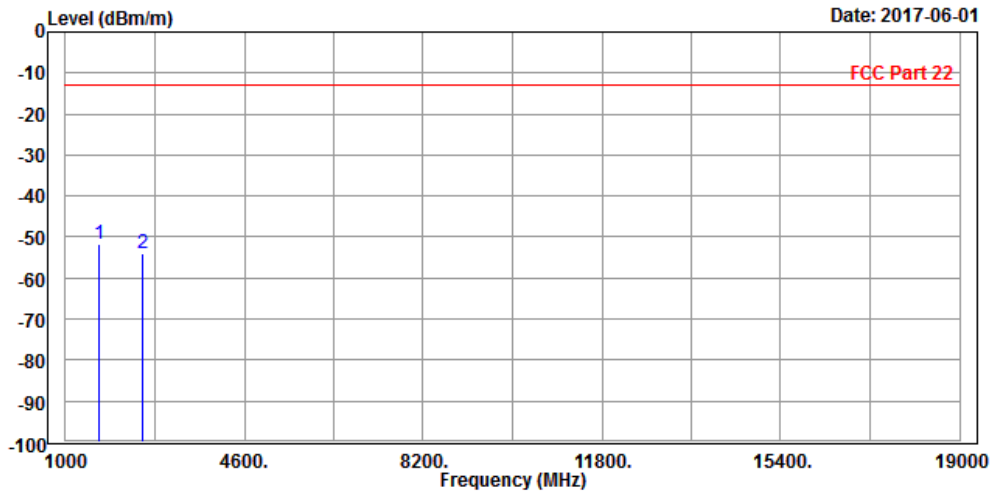



**BUREAU  
VERITAS**

Test Report No.: RF180521W014-1

**CHANNEL BANDWIDTH: 10MHz / QPSK**

<b>MODE</b>	TX channel 20525	<b>FREQUENCY RANGE</b>	Above 1000MHz
<b>ENVIRONMENTAL CONDITIONS</b>	26deg. C, 56%RH	<b>INPUT POWER</b>	DC 3.8V
<b>TESTED BY</b>	Star Le		
<b>ANTENNA POLARITY &amp; TEST DISTANCE: HORIZONTAL AT 3 M</b>			

	Freq	Level	Read Level	Limit Line	Over Limit	Factor	Remark	Pol/Phase
	MHz	dBm/m	dBm	dBm/m	dB	dB/m		
1	PP 1666.000	-50.78	-45.96	-13.00	-37.78	-4.82	Peak	Horizontal
2	2512.000	-55.39	-53.80	-13.00	-42.39	-1.59	Peak	Horizontal

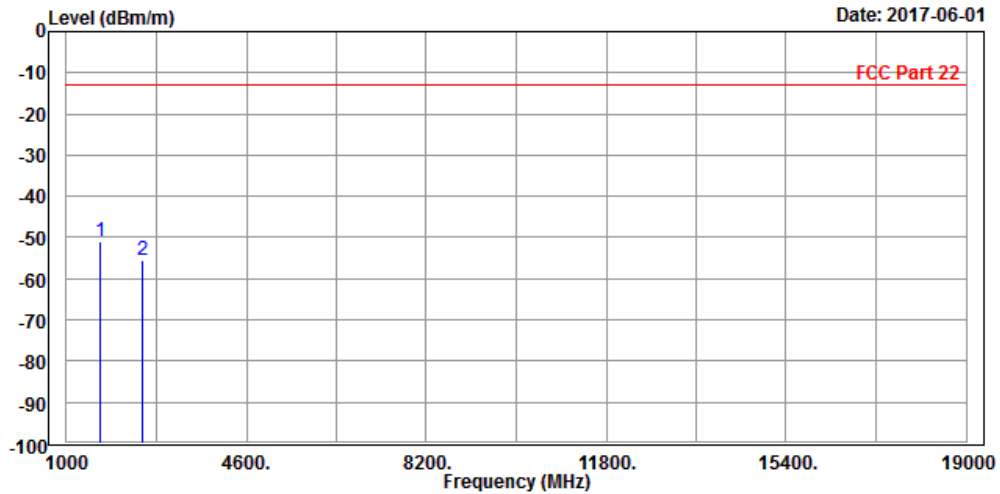



Test Report No.: RF180521W014-1

<b>MODE</b>	TX channel 20525	<b>FREQUENCY RANGE</b>	Above 1000MHz
<b>ENVIRONMENTAL CONDITIONS</b>	26deg. C, 56%RH	<b>INPUT POWER</b>	DC 3.8V
<b>TESTED BY</b>	Star Le		
<b>ANTENNA POLARITY &amp; TEST DISTANCE: VERTICAL AT 3 M</b>			

	Freq	Level	Read Level	Limit Line	Over Limit	Factor	Remark	Pol/Phase
	MHz	dBm/m	dBm	dBm/m	dB	dB/m		
1	PP 1666.000	-49.02	-45.64	-13.00	-36.02	-3.38	Peak	Vertical
2	2512.000	-53.80	-53.68	-13.00	-40.80	-0.12	Peak	Vertical

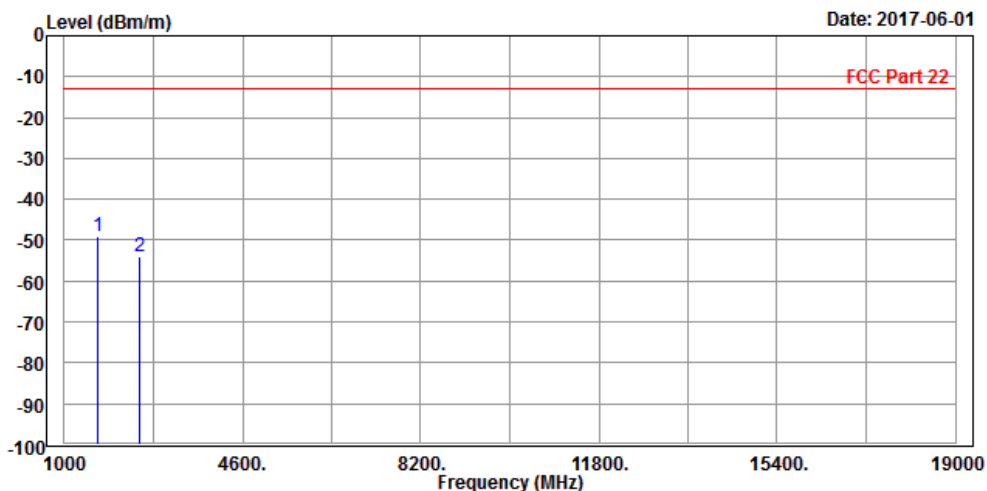

### 3.7 PEAK TO AVERAGE RATIO

#### 3.7.1 LIMITS OF PEAK TO AVERAGE RATIO MEASUREMENT

In measuring transmissions in this band using an average power technique, the peak to-average ratio (PAR) of the transmission may not exceed 13 dB

#### 3.7.2 TEST SETUP

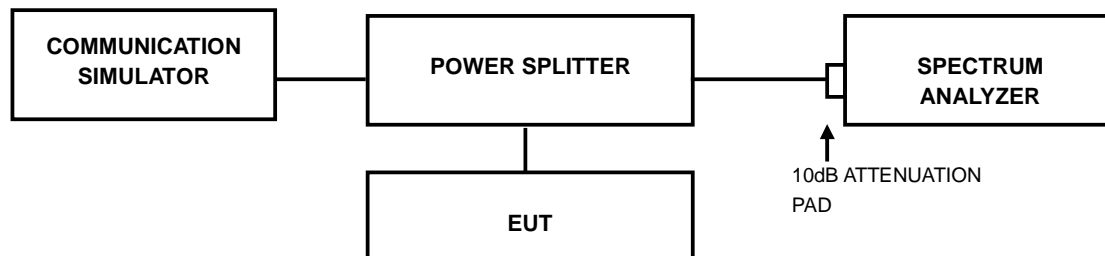

#### 3.7.3 TEST PROCEDURES

1. Set resolution/measurement bandwidth  $\geq$  signal's occupied bandwidth;
2. Set the number of counts to a value that stabilizes the measured CCDF curve;
3. Record the maximum PAPR level associated with a probability of 0.1%.



### 3.7.4 TEST RESULTS

#### GSM

CHANNEL	FREQUENCY (MHz)	PEAK TO AVERAGE RATIO (dB)
128	824.2	2.76

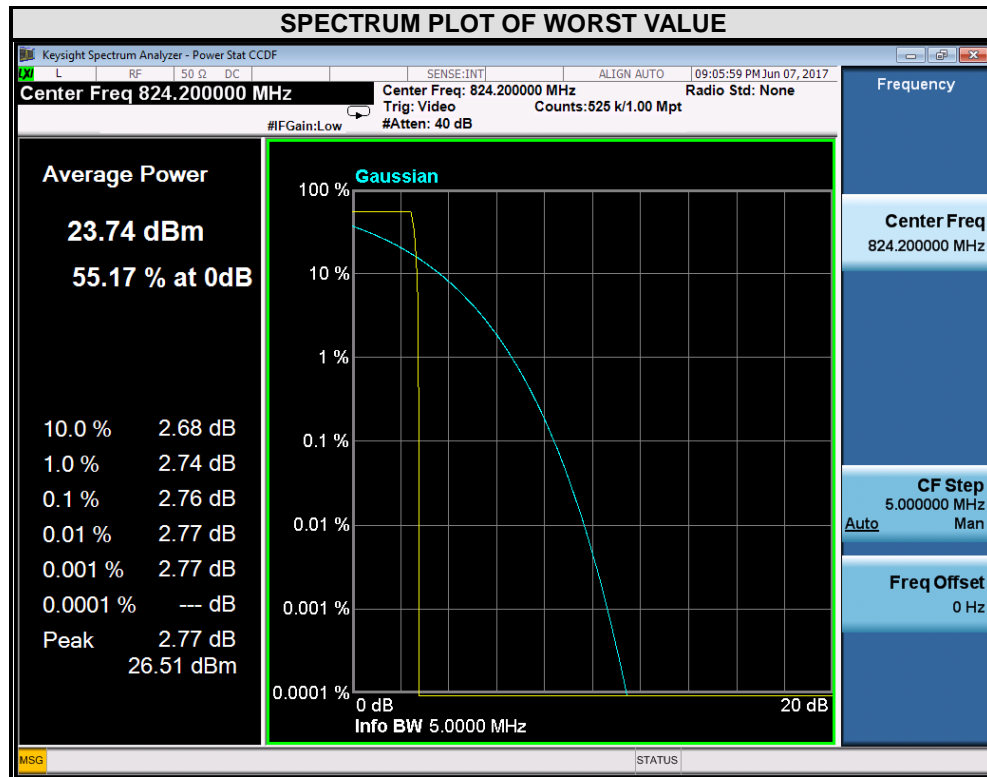



Test Report No.: RF180521W014-1

CHANNEL	FREQUENCY (MHz)	PEAK TO AVERAGE RATIO (dB)
189	836.4	2.72

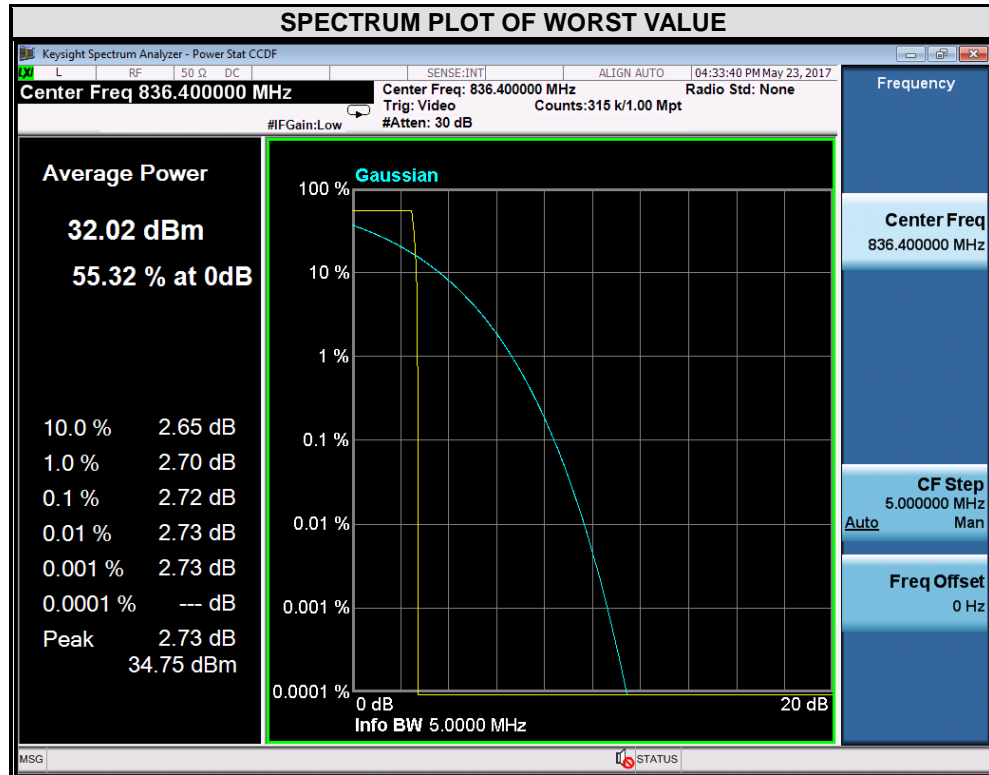



Test Report No.: RF180521W014-1

CHANNEL	FREQUENCY (MHz)	PEAK TO AVERAGE RATIO (dB)
251	848.8	2.73

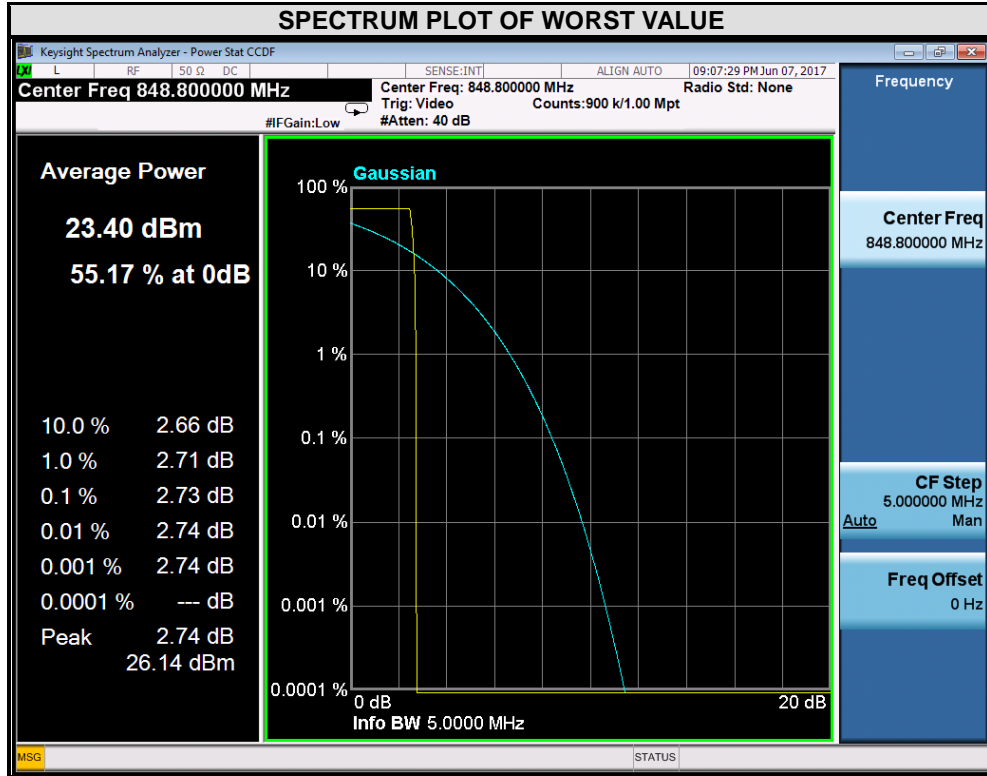



Test Report No.: RF180521W014-1

EDGE

CHANNEL	FREQUENCY (MHz)	PEAK TO AVERAGE RATIO (dB)
128	824.2	5.79

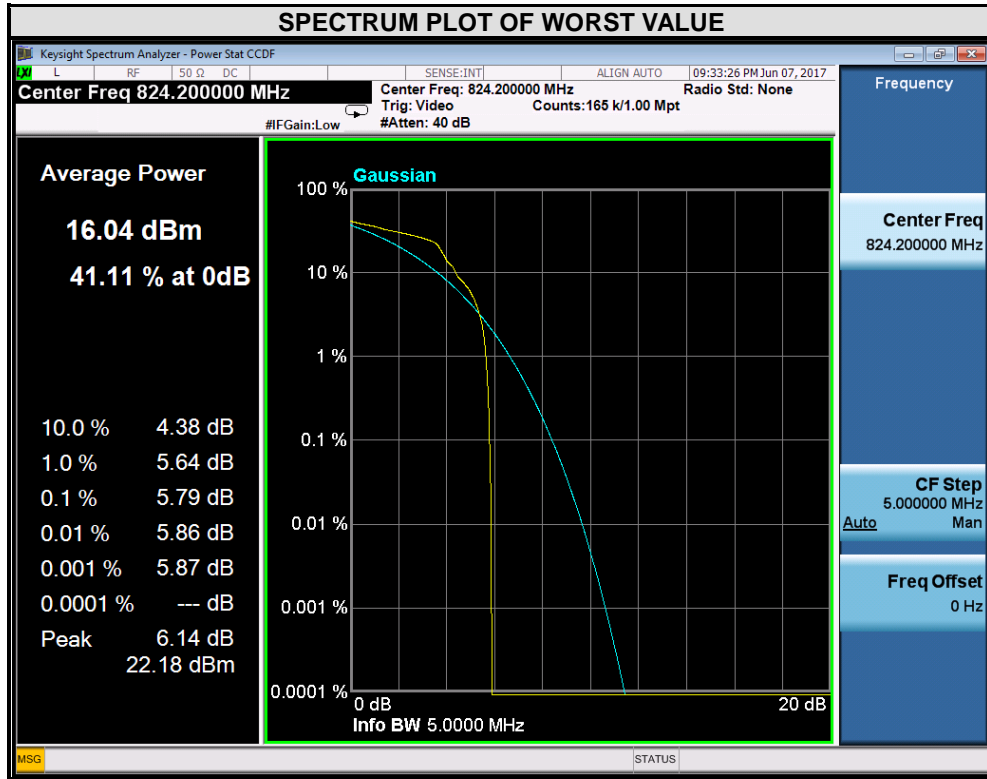



Test Report No.: RF180521W014-1

CHANNEL	FREQUENCY (MHz)	PEAK TO AVERAGE RATIO (dB)
189	836.4	2.87

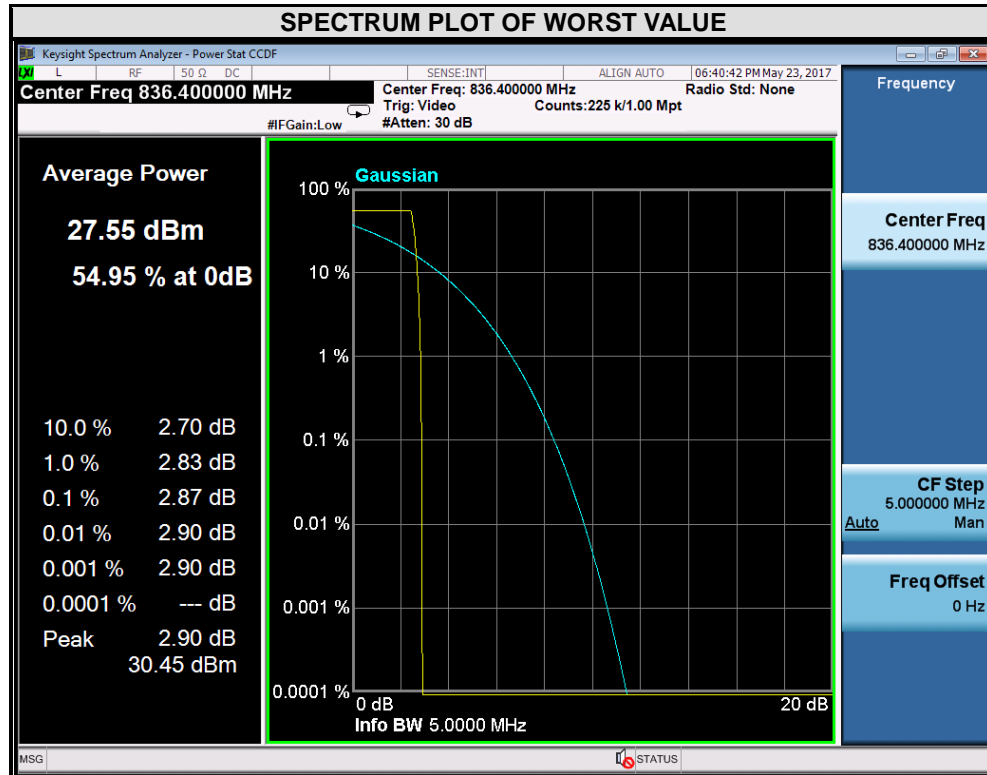



Test Report No.: RF180521W014-1

CHANNEL	FREQUENCY (MHz)	PEAK TO AVERAGE RATIO (dB)
251	848.8	5.77

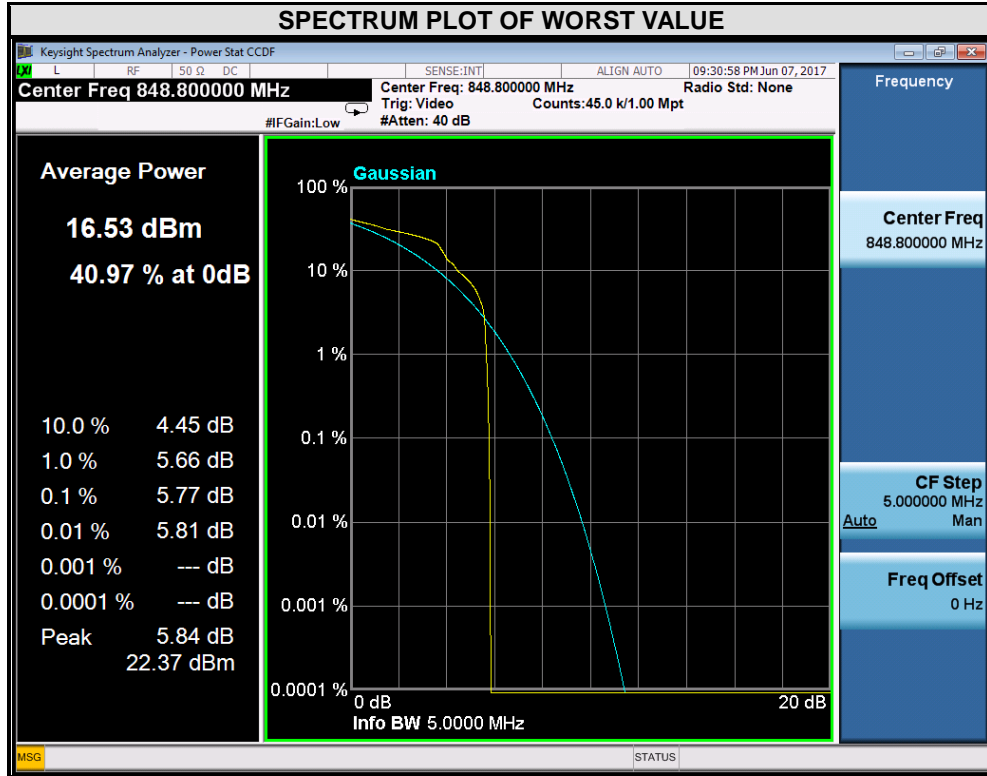



Test Report No.: RF180521W014-1

WCDMA

CHANNEL	FREQUENCY (MHz)	PEAK TO AVERAGE RATIO (dB)
4132	826.4	3.01

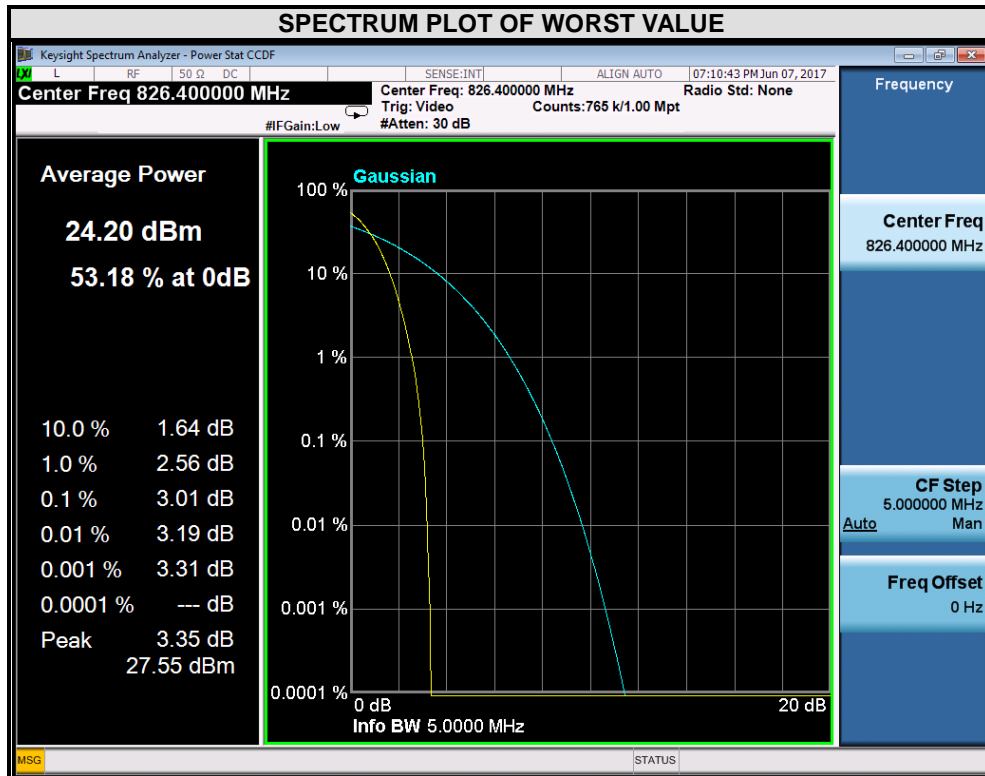



Test Report No.: RF180521W014-1

CHANNEL	FREQUENCY (MHz)	PEAK TO AVERAGE RATIO (dB)
4182	836.4	3.40

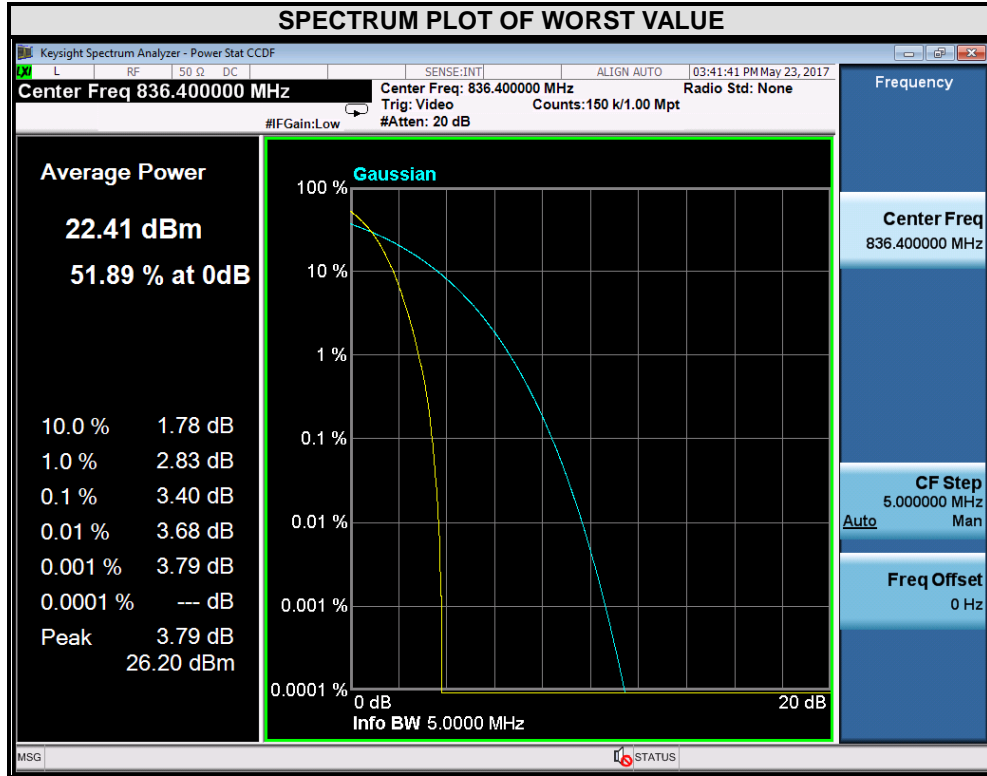





Test Report No.: RF180521W014-1

CHANNEL	FREQUENCY (MHz)	PEAK TO AVERAGE RATIO (dB)
4233	846.6	3.36

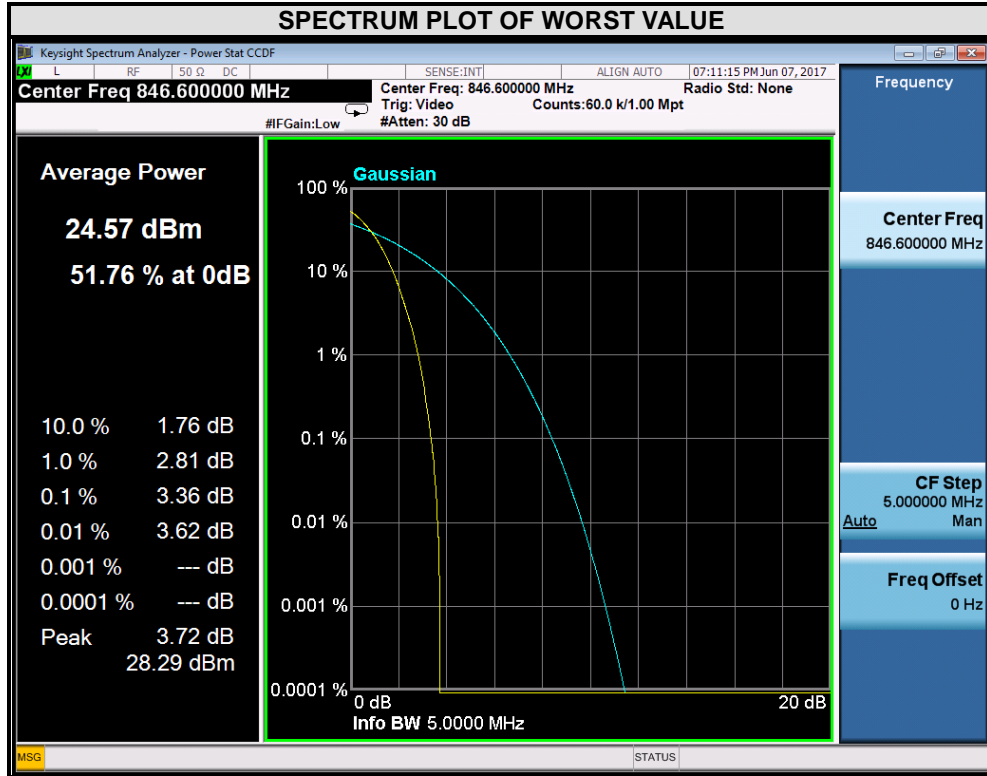

LTE BAND 5

CHANNEL BANDWIDTH: 1.4MHz				CHANNEL BANDWIDTH: 3MHz			
CHANNEL	FREQUENCY (MHz)	PEAK TO AVERAGE RATIO (dB)		CHANNEL	FREQUENCY (MHz)	PEAK TO AVERAGE RATIO (dB)	
		QPSK	16QAM			QPSK	16QAM
20407	824.7	5.33	6.12	20415	825.5	5.26	6.03
20525	836.5	5.97	6.72	20525	836.5	5.90	6.73
20643	848.3	5.92	6.86	20635	847.5	5.88	6.74

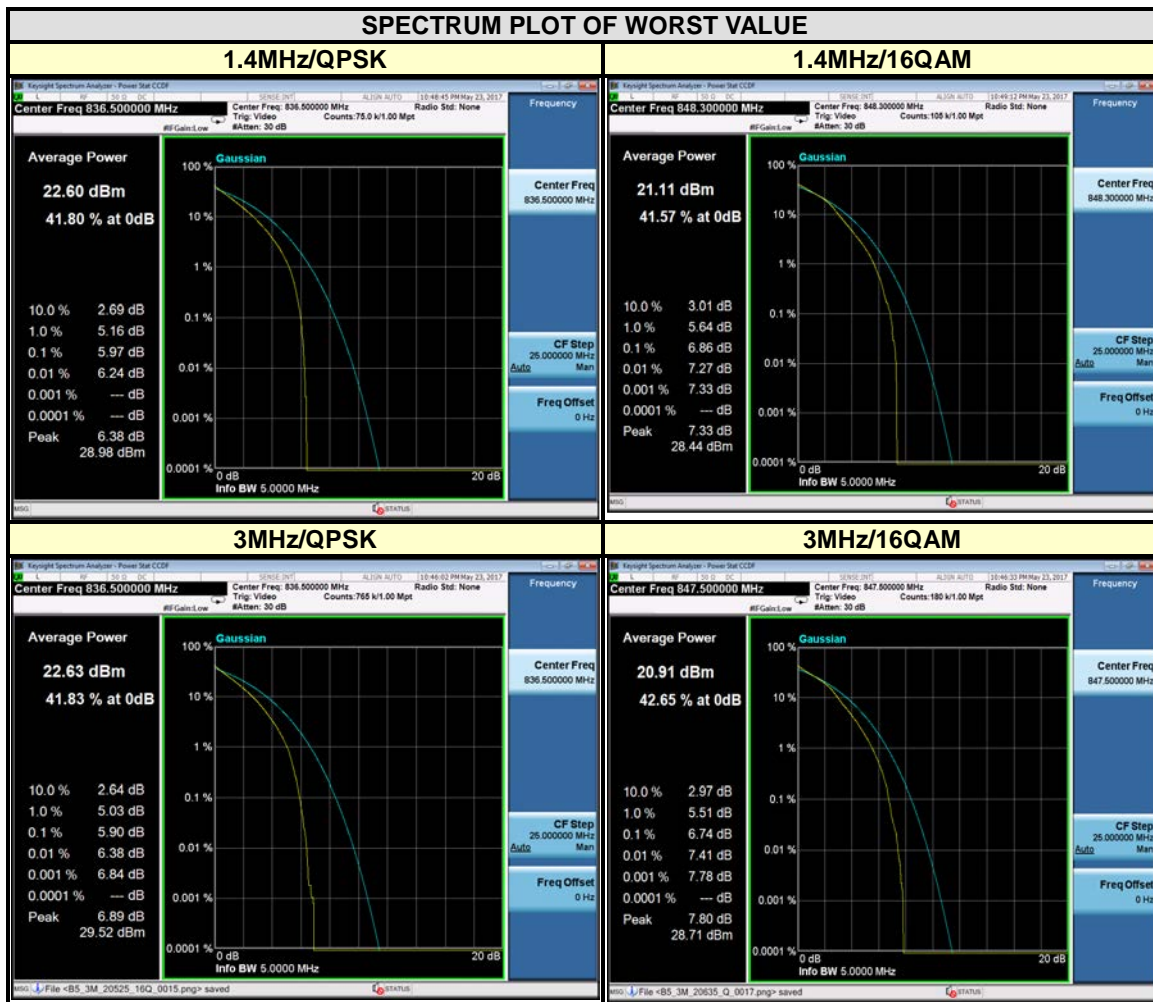

CHANNEL BANDWIDTH: 5MHz				CHANNEL BANDWIDTH: 10MHz			
CHANNEL	FREQUENCY (MHz)	PEAK TO AVERAGE RATIO (dB)		CHANNEL	FREQUENCY (MHz)	PEAK TO AVERAGE RATIO (dB)	
		QPSK	16QAM			QPSK	16QAM
20425	826.5	5.18	5.97	20450	829	5.57	6.29
20525	836.5	5.64	6.53	20525	836.5	5.78	6.70
20625	846.5	5.52	6.33	20600	844	5.50	6.23

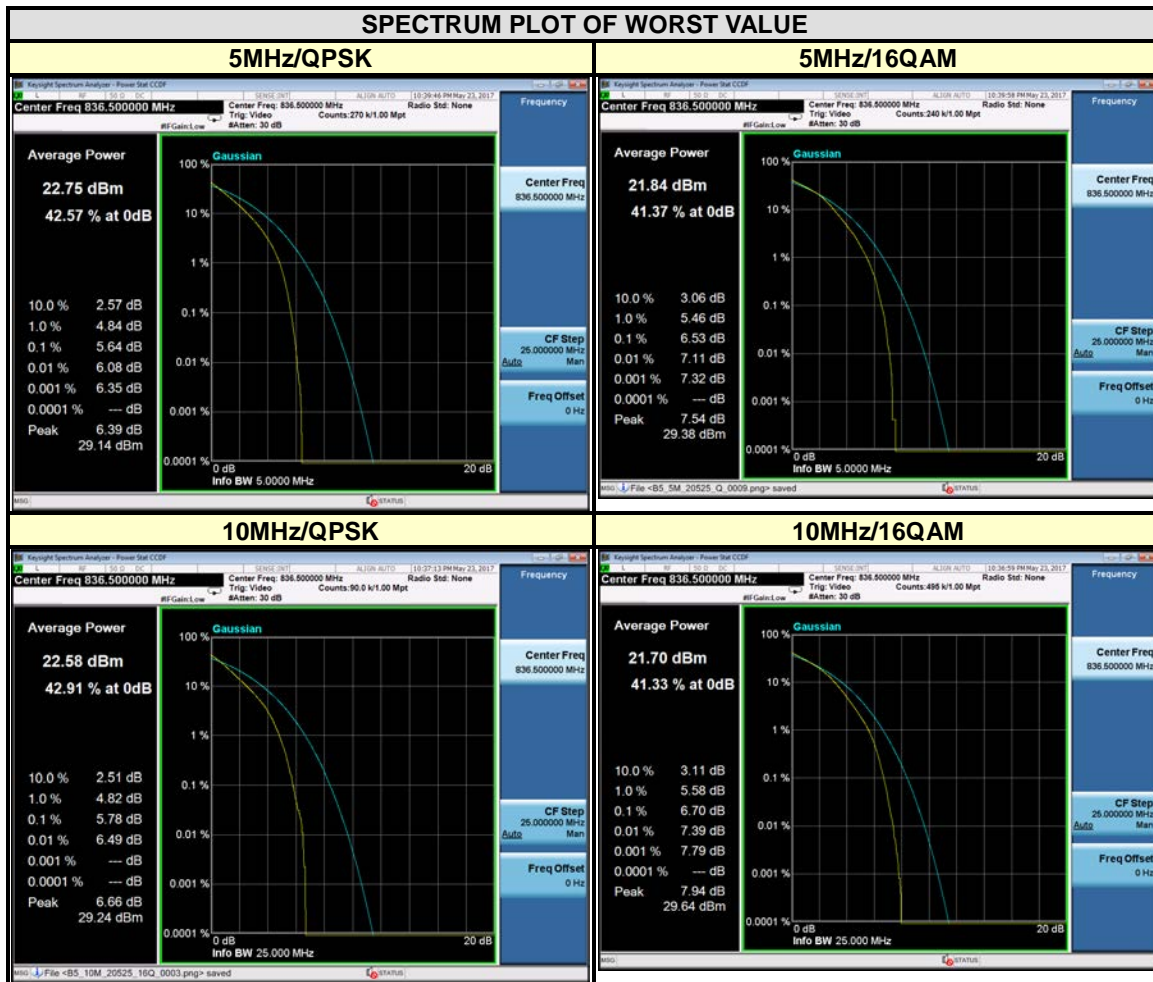



**BUREAU**  
**VERITAS**

Test Report No.: RF180521W014-1

## 4 PHOTOGRAPHS OF THE TEST CONFIGURATION

Please refer to the attached file (Test Setup Photo).



Test Report No.: RF180521W014-1

## 5 INFORMATION ON THE TESTING LABORATORIES

We, BV 7LAYERS COMMUNICATIONS TECHNOLOGY (SHENZHEN) CO. LTD., were founded in 2015 to provide our best service in EMC, Radio, Telecom and Safety consultation. Our laboratories are accredited and approved according to ISO/IEC 17025.

If you have any comments, please feel free to contact us at the following:

**Shenzhen EMC/RF Lab:**

Tel: +86-755-88696566

Fax: +86-755-88696577

**Email:** [customerservice.dg@cn.bureauveritas.com](mailto:customerservice.dg@cn.bureauveritas.com)

**Web Site:** [www.adt.com.tw](http://www.adt.com.tw)

The address and road map of all our labs can be found in our web site also.



Test Report No.: RF180521W014-1

## 6 APPENDIX A – MODIFICATIONS RECORDERS FOR ENGINEERING CHANGES TO THE EUT BY THE LAB

No any modifications are made to the EUT by the lab during the test.

---END---