



FCC RF Test Report

APPLICANT : Gosuncn Technology Group Co., Ltd.
EQUIPMENT : LTE Module
BRAND NAME : GOSUNCN
MODEL NAME : GM500-U1G
FCC ID : 2APNR-GM500U1G1
STANDARD : 47 CFR Part 2, 22(H), 24(E), 27(L), 27(H), 27(F)
CLASSIFICATION : PCS Licensed Transmitter (PCB)
TEST DATE(S) : Aug. 08, 2022 ~ Aug. 23, 2022

We, Sporton International Inc. (Shenzhen), would like to declare that the tested sample has been evaluated in accordance with the procedures given in ANSI C63.26-2015 and shown compliance with the applicable technical standards.

The test results in this report apply exclusively to the tested model / sample. Without written approval of Sporton International Inc. (Shenzhen), the test report shall not be reproduced except in full.

Jason Jia



Approved by: Jason Jia

Sporton International Inc. (ShenZhen)

1/F, 2/F, Bldg 5, Shiling Industrial Zone, Xinwei Village, Xili, Nanshan, Shenzhen, 518055

People's Republic of China



TABLE OF CONTENTS

REVISION HISTORY 3
SUMMARY OF TEST RESULT 4
1 GENERAL DESCRIPTION 5
1.1 Applicant 5
1.2 Manufacturer 5
1.3 Product Feature of Equipment Under Test 5
1.4 Product Specification of Equipment Under Test 5
1.5 Modification of EUT 6
1.6 Maximum EIRP and Emission Designator 6
1.7 Testing Location 7
1.8 Test Software 7
1.9 Applicable Standards 7
2 RE-USE OF MEASURED DATA 8
2.1 Introduction Section 8
2.2 Model Difference Information 8
2.3 Reference detail Section: 8
2.4 Spot Check Verification Data Section 9
3 TEST CONFIGURATION OF EQUIPMENT UNDER TEST 10
3.1 Test Mode 10
3.2 Connection Diagram of Test System 11
3.3 Support Unit used in test configuration and system 11
3.4 Measurement Results Explanation Example 12
3.5 Frequency List of Low/Middle/High Channels 12
4 CONDUCTED TEST ITEMS 14
4.1 Measuring Instruments 14
4.2 Test Setup 14
4.3 Test Result of Conducted Test 14
4.4 Conducted Output Power and EIRP 15
4.5 Peak-to-Average Ratio 16
4.6 Occupied Bandwidth 17
4.7 Conducted Band Edge 18
4.8 Conducted Spurious Emission 19
4.9 Frequency Stability 20
5 RADIATED TEST ITEMS 21
5.1 Measuring Instruments 21
5.2 Test Setup 21
5.3 Test Result of Radiated Test 22
5.4 Radiated Spurious Emission 23
6 LIST OF MEASURING EQUIPMENT 24
7 UNCERTAINTY OF EVALUATION 25
APPENDIX A. TEST RESULTS OF CONDUCTED TEST
APPENDIX B. TEST RESULTS OF RADIATED TEST
APPENDIX C. TEST SETUP PHOTOGRAPHS
APPENDIX D. REFERENCE REPORT



SUMMARY OF TEST RESULT

Report Section	FCC Rule	Description	Limit	Result	Remark
4.4	§2.1046	Conducted Output Power	Reporting Only	PASS	-
	§27.50(d)(4)	Equivalent Isotropic Radiated Power (Band 4) (Band 66)	EIRP < 1Watt	PASS	-
4.5	N/A	Peak-to-Average Ratio	<13 dB	PASS	-
4.6	§2.1049	Occupied Bandwidth	Reporting Only	PASS	-
4.7	§2.1051 §27.53(h)	Conducted Band Edge Measurement (Band 66)	< 43+10log ₁₀ (P[Watts])	PASS	-
4.8	§2.1051 §27.53(h)	Conducted Spurious Emission (Band 66)	< 43+10log ₁₀ (P[Watts])	PASS	-
4.9	§2.1055 §27.54	Frequency Stability Temperature & Voltage	Within Authorized Band	PASS	-
5.4	§2.1053 §27.53(h)	Radiated Spurious Emission (Band 66)	< 43+10log ₁₀ (P[Watts])	PASS	Under limit 26.10 dB at 3472.000 MHz

Declaration of Conformity:

The test results with all measurement uncertainty excluded are presented in accordance with the regulation limits or requirements declared by manufacturers.

Comments and Explanations:

The declared of product specification for EUT presented in the report are provided by the manufacturer, and the manufacturer takes all the responsibilities for the accuracy of product specification.



1 General Description

1.1 Applicant

Gosuncn Technology Group Co., Ltd.

6F, 2819 KaiChuang Blvd., Science Town, Huangpu District, Guangzhou City, Guangdong, China.

1.2 Manufacturer

Gosuncn Technology Group Co., Ltd.

6F, 2819 KaiChuang Blvd., Science Town, Huangpu District, Guangzhou City, Guangdong, China.

1.3 Product Feature of Equipment Under Test

Product Feature	
Equipment	LTE Module
Brand Name	GOSUNCN
Model Name	GM500-U1G
FCC ID	2APNR-GM500U1G1
IMEI Code	Conducted: 863175050001037 Radiation: 863175050000963
HW Version	GM500-U1G.H01
SW Version	GM500U1GV1.0B01
EUT Stage	Identical Prototype

1.4 Product Specification of Equipment Under Test

Standards-related Product Specification	
Tx Frequency	LTE Band 2 : 1850 MHz ~ 1910 MHz LTE Band 4 : 1710 MHz ~ 1755 MHz LTE Band 5 : 824 MHz ~ 849 MHz LTE Band 12 : 699 MHz ~ 716 MHz LTE Band 13 : 777 MHz ~ 787 MHz LTE Band 25 : 1850 MHz ~ 1915 MHz LTE Band 26 : 824 MHz ~ 849 MHz LTE Band 66 : 1710 MHz ~ 1780 MHz
Rx Frequency	LTE Band 2 : 1930 MHz ~ 1990 MHz LTE Band 4 : 2110 MHz ~ 2155 MHz LTE Band 5 : 869 MHz ~ 894 MHz LTE Band 12 : 729 MHz ~ 746 MHz LTE Band 13 : 746 MHz ~ 756 MHz LTE Band 25 : 1930 MHz ~ 1995 MHz LTE Band 26 : 869 MHz ~ 894 MHz LTE Band 66 : 2110 MHz~ 2180 MHz
Bandwidth	LTE Band 66 : 1.4MHz / 3MHz / 5MHz / 10MHz / 15MHz / 20MHz
Maximum Output Power to Antenna	LTE Band 4 : 23.27 dBm LTE Band 66 : 23.39 dBm



Antenna Gain	LTE Band 4 : 2.0 dBi LTE Band 66 : 2.0 dBi
Type of Modulation	QPSK / 16QAM / 64QAM(Downlink only)

1.5 Modification of EUT

No modifications are made to the EUT during all test items.

1.6 Maximum EIRP and Emission Designator

LTE Band 4		QPSK		16QAM	
BW (MHz)	Frequency Range (MHz)	Maximum EIRP(W)		Maximum EIRP(W)	
1.4	1710.7 ~ 1754.3	0.3126		0.2523	
3	1711.5 ~ 1753.5	0.3192		0.2427	
5	1712.5 ~ 1752.5	0.3141		0.2742	
10	1715.0 ~ 1750.0	0.3155		0.2559	
15	1717.5 ~ 1747.5	0.3243		0.2466	
20	1720.0 ~ 1745.0	0.3365		0.2582	
LTE Band 66		QPSK		16QAM	
BW (MHz)	Frequency Range (MHz)	Maximum EIRP(W)	Emission Designator (99%OBW)	Maximum EIRP(W)	Emission Designator (99%OBW)
1.4	1710.7 ~ 1779.3	0.3388	1M10G7D	0.2748	1M10W7D
3	1711.5 ~ 1778.5	0.3443	2M73G7D	0.2825	2M72W7D
5	1712.5 ~ 1777.5	0.3404	4M51G7D	0.2735	4M52W7D
10	1715.0 ~ 1775.0	0.3428	9M07G7D	0.2999	9M03W7D
15	1717.5 ~ 1772.5	0.3428	13M5G7D	0.2965	13M5W7D
20	1720.0 ~ 1770.0	0.3459	17M9G7D	0.2723	17M9W7D



1.7 Testing Location

Sporton International Inc. (Shenzhen) is accredited to ISO/IEC 17025:2017 by American Association for Laboratory Accreditation with Certificate Number 5145.01.

Test Firm	Sporton International Inc. (Shenzhen)		
Test Site Location	1/F, 2/F, Bldg 5, Shiling Industrial Zone, Xinwei Village, Xili, Nanshan, Shenzhen, 518055 People's Republic of China TEL: +86-755-86379589 FAX: +86-755-86379595		
Test Site No.	Sporton Site No.	FCC Designation No.	FCC Test Firm Registration No.
	TH01-SZ	CN1256	421272

Test Firm	Sporton International Inc. (Shenzhen)		
Test Site Location	101, 1st Floor, Block B, Building 1, No. 2, Tengfeng 4th Road, Fenghuang Community, Fuyong Street, Baoan District, Shenzhen City Guangdong Province China 518103 TEL: +86-755-33202398		
Test Site No.	Sporton Site No.	FCC Designation No.	FCC Test Firm Registration No.
	03CH01-SZ	CN1256	421272

1.8 Test Software

Item	Site	Manufacturer	Name	Version
1.	03CH01-SZ	AUDIX	E3	6.2009-8-24

1.9 Applicable Standards

According to the specifications of the manufacturer, the EUT must comply with the requirements of the following standards:

- 47 CFR Part 2, 22(H), 24(E), 27(L), 27(H), 27(F)
- ANSI C63.26-2015
- FCC KDB 971168 D01 Power Meas License Digital Systems v03r01
- FCC KDB 412172 D01 Determining ERP and EIRP v01r01

Remark:

1. All test items were verified and recorded according to the standards and without any deviation during the test.
2. This EUT has also been tested and complied with the requirements of FCC Part 15, Subpart B, recorded in a separate test report.



2 Re-use of Measured Data

2.1 Introduction Section

This application re-uses data collected on a similar device. The subject device of this application (Model: GM500-U1G, FCC ID: 2APNR-GM500U1G1) is electrically identical to the reference device (Model: GM500-U1G_A, FCC ID: 2APNR-GM500U1G) for the portions of the circuitry corresponding to the data being re-used. Based on their similarity, the FCC Part 22(H), 24(E), 27(L), 27(H), 27(F) for LTE Band 2/4/5/12/13/25/26 (equipment class: PCB) reuse the original model's result and do spot-check, following the FCC KDB 484596 D01 v01.

The applicant takes full responsibility that the test data as referenced in this report represent compliance for this FCC ID: 2APNR-GM500U1G1

2.2 Model Difference Information

The main difference between FCC ID: 2APNR-GM500U1G and FCC ID: 2APNR-GM500U1G1 is as below:

- Add WCDMA band IV and LTE band 66 .

The details of above information can be found in the confidential documents (GM500-U1G_Operational Description of Product Equality Declaration).

2.3 Reference detail Section:

Rule Part	Equipment Class	Frequency Band	Reference FCC ID (Parent)	Reference Title	Report Title/Section
22,24,27	PCB	Band 2/4/5/12/13/25/26	2APNR-GM500U1G	FG0D0333B	All sections applicable except for conducted power/EIRP of LTE band 4



2.4 Spot Check Verification Data Section

Conducted power and radiated spurious emission test against the variant model based on the worst-case condition from the original model was performed in this filing to demonstrate the test data from original model remains representative for the variant model

Summary for power and RSE spot check for each rule entry and technology is listed as below:

Test Item	Mode	2APNR-GM500U1G (Parent) Worst Result	2APNR-GM500U1G1 (Variant) Check Result	Difference (dB)
Conducted Power (dBm)	LTE Band 2	23.28	23.26	0.02
	LTE Band 4	23.35	23.27	0.08
	LTE Band 5	22.94	22.93	0.01
	LTE Band 12	23.16	23.14	0.02
	LTE Band 13	22.94	21.23	1.71
	LTE Band 25	23.33	23.30	0.03
	LTE Band 26	22.99	22.97	0.02
Radiated Spurious Emission(dBm)	LTE Band 13	-14.16	-2.21	11.95

Conclusion:

Radiated spurious emission test against the variant model based on the worst-case condition from the original model was performed in this filing to demonstrate the test data from original model remains representative for the variant model.

Based on the spot check test result, the test data from the original model is representative for the variant model. The power level and RSE spot check are shown within expected level compliant to limit line.

We are using power and ERP/EIRP measurements from the original parent model reports to list on the grant.

We confirm that the test data reuse policy of FCC KDB 484596 D01 Referencing Test Data v01 has been followed and the test data as referenced from the parent model report represents compliance with new FCC ID.



3 Test Configuration of Equipment Under Test

3.1 Test Mode

Antenna port conducted and radiated test items listed below are performed according to KDB 971168 D01 Power Meas License Digital Systems v03r01 with maximum output power.

Radiated measurements are performed by rotating the EUT in three different orthogonal test planes to find the maximum emission. (Y-Plane)

Test Items	Band	Bandwidth (MHz)						Modulation			RB #			Test Channel		
		1.4	3	5	10	15	20	QPSK	16QAM	64QAM	1	Half	Full	L	M	H
Max. Output Power	4	v	v	v	v	v	v	v	v	-	v	v	v	v	v	v
	66	v	v	v	v	v	v	v	v	-	v	v	v	v	v	v
Peak-to-Average Ratio	66						v	v	v	-	v		v	v	v	v
26dB and 99% Bandwidth	66	v	v	v	v	v	v	v	v	-			v	v	v	v
Conducted Band Edge	66	v	v	v	v	v	v	v	v	-	v		v	v		v
Conducted Spurious Emission	66	v	v	v	v	v	v	v	v	-	v			v	v	v
Frequency Stability	66				v			v		-			v		v	
E.R.P / E.I.R.P	4	v	v	v	v	v	v	v	v	-	v			v	v	v
	66	v	v	v	v	v	v	v	v	-	v			v	v	v
Radiated Spurious Emission	66	Worst Case												v		
Note	<ol style="list-style-type: none"> The mark "v" means that this configuration is chosen for testing The mark "-" means that this bandwidth is not supported. The device is investigated from 30MHz to 10 times of fundamental signal for radiated spurious emission test under different RB size/offset and modulations in exploratory test. Subsequently, only the worst case emissions are reported. 															

3.2 Connection Diagram of Test System

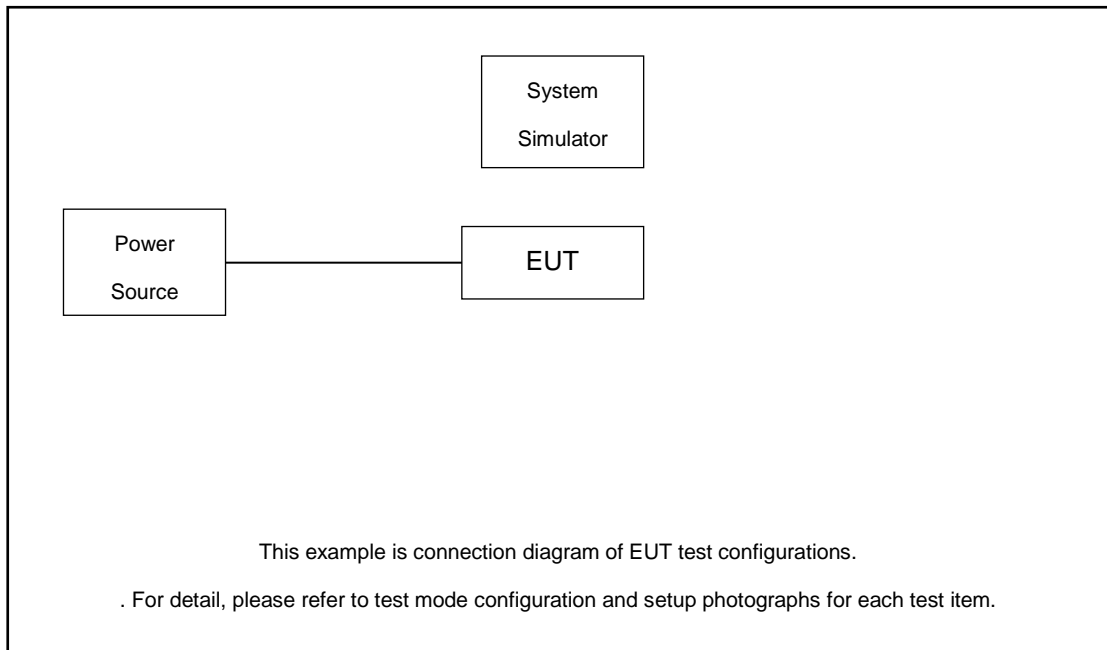

3.3 Support Unit used in test configuration and system

Item	Equipment	Trade Name	Model No.	FCC ID	Data Cable	Power Cord
1.	Power Supply	GWINSTEK	PSS-2002	N/A	N/A	Unshielded, 1.8 m
2.	LTE Base Station	Anritsu	MT8820C	N/A	N/A	Unshielded, 1.8 m
3.	WWAN Antenna	N/A	N/A	N/A	N/A	N/A
4.	Adapter	N/A	N/A	N/A	N/A	N/A
5.	Test Jig	N/A	N/A	N/A	N/A	N/A



3.4 Measurement Results Explanation Example

For all conducted test items:

The offset level is set in the spectrum analyzer to compensate the RF cable loss and attenuator factor between EUT conducted output port and spectrum analyzer. With the offset compensation, the spectrum analyzer reading level is exactly the EUT RF output level.

The spectrum analyzer offset is derived from RF cable loss and attenuator factor.

$$\text{Offset} = \text{RF cable loss} + \text{attenuator factor}.$$

Following shows an offset computation example with cable loss 4.5 dB and 10dB attenuator.

Example :

$$\begin{aligned} \text{Offset(dB)} &= \text{RF cable loss(dB)} + \text{attenuator factor(dB)}. \\ &= 4.5 + 10 = 14.5 \text{ (dB)} \end{aligned}$$

3.5 Frequency List of Low/Middle/High Channels

LTE Band 4 Channel and Frequency List				
BW [MHz]	Channel/Frequency(MHz)	Lowest	Middle	Highest
20	Channel	20050	20175	20300
	Frequency	1720	1732.5	1745
15	Channel	20025	20175	20325
	Frequency	1717.5	1732.5	1747.5
10	Channel	20000	20175	20350
	Frequency	1715	1732.5	1750
5	Channel	19975	20175	20375
	Frequency	1712.5	1732.5	1752.5
3	Channel	19965	20175	20385
	Frequency	1711.5	1732.5	1753.5
1.4	Channel	19957	20175	20393
	Frequency	1710.7	1732.5	1754.3



LTE Band 66 Channel and Frequency List				
BW [MHz]	Channel/Frequency(MHz)	Lowest	Middle	Highest
20	Channel	132072	132322	132572
	Frequency	1720	1745	1770
15	Channel	132047	132322	132597
	Frequency	1717.5	1745	1772.5
10	Channel	132022	132322	132622
	Frequency	1715	1745	1775
5	Channel	131997	132322	132647
	Frequency	1712.5	1745	1777.5
3	Channel	131987	132322	132657
	Frequency	1711.5	1745	1778.5
1.4	Channel	131979	132322	132665
	Frequency	1710.7	1745	1779.3

4 Conducted Test Items

4.1 Measuring Instruments

See list of measuring instruments of this test report.

4.2 Test Setup

4.2.1 Conducted Output Power



4.2.2 Peak-to-Average Ratio, Occupied Bandwidth ,Conducted Band-Edge and Conducted Spurious Emission

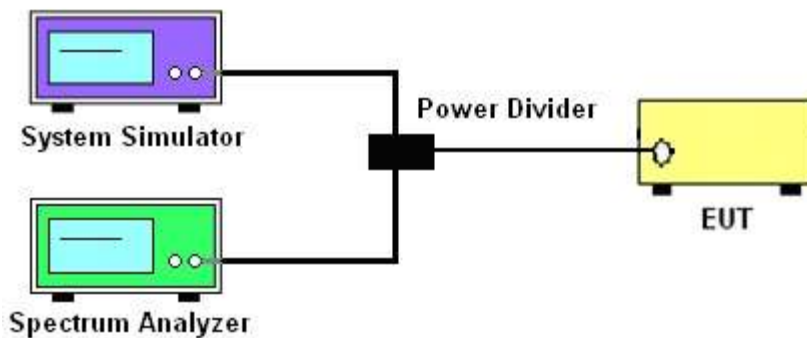

4.2.3 Frequency Stability

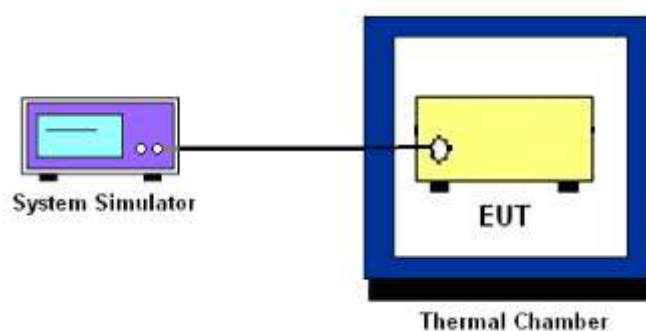

4.3 Test Result of Conducted Test

Please refer to Appendix A.



4.4 Conducted Output Power and EIRP

4.4.1 Description of the Conducted Output Power Measurement and EIRP Measurement

A system simulator was used to establish communication with the EUT. Its parameters were set to force the EUT transmitting at maximum output power. The measured power in the radio frequency on the transmitter output terminals shall be reported.

The EIRP of mobile transmitters must not exceed 1 Watts for LTE Band 4/66.

According to KDB 412172 D01 Power Approach,

$EIRP = P_T + G_T - L_C$, $ERP = EIRP - 2.15$, where

P_T = transmitter output power in dBm

G_T = gain of the transmitting antenna in dBi

L_C = signal attenuation in the connecting cable between the transmitter and antenna in dB

4.4.2 Test Procedures

1. The testing follows ANSI C63.26 Section 5.2
2. The transmitter output port was connected to the system simulator.
3. Set EUT at maximum power through the system simulator.
4. Select lowest, middle, and highest channels for each band and different modulation.
5. Measure and record the power level from the system simulator.



4.5 Peak-to-Average Ratio

4.5.1 Description of the PAR Measurement

Power Complementary Cumulative Distribution Function (CCDF) curves provide a means for characterizing the power peaks of a digitally modulated signal on a statistical basis. A CCDF curve depicts the probability of the peak signal amplitude exceeding the average power level. Most contemporary measurement instrumentation include the capability to produce CCDF curves for an input signal provided that the instrument's resolution bandwidth can be set wide enough to accommodate the entire input signal bandwidth. In measuring transmissions in this band using an average power technique, the peak-to-average ratio (PAR) of the transmission may not exceed 13 dB.

4.5.2 Test Procedures

1. The testing follows ANSI C63.26 Section 5.2.3.4 (CCDF).
2. The EUT was connected to spectrum and system simulator via a power divider.
3. Set the CCDF (Complementary Cumulative Distribution Function) option in spectrum analyzer.
4. The highest RF powers were measured and recorded the maximum PAPR level associated with a probability of 0.1 %.
5. Record the deviation as Peak to Average Ratio.



4.6 Occupied Bandwidth

4.6.1 Description of Occupied Bandwidth Measurement

The occupied bandwidth is the width of a frequency band such that, below the lower and above the upper frequency limits, the mean powers emitted are each equal to a specified percentage 0.5% of the total mean transmitted power.

The 26 dB emission bandwidth is defined as the frequency range between two points, one above and one below the carrier frequency, at which the spectral density of the emission is attenuated 26 dB below the maximum in-band spectral density of the modulated signal. Spectral density (power per unit bandwidth) is to be measured with a detector of resolution bandwidth equal to approximately 1.0% of the emission bandwidth.

4.6.2 Test Procedures

1. The testing follows ANSI C63.26 Section 5.4
2. The EUT was connected to spectrum analyzer and system simulator via a power divider.
3. The spectrum analyzer center frequency is set to the nominal EUT channel center frequency. The span range for the spectrum analyzer shall be between two and five times the anticipated OBW.
4. The nominal resolution bandwidth (RBW) shall be in the range of 1 to 5 % of the anticipated OBW, and the VBW shall be at least 3 times the RBW.
5. Set the detection mode to peak, and the trace mode to max hold.
6. Determine the reference value: Set the EUT to transmit a modulated signal. Allow the trace to stabilize. Set the spectrum analyzer marker to the highest level of the displayed trace.
(this is the reference value)
7. Determine the “-26 dB down amplitude” as equal to (Reference Value – X).
8. Place two markers, one at the lowest and the other at the highest frequency of the envelope of the spectral display such that each marker is at or slightly below the “-X dB down amplitude” determined in step 6. If a marker is below this “-X dB down amplitude” value it shall be placed as close as possible to this value. The OBW is the positive frequency difference between the two markers.
9. Use the 99 % power bandwidth function of the spectrum analyzer and report the measured bandwidth.



4.7 Conducted Band Edge

4.7.1 Description of Conducted Band Edge Measurement

27.53 (h)

For operations in the 1710 – 1755 MHz and 1710 – 1780 MHz band, the FCC limit is $43 + 10\log_{10}(P[\text{Watts}])$ dB below the transmitter power $P(\text{Watts})$ in a 1 MHz bandwidth. However, in the 1MHz bands immediately outside and adjacent to the licensee's frequency block, a resolution bandwidth of at least one percent of the emission bandwidth of the fundamental emission of the transmitter may be employed.

4.7.2 Test Procedures

1. The testing follows ANSI C63.26 section 5.7
2. The EUT was connected to spectrum analyzer and system simulator via a power divider.
3. The band edges of low and high channels for the highest RF powers were measured.
4. Set RBW $\geq 1\%$ EBW in the 1MHz band immediately outside and adjacent to the band edge.
5. Beyond the 1 MHz band from the band edge, RBW=1MHz was used or a narrower RBW was used and the measured power was integrated over the full required measurement bandwidth of 1 MHz.
6. Set spectrum analyzer with RMS detector.
7. The RF fundamental frequency should be excluded against the limit line in the operating frequency band.
8. Checked that all the results comply with the emission limit line.

Example:

The limit line is derived from $43 + 10\log(P)\text{dB}$ below the transmitter power $P(\text{Watts})$
 $= P(\text{W}) - [43 + 10\log(P)] (\text{dB})$
 $= [30 + 10\log(P)] (\text{dBm}) - [43 + 10\log(P)] (\text{dB}) = -13\text{dBm}.$

9. When using the integration method, the starting frequency of the integration shall be centered at one-half of the RBW away from the band edge.



4.8 Conducted Spurious Emission

4.8.1 Description of Conducted Spurious Emission Measurement

The power of any emission outside of the authorized operating frequency ranges must be lower than the transmitter power (P) by a factor of at least $43 + 10 \log (P)$ dB.

It is measured by means of a calibrated spectrum analyzer and scanned from 30 MHz up to a frequency including its 10th harmonic.

4.8.2 Test Procedures

1. The testing follows ANSI C63.26 section 5.7
2. The EUT was connected to spectrum analyzer and system simulator via a power divider.
3. The RF output of EUT was connected to the spectrum analyzer by RF cable and attenuator. The path loss was compensated to the results for each measurement.
4. The middle channel for the highest RF power within the transmitting frequency was measured.
5. The conducted spurious emission for the whole frequency range was taken.
6. Make the measurement with the spectrum analyzer's RBW = 1MHz, VBW = 3MHz.
7. Set spectrum analyzer with RMS detector.
8. Taking the record of maximum spurious emission.
9. The RF fundamental frequency should be excluded against the limit line in the operating frequency band.
10. The limit line is derived from $43 + 10\log(P)$ dB below the transmitter power P(Watts)
= P(W)- [43 + 10log(P)] (dB)
= [30 + 10log(P)] (dBm) - [43 + 10log(P)] (dB)
= -13dBm.



4.9 Frequency Stability

4.9.1 Description of Frequency Stability Measurement

The frequency stability shall be measured by variation of ambient temperature and variation of primary supply voltage to ensure that the fundamental emission stays within the authorized frequency block.

4.9.2 Test Procedures for Temperature Variation

1. The testing follows ANSI C63.26 section 5.6.4
2. The EUT was set up in the thermal chamber and connected with the system simulator.
3. With power OFF, the temperature was decreased to -30°C and the EUT was stabilized before testing. Power was applied and the maximum change in frequency was recorded within one minute.
4. With power OFF, the temperature was raised in 10°C step up to 50°C. The EUT was stabilized at each step for at least half an hour. Power was applied and the maximum frequency change was recorded within one minute.

4.9.3 Test Procedures for Voltage Variation

1. The testing follows ANSI C63.26 section 5.6.5
2. The EUT was placed in a temperature chamber at 20±5°C and connected with the system simulator.
3. The power supply voltage to the EUT was varied from 85% to 115% of the nominal value for other than hand carried battery equipment.
4. For hand carried, battery powered equipment, reduce the primary ac or dc supply voltage to the battery operating end point, which shall be specified by the manufacturer.
5. The variation in frequency was measured for the worst case.

5 Radiated Test Items

5.1 Measuring Instruments

See list of measuring instruments of this test report.

5.2 Test Setup

5.2.1 For radiated test below 30MHz

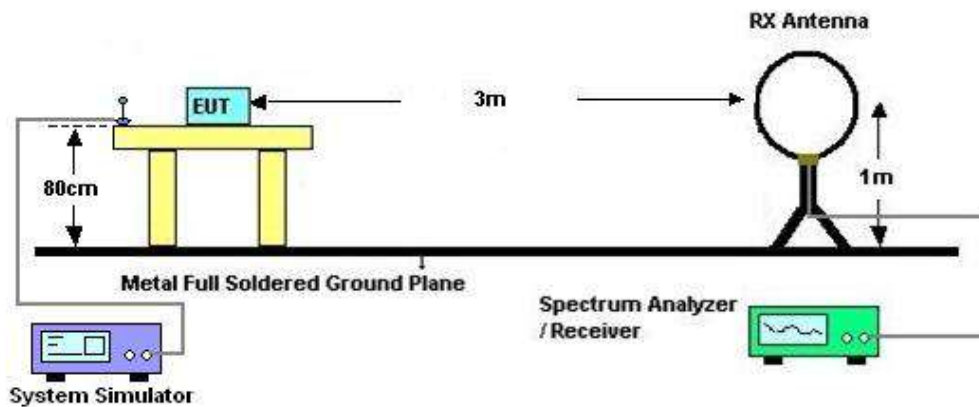

5.2.2 For radiated test from 30MHz to 1GHz

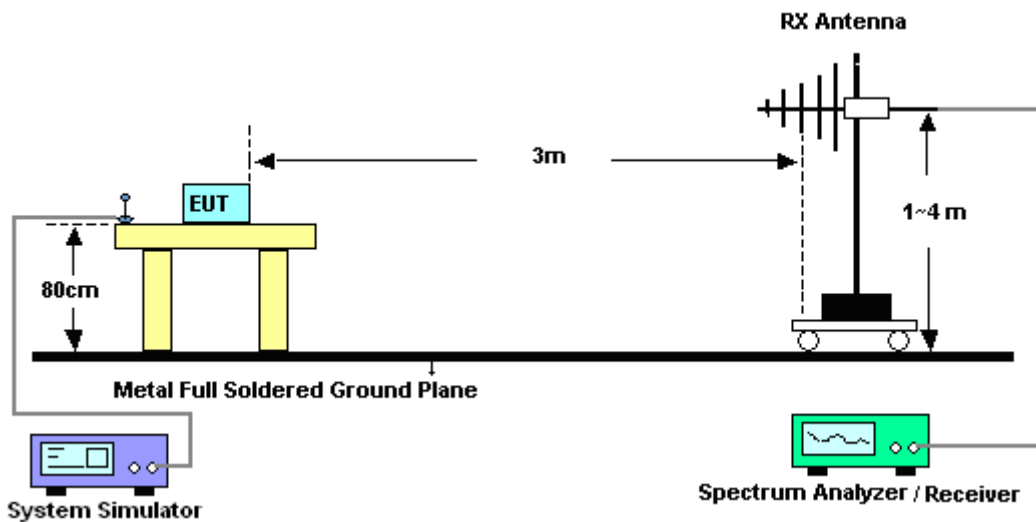

5.2.3 For radiated test above 1GHz

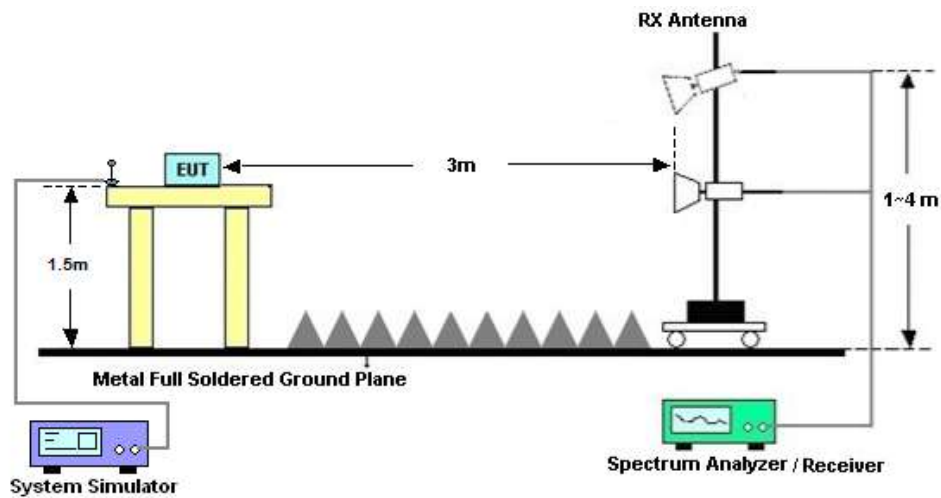

5.3 Test Result of Radiated Test

The low frequency, which started from 9 kHz to 30MHz, was pre-scanned and the result which was 20dB lower than the limit line was not reported.

Please refer to Appendix B.



5.4 Radiated Spurious Emission

5.4.1 Description of Radiated Spurious Emission

The radiated spurious emission was measured by substitution method according to ANSI C63.26. The power of any emission outside of the authorized operating frequency ranges must be attenuated below the transmitter power (P) by a factor of at least $43 + 10 \log (P)$ dB.

The spectrum is scanned from 30 MHz up to a frequency including its 10th harmonic.

5.4.2 Test Procedures

1. The testing follows ANSI C63.26 Section 5.5
2. The EUT was placed on a turntable with 0.8 meter height for frequency below 1GHz and 1.5 meter height for frequency above 1GHz respectively above ground.
3. The EUT was set 3 meters from the receiving antenna mounted on the antenna tower.
4. The table was rotated 360 degrees to determine the position of the highest spurious emission.
5. The height of the receiving antenna is varied between 1m to 4m to search the maximum spurious emission for both horizontal and vertical polarizations.
6. During the measurement, the system simulator parameters were set to force the EUT transmitting at maximum output power.
7. Make the measurement with the spectrum analyzer's RBW = 1MHz, VBW = 3MHz, taking the record of maximum spurious emission.
8. A horn antenna was substituted in place of the EUT and was driven by a signal generator.
9. Tune the output power of signal generator to the same emission level with EUT maximum spurious emission.
10. $EIRP \text{ (dBm)} = S.G. \text{ Power} - Tx \text{ Cable Loss} + Tx \text{ Antenna Gain}$
11. $ERP \text{ (dBm)} = EIRP - 2.15$
12. The RF fundamental frequency should be excluded against the limit line in the operating frequency band.

The limit line is derived from $43 + 10\log(P)$ dB below the transmitter power P(Watts)
= $P(W) - [43 + 10\log(P)] \text{ (dB)}$
= $[30 + 10\log(P)] \text{ (dBm)} - [43 + 10\log(P)] \text{ (dB)}$
= -13dBm.



6 List of Measuring Equipment

Instrument	Manufacturer	Model No.	Serial No.	Characteristics	Calibration Date	Test Date	Due Date	Remark
Spectrum Analyzer	R&S	FSV40	101078	10Hz~40GHz	Apr. 07, 2022	Aug. 08, 2022~ Aug. 23, 2022	Apr. 06, 2023	Conducted (TH01-SZ)
Power Divider	TOJOIN	PS-2SM-04 265	60.06.020.007 7	0.4GHz~26.5GHz	Dec. 25, 2021	Aug. 08, 2022~ Aug. 23, 2022	Dec. 24, 2022	Conducted (TH01-SZ)
Thermal Chamber	Ten Billion Hongzhonggroup	LP-150U	H2014081803	-40~+150°C	Jul. 07, 2022	Aug. 08, 2022~ Aug. 23, 2022	Jul. 06, 2023	Conducted (TH01-SZ)
EMI Test Receiver&SA	Agilent	N9038A	MY52260185	20Hz~26.5GHz	Dec. 27, 2021	Aug. 19, 2022~ Aug. 23, 2022	Dec. 26, 2022	Radiation (03CH01-SZ)
Loop Antenna	R&S	HFH2-Z2	100354	9kHz~30MHz	Jun. 21, 2022	Aug. 19, 2022~ Aug. 23, 2022	Jun. 20, 2023	Radiation (03CH01-SZ)
HF Amplifier	KEYSIGHT	83017A	MY53270105	0.5GHz~26.5Ghz	Oct. 22, 2021	Aug. 19, 2022~ Aug. 23, 2022	Oct. 21, 2022	Radiation (03CH01-SZ)
Bilog Antenna	TeseQ	CBL6112D	35407	30MHz-2GHz	Sep. 28, 2021	Aug. 19, 2022~ Aug. 23, 2022	Sep. 27, 2022	Radiation (03CH01-SZ)
Double Ridge Horn Antenna	SCHWARZBECK	BBHA9120D	9120D-1474	1GHz~18GHz	Jul. 07, 2022	Aug. 19, 2022~ Aug. 23, 2022	Jul. 06, 2023	Radiation (03CH01-SZ)
SHF-EHF Horn	com-power	AH-840	101071	18Ghz-40GHz	Apr. 10, 2022	Aug. 19, 2022~ Aug. 23, 2022	Apr. 09, 2023	Radiation (03CH01-SZ)
LF Amplifier	Burgeon	BPA-530	102209	0.01~3000Mhz	Apr. 06, 2022	Aug. 19, 2022~ Aug. 23, 2022	Apr. 05, 2023	Radiation (03CH01-SZ)
HF Amplifier	MITEQ	AMF-7D-00 101800-30-1 0P-R	1943528	1GHz~18GHz	Oct. 22, 2021	Aug. 19, 2022~ Aug. 23, 2022	Oct. 21, 2022	Radiation (03CH01-SZ)
HF Amplifier	MITEQ	TTA1840-35 -HG	1871923	18GHz~40GHz	Jul. 06, 2022	Aug. 19, 2022~ Aug. 23, 2022	Jul. 05, 2023	Radiation (03CH01-SZ)
AC Power Source	Chroma	61601	616010001985	N/A	NCR	Aug. 19, 2022~ Aug. 23, 2022	NCR	Radiation (03CH01-SZ)
Turn Table	EM	EM1000	N/A	0~360 degree	NCR	Aug. 19, 2022~ Aug. 23, 2022	NCR	Radiation (03CH01-SZ)
Antenna Mast	EM	EM1000	N/A	1 m~4 m	NCR	Aug. 19, 2022~ Aug. 23, 2022	NCR	Radiation (03CH01-SZ)

NCR: No Calibration Required



7 Uncertainty of Evaluation

The measurement uncertainties shown below were calculated in accordance with the requirements of ANSI 63.26-2015. All the measurement uncertainty value were shown with a coverage K=2 to indicate 95% level of confidence. The measurement data show herein meets or exceeds the CISPR measurement uncertainty values specified in CISPR 16-4-2 and can be compared directly to specified limit to determine compliance.

Uncertainty of Conducted Measurement

Test Item	Uncertainty
Conducted Power	1.34 dB
Conducted Emissions	1.34 dB
Occupied Channel Bandwidth	0.012MHz
Conducted Power Spectral Density	1.32 dB
Frequency tolerance	1.30 ppm

Uncertainty of Radiated Emission Measurement (30 MHz ~ 1000 MHz)

Measuring Uncertainty for a Level of Confidence of 95% (U = 2Uc(y))	2.48dB
---	--------

Uncertainty of Radiated Emission Measurement (1000 MHz ~ 18000 MHz)

Measuring Uncertainty for a Level of Confidence of 95% (U = 2Uc(y))	3.53dB
---	--------

Uncertainty of Radiated Emission Measurement (18 GHz ~ 40 GHz)

Measuring Uncertainty for a Level of Confidence of 95% (U = 2Uc(y))	4.02dB
---	--------



Appendix A. Test Results of Conducted Test

Test Engineer :	Chen Hong	Temperature :	24~26°C
		Relative Humidity :	50~53%

Conducted Output Power(Average power)

LTE Band 4						
BW [MHz]	Modulation	RB Size	RB Offset	Power Low Ch. / Freq.	Power Middle Ch. / Freq.	Power High Ch. / Freq.
Channel				20050	20175	20300
Frequency (MHz)				1720	1732.5	1745
20	QPSK	1	0	22.81	22.72	23.27
20	QPSK	1	49	23.09	22.68	23.09
20	QPSK	1	99	22.68	22.48	22.80
20	QPSK	50	0	22.05	21.97	21.99
20	QPSK	50	24	21.95	21.85	22.00
20	QPSK	50	50	22.00	21.93	21.85
20	QPSK	100	0	21.82	21.68	21.92
20	16QAM	1	0	21.69	21.67	22.12
20	16QAM	1	49	21.56	21.86	21.99
20	16QAM	1	99	21.29	21.42	21.81
20	16QAM	50	0	21.02	20.98	20.95
20	16QAM	50	24	20.97	20.76	21.00
20	16QAM	50	50	21.10	20.82	20.85
20	16QAM	100	0	20.95	20.68	20.83
Channel				20025	20175	20325
Frequency (MHz)				1717.5	1732.5	1747.5
15	QPSK	1	0	22.71	22.50	22.93
15	QPSK	1	37	22.97	22.70	23.11
15	QPSK	1	74	22.90	22.43	22.73
15	QPSK	36	0	21.64	21.83	22.00
15	QPSK	36	20	21.76	21.68	21.90
15	QPSK	36	39	21.76	21.70	21.98
15	QPSK	75	0	21.74	21.82	21.88
15	16QAM	1	0	21.61	21.64	21.92
15	16QAM	1	37	21.55	21.12	21.40
15	16QAM	1	74	21.70	21.60	21.21



15	16QAM	36	0	20.79	20.79	20.84
15	16QAM	36	20	20.79	20.83	20.87
15	16QAM	36	39	20.88	20.77	20.93
15	16QAM	75	0	20.79	20.84	20.92
Channel				20000	20175	20350
Frequency (MHz)				1715	1732.5	1750
10	QPSK	1	0	22.52	22.63	22.56
10	QPSK	1	25	22.69	22.57	22.99
10	QPSK	1	49	22.75	22.30	22.74
10	QPSK	25	0	21.57	21.62	21.94
10	QPSK	25	12	21.70	21.62	21.97
10	QPSK	25	25	21.94	21.62	21.87
10	QPSK	50	0	21.74	21.62	21.83
10	16QAM	1	0	21.73	21.39	21.60
10	16QAM	1	25	21.70	21.34	22.08
10	16QAM	1	49	21.43	21.03	21.89
10	16QAM	25	0	20.71	21.03	20.81
10	16QAM	25	12	20.74	20.87	20.97
10	16QAM	25	25	20.91	20.71	20.86
10	16QAM	50	0	20.78	20.80	21.04
Channel				19975	20175	20375
Frequency (MHz)				1712.5	1732.5	1752.5
5	QPSK	1	0	22.39	22.97	22.88
5	QPSK	1	12	22.65	22.50	22.84
5	QPSK	1	24	22.79	22.26	22.69
5	QPSK	12	0	21.57	21.64	21.77
5	QPSK	12	7	21.62	21.60	21.89
5	QPSK	12	13	21.73	21.64	21.90
5	QPSK	25	0	21.70	21.73	21.90
5	16QAM	1	0	21.82	21.85	22.38
5	16QAM	1	12	21.51	21.17	22.00
5	16QAM	1	24	21.42	21.06	21.45
5	16QAM	12	0	20.60	20.75	20.74
5	16QAM	12	7	20.60	20.71	20.78
5	16QAM	12	13	20.42	20.77	21.05
5	16QAM	25	0	20.70	20.86	20.95
Channel				19965	20175	20385
Frequency (MHz)				1711.5	1732.5	1753.5



3	QPSK	1	0	22.42	22.88	22.91
3	QPSK	1	8	22.25	22.37	23.04
3	QPSK	1	14	22.75	22.42	22.80
3	QPSK	8	0	21.51	21.71	21.74
3	QPSK	8	4	21.60	21.75	21.83
3	QPSK	8	7	21.68	21.69	21.84
3	QPSK	15	0	21.54	21.73	21.78
3	16QAM	1	0	21.73	21.75	21.85
3	16QAM	1	8	21.17	21.68	21.49
3	16QAM	1	14	21.78	21.59	21.67
3	16QAM	8	0	20.85	20.51	20.71
3	16QAM	8	4	20.62	20.62	20.82
3	16QAM	8	7	20.75	20.85	20.96
3	16QAM	15	0	20.61	20.93	20.66
Channel				19957	20175	20393
Frequency (MHz)				1710.7	1732.5	1754.3
1.4	QPSK	1	0	22.58	22.74	22.45
1.4	QPSK	1	3	22.74	22.65	22.53
1.4	QPSK	1	5	22.69	22.72	22.69
1.4	QPSK	3	0	22.73	22.78	22.70
1.4	QPSK	3	1	22.72	22.92	22.95
1.4	QPSK	3	3	22.75	22.67	22.75
1.4	QPSK	6	0	21.48	21.74	21.72
1.4	16QAM	1	0	21.28	21.37	22.02
1.4	16QAM	1	3	21.74	21.88	21.91
1.4	16QAM	1	5	21.42	21.18	21.77
1.4	16QAM	3	0	21.71	21.65	21.67
1.4	16QAM	3	1	21.80	21.77	21.61
1.4	16QAM	3	3	21.84	21.55	21.81
1.4	16QAM	6	0	20.51	20.72	20.53



LTE Band 66						
BW [MHz]	Modulation	RB Size	RB Offset	Power Low Ch. / Freq.	Power Middle Ch. / Freq.	Power High Ch. / Freq.
Channel				132072	132322	132572
Frequency (MHz)				1720	1745	1770
20	QPSK	1	0	23.02	23.39	22.98
20	QPSK	1	49	23.29	22.97	23.22
20	QPSK	1	99	23.09	22.56	23.04
20	QPSK	50	0	22.25	22.50	22.37
20	QPSK	50	24	22.35	22.36	22.33
20	QPSK	50	50	22.36	22.25	22.33
20	QPSK	100	0	22.29	22.27	22.27
20	16QAM	1	0	22.14	21.78	22.22
20	16QAM	1	49	22.35	21.85	22.09
20	16QAM	1	99	21.93	22.04	21.99
20	16QAM	50	0	21.10	21.26	21.36
20	16QAM	50	24	21.30	21.12	21.46
20	16QAM	50	50	21.30	21.11	21.36
20	16QAM	100	0	21.25	21.16	21.40
Channel				132047	132322	132597
Frequency (MHz)				1717.5	1745	1772.5
15	QPSK	1	0	23.19	23.31	23.29
15	QPSK	1	37	23.29	23.35	23.30
15	QPSK	1	74	23.35	22.57	23.11
15	QPSK	36	0	22.07	22.34	22.35
15	QPSK	36	20	22.23	22.21	22.37
15	QPSK	36	39	22.23	22.16	22.27
15	QPSK	75	0	22.26	22.32	22.41
15	16QAM	1	0	22.09	21.92	22.00
15	16QAM	1	37	22.72	21.69	22.53
15	16QAM	1	74	21.90	21.77	21.81
15	16QAM	36	0	21.14	21.31	21.39
15	16QAM	36	20	21.31	21.19	21.38
15	16QAM	36	39	21.22	21.14	21.18
15	16QAM	75	0	21.25	21.15	21.23



Channel				132022	132322	132622
Frequency (MHz)				1715	1745	1775
10	QPSK	1	0	22.92	23.35	23.00
10	QPSK	1	25	23.30	23.17	23.27
10	QPSK	1	49	23.30	22.62	22.89
10	QPSK	25	0	22.09	22.37	22.30
10	QPSK	25	12	22.31	22.24	22.25
10	QPSK	25	25	22.29	22.17	22.19
10	QPSK	50	0	22.36	22.32	22.15
10	16QAM	1	0	21.80	22.77	21.99
10	16QAM	1	25	22.01	22.29	21.91
10	16QAM	1	49	22.01	21.89	21.76
10	16QAM	25	0	21.12	21.32	21.52
10	16QAM	25	12	21.18	21.14	21.38
10	16QAM	25	25	21.20	21.17	21.19
10	16QAM	50	0	21.04	21.22	21.07
Channel				131997	132322	132647
Frequency (MHz)				1712.5	1745	1777.5
5	QPSK	1	0	22.91	23.31	23.32
5	QPSK	1	12	23.32	23.27	23.27
5	QPSK	1	24	23.04	22.95	22.94
5	QPSK	12	0	22.13	22.36	22.41
5	QPSK	12	7	22.25	22.33	22.30
5	QPSK	12	13	22.18	22.29	22.36
5	QPSK	25	0	22.25	22.25	22.30
5	16QAM	1	0	22.26	22.37	22.07
5	16QAM	1	12	22.35	22.10	21.98
5	16QAM	1	24	21.86	21.70	22.27
5	16QAM	12	0	21.02	21.26	21.40
5	16QAM	12	7	21.14	21.24	21.17
5	16QAM	12	13	21.07	21.13	21.08
5	16QAM	25	0	21.15	21.28	21.30
Channel				131987	132322	132657
Frequency (MHz)				1711.5	1745	1778.5
3	QPSK	1	0	23.14	23.35	23.37
3	QPSK	1	8	23.18	23.02	23.06



3	QPSK	1	14	23.33	23.15	23.00
3	QPSK	8	0	22.30	22.32	22.36
3	QPSK	8	4	22.29	22.28	22.33
3	QPSK	8	7	22.26	22.31	22.27
3	QPSK	15	0	22.23	22.24	22.31
3	16QAM	1	0	21.82	22.28	22.11
3	16QAM	1	8	22.12	22.09	22.41
3	16QAM	1	14	22.38	22.05	22.51
3	16QAM	8	0	21.25	21.42	21.36
3	16QAM	8	4	21.23	21.26	21.25
3	16QAM	8	7	21.29	21.28	21.42
3	16QAM	15	0	21.29	21.17	21.42
Channel				131979	132322	132665
Frequency (MHz)				1710.7	1745	1779.3
1.4	QPSK	1	0	22.94	23.21	23.30
1.4	QPSK	1	3	23.11	23.13	23.26
1.4	QPSK	1	5	22.99	23.16	23.01
1.4	QPSK	3	0	22.93	23.17	23.30
1.4	QPSK	3	1	23.03	23.23	23.29
1.4	QPSK	3	3	23.05	23.24	23.19
1.4	QPSK	6	0	21.91	22.30	22.28
1.4	16QAM	1	0	21.85	22.34	21.96
1.4	16QAM	1	3	22.02	22.07	22.39
1.4	16QAM	1	5	21.68	21.96	21.82
1.4	16QAM	3	0	22.01	22.31	22.22
1.4	16QAM	3	1	22.10	22.20	22.24
1.4	16QAM	3	3	22.17	22.33	22.16
1.4	16QAM	6	0	21.05	21.34	21.15



EIRP

LTE Band 4 (GT - LC = 2.0 dB) QPSK									
Bandwidth	1.4M			3M			5M		
Channel	19957	20175	20393	19965	20175	20385	19975	20175	20375
	(Low)	(Mid)	(High)	(Low)	(Mid)	(High)	(Low)	(Mid)	(High)
Frequency (MHz)	1710.7	1732.5	1754.3	1711.5	1732.5	1753.5	1712.5	1732.5	1752.5
Conducted Power (dBm)	22.72	22.92	22.95	22.25	22.37	23.04	22.39	22.97	22.88
Conducted Power (Watts)	0.1871	0.1959	0.1972	0.1679	0.1726	0.2014	0.1734	0.1982	0.1941
EIRP(dBm)	24.72	24.92	24.95	24.25	24.37	25.04	24.39	24.97	24.88
EIRP(Watts)	0.2965	0.3105	0.3126	0.2661	0.2735	0.3192	0.2748	0.3141	0.3076

LTE Band 4 (GT - LC = 2.0 dB) QPSK									
Bandwidth	10M			15M			20M		
Channel	20000	20175	20350	20025	20175	20325	20050	20175	20300
	(Low)	(Mid)	(High)	(Low)	(Mid)	(High)	(Low)	(Mid)	(High)
Frequency (MHz)	1715	1732.5	1750	1717.5	1732.5	1747.5	1720	1732.5	1745
Conducted Power (dBm)	22.69	22.57	22.99	22.97	22.70	23.11	22.81	22.72	23.27
Conducted Power (Watts)	0.1858	0.1807	0.1991	0.1982	0.1862	0.2046	0.1910	0.1871	0.2123
EIRP(dBm)	24.69	24.57	24.99	24.97	24.70	25.11	24.81	24.72	25.27
EIRP(Watts)	0.2944	0.2864	0.3155	0.3141	0.2951	0.3243	0.3027	0.2965	0.3365



LTE Band 4 (GT - LC = 2.0 dB) 16QAM									
Bandwidth	1.4M			3M			5M		
Channel	19957	20175	20393	19965	20175	20385	19975	20175	20375
	(Low)	(Mid)	(High)	(Low)	(Mid)	(High)	(Low)	(Mid)	(High)
Frequency (MHz)	1710.7	1732.5	1754.3	1711.5	1732.5	1753.5	1712.5	1732.5	1752.5
Conducted Power (dBm)	21.28	21.37	22.02	21.73	21.75	21.85	21.82	21.85	22.38
Conducted Power (Watts)	0.1343	0.1371	0.1592	0.1489	0.1496	0.1531	0.1521	0.1531	0.1730
EIRP(dBm)	23.28	23.37	24.02	23.73	23.75	23.85	23.82	23.85	24.38
EIRP(Watts)	0.2128	0.2173	0.2523	0.2360	0.2371	0.2427	0.2410	0.2427	0.2742

LTE Band 4 (GT - LC = 2.0 dB) 16QAM									
Bandwidth	10M			15M			20M		
Channel	20000	20175	20350	20025	20175	20325	20050	20175	20300
	(Low)	(Mid)	(High)	(Low)	(Mid)	(High)	(Low)	(Mid)	(High)
Frequency (MHz)	1715	1732.5	1750	1717.5	1732.5	1747.5	1720	1732.5	1745
Conducted Power (dBm)	21.70	21.34	22.08	21.61	21.64	21.92	21.69	21.67	22.12
Conducted Power (Watts)	0.1479	0.1361	0.1614	0.1449	0.1459	0.1556	0.1476	0.1469	0.1629
EIRP(dBm)	23.70	23.34	24.08	23.61	23.64	23.92	23.69	23.67	24.12
EIRP(Watts)	0.2344	0.2158	0.2559	0.2296	0.2312	0.2466	0.2339	0.2328	0.2582



LTE Band 66 (GT - LC = 2.0 dB) QPSK									
Bandwidth	1.4M			3M			5M		
Channel	131979	132322	132665	131987	132322	132657	131997	132322	132647
	(Low)	(Mid)	(High)	(Low)	(Mid)	(High)	(Low)	(Mid)	(High)
Frequency (MHz)	1710.7	1745	1779.3	1711.5	1745	1778.5	1712.5	1745	1777.5
Conducted Power (dBm)	22.93	23.17	23.30	23.14	23.35	23.37	23.32	23.27	23.27
Conducted Power (Watts)	0.1963	0.2075	0.2138	0.2061	0.2163	0.2173	0.2148	0.2123	0.2123
EIRP(dBm)	24.93	25.17	25.30	25.14	25.35	25.37	25.32	25.27	25.27
EIRP(Watts)	0.3112	0.3289	0.3388	0.3266	0.3428	0.3443	0.3404	0.3365	0.3365

LTE Band 66 (GT - LC = 2.0 dB) QPSK									
Bandwidth	10M			15M			20M		
Channel	132022	132322	132622	132047	132322	132597	132072	132322	132572
	(Low)	(Mid)	(High)	(Low)	(Mid)	(High)	(Low)	(Mid)	(Mid)
Frequency (MHz)	1715	1745	1775	1717.5	1745	1772.5	1720	1745	1770
Conducted Power (dBm)	22.92	23.35	23.00	23.35	22.57	23.11	23.02	23.39	22.98
Conducted Power (Watts)	0.1959	0.2163	0.1995	0.2163	0.1807	0.2046	0.2004	0.2183	0.1986
EIRP(dBm)	24.92	25.35	25.00	25.35	24.57	25.11	25.02	25.39	24.98
EIRP(Watts)	0.3105	0.3428	0.3162	0.3428	0.2864	0.3243	0.3177	0.3459	0.3148



LTE Band 66 (GT - LC = 2.0 dB) 16QAM									
Bandwidth	1.4M			3M			5M		
Channel	131979	132322	132665	131987	132322	132657	131997	132322	132647
	(Low)	(Mid)	(High)	(Low)	(Mid)	(High)	(Low)	(Mid)	(High)
Frequency (MHz)	1710.7	1745	1779.3	1711.5	1745	1778.5	1712.5	1745	1777.5
Conducted Power (dBm)	22.02	22.07	22.39	22.38	22.05	22.51	22.26	22.37	22.07
Conducted Power (Watts)	0.1592	0.1611	0.1734	0.1730	0.1603	0.1782	0.1683	0.1726	0.1611
EIRP(dBm)	24.02	24.07	24.39	24.38	24.05	24.51	24.26	24.37	24.07
EIRP(Watts)	0.2523	0.2553	0.2748	0.2742	0.2541	0.2825	0.2667	0.2735	0.2553

LTE Band 66 (GT - LC = 2.0 dB) 16QAM									
Bandwidth	10M			15M			20M		
Channel	132022	132322	132622	132047	132322	132597	132072	132322	132572
	(Low)	(Mid)	(High)	(Low)	(Mid)	(High)	(Low)	(Mid)	(Mid)
Frequency (MHz)	1715	1745	1775	1717.5	1745	1772.5	1720	1745	1770
Conducted Power (dBm)	21.80	22.77	21.99	22.72	21.69	22.53	22.35	21.85	22.09
Conducted Power (Watts)	0.1514	0.1892	0.1581	0.1871	0.1476	0.1791	0.1718	0.1531	0.1618
EIRP(dBm)	23.80	24.77	23.99	24.72	23.69	24.53	24.35	23.85	24.09
EIRP(Watts)	0.2399	0.2999	0.2506	0.2965	0.2339	0.2838	0.2723	0.2427	0.2564



LTE Band 66

Peak-to-Average Ratio

Mode	LTE Band 66 / 20MHz				
Mod.	QPSK		16QAM		Limit: 13dB
RB Size	1RB	Full RB	1RB	Full RB	Result
Lowest CH	4.93	4.90	5.71	5.97	PASS
Middle CH	4.58	5.19	5.62	6.23	
Highest CH	4.93	4.87	5.71	5.97	



LTE Band 66 / 20MHz / QPSK

Lowest Channel / 1RB

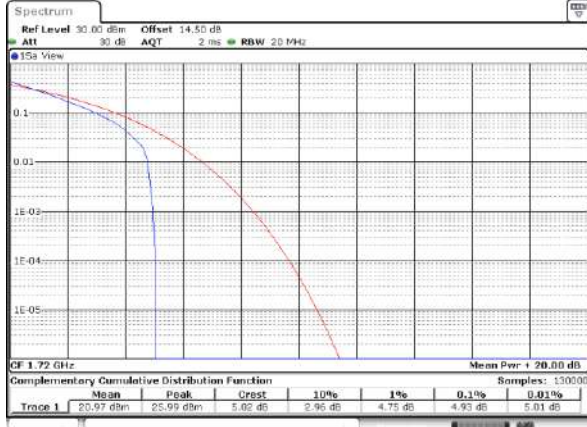

Date: 06/09/2022 19:44:22

Lowest Channel / Full RB

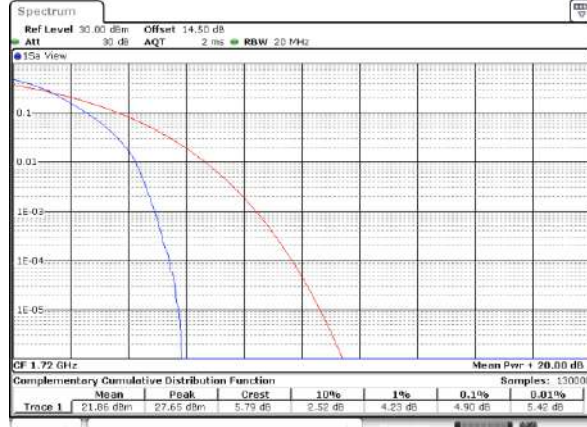

Date: 06/09/2022 19:42:36

Middle Channel / 1RB

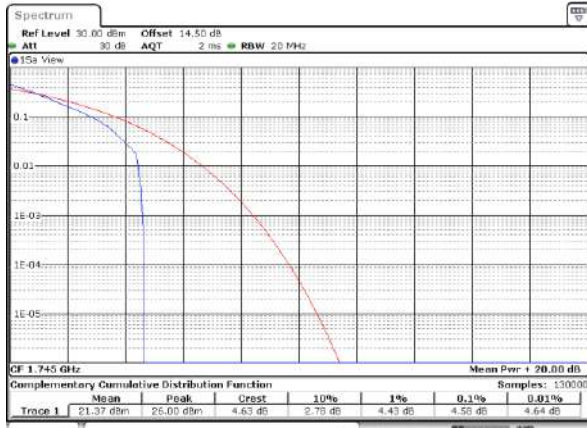

Date: 06/09/2022 19:45:20

Middle Channel / Full RB

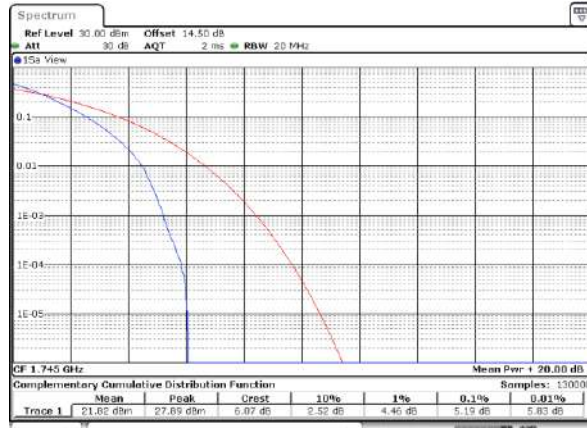

Date: 06/09/2022 20:34:27

Highest Channel / 1RB



Date: 06/09/2022 20:46:49

Highest Channel / Full RB

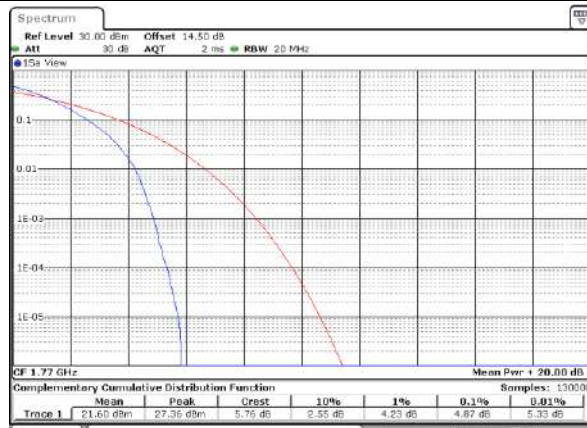

Date: 06/09/2022 20:35:10



LTE Band 66 / 20MHz / 16QAM

Lowest Channel / 1RB



Date: 9/JUN/2022 19:45:14:3

Lowest Channel / Full RB

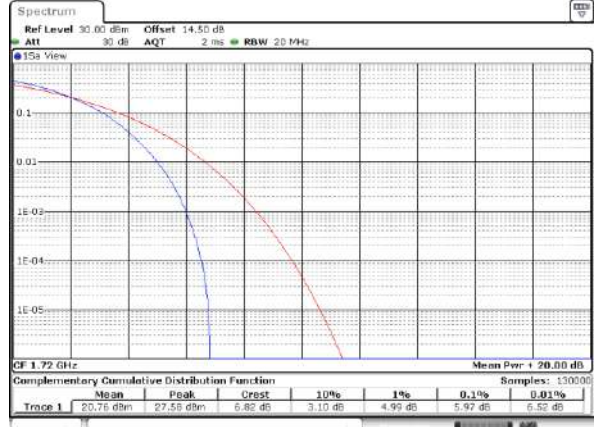

Date: 9/JUN/2022 19:44:12:7

Middle Channel / 1RB



Date: 9/JUN/2022 20:10:13:5

Middle Channel / Full RB

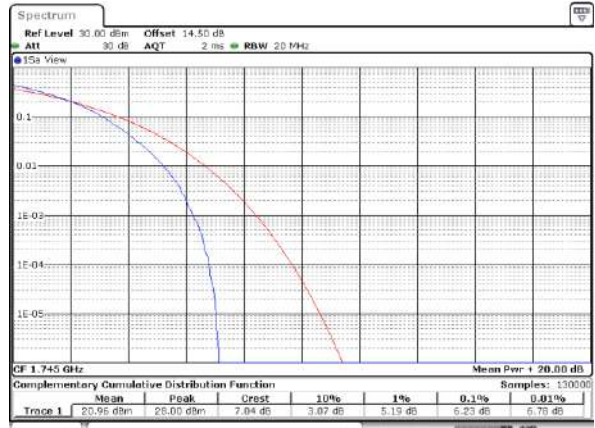

Date: 9/JUN/2022 20:10:10:9

Highest Channel / 1RB



Date: 9/JUN/2022 20:46:11:8

Highest Channel / Full RB



Date: 9/JUN/2022 20:40:13:3



26dB Bandwidth

Mode	LTE Band 66 : 26dB BW(MHz)											
BW	1.4MHz		3MHz		5MHz		10MHz		15MHz		20MHz	
Mod.	QPSK	16QAM	QPSK	16QAM	QPSK	16QAM	QPSK	16QAM	QPSK	16QAM	QPSK	16QAM
Lowest CH	1.26	1.28	2.99	3.02	4.94	4.87	9.85	9.93	14.36	14.30	18.90	18.82
Middle CH	1.28	1.26	3.05	3.05	4.99	4.84	9.95	9.75	14.36	14.30	18.86	18.70
Highest CH	1.26	1.29	2.99	3.02	4.91	4.95	9.83	9.79	14.36	14.39	18.86	18.98



LTE Band 66

Lowest Channel / 1.4MHz / QPSK

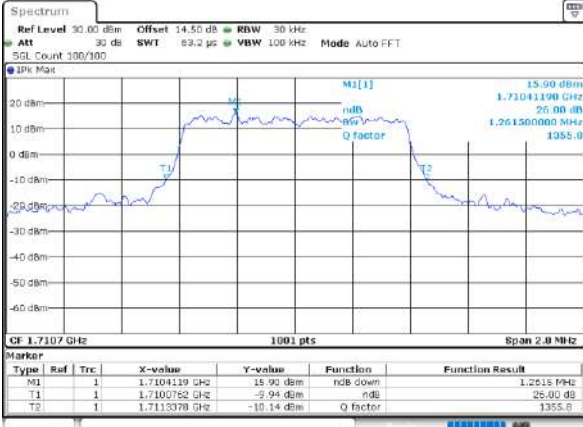

Date: 9/20/2022 11:04:10

Lowest Channel / 1.4MHz / 16QAM

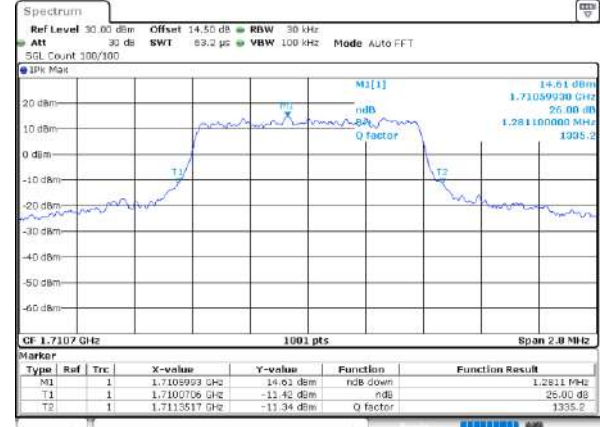

Date: 9/20/2022 11:04:10

Middle Channel / 1.4MHz / QPSK

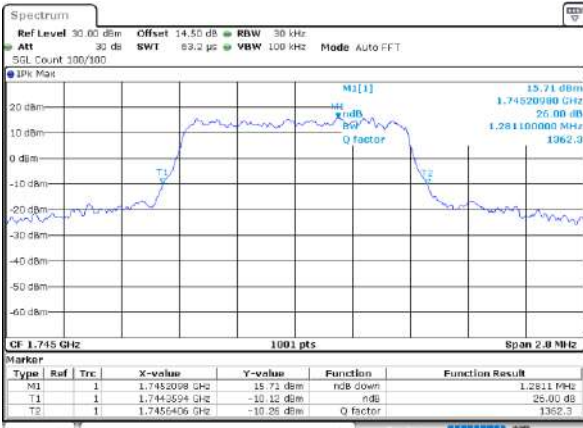

Date: 9/20/2022 11:12:16

Middle Channel / 1.4MHz / 16QAM

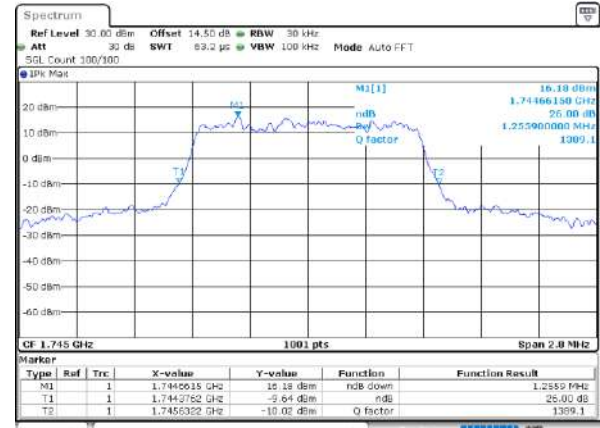

Date: 9/20/2022 11:14:21

Highest Channel / 1.4MHz / QPSK

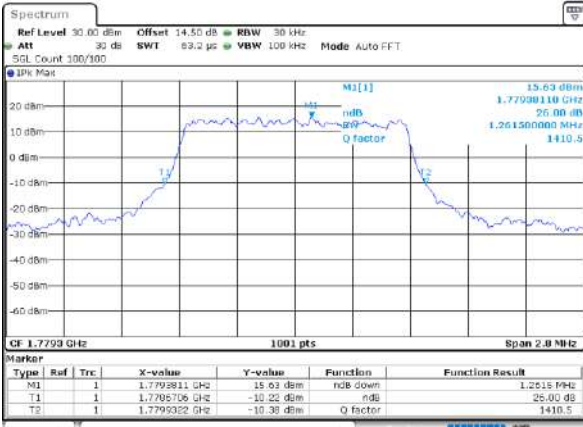

Date: 9/20/2022 11:17:19

Highest Channel / 1.4MHz / 16QAM

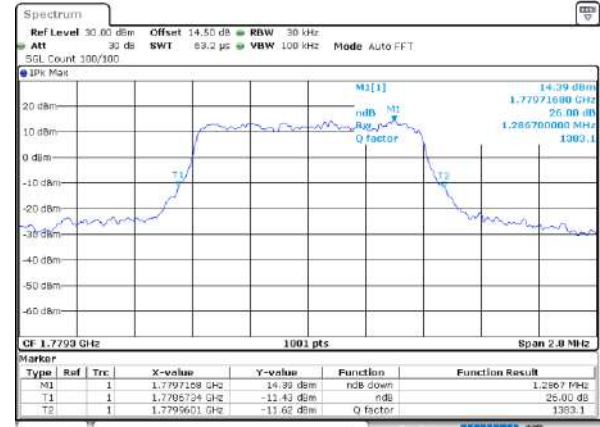

Date: 9/20/2022 11:17:44



LTE Band 66

Lowest Channel / 3MHz / QPSK

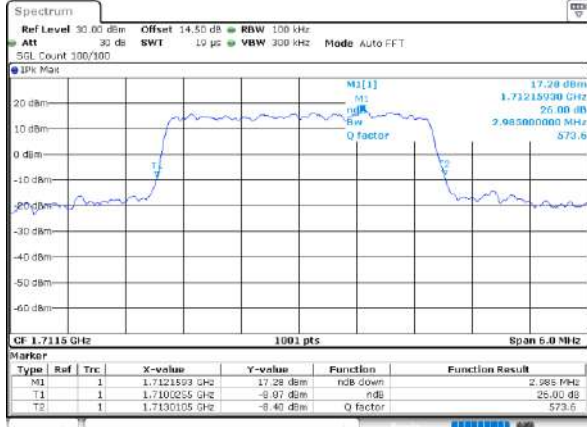

Date: 9/JUN/2022 10:50:04

Lowest Channel / 3MHz / 16QAM

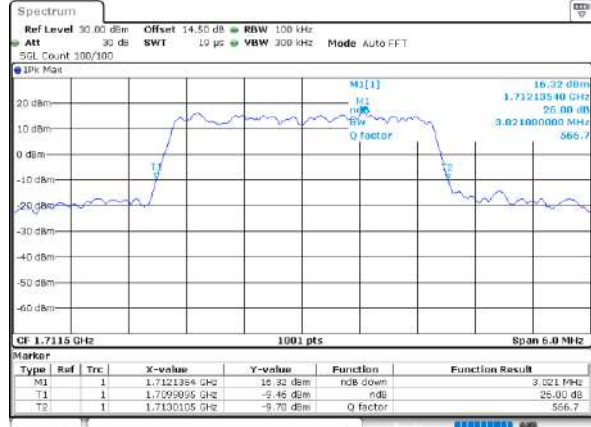

Date: 9/JUN/2022 10:50:18

Middle Channel / 3MHz / QPSK

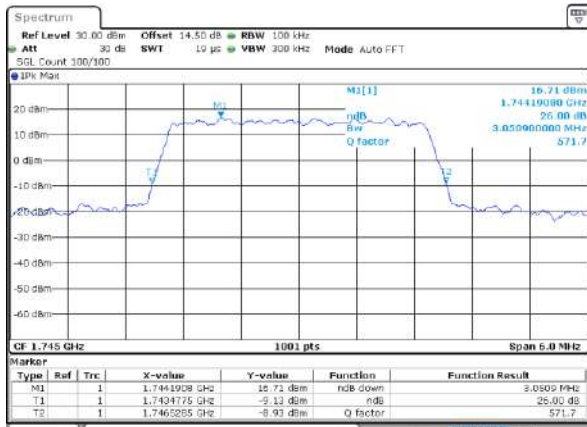

Date: 9/JUN/2022 10:51:06

Middle Channel / 3MHz / 16QAM

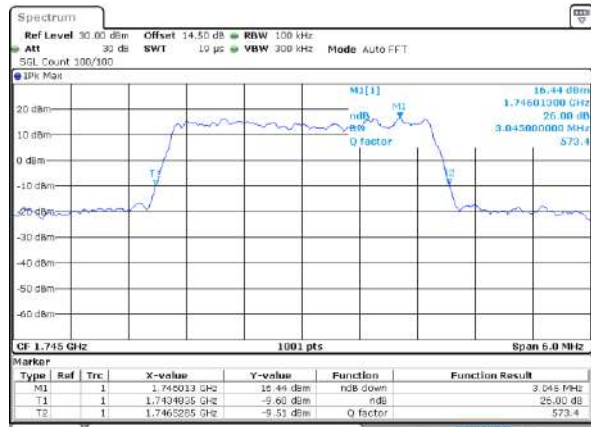

Date: 9/JUN/2022 10:51:08

Highest Channel / 3MHz / QPSK

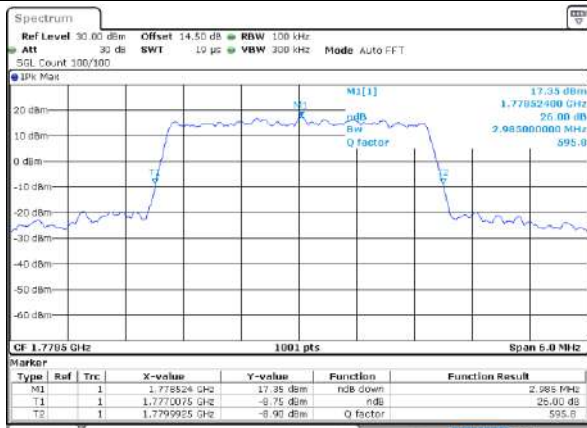

Date: 9/JUN/2022 10:51:55

Highest Channel / 3MHz / 16QAM

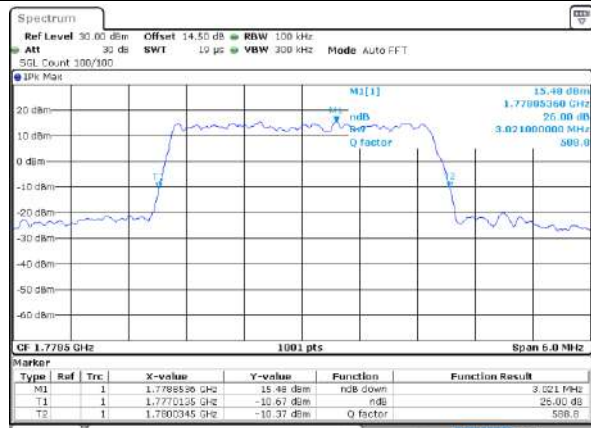

Date: 9/JUN/2022 10:54:17



LTE Band 66

Lowest Channel / 5MHz / QPSK

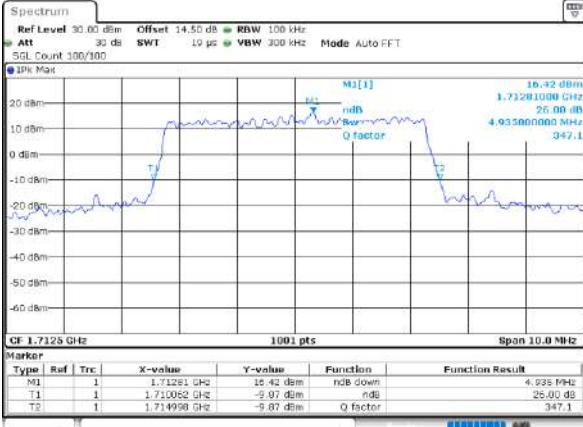

Date: 9/NOV/2022 14:24:58

Lowest Channel / 5MHz / 16QAM

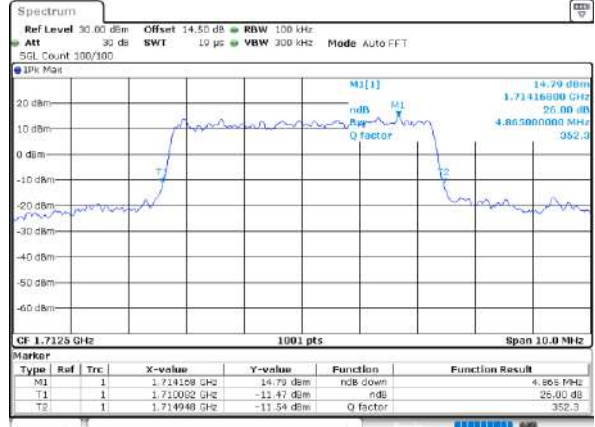

Date: 9/NOV/2022 14:25:18

Middle Channel / 5MHz / QPSK

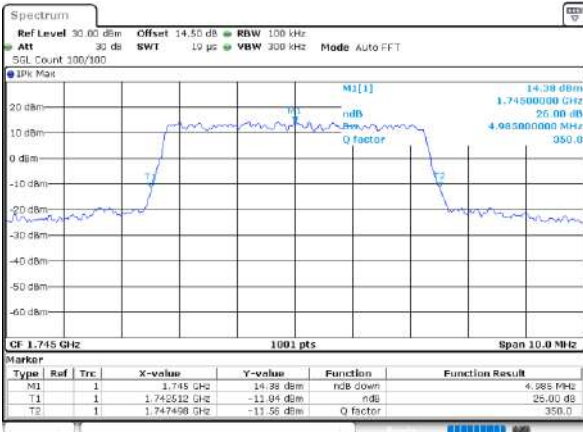

Date: 9/NOV/2022 14:31:06

Middle Channel / 5MHz / 16QAM

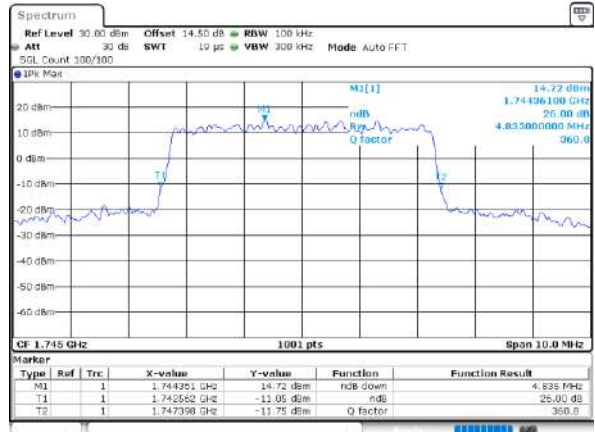

Date: 9/NOV/2022 14:31:28

Highest Channel / 5MHz / QPSK

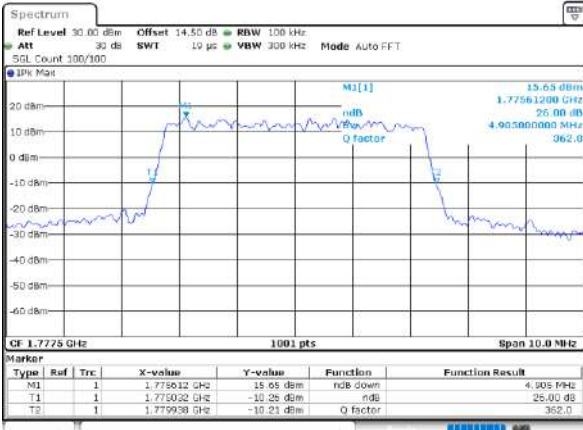

Date: 9/NOV/2022 14:34:15

Highest Channel / 5MHz / 16QAM



Date: 9/NOV/2022 14:34:27



LTE Band 66

Lowest Channel / 10MHz / QPSK

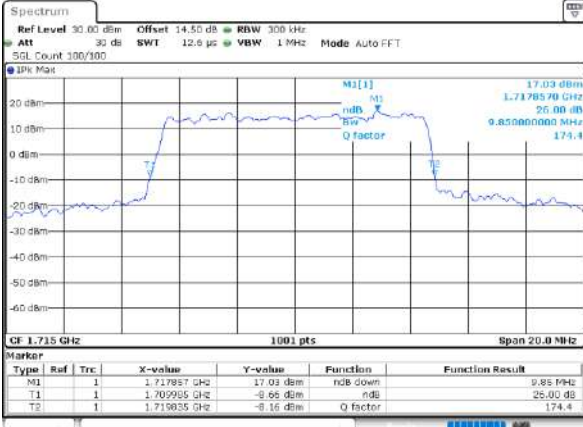

Date: 9/20/2022 14:41:40

Lowest Channel / 10MHz / 16QAM

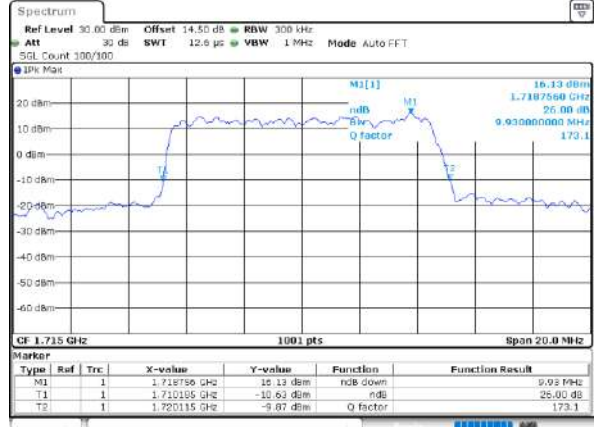

Date: 9/20/2022 14:42:02

Middle Channel / 10MHz / QPSK

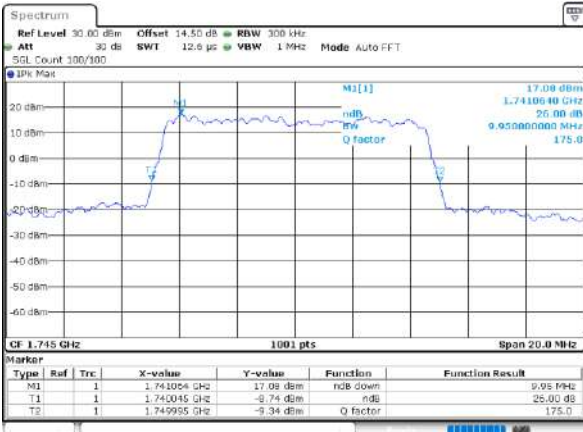

Date: 9/20/2022 14:56:09

Middle Channel / 10MHz / 16QAM

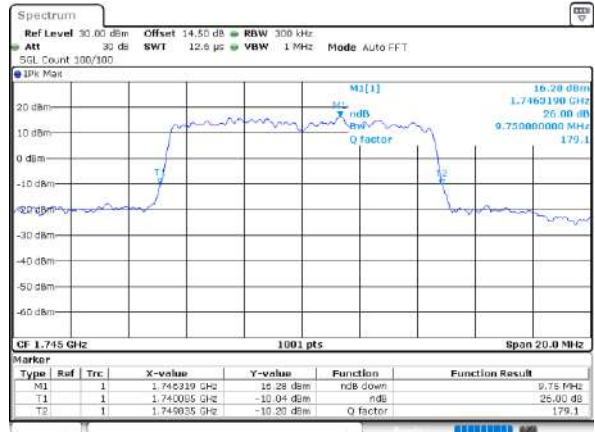

Date: 9/20/2022 14:56:21

Highest Channel / 10MHz / QPSK

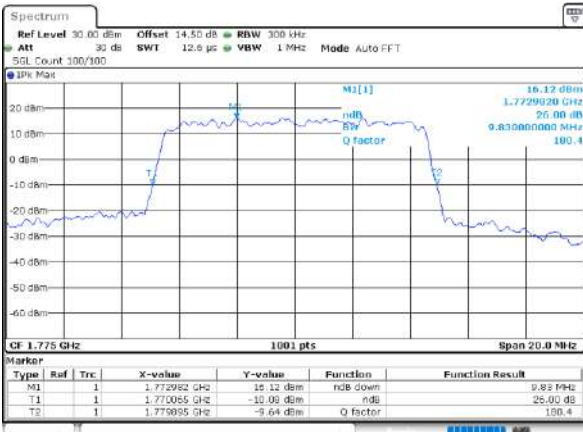

Date: 9/20/2022 15:00:58

Highest Channel / 10MHz / 16QAM

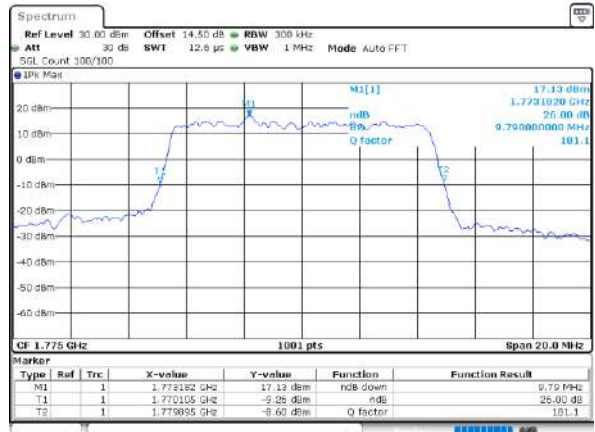

Date: 9/20/2022 15:01:12



LTE Band 66

Lowest Channel / 15MHz / QPSK

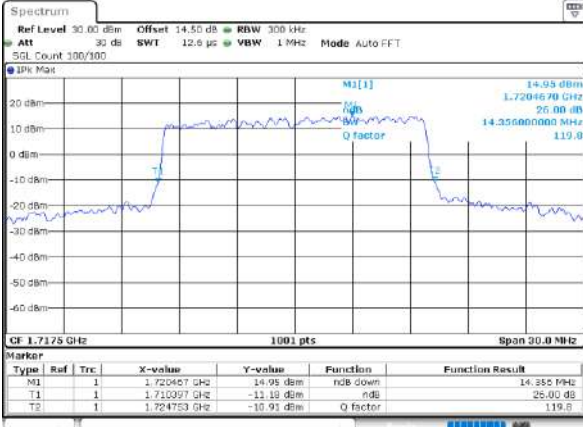

Date: 06/NOV/2022 17:15:02

Lowest Channel / 15MHz / 16QAM

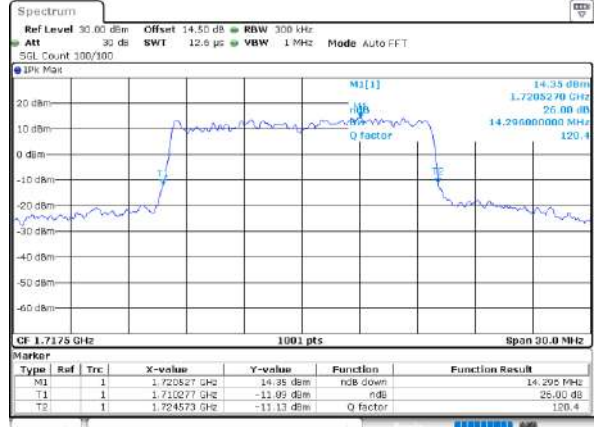

Date: 06/NOV/2022 17:15:07

Middle Channel / 15MHz / QPSK



Date: 06/NOV/2022 17:15:08

Middle Channel / 15MHz / 16QAM

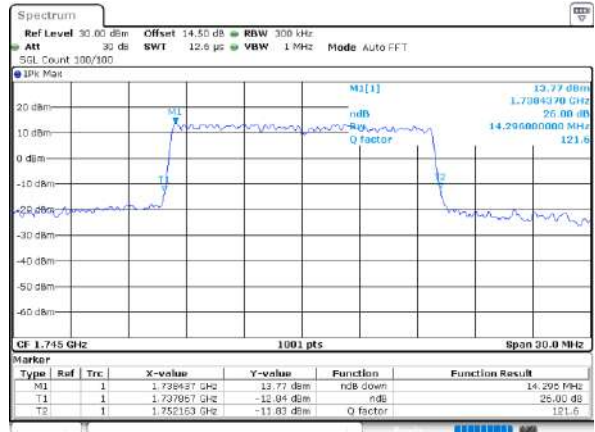

Date: 06/NOV/2022 17:15:02

Highest Channel / 15MHz / QPSK



Date: 06/NOV/2022 19:10:56

Highest Channel / 15MHz / 16QAM

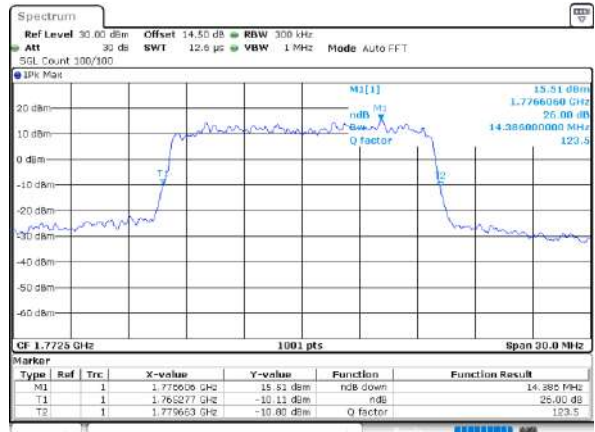

Date: 06/NOV/2022 19:12:59



LTE Band 66

Lowest Channel / 20MHz / QPSK

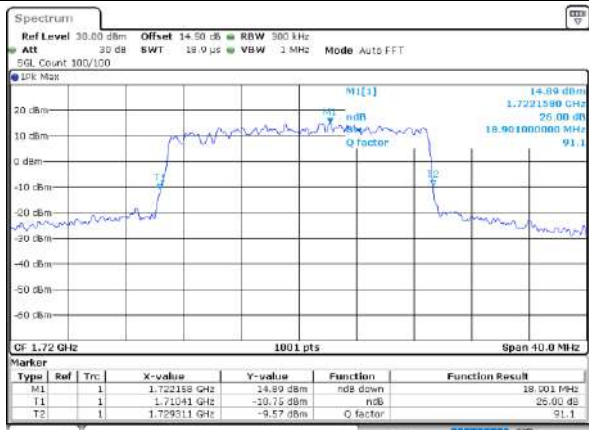

Date: 8/AUG/2022 21:24:57

Lowest Channel / 20MHz / 16QAM

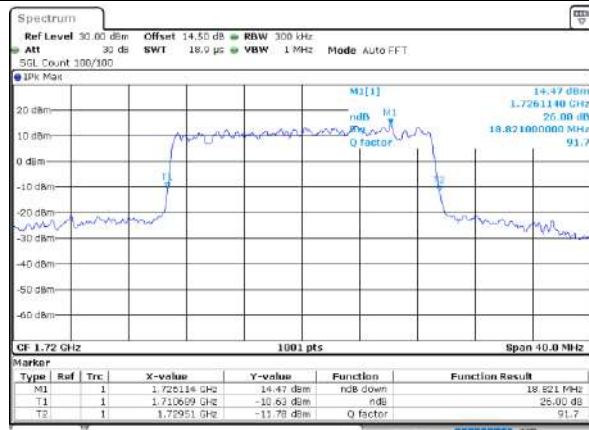

Date: 8/AUG/2022 19:43:02

Middle Channel / 20MHz / QPSK

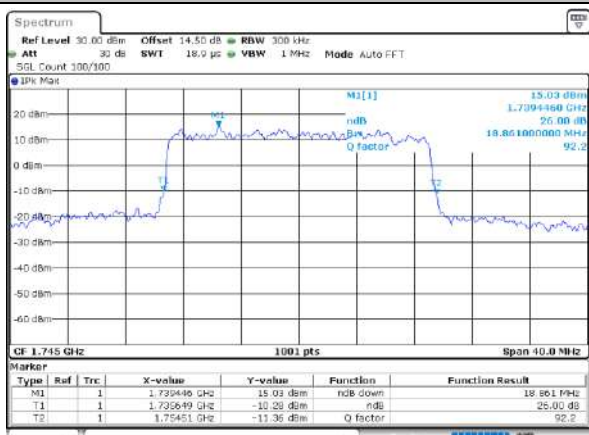

Date: 8/AUG/2022 20:23:26

Middle Channel / 20MHz / 16QAM

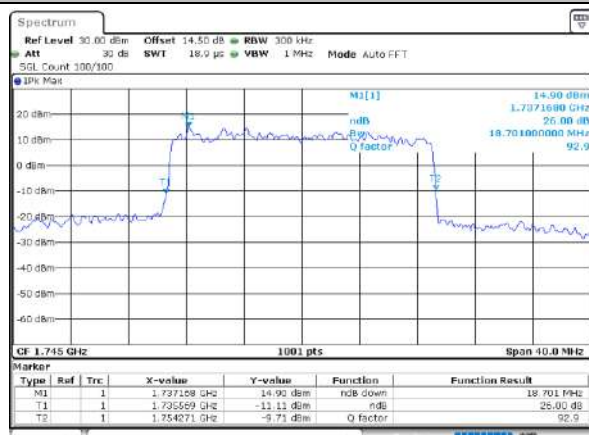

Date: 8/AUG/2022 20:21:06

Highest Channel / 20MHz / QPSK

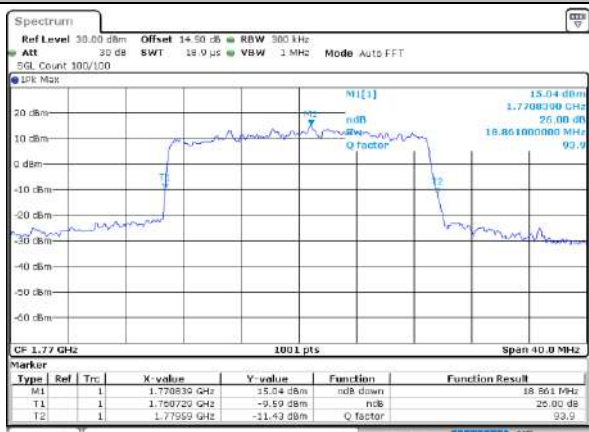

Date: 8/AUG/2022 21:29:50

Highest Channel / 20MHz / 16QAM

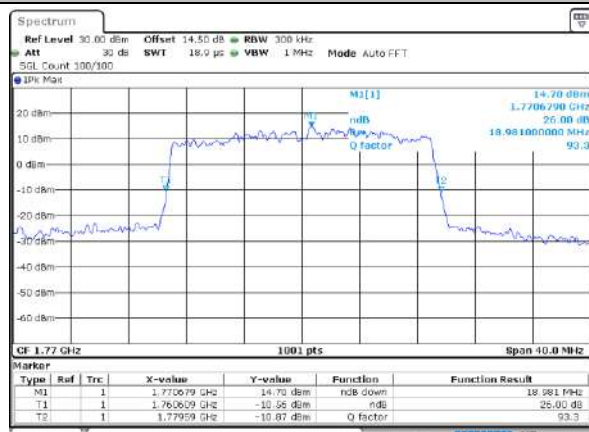

Date: 8/AUG/2022 20:43:22



Occupied Bandwidth

Mode	LTE Band 66 : 99%OBW(MHz)											
	1.4MHz		3MHz		5MHz		10MHz		15MHz		20MHz	
BW												
Mod.	QPSK	16QAM	QPSK	16QAM	QPSK	16QAM	QPSK	16QAM	QPSK	16QAM	QPSK	16QAM
Lowest CH	1.09	1.10	2.71	2.72	4.51	4.52	9.07	9.01	13.46	13.43	17.78	17.90
Middle CH	1.10	1.09	2.72	2.71	4.51	4.51	8.93	8.97	13.46	13.46	17.86	17.86
Highest CH	1.09	1.09	2.73	2.72	4.51	4.50	8.93	9.03	13.37	13.37	17.82	17.78



LTE Band 66

Lowest Channel / 1.4MHz / QPSK

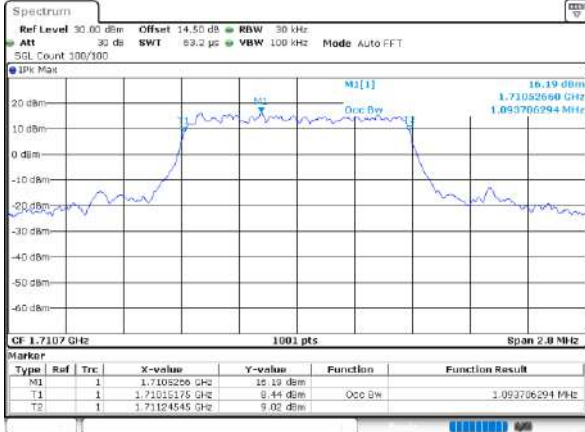

Lowest Channel / 1.4MHz / 16QAM

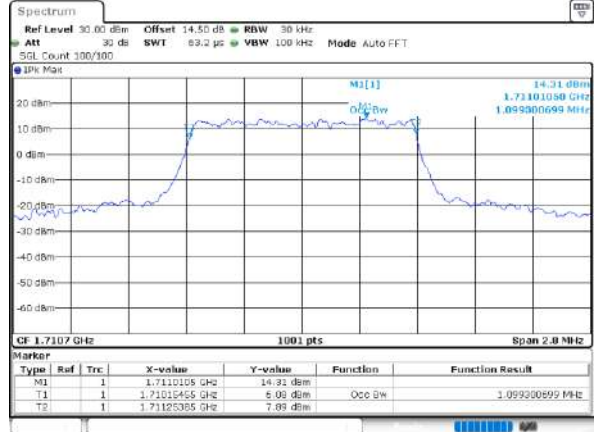

Middle Channel / 1.4MHz / QPSK

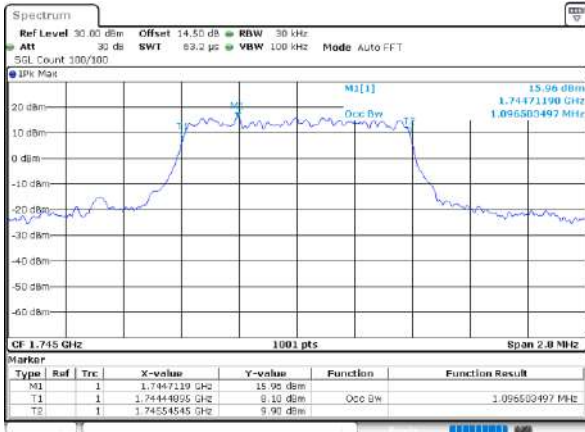

Middle Channel / 1.4MHz / 16QAM

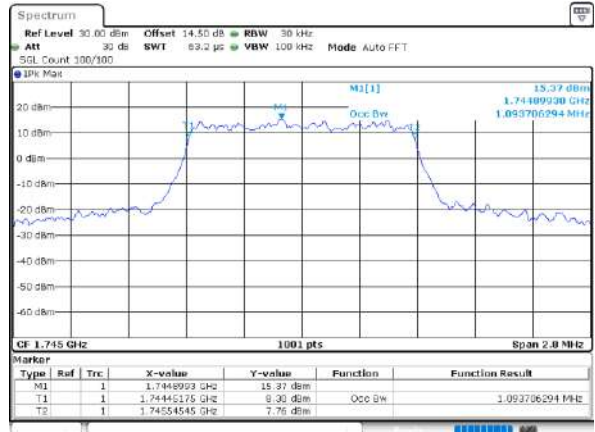

Highest Channel / 1.4MHz / QPSK

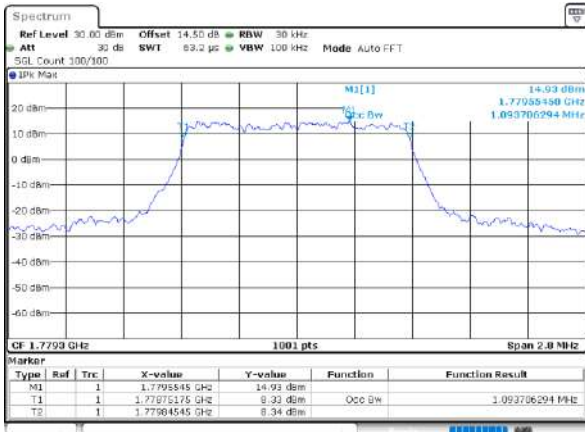

Highest Channel / 1.4MHz / 16QAM

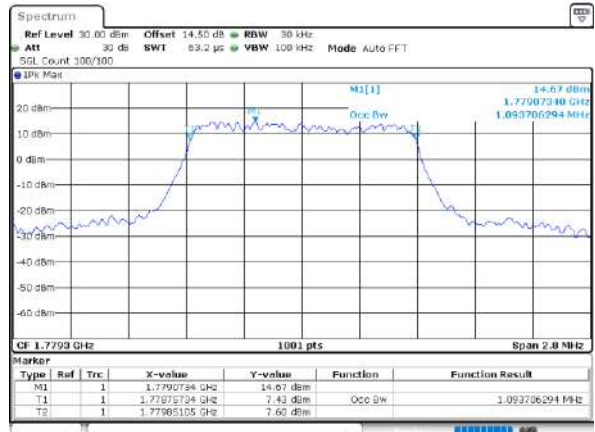



LTE Band 66

Lowest Channel / 3MHz / QPSK

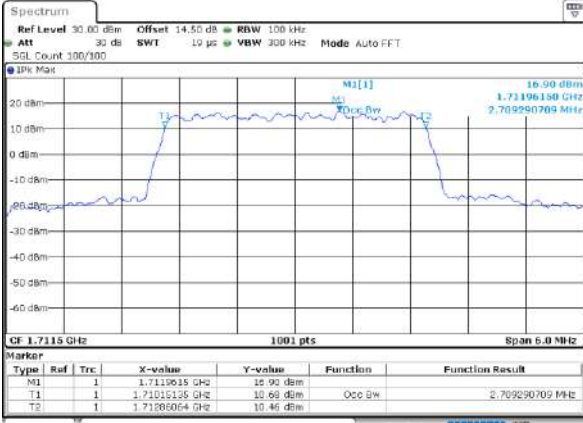

Date: 9/20/2022 13:49:15

Lowest Channel / 3MHz / 16QAM

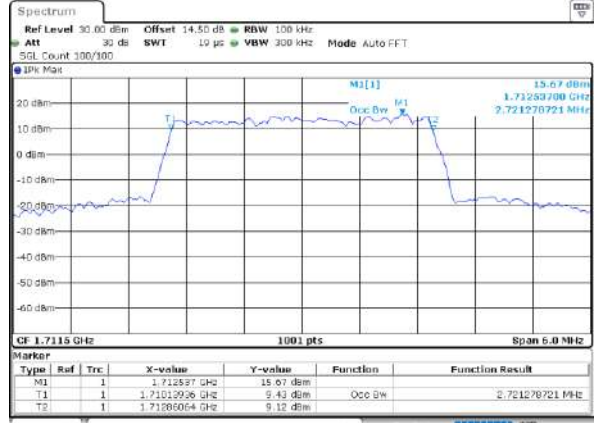

Date: 9/20/2022 13:49:19

Middle Channel / 3MHz / QPSK

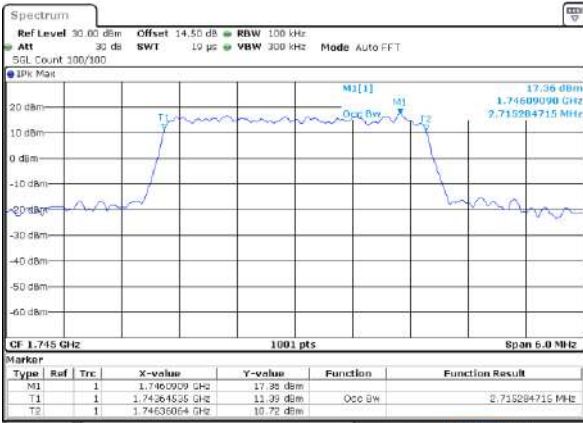

Date: 9/20/2022 13:50:02

Middle Channel / 3MHz / 16QAM

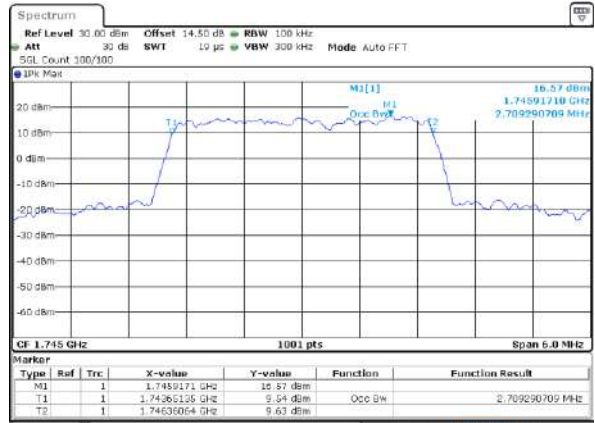

Date: 9/20/2022 13:50:14

Highest Channel / 3MHz / QPSK

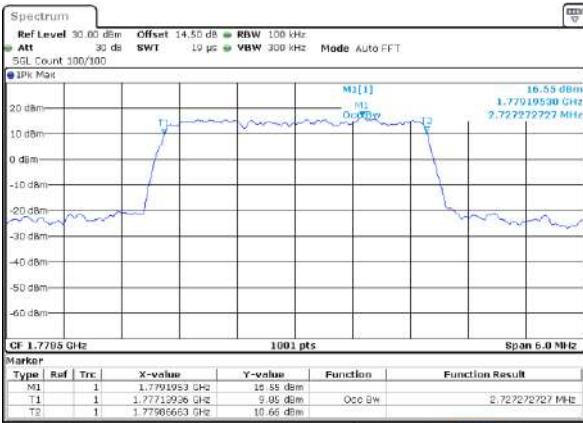

Date: 9/20/2022 13:50:11

Highest Channel / 3MHz / 16QAM

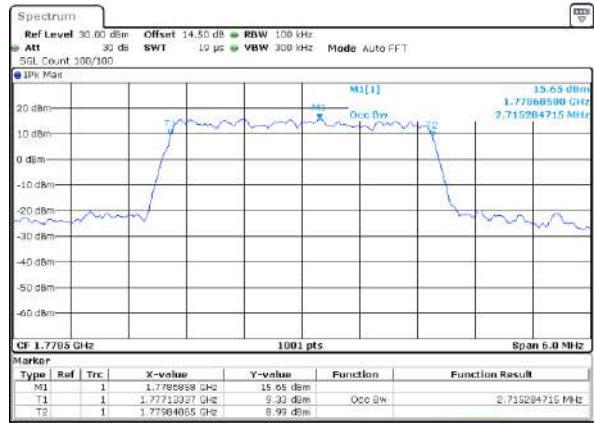

Date: 9/20/2022 13:50:13



LTE Band 66

Lowest Channel / 5MHz / QPSK

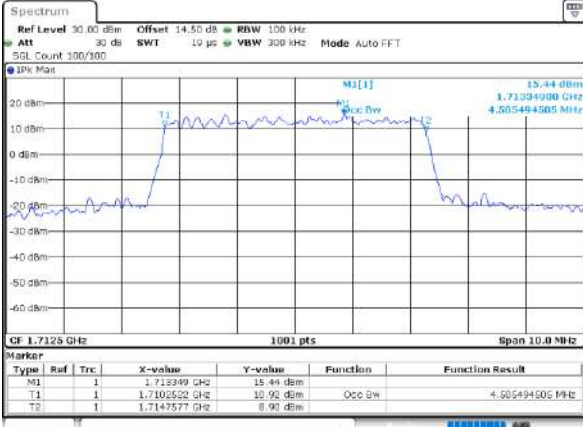

Date: 9/20/2022 14:24:14

Lowest Channel / 5MHz / 16QAM

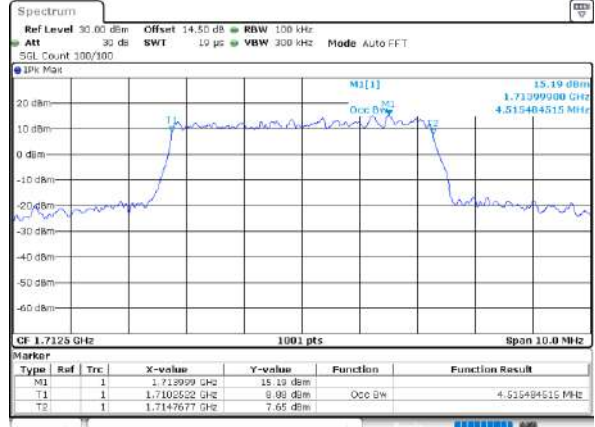

Date: 9/20/2022 14:24:16

Middle Channel / 5MHz / QPSK

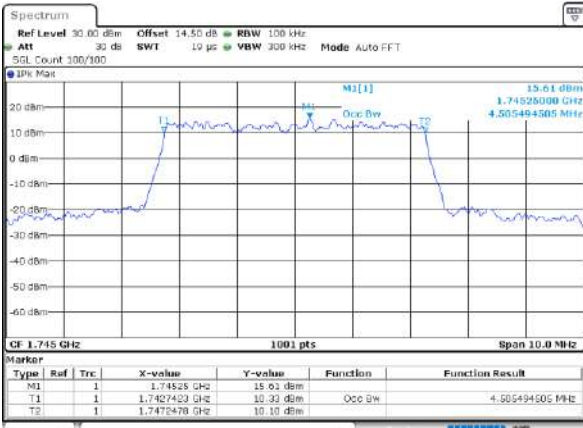

Date: 9/20/2022 14:20:23

Middle Channel / 5MHz / 16QAM

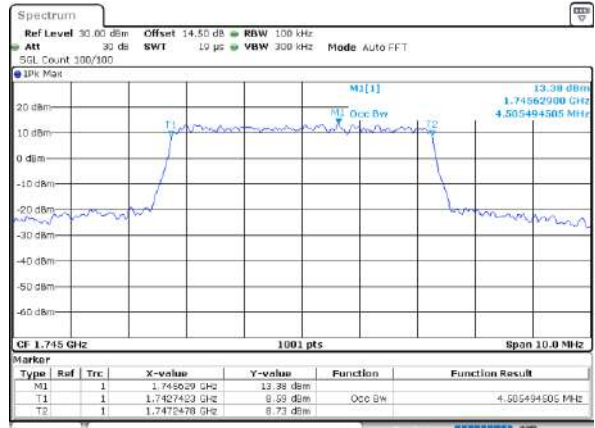

Date: 9/20/2022 14:20:45

Highest Channel / 5MHz / QPSK

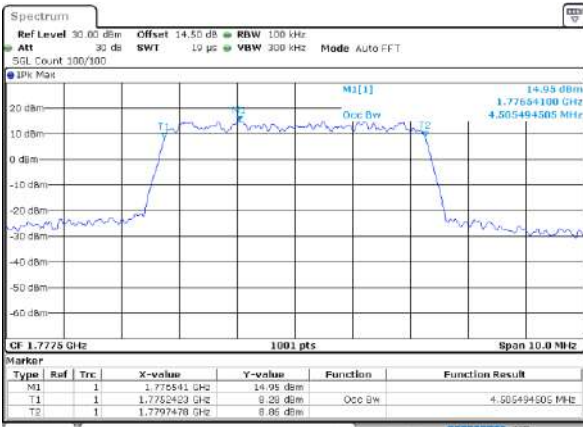

Date: 9/20/2022 14:22:22

Highest Channel / 5MHz / 16QAM

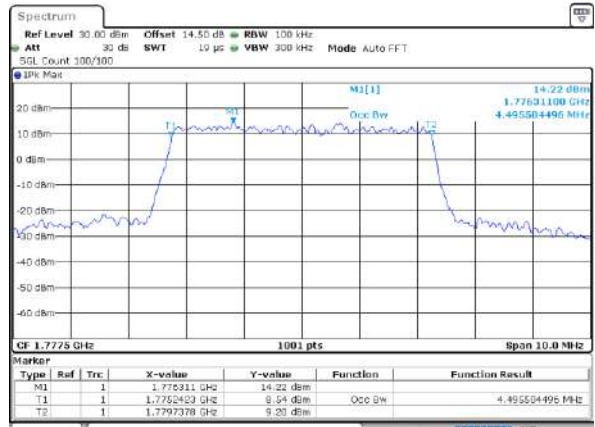

Date: 9/20/2022 14:22:13



LTE Band 66

Lowest Channel / 10MHz / QPSK

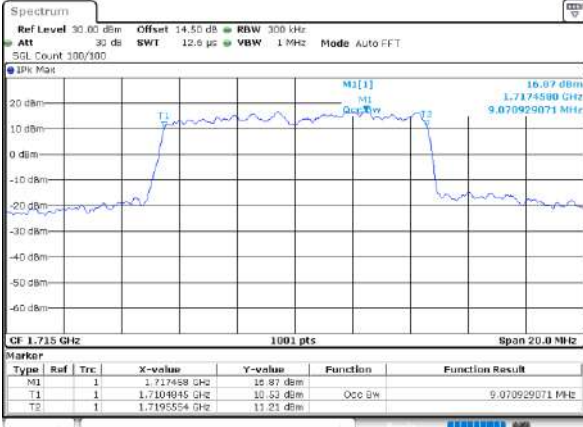

Date: 9/20/2022 14:39:41

Lowest Channel / 10MHz / 16QAM

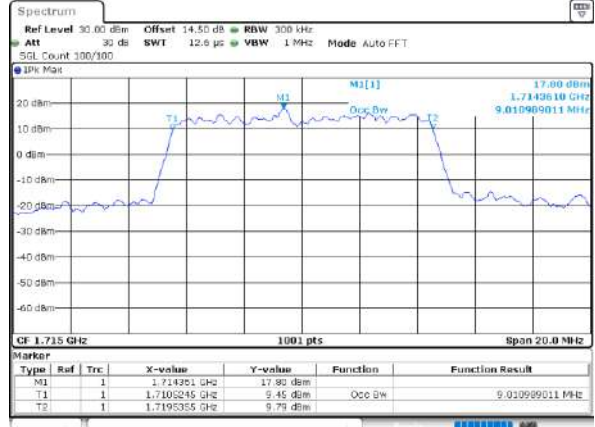

Date: 9/20/2022 14:40:47

Middle Channel / 10MHz / QPSK

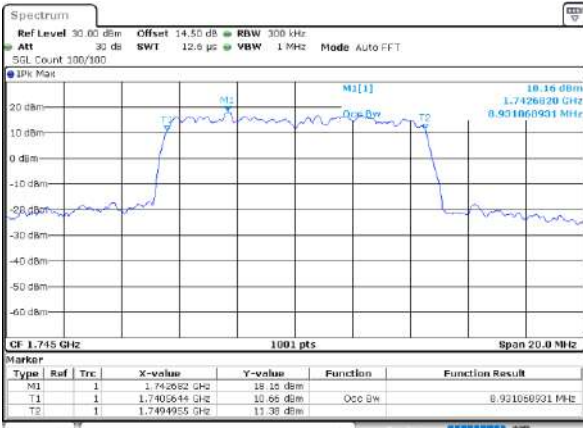

Date: 9/20/2022 14:55:25

Middle Channel / 10MHz / 16QAM

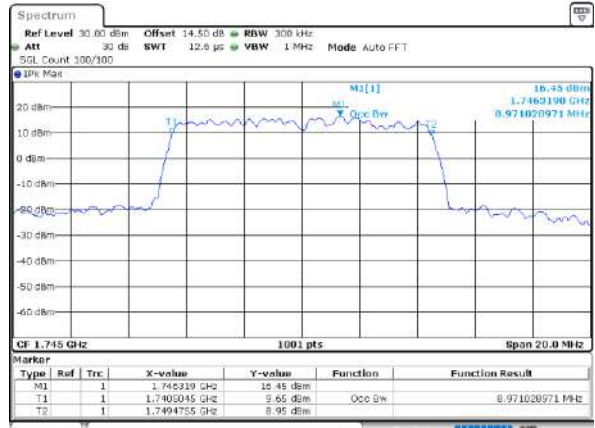

Date: 9/20/2022 14:55:47

Highest Channel / 10MHz / QPSK

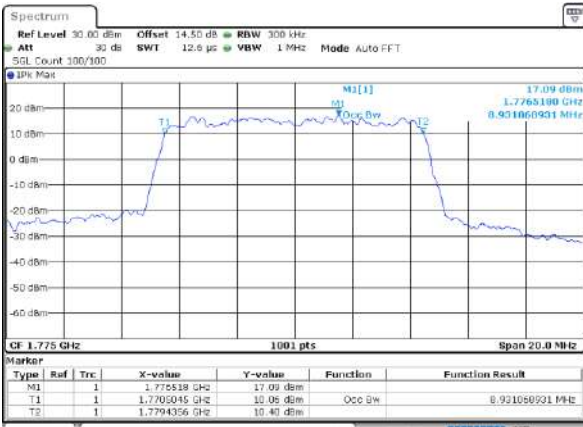

Date: 9/20/2022 15:19:07

Highest Channel / 10MHz / 16QAM

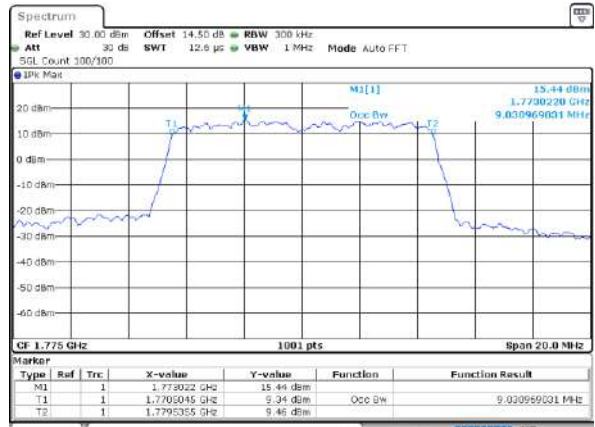

Date: 9/20/2022 15:19:19



LTE Band 66

Lowest Channel / 15MHz / QPSK

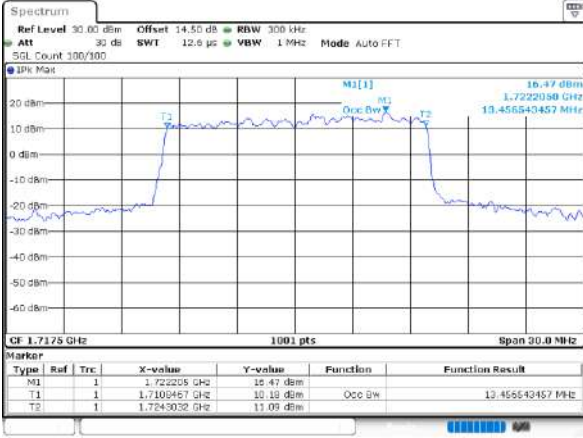

Date: 9/20/2022 17:49:41

Lowest Channel / 15MHz / 16QAM

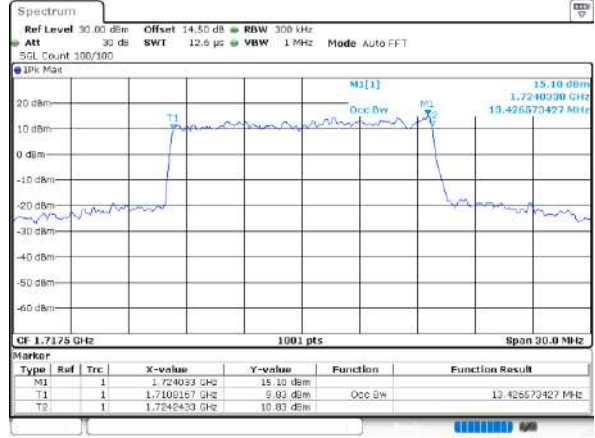

Date: 9/20/2022 17:56:06

Middle Channel / 15MHz / QPSK

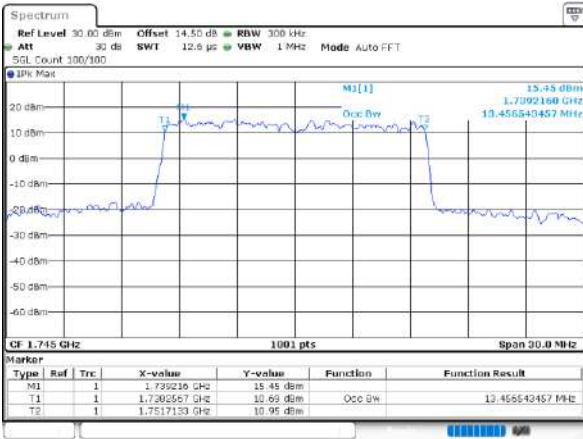

Date: 9/20/2022 17:59:17

Middle Channel / 15MHz / 16QAM

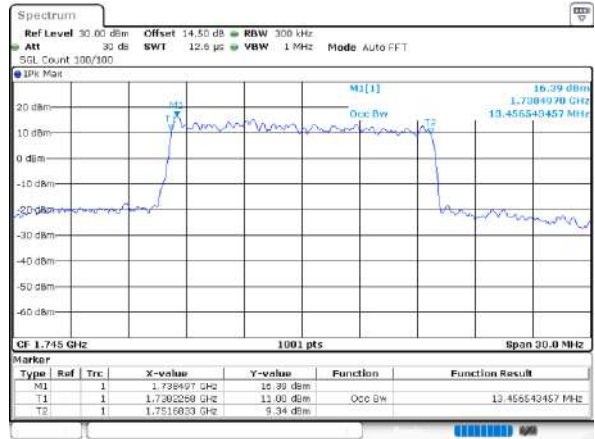

Date: 9/20/2022 17:59:22

Highest Channel / 15MHz / QPSK

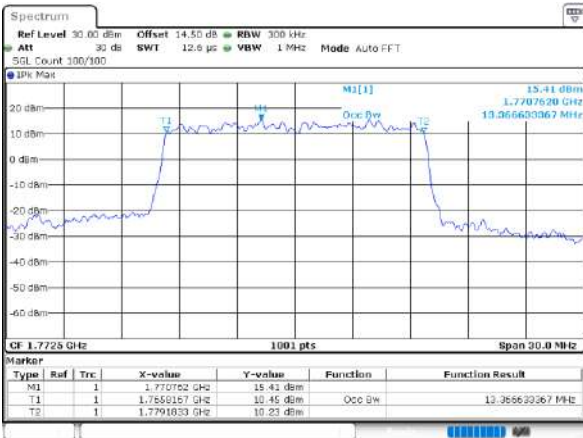

Date: 9/20/2022 19:09:22

Highest Channel / 15MHz / 16QAM

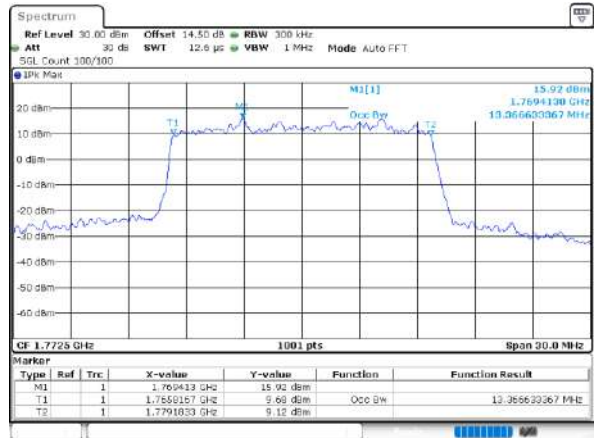

Date: 9/20/2022 19:11:25



LTE Band 66

Lowest Channel / 20MHz / QPSK

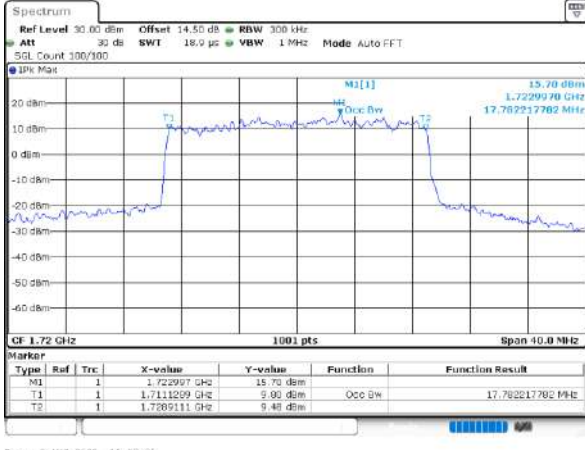

Date: 9/20/2022 19:43:05

Lowest Channel / 20MHz / 16QAM

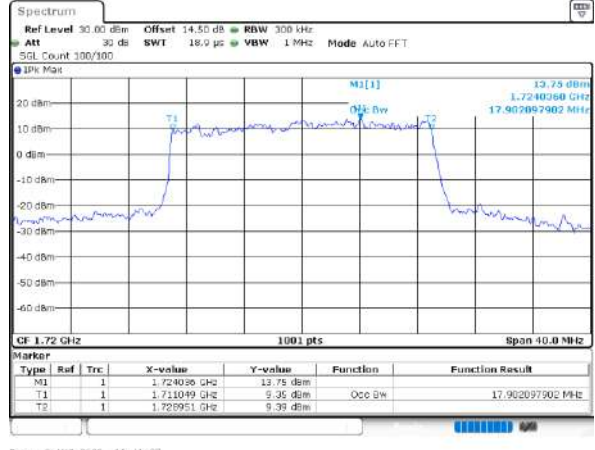

Date: 9/20/2022 19:41:27

Middle Channel / 20MHz / QPSK

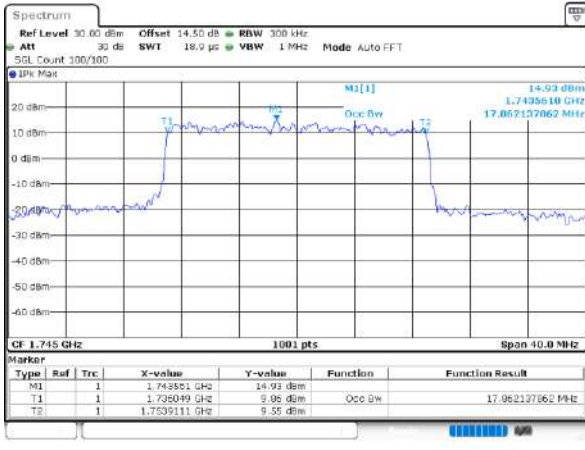

Date: 9/20/2022 20:43:06

Middle Channel / 20MHz / 16QAM

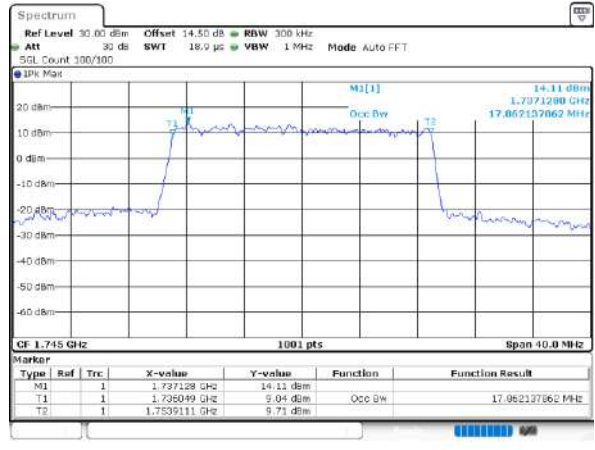

Date: 9/20/2022 20:43:21

Highest Channel / 20MHz / QPSK

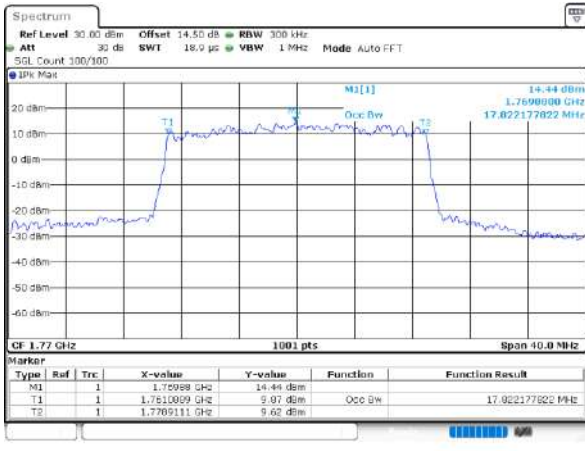

Date: 9/20/2022 20:43:57

Highest Channel / 20MHz / 16QAM

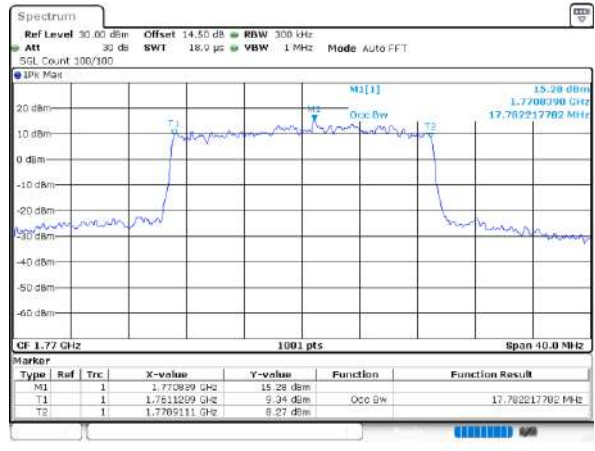

Date: 9/20/2022 20:43:58



Conducted Band Edge

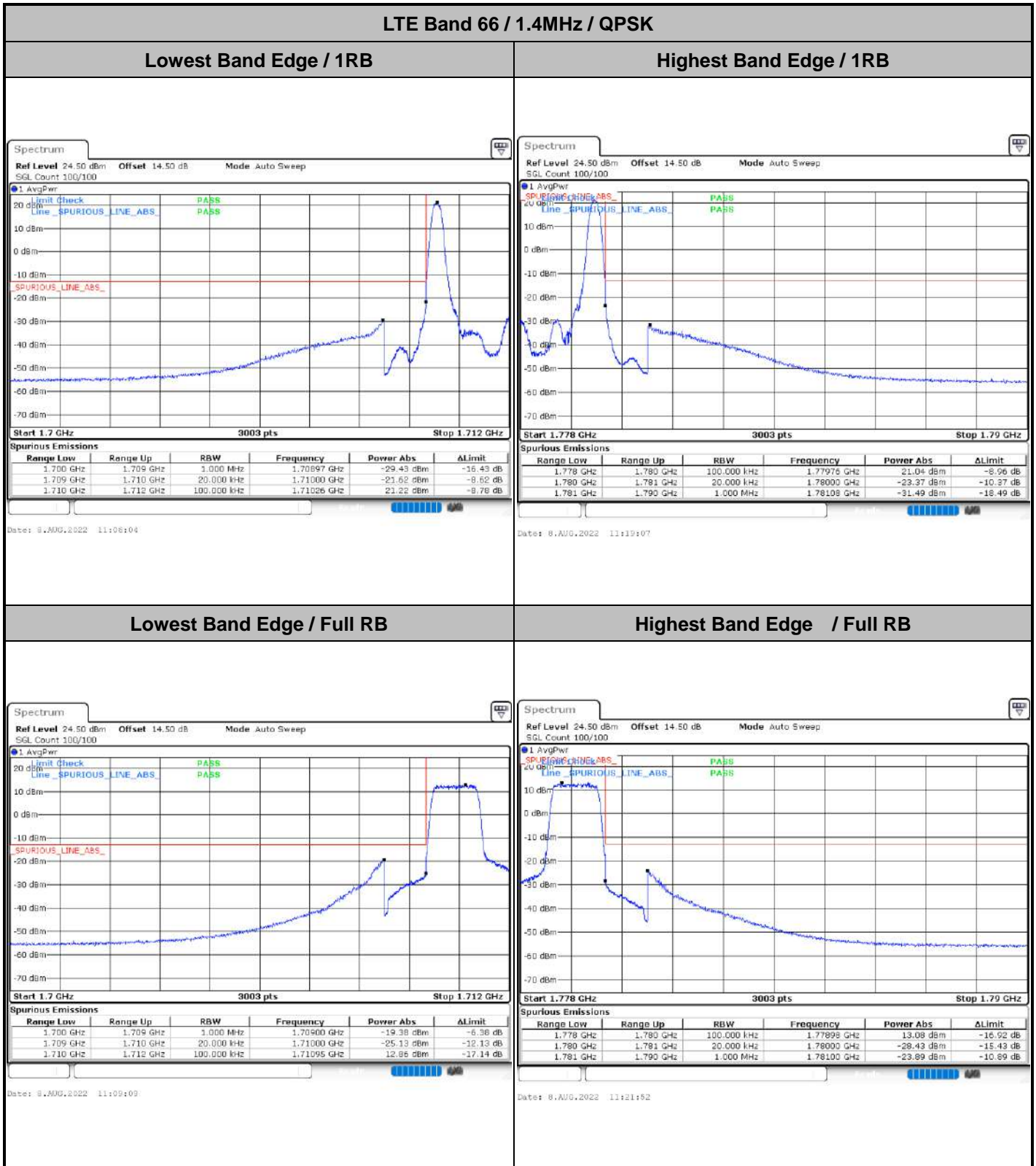



LTE Band 66 / 1.4MHz / 16QAM

Lowest Band Edge / 1 RB

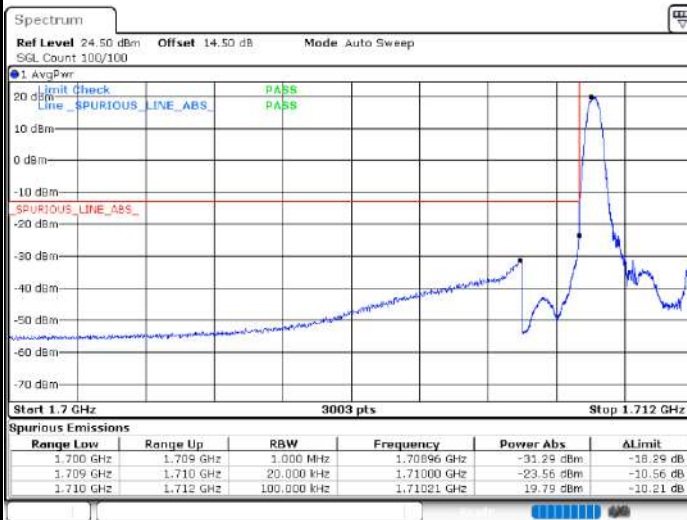

Date: 8.AUG.2022 11:07:36

Highest Band Edge / 1 RB



Date: 8.AUG.2022 11:20:29

Lowest Band Edge / Full RB

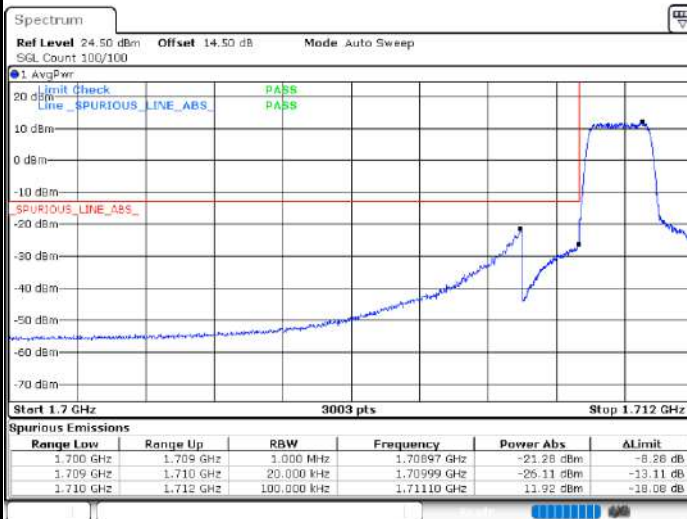

Date: 8.AUG.2022 11:10:41

Highest Band Edge / Full RB



Date: 8.AUG.2022 11:23:15



LTE Band 66 / 3MHz / QPSK

Lowest Band Edge / 1RB

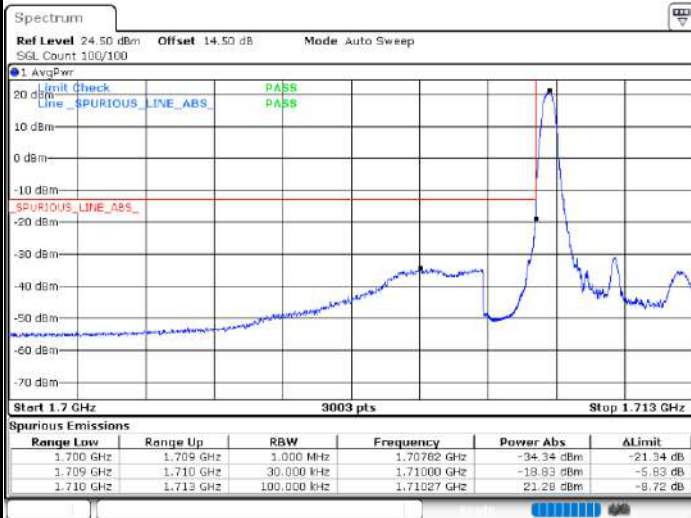

Highest Band Edge / 1 RB

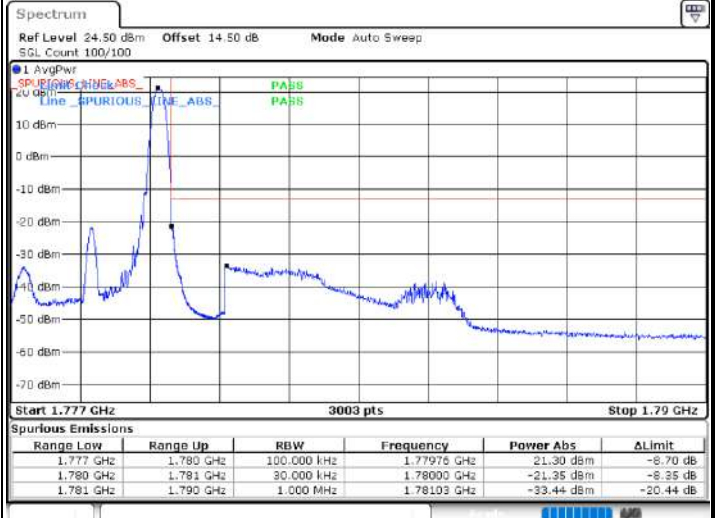

Lowest Band Edge / Full RB

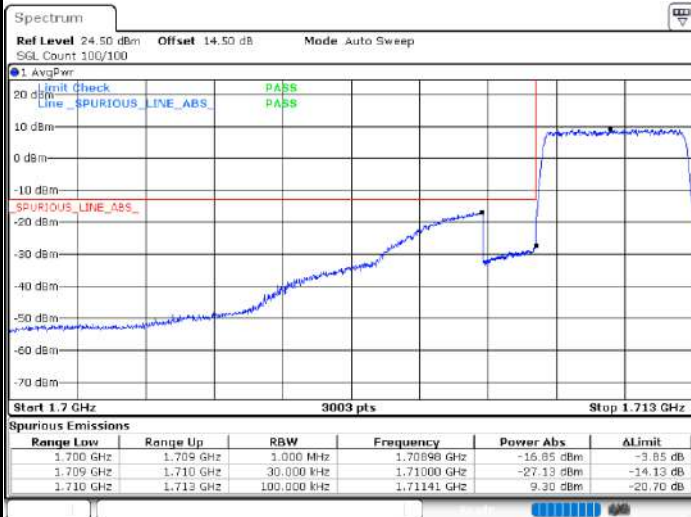

Highest Band Edge / Full RB





LTE Band 66 / 3MHz / 16QAM

Lowest Band Edge / 1 RB

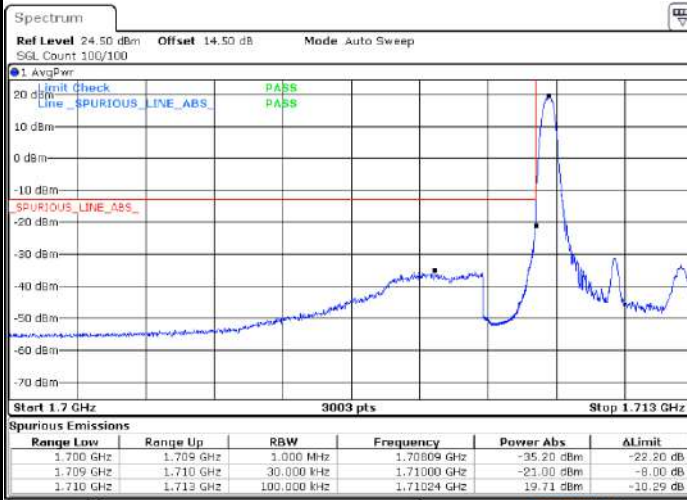

Date: 8.AUG.2022 12:02:41

Highest Band Edge / 1 RB

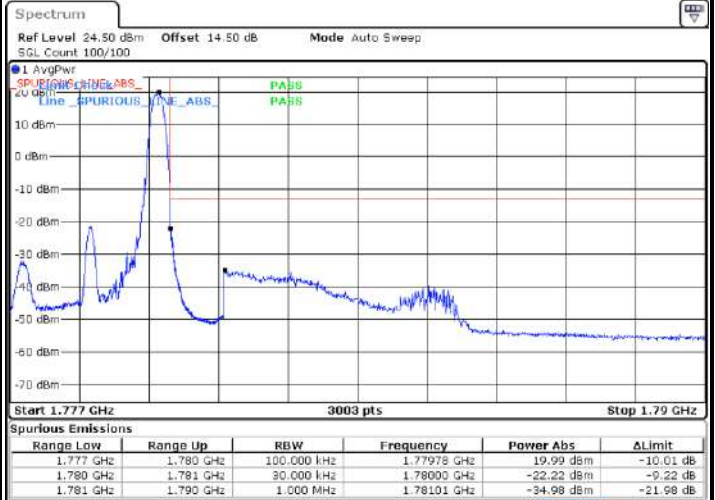

Date: 8.AUG.2022 13:56:17

Lowest Band Edge / Full RB



Date: 8.AUG.2022 12:06:42

Highest Band Edge / Full RB



Date: 8.AUG.2022 13:56:17



LTE Band 66 / 5MHz / QPSK

Lowest Band Edge / 1 RB

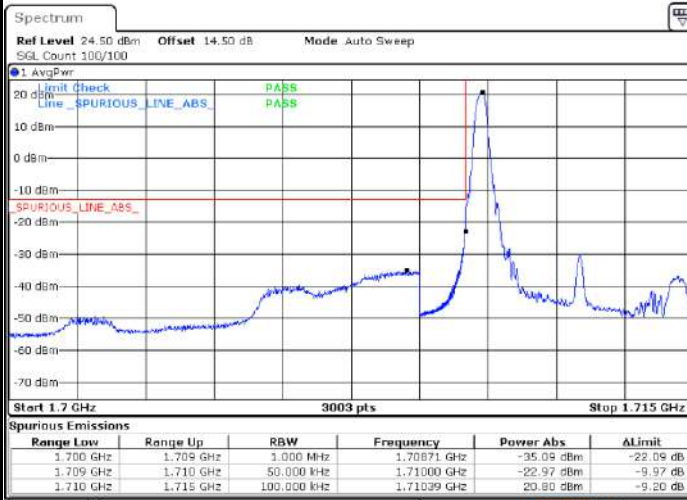

Date: 8.AUG.2022 14:26:05

Highest Band Edge / 1 RB



Date: 8.AUG.2022 14:33:23

Lowest Band Edge / Full RB

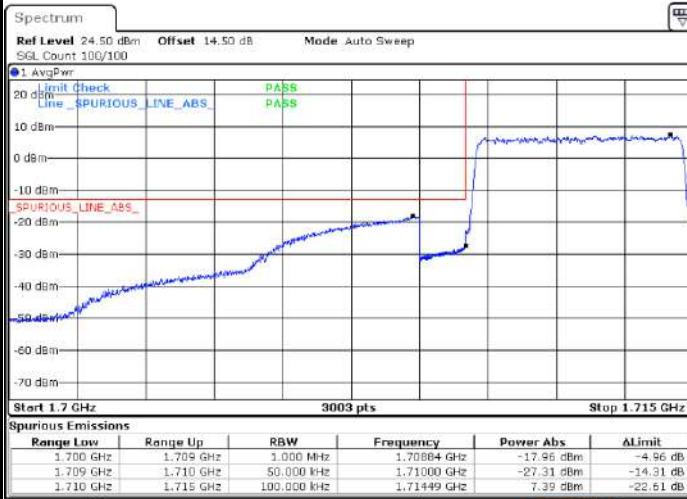

Date: 8.AUG.2022 14:27:35

Highest Band Edge / Full RB



Date: 8.AUG.2022 14:38:53



LTE Band 66 / 5MHz / 16QAM

Lowest Band Edge / 1RB

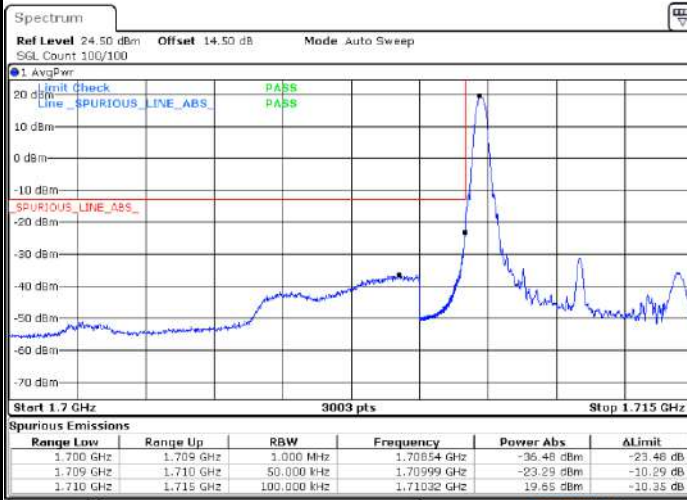

Highest Band Edge / 1 RB



Lowest Band Edge / Full RB



Highest Band Edge / Full RB





LTE Band 66 / 10MHz / QPSK

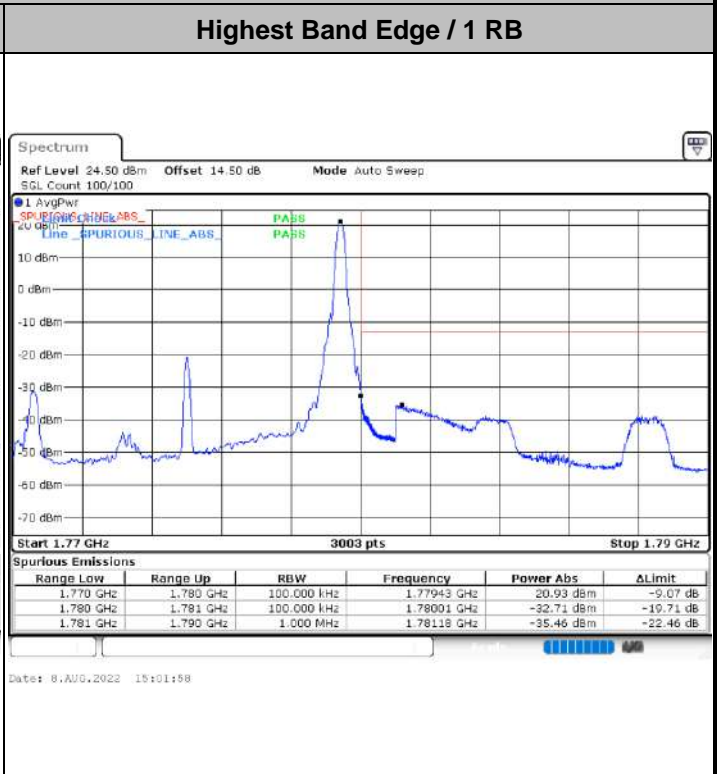
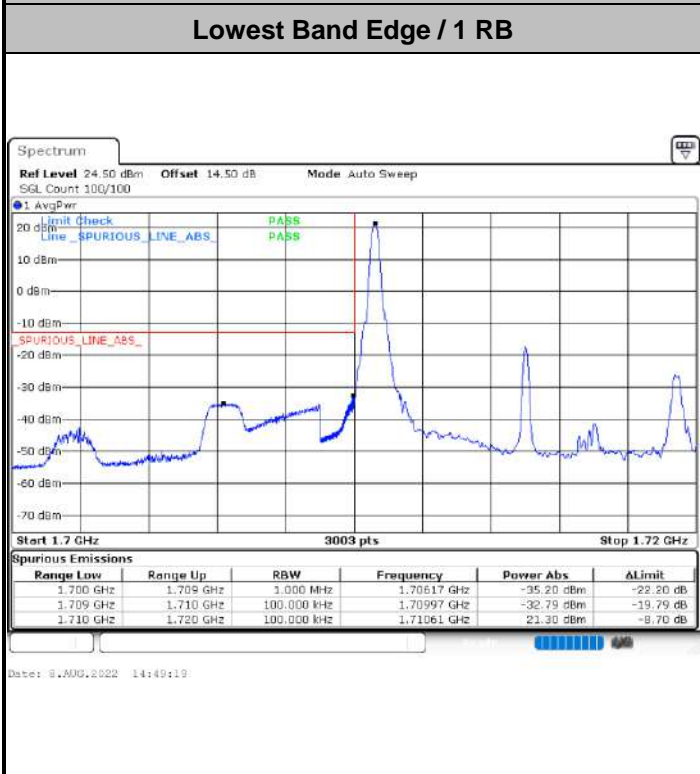



LTE Band 66 / 10MHz / 16QAM

Lowest Band Edge / 1 RB

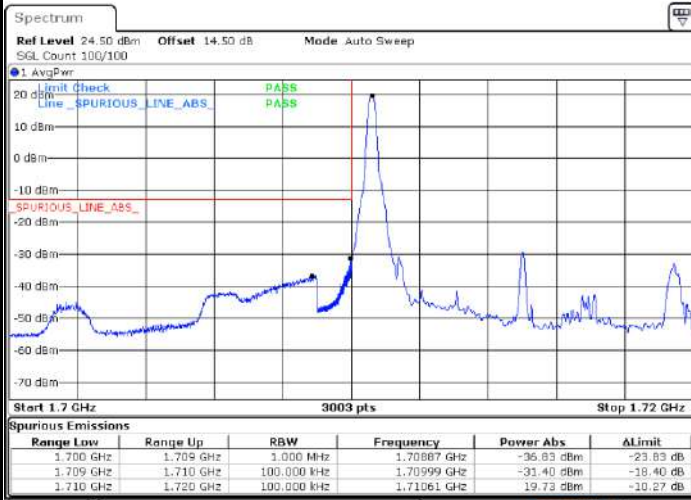

Date: 8.AUG.2022 14:50:04

Highest Band Edge / 1 RB

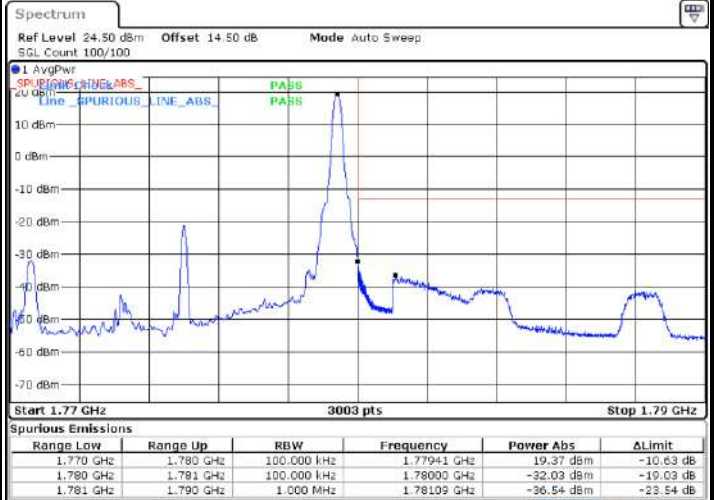

Date: 8.AUG.2022 15:02:42

Lowest Band Edge / Full RB

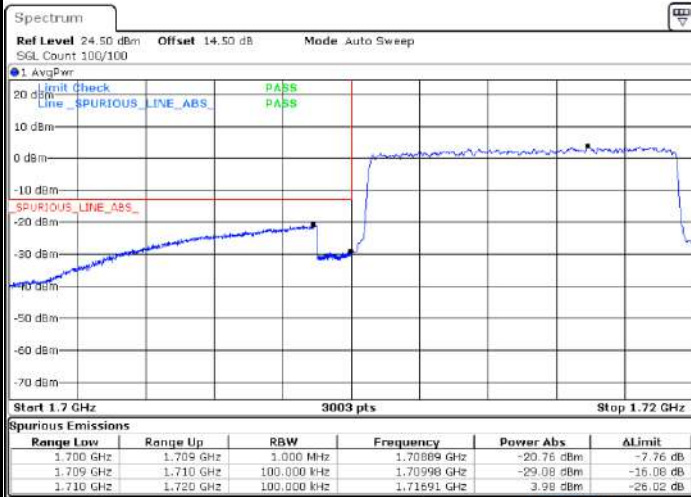

Date: 8.AUG.2022 14:51:34

Highest Band Edge / Full RB



Date: 8.AUG.2022 15:04:13



LTE Band 66 / 15MHz / QPSK

Lowest Band Edge / 1 RB

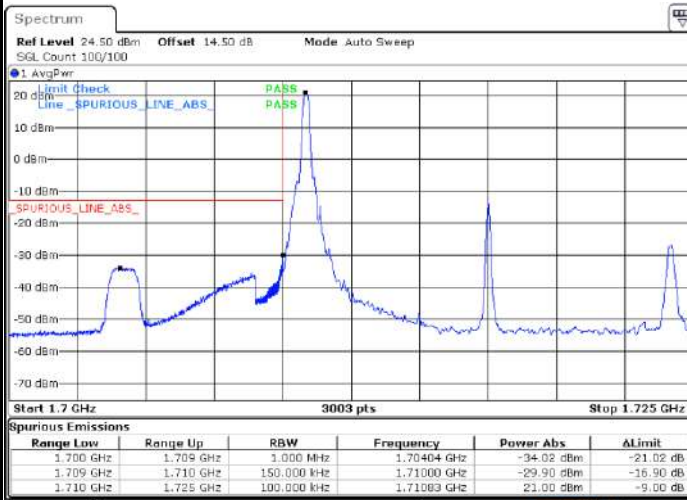

Date: 8.AUG.2022 17:52:03

Highest Band Edge / 1 RB

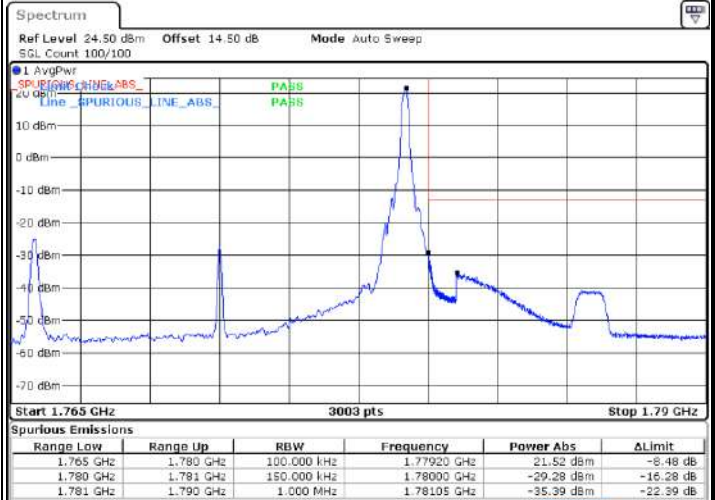

Date: 8.AUG.2022 19:27:05

Lowest Band Edge / Full RB

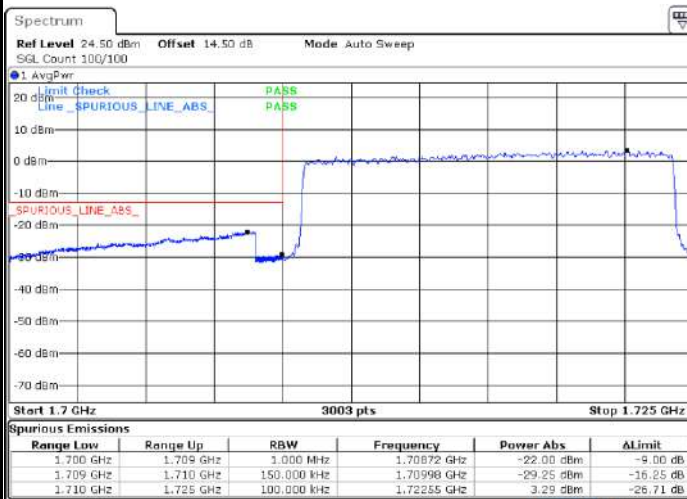

Date: 8.AUG.2022 17:50:34

Highest Band Edge / Full RB

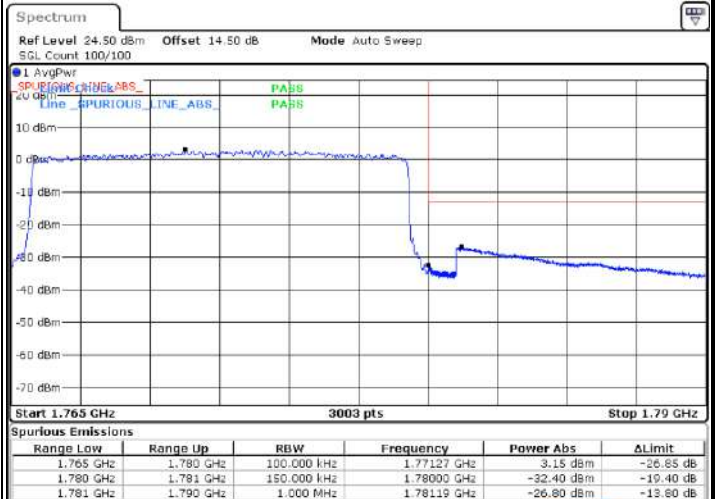

Date: 8.AUG.2022 19:10:56



LTE Band 66 / 15MHz / 16QAM

Lowest Band Edge / 1 RB

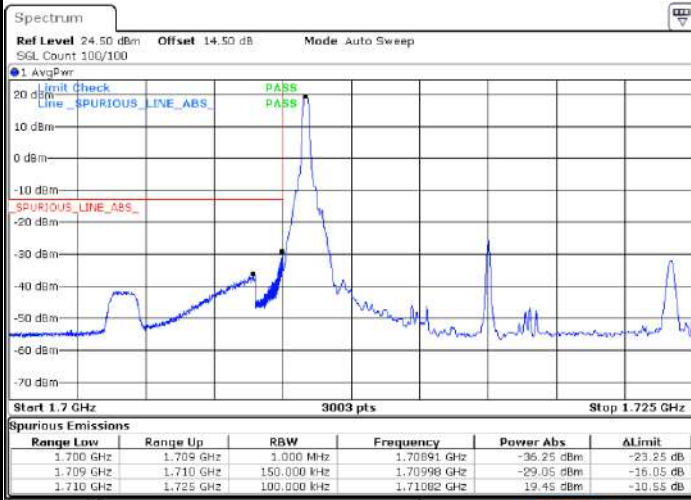

Date: 8.AUG.2022 17:55:24

Highest Band Edge / 1 RB

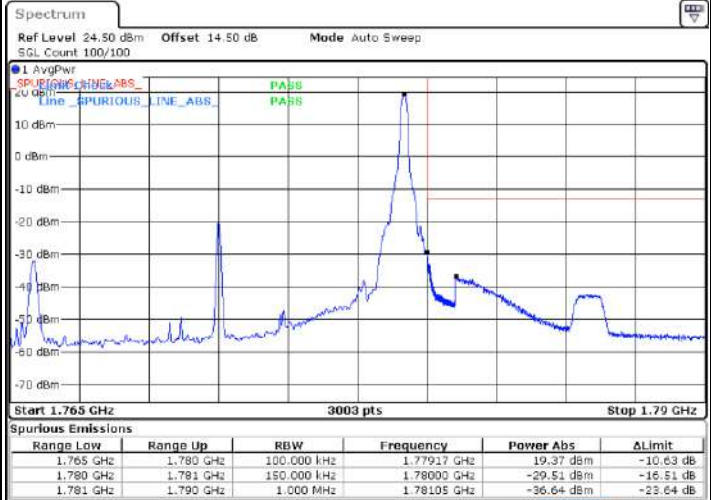

Date: 8.AUG.2022 19:28:34

Lowest Band Edge / Full RB

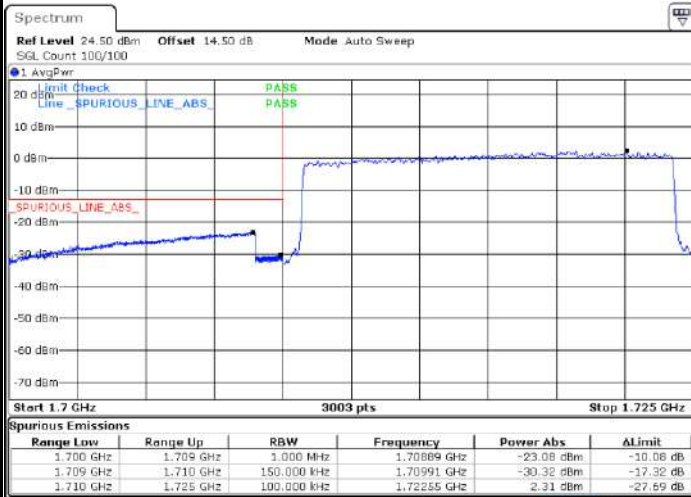

Date: 8.AUG.2022 17:56:57

Highest Band Edge / Full RB

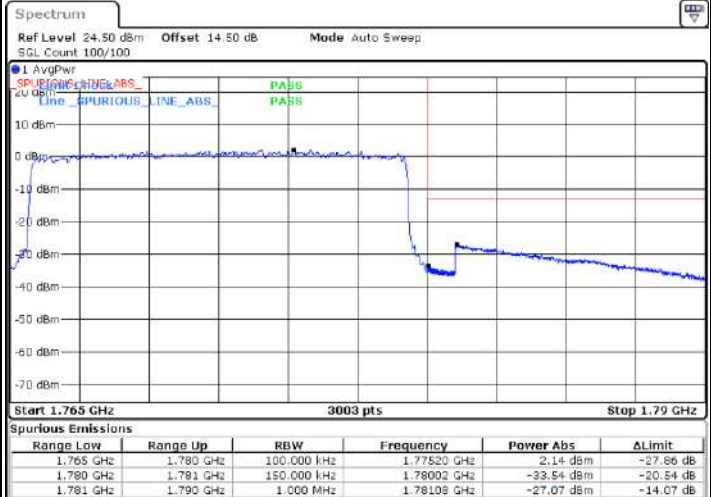

Date: 8.AUG.2022 19:19:25



LTE Band 66 / 20MHz / QPSK

Lowest Band Edge / 1 RB

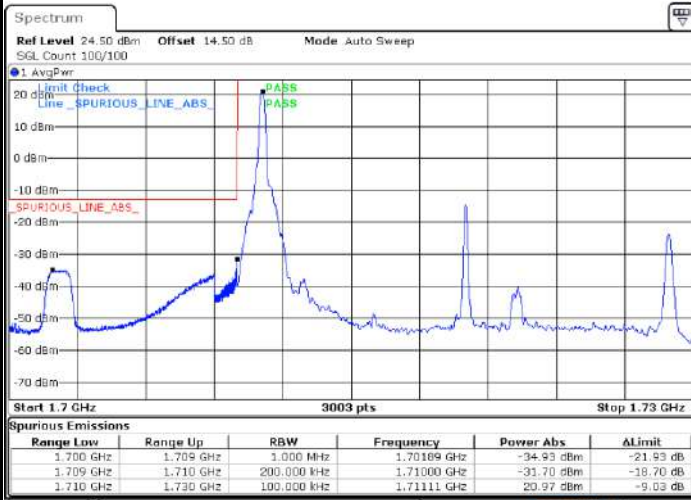

Highest Band Edge / 1 RB

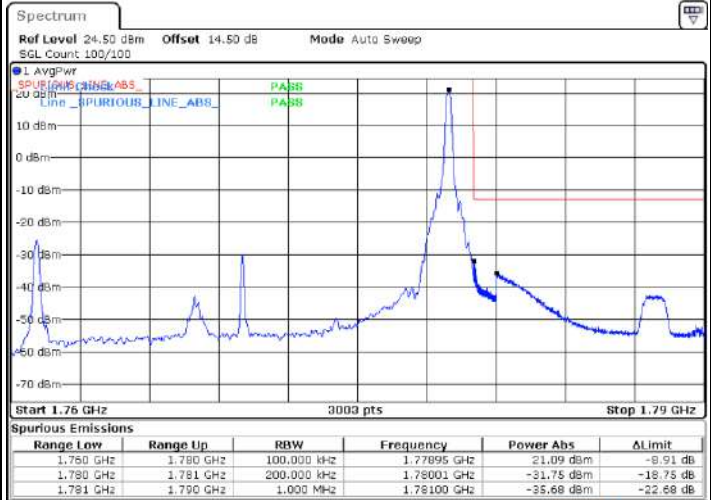

Lowest Band Edge / Full RB

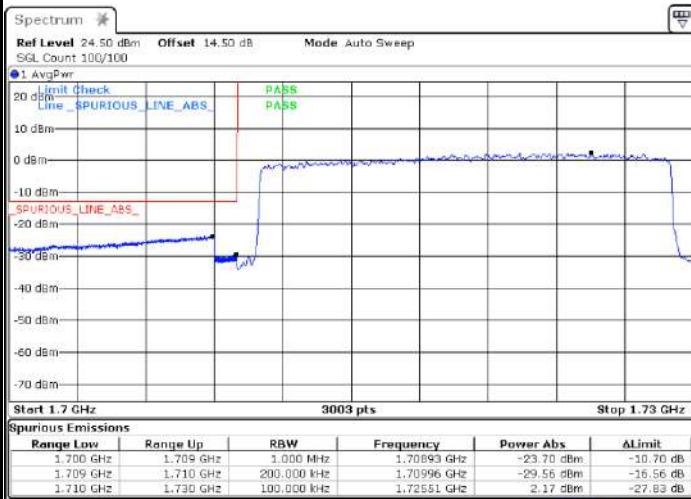

Highest Band Edge / Full RB





LTE Band 66 / 20MHz / 16QAM

Lowest Band Edge / 1 RB

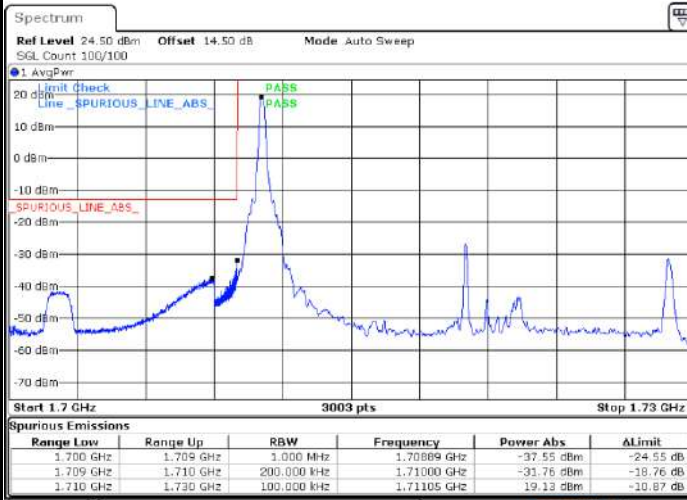

Date: 8.AUG.2022 19:51:59

Highest Band Edge / 1 RB

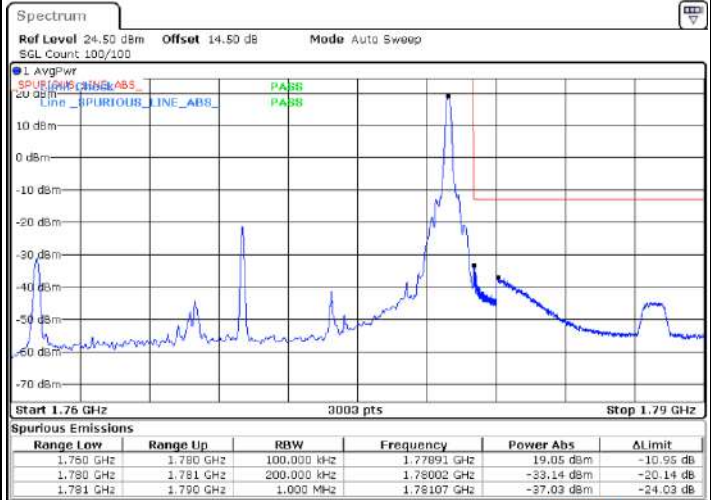

Date: 8.AUG.2022 21:42:12

Lowest Band Edge / Full RB

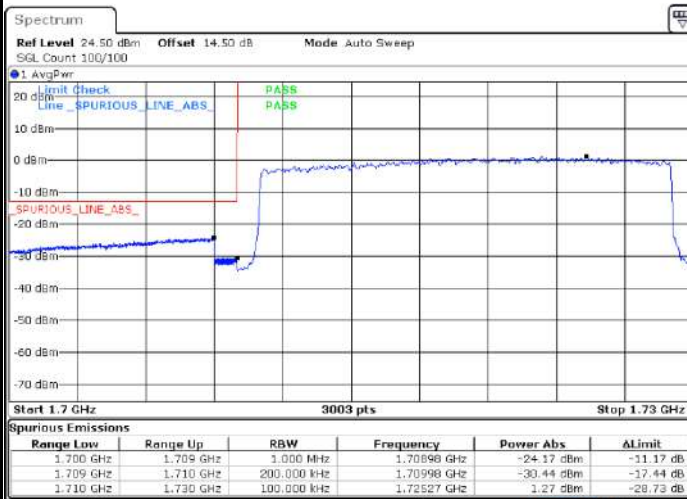

Date: 8.AUG.2022 19:42:26

Highest Band Edge / Full RB

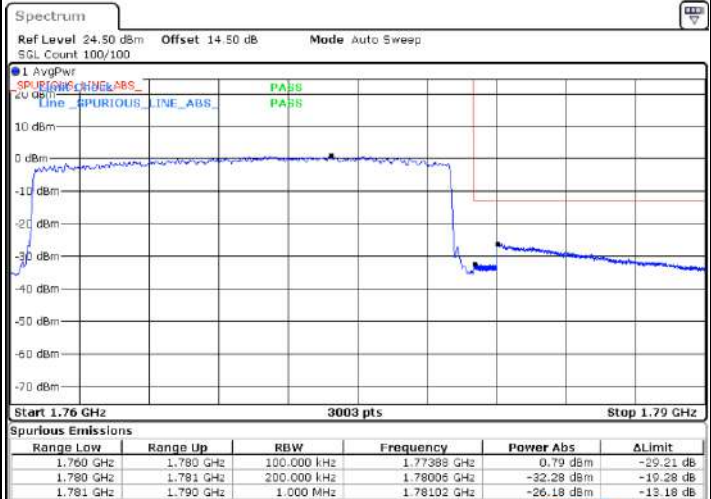

Date: 8.AUG.2022 20:38:51



Conducted Spurious Emission

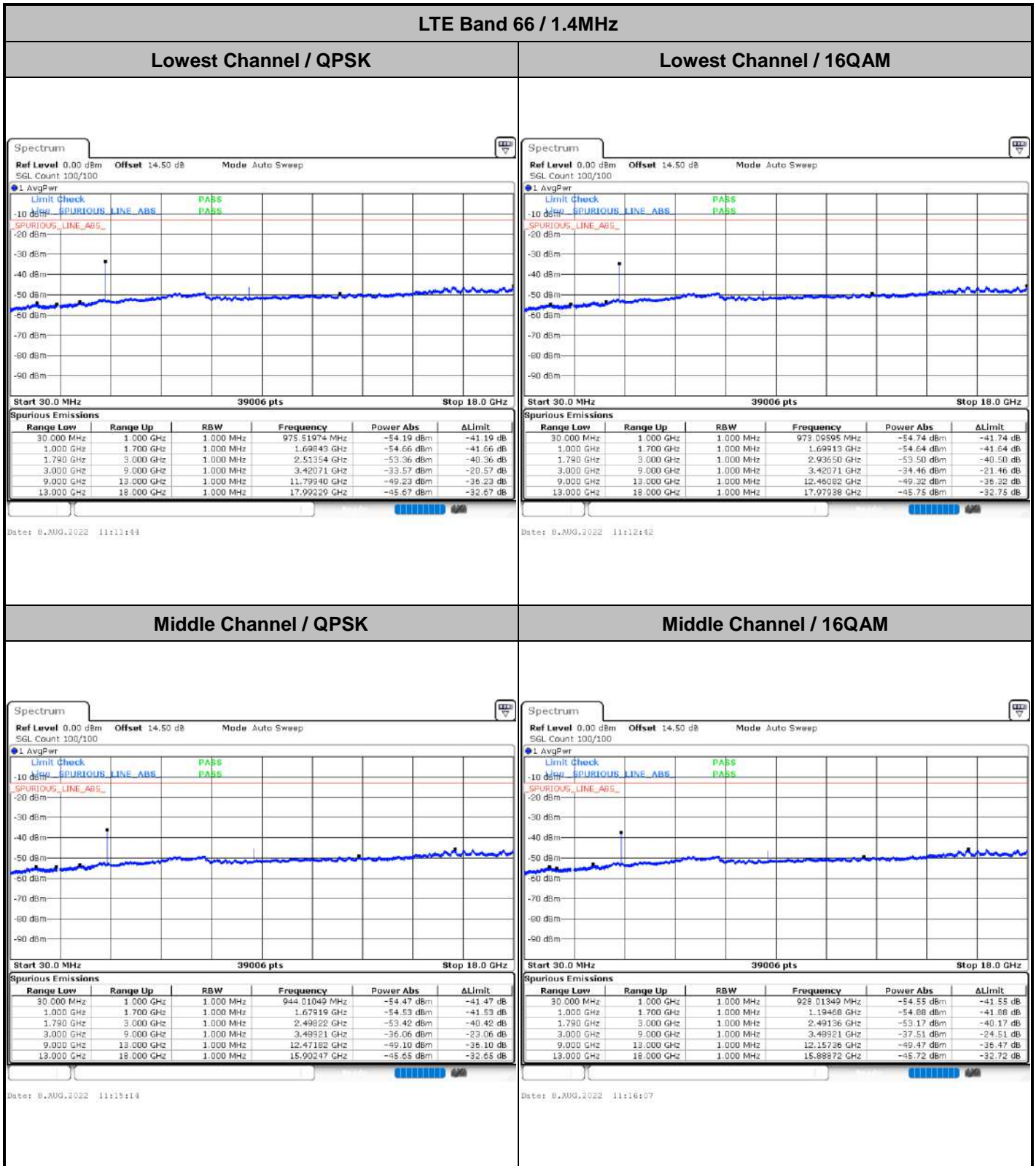



LTE Band 66 / 1.4MHz

Highest Channel / QPSK

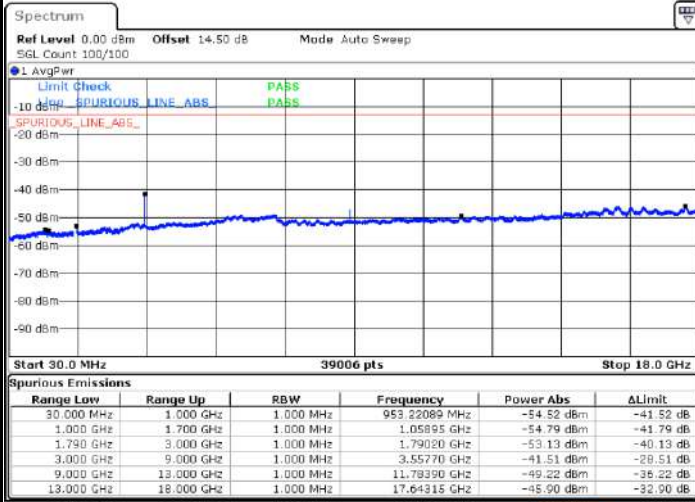

Date: 8.AUG.2022 11:24:07

Highest Channel / 16QAM

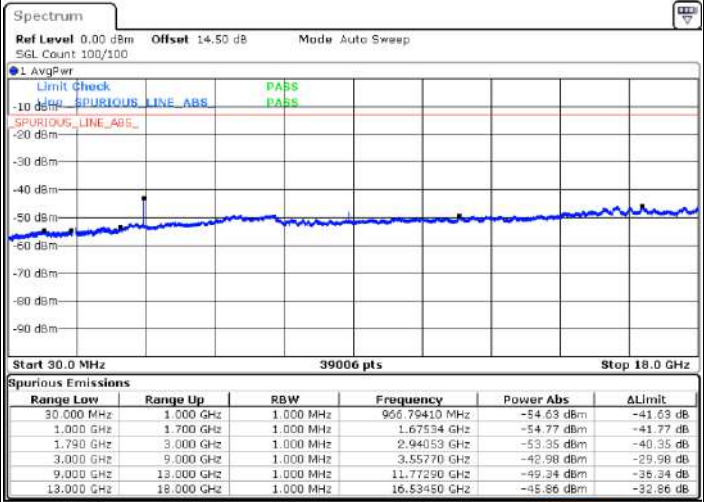

Date: 8.AUG.2022 11:25:00

LTE Band 66 / 3MHz

Lowest Channel / QPSK

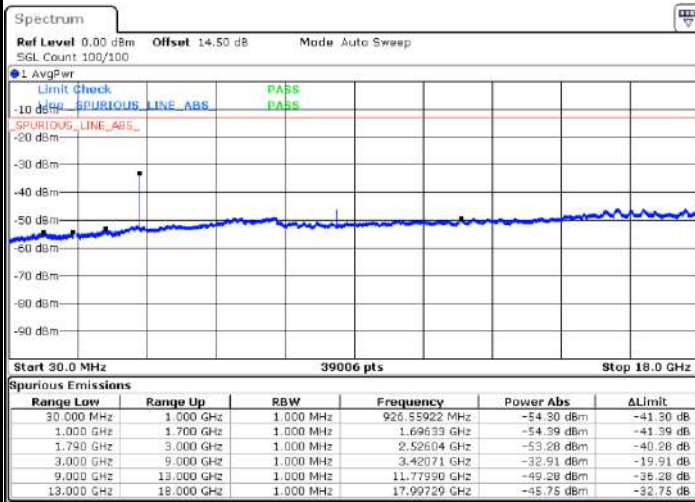

Date: 8.AUG.2022 12:05:32

Lowest Channel / 16QAM

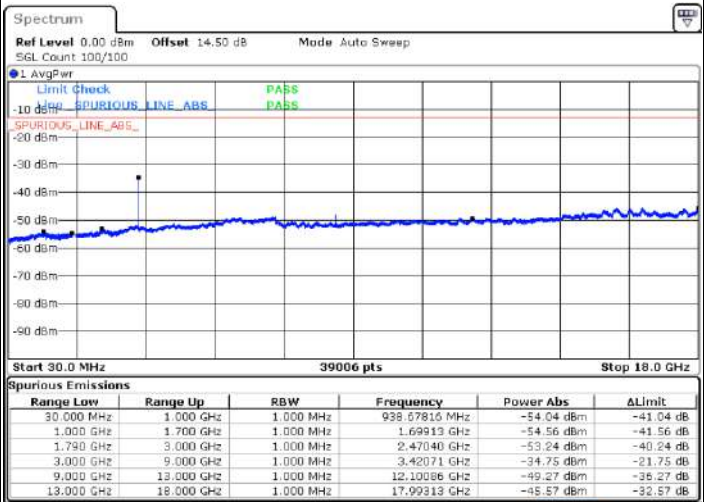

Date: 8.AUG.2022 12:49:39



LTE Band 66 / 3MHz

Middle Channel / QPSK

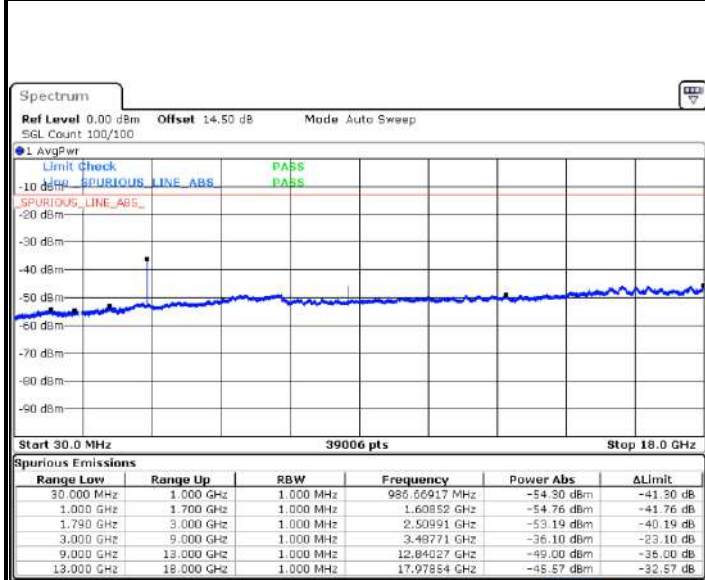

Date: 8.AUG.2022 13:51:58

Middle Channel / 16QAM

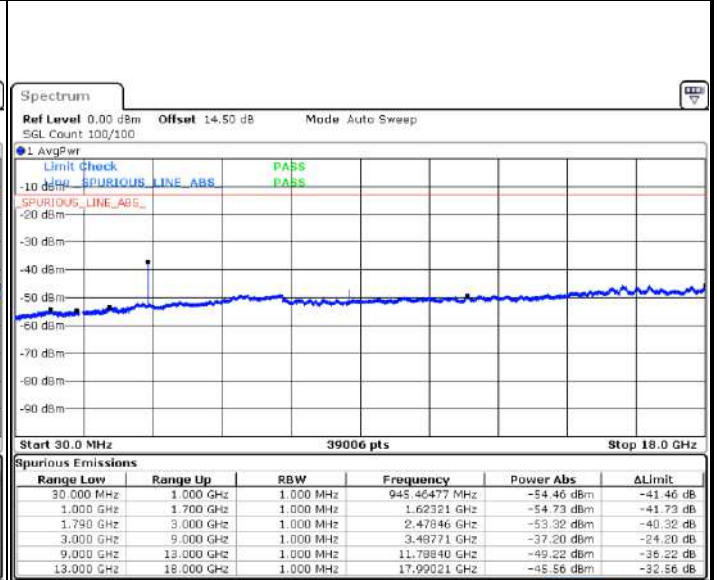

Date: 8.AUG.2022 13:52:49

Highest Channel / QPSK

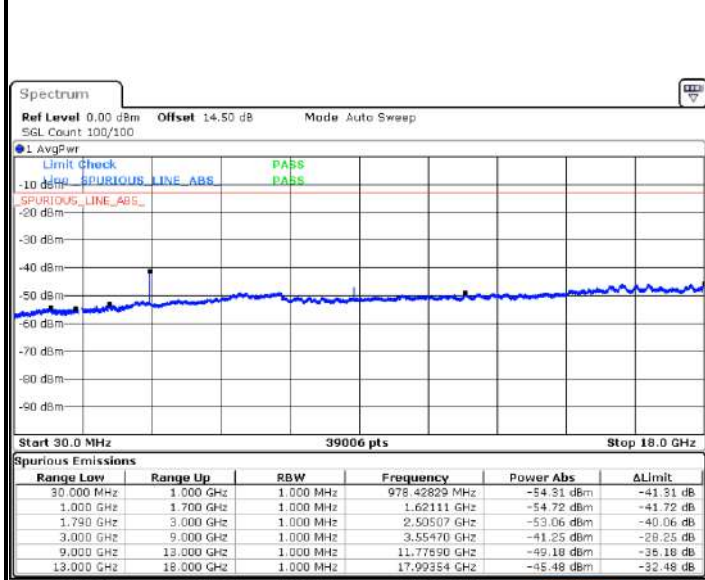

Date: 8.AUG.2022 13:59:07

Highest Channel / 16QAM

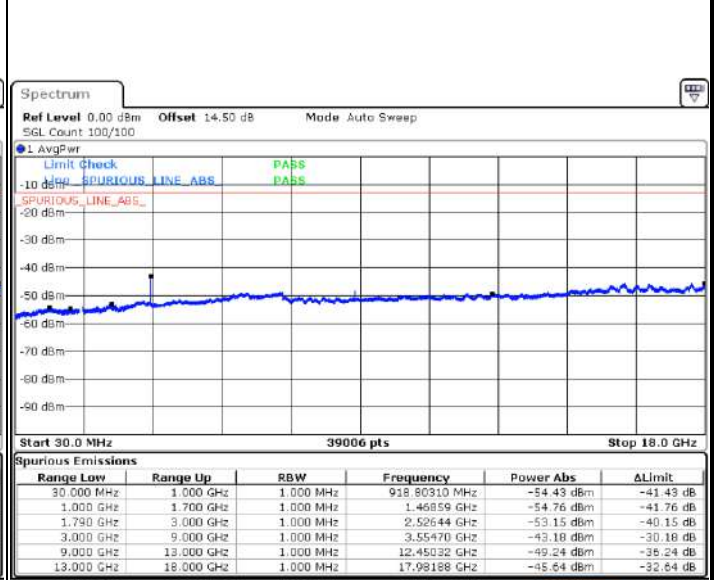

Date: 8.AUG.2022 13:59:58



LTE Band 66 / 5MHz

Lowest Channel / QPSK

Lowest Channel / 16QAM

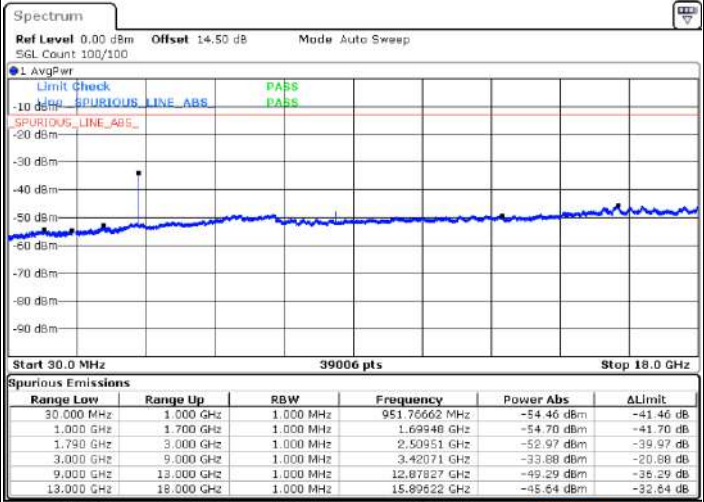
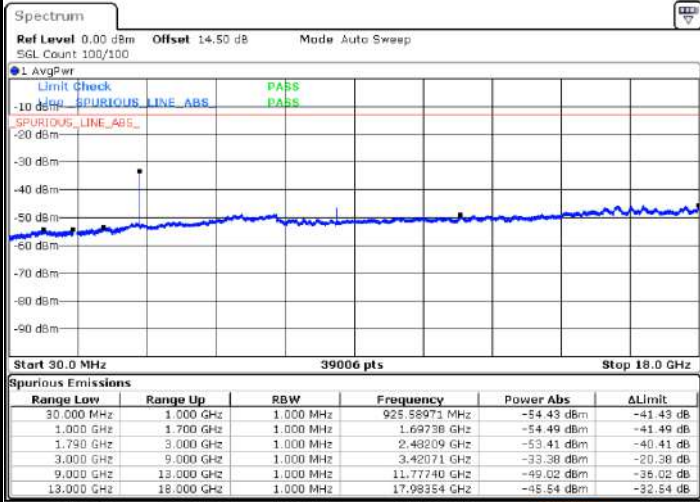

Date: 8.AUG.2022 14:29:19

Date: 8.AUG.2022 14:30:01

Middle Channel / QPSK

Middle Channel / 16QAM

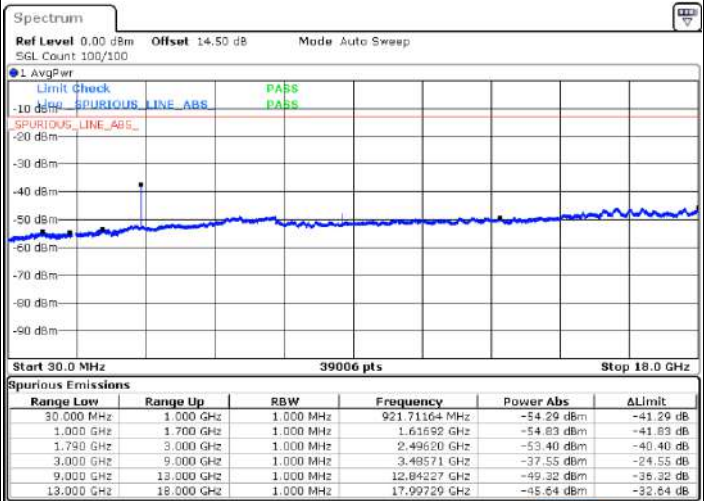
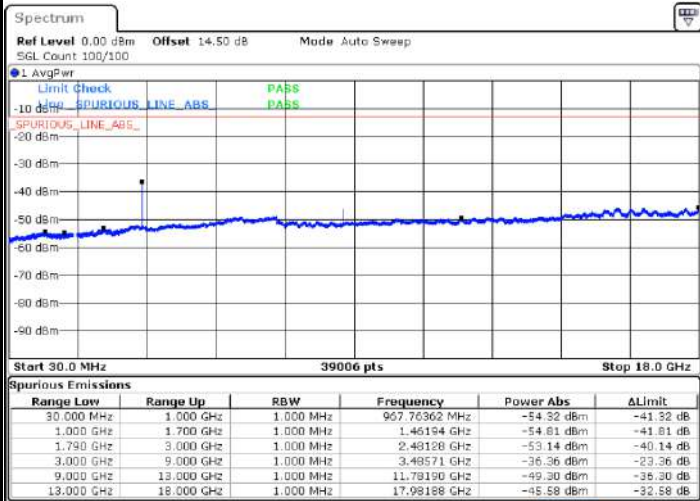

Date: 8.AUG.2022 14:32:19

Date: 8.AUG.2022 14:33:19



LTE Band 66 / 5MHz

Highest Channel / QPSK

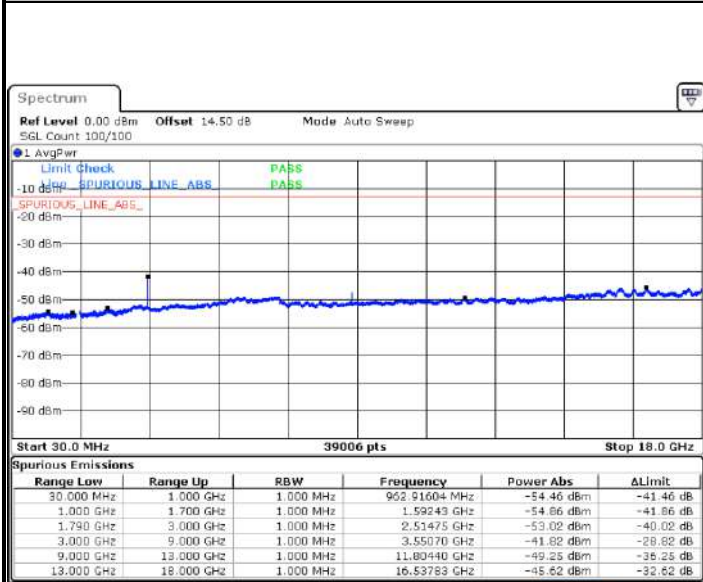

Date: 8.AUG.2022 14:38:28

Highest Channel / 16QAM

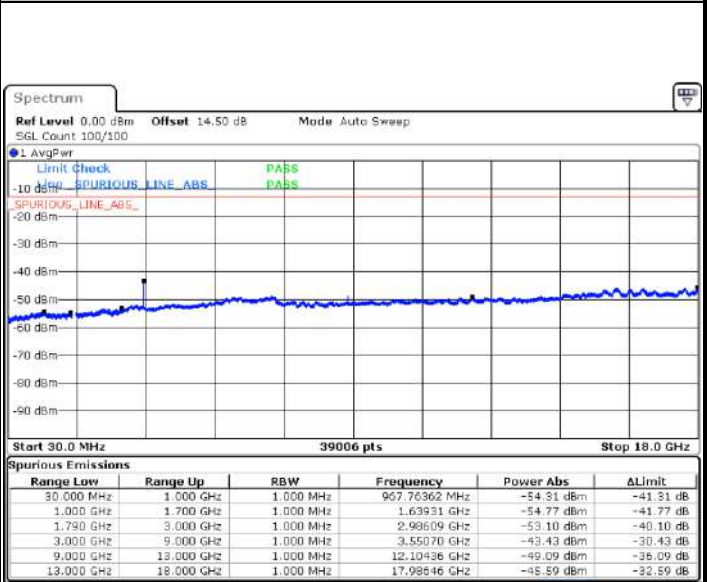

Date: 8.AUG.2022 14:39:18

LTE Band 66 / 10MHz

Lowest Channel / QPSK

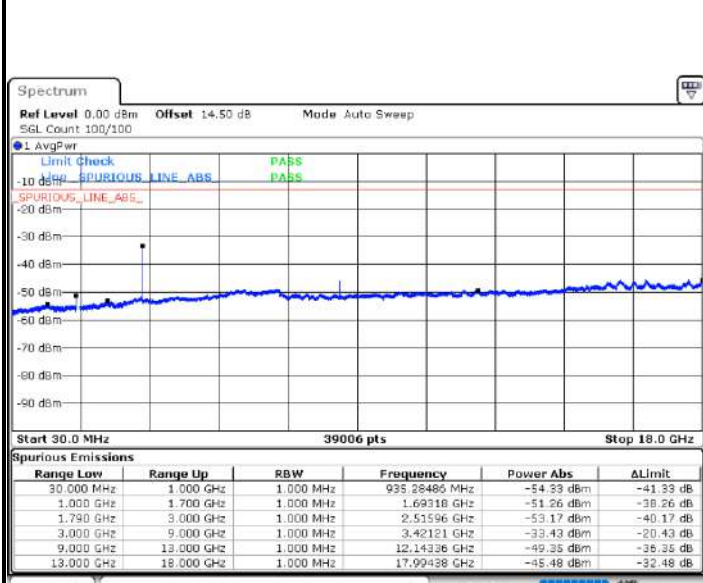

Date: 8.AUG.2022 14:52:24

Lowest Channel / 16QAM

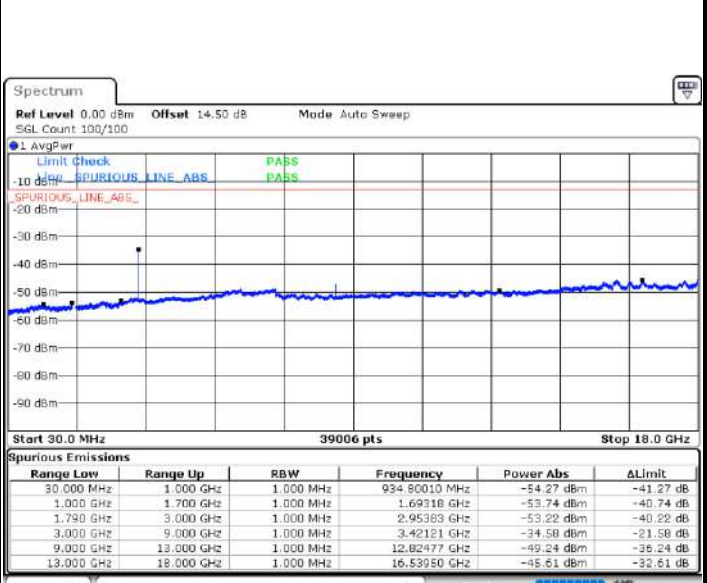

Date: 8.AUG.2022 14:53:15



LTE Band 66 / 10MHz

Middle Channel / QPSK

Middle Channel / 16QAM

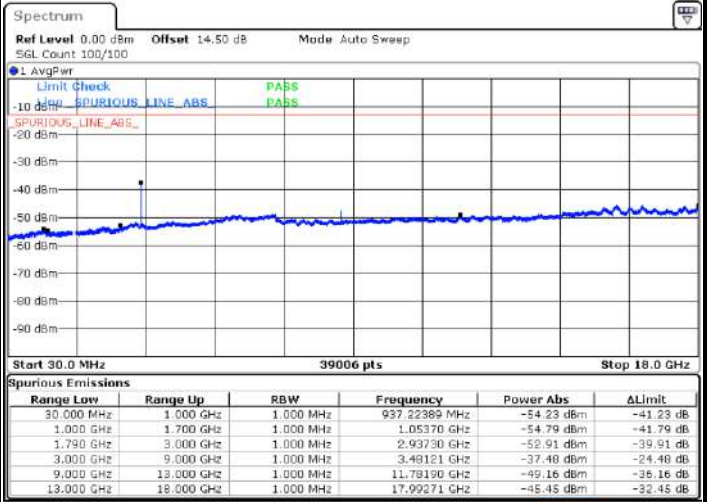
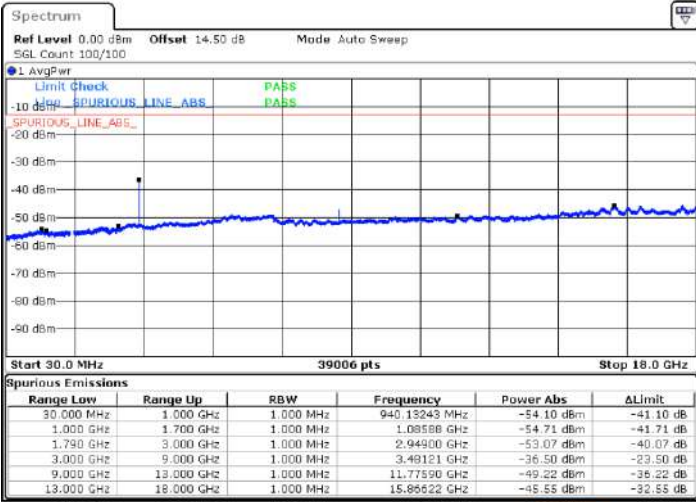

Date: 8.AUG.2022 14:57:21

Date: 8.AUG.2022 14:58:12

Highest Channel / QPSK

Highest Channel / 16QAM

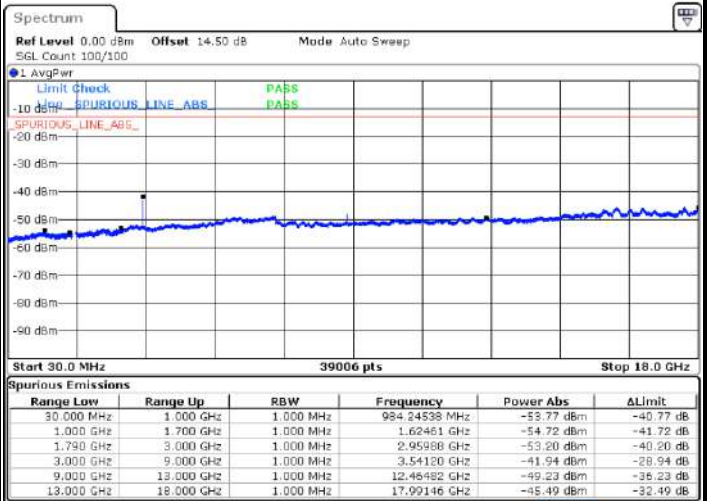
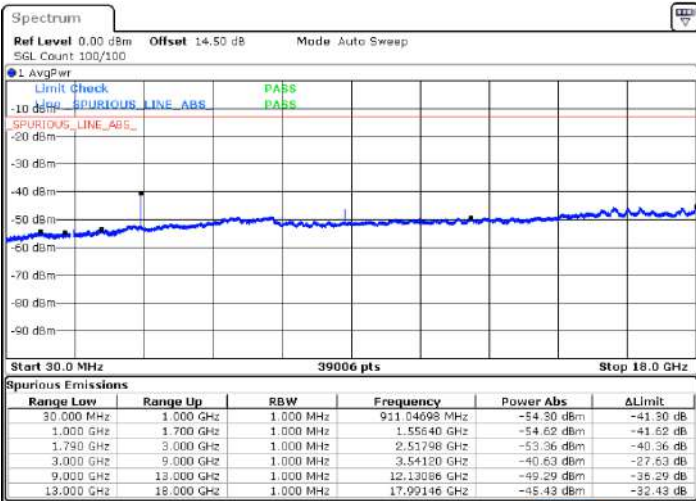

Date: 8.AUG.2022 15:05:03

Date: 8.AUG.2022 15:05:54



LTE Band 66 / 15MHz

Lowest Channel / QPSK

Lowest Channel / 16QAM

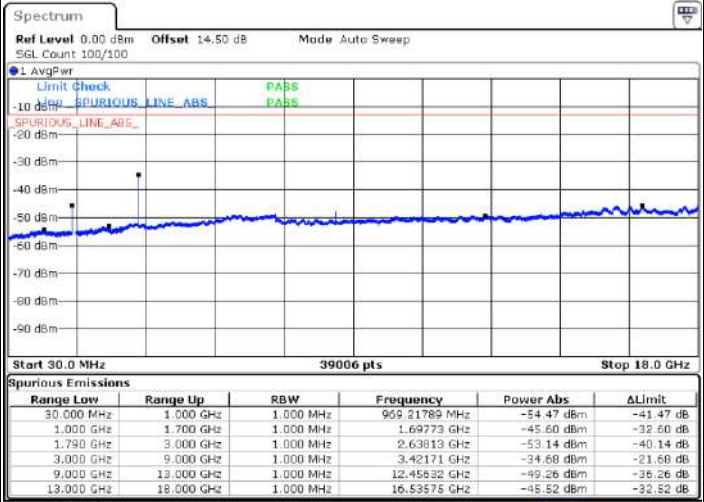
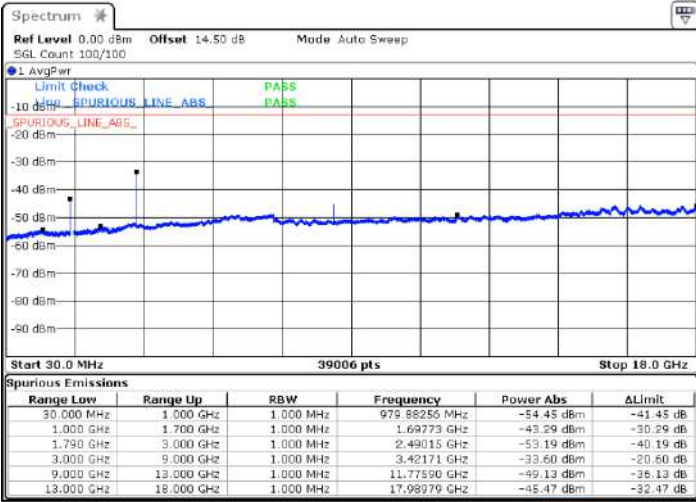

Date: 8.AUG.2022 17:52:34

Date: 8.AUG.2022 17:54:59

Middle Channel / QPSK

Middle Channel / 16QAM

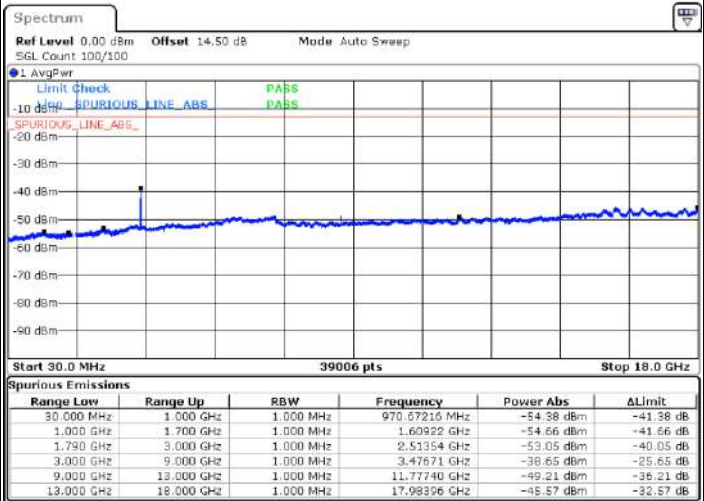
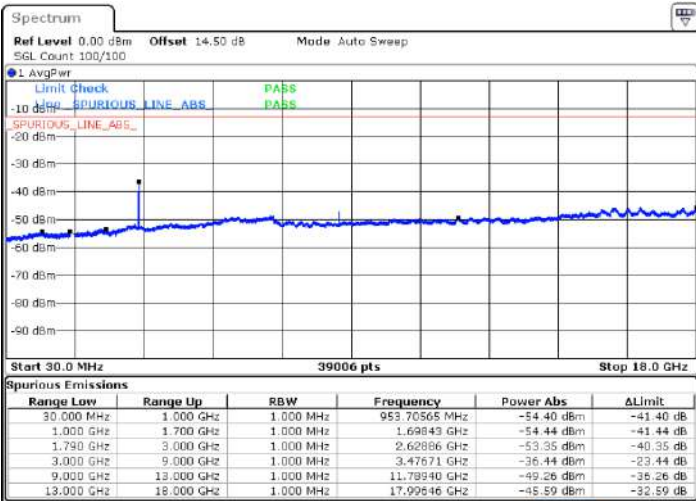

Date: 8.AUG.2022 18:00:47

Date: 8.AUG.2022 19:20:55



LTE Band 66 / 15MHz

Highest Channel / QPSK

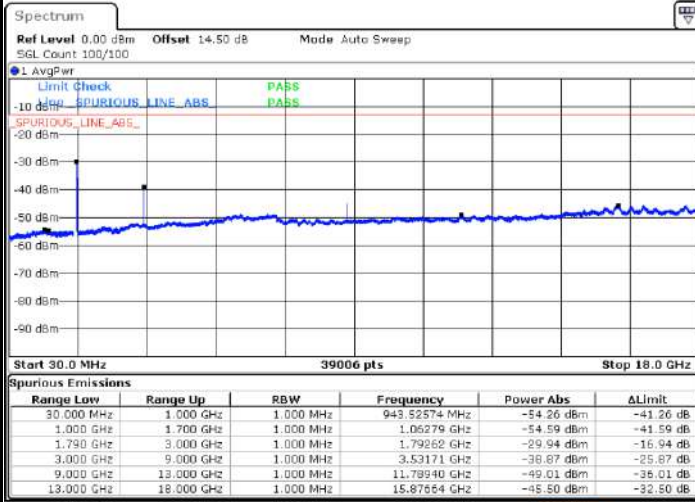

Date: 8.AUG.2022 19:20:47

Highest Channel / 16QAM

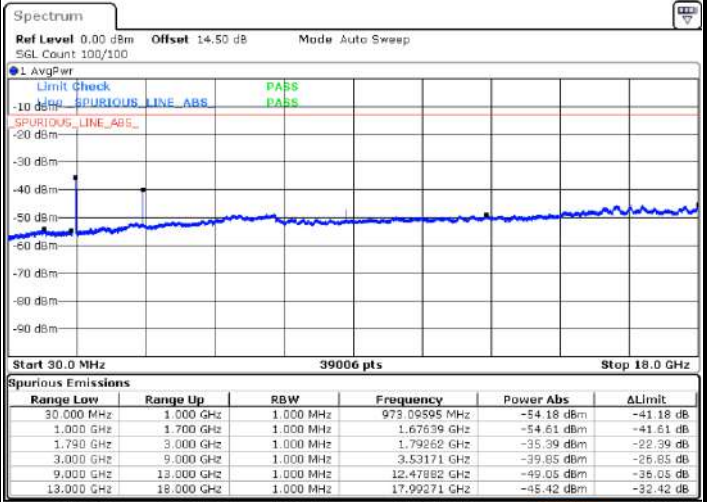

Date: 8.AUG.2022 19:19:51

LTE Band 66 / 20MHz

Lowest Channel / QPSK

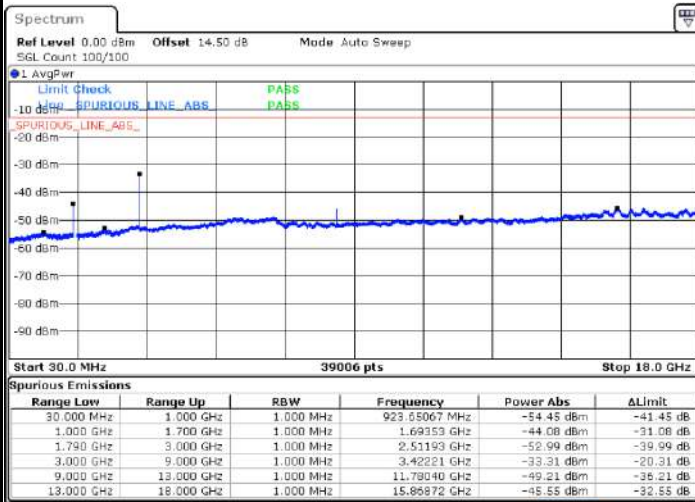

Date: 8.AUG.2022 21:04:05

Lowest Channel / 16QAM

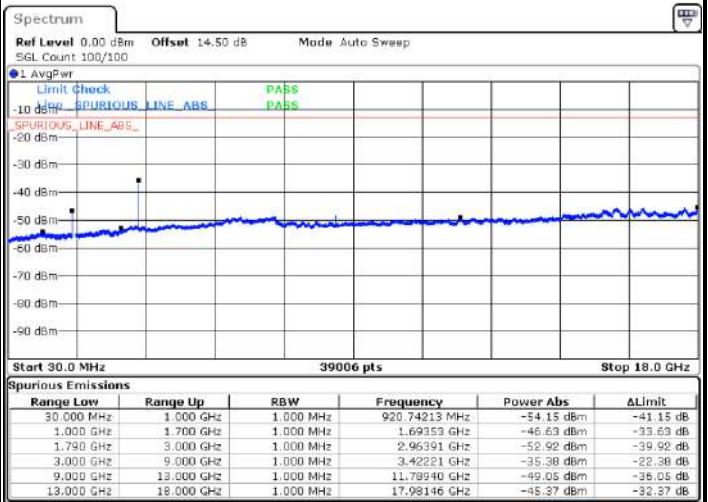

Date: 8.AUG.2022 21:02:56



LTE Band 66 / 20MHz

Middle Channel / QPSK

Middle Channel / 16QAM

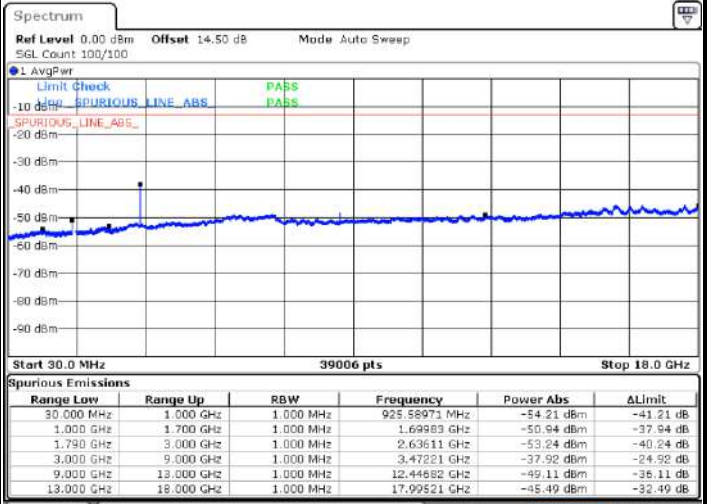
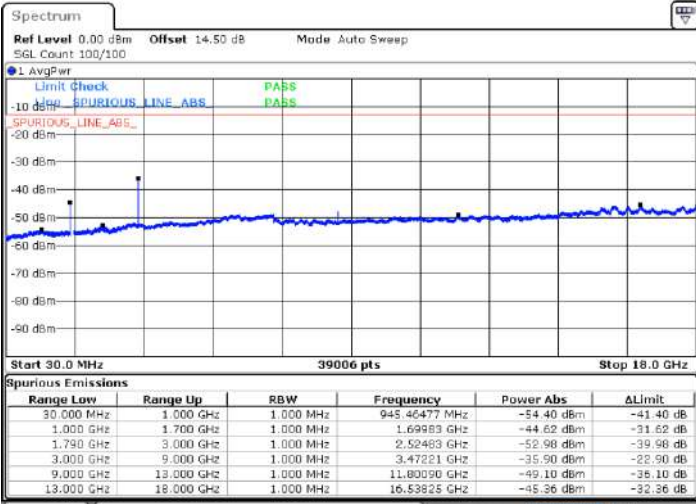

Date: 8.AUG.2022 20:08:20

Date: 8.AUG.2022 20:09:45

Highest Channel / QPSK

Highest Channel / 16QAM

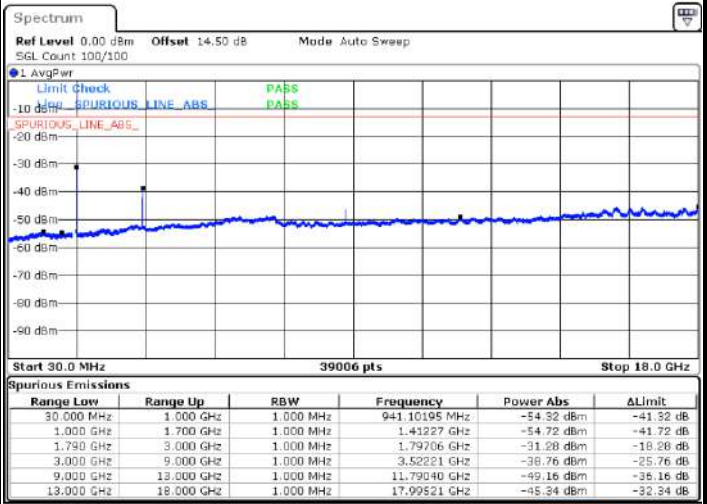
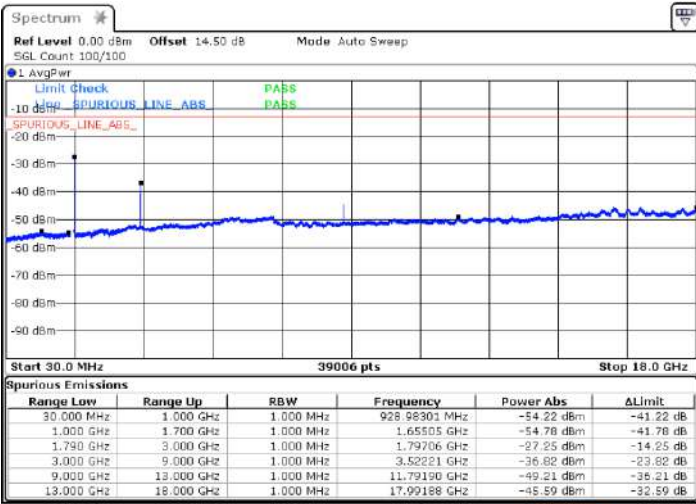

Date: 8.AUG.2022 20:10:20

Date: 8.AUG.2022 20:51:02



Frequency Stability

Test Conditions		LTE Band 66 (QPSK) / Middle Channel	Limit
Temperature (°C)	Voltage (Volt)	BW 10MHz	Note 2.
		Deviation (ppm)	Result
75	Normal Voltage	0.0019	PASS
70	Normal Voltage	0.0015	
60	Normal Voltage	0.0008	
50	Normal Voltage	0.0002	
40	Normal Voltage	0.0001	
30	Normal Voltage	0.0002	
20(Ref.)	Normal Voltage	0.0000	
10	Normal Voltage	0.0001	
0	Normal Voltage	0.0003	
-10	Normal Voltage	0.0001	
-20	Normal Voltage	0.0001	
-30	Normal Voltage	0.0007	
20	Maximum Voltage	0.0005	
20	Normal Voltage	0.0000	
20	End Point Voltage	0.0003	

Note:

1. Normal Voltage =3.8 V. ; End Point (BEP) =3.4 V. ; Maximum Voltage =4.2 V.
2. Note: The frequency fundamental emissions stay within the authorized frequency block.



Appendix B. Test Results of Radiated Test

Radiated Spurious Emission

Test Engineer :	Kuang Jia	Temperature :	22~25°C
		Relative Humidity :	48~52%

LTE Band 66 / 20MHz / QPSK									
Channel	Frequency (MHz)	EIRP (dBm)	Limit (dBm)	Over Limit (dB)	SPA Reading (dBm)	S.G. Power (dBm)	TX Cable loss (dB)	TX Antenna Gain (dBi)	Polarization (H/V)
Middle	3472	-44.48	-13	-31.48	-66.43	-51.33	5.65	12.50	H
	5208	-57.08	-13	-44.08	-81.30	-62.75	7.13	12.80	H
	6944	-55.97	-13	-42.97	-81.68	-59.37	8.40	11.80	H
	3472	-39.10	-13	-26.10	-60.85	-45.95	5.65	12.50	V
	5208	-57.07	-13	-44.07	-81.46	-62.74	7.13	12.80	V
	6944	-55.50	-13	-42.50	-81.94	-58.90	8.40	11.80	V

Remark: Spurious emissions within 30-1000MHz were found more than 20dB below limit line.

Appendix C. Setup Photographs

<Radiated Emission>

LF

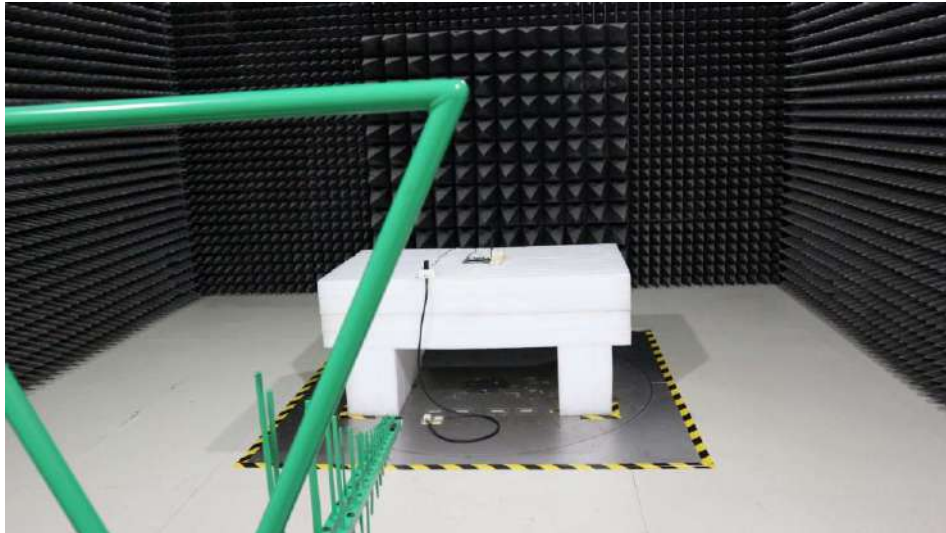

HF

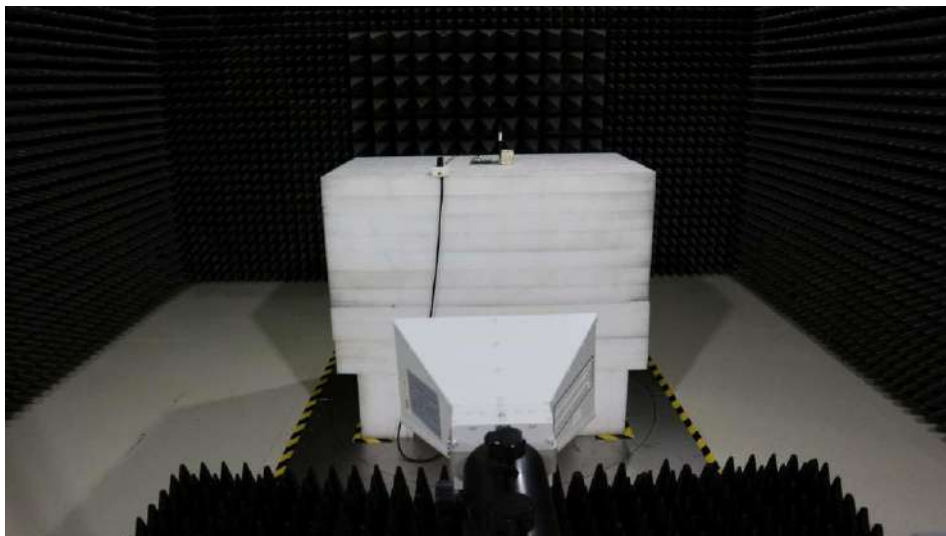



Appendix D. Reference Report

Please refer to Sporton report number FG0D0333B which is issued separately.