

Report No.: SEWA2209000044RG06
 Rev.: 01
 Page: 1 of 85

TEST REPORT

Application No.: SEWA2209000044RG
Applicant: Gosuncn Technology Group Co., Ltd.
Address of Applicant: 6F, 2819 KaiChuang Blvd., Science Town, Huangpu District, Guangzhou City, Guangdong, China.
Manufacturer: Gosuncn Technology Group Co., Ltd.
Address of Manufacturer: 6F, 2819 KaiChuang Blvd., Science Town, Huangpu District, Guangzhou City, Guangdong, China.
EUT Description: Automatic Database Diagnostic Monitor (LTE OBD II Hotspot)
Model No.: GD506
Trade Mark: GOSUNCN
FCC ID: 2APNR-GD506
Standards: FCC 47 CFR Part 2, Subpart J
 FCC 47 CFR Part 15, Subpart E
Date of Receipt: 2022/09/20
Date of Test: 2022/10/08 to 2022/12/29
Date of Issue: 2022/12/29

Test Result :	PASS *
----------------------	---------------

* In the configuration tested, the EUT detailed in this report complied with the standards specified above.

Authorized Signature:



Panta Sun
 Wireless Laboratory Manager



Unless otherwise agreed in writing, this document is issued by the Company subject to its General Conditions of Service printed overleaf, available on request or accessible at <http://www.sgs.com/en/Terms-and-Conditions.aspx> and, for electronic format documents, subject to Terms and Conditions for Electronic Documents at <http://www.sgs.com/en/Terms-and-Conditions/Terms-e-Documents.aspx>. Attention is drawn to the limitation of liability, indemnification and jurisdiction issues defined therein. Any holder of this document is advised that information contained hereon reflects the Company's findings at the time of its intervention only and within the limits of Client's instructions, if any. The Company's sole responsibility is to its Client and this document does not exonerate parties to a transaction from exercising all their rights and obligations under the transaction documents. This document cannot be reproduced except in full, without prior written approval of the Company. Any unauthorized alteration, forgery or falsification of the content or appearance of this document is unlawful and offenders may be prosecuted to the fullest extent of the law. Unless otherwise stated the results shown in this test report refer only to the sample(s) tested and such sample(s) are retained for 30 days only.
Attention: To check the authenticity of testing/inspection report & certificate, please contact us at telephone: (86-755) 8307 1443, or email: CN.Doccheck@sgs.com

South of No. 6 Plant, No. 1, Runsheng Road, Suzhou Industrial Park, Suzhou Area, China (Jiangsu) Pilot Free Trade Zone 215000 t (86-512) 62992980 www.sgs.com.cn
 中国·苏州·中国(江苏)自由贸易试验区苏州片区苏州工业园区润胜路1号的6号厂房南楼 邮编: 215000 t (86-512) 62992980 sgs.china@sgs.com

1 Version

Revision Record				
Version	Chapter	Date	Modifier	Remark
01		2022/12/29		Original

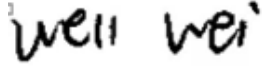
Prepared By		 <hr/> (Ives Cheng) / Test Engineer
Checked By		 <hr/> (Well Wei) / Reviewer



Unless otherwise agreed in writing, this document is issued by the Company subject to its General Conditions of Service printed overleaf, available on request or accessible at <http://www.sgs.com/en/Terms-and-Conditions.aspx> and, for electronic format documents, subject to Terms and Conditions for Electronic Documents at <http://www.sgs.com/en/Terms-and-Conditions/Terms-e-Documents.aspx>. Attention is drawn to the limitation of liability, indemnification and jurisdiction issues defined therein. Any holder of this document is advised that information contained hereon reflects the Company's findings at the time of its intervention only and within the limits of Client's instructions, if any. The Company's sole responsibility is to its Client and this document does not exonerate parties to a transaction from exercising all their rights and obligations under the transaction documents. This document cannot be reproduced except in full, without prior written approval of the Company. Any unauthorized alteration, forgery or falsification of the content or appearance of this document is unlawful and offenders may be prosecuted to the fullest extent of the law. Unless otherwise stated the results shown in this test report refer only to the sample(s) tested and such sample(s) are retained for 30 days only.

Attention: To check the authenticity of testing/inspection report & certificate, please contact us at telephone: (86-755) 8307 1443, or email: CN.Doccheck@sgs.com

South of No. 6 Plant, No. 1, Runsheng Road, Suzhou Industrial Park, Suzhou Area, China (Jiangsu) Pilot Free Trade Zone 215000 t (86-512) 62992980 www.sgs.com.cn
 中国·苏州·中国(江苏)自由贸易试验区苏州片区苏州工业园区润胜路1号的6号厂房南楼 邮编: 215000 t (86-512) 62992980 sgs.china@sgs.com

2 Test Summary

Test Item	Band ^[1]	FCC rules No.	Test Requirements	Test Result	Result																				
Dynamic Frequency Selection	Band II-A Band II-C	15.407	<p>DFS Detection Thresholds:</p> <table border="1"> <thead> <tr> <th>Maximum Transmit Power</th> <th>Value (See Notes 1, 2, and 3)</th> </tr> </thead> <tbody> <tr> <td>EIRP > 200 milliwatt</td> <td>-64 dBm</td> </tr> <tr> <td>EIRP < 200 milliwatt and power spectral density < 10 dBm/MHz</td> <td>-62 dBm</td> </tr> <tr> <td>EIRP < 200 milliwatt that do not meet the power spectral density requirement</td> <td>-64 dBm</td> </tr> </tbody> </table> <p>Note 1: This is the level at the input of the receiver assuming a 0 dBi receive antenna. Note 2: Throughout these test procedures an additional 1 dB has been added to the amplitude of the test transmission waveforms to account for variations in measurement equipment. This will ensure that the test signal is at or above the detection threshold level to trigger a DFS response. Note 3: EIRP is based on the highest antenna gain. For MIMO devices refer to KDB Publication 662911 D01.</p> <p>DFS Response Requirement:</p> <table border="1"> <thead> <tr> <th>Parameter</th> <th>Value</th> </tr> </thead> <tbody> <tr> <td>Non-occupancy period</td> <td>Minimum 30 minutes</td> </tr> <tr> <td>Channel Availability Check Time</td> <td>60 seconds</td> </tr> <tr> <td>Channel Move Time</td> <td>10 seconds See Note 1.</td> </tr> <tr> <td>Channel Closing Transmission Time</td> <td>200 milliseconds + an aggregate of 60 milliseconds over remaining 10 second period. See Notes 1 and 2.</td> </tr> <tr> <td>U-NII Detection Bandwidth</td> <td>Minimum 100% of the U-NII 99% transmission power bandwidth. See Note 3.</td> </tr> </tbody> </table> <p>Note 1: Channel Move Time and the Channel Closing Transmission Time should be performed with Radar Type 0. The measurement timing begins at the end of the Radar Type 0 burst. Note 2: The Channel Closing Transmission Time is comprised of 200 milliseconds starting at the beginning of the Channel Move Time plus any additional intermittent control signals required to facilitate a Channel move (an aggregate of 60 milliseconds) during the remainder of the 10 second period. The aggregate duration of control signals will not count quiet periods in between transmissions. Note 3: During the U-NII Detection Bandwidth detection test, radar type 0 should be used. For each frequency step the minimum percentage of detection is 90 percent. Measurements are performed with no data traffic.</p>	Maximum Transmit Power	Value (See Notes 1, 2, and 3)	EIRP > 200 milliwatt	-64 dBm	EIRP < 200 milliwatt and power spectral density < 10 dBm/MHz	-62 dBm	EIRP < 200 milliwatt that do not meet the power spectral density requirement	-64 dBm	Parameter	Value	Non-occupancy period	Minimum 30 minutes	Channel Availability Check Time	60 seconds	Channel Move Time	10 seconds See Note 1.	Channel Closing Transmission Time	200 milliseconds + an aggregate of 60 milliseconds over remaining 10 second period. See Notes 1 and 2.	U-NII Detection Bandwidth	Minimum 100% of the U-NII 99% transmission power bandwidth. See Note 3.	Clause 4.1	PASS
Maximum Transmit Power	Value (See Notes 1, 2, and 3)																								
EIRP > 200 milliwatt	-64 dBm																								
EIRP < 200 milliwatt and power spectral density < 10 dBm/MHz	-62 dBm																								
EIRP < 200 milliwatt that do not meet the power spectral density requirement	-64 dBm																								
Parameter	Value																								
Non-occupancy period	Minimum 30 minutes																								
Channel Availability Check Time	60 seconds																								
Channel Move Time	10 seconds See Note 1.																								
Channel Closing Transmission Time	200 milliseconds + an aggregate of 60 milliseconds over remaining 10 second period. See Notes 1 and 2.																								
U-NII Detection Bandwidth	Minimum 100% of the U-NII 99% transmission power bandwidth. See Note 3.																								
<p>Note 1: Band II-A: 5250-5350MHz Band II-C: 5470-5725MHz</p>																									



Unless otherwise agreed in writing, this document is issued by the Company subject to its General Conditions of Service printed overleaf, available on request or accessible at <http://www.sgs.com/en/Terms-and-Conditions.aspx> and, for electronic format documents, subject to Terms and Conditions for Electronic Documents at <http://www.sgs.com/en/Terms-and-Conditions/Terms-e-Documents.aspx>. Attention is drawn to the limitation of liability, indemnification and jurisdiction issues defined therein. Any holder of this document is advised that information contained hereon reflects the Company's findings at the time of its intervention only and within the limits of Client's instructions, if any. The Company's sole responsibility is to its Client and this document does not exonerate parties to a transaction from exercising all their rights and obligations under the transaction documents. This document cannot be reproduced except in full, without prior written approval of the Company. Any unauthorized alteration, forgery or falsification of the content or appearance of this document is unlawful and offenders may be prosecuted to the fullest extent of the law. Unless otherwise stated the results shown in this test report refer only to the sample(s) tested and such sample(s) are retained for 30 days only.

Attention: To check the authenticity of testing/inspection report & certificate, please contact us at telephone: (86-755) 8307 1443, or email: CN.Doccheck@sgs.com

Contents

1	Version	2
2	Test Summary	3
3	General Information	5
3.1	Details of Client	5
3.2	Test Location	5
3.3	Test Facility	5
3.4	General Description of EUT	6
3.5	Test Environment and Mode	8
3.6	Description of Support Units	8
3.7	Worst-case configuration and mode	8
4	Test results and Measurement Data	9
4.1	Dynamic Frequency Selection	9
4.1.1	DFS Measurement Configuration	9
4.1.2	DFS Threshold level	9
4.1.3	Power-on cycle	9
4.1.4	User Access Restrctions	9
4.1.5	Channel Loading/Data Streaming	9
4.1.6	Conducted Setup of Calibration of DFS Detection Threshold Level	10
4.1.7	Test Setup	10
4.1.8	Applicability of DFS Requirements Prior to Use of a Cahannel	11
4.1.9	Applicability of DFS Requirements During Normal Operation	11
4.1.10	DFS Detection Thresholds	12
4.1.11	Response Requirements	12
4.1.12	Short Pulse Radar Test Waveforms	13
4.1.13	Long Pulse Radar Test Waveform	15
4.1.14	Frequency Hopping Radar Test Waveform	15
5	Measurement Uncertainty (95% confidence levels, k=2)	16
6	Equipment List	17
7	Photographs - Setup Photos	18



Unless otherwise agreed in writing, this document is issued by the Company subject to its General Conditions of Service printed overleaf, available on request or accessible at <http://www.sgs.com/en/Terms-and-Conditions.aspx> and, for electronic format documents, subject to Terms and Conditions for Electronic Documents at <http://www.sgs.com/en/Terms-and-Conditions/Terms-e-Documents.aspx>. Attention is drawn to the limitation of liability, indemnification and jurisdiction issues defined therein. Any holder of this document is advised that information contained hereon reflects the Company's findings at the time of its intervention only and within the limits of Client's instructions, if any. The Company's sole responsibility is to its Client and this document does not exonerate parties to a transaction from exercising all their rights and obligations under the transaction documents. This document cannot be reproduced except in full, without prior written approval of the Company. Any unauthorized alteration, forgery or falsification of the content or appearance of this document is unlawful and offenders may be prosecuted to the fullest extent of the law. Unless otherwise stated the results shown in this test report refer only to the sample(s) tested and such sample(s) are retained for 30 days only.

Attention: To check the authenticity of testing/inspection report & certificate, please contact us at telephone: (86-755) 8307 1443, or email: CN.Doccheck@sgs.com

South of No. 6 Plant, No. 1, Runsheng Road, Suzhou Industrial Park, Suzhou Area, China (Jiangsu) Pilot Free Trade Zone 215000 t (86-512) 62992980 www.sgsgroup.com.cn
 中国·苏州·中国(江苏)自由贸易试验区苏州片区苏州工业园区润胜路1号的6号厂房南楼 邮编: 215000 t (86-512) 62992980 sgs.china@sgs.com

3 General Information

3.1 Details of Client

Applicant:	Gosuncn Technology Group Co., Ltd.
Address of Applicant:	6F, 2819 KaiChuang Blvd., Science Town, Huangpu District, Guangzhou City, Guangdong, China.
Manufacturer:	Gosuncn Technology Group Co., Ltd.
Address of Manufacturer:	6F, 2819 KaiChuang Blvd., Science Town, Huangpu District, Guangzhou City, Guangdong, China.

3.2 Test Location

Company:	SGS-CSTC Standards Technical Services (Suzhou) Co., Ltd.
Address:	South of No. 6 Plant, No. 1, Runsheng Road, Suzhou Industrial Park, Suzhou Area, China (Jiangsu) Pilot Free Trade Zone
Post code:	215000
Test engineer:	Ives Cheng

3.3 Test Facility

The test facility is recognized, certified, or accredited by the following organizations:

• **A2LA (Certificate No. 6336.01)**

SGS-CSTC STANDARDS TECHNICAL SERVICES (SUZHOU) CO., LTD. is accredited by the American Association for Laboratory Accreditation(A2LA). Certificate No. 6336.01.

• **Innovation, Science and Economic Development Canada**

SGS-CSTC STANDARDS TECHNICAL SERVICES (SUZHOU) CO., LTD. has been recognized by ISED as an accredited testing laboratory.

CAB identifier: CN0120.

IC#: 27594.

• **FCC –Designation Number: CN1312**

SGS-CSTC STANDARDS TECHNICAL SERVICES (SUZHOU) CO., LTD. has been recognized as an accredited testing laboratory.

Designation Number: CN1312.

Test Firm Registration Number: 717327



Unless otherwise agreed in writing, this document is issued by the Company subject to its General Conditions of Service printed overleaf, available on request or accessible at <http://www.sgs.com/en/Terms-and-Conditions.aspx> and, for electronic format documents, subject to Terms and Conditions for Electronic Documents at <http://www.sgs.com/en/Terms-and-Conditions/Terms-e-Documents.aspx>. Attention is drawn to the limitation of liability, indemnification and jurisdiction issues defined therein. Any holder of this document is advised that information contained hereon reflects the Company's findings at the time of its intervention only and within the limits of Client's instructions, if any. The Company's sole responsibility is to its Client and this document does not exonerate parties to a transaction from exercising all their rights and obligations under the transaction documents. This document cannot be reproduced except in full, without prior written approval of the Company. Any unauthorized alteration, forgery or falsification of the content or appearance of this document is unlawful and offenders may be prosecuted to the fullest extent of the law. Unless otherwise stated the results shown in this test report refer only to the sample(s) tested and such sample(s) are retained for 30 days only.
Attention: To check the authenticity of testing/inspection report & certificate, please contact us at telephone: (86-755) 8307 1443, or email: CN.Doccheck@sgs.com

South of No. 6 Plant, No. 1, Runsheng Road, Suzhou Industrial Park, Suzhou Area, China (Jiangsu) Pilot Free Trade Zone 215000
 中国·苏州·中国(江苏)自由贸易试验区苏州片区苏州工业园区润胜路1号的6号厂房南面 邮编: 215000

t (86-512) 62992980 www.sgsgroup.com.cn
 t (86-512) 62992980 sgs.china@sgs.com

3.4 General Description of EUT

EUT Description:	Automatic Database Diagnostic Monitor (LTE OBD II Hotspot)	
Model No.:	GD506	
Trade Mark:	GOSUNCN	
Hardware Version:	GD506.H01	
Software Version:	MDM_GEN_GD506V1.1.1B01	
IMEI:	861240040116519	
WLAN Mode Supported:	802.11a:	20 MHz channel bandwidth
	802.11n:	20 MHz / 40 MHz channel bandwidth
	802.11ac:	20 MHz / 40 MHz / 80 MHz channel bandwidth
Operation Frequency:	5250MHz to 5350MHz 5470MHz to 5725MHz	
Modulation Type:	802.11a:	OFDM (BPSK, QPSK, 16QAM, 64QAM)
	802.11n:	OFDM (BPSK, QPSK, 16QAM, 64QAM)
	802.11ac:	OFDM (BPSK, QPSK, 16QAM, 64QAM, 256QAM)
Channel Spacing:	20MHz:	802.11a/n(HT20)/ac(VHT20)
	40MHz:	802.11n(HT40)/ac(VHT40)
	80MHz:	802.11ac(VHT80)
Antenna Type:	Internal Antenna	
Antenna Gain:	5250MHz to 5350MHz: 6.85dBi(Ant2) 5470MHz to 5725MHz: 7.35dBi(Ant2)	
	Note: The antenna gain are derived from the gain information report provided by the manufacturer.	
Smart System:	<input checked="" type="checkbox"/> SISO	802.11a/n/ac
	<input type="checkbox"/> MIMO	CDD: 802.11a/n/ac: Tx & Rx
		STBC: 802.11n/ac: Tx & Rx
		TXBF: 802.11n/ac: Tx & Rx
<input type="checkbox"/> Diversity	802.11a: Tx & Rx	
DFS Function:	<input checked="" type="checkbox"/> Master	
	<input type="checkbox"/> Slave with radar detection	<input type="checkbox"/> Slave without radar detection
RF Cable:	2dB	
Remark:	As above information is provided and confirmed by the applicant. SGS is not liable to the accuracy, suitability, reliability or/and integrity of the information.	



Unless otherwise agreed in writing, this document is issued by the Company subject to its General Conditions of Service printed overleaf, available on request or accessible at <http://www.sgs.com/en/Terms-and-Conditions.aspx> and, for electronic format documents, subject to Terms and Conditions for Electronic Documents at <http://www.sgs.com/en/Terms-and-Conditions/Terms-e-Documents.aspx>. Attention is drawn to the limitation of liability, indemnification and jurisdiction issues defined therein. Any holder of this document is advised that information contained hereon reflects the Company's findings at the time of its intervention only and within the limits of Client's instructions, if any. The Company's sole responsibility is to its Client and this document does not exonerate parties to a transaction from exercising all their rights and obligations under the transaction documents. This document cannot be reproduced except in full, without prior written approval of the Company. Any unauthorized alteration, forgery or falsification of the content or appearance of this document is unlawful and offenders may be prosecuted to the fullest extent of the law. Unless otherwise stated the results shown in this test report refer only to the sample(s) tested and such sample(s) are retained for 30 days only.

Attention: To check the authenticity of testing/inspection report & certificate, please contact us at telephone: (86-755) 8307 1443, or email: CN.Doccheck@sgs.com

South of No. 6 Plant, No. 1, Runsheng Road, Suzhou Industrial Park, Suzhou Area, China (Jiangsu) Pilot Free Trade Zone 215000
中国·苏州·中国(江苏)自由贸易试验区苏州片区苏州工业园区润胜路1号的6号厂房南楼 邮编: 215000

t (86-512) 62992980 www.sgs.com.cn
t (86-512) 62992980 sgs.china@sgs.com

Remark:

In FCC 15.31, for each band in which the device can be operated with the device operating at the number of frequencies in each band specified in the following table, and the selected channel to perform the test as below:

Frequency Range of Operation Operating Frequency Range (in each Band)	Number of Measurement Frequencies Required	Location of Measurement Frequency in Band of Operation
1 MHz or less	1	centre
1 MHz to 10 MHz	2	1 near high end, 1 near low end
Greater than 10 MHz	3	1 near high end, 1 near centre

For UNII Band II-A:

Mode	Channel	Frequency(MHz)
IEEE 802.11a/n/ac 20MHz	The Lowest channel	5260
	The Middle channel	5280
	The Highest channel	5320
IEEE 802.11n/ac 40MHz	The Lowest channel	5270
	The Highest channel	5310
IEEE 802.11ac 80MHz	The Middle channel	5290

For UNII Band II-C:

Mode	Channel	Frequency(MHz)
IEEE 802.11a/n/ac 20MHz	The Lowest channel	5500
	The Middle channel	5580
	The Highest channel	5700
IEEE 802.11n/ac 40MHz	The Lowest channel	5510
	The Middle channel	5550
	The Highest channel	5670
IEEE 802.11ac 80MHz	The Lowest channel	5530
	The Highest channel	5610



Unless otherwise agreed in writing, this document is issued by the Company subject to its General Conditions of Service printed overleaf, available on request or accessible at <http://www.sgs.com/en/Terms-and-Conditions.aspx> and, for electronic format documents, subject to Terms and Conditions for Electronic Documents at <http://www.sgs.com/en/Terms-and-Conditions/Terms-e-Documents.aspx>. Attention is drawn to the limitation of liability, indemnification and jurisdiction issues defined therein. Any holder of this document is advised that information contained hereon reflects the Company's findings at the time of its intervention only and within the limits of Client's instructions, if any. The Company's sole responsibility is to its Client and this document does not exonerate parties to a transaction from exercising all their rights and obligations under the transaction documents. This document cannot be reproduced except in full, without prior written approval of the Company. Any unauthorized alteration, forgery or falsification of the content or appearance of this document is unlawful and offenders may be prosecuted to the fullest extent of the law. Unless otherwise stated the results shown in this test report refer only to the sample(s) tested and such sample(s) are retained for 30 days only.
Attention: To check the authenticity of testing/inspection report & certificate, please contact us at telephone: (86-755) 8307 1443, or email: CN.Doccheck@sgs.com

South of No. 6 Plant, No. 1, Runsheng Road, Suzhou Industrial Park, Suzhou Area, China (Jiangsu) Pilot Free Trade Zone 215000
 中国·苏州·中国(江苏)自由贸易试验区苏州片区苏州工业园区润胜路1号的6号厂房南楼 邮编: 215000

t (86-512) 62992980 www.sgsgroup.com.cn
 t (86-512) 62992980 sgs.china@sgs.com

3.5 Test Environment and Mode

Environment Parameter	101.0 kPa Selected Values During Tests	
Relative Humidity	44-60 % RH Ambient	
Value	Temperature(°C)	Voltage(V)
NTNV	22~23	12
Remark: NV: Normal Voltage NT: Normal Temperature		

3.6 Description of Support Units

Description	Manufacturer	Model No.
Mother board*	Gosuncn Technology Group Co., Ltd.	VX6080
Router	ASUS	GT-AXE11000 (FCC ID MSQ-RTAXJF00)
Remark: the information with "*" are provided by client.		

3.7 Worst-case configuration and mode

Low data rate was used to test on antenna port conducted tests and radiated spurious emissions since it has the highest maximum power. Following are the worst-case data rates set for test:

Modulation Type	SISO - Data Rate	MIMO - Data Rate
802.11a	6 Mbps	/
802.11n (HT 20)	MCS0 (6.5 Mbps)	/
802.11n (HT 40)	MCS0 (13.5 Mbps)	/
802.11ac (VHT 20)	MCS0 (6.5 Mbps)	/
802.11ac (VHT 40)	MCS0 (13.5 Mbps)	/
802.11ac (VHT 80)	MCS0 (29.3 Mbps)	/



Unless otherwise agreed in writing, this document is issued by the Company subject to its General Conditions of Service printed overleaf, available on request or accessible at <http://www.sgs.com/en/Terms-and-Conditions.aspx> and, for electronic format documents, subject to Terms and Conditions for Electronic Documents at <http://www.sgs.com/en/Terms-and-Conditions/Terms-e-Documents.aspx>. Attention is drawn to the limitation of liability, indemnification and jurisdiction issues defined therein. Any holder of this document is advised that information contained hereon reflects the Company's findings at the time of its intervention only and within the limits of Client's instructions, if any. The Company's sole responsibility is to its Client and this document does not exonerate parties to a transaction from exercising all their rights and obligations under the transaction documents. This document cannot be reproduced except in full, without prior written approval of the Company. Any unauthorized alteration, forgery or falsification of the content or appearance of this document is unlawful and offenders may be prosecuted to the fullest extent of the law. Unless otherwise stated the results shown in this test report refer only to the sample(s) tested and such sample(s) are retained for 30 days only.
Attention: To check the authenticity of testing/inspection report & certificate, please contact us at telephone: (86-755) 8307 1443, or email: CN.Doccheck@sgs.com

South of No. 6 Plant, No. 1, Runsheng Road, Suzhou Industrial Park, Suzhou Area, China (Jiangsu) Pilot Free Trade Zone 215000
中国·苏州·中国(江苏)自由贸易试验区苏州片区苏州工业园区润胜路1号的6号厂房南楼 邮编: 215000

t (86-512) 62992980 www.sgs.com.cn
t (86-512) 62992980 sgs.china@sgs.com

4 Test results and Measurement Data

4.1 Dynamic Frequency Selection

4.1.1 DFS Measurement Configuration

Test Condition	Conducted Measurement Use 50Ohms to connect cable/connector calibration and testing, Use ANT2 port for testing. Refer to Section 4.1.7 for test connection.
----------------	--

4.1.2 DFS Threshold level

DFS Threshold level:(-54.65)dBm	<input checked="" type="checkbox"/> At the antenna connector <input type="checkbox"/> In front of the antenna
The Interference Radar Detection Threshold Level is: (Band II-C: -62dBm + 7.35dBi + 0dB = -54.65dBm); That had been taken into account the output power range and antenna gain.	

4.1.3 Power-on cycle

The time required for the Master Device and/or Client Device to complete its power-on cycle(19S).

4.1.4 User Access Restrctions

DFS Controls(Hardware or software) related to radar detection are NOT accessible to the user. Manufacturer statement confirming that information regarding the parameters of the detected Radar Waveforms is not available to the end user.

4.1.5 Channel Loading/Data Streaming

<input type="checkbox"/>	The dara file(MPEG-4) has been transmitting in a streaming mode.
<input checked="" type="checkbox"/>	Softwae to ping the client is permitted to simuate data transfer with random ping intervals.
<input checked="" type="checkbox"/>	Minimum channel loading of approximately 17%.
<input type="checkbox"/>	Unicast protocol has been used.



4.1.6 Conducted Setup of Calibration of DFS Detection Threshold Level



4.1.7 Test Setup

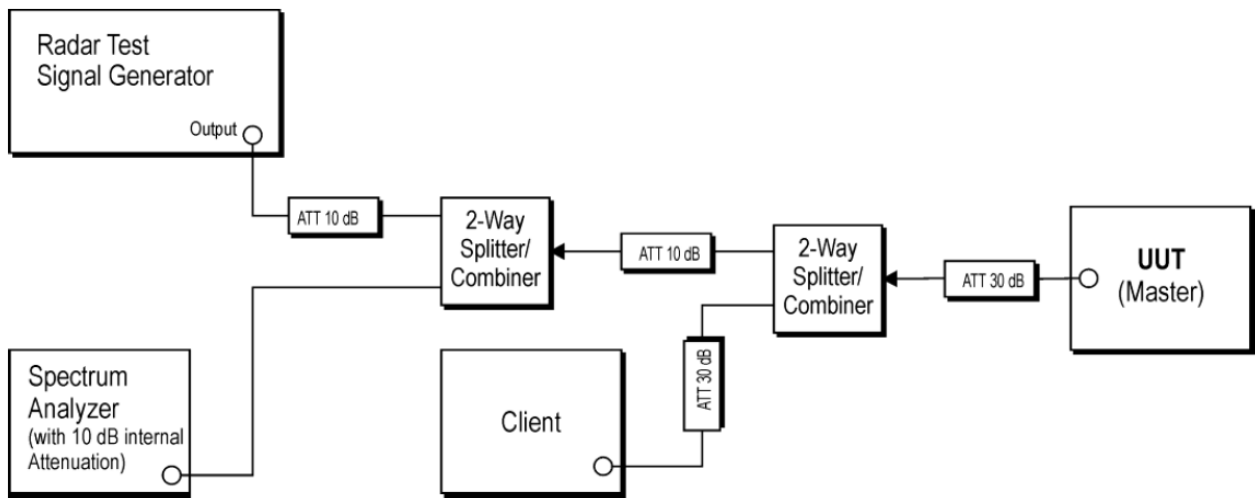

Unless otherwise agreed in writing, this document is issued by the Company subject to its General Conditions of Service printed overleaf, available on request or accessible at <http://www.sgs.com/en/Terms-and-Conditions.aspx> and, for electronic format documents, subject to Terms and Conditions for Electronic Documents at <http://www.sgs.com/en/Terms-and-Conditions/Terms-e-Documents.aspx>. Attention is drawn to the limitation of liability, indemnification and jurisdiction issues defined therein. Any holder of this document is advised that information contained hereon reflects the Company's findings at the time of its intervention only and within the limits of Client's instructions, if any. The Company's sole responsibility is to its Client and this document does not exonerate parties to a transaction from exercising all their rights and obligations under the transaction documents. This document cannot be reproduced except in full, without prior written approval of the Company. Any unauthorized alteration, forgery or falsification of the content or appearance of this document is unlawful and offenders may be prosecuted to the fullest extent of the law. Unless otherwise stated the results shown in this test report refer only to the sample(s) tested and such sample(s) are retained for 30 days only.
Attention: To check the authenticity of testing/inspection report & certificate, please contact us at telephone: (86-755) 8307 1443, or email: CN.Doccheck@sgs.com

South of No. 6 Plant, No. 1, Runsheng Road, Suzhou Industrial Park, Suzhou Area, China (Jiangsu) Pilot Free Trade Zone 215000
 中国·苏州·中国(江苏)自由贸易试验区苏州片区苏州工业园区润胜路1号的6号厂房南楼 邮编: 215000

t (86-512) 62992980 www.sgsgroup.com.cn
 t (86-512) 62992980 sgs.china@sgs.com

4.1.8 Applicability of DFS Requirements Prior to Use of a Channel

Requirement	DFS Operational mode		
	Master	Client Without Radar Detection	Client With Radar Detection
<i>Non-Occupancy Period</i>	Yes	Not required	Yes
<i>DFS Detection Threshold</i>	Yes	Not required	Yes
<i>Channel Availability Check Time</i>	Yes	Not required	Not required
<i>U-NII Detection Bandwidth</i>	Yes	Not required	Yes

4.1.9 Applicability of DFS Requirements During Normal Operation

Requirement	DFS Operational mode	
	Master Device or Client with Radar Detection	Client Without Radar Detection
<i>DFS Detection Threshold</i>	Yes	Not required
<i>Channel Availability Check Time</i>	Yes	Yes
<i>Channel Move Time</i>	Yes	Yes
<i>U-NII Detection Bandwidth</i>	Yes	Not required

Additional requirements for devices with multiple bandwidth modes	Master Device or Client with Radar Detection	Client Without Radar Detection
<i>U-NII Detection Bandwidth and Statistical Performance Check</i>	All BW modes must be tested	Not required
<i>Channel Move Time and Channel Closing Transmission Time</i>	Test using widest BW mode available	Test using the widest BW mode available for the link
<i>All other tests</i>	Any single BW mode	Not required

Note: Frequencies selected for statistical performance check (Section 7.8.4) should include several frequencies within the radar detection bandwidth and frequencies near the edge of the radar detection bandwidth. For 802.11 devices it is suggested to select frequencies in each of the bonded 20 MHz channels and the channel center frequency.



Unless otherwise agreed in writing, this document is issued by the Company subject to its General Conditions of Service printed overleaf, available on request or accessible at <http://www.sgs.com/en/Terms-and-Conditions.aspx> and, for electronic format documents, subject to Terms and Conditions for Electronic Documents at <http://www.sgs.com/en/Terms-and-Conditions/Terms-e-Documents.aspx>. Attention is drawn to the limitation of liability, indemnification and jurisdiction issues defined therein. Any holder of this document is advised that information contained hereon reflects the Company's findings at the time of its intervention only and within the limits of Client's instructions, if any. The Company's sole responsibility is to its Client and this document does not exonerate parties to a transaction from exercising all their rights and obligations under the transaction documents. This document cannot be reproduced except in full, without prior written approval of the Company. Any unauthorized alteration, forgery or falsification of the content or appearance of this document is unlawful and offenders may be prosecuted to the fullest extent of the law. Unless otherwise stated the results shown in this test report refer only to the sample(s) tested and such sample(s) are retained for 30 days only.
Attention: To check the authenticity of testing/inspection report & certificate, please contact us at telephone: (86-755) 8307 1443, or email: CN.Doccheck@sgs.com

South of No. 6 Plant, No. 1, Runsheng Road, Suzhou Industrial Park, Suzhou Area, China (Jiangsu) Pilot Free Trade Zone 215000
 中国·苏州·中国(江苏)自由贸易试验区苏州片区苏州工业园区润胜路1号的6号厂房南楼 邮编: 215000

t (86-512) 62992980 www.sgs.com.cn
 t (86-512) 62992980 sgs.china@sgs.com

4.1.10 DFS Detection Thresholds

Maximum Transmit Power	Value (See Notes 1, 2, and 3)
EIRP ≥ 200 milliwatt	-64 dBm
EIRP < 200 milliwatt and power spectral density < 10 dBm/MHz	-62 dBm
EIRP < 200 milliwatt that do not meet the power spectral density requirement	-64 dBm

Note 1: This is the level at the input of the receiver assuming a 0 dBi receive antenna.

Note 2: Throughout these test procedures an additional 1 dB has been added to the amplitude of the test transmission waveforms to account for variations in measurement equipment. This will ensure that the test signal is at or above the detection threshold level to trigger a DFS response.

Note3: EIRP is based on the highest antenna gain. For MIMO devices refer to KDB Publication 662911 D01.

4.1.11 Response Requirements

Parameter	Value
<i>Non-occupancy period</i>	Minimum 30 minutes
<i>Channel Availability Check Time</i>	60 seconds
<i>Channel Move Time</i>	10 seconds See Note 1.
<i>Channel Closing Transmission Time</i>	200 milliseconds + an aggregate of 60 milliseconds over remaining 10 second period. See Notes 1 and 2.
<i>U-NII Detection Bandwidth</i>	Minimum 100% of the U-NII 99% transmission power bandwidth. See Note 3.

Note 1: Channel Move Time and the Channel Closing Transmission Time should be performed with Radar Type 0. The measurement timing begins at the end of the Radar Type 0 burst.

Note 2: The Channel Closing Transmission Time is comprised of 200 milliseconds starting at the beginning of the Channel Move Time plus any additional intermittent control signals required to facilitate a Channel move (an aggregate of 60 milliseconds) during the remainder of the 10 second period. The aggregate duration of control signals will not count quiet periods in between transmissions.

Note 3: During the U-NII Detection Bandwidth detection test, radar type 0 should be used. For each frequency step the minimum percentage of detection is 90 percent. Measurements are performed with no data traffic.



Unless otherwise agreed in writing, this document is issued by the Company subject to its General Conditions of Service printed overleaf, available on request or accessible at <http://www.sgs.com/en/Terms-and-Conditions.aspx> and, for electronic format documents, subject to Terms and Conditions for Electronic Documents at <http://www.sgs.com/en/Terms-and-Conditions/Terms-e-Documents.aspx>. Attention is drawn to the limitation of liability, indemnification and jurisdiction issues defined therein. Any holder of this document is advised that information contained hereon reflects the Company's findings at the time of its intervention only and within the limits of Client's instructions, if any. The Company's sole responsibility is to its Client and this document does not exonerate parties to a transaction from exercising all their rights and obligations under the transaction documents. This document cannot be reproduced except in full, without prior written approval of the Company. Any unauthorized alteration, forgery or falsification of the content or appearance of this document is unlawful and offenders may be prosecuted to the fullest extent of the law. Unless otherwise stated the results shown in this test report refer only to the sample(s) tested and such sample(s) are retained for 30 days only.
Attention: To check the authenticity of testing/inspection report & certificate, please contact us at telephone: (86-755) 8307 1443, or email: CN.Doccheck@sgs.com

South of No. 6 Plant, No. 1, Runsheng Road, Suzhou Industrial Park, Suzhou Area, China (Jiangsu) Pilot Free Trade Zone 215000 t (86-512) 62992980 www.sgs.com.cn
 中国·苏州·中国(江苏)自由贸易试验区苏州片区苏州工业园区润胜路1号的6号厂房南楼 邮编: 215000 t (86-512) 62992980 sgs.china@sgs.com

4.1.12 Short Pulse Radar Test Waveforms

Radar Type	Pulse Width (μsec)	PRI(μsec)	Number of Pulses	Minimum Percentage of Successful Detection	Minimum Number of Trials
0	1	1428	18	See Note 1	See Note 1
1	1	Test A: 15 unique PRI values randomly selected from the list of 23 PRI values in Table 5a	Roundup $\left\{ \left(\frac{1}{360} \right) \cdot \left(\frac{19 \cdot 10^6}{PRI_{\mu sec}} \right) \right\}$	60%	30
		Test B: 15 unique PRI values randomly selected within the range of 518-3066 μsec, with a minimum increment of 1 μsec, excluding PRI values selected in Test A			
2	1-5	150-230	23-29	60%	30
3	6-10	200-500	16-18	60%	30
4	11-20	200-500	12-16	60%	30
Aggregate (Radar Types 1-4)				80%	120
Note 1: Short Pulse Radar Type 0 should be used for the detection bandwidth test, channel move time, and channel closing time tests.					

A minimum of 30 unique waveforms are required for each of the Short Pulse Radar Types 2 through 4. If more than 30 waveforms are used for Short Pulse Radar Types 2 through 4, then each additional waveform must also be unique and not repeated from the previous waveforms. If more than 30 waveforms are used for Short Pulse Radar Type 1, then each additional waveform is generated with Test B and must also be unique and not repeated from the previous waveforms in Tests A or B.

For example if in Short Pulse Radar Type 1 Test B a PRI of 3066 μsec is selected, the number of pulses

would be $6 \cdot 1 \cdot 19 \cdot 10 \cdot \text{Roundup} \left\{ \left(\frac{1}{360} \right) \cdot \left(\frac{19 \cdot 10^6}{3066} \right) \right\} \text{ Round up } \{17.2\} = 18.$

Table 5a - Pulse Repetition Intervals Values for Test A



Unless otherwise agreed in writing, this document is issued by the Company subject to its General Conditions of Service printed overleaf, available on request or accessible at <http://www.sgs.com/en/Terms-and-Conditions.aspx> and, for electronic format documents, subject to Terms and Conditions for Electronic Documents at <http://www.sgs.com/en/Terms-and-Conditions/Terms-e-Documents.aspx>. Attention is drawn to the limitation of liability, indemnification and jurisdiction issues defined therein. Any holder of this document is advised that information contained hereon reflects the Company's findings at the time of its intervention only and within the limits of Client's instructions, if any. The Company's sole responsibility is to its Client and this document does not exonerate parties to a transaction from exercising all their rights and obligations under the transaction documents. This document cannot be reproduced except in full, without prior written approval of the Company. Any unauthorized alteration, forgery or falsification of the content or appearance of this document is unlawful and offenders may be prosecuted to the fullest extent of the law. Unless otherwise stated the results shown in this test report refer only to the sample(s) tested and such sample(s) are retained for 30 days only.
Attention: To check the authenticity of testing/inspection report & certificate, please contact us at telephone: (86-755) 8307 1443, or email: CN.Doccheck@sgs.com

South of No. 6 Plant, No. 1, Runsheng Road, Suzhou Industrial Park, Suzhou Area, China (Jiangsu) Pilot Free Trade Zone 215000 t (86-512) 62992980 www.sgs.com.cn
 中国·苏州·中国(江苏)自由贸易试验区苏州片区苏州工业园区润胜路1号的6号厂房南楼 邮编: 215000 t (86-512) 62992980 sgs.china@sgs.com

Pulse Repetition Frequency Number	Pulse Repetition Frequency (Pulses Per Second)	Pulse Repetition Interval (Microseconds)
1	1930.5	518
2	1858.7	538
3	1792.1	558
4	1730.1	578
5	1672.2	598
6	1618.1	618
7	1567.4	638
8	1519.8	658
9	1474.9	678
10	1432.7	698
11	1392.8	718
12	1355	738
13	1319.3	758
14	1285.3	778
15	1253.1	798
16	1222.5	818
17	1193.3	838
18	1165.6	858
19	1139	878
20	1113.6	898
21	1089.3	918
22	1066.1	938
23	326.2	3066

The aggregate is the average of the percentage of successful detections of Short Pulse Radar Types 1-4. For example, the following table indicates how to compute the aggregate of percentage of successful detections.

Radar Type	Number of Trials	Number of Successful Detections	Minimum Percentage of Successful Detection
1	35	29	82.9%
2	30	18	60%
3	30	27	90%
4	50	44	88%

Aggregate $(82.9\% + 60\% + 90\% + 88\%)/4 = 80.2\%$



Unless otherwise agreed in writing, this document is issued by the Company subject to its General Conditions of Service printed overleaf, available on request or accessible at <http://www.sgs.com/en/Terms-and-Conditions.aspx> and, for electronic format documents, subject to Terms and Conditions for Electronic Documents at <http://www.sgs.com/en/Terms-and-Conditions/Terms-e-Documents.aspx>. Attention is drawn to the limitation of liability, indemnification and jurisdiction issues defined therein. Any holder of this document is advised that information contained hereon reflects the Company's findings at the time of its intervention only and within the limits of Client's instructions, if any. The Company's sole responsibility is to its Client and this document does not exonerate parties to a transaction from exercising all their rights and obligations under the transaction documents. This document cannot be reproduced except in full, without prior written approval of the Company. Any unauthorized alteration, forgery or falsification of the content or appearance of this document is unlawful and offenders may be prosecuted to the fullest extent of the law. Unless otherwise stated the results shown in this test report refer only to the sample(s) tested and such sample(s) are retained for 30 days only.

Attention: To check the authenticity of testing/inspection report & certificate, please contact us at telephone: (86-755) 8307 1443, or email: CN.Doccheck@sgs.com

South of No. 6 Plant, No. 1, Runsheng Road, Suzhou Industrial Park, Suzhou Area, China (Jiangsu) Pilot Free Trade Zone 215000 t (86-512) 62992980 www.sgs.com.cn
 中国·苏州·中国(江苏)自由贸易试验区苏州片区苏州工业园区润胜路1号的6号厂房南楼 邮编: 215000 t (86-512) 62992980 sgs.china@sgs.com

4.1.13 Long Pulse Radar Test Waveform

Radar Type	Pulse Width (μsec)	Chirp Width (MHz)	PRI (μsec)	Number of Pulses per Burst	Number of Bursts	Minimum Percentage of Successful Detection	Minimum Number of Trials
5	50-100	5-20	1000-2000	1-3	8-20	80%	30

Each waveform is defined as follows:

- 1) The transmission period for the Long Pulse Radar test signal is 12 seconds.
- 2) There are a total of 8 to 20 Bursts in the 12 second period, with the number of Bursts being randomly chosen. This number is Burst Count.
- 3) Each Burst consists of 1 to 3 pulses, with the number of pulses being randomly chosen. Each Burst within the 12 second sequence may have a different number of pulses.
- 4) The pulse width is between 50 and 100 microseconds, with the pulse width being randomly chosen. Each pulse within a Burst will have the same pulse width. Pulses in different Bursts may have different pulse widths.
- 5) Each pulse has a linear frequency modulated chirp between 5 and 20 MHz, with the chirp width being randomly chosen. Each pulse within a transmission period will have the same chirp width. The chirp is centered on the pulse. For example, with a radar frequency of 5300 MHz and a 20 MHz chirped signal, the chirp starts at 5290 MHz and ends at 5310 MHz.
- 6) If more than one pulse is present in a Burst, the time between the pulses will be between 1000 and 2000 microseconds, with the time being randomly chosen. If three pulses are present in a Burst, the random time interval between the first and second pulses is chosen independently of the random time interval between the second and third pulses.
- 7) The 12 second transmission period is divided into even intervals. The number of intervals is equal to Burst Count. Each interval is of length $(12,000,000 / \text{Burst Count})$ microseconds. Each interval contains one Burst. The start time for the Burst, relative to the beginning of the interval, is between 1 and $[(12,000,000 / \text{Burst Count}) - (\text{Total Burst Length}) + (\text{One Random PRI Interval})]$ microseconds, with the start time being randomly chosen. The step interval for the start time is 1 microsecond. The start time for each Burst is chosen randomly.

4.1.14 Frequency Hopping Radar Test Waveform

Radar Type	Pulse Width (μsec)	Chirp Width (MHz)	PRI (μsec)	Number of Pulses per Burst	Number of Bursts	Minimum Percentage of Successful Detection	Minimum Number of Trials
6	1	333	9	0.333	300	70%	30

For the Frequency Hopping Radar Type, the same Burst parameters are used for each waveform. The hopping sequence is different for each waveform and a 100-length segment is selected from the hopping sequence defined by the following algorithm: If a segment does not contain at least 1 frequency within the U-NII Detection Bandwidth of the UUT, then that segment is not used.

The detailed test data see: **Appendix**



Unless otherwise agreed in writing, this document is issued by the Company subject to its General Conditions of Service printed overleaf, available on request or accessible at <http://www.sgs.com/en/Terms-and-Conditions.aspx> and, for electronic format documents, subject to Terms and Conditions for Electronic Documents at <http://www.sgs.com/en/Terms-and-Conditions/Terms-e-Documents.aspx>. Attention is drawn to the limitation of liability, indemnification and jurisdiction issues defined therein. Any holder of this document is advised that information contained hereon reflects the Company's findings at the time of its intervention only and within the limits of Client's instructions, if any. The Company's sole responsibility is to its Client and this document does not exonerate parties to a transaction from exercising all their rights and obligations under the transaction documents. This document cannot be reproduced except in full, without prior written approval of the Company. Any unauthorized alteration, forgery or falsification of the content or appearance of this document is unlawful and offenders may be prosecuted to the fullest extent of the law. Unless otherwise stated the results shown in this test report refer only to the sample(s) tested and such sample(s) are retained for 30 days only.
Attention: To check the authenticity of testing/inspection report & certificate, please contact us at telephone: (86-755) 8307 1443, or email: CN.Doccheck@sgs.com

South of No. 6 Plant, No. 1, Runsheng Road, Suzhou Industrial Park, Suzhou Area, China (Jiangsu) Pilot Free Trade Zone 215000 t (86-512) 62992980 www.sgsgroup.com.cn
 中国·苏州·中国(江苏)自由贸易试验区苏州片区苏州工业园区润胜路1号的6号厂房南楼 邮编: 215000 t (86-512) 62992980 sgs.china@sgs.com

5 Measurement Uncertainty (95% confidence levels, k=2)

No.	Item	Measurement Uncertainty
1	Radio Frequency	±1.0 %

Remark:
 The U_{lab} (lab Uncertainty) is less than $U_{CISPR/ETSI}$ (CISPR/ETSI Uncertainty), so the test results
 – compliance is deemed to occur if no measured disturbance level exceeds the disturbance limit;
 – non-compliance is deemed to occur if any measured disturbance level exceeds the disturbance limit.



Unless otherwise agreed in writing, this document is issued by the Company subject to its General Conditions of Service printed overleaf, available on request or accessible at <http://www.sgs.com/en/Terms-and-Conditions.aspx> and, for electronic format documents, subject to Terms and Conditions for Electronic Documents at <http://www.sgs.com/en/Terms-and-Conditions/Terms-e-Documents.aspx>. Attention is drawn to the limitation of liability, indemnification and jurisdiction issues defined therein. Any holder of this document is advised that information contained hereon reflects the Company's findings at the time of its intervention only and within the limits of Client's instructions, if any. The Company's sole responsibility is to its Client and this document does not exonerate parties to a transaction from exercising all their rights and obligations under the transaction documents. This document cannot be reproduced except in full, without prior written approval of the Company. Any unauthorized alteration, forgery or falsification of the content or appearance of this document is unlawful and offenders may be prosecuted to the fullest extent of the law. Unless otherwise stated the results shown in this test report refer only to the sample(s) tested and such sample(s) are retained for 30 days only.
Attention: To check the authenticity of testing/inspection report & certificate, please contact us at telephone: (86-755) 8307 1443, or email: CN.Doccheck@sgs.com

South of No. 6 Plant, No. 1, Runsheng Road, Suzhou Industrial Park, Suzhou Area, China (Jiangsu) Pilot Free Trade Zone 215000
 中国·苏州·中国(江苏)自由贸易试验区苏州片区苏州工业园区润胜路1号的6号厂房南面 邮编: 215000

t (86-512) 62992980 www.sgs.com.cn
 t (86-512) 62992980 sgs.china@sgs.com

6 Equipment List

RF Test Equipment					
Equipment	Manufacturer	Model No.	Inventory No.	Cal Date (yyyy/mm/dd)	Cal Due Date (yyyy/mm/dd)
Shielding Room	Brilliant-emc	N/A	SUWI-04-01-06	2021/05/08	2024/05/07
Temperature and humidity meter	MingGao	TH101B	SUWI-01-01-07	2022/02/16	2023/02/15
Signal Analyzer	ROHDE &SCHWARZ	FSV3030	SUWI-01-02-02	2022/05/17	2023/05/16
Measurement Software	Tonscend	JS1120-3 Test System V3.1.55	SUWI-02-09-09	NCR	NCR
DC Power Supply	HYELEC	HY3005B	SUWI-01-18-01	2022/02/15	2023/02/14
Signal Analyzer	ROHDE &SCHWARZ	FSW43	SUWI-01-02-04	2022/05/28	2023/05/27
Power meter	Anritsu	ML2495A	SUWI-01-31-01	2021/12/04	2022/12/03
				2022/11/23	2023/11/22
Pulse power sensor	Anritsu	MA2411B	SUWI-01-32-01	2021/12/04	2022/12/03
				2022/11/23	2023/11/22
MXG Vector signal genitor	KEYSIGHT	N5182B	SUWI-01-38-01	2022/02/14	2023/02/13
Temperature Chamber	ESPEC	SU-242	SUWI-01-13-01	2022/02/15	2023/02/14
Wideband Radio Communication Tester	ROHDE &SCHWARZ	CMW500	SUWI-01-16-05	2022/02/14	2023/02/13



Unless otherwise agreed in writing, this document is issued by the Company subject to its General Conditions of Service printed overleaf, available on request or accessible at <http://www.sgs.com/en/Terms-and-Conditions.aspx> and, for electronic format documents, subject to Terms and Conditions for Electronic Documents at <http://www.sgs.com/en/Terms-and-Conditions/Terms-e-Documents.aspx>. Attention is drawn to the limitation of liability, indemnification and jurisdiction issues defined therein. Any holder of this document is advised that information contained hereon reflects the Company's findings at the time of its intervention only and within the limits of Client's instructions, if any. The Company's sole responsibility is to its Client and this document does not exonerate parties to a transaction from exercising all their rights and obligations under the transaction documents. This document cannot be reproduced except in full, without prior written approval of the Company. Any unauthorized alteration, forgery or falsification of the content or appearance of this document is unlawful and offenders may be prosecuted to the fullest extent of the law. Unless otherwise stated the results shown in this test report refer only to the sample(s) tested and such sample(s) are retained for 30 days only.

Attention: To check the authenticity of testing/inspection report & certificate, please contact us at telephone: (86-755) 8307 1443, or email: CN.Doccheck@sgs.com

South of No. 6 Plant, No. 1, Runsheng Road, Suzhou Industrial Park, Suzhou Area, China (Jiangsu) Pilot Free Trade Zone 215000
 中国·苏州·中国(江苏)自由贸易试验区苏州片区苏州工业园区润胜路1号的6号厂房南楼 邮编: 215000

t (86-512) 62992980 www.sgs.com.cn
 t (86-512) 62992980 sgs.china@sgs.com

Report No.: SEWA2209000044RG06
Rev.: 01
Page: 18 of 85

7 Photographs - Setup Photos

Refer to Appendix A.2 WLAN Setup Photos.



Unless otherwise agreed in writing, this document is issued by the Company subject to its General Conditions of Service printed overleaf, available on request or accessible at <http://www.sgs.com/en/Terms-and-Conditions.aspx> and, for electronic format documents, subject to Terms and Conditions for Electronic Documents at <http://www.sgs.com/en/Terms-and-Conditions/Terms-e-Documents.aspx>. Attention is drawn to the limitation of liability, indemnification and jurisdiction issues defined therein. Any holder of this document is advised that information contained hereon reflects the Company's findings at the time of its intervention only and within the limits of Client's instructions, if any. The Company's sole responsibility is to its Client and this document does not exonerate parties to a transaction from exercising all their rights and obligations under the transaction documents. This document cannot be reproduced except in full, without prior written approval of the Company. Any unauthorized alteration, forgery or falsification of the content or appearance of this document is unlawful and offenders may be prosecuted to the fullest extent of the law. Unless otherwise stated the results shown in this test report refer only to the sample(s) tested and such sample(s) are retained for 30 days only.
Attention: To check the authenticity of testing/inspection report & certificate, please contact us at telephone: (86-755) 8307 1443, or email: CN.Doccheck@sgs.com

South of No. 6 Plant, No. 1, Runsheng Road, Suzhou Industrial Park, Suzhou Area, China (Jiangsu) Pilot Free Trade Zone 215000
中国·苏州·中国(江苏)自由贸易试验区苏州片区苏州工业园区润胜路1号的6号厂房南面 邮编: 215000

t (86-512) 62992980 www.sgsgroup.com.cn
t (86-512) 62992980 sgs.china@sgs.com

Report No.: SEWA2209000044RG06
Rev.: 01
Page: 19 of 85

Appendix



Unless otherwise agreed in writing, this document is issued by the Company subject to its General Conditions of Service printed overleaf, available on request or accessible at <http://www.sgs.com/en/Terms-and-Conditions.aspx> and, for electronic format documents, subject to Terms and Conditions for Electronic Documents at <http://www.sgs.com/en/Terms-and-Conditions/Terms-e-Documents.aspx>. Attention is drawn to the limitation of liability, indemnification and jurisdiction issues defined therein. Any holder of this document is advised that information contained hereon reflects the Company's findings at the time of its intervention only and within the limits of Client's instructions, if any. The Company's sole responsibility is to its Client and this document does not exonerate parties to a transaction from exercising all their rights and obligations under the transaction documents. This document cannot be reproduced except in full, without prior written approval of the Company. Any unauthorized alteration, forgery or falsification of the content or appearance of this document is unlawful and offenders may be prosecuted to the fullest extent of the law. Unless otherwise stated the results shown in this test report refer only to the sample(s) tested and such sample(s) are retained for 30 days only.
Attention: To check the authenticity of testing/inspection report & certificate, please contact us at telephone: (86-755) 8307 1443, or email: CN.Doccheck@sgs.com

South of No. 6 Plant, No. 1, Runsheng Road, Suzhou Industrial Park, Suzhou Area, China (Jiangsu) Pilot Free Trade Zone 215000 t (86-512) 62992980 www.sgs.com.cn
中国·苏州·中国(江苏)自由贸易试验区苏州片区苏州工业园区湖胜路1号的6号厂房南楼 邮编: 215000 t (86-512) 62992980 sgs.china@sgs.com

**DFS Detection Thresholds
Test Result**

TestMode	Frequency[dbm]	Radar Type	Result	Gain	Limit[dbm]	Verdict
11ac80SISO	5530	Type0	-54.81	7.35	-54.65	PASS
		Type1	-54.78	7.35	-54.65	PASS
		Type2	-54.71	7.35	-54.65	PASS
		Type3	-54.78	7.35	-54.65	PASS
		Type4	-54.66	7.35	-54.65	PASS
		Type5	-54.86	7.35	-54.65	PASS
		Type6	-55.09	7.35	-54.65	PASS



Unless otherwise agreed in writing, this document is issued by the Company subject to its General Conditions of Service printed overleaf, available on request or accessible at <http://www.sgs.com/en/Terms-and-Conditions.aspx> and, for electronic format documents, subject to Terms and Conditions for Electronic Documents at <http://www.sgs.com/en/Terms-and-Conditions/Terms-e-Documents.aspx>. Attention is drawn to the limitation of liability, indemnification and jurisdiction issues defined therein. Any holder of this document is advised that information contained hereon reflects the Company's findings at the time of its intervention only and within the limits of Client's instructions, if any. The Company's sole responsibility is to its Client and this document does not exonerate parties to a transaction from exercising all their rights and obligations under the transaction documents. This document cannot be reproduced except in full, without prior written approval of the Company. Any unauthorized alteration, forgery or falsification of the content or appearance of this document is unlawful and offenders may be prosecuted to the fullest extent of the law. Unless otherwise stated the results shown in this test report refer only to the sample(s) tested and such sample(s) are retained for 30 days only.
Attention: To check the authenticity of testing/inspection report & certificate, please contact us at telephone: (86-755) 8307 1443, or email: CN.Doccheck@sgs.com

South of No. 6 Plant, No. 1, Runsheng Road, Suzhou Industrial Park, Suzhou Area, China (Jiangsu) Pilot Free Trade Zone 215000
 中国·苏州·中国(江苏)自由贸易试验区苏州片区苏州工业园区润胜路1号的6号厂房南面 邮编: 215000

t (86-512) 62992980 www.sgs.com.cn
 t (86-512) 62992980 sgs.china@sgs.com

Test Graphs

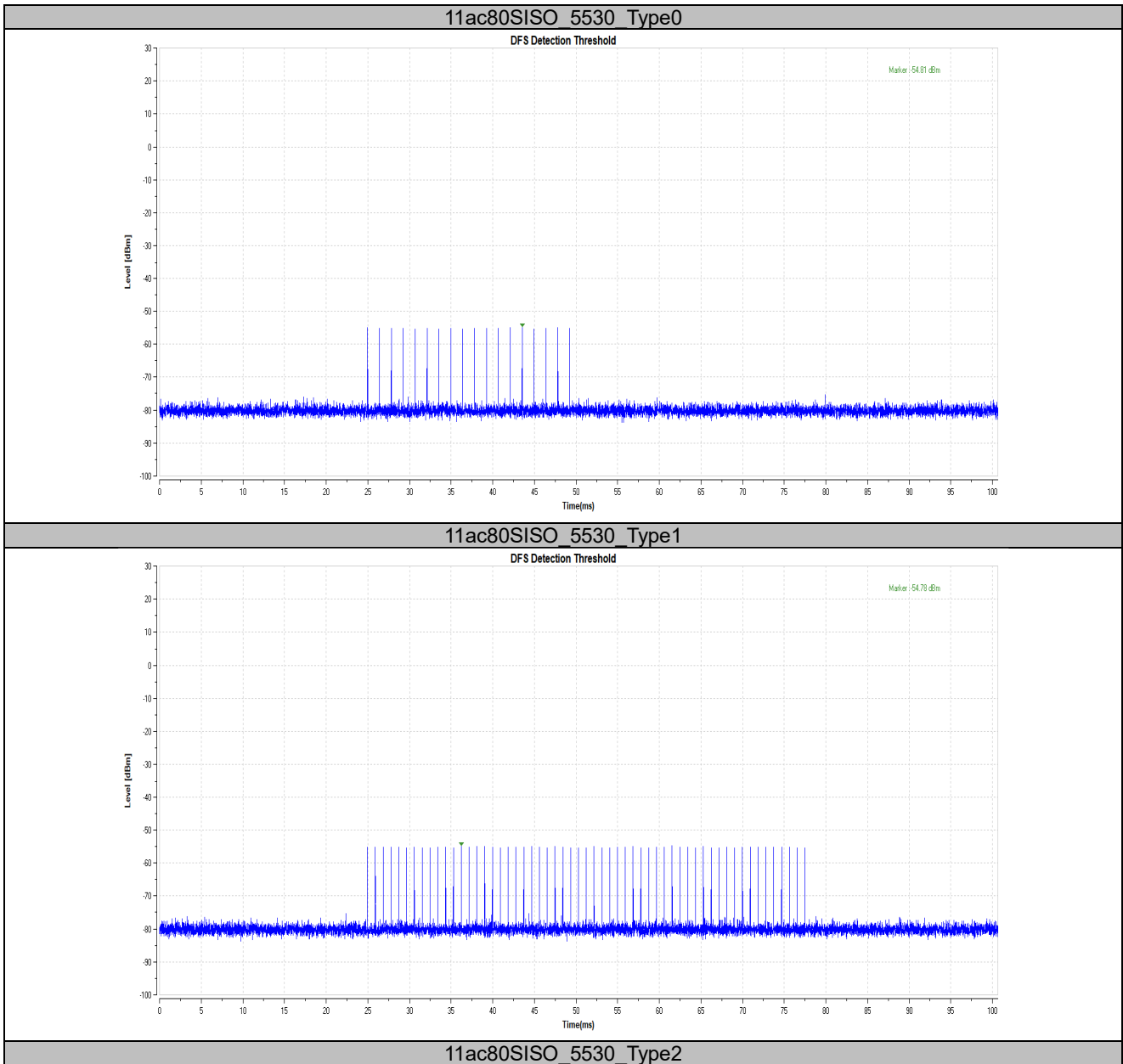

Unless otherwise agreed in writing, this document is issued by the Company subject to its General Conditions of Service printed overleaf, available on request or accessible at <http://www.sgs.com/en/Terms-and-Conditions.aspx> and, for electronic format documents, subject to Terms and Conditions for Electronic Documents at <http://www.sgs.com/en/Terms-and-Conditions/Terms-e-Documents.aspx>. Attention is drawn to the limitation of liability, indemnification and jurisdiction issues defined therein. Any holder of this document is advised that information contained hereon reflects the Company's findings at the time of its intervention only and within the limits of Client's instructions, if any. The Company's sole responsibility is to its Client and this document does not exonerate parties to a transaction from exercising all their rights and obligations under the transaction documents. This document cannot be reproduced except in full, without prior written approval of the Company. Any unauthorized alteration, forgery or falsification of the content or appearance of this document is unlawful and offenders may be prosecuted to the fullest extent of the law. Unless otherwise stated the results shown in this test report refer only to the sample(s) tested and such sample(s) are retained for 30 days only.

Attention: To check the authenticity of testing/inspection report & certificate, please contact us at telephone: (86-755) 8307 1443, or email: CN.Doccheck@sgs.com

South of No. 6 Plant, No. 1, Runsheng Road, Suzhou Industrial Park, Suzhou Area, China (Jiangsu) Pilot Free Trade Zone 215000
 中国·苏州·中国(江苏)自由贸易试验区苏州片区苏州工业园区润胜路1号的6号厂房南部 邮编: 215000

t (86-512) 62992980 www.sgsgroup.com.cn
 t (86-512) 62992980 sgs.china@sgs.com

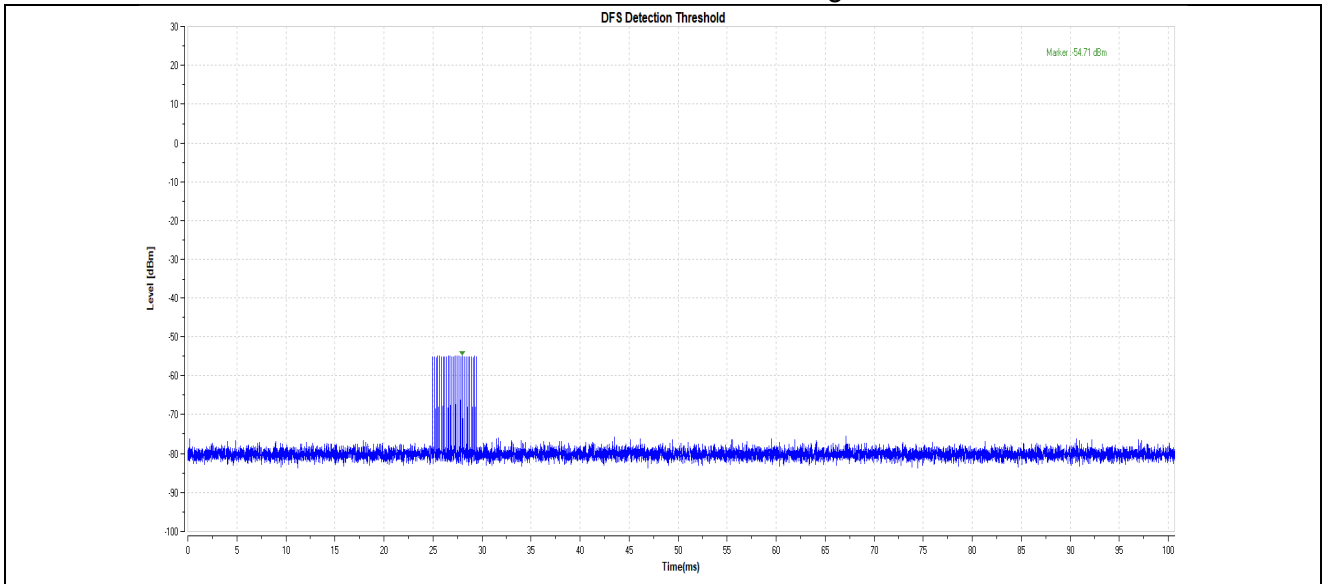

11ac80SISO 5530 Type3

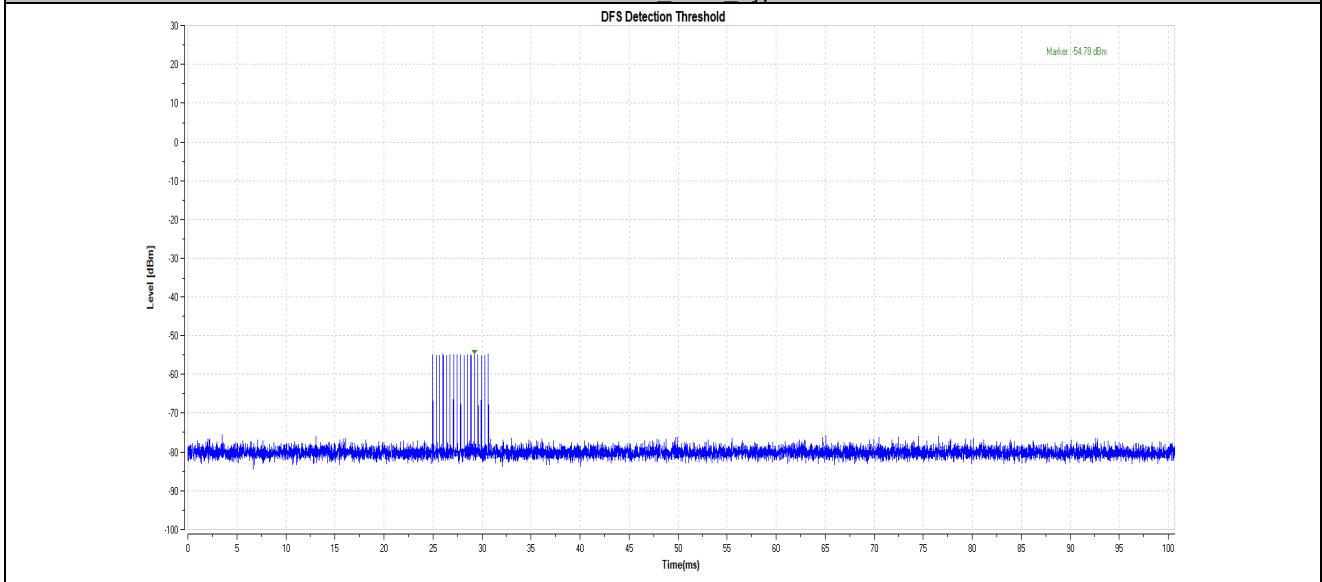

Unless otherwise agreed in writing, this document is issued by the Company subject to its General Conditions of Service printed overleaf, available on request or accessible at <http://www.sgs.com/en/Terms-and-Conditions.aspx> and, for electronic format documents, subject to Terms and Conditions for Electronic Documents at <http://www.sgs.com/en/Terms-and-Conditions/Terms-e-Documents.aspx>. Attention is drawn to the limitation of liability, indemnification and jurisdiction issues defined therein. Any holder of this document is advised that information contained hereon reflects the Company's findings at the time of its intervention only and within the limits of Client's instructions, if any. The Company's sole responsibility is to its Client and this document does not exonerate parties to a transaction from exercising all their rights and obligations under the transaction documents. This document cannot be reproduced except in full, without prior written approval of the Company. Any unauthorized alteration, forgery or falsification of the content or appearance of this document is unlawful and offenders may be prosecuted to the fullest extent of the law. Unless otherwise stated the results shown in this test report refer only to the sample(s) tested and such sample(s) are retained for 30 days only.

Attention: To check the authenticity of testing/inspection report & certificate, please contact us at telephone: (86-755) 8307 1443, or email: CN.Doccheck@sgs.com

South of No. 6 Plant, No. 1, Runsheng Road, Suzhou Industrial Park, Suzhou Area, China (Jiangsu) Pilot Free Trade Zone 215000 t (86-512) 62992980 www.sgs.com
 中国·苏州·中国(江苏)自由贸易试验区苏州片区苏州工业园区润胜路1号的6号厂房南楼 邮编: 215000 t (86-512) 62992980 sgs.china@sgs.com

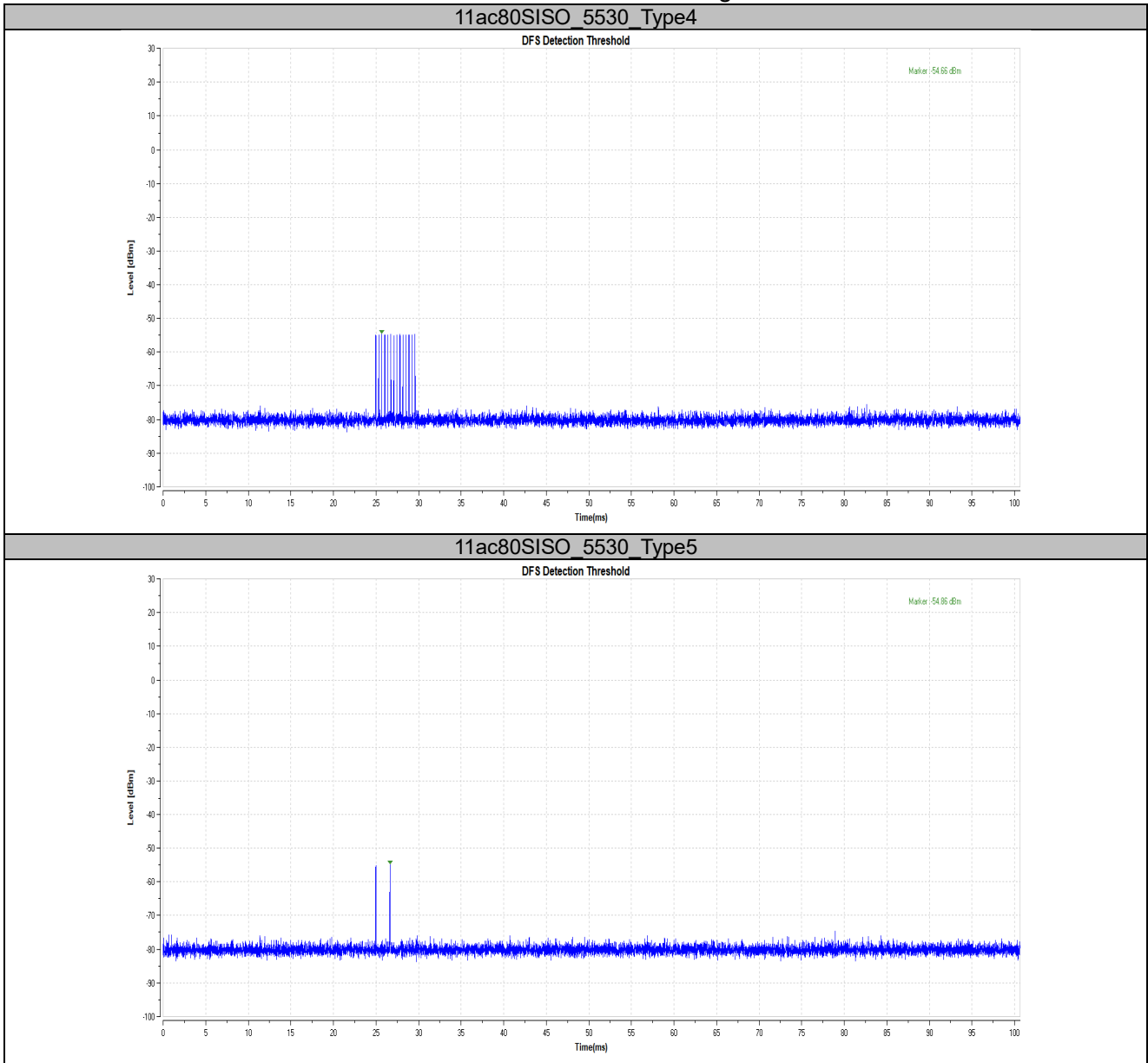

Unless otherwise agreed in writing, this document is issued by the Company subject to its General Conditions of Service printed overleaf, available on request or accessible at <http://www.sgs.com/en/Terms-and-Conditions.aspx> and, for electronic format documents, subject to Terms and Conditions for Electronic Documents at <http://www.sgs.com/en/Terms-and-Conditions/Terms-e-Documents.aspx>. Attention is drawn to the limitation of liability, indemnification and jurisdiction issues defined therein. Any holder of this document is advised that information contained hereon reflects the Company's findings at the time of its intervention only and within the limits of Client's instructions, if any. The Company's sole responsibility is to its Client and this document does not exonerate parties to a transaction from exercising all their rights and obligations under the transaction documents. This document cannot be reproduced except in full, without prior written approval of the Company. Any unauthorized alteration, forgery or falsification of the content or appearance of this document is unlawful and offenders may be prosecuted to the fullest extent of the law. Unless otherwise stated the results shown in this test report refer only to the sample(s) tested and such sample(s) are retained for 30 days only.

Attention: To check the authenticity of testing/inspection report & certificate, please contact us at telephone: (86-755) 8307 1443, or email: CN.Doccheck@sgs.com

South of No. 6 Plant, No. 1, Runsheng Road, Suzhou Industrial Park, Suzhou Area, China (Jiangsu) Pilot Free Trade Zone 215000 t (86-512) 62992980 www.sgsgroup.com.cn
 中国·苏州·中国(江苏)自由贸易试验区苏州片区苏州工业园区润胜路1号的6号厂房南楼 邮编: 215000 t (86-512) 62992980 sgs.china@sgs.com

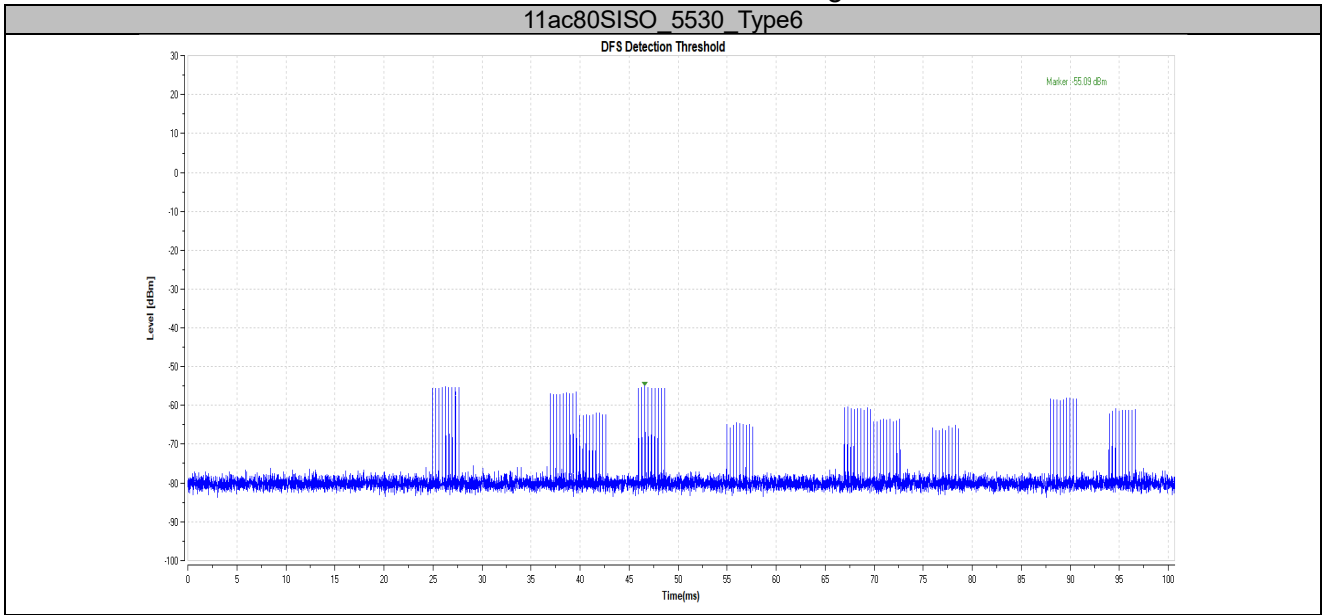

Unless otherwise agreed in writing, this document is issued by the Company subject to its General Conditions of Service printed overleaf, available on request or accessible at <http://www.sgs.com/en/Terms-and-Conditions.aspx> and, for electronic format documents, subject to Terms and Conditions for Electronic Documents at <http://www.sgs.com/en/Terms-and-Conditions/Terms-e-Documents.aspx>. Attention is drawn to the limitation of liability, indemnification and jurisdiction issues defined therein. Any holder of this document is advised that information contained hereon reflects the Company's findings at the time of its intervention only and within the limits of Client's instructions, if any. The Company's sole responsibility is to its Client and this document does not exonerate parties to a transaction from exercising all their rights and obligations under the transaction documents. This document cannot be reproduced except in full, without prior written approval of the Company. Any unauthorized alteration, forgery or falsification of the content or appearance of this document is unlawful and offenders may be prosecuted to the fullest extent of the law. Unless otherwise stated the results shown in this test report refer only to the sample(s) tested and such sample(s) are retained for 30 days only.

Attention: To check the authenticity of testing/inspection report & certificate, please contact us at telephone: (86-755) 8307 1443, or email: CN.Doccheck@sgs.com

South of No. 6 Plant, No. 1, Runsheng Road, Suzhou Industrial Park, Suzhou Area, China (Jiangsu) Pilot Free Trade Zone 215000
 中国·苏州·中国(江苏)自由贸易试验区苏州片区苏州工业园区润胜路1号的6号厂房南面 邮编: 215000

t (86-512) 62992980 www.sgs.com.cn
 t (86-512) 62992980 sgs.china@sgs.com

Data Traffic Plot
Test Graphs

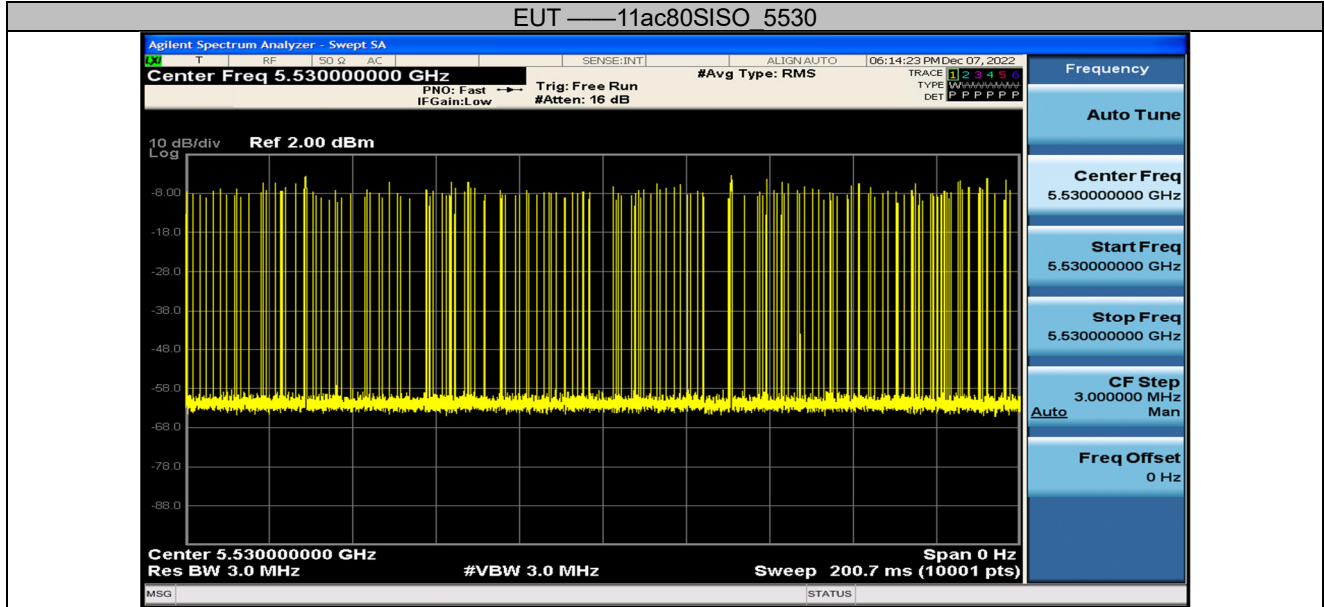

Unless otherwise agreed in writing, this document is issued by the Company subject to its General Conditions of Service printed overleaf, available on request or accessible at <http://www.sgs.com/en/Terms-and-Conditions.aspx> and, for electronic format documents, subject to Terms and Conditions for Electronic Documents at <http://www.sgs.com/en/Terms-and-Conditions/Terms-e-Documents.aspx>. Attention is drawn to the limitation of liability, indemnification and jurisdiction issues defined therein. Any holder of this document is advised that information contained hereon reflects the Company's findings at the time of its intervention only and within the limits of Client's instructions, if any. The Company's sole responsibility is to its Client and this document does not exonerate parties to a transaction from exercising all their rights and obligations under the transaction documents. This document cannot be reproduced except in full, without prior written approval of the Company. Any unauthorized alteration, forgery or falsification of the content or appearance of this document is unlawful and offenders may be prosecuted to the fullest extent of the law. Unless otherwise stated the results shown in this test report refer only to the sample(s) tested and such sample(s) are retained for 30 days only.

Attention: To check the authenticity of testing/inspection report & certificate, please contact us at telephone: (86-755) 8307 1443, or email: CN.Doccheck@sgs.com

South of No. 6 Plant, No. 1, Runsheng Road, Suzhou Industrial Park, Suzhou Area, China (Jiangsu) Pilot Free Trade Zone 215000
中国·苏州·中国(江苏)自由贸易试验区苏州片区苏州工业园区润胜路1号的6号厂房南面 邮编: 215000

t (86-512) 62992980 www.sgs.com.cn
t (86-512) 62992980 sgs.china@sgs.com

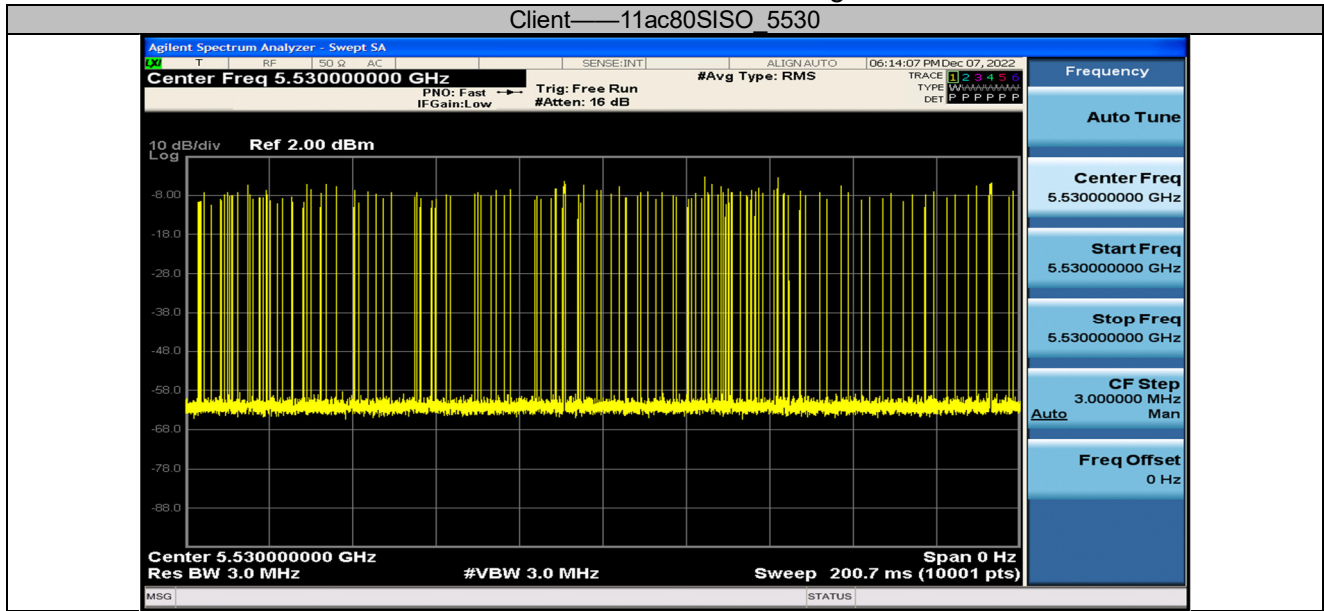

Unless otherwise agreed in writing, this document is issued by the Company subject to its General Conditions of Service printed overleaf, available on request or accessible at <http://www.sgs.com/en/Terms-and-Conditions.aspx> and, for electronic format documents, subject to Terms and Conditions for Electronic Documents at <http://www.sgs.com/en/Terms-and-Conditions/Terms-e-Documents.aspx>. Attention is drawn to the limitation of liability, indemnification and jurisdiction issues defined therein. Any holder of this document is advised that information contained hereon reflects the Company's findings at the time of its intervention only and within the limits of Client's instructions, if any. The Company's sole responsibility is to its Client and this document does not exonerate parties to a transaction from exercising all their rights and obligations under the transaction documents. This document cannot be reproduced except in full, without prior written approval of the Company. Any unauthorized alteration, forgery or falsification of the content or appearance of this document is unlawful and offenders may be prosecuted to the fullest extent of the law. Unless otherwise stated the results shown in this test report refer only to the sample(s) tested and such sample(s) are retained for 30 days only.

Attention: To check the authenticity of testing / inspection report & certificate, please contact us at telephone: (86-755) 8307 1443, or email: CN.Doccheck@sgs.com

South of No. 6 Plant, No. 1, Runsheng Road, Suzhou Industrial Park, Suzhou Area, China (Jiangsu) Pilot Free Trade Zone 215000 t (86-512) 62992980 www.sgs.com.cn
 中国·苏州·中国(江苏)自由贸易试验区苏州片区苏州工业园区润胜路1号的6号厂房南部 邮编: 215000 t (86-512) 62992980 sgs.china@sgs.com

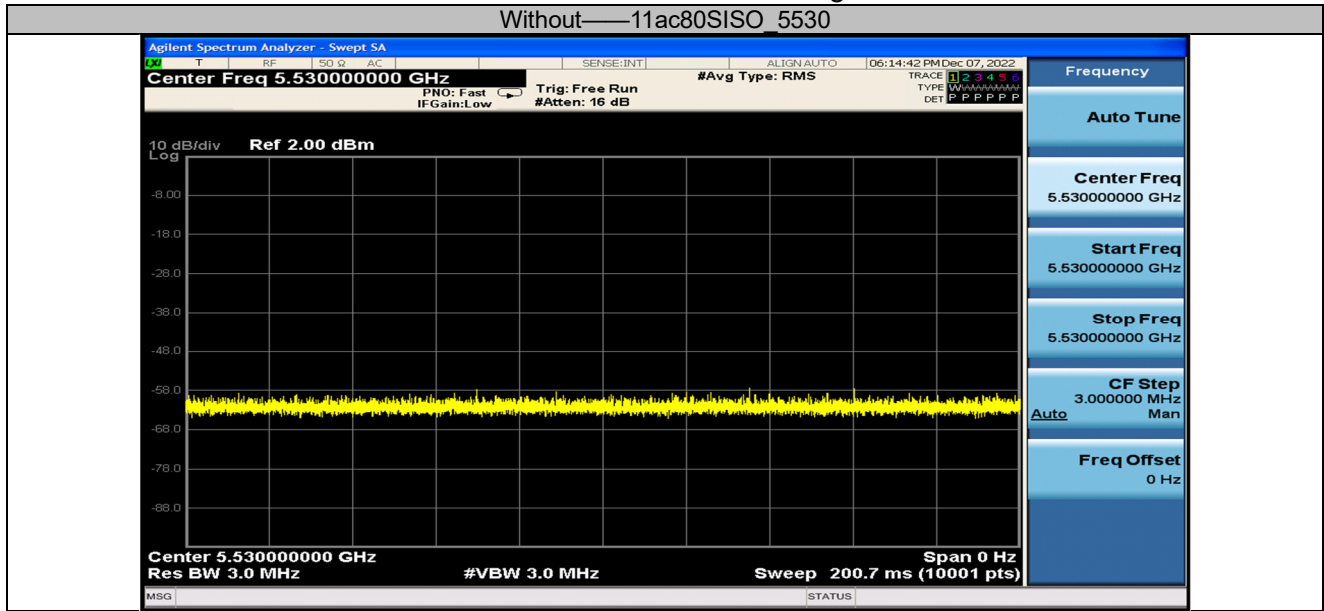

Unless otherwise agreed in writing, this document is issued by the Company subject to its General Conditions of Service printed overleaf, available on request or accessible at <http://www.sgs.com/en/Terms-and-Conditions.aspx> and, for electronic format documents, subject to Terms and Conditions for Electronic Documents at <http://www.sgs.com/en/Terms-and-Conditions/Terms-e-Documents.aspx>. Attention is drawn to the limitation of liability, indemnification and jurisdiction issues defined therein. Any holder of this document is advised that information contained hereon reflects the Company's findings at the time of its intervention only and within the limits of Client's instructions, if any. The Company's sole responsibility is to its Client and this document does not exonerate parties to a transaction from exercising all their rights and obligations under the transaction documents. This document cannot be reproduced except in full, without prior written approval of the Company. Any unauthorized alteration, forgery or falsification of the content or appearance of this document is unlawful and offenders may be prosecuted to the fullest extent of the law. Unless otherwise stated the results shown in this test report refer only to the sample(s) tested and such sample(s) are retained for 30 days.

Attention: To check the authenticity of testing/inspection report & certificate, please contact us at telephone: (86-755) 8307 1443, or email: CN.Doccheck@sgs.com

South of No. 6 Plant, No. 1, Runsheng Road, Suzhou Industrial Park, Suzhou Area, China (Jiangsu) Pilot Free Trade Zone 215000 t (86-512) 62992980 www.sgsgroup.com.cn
 中国·苏州·中国(江苏)自由贸易试验区苏州片区苏州工业园区润胜路1号的6号厂房南部 邮编: 215000 t (86-512) 62992980 sgs.china@sgs.com

Report No.: SEWA2209000044RG06

Rev.: 01

Page: 28 of 85

Channel Loading Test Result

TestMode	Frequency[MHz]	Result	Limit [%]	Verdict
11ac80SISO	5530	19.63	17	PASS



Unless otherwise agreed in writing, this document is issued by the Company subject to its General Conditions of Service printed overleaf, available on request or accessible at <http://www.sgs.com/en/Terms-and-Conditions.aspx> and, for electronic format documents, subject to Terms and Conditions for Electronic Documents at <http://www.sgs.com/en/Terms-and-Conditions/Terms-e-Documents.aspx>. Attention is drawn to the limitation of liability, indemnification and jurisdiction issues defined therein. Any holder of this document is advised that information contained hereon reflects the Company's findings at the time of its intervention only and within the limits of Client's instructions, if any. The Company's sole responsibility is to its Client and this document does not exonerate parties to a transaction from exercising all their rights and obligations under the transaction documents. This document cannot be reproduced except in full, without prior written approval of the Company. Any unauthorized alteration, forgery or falsification of the content or appearance of this document is unlawful and offenders may be prosecuted to the fullest extent of the law. Unless otherwise stated the results shown in this test report refer only to the sample(s) tested and such sample(s) are retained for 30 days only.
Attention: To check the authenticity of testing/inspection report & certificate, please contact us at telephone: (86-755) 8307 1443, or email: CN.Doccheck@sgs.com

South of No. 6 Plant, No. 1, Runsheng Road, Suzhou Industrial Park, Suzhou Area, China (Jiangsu) Pilot Free Trade Zone 215000
中国·苏州·中国(江苏)自由贸易试验区苏州片区苏州工业园区润胜路1号的6号厂房南面 邮编: 215000

t (86-512) 62992980 www.sgs.com.cn
t (86-512) 62992980 sgs.china@sgs.com

Test Graphs

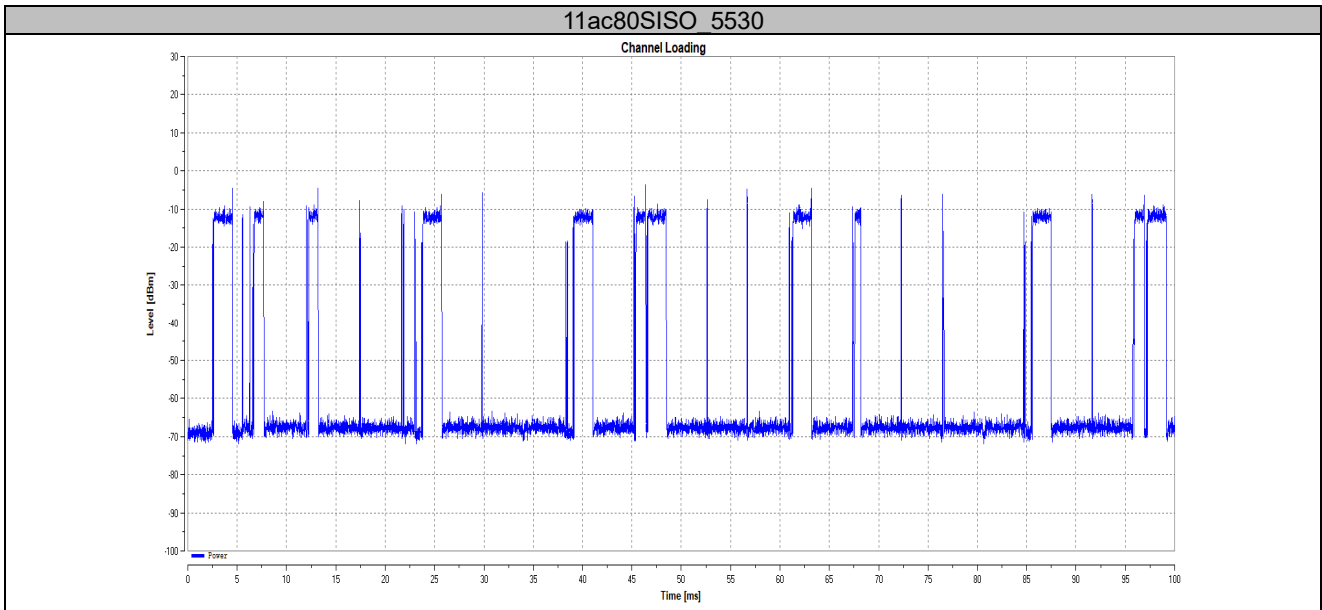

Unless otherwise agreed in writing, this document is issued by the Company subject to its General Conditions of Service printed overleaf, available on request or accessible at <http://www.sgs.com/en/Terms-and-Conditions.aspx> and, for electronic format documents, subject to Terms and Conditions for Electronic Documents at <http://www.sgs.com/en/Terms-and-Conditions/Terms-e-Documents.aspx>. Attention is drawn to the limitation of liability, indemnification and jurisdiction issues defined therein. Any holder of this document is advised that information contained hereon reflects the Company's findings at the time of its intervention only and within the limits of Client's instructions, if any. The Company's sole responsibility is to its Client and this document does not exonerate parties to a transaction from exercising all their rights and obligations under the transaction documents. This document cannot be reproduced except in full, without prior written approval of the Company. Any unauthorized alteration, forgery or falsification of the content or appearance of this document is unlawful and offenders may be prosecuted to the fullest extent of the law. Unless otherwise stated the results shown in this test report refer only to the sample(s) tested and such sample(s) are retained for 30 days only.
Attention: To check the authenticity of testing/inspection report & certificate, please contact us at telephone: (86-755) 8307 1443, or email: CN.Doccheck@sgs.com

South of No. 6 Plant, No. 1, Runsheng Road, Suzhou Industrial Park, Suzhou Area, China (Jiangsu) Pilot Free Trade Zone 215000
中国·苏州·中国(江苏)自由贸易试验区苏州片区苏州工业园区润胜路1号的6号厂房南部 邮编: 215000

t (86-512) 62992980 www.sgsgroup.com.cn
t (86-512) 62992980 sgs.china@sgs.com

Report No.: SEWA2209000044RG06

Rev.: 01

Page: 30 of 85

**Channel Availability Check Time
Test Result**

TestMode	Frequency[MHz]	Result	Verdict
11ac80SISO	5530	See test Graph	PASS

TestMode	Frequency[MHz]	Result	Verdict
11ac80SISO	5530	See test Graph	PASS

TestMode	Frequency[MHz]	Result	Verdict
11ac80SISO	5530	See test Graph	PASS



Unless otherwise agreed in writing, this document is issued by the Company subject to its General Conditions of Service printed overleaf, available on request or accessible at <http://www.sgs.com/en/Terms-and-Conditions.aspx> and, for electronic format documents, subject to Terms and Conditions for Electronic Documents at <http://www.sgs.com/en/Terms-and-Conditions/Terms-e-Documents.aspx>. Attention is drawn to the limitation of liability, indemnification and jurisdiction issues defined therein. Any holder of this document is advised that information contained hereon reflects the Company's findings at the time of its intervention only and within the limits of Client's instructions, if any. The Company's sole responsibility is to its Client and this document does not exonerate parties to a transaction from exercising all their rights and obligations under the transaction documents. This document cannot be reproduced except in full, without prior written approval of the Company. Any unauthorized alteration, forgery or falsification of the content or appearance of this document is unlawful and offenders may be prosecuted to the fullest extent of the law. Unless otherwise stated the results shown in this test report refer only to the sample(s) tested and such sample(s) are retained for 30 days only.
Attention: To check the authenticity of testing/inspection report & certificate, please contact us at telephone: (86-755) 8307 1443, or email: CN.Doccheck@sgs.com

South of No. 6 Plant, No. 1, Runsheng Road, Suzhou Industrial Park, Suzhou Area, China (Jiangsu) Pilot Free Trade Zone 215000 t (86-512) 62992980 www.sgs.com.cn
 中国·苏州·中国(江苏)自由贸易试验区苏州片区苏州工业园区润胜路1号的6号厂房南楼 邮编: 215000 t (86-512) 62992980 sgs.china@sgs.com

Test Graphs

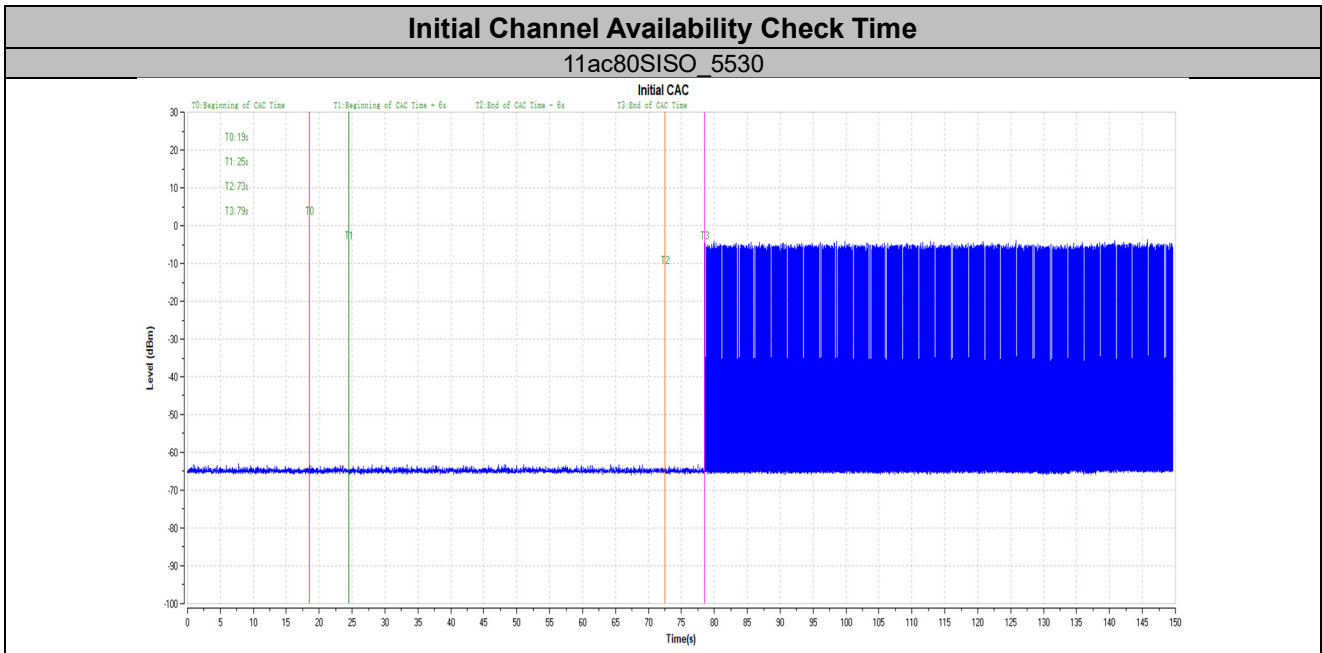

Unless otherwise agreed in writing, this document is issued by the Company subject to its General Conditions of Service printed overleaf, available on request or accessible at <http://www.sgs.com/en/Terms-and-Conditions.aspx> and, for electronic format documents, subject to Terms and Conditions for Electronic Documents at <http://www.sgs.com/en/Terms-and-Conditions/Terms-e-Documents.aspx>. Attention is drawn to the limitation of liability, indemnification and jurisdiction issues defined therein. Any holder of this document is advised that information contained hereon reflects the Company's findings at the time of its intervention only and within the limits of Client's instructions, if any. The Company's sole responsibility is to its Client and this document does not exonerate parties to a transaction from exercising all their rights and obligations under the transaction documents. This document cannot be reproduced except in full, without prior written approval of the Company. Any unauthorized alteration, forgery or falsification of the content or appearance of this document is unlawful and offenders may be prosecuted to the fullest extent of the law. Unless otherwise stated the results shown in this test report refer only to the sample(s) tested and such sample(s) are retained for 30 days.

Attention: To check the authenticity of testing/inspection report & certificate, please contact us at telephone: (86-755) 8307 1443, or email: CN.Doccheck@sgs.com

South of No. 6 Plant, No. 1, Runsheng Road, Suzhou Industrial Park, Suzhou Area, China (Jiangsu) Pilot Free Trade Zone 215000
 中国·苏州·中国(江苏)自由贸易试验区苏州片区苏州工业园区润胜路1号的6号厂房南楼 邮编: 215000

t (86-512) 62992980 www.sgs.com.cn
 t (86-512) 62992980 sgs.china@sgs.com

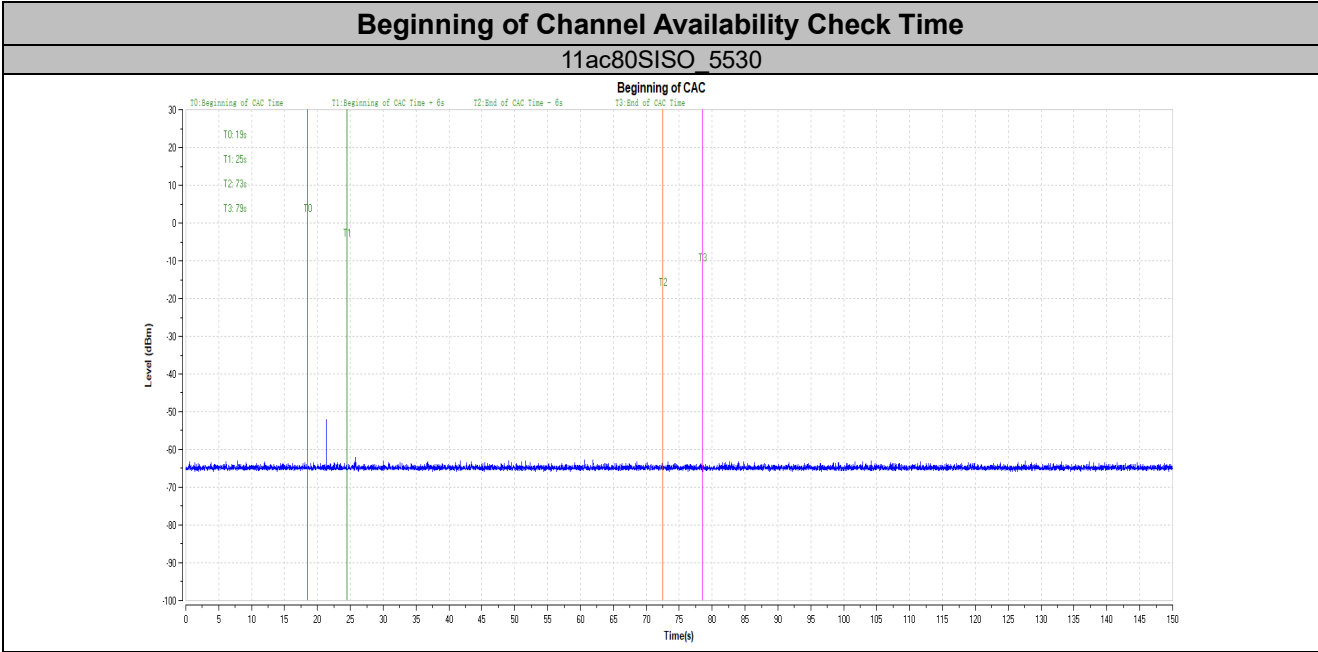

Unless otherwise agreed in writing, this document is issued by the Company subject to its General Conditions of Service printed overleaf, available on request or accessible at <http://www.sgs.com/en/Terms-and-Conditions.aspx> and, for electronic format documents, subject to Terms and Conditions for Electronic Documents at <http://www.sgs.com/en/Terms-and-Conditions/Terms-e-Documents.aspx>. Attention is drawn to the limitation of liability, indemnification and jurisdiction issues defined therein. Any holder of this document is advised that information contained hereon reflects the Company's findings at the time of its intervention only and within the limits of Client's instructions, if any. The Company's sole responsibility is to its Client and this document does not exonerate parties to a transaction from exercising all their rights and obligations under the transaction documents. This document cannot be reproduced except in full, without prior written approval of the Company. Any unauthorized alteration, forgery or falsification of the content or appearance of this document is unlawful and offenders may be prosecuted to the fullest extent of the law. Unless otherwise stated the results shown in this test report refer only to the sample(s) tested and such sample(s) are retained for 30 days.

Attention: To check the authenticity of testing/inspection report & certificate, please contact us at telephone: (86-755) 8307 1443, or email: CN.Doccheck@sgs.com

South of No. 6 Plant, No. 1, Runsheng Road, Suzhou Industrial Park, Suzhou Area, China (Jiangsu) Pilot Free Trade Zone 215000 t (86-512) 62992980 www.sgs.com.cn
 中国·苏州·中国(江苏)自由贸易试验区苏州片区苏州工业园区润胜路1号的6号厂房南楼 邮编: 215000 t (86-512) 62992980 sgs.china@sgs.com

End of Channel Availability Check Time

11ac80SISO_5530

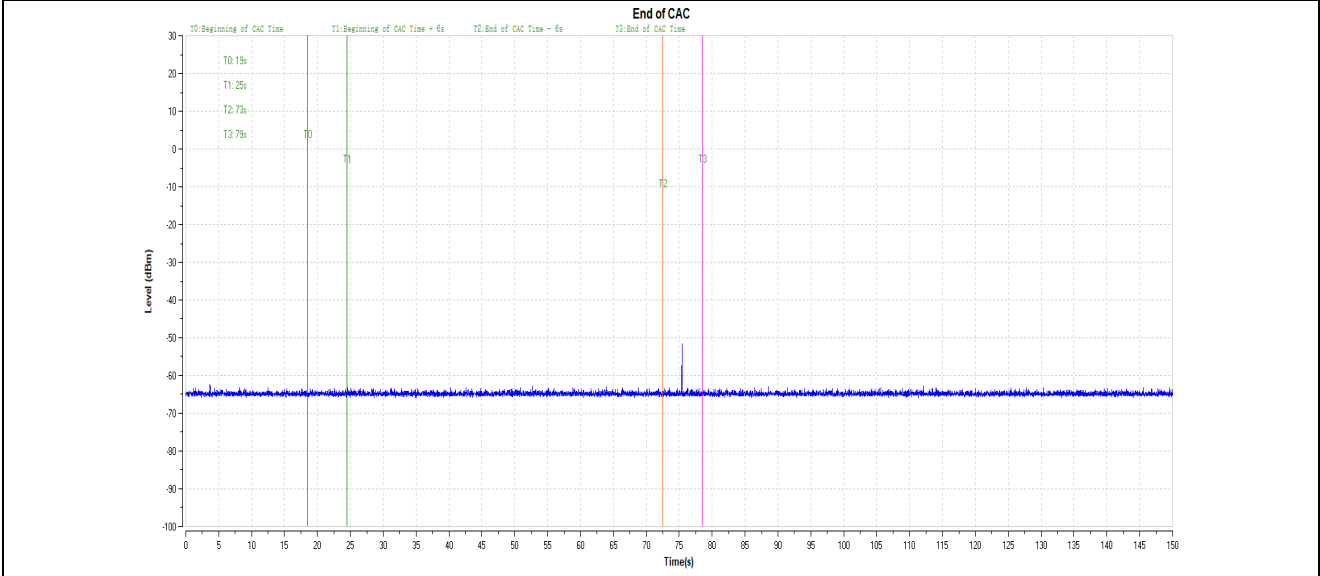

Unless otherwise agreed in writing, this document is issued by the Company subject to its General Conditions of Service printed overleaf, available on request or accessible at <http://www.sgs.com/en/Terms-and-Conditions.aspx> and, for electronic format documents, subject to Terms and Conditions for Electronic Documents at <http://www.sgs.com/en/Terms-and-Conditions/Terms-e-Documents.aspx>. Attention is drawn to the limitation of liability, indemnification and jurisdiction issues defined therein. Any holder of this document is advised that information contained hereon reflects the Company's findings at the time of its intervention only and within the limits of Client's instructions, if any. The Company's sole responsibility is to its Client and this document does not exonerate parties to a transaction from exercising all their rights and obligations under the transaction documents. This document cannot be reproduced except in full, without prior written approval of the Company. Any unauthorized alteration, forgery or falsification of the content or appearance of this document is unlawful and offenders may be prosecuted to the fullest extent of the law. Unless otherwise stated the results shown in this test report refer only to the sample(s) tested and such sample(s) are retained for 30 days.
Attention: To check the authenticity of testing/inspection report & certificate, please contact us at telephone: (86-755) 8307 1443, or email: CN.Doccheck@sgs.com

South of No. 6 Plant, No. 1, Runsheng Road, Suzhou Industrial Park, Suzhou Area, China (Jiangsu) Pilot Free Trade Zone 215000
中国·苏州·中国(江苏)自由贸易试验区苏州片区苏州工业园区润胜路1号的6号厂房南楼 邮编: 215000

t (86-512) 62992980 www.sgs.com.cn
t (86-512) 62992980 sgs.china@sgs.com

Report No.: SEWA2209000044RG06

Rev.: 01

Page: 34 of 85

Channel Move Time and Channel Closing Transmission Time Test Result

TestMode	Frequency[MHz]	CCTT[ms]	Limit[ms]	CMT[ms]	Limit[ms]	Verdict
11ac80SISO	5530	200+55.9	200+60	998.1	10000	PASS



Unless otherwise agreed in writing, this document is issued by the Company subject to its General Conditions of Service printed overleaf, available on request or accessible at <http://www.sgs.com/en/Terms-and-Conditions.aspx> and, for electronic format documents, subject to Terms and Conditions for Electronic Documents at <http://www.sgs.com/en/Terms-and-Conditions/Terms-e-Documents.aspx>. Attention is drawn to the limitation of liability, indemnification and jurisdiction issues defined therein. Any holder of this document is advised that information contained hereon reflects the Company's findings at the time of its intervention only and within the limits of Client's instructions, if any. The Company's sole responsibility is to its Client and this document does not exonerate parties to a transaction from exercising all their rights and obligations under the transaction documents. This document cannot be reproduced except in full, without prior written approval of the Company. Any unauthorized alteration, forgery or falsification of the content or appearance of this document is unlawful and offenders may be prosecuted to the fullest extent of the law. Unless otherwise stated the results shown in this test report refer only to the sample(s) tested and such sample(s) are retained for 30 days only.
Attention: To check the authenticity of testing/inspection report & certificate, please contact us at telephone: (86-755) 8307 1443, or email: CN.Doccheck@sgs.com

South of No. 6 Plant, No. 1, Runsheng Road, Suzhou Industrial Park, Suzhou Area, China (Jiangsu) Pilot Free Trade Zone 215000
 中国·苏州·中国(江苏)自由贸易试验区苏州片区苏州工业园区润胜路1号的6号厂房南面 邮编: 215000

t (86-512) 62992980 www.sgs.com.cn
 t (86-512) 62992980 sgs.china@sgs.com

Test Graphs

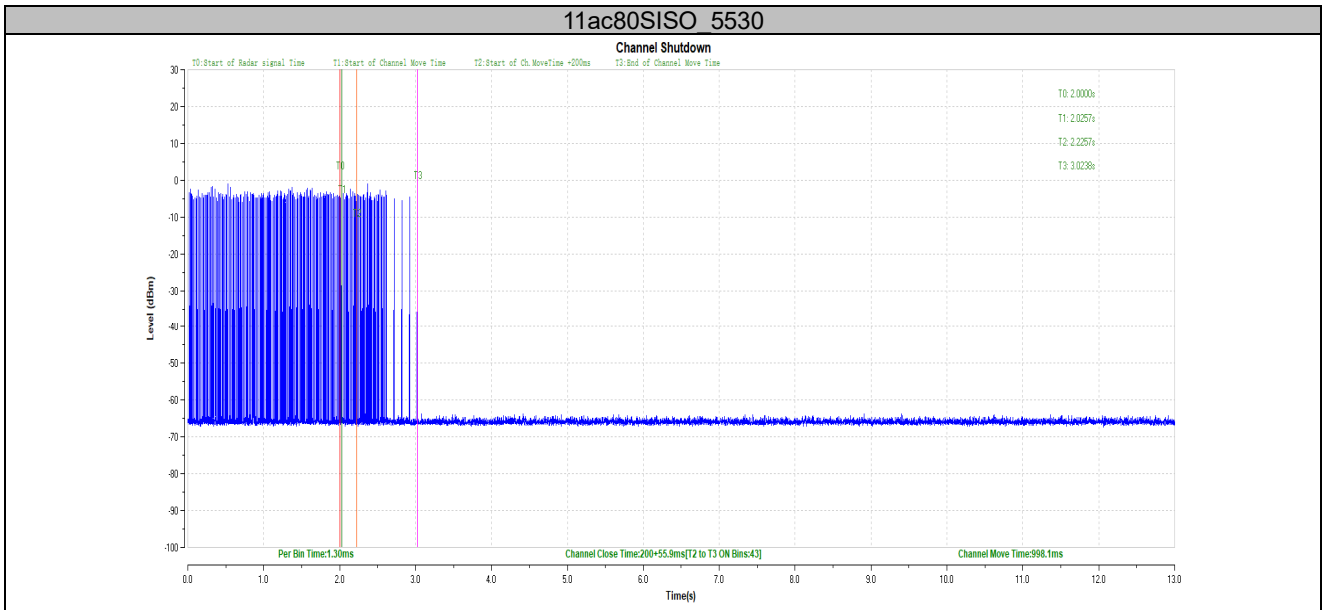

Unless otherwise agreed in writing, this document is issued by the Company subject to its General Conditions of Service printed overleaf, available on request or accessible at <http://www.sgs.com/en/Terms-and-Conditions.aspx> and, for electronic format documents, subject to Terms and Conditions for Electronic Documents at <http://www.sgs.com/en/Terms-and-Conditions/Terms-e-Documents.aspx>. Attention is drawn to the limitation of liability, indemnification and jurisdiction issues defined therein. Any holder of this document is advised that information contained hereon reflects the Company's findings at the time of its intervention only and within the limits of Client's instructions, if any. The Company's sole responsibility is to its Client and this document does not exonerate parties to a transaction from exercising all their rights and obligations under the transaction documents. This document cannot be reproduced except in full, without prior written approval of the Company. Any unauthorized alteration, forgery or falsification of the content or appearance of this document is unlawful and offenders may be prosecuted to the fullest extent of the law. Unless otherwise stated the results shown in this test report refer only to the sample(s) tested and such sample(s) are retained for 30 days only.

Attention: To check the authenticity of testing/inspection report & certificate, please contact us at telephone: (86-755) 8307 1443, or email: CN.Doccheck@sgs.com

South of No. 6 Plant, No. 1, Runsheng Road, Suzhou Industrial Park, Suzhou Area, China (Jiangsu) Pilot Free Trade Zone 215000 t (86-512) 62992980 www.sgs.com.cn
 中国·苏州·中国(江苏)自由贸易试验区苏州片区苏州工业园区润胜路1号的6号厂房南楼 邮编: 215000 t (86-512) 62992980 sgs.china@sgs.com



Report No.: SEWA2209000044RG06

Rev.: 01

Page: 36 of 85

Non-Occupancy Period

Test Result

TestMode	Frequency[MHz]	Result	Limit[s]	Verdict
11ac80SISO	5530	see test graph	≥1800	PASS



Unless otherwise agreed in writing, this document is issued by the Company subject to its General Conditions of Service printed overleaf, available on request or accessible at <http://www.sgs.com/en/Terms-and-Conditions.aspx> and, for electronic format documents, subject to Terms and Conditions for Electronic Documents at <http://www.sgs.com/en/Terms-and-Conditions/Terms-e-Documents.aspx>. Attention is drawn to the limitation of liability, indemnification and jurisdiction issues defined therein. Any holder of this document is advised that information contained hereon reflects the Company's findings at the time of its intervention only and within the limits of Client's instructions, if any. The Company's sole responsibility is to its Client and this document does not exonerate parties to a transaction from exercising all their rights and obligations under the transaction documents. This document cannot be reproduced except in full, without prior written approval of the Company. Any unauthorized alteration, forgery or falsification of the content or appearance of this document is unlawful and offenders may be prosecuted to the fullest extent of the law. Unless otherwise stated the results shown in this test report refer only to the sample(s) tested and such sample(s) are retained for 30 days only.

Attention: To check the authenticity of testing/inspection report & certificate, please contact us at telephone: (86-755) 8307 1443, or email: CN.Doccheck@sgs.com

South of No. 6 Plant, No. 1, Runsheng Road, Suzhou Industrial Park, Suzhou Area, China (Jiangsu) Pilot Free Trade Zone 215000 t (86-512) 62992980 www.sgs.com.cn
 中国·苏州·中国(江苏)自由贸易试验区苏州片区苏州工业园区润胜路1号的6号厂房南楼 邮编: 215000 t (86-512) 62992980 sgs.china@sgs.com

Test Graphs

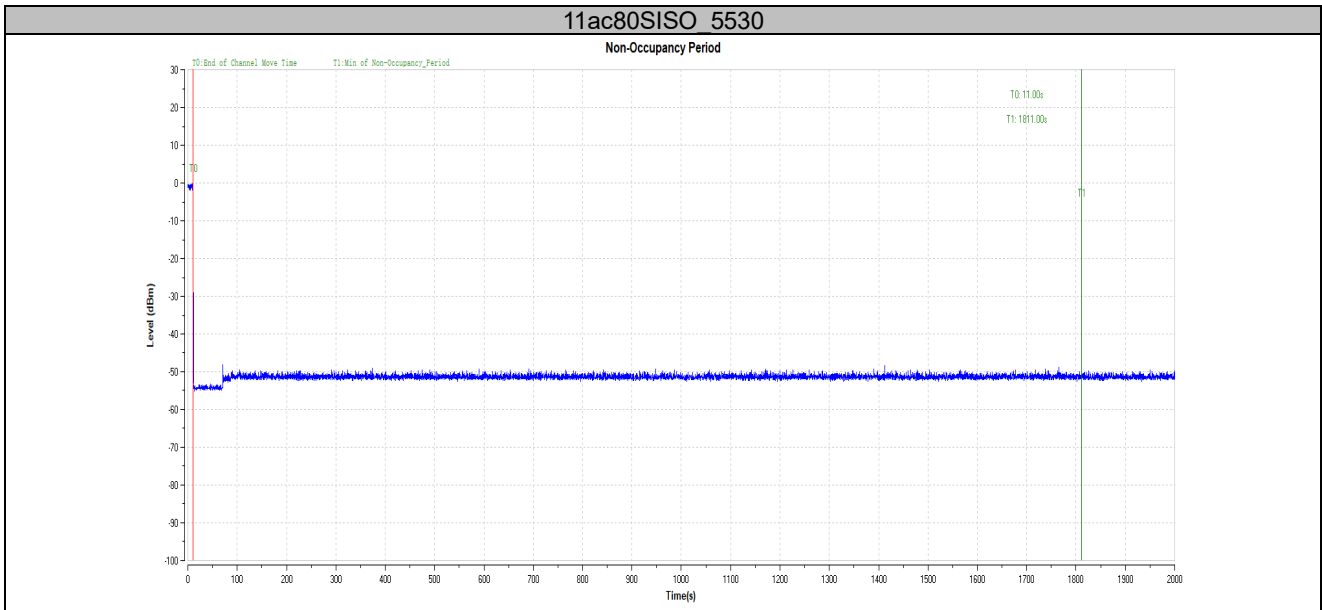

Unless otherwise agreed in writing, this document is issued by the Company subject to its General Conditions of Service printed overleaf, available on request or accessible at <http://www.sgs.com/en/Terms-and-Conditions.aspx> and, for electronic format documents, subject to Terms and Conditions for Electronic Documents at <http://www.sgs.com/en/Terms-and-Conditions/Terms-e-Documents.aspx>. Attention is drawn to the limitation of liability, indemnification and jurisdiction issues defined therein. Any holder of this document is advised that information contained hereon reflects the Company's findings at the time of its intervention only and within the limits of Client's instructions, if any. The Company's sole responsibility is to its Client and this document does not exonerate parties to a transaction from exercising all their rights and obligations under the transaction documents. This document cannot be reproduced except in full, without prior written approval of the Company. Any unauthorized alteration, forgery or falsification of the content or appearance of this document is unlawful and offenders may be prosecuted to the fullest extent of the law. Unless otherwise stated the results shown in this test report refer only to the sample(s) tested and such sample(s) are retained for 30 days.

Attention: To check the authenticity of testing/inspection report & certificate, please contact us at telephone: (86-755) 8307 1443, or email: CN.Doccheck@sgs.com

South of No. 6 Plant, No. 1, Runsheng Road, Suzhou Industrial Park, Suzhou Area, China (Jiangsu) Pilot Free Trade Zone 215000
 中国·苏州·中国(江苏)自由贸易试验区苏州片区苏州工业园区润胜路1号的6号厂房南面 邮编: 215000

t (86-512) 62992980 www.sgs.com
 t (86-512) 62992980 sgs.china@sgs.com

U-NII Detection Bandwidth

Test Result

TestMode	Frequency[MHz]	FL[MHz]	FH[MHz]	Detection Bandwidth [MHz]	OCB [MHz]	Ratio [%]	Limit [%]	Verdict
11ac20SISO	5500	5490	5510	20	18.858	106.05	≥100	PASS
11ac40SISO	5510	5490	5530	40	36.337	110.08	≥100	PASS
11ac80SISO	5530	5490	5570	80	76.350	104.77	≥100	PASS



Unless otherwise agreed in writing, this document is issued by the Company subject to its General Conditions of Service printed overleaf, available on request or accessible at <http://www.sgs.com/en/Terms-and-Conditions.aspx> and, for electronic format documents, subject to Terms and Conditions for Electronic Documents at <http://www.sgs.com/en/Terms-and-Conditions/Terms-e-Documents.aspx>. Attention is drawn to the limitation of liability, indemnification and jurisdiction issues defined therein. Any holder of this document is advised that information contained hereon reflects the Company's findings at the time of its intervention only and within the limits of Client's instructions, if any. The Company's sole responsibility is to its Client and this document does not exonerate parties to a transaction from exercising all their rights and obligations under the transaction documents. This document cannot be reproduced except in full, without prior written approval of the Company. Any unauthorized alteration, forgery or falsification of the content or appearance of this document is unlawful and offenders may be prosecuted to the fullest extent of the law. Unless otherwise stated the results shown in this test report refer only to the sample(s) tested and such sample(s) are retained for 30 days only.

Attention: To check the authenticity of testing/inspection report & certificate, please contact us at telephone: (86-755) 8307 1443, or email: CN.Doccheck@sgs.com

South of No. 6 Plant, No. 1, Runsheng Road, Suzhou Industrial Park, Suzhou Area, China (Jiangsu) Pilot Free Trade Zone 215000
 中国·苏州·中国(江苏)自由贸易试验区苏州片区苏州工业园区润胜路1号的6号厂房南楼 邮编: 215000

t (86-512) 62992980 www.sgs.com.cn
 t (86-512) 62992980 sgs.china@sgs.com

Test Mode	Frequency[MHz]	Radar Freq.	Trial 1	Trial 2	Trial 3	Trial 4	Trial 5	Trial 6	Trial 7	Trial 8	Trial 9	Trial 10	Ratio (%)	
11ac20SISO	5500	5485	0	0	0	0	0	0	0	0	0	0	0	
		5486	0	0	0	0	0	0	0	0	0	0	0	0
		5487	0	0	0	0	0	0	0	0	0	0	0	0
		5488	0	0	0	0	0	0	0	0	0	0	0	0
		5489	0	0	0	0	0	0	0	0	0	0	0	0
		5490	1	1	1	1	1	1	1	1	1	1	1	100
		5495	1	1	1	1	1	1	1	1	1	1	1	100
		5500	1	1	1	1	1	1	1	1	1	1	1	100
		5505	1	1	1	1	1	1	1	1	1	1	1	100
		5510	1	1	1	1	1	1	1	1	1	1	1	100
		5511	0	0	0	0	0	0	0	0	0	0	0	0
		5512	0	0	0	0	0	0	0	0	0	0	0	0
		5513	0	0	0	0	0	0	0	0	0	0	0	0
		5514	0	0	0	0	0	0	0	0	0	0	0	0
5515	0	0	0	0	0	0	0	0	0	0	0	0		
11ac40SISO	5510	5485	0	0	0	0	0	0	0	0	0	0	0	
		5486	0	0	0	0	0	0	0	0	0	0	0	0
		5487	0	0	0	0	0	0	0	0	0	0	0	0
		5488	0	0	0	0	0	0	0	0	0	0	0	0
		5489	0	0	0	0	0	0	0	0	0	0	0	0
		5490	1	1	1	1	1	1	1	1	1	1	1	100
		5495	1	1	1	1	1	1	1	1	1	1	1	100
		5500	1	1	1	1	1	1	1	1	1	1	1	100
		5505	1	1	1	1	1	1	1	1	1	1	1	100
		5510	1	1	1	1	1	1	1	1	1	1	1	100
		5515	1	1	1	1	1	1	1	1	1	1	1	100
		5520	1	1	1	1	1	1	1	1	1	1	1	100
		5525	1	1	1	1	1	1	1	1	1	1	1	100
		5530	1	1	1	1	1	1	1	1	1	1	1	100
		5531	0	0	0	0	0	0	0	0	0	0	0	0
		5532	0	0	0	0	0	0	0	0	0	0	0	0
		5533	0	0	0	0	0	0	0	0	0	0	0	0
		5534	0	0	0	0	0	0	0	0	0	0	0	0
5535	0	0	0	0	0	0	0	0	0	0	0	0		
11ac80SISO	5530	5485	0	0	0	0	0	0	0	0	0	0	0	
		5486	0	0	0	0	0	0	0	0	0	0	0	0
		5487	0	0	0	0	0	0	0	0	0	0	0	0
		5488	0	0	0	0	0	0	0	0	0	0	0	0
		5489	0	0	0	0	0	0	0	0	0	0	0	0
		5490	1	1	1	1	1	1	1	1	1	1	1	100
		5495	1	1	1	1	1	1	1	1	1	1	1	100
		5500	1	1	1	1	1	1	1	1	1	1	1	100
		5505	1	1	1	1	1	1	1	1	1	1	1	100
		5510	1	1	1	1	1	1	1	1	1	1	1	100
		5515	1	1	1	1	1	1	1	1	1	1	1	100
		5520	1	1	1	1	1	1	1	1	1	1	1	100
		5525	1	1	1	1	1	1	1	1	1	1	1	100
		5530	1	1	1	1	1	1	1	1	1	1	1	100
		5535	1	1	1	1	1	1	1	1	1	1	1	100
		5540	1	1	1	1	1	1	1	1	1	1	1	100
		5545	1	1	1	1	1	1	1	1	1	1	1	100
		5550	1	1	1	1	1	1	1	1	1	1	1	100
		5555	1	1	1	1	1	1	1	1	1	1	1	100
		5560	1	1	1	1	1	1	1	1	1	1	1	100
5565	1	1	1	1	1	1	1	1	1	1	1	100		



Unless otherwise agreed in writing, this document is issued by the Company subject to its General Conditions of Service printed overleaf, available on request or accessible at <http://www.sgs.com/en/Terms-and-Conditions.aspx> and, for electronic format documents, subject to Terms and Conditions for Electronic Documents at <http://www.sgs.com/en/Terms-and-Conditions/Terms-e-Documents.aspx>. Attention is drawn to the limitation of liability, indemnification and jurisdiction issues defined therein. Any holder of this document is advised that information contained hereon reflects the Company's findings at the time of its intervention only and within the limits of Client's instructions, if any. The Company's sole responsibility is to its Client and this document does not exonerate parties to a transaction from exercising all their rights and obligations under the transaction documents. This document cannot be reproduced except in full, without prior written approval of the Company. Any unauthorized alteration, forgery or falsification of the content or appearance of this document is unlawful and offenders may be prosecuted to the fullest extent of the law. Unless otherwise stated the results shown in this test report refer only to the sample(s) tested and such sample(s) are retained for 30 days only.

Attention: To check the authenticity of testing/inspection report & certificate, please contact us at telephone: (86-755) 8307 1443, or email: CN.Doccheck@sgs.com

South of No. 6 Plant, No. 1, Runsheng Road, Suzhou Industrial Park, Suzhou Area, China (Jiangsu) Pilot Free Trade Zone 215000 t (86-512) 62992980 www.sgs.com.cn
 中国·苏州·中国(江苏)自由贸易试验区苏州片区工业园区润胜路1号的6号厂房南楼 邮编: 215000 t (86-512) 62992980 sgs.china@sgs.com

Report No.: SEWA2209000044RG06

Rev.: 01

Page: 40 of 85

		5570	1	1	1	1	1	1	1	1	1	1	100
		5571	0	0	0	0	0	0	0	0	0	0	0
		5572	0	0	0	0	0	0	0	0	0	0	0
		5573	0	0	0	0	0	0	0	0	0	0	0
		5574	0	0	0	0	0	0	0	0	0	0	0
		5575	0	0	0	0	0	0	0	0	0	0	0



Unless otherwise agreed in writing, this document is issued by the Company subject to its General Conditions of Service printed overleaf, available on request or accessible at <http://www.sgs.com/en/Terms-and-Conditions.aspx> and, for electronic format documents, subject to Terms and Conditions for Electronic Documents at <http://www.sgs.com/en/Terms-and-Conditions/Terms-e-Documents.aspx>. Attention is drawn to the limitation of liability, indemnification and jurisdiction issues defined therein. Any holder of this document is advised that information contained hereon reflects the Company's findings at the time of its intervention only and within the limits of Client's instructions, if any. The Company's sole responsibility is to its Client and this document does not exonerate parties to a transaction from exercising all their rights and obligations under the transaction documents. This document cannot be reproduced except in full, without prior written approval of the Company. Any unauthorized alteration, forgery or falsification of the content or appearance of this document is unlawful and offenders may be prosecuted to the fullest extent of the law. Unless otherwise stated the results shown in this test report refer only to the sample(s) tested and such sample(s) are retained for 30 days only.
Attention: To check the authenticity of testing/inspection report & certificate, please contact us at telephone: (86-755) 8307 1443, or email: CN.Doccheck@sgs.com

South of No. 6 Plant, No. 1, Runsheng Road, Suzhou Industrial Park, Suzhou Area, China (Jiangsu) Pilot Free Trade Zone 215000 t (86-512) 62992980 www.sgs.com.cn
 中国·苏州·中国(江苏)自由贸易试验区苏州片区苏州工业园区润胜路1号的6号厂房南楼 邮编: 215000 t (86-512) 62992980 sgs.china@sgs.com

Test Graphs

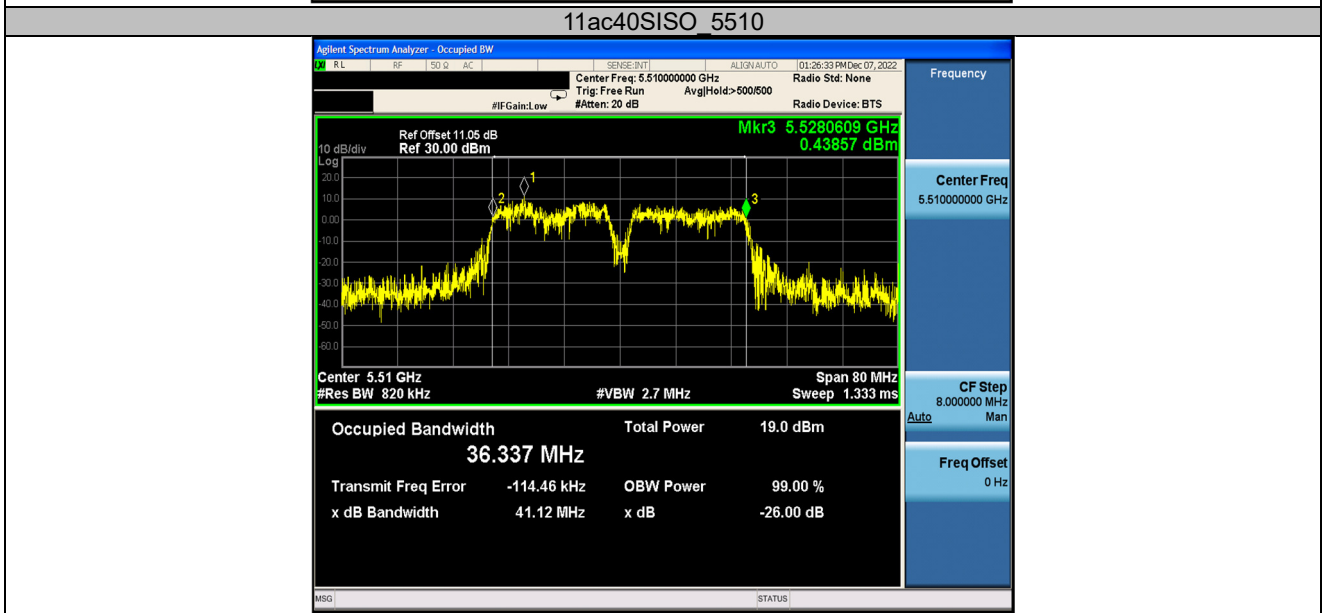
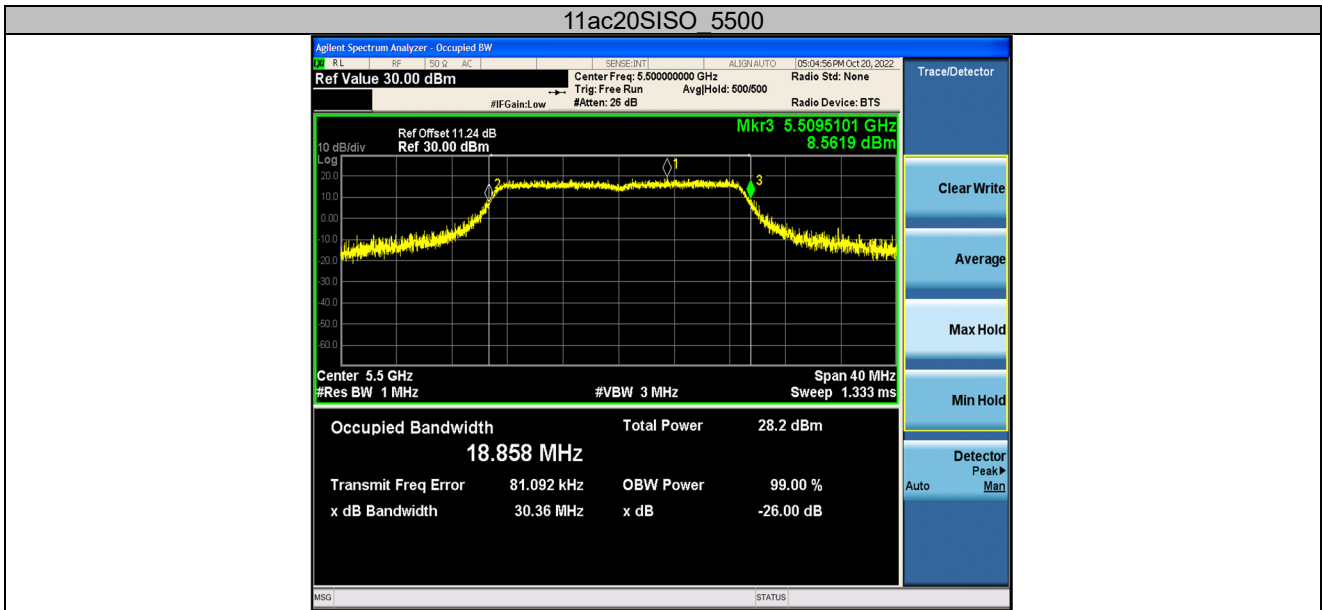

11ac80SISO_5530



Unless otherwise agreed in writing, this document is issued by the Company subject to its General Conditions of Service printed overleaf, available on request or accessible at <http://www.sgs.com/en/Terms-and-Conditions.aspx> and, for electronic format documents, subject to Terms and Conditions for Electronic Documents at <http://www.sgs.com/en/Terms-and-Conditions/Terms-e-Documents.aspx>. Attention is drawn to the limitation of liability, indemnification and jurisdiction issues defined therein. Any holder of this document is advised that information contained hereon reflects the Company's findings at the time of its intervention only and within the limits of Client's instructions, if any. The Company's sole responsibility is to its Client and this document does not exonerate parties to a transaction from exercising all their rights and obligations under the transaction documents. This document cannot be reproduced except in full, without prior written approval of the Company. Any unauthorized alteration, forgery or falsification of the content or appearance of this document is unlawful and offenders may be prosecuted to the fullest extent of the law. Unless otherwise stated the results shown in this test report refer only to the sample(s) tested and such sample(s) are retained for 30 days only.

Attention: To check the authenticity of testing/inspection report & certificate, please contact us at telephone: (86-755) 8307 1443, or email: CN.Doccheck@sgs.com

South of No. 6 Plant, No. 1, Runsheng Road, Suzhou Industrial Park, Suzhou Area, China (Jiangsu) Pilot Free Trade Zone 215000 t (86-512) 62992980 www.sgsgroup.com.cn
中国·苏州·中国(江苏)自由贸易试验区苏州片区工业园区润胜路1号的6号厂房南部 邮编: 215000 t (86-512) 62992980 sgs.china@sgs.com

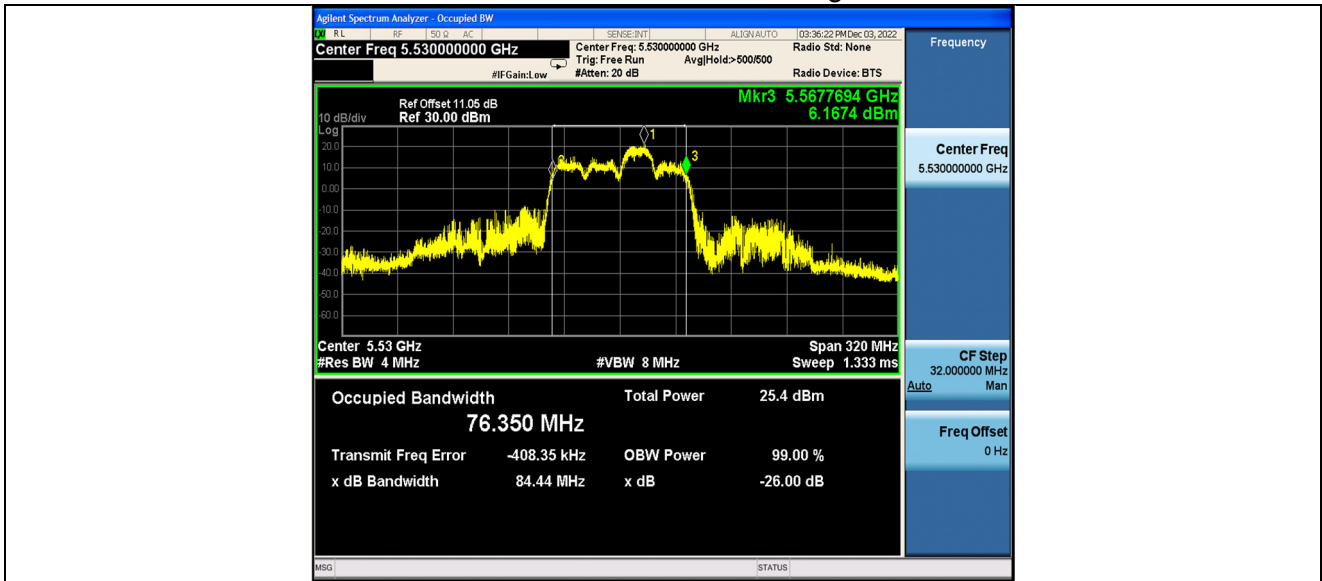

Unless otherwise agreed in writing, this document is issued by the Company subject to its General Conditions of Service printed overleaf, available on request or accessible at <http://www.sgs.com/en/Terms-and-Conditions.aspx> and, for electronic format documents, subject to Terms and Conditions for Electronic Documents at <http://www.sgs.com/en/Terms-and-Conditions/Terms-e-Documents.aspx>. Attention is drawn to the limitation of liability, indemnification and jurisdiction issues defined therein. Any holder of this document is advised that information contained hereon reflects the Company's findings at the time of its intervention only and within the limits of Client's instructions, if any. The Company's sole responsibility is to its Client and this document does not exonerate parties to a transaction from exercising all their rights and obligations under the transaction documents. This document cannot be reproduced except in full, without prior written approval of the Company. Any unauthorized alteration, forgery or falsification of the content or appearance of this document is unlawful and offenders may be prosecuted to the fullest extent of the law. Unless otherwise stated the results shown in this test report refer only to the sample(s) tested and such sample(s) are retained for 30 days only.

Attention: To check the authenticity of testing/inspection report & certificate, please contact us at telephone: (86-755) 8307 1443, or email: CN.Doccheck@sgs.com

South of No. 6 Plant, No. 1, Runsheng Road, Suzhou Industrial Park, Suzhou Area, China (Jiangsu) Pilot Free Trade Zone 215000 t (86-512) 62992980 www.sgs.com
 中国·苏州·中国(江苏)自由贸易试验区苏州片区苏州工业园区润胜路1号的6号厂房南楼 邮编: 215000 t (86-512) 62992980 sgs.china@sgs.com

Statistical Performance check

Test Result

TestMode	Frequency[MHz]	Radar Type	Pass Times	Fail Times	Probability (%)	Limit (%)	Verdict
11ac20SISO	5500	Type1	30	0	100.00	60	PASS
		Type2	30	0	100.00	60	PASS
		Type3	28	2	93.33	60	PASS
		Type4	30	0	100.00	60	PASS
		Type 1-4	---	---	98.33	80	PASS
		Type5	29	1	96.67	80	PASS
11ac40SISO	5510	Type1	29	1	96.67	60	PASS
		Type2	30	0	100.00	60	PASS
		Type3	29	1	96.67	60	PASS
		Type4	30	0	100.00	60	PASS
		Type 1-4	---	---	98.33	80	PASS
		Type5	29	1	96.67	80	PASS
11ac80SISO	5530	Type1	28	2	93.33	60	PASS
		Type2	30	0	100.00	60	PASS
		Type3	30	0	100.00	60	PASS
		Type4	26	4	86.67	60	PASS
		Type 1-4	---	---	95.00	80	PASS
		Type5	30	0	100.00	80	PASS
		Type6	30	0	100.00	70	PASS



Unless otherwise agreed in writing, this document is issued by the Company subject to its General Conditions of Service printed overleaf, available on request or accessible at <http://www.sgs.com/en/Terms-and-Conditions.aspx> and, for electronic format documents, subject to Terms and Conditions for Electronic Documents at <http://www.sgs.com/en/Terms-and-Conditions/Terms-e-Documents.aspx>. Attention is drawn to the limitation of liability, indemnification and jurisdiction issues defined therein. Any holder of this document is advised that information contained hereon reflects the Company's findings at the time of its intervention only and within the limits of Client's instructions, if any. The Company's sole responsibility is to its Client and this document does not exonerate parties to a transaction from exercising all their rights and obligations under the transaction documents. This document cannot be reproduced except in full, without prior written approval of the Company. Any unauthorized alteration, forgery or falsification of the content or appearance of this document is unlawful and offenders may be prosecuted to the fullest extent of the law. Unless otherwise stated the results shown in this test report refer only to the sample(s) tested and such sample(s) are retained for 30 days only.

Attention: To check the authenticity of testing/inspection report & certificate, please contact us at telephone: (86-755) 8307 1443, or email: CN.Doccheck@sgs.com

South of No. 6 Plant, No. 1, Runsheng Road, Suzhou Industrial Park, Suzhou Area, China (Jiangsu) Pilot Free Trade Zone 215000
 中国·苏州·中国(江苏)自由贸易试验区苏州片区苏州工业园区润胜路1号的6号厂房南楼 邮编: 215000

t (86-512) 62992980 www.sgs.com
 t (86-512) 62992980 sgs.china@sgs.com

TestMode	Frequency[MHz]	Radar Type	Trial ID	Pulse width(μs)	PRI(μs)	Pulses per Burst	Detection (1: Yes; 0: No)
11ac20SISO	5500	Type1	0	1.0	938.0	57	1
		Type1	1	1.0	698.0	76	1
		Type1	2	1.0	618.0	86	1
		Type1	3	1.0	538.0	99	1
		Type1	4	1.0	878.0	61	1
		Type1	5	1.0	3066.0	18	1
		Type1	6	1.0	638.0	83	1
		Type1	7	1.0	918.0	58	1
		Type1	8	1.0	838.0	63	1
		Type1	9	1.0	858.0	62	1
		Type1	10	1.0	798.0	67	1
		Type1	11	1.0	718.0	74	1
		Type1	12	1.0	578.0	92	1
		Type1	13	1.0	598.0	89	1
		Type1	14	1.0	558.0	95	1
		Type1	15	1.0	2536.0	21	1
		Type1	16	1.0	966.0	55	1
		Type1	17	1.0	827.0	64	1
		Type1	18	1.0	2501.0	22	1
		Type1	19	1.0	2595.0	21	1
		Type1	20	1.0	1114.0	48	1
		Type1	21	1.0	1302.0	41	1
		Type1	22	1.0	3045.0	18	1
		Type1	23	1.0	1624.0	33	1
		Type1	24	1.0	2878.0	19	1
		Type1	25	1.0	1027.0	52	1
		Type1	26	1.0	2485.0	22	1
		Type1	27	1.0	1600.0	33	1
		Type1	28	1.0	1172.0	46	1
		Type1	29	1.0	1177.0	45	1
		Type2	0	3.2	179.0	26	1
		Type2	1	1.1	207.0	23	1
		Type2	2	2.1	230.0	24	1
		Type2	3	4.8	200.0	29	1
		Type2	4	3.9	214.0	28	1
		Type2	5	2.9	222.0	26	1
		Type2	6	3.2	204.0	26	1
		Type2	7	2.5	192.0	25	1
		Type2	8	3.1	164.0	26	1
		Type2	9	1.2	156.0	23	1
		Type2	10	3.9	210.0	27	1
		Type2	11	4.6	201.0	29	1
		Type2	12	3.2	162.0	26	1
		Type2	13	2.2	197.0	25	1
		Type2	14	4.5	163.0	29	1
		Type2	15	3.0	203.0	26	1
		Type2	16	5.0	168.0	29	1
		Type2	17	2.4	217.0	25	1
Type2	18	2.9	191.0	26	1		
Type2	19	2.3	166.0	25	1		
Type2	20	3.7	150.0	27	1		
Type2	21	2.2	176.0	25	1		
Type2	22	4.9	195.0	29	1		
Type2	23	2.9	202.0	26	1		
Type2	24	2.5	178.0	25	1		



Unless otherwise agreed in writing, this document is issued by the Company subject to its General Conditions of Service printed overleaf, available on request or accessible at <http://www.sgs.com/en/Terms-and-Conditions.aspx> and, for electronic format documents, subject to Terms and Conditions for Electronic Documents at <http://www.sgs.com/en/Terms-and-Conditions/Terms-e-Documents.aspx>. Attention is drawn to the limitation of liability, indemnification and jurisdiction issues defined therein. Any holder of this document is advised that information contained hereon reflects the Company's findings at the time of its intervention only and within the limits of Client's instructions, if any. The Company's sole responsibility is to its Client and this document does not exonerate parties to a transaction from exercising all their rights and obligations under the transaction documents. This document cannot be reproduced except in full, without prior written approval of the Company. Any unauthorized alteration, forgery or falsification of the content or appearance of this document is unlawful and offenders may be prosecuted to the fullest extent of the law. Unless otherwise stated the results shown in this test report refer only to the sample(s) tested and such sample(s) are retained for 30 days only.

Attention: To check the authenticity of testing/inspection report & certificate, please contact us at telephone: (86-755) 83071443, or email: CN.Doccheck@sgs.com

South of No. 6 Plant, No. 1, Runsheng Road, Suzhou Industrial Park, Suzhou Area, China (Jiangsu) Pilot Free Trade Zone 215000 t (86-512) 62992980 www.sgs.com.cn
 中国·苏州·中国(江苏)自由贸易试验区苏州片区苏州工业园区润胜路1号的6号厂房南楼 邮编: 215000 t (86-512) 62992980 sgs.china@sgs.com

Type2	25	1.1	206.0	23	1
Type2	26	3.8	155.0	27	1
Type2	27	4.7	157.0	29	1
Type2	28	2.4	224.0	25	1
Type2	29	4.2	159.0	28	1
Type3	0	8.2	355.0	17	1
Type3	1	6.1	487.0	16	1
Type3	2	7.1	344.0	16	1
Type3	3	9.8	288.0	18	1
Type3	4	8.9	230.0	18	1
Type3	5	7.9	432.0	17	1
Type3	6	8.2	207.0	17	1
Type3	7	7.5	443.0	17	0
Type3	8	8.1	439.0	17	1
Type3	9	6.2	223.0	16	0
Type3	10	8.9	208.0	18	1
Type3	11	9.6	463.0	18	1
Type3	12	8.2	441.0	17	1
Type3	13	7.2	323.0	16	1
Type3	14	9.5	297.0	18	1
Type3	15	8.0	412.0	17	1
Type3	16	10.0	324.0	18	1
Type3	17	7.4	271.0	17	1
Type3	18	7.9	349.0	17	1
Type3	19	7.3	409.0	16	1
Type3	20	8.7	373.0	18	1
Type3	21	7.2	254.0	16	1
Type3	22	9.9	274.0	18	1
Type3	23	7.9	278.0	17	1
Type3	24	7.5	317.0	17	1
Type3	25	6.1	260.0	16	1
Type3	26	8.8	211.0	18	1
Type3	27	9.7	272.0	18	1
Type3	28	7.4	264.0	17	1
Type3	29	9.2	284.0	18	1
Type4	0	16.0	355.0	14	1
Type4	1	11.3	487.0	12	1
Type4	2	13.5	344.0	13	1
Type4	3	19.4	288.0	16	1
Type4	4	17.5	230.0	15	1
Type4	5	15.3	432.0	14	1
Type4	6	15.9	207.0	14	1
Type4	7	14.3	443.0	13	1
Type4	8	15.8	439.0	14	1
Type4	9	11.5	223.0	12	1
Type4	10	17.4	208.0	15	1
Type4	11	19.0	463.0	16	1
Type4	12	16.0	441.0	14	1
Type4	13	13.8	323.0	13	1
Type4	14	18.9	297.0	16	1
Type4	15	15.5	412.0	14	1
Type4	16	19.9	324.0	16	1
Type4	17	14.1	271.0	13	1
Type4	18	15.2	349.0	14	1
Type4	19	13.8	409.0	13	1
Type4	20	17.1	373.0	15	1
Type4	21	13.8	254.0	13	1



Unless otherwise agreed in writing, this document is issued by the Company subject to its General Conditions of Service printed overleaf, available on request or accessible at <http://www.sgs.com/en/Terms-and-Conditions.aspx> and, for electronic format documents, subject to Terms and Conditions for Electronic Documents at <http://www.sgs.com/en/Terms-and-Conditions/Terms-e-Documents.aspx>. Attention is drawn to the limitation of liability, indemnification and jurisdiction issues defined therein. Any holder of this document is advised that information contained hereon reflects the Company's findings at the time of its intervention only and within the limits of Client's instructions, if any. The Company's sole responsibility is to its Client and this document does not exonerate parties to a transaction from exercising all their rights and obligations under the transaction documents. This document cannot be reproduced except in full, without prior written approval of the Company. Any unauthorized alteration, forgery or falsification of the content or appearance of this document is unlawful and offenders may be prosecuted to the fullest extent of the law. Unless otherwise stated the results shown in this test report refer only to the sample(s) tested and such sample(s) are retained for 30 days only.

Attention: To check the authenticity of testing/inspection report & certificate, please contact us at telephone: (86-755) 8307 1443, or email: CN.Doccheck@sgs.com

South of No. 6 Plant, No. 1, Runsheng Road, Suzhou Industrial Park, Suzhou Area, China (Jiangsu) Pilot Free Trade Zone 215000
 中国·苏州·中国(江苏)自由贸易试验区苏州片区工业园区润胜路1号的6号厂房南楼 邮编: 215000

t (86-512) 62992980 www.sgs.com
 t (86-512) 62992980 sgs.china@sgs.com

		Type4	22	19.8	274.0	16	1
		Type4	23	15.3	278.0	14	1
		Type4	24	14.5	317.0	13	1
		Type4	25	11.3	260.0	12	1
		Type4	26	17.3	211.0	15	1
		Type4	27	19.2	272.0	16	1
		Type4	28	14.2	264.0	13	1
		Type4	29	18.2	284.0	15	1
11ac40SISO	5510	Type1	0	1.0	938.0	57	1
		Type1	1	1.0	698.0	76	0
		Type1	2	1.0	618.0	86	1
		Type1	3	1.0	538.0	99	1
		Type1	4	1.0	878.0	61	1
		Type1	5	1.0	3066.0	18	1
		Type1	6	1.0	638.0	83	1
		Type1	7	1.0	918.0	58	1
		Type1	8	1.0	838.0	63	1
		Type1	9	1.0	858.0	62	1
		Type1	10	1.0	798.0	67	1
		Type1	11	1.0	718.0	74	1
		Type1	12	1.0	578.0	92	1
		Type1	13	1.0	598.0	89	1
		Type1	14	1.0	558.0	95	1
		Type1	15	1.0	2536.0	21	1
		Type1	16	1.0	966.0	55	1
		Type1	17	1.0	827.0	64	1
		Type1	18	1.0	2501.0	22	1
		Type1	19	1.0	2595.0	21	1
		Type1	20	1.0	1114.0	48	1
		Type1	21	1.0	1302.0	41	1
		Type1	22	1.0	3045.0	18	1
		Type1	23	1.0	1624.0	33	1
		Type1	24	1.0	2878.0	19	1
		Type1	25	1.0	1027.0	52	1
		Type1	26	1.0	2485.0	22	1
		Type1	27	1.0	1600.0	33	1
		Type1	28	1.0	1172.0	46	1
		Type1	29	1.0	1177.0	45	1
		Type2	0	3.2	179.0	26	1
		Type2	1	1.1	207.0	23	1
		Type2	2	2.1	230.0	24	1
		Type2	3	4.8	200.0	29	1
		Type2	4	3.9	214.0	28	1
		Type2	5	2.9	222.0	26	1
		Type2	6	3.2	204.0	26	1
		Type2	7	2.5	192.0	25	1
Type2	8	3.1	164.0	26	1		
Type2	9	1.2	156.0	23	1		
Type2	10	3.9	210.0	27	1		
Type2	11	4.6	201.0	29	1		
Type2	12	3.2	162.0	26	1		
Type2	13	2.2	197.0	25	1		
Type2	14	4.5	163.0	29	1		
Type2	15	3.0	203.0	26	1		
Type2	16	5.0	168.0	29	1		
Type2	17	2.4	217.0	25	1		
Type2	18	2.9	191.0	26	1		



Unless otherwise agreed in writing, this document is issued by the Company subject to its General Conditions of Service printed overleaf, available on request or accessible at <http://www.sgs.com/en/Terms-and-Conditions.aspx> and, for electronic format documents, subject to Terms and Conditions for Electronic Documents at <http://www.sgs.com/en/Terms-and-Conditions/Terms-e-Documents.aspx>. Attention is drawn to the limitation of liability, indemnification and jurisdiction issues defined therein. Any holder of this document is advised that information contained hereon reflects the Company's findings at the time of its intervention only and within the limits of Client's instructions, if any. The Company's sole responsibility is to its Client and this document does not exonerate parties to a transaction from exercising all their rights and obligations under the transaction documents. This document cannot be reproduced except in full, without prior written approval of the Company. Any unauthorized alteration, forgery or falsification of the content or appearance of this document is unlawful and offenders may be prosecuted to the fullest extent of the law. Unless otherwise stated the results shown in this test report refer only to the sample(s) tested and such sample(s) are retained for 30 days only.

Attention: To check the authenticity of testing/inspection report & certificate, please contact us at telephone: (86-755) 8307 1443, or email: CN.Doccheck@sgs.com

South of No. 6 Plant, No. 1, Runsheng Road, Suzhou Industrial Park, Suzhou Area, China (Jiangsu) Pilot Free Trade Zone 215000
 中国·苏州·中国(江苏)自由贸易试验区苏州片区苏州工业园区润胜路1号的6号厂房南楼 邮编: 215000

t (86-512) 62992980 www.sgsgroup.com.cn
 t (86-512) 62992980 sgs.china@sgs.com

Type2	19	2.3	166.0	25	1
Type2	20	3.7	150.0	27	1
Type2	21	2.2	176.0	25	1
Type2	22	4.9	195.0	29	1
Type2	23	2.9	202.0	26	1
Type2	24	2.5	178.0	25	1
Type2	25	1.1	206.0	23	1
Type2	26	3.8	155.0	27	1
Type2	27	4.7	157.0	29	1
Type2	28	2.4	224.0	25	1
Type2	29	4.2	159.0	28	1
Type3	0	8.2	355.0	17	1
Type3	1	6.1	487.0	16	1
Type3	2	7.1	344.0	16	1
Type3	3	9.8	288.0	18	1
Type3	4	8.9	230.0	18	1
Type3	5	7.9	432.0	17	1
Type3	6	8.2	207.0	17	1
Type3	7	7.5	443.0	17	1
Type3	8	8.1	439.0	17	1
Type3	9	6.2	223.0	16	1
Type3	10	8.9	208.0	18	1
Type3	11	9.6	463.0	18	1
Type3	12	8.2	441.0	17	0
Type3	13	7.2	323.0	16	1
Type3	14	9.5	297.0	18	1
Type3	15	8.0	412.0	17	1
Type3	16	10.0	324.0	18	1
Type3	17	7.4	271.0	17	1
Type3	18	7.9	349.0	17	1
Type3	19	7.3	409.0	16	1
Type3	20	8.7	373.0	18	1
Type3	21	7.2	254.0	16	1
Type3	22	9.9	274.0	18	1
Type3	23	7.9	278.0	17	1
Type3	24	7.5	317.0	17	1
Type3	25	6.1	260.0	16	1
Type3	26	8.8	211.0	18	1
Type3	27	9.7	272.0	18	1
Type3	28	7.4	264.0	17	1
Type3	29	9.2	284.0	18	1
Type4	0	16.0	355.0	14	1
Type4	1	11.3	487.0	12	1
Type4	2	13.5	344.0	13	1
Type4	3	19.4	288.0	16	1
Type4	4	17.5	230.0	15	1
Type4	5	15.3	432.0	14	1
Type4	6	15.9	207.0	14	1
Type4	7	14.3	443.0	13	1
Type4	8	15.8	439.0	14	1
Type4	9	11.5	223.0	12	1
Type4	10	17.4	208.0	15	1
Type4	11	19.0	463.0	16	1
Type4	12	16.0	441.0	14	1
Type4	13	13.8	323.0	13	1
Type4	14	18.9	297.0	16	1
Type4	15	15.5	412.0	14	1



Unless otherwise agreed in writing, this document is issued by the Company subject to its General Conditions of Service printed overleaf, available on request or accessible at <http://www.sgs.com/en/Terms-and-Conditions.aspx> and, for electronic format documents, subject to Terms and Conditions for Electronic Documents at <http://www.sgs.com/en/Terms-and-Conditions/Terms-e-Documents.aspx>. Attention is drawn to the limitation of liability, indemnification and jurisdiction issues defined therein. Any holder of this document is advised that information contained hereon reflects the Company's findings at the time of its intervention only and within the limits of Client's instructions, if any. The Company's sole responsibility is to its Client and this document does not exonerate parties to a transaction from exercising all their rights and obligations under the transaction documents. This document cannot be reproduced except in full, without prior written approval of the Company. Any unauthorized alteration, forgery or falsification of the content or appearance of this document is unlawful and offenders may be prosecuted to the fullest extent of the law. Unless otherwise stated the results shown in this test report refer only to the sample(s) tested and such sample(s) are retained for 30 days only.

Attention: To check the authenticity of testing/inspection report & certificate, please contact us at telephone: (86-755) 8307 1443, or email: CN.Doccheck@sgs.com

South of No. 6 Plant, No. 1, Runsheng Road, Suzhou Industrial Park, Suzhou Area, China (Jiangsu) Pilot Free Trade Zone 215000
 中国·苏州·中国(江苏)自由贸易试验区苏州片区苏州工业园区润胜路1号的6号厂房南面 邮编: 215000

t (86-512) 62992980 www.sgs.com.cn
 t (86-512) 62992980 sgs.china@sgs.com

		Type4	16	19.9	324.0	16	1
		Type4	17	14.1	271.0	13	1
		Type4	18	15.2	349.0	14	1
		Type4	19	13.8	409.0	13	1
		Type4	20	17.1	373.0	15	1
		Type4	21	13.8	254.0	13	1
		Type4	22	19.8	274.0	16	1
		Type4	23	15.3	278.0	14	1
		Type4	24	14.5	317.0	13	1
		Type4	25	11.3	260.0	12	1
		Type4	26	17.3	211.0	15	1
		Type4	27	19.2	272.0	16	1
		Type4	28	14.2	264.0	13	1
		Type4	29	18.2	284.0	15	1
11ac80SISO	5530	Type1	0	1.0	938.0	57	1
		Type1	1	1.0	698.0	76	1
		Type1	2	1.0	618.0	86	1
		Type1	3	1.0	538.0	99	1
		Type1	4	1.0	878.0	61	1
		Type1	5	1.0	3066.0	18	1
		Type1	6	1.0	638.0	83	1
		Type1	7	1.0	918.0	58	1
		Type1	8	1.0	838.0	63	1
		Type1	9	1.0	858.0	62	0
		Type1	10	1.0	798.0	67	1
		Type1	11	1.0	718.0	74	1
		Type1	12	1.0	578.0	92	0
		Type1	13	1.0	598.0	89	1
		Type1	14	1.0	558.0	95	1
		Type1	15	1.0	2536.0	21	1
		Type1	16	1.0	966.0	55	1
		Type1	17	1.0	827.0	64	1
		Type1	18	1.0	2501.0	22	1
		Type1	19	1.0	2595.0	21	1
		Type1	20	1.0	1114.0	48	1
		Type1	21	1.0	1302.0	41	1
		Type1	22	1.0	3045.0	18	1
		Type1	23	1.0	1624.0	33	1
		Type1	24	1.0	2878.0	19	1
		Type1	25	1.0	1027.0	52	1
		Type1	26	1.0	2485.0	22	1
		Type1	27	1.0	1600.0	33	1
		Type1	28	1.0	1172.0	46	1
		Type1	29	1.0	1177.0	45	1
		Type2	0	3.2	179.0	26	1
		Type2	1	1.1	207.0	23	1
		Type2	2	2.1	230.0	24	1
Type2	3	4.8	200.0	29	1		
Type2	4	3.9	214.0	28	1		
Type2	5	2.9	222.0	26	1		
Type2	6	3.2	204.0	26	1		



Unless otherwise agreed in writing, this document is issued by the Company subject to its General Conditions of Service printed overleaf, available on request or accessible at <http://www.sgs.com/en/Terms-and-Conditions.aspx> and, for electronic format documents, subject to Terms and Conditions for Electronic Documents at <http://www.sgs.com/en/Terms-and-Conditions.aspx>. Attention is drawn to the limitation of liability, indemnification and jurisdiction issues defined therein. Any holder of this document is advised that information contained hereon reflects the Company's findings at the time of its intervention only and within the limits of Client's instructions, if any. The Company's sole responsibility is to its Client and this document does not exonerate parties to a transaction from exercising all their rights and obligations under the transaction documents. This document cannot be reproduced except in full, without prior written approval of the Company. Any unauthorized alteration, forgery or falsification of the content or appearance of this document is unlawful and offenders may be prosecuted to the fullest extent of the law. Unless otherwise stated the results shown in this test report refer only to the sample(s) tested and such sample(s) are retained for 30 days only.

Attention: To check the authenticity of testing/inspection report & certificate, please contact us at telephone: (86-755) 8307 1443, or email: CN.Doccheck@sgs.com

South of No. 6 Plant, No. 1, Runsheng Road, Suzhou Industrial Park, Suzhou Area, China (Jiangsu) Pilot Free Trade Zone 215000
 中国·苏州·中国(江苏)自由贸易试验区苏州片区苏州工业园区润胜路1号的6号厂房南楼 邮编: 215000

t (86-512) 62992980 www.sgs.com.cn
 t (86-512) 62992980 sgs.china@sgs.com

Type2	7	2.5	192.0	25	1
Type2	8	3.1	164.0	26	1
Type2	9	1.2	156.0	23	1
Type2	10	3.9	210.0	27	1
Type2	11	4.6	201.0	29	1
Type2	12	3.2	162.0	26	1
Type2	13	2.2	197.0	25	1
Type2	14	4.5	163.0	29	1
Type2	15	3.0	203.0	26	1
Type2	16	5.0	168.0	29	1
Type2	17	2.4	217.0	25	1
Type2	18	2.9	191.0	26	1
Type2	19	2.3	166.0	25	1
Type2	20	3.7	150.0	27	1
Type2	21	2.2	176.0	25	1
Type2	22	4.9	195.0	29	1
Type2	23	2.9	202.0	26	1
Type2	24	2.5	178.0	25	1
Type2	25	1.1	206.0	23	1
Type2	26	3.8	155.0	27	1
Type2	27	4.7	157.0	29	1
Type2	28	2.4	224.0	25	1
Type2	29	4.2	159.0	28	1
Type3	0	8.2	355.0	17	1
Type3	1	6.1	487.0	16	1
Type3	2	7.1	344.0	16	1
Type3	3	9.8	288.0	18	1
Type3	4	8.9	230.0	18	1
Type3	5	7.9	432.0	17	1
Type3	6	8.2	207.0	17	1
Type3	7	7.5	443.0	17	1
Type3	8	8.1	439.0	17	1
Type3	9	6.2	223.0	16	1
Type3	10	8.9	208.0	18	1
Type3	11	9.6	463.0	18	1
Type3	12	8.2	441.0	17	1
Type3	13	7.2	323.0	16	1
Type3	14	9.5	297.0	18	1
Type3	15	8.0	412.0	17	1
Type3	16	10.0	324.0	18	1
Type3	17	7.4	271.0	17	1
Type3	18	7.9	349.0	17	1
Type3	19	7.3	409.0	16	1
Type3	20	8.7	373.0	18	1
Type3	21	7.2	254.0	16	1
Type3	22	9.9	274.0	18	1
Type3	23	7.9	278.0	17	1
Type3	24	7.5	317.0	17	1
Type3	25	6.1	260.0	16	1



Unless otherwise agreed in writing, this document is issued by the Company subject to its General Conditions of Service printed overleaf, available on request or accessible at <http://www.sgs.com/en/Terms-and-Conditions.aspx> and, for electronic format documents, subject to Terms and Conditions for Electronic Documents at <http://www.sgs.com/en/Terms-and-Conditions/Terms-e-Documents.aspx>. Attention is drawn to the limitation of liability, indemnification and jurisdiction issues defined therein. Any holder of this document is advised that information contained hereon reflects the Company's findings at the time of its intervention only and within the limits of Client's instructions, if any. The Company's sole responsibility is to its Client and this document does not exonerate parties to a transaction from exercising all their rights and obligations under the transaction documents. This document cannot be reproduced except in full, without prior written approval of the Company. Any unauthorized alteration, forgery or falsification of the content or appearance of this document is unlawful and offenders may be prosecuted to the fullest extent of the law. Unless otherwise stated the results shown in this test report refer only to the sample(s) tested and such sample(s) are retained for 30 days only.

Attention: To check the authenticity of testing/inspection report & certificate, please contact us at telephone: (86-755) 8307 1443, or email: CN.Doccheck@sgs.com

South of No. 6 Plant, No. 1, Runsheng Road, Suzhou Industrial Park, Suzhou Area, China (Jiangsu) Pilot Free Trade Zone 215000
 中国·苏州·中国(江苏)自由贸易试验区苏州片区苏州工业园区润胜路1号的6号厂房南楼 邮编: 215000

t (86-512) 62992980 www.sgsgroup.com.cn
 t (86-512) 62992980 sgs.china@sgs.com

Type3	26	8.8	211.0	18	1
Type3	27	9.7	272.0	18	1
Type3	28	7.4	264.0	17	1
Type3	29	9.2	284.0	18	1
Type4	0	16.0	355.0	14	1
Type4	1	11.3	487.0	12	1
Type4	2	13.5	344.0	13	1
Type4	3	19.4	288.0	16	0
Type4	4	17.5	230.0	15	1
Type4	5	15.3	432.0	14	1
Type4	6	15.9	207.0	14	1
Type4	7	14.3	443.0	13	1
Type4	8	15.8	439.0	14	1
Type4	9	11.5	223.0	12	0
Type4	10	17.4	208.0	15	1
Type4	11	19.0	463.0	16	1
Type4	12	16.0	441.0	14	1
Type4	13	13.8	323.0	13	1
Type4	14	18.9	297.0	16	1
Type4	15	15.5	412.0	14	1
Type4	16	19.9	324.0	16	1
Type4	17	14.1	271.0	13	1
Type4	18	15.2	349.0	14	1
Type4	19	13.8	409.0	13	1
Type4	20	17.1	373.0	15	0
Type4	21	13.8	254.0	13	0
Type4	22	19.8	274.0	16	1
Type4	23	15.3	278.0	14	1
Type4	24	14.5	317.0	13	1
Type4	25	11.3	260.0	12	1
Type4	26	17.3	211.0	15	1
Type4	27	19.2	272.0	16	1
Type4	28	14.2	264.0	13	1
Type4	29	18.2	284.0	15	1



Unless otherwise agreed in writing, this document is issued by the Company subject to its General Conditions of Service printed overleaf, available on request or accessible at <http://www.sgs.com/en/Terms-and-Conditions.aspx> and, for electronic format documents, subject to Terms and Conditions for Electronic Documents at <http://www.sgs.com/en/Terms-and-Conditions/Terms-e-Documents.aspx>. Attention is drawn to the limitation of liability, indemnification and jurisdiction issues defined therein. Any holder of this document is advised that information contained hereon reflects the Company's findings at the time of its intervention only and within the limits of Client's instructions, if any. The Company's sole responsibility is to its Client and this document does not exonerate parties to a transaction from exercising all their rights and obligations under the transaction documents. This document cannot be reproduced except in full, without prior written approval of the Company. Any unauthorized alteration, forgery or falsification of the content or appearance of this document is unlawful and offenders may be prosecuted to the fullest extent of the law. Unless otherwise stated the results shown in this test report refer only to the sample(s) tested and such sample(s) are retained for 30 days only.

Attention: To check the authenticity of testing/inspection report & certificate, please contact us at telephone: (86-755) 8307 1443, or email: CN.Doccheck@sgs.com

South of No. 6 Plant, No. 1, Runsheng Road, Suzhou Industrial Park, Suzhou Area, China (Jiangsu) Pilot Free Trade Zone 215000 t (86-512) 62992980 www.sgsgroup.com.cn
 中国·苏州·中国(江苏)自由贸易试验区苏州片区苏州工业园区润胜路1号的6号厂房南部 邮编: 215000 t (86-512) 62992980 sgs.china@sgs.com

@FCC_RLAN_DFS_SPC_Radar_T5_SP2_Tr0@

TestMode	Channel	Radar Type	Trial ID	Burst ID	Burst Offset (μs)	Chirp Width (MHz)	Number Of Pulses	Pulse Width (μs)	PRI1 (μs)	PRI2 (μs)	PRI3 (μs)
11ac20SISO	5500	Type5	0	0	636185.0	13	2	77.8	1665.0	1477.0	---
11ac20SISO	5500	Type5	0	1	32674.0	13	1	51.9	1074.0	---	---
11ac20SISO	5500	Type5	0	2	226294.0	13	1	63.8	1584.0	---	---
11ac20SISO	5500	Type5	0	3	417976.0	13	3	96.6	1682.0	1786.0	1843.0
11ac20SISO	5500	Type5	0	4	611152.0	13	3	85.9	1795.0	1215.0	1729.0
11ac20SISO	5500	Type5	0	5	8789.0	13	2	73.7	1198.0	1549.0	---
11ac20SISO	5500	Type5	0	6	201917.0	13	2	77.2	1837.0	1819.0	---
11ac20SISO	5500	Type5	0	7	395530.0	13	2	68.4	1587.0	1114.0	---
11ac20SISO	5500	Type5	0	8	588564.0	13	2	76.7	2000.0	1155.0	---
11ac20SISO	5500	Type5	0	9	783794.0	13	1	53.2	1147.0	---	---
11ac20SISO	5500	Type5	0	10	177933.0	13	3	85.7	1433.0	1695.0	1394.0
11ac20SISO	5500	Type5	0	11	370624.0	13	3	94.3	1670.0	1426.0	1935.0
11ac20SISO	5500	Type5	0	12	564893.0	13	2	77.6	1294.0	1671.0	---
11ac20SISO	5500	Type5	0	13	759583.0	13	1	65.7	1512.0	---	---
11ac20SISO	5500	Type5	0	14	154262.0	13	3	93.5	1444.0	1130.0	1468.0
11ac40SISO	5510	Type5	0	0	636185.0	13	2	77.8	1665.0	1477.0	---
11ac40SISO	5510	Type5	0	1	32674.0	13	1	51.9	1074.0	---	---
11ac40SISO	5510	Type5	0	2	226294.0	13	1	63.8	1584.0	---	---
11ac40SISO	5510	Type5	0	3	417976.0	13	3	96.6	1682.0	1786.0	1843.0
11ac40SISO	5510	Type5	0	4	611152.0	13	3	85.9	1795.0	1215.0	1729.0
11ac40SISO	5510	Type5	0	5	8789.0	13	2	73.7	1198.0	1549.0	---
11ac40SISO	5510	Type5	0	6	201917.0	13	2	77.2	1837.0	1819.0	---
11ac40SISO	5510	Type5	0	7	395530.0	13	2	68.4	1587.0	1114.0	---
11ac40SISO	5510	Type5	0	8	588564.0	13	2	76.7	2000.0	1155.0	---
11ac40SISO	5510	Type5	0	9	783794.0	13	1	53.2	1147.0	---	---
11ac40SISO	5510	Type5	0	10	177933.0	13	3	85.7	1433.0	1695.0	1394.0
11ac40SISO	5510	Type5	0	11	370624.0	13	3	94.3	1670.0	1426.0	1935.0
11ac40SISO	5510	Type5	0	12	564893.0	13	2	77.6	1294.0	1671.0	---
11ac40SISO	5510	Type5	0	13	759583.0	13	1	65.7	1512.0	---	---
11ac40SISO	5510	Type5	0	14	154262.0	13	3	93.5	1444.0	1130.0	1468.0
11ac80SISO	5530	Type5	0	0	636185.0	13	2	77.8	1665.0	1477.0	---
11ac80SISO	5530	Type5	0	1	32674.0	13	1	51.9	1074.0	---	---
11ac80SISO	5530	Type5	0	2	226294.0	13	1	63.8	1584.0	---	---
11ac80SISO	5530	Type5	0	3	417976.0	13	3	96.6	1682.0	1786.0	1843.0
11ac80SISO	5530	Type5	0	4	611152.0	13	3	85.9	1795.0	1215.0	1729.0
11ac80SISO	5530	Type5	0	5	8789.0	13	2	73.7	1198.0	1549.0	---
11ac80SISO	5530	Type5	0	6	201917.0	13	2	77.2	1837.0	1819.0	---
11ac80SISO	5530	Type5	0	7	395530.0	13	2	68.4	1587.0	1114.0	---
11ac80SISO	5530	Type5	0	8	588564.0	13	2	76.7	2000.0	1155.0	---
11ac80SISO	5530	Type5	0	9	783794.0	13	1	53.2	1147.0	---	---
11ac80SISO	5530	Type5	0	10	177933.0	13	3	85.7	1433.0	1695.0	1394.0
11ac80SISO	5530	Type5	0	11	370624.0	13	3	94.3	1670.0	1426.0	1935.0
11ac80SISO	5530	Type5	0	12	564893.0	13	2	77.6	1294.0	1671.0	---
11ac80SISO	5530	Type5	0	13	759583.0	13	1	65.7	1512.0	---	---
11ac80SISO	5530	Type5	0	14	154262.0	13	3	93.5	1444.0	1130.0	1468.0



Unless otherwise agreed in writing, this document is issued by the Company subject to its General Conditions of Service printed overleaf, available on request or accessible at <http://www.sgs.com/en/Terms-and-Conditions.aspx> and, for electronic format documents, subject to Terms and Conditions for Electronic Documents at <http://www.sgs.com/en/Terms-and-Conditions/Terms-e-Documents.aspx>. Attention is drawn to the limitation of liability, indemnification and jurisdiction issues defined therein. Any holder of this document is advised that information contained hereon reflects the Company's findings at the time of its intervention only and within the limits of Client's instructions, if any. The Company's sole responsibility is to its Client and this document does not exonerate parties to a transaction from exercising all their rights and obligations under the transaction documents. This document cannot be reproduced except in full, without prior written approval of the Company. Any unauthorized alteration, forgery or falsification of the content or appearance of this document is unlawful and offenders may be prosecuted to the fullest extent of the law. Unless otherwise stated the results shown in this test report refer only to the sample(s) tested and such sample(s) are retained for 30 days only.

Attention: To check the authenticity of testing/inspection report & certificate, please contact us at telephone: (86-755) 8307 1443, or email: CN.Doccheck@sgs.com

South of No. 6 Plant, No. 1, Runsheng Road, Suzhou Industrial Park, Suzhou Area, China (Jiangsu) Pilot Free Trade Zone 215000
 中国·苏州·中国(江苏)自由贸易试验区苏州片区苏州工业园区润胜路1号的6号厂房南楼 邮编: 215000

t (86-512) 62992980 www.sgs.com.cn
 t (86-512) 62992980 sgs.china@sgs.com

@FCC_RLAN_DFS_SPC_Radar_T5_SP2_Tr1@

TestMode	Channel	Radar Type	Trial ID	Burst ID	Burst Offset (μs)	Chirp Width (MHz)	Number Of Pulses	Pulse Width (μs)	PR1 (μs)	PR2 (μs)	PR3 (μs)
11ac20SISO	5500	Type5	1	0	653020.0	5	2	75.0	1880.0	1527.0	---
11ac20SISO	5500	Type5	1	1	1015643.0	5	3	99.4	1401.0	1262.0	1257.0
11ac20SISO	5500	Type5	1	2	1379398.0	5	2	67.4	1531.0	1403.0	---
11ac20SISO	5500	Type5	1	3	245489.0	5	2	73.6	1449.0	1041.0	---
11ac20SISO	5500	Type5	1	4	609113.0	5	1	65.9	1432.0	---	---
11ac20SISO	5500	Type5	1	5	970852.0	5	3	83.8	1356.0	1292.0	1419.0
11ac20SISO	5500	Type5	1	6	1335913.0	5	1	65.5	1543.0	---	---
11ac20SISO	5500	Type5	1	7	200406.0	5	3	98.6	1548.0	1796.0	1728.0
11ac40SISO	5510	Type5	1	0	653020.0	5	2	75.0	1880.0	1527.0	---
11ac40SISO	5510	Type5	1	1	1015643.0	5	3	99.4	1401.0	1262.0	1257.0
11ac40SISO	5510	Type5	1	2	1379398.0	5	2	67.4	1531.0	1403.0	---
11ac40SISO	5510	Type5	1	3	245489.0	5	2	73.6	1449.0	1041.0	---
11ac40SISO	5510	Type5	1	4	609113.0	5	1	65.9	1432.0	---	---
11ac40SISO	5510	Type5	1	5	970852.0	5	3	83.8	1356.0	1292.0	1419.0
11ac40SISO	5510	Type5	1	6	1335913.0	5	1	65.5	1543.0	---	---
11ac40SISO	5510	Type5	1	7	200406.0	5	3	98.6	1548.0	1796.0	1728.0
11ac80SISO	5530	Type5	1	0	653020.0	5	2	75.0	1880.0	1527.0	---
11ac80SISO	5530	Type5	1	1	1015643.0	5	3	99.4	1401.0	1262.0	1257.0
11ac80SISO	5530	Type5	1	2	1379398.0	5	2	67.4	1531.0	1403.0	---
11ac80SISO	5530	Type5	1	3	245489.0	5	2	73.6	1449.0	1041.0	---
11ac80SISO	5530	Type5	1	4	609113.0	5	1	65.9	1432.0	---	---
11ac80SISO	5530	Type5	1	5	970852.0	5	3	83.8	1356.0	1292.0	1419.0
11ac80SISO	5530	Type5	1	6	1335913.0	5	1	65.5	1543.0	---	---
11ac80SISO	5530	Type5	1	7	200406.0	5	3	98.6	1548.0	1796.0	1728.0



Unless otherwise agreed in writing, this document is issued by the Company subject to its General Conditions of Service printed overleaf, available on request or accessible at <http://www.sgs.com/en/Terms-and-Conditions.aspx> and, for electronic format documents, subject to Terms and Conditions for Electronic Documents at <http://www.sgs.com/en/Terms-and-Conditions/Terms-e-Documents.aspx>. Attention is drawn to the limitation of liability, indemnification and jurisdiction issues defined therein. Any holder of this document is advised that information contained hereon reflects the Company's findings at the time of its intervention only and within the limits of Client's instructions, if any. The Company's sole responsibility is to its Client and this document does not exonerate parties to a transaction from exercising all their rights and obligations under the transaction documents. This document cannot be reproduced except in full, without prior written approval of the Company. Any unauthorized alteration, forgery or falsification of the content or appearance of this document is unlawful and offenders may be prosecuted to the fullest extent of the law. Unless otherwise stated the results shown in this test report refer only to the sample(s) tested and such sample(s) are retained for 30 days only.

Attention: To check the authenticity of testing/inspection report & certificate, please contact us at telephone: (86-755) 8307 1443, or email: CN.Doccheck@sgs.com

South of No. 6 Plant, No. 1, Runsheng Road, Suzhou Industrial Park, Suzhou Area, China (Jiangsu) Pilot Free Trade Zone 215000 t (86-512) 62992980 www.sgs.com.cn
 中国·苏州·中国(江苏)自由贸易试验区苏州片区苏州工业园区润胜路1号的6号厂房南楼 邮编: 215000 t (86-512) 62992980 sgs.china@sgs.com

@FCC_RLAN_DFS_SPC_Radar_T5_SP2_Tr2@

TestMode	Channel	Radar Type	Trial ID	Burst ID	Burst Offset (μs)	Chirp Width (MHz)	Number Of Pulses	Pulse Width (μs)	PRI1 (μs)	PRI2 (μs)	PRI3 (μs)
11ac20SISO	5500	Type5	2	0	409565.0	9	2	73.8	1806.0	1538.0	---
11ac20SISO	5500	Type5	2	1	673692.0	9	2	69.5	1117.0	1649.0	---
11ac20SISO	5500	Type5	2	2	938562.0	9	1	51.9	1651.0	---	---
11ac20SISO	5500	Type5	2	3	113209.0	9	3	84.6	1976.0	1032.0	1271.0
11ac20SISO	5500	Type5	2	4	376726.0	9	3	95.4	1060.0	1903.0	1388.0
11ac20SISO	5500	Type5	2	5	641212.0	9	2	68.0	1368.0	1351.0	---
11ac20SISO	5500	Type5	2	6	903714.0	9	3	89.6	1338.0	1514.0	1573.0
11ac20SISO	5500	Type5	2	7	80863.0	9	2	81.9	1022.0	1689.0	---
11ac20SISO	5500	Type5	2	8	344067.0	9	3	88.3	1810.0	1330.0	1838.0
11ac20SISO	5500	Type5	2	9	609331.0	9	1	53.7	1597.0	---	---
11ac20SISO	5500	Type5	2	10	871542.0	9	3	91.3	1961.0	1106.0	1001.0
11ac40SISO	5510	Type5	2	0	409565.0	9	2	73.8	1806.0	1538.0	---
11ac40SISO	5510	Type5	2	1	673692.0	9	2	69.5	1117.0	1649.0	---
11ac40SISO	5510	Type5	2	2	938562.0	9	1	51.9	1651.0	---	---
11ac40SISO	5510	Type5	2	3	113209.0	9	3	84.6	1976.0	1032.0	1271.0
11ac40SISO	5510	Type5	2	4	376726.0	9	3	95.4	1060.0	1903.0	1388.0
11ac40SISO	5510	Type5	2	5	641212.0	9	2	68.0	1368.0	1351.0	---
11ac40SISO	5510	Type5	2	6	903714.0	9	3	89.6	1338.0	1514.0	1573.0
11ac40SISO	5510	Type5	2	7	80863.0	9	2	81.9	1022.0	1689.0	---
11ac40SISO	5510	Type5	2	8	344067.0	9	3	88.3	1810.0	1330.0	1838.0
11ac40SISO	5510	Type5	2	9	609331.0	9	1	53.7	1597.0	---	---
11ac40SISO	5510	Type5	2	10	871542.0	9	3	91.3	1961.0	1106.0	1001.0
11ac80SISO	5530	Type5	2	0	409565.0	9	2	73.8	1806.0	1538.0	---
11ac80SISO	5530	Type5	2	1	673692.0	9	2	69.5	1117.0	1649.0	---
11ac80SISO	5530	Type5	2	2	938562.0	9	1	51.9	1651.0	---	---
11ac80SISO	5530	Type5	2	3	113209.0	9	3	84.6	1976.0	1032.0	1271.0
11ac80SISO	5530	Type5	2	4	376726.0	9	3	95.4	1060.0	1903.0	1388.0
11ac80SISO	5530	Type5	2	5	641212.0	9	2	68.0	1368.0	1351.0	---
11ac80SISO	5530	Type5	2	6	903714.0	9	3	89.6	1338.0	1514.0	1573.0
11ac80SISO	5530	Type5	2	7	80863.0	9	2	81.9	1022.0	1689.0	---
11ac80SISO	5530	Type5	2	8	344067.0	9	3	88.3	1810.0	1330.0	1838.0
11ac80SISO	5530	Type5	2	9	609331.0	9	1	53.7	1597.0	---	---
11ac80SISO	5530	Type5	2	10	871542.0	9	3	91.3	1961.0	1106.0	1001.0



Unless otherwise agreed in writing, this document is issued by the Company subject to its General Conditions of Service printed overleaf, available on request or accessible at <http://www.sgs.com/en/Terms-and-Conditions.aspx> and, for electronic format documents, subject to Terms and Conditions for Electronic Documents at <http://www.sgs.com/en/Terms-and-Conditions/Terms-e-Documents.aspx>. Attention is drawn to the limitation of liability, indemnification and jurisdiction issues defined therein. Any holder of this document is advised that information contained hereon reflects the Company's findings at the time of its intervention only and within the limits of Client's instructions, if any. The Company's sole responsibility is to its Client and this document does not exonerate parties to a transaction from exercising all their rights and obligations under the transaction documents. This document cannot be reproduced except in full, without prior written approval of the Company. Any unauthorized alteration, forgery or falsification of the content or appearance of this document is unlawful and offenders may be prosecuted to the fullest extent of the law. Unless otherwise stated the results shown in this test report refer only to the sample(s) tested and such sample(s) are retained for 30 days only.

Attention: To check the authenticity of testing/inspection report & certificate, please contact us at telephone: (86-755) 8307 1443, or email: CN.Doccheck@sgs.com

South of No. 6 Plant, No. 1, Runsheng Road, Suzhou Industrial Park, Suzhou Area, China (Jiangsu) Pilot Free Trade Zone 215000 t (86-512) 62992980 www.sgs.com.cn
 中国·苏州·中国(江苏)自由贸易试验区苏州片区苏州工业园区润胜路1号的6号厂房南楼 邮编: 215000 t (86-512) 62992980 sgs.china@sgs.com

@FCC_RLAN_DFS_SPC_Radar_T5_SP2_Tr3@											
TestMode	Channel	Radar Type	Trial ID	Burst ID	Burst Offset (μs)	Chirp Width (MHz)	Number Of Pulses	Pulse Width (μs)	PRI1 (μs)	PRI2 (μs)	PRI3 (μs)
11ac20SISO	5500	Type5	3	0	26541.0	19	2	68.1	1339.0	1355.0	---
11ac20SISO	5500	Type5	3	1	171821.0	19	1	58.7	1251.0	---	---
11ac20SISO	5500	Type5	3	2	316229.0	19	2	75.3	1136.0	1640.0	---
11ac20SISO	5500	Type5	3	3	461864.0	19	1	56.4	1753.0	---	---
11ac20SISO	5500	Type5	3	4	8677.0	19	3	99.7	1196.0	1708.0	1159.0
11ac20SISO	5500	Type5	3	5	153995.0	19	1	57.7	1013.0	---	---
11ac20SISO	5500	Type5	3	6	299238.0	19	1	59.5	1072.0	---	---
11ac20SISO	5500	Type5	3	7	443177.0	19	2	80.0	1482.0	1369.0	---
11ac20SISO	5500	Type5	3	8	587671.0	19	2	82.0	1993.0	1197.0	---
11ac20SISO	5500	Type5	3	9	135674.0	19	2	82.8	1883.0	1005.0	---
11ac20SISO	5500	Type5	3	10	279928.0	19	3	88.0	1061.0	1928.0	1101.0
11ac20SISO	5500	Type5	3	11	424279.0	19	3	93.2	1207.0	1907.0	1223.0
11ac20SISO	5500	Type5	3	12	570132.0	19	2	70.4	1526.0	1360.0	---
11ac20SISO	5500	Type5	3	13	117439.0	19	3	95.3	1171.0	1955.0	1775.0
11ac20SISO	5500	Type5	3	14	262502.0	19	2	81.9	1690.0	1545.0	---
11ac20SISO	5500	Type5	3	15	406573.0	19	3	98.5	1975.0	1169.0	1062.0
11ac20SISO	5500	Type5	3	16	553328.0	19	1	65.0	1767.0	---	---
11ac20SISO	5500	Type5	3	17	99799.0	19	3	85.4	1011.0	1637.0	1425.0
11ac20SISO	5500	Type5	3	18	244095.0	19	3	91.6	1878.0	1445.0	1325.0
11ac20SISO	5500	Type5	3	19	390012.0	19	2	67.3	1091.0	1218.0	---
11ac40SISO	5510	Type5	3	0	26541.0	19	2	68.1	1339.0	1355.0	---
11ac40SISO	5510	Type5	3	1	171821.0	19	1	58.7	1251.0	---	---
11ac40SISO	5510	Type5	3	2	316229.0	19	2	75.3	1136.0	1640.0	---
11ac40SISO	5510	Type5	3	3	461864.0	19	1	56.4	1753.0	---	---
11ac40SISO	5510	Type5	3	4	8677.0	19	3	99.7	1196.0	1708.0	1159.0
11ac40SISO	5510	Type5	3	5	153995.0	19	1	57.7	1013.0	---	---
11ac40SISO	5510	Type5	3	6	299238.0	19	1	59.5	1072.0	---	---
11ac40SISO	5510	Type5	3	7	443177.0	19	2	80.0	1482.0	1369.0	---
11ac40SISO	5510	Type5	3	8	587671.0	19	2	82.0	1993.0	1197.0	---
11ac40SISO	5510	Type5	3	9	135674.0	19	2	82.8	1883.0	1005.0	---
11ac40SISO	5510	Type5	3	10	279928.0	19	3	88.0	1061.0	1928.0	1101.0
11ac40SISO	5510	Type5	3	11	424279.0	19	3	93.2	1207.0	1907.0	1223.0
11ac40SISO	5510	Type5	3	12	570132.0	19	2	70.4	1526.0	1360.0	---
11ac40SISO	5510	Type5	3	13	117439.0	19	3	95.3	1171.0	1955.0	1775.0
11ac40SISO	5510	Type5	3	14	262502.0	19	2	81.9	1690.0	1545.0	---
11ac40SISO	5510	Type5	3	15	406573.0	19	3	98.5	1975.0	1169.0	1062.0
11ac40SISO	5510	Type5	3	16	553328.0	19	1	65.0	1767.0	---	---
11ac40SISO	5510	Type5	3	17	99799.0	19	3	85.4	1011.0	1637.0	1425.0
11ac40SISO	5510	Type5	3	18	244095.0	19	3	91.6	1878.0	1445.0	1325.0
11ac40SISO	5510	Type5	3	19	390012.0	19	2	67.3	1091.0	1218.0	---
11ac80SISO	5530	Type5	3	0	26541.0	19	2	68.1	1339.0	1355.0	---
11ac80SISO	5530	Type5	3	1	171821.0	19	1	58.7	1251.0	---	---
11ac80SISO	5530	Type5	3	2	316229.0	19	2	75.3	1136.0	1640.0	---
11ac80SISO	5530	Type5	3	3	461864.0	19	1	56.4	1753.0	---	---
11ac80SISO	5530	Type5	3	4	8677.0	19	3	99.7	1196.0	1708.0	1159.0
11ac80SISO	5530	Type5	3	5	153995.0	19	1	57.7	1013.0	---	---
11ac80SISO	5530	Type5	3	6	299238.0	19	1	59.5	1072.0	---	---
11ac80SISO	5530	Type5	3	7	443177.0	19	2	80.0	1482.0	1369.0	---
11ac80SISO	5530	Type5	3	8	587671.0	19	2	82.0	1993.0	1197.0	---
11ac80SISO	5530	Type5	3	9	135674.0	19	2	82.8	1883.0	1005.0	---
11ac80SISO	5530	Type5	3	10	279928.0	19	3	88.0	1061.0	1928.0	1101.0
11ac80SISO	5530	Type5	3	11	424279.0	19	3	93.2	1207.0	1907.0	1223.0
11ac80SISO	5530	Type5	3	12	570132.0	19	2	70.4	1526.0	1360.0	---
11ac80SISO	5530	Type5	3	13	117439.0	19	3	95.3	1171.0	1955.0	1775.0
11ac80SISO	5530	Type5	3	14	262502.0	19	2	81.9	1690.0	1545.0	---
11ac80SISO	5530	Type5	3	15	406573.0	19	3	98.5	1975.0	1169.0	1062.0
11ac80SISO	5530	Type5	3	16	553328.0	19	1	65.0	1767.0	---	---



Unless otherwise agreed in writing, this document is issued by the Company subject to its General Conditions of Service printed overleaf, available on request or accessible at <http://www.sgs.com/en/Terms-and-Conditions.aspx> and, for electronic format documents, subject to Terms and Conditions for Electronic Documents at <http://www.sgs.com/en/Terms-and-Conditions/Terms-e-Documents.aspx>. Attention is drawn to the limitation of liability, indemnification and jurisdiction issues defined therein. Any holder of this document is advised that information contained hereon reflects the Company's findings at the time of its intervention only and within the limits of Client's instructions, if any. The Company's sole responsibility is to its Client and this document does not exonerate parties to a transaction from exercising all their rights and obligations under the transaction documents. This document cannot be reproduced except in full, without prior written approval of the Company. Any unauthorized alteration, forgery or falsification of the content or appearance of this document is unlawful and offenders may be prosecuted to the fullest extent of the law. Unless otherwise stated the results shown in this test report refer only to the sample(s) tested and such sample(s) are retained for 30 days only.

Attention: To check the authenticity of testing/inspection report & certificate, please contact us at telephone: (86-755) 83071443, or email: CN.Doccheck@sgs.com

South of No. 6 Plant, No. 1, Runsheng Road, Suzhou Industrial Park, Suzhou Area, China (Jiangsu) Pilot Free Trade Zone 215000 t (86-512) 62992980 www.sgs.com.cn
 中国·苏州·中国(江苏)自由贸易试验区苏州片区苏州工业园区润胜路1号的6号厂房南部 邮编: 215000 t (86-512) 62992980 sgs.china@sgs.com



Report No.: SEWA2209000044RG06

Rev.: 01

Page: 55 of 85

11ac80SISO	5530	Type5	3	17	99799.0	19	3	85.4	1011.0	1637.0	1425.0
11ac80SISO	5530	Type5	3	18	244095.0	19	3	91.6	1878.0	1445.0	1325.0
11ac80SISO	5530	Type5	3	19	390012.0	19	2	67.3	1091.0	1218.0	---



Unless otherwise agreed in writing, this document is issued by the Company subject to its General Conditions of Service printed overleaf, available on request or accessible at <http://www.sgs.com/en/Terms-and-Conditions.aspx> and, for electronic format documents, subject to Terms and Conditions for Electronic Documents at <http://www.sgs.com/en/Terms-and-Conditions/Terms-e-Documents.aspx>. Attention is drawn to the limitation of liability, indemnification and jurisdiction issues defined therein. Any holder of this document is advised that information contained hereon reflects the Company's findings at the time of its intervention only and within the limits of Client's instructions, if any. The Company's sole responsibility is to its Client and this document does not exonerate parties to a transaction from exercising all their rights and obligations under the transaction documents. This document cannot be reproduced except in full, without prior written approval of the Company. Any unauthorized alteration, forgery or falsification of the content or appearance of this document is unlawful and offenders may be prosecuted to the fullest extent of the law. Unless otherwise stated the results shown in this test report refer only to the sample(s) tested and such sample(s) are retained for 30 days only.

Attention: To check the authenticity of testing/inspection report & certificate, please contact us at telephone: (86-755) 8307 1443, or email: CN.Doccheck@sgs.com

South of No. 6 Plant, No. 1, Runsheng Road, Suzhou Industrial Park, Suzhou Area, China (Jiangsu) Pilot Free Trade Zone 215000
 中国·苏州·中国(江苏)自由贸易试验区苏州片区苏州工业园区润胜路1号的6号厂房南部 邮编: 215000

t (86-512) 62992980 www.sgs.com.cn
 t (86-512) 62992980 sgs.china@sgs.com

@FCC_RLAN_DFS_SPC_Radar_T5_SP2_Tr4@											
TestMode	Channel	Radar Type	Trial ID	Burst ID	Burst Offset (μs)	Chirp Width (MHz)	Number Of Pulses	Pulse Width (μs)	PRI1 (μs)	PRI2 (μs)	PRI3 (μs)
11ac20SISO	5500	Type5	4	0	629614.0	16	2	67.9	1320.0	1133.0	---
11ac20SISO	5500	Type5	4	1	96856.0	16	1	62.3	1957.0	---	---
11ac20SISO	5500	Type5	4	2	267719.0	16	1	53.3	1592.0	---	---
11ac20SISO	5500	Type5	4	3	436784.0	16	3	90.0	1900.0	1153.0	1346.0
11ac20SISO	5500	Type5	4	4	608289.0	16	2	77.1	1166.0	1646.0	---
11ac20SISO	5500	Type5	4	5	75610.0	16	3	83.9	1278.0	1232.0	1459.0
11ac20SISO	5500	Type5	4	6	245638.0	16	3	89.1	1240.0	1384.0	1939.0
11ac20SISO	5500	Type5	4	7	416355.0	16	2	81.8	1833.0	1676.0	---
11ac20SISO	5500	Type5	4	8	588736.0	16	1	50.3	1075.0	---	---
11ac20SISO	5500	Type5	4	9	54571.0	16	3	87.1	1116.0	1996.0	1756.0
11ac20SISO	5500	Type5	4	10	225175.0	16	2	71.3	1225.0	1815.0	---
11ac20SISO	5500	Type5	4	11	394825.0	16	3	97.5	1884.0	1465.0	1132.0
11ac20SISO	5500	Type5	4	12	565361.0	16	3	90.6	1561.0	1040.0	1354.0
11ac20SISO	5500	Type5	4	13	33643.0	16	3	86.3	1596.0	1183.0	1792.0
11ac20SISO	5500	Type5	4	14	203957.0	16	3	97.6	1365.0	1073.0	1361.0
11ac20SISO	5500	Type5	4	15	373812.0	16	3	84.7	1021.0	1718.0	1854.0
11ac20SISO	5500	Type5	4	16	544060.0	16	3	99.7	1150.0	1244.0	1988.0
11ac40SISO	5510	Type5	4	0	629614.0	16	2	67.9	1320.0	1133.0	---
11ac40SISO	5510	Type5	4	1	96856.0	16	1	62.3	1957.0	---	---
11ac40SISO	5510	Type5	4	2	267719.0	16	1	53.3	1592.0	---	---
11ac40SISO	5510	Type5	4	3	436784.0	16	3	90.0	1900.0	1153.0	1346.0
11ac40SISO	5510	Type5	4	4	608289.0	16	2	77.1	1166.0	1646.0	---
11ac40SISO	5510	Type5	4	5	75610.0	16	3	83.9	1278.0	1232.0	1459.0
11ac40SISO	5510	Type5	4	6	245638.0	16	3	89.1	1240.0	1384.0	1939.0
11ac40SISO	5510	Type5	4	7	416355.0	16	2	81.8	1833.0	1676.0	---
11ac40SISO	5510	Type5	4	8	588736.0	16	1	50.3	1075.0	---	---
11ac40SISO	5510	Type5	4	9	54571.0	16	3	87.1	1116.0	1996.0	1756.0
11ac40SISO	5510	Type5	4	10	225175.0	16	2	71.3	1225.0	1815.0	---
11ac40SISO	5510	Type5	4	11	394825.0	16	3	97.5	1884.0	1465.0	1132.0
11ac40SISO	5510	Type5	4	12	565361.0	16	3	90.6	1561.0	1040.0	1354.0
11ac40SISO	5510	Type5	4	13	33643.0	16	3	86.3	1596.0	1183.0	1792.0
11ac40SISO	5510	Type5	4	14	203957.0	16	3	97.6	1365.0	1073.0	1361.0
11ac40SISO	5510	Type5	4	15	373812.0	16	3	84.7	1021.0	1718.0	1854.0
11ac40SISO	5510	Type5	4	16	544060.0	16	3	99.7	1150.0	1244.0	1988.0
11ac80SISO	5530	Type5	4	0	629614.0	16	2	67.9	1320.0	1133.0	---
11ac80SISO	5530	Type5	4	1	96856.0	16	1	62.3	1957.0	---	---
11ac80SISO	5530	Type5	4	2	267719.0	16	1	53.3	1592.0	---	---
11ac80SISO	5530	Type5	4	3	436784.0	16	3	90.0	1900.0	1153.0	1346.0
11ac80SISO	5530	Type5	4	4	608289.0	16	2	77.1	1166.0	1646.0	---
11ac80SISO	5530	Type5	4	5	75610.0	16	3	83.9	1278.0	1232.0	1459.0
11ac80SISO	5530	Type5	4	6	245638.0	16	3	89.1	1240.0	1384.0	1939.0
11ac80SISO	5530	Type5	4	7	416355.0	16	2	81.8	1833.0	1676.0	---
11ac80SISO	5530	Type5	4	8	588736.0	16	1	50.3	1075.0	---	---
11ac80SISO	5530	Type5	4	9	54571.0	16	3	87.1	1116.0	1996.0	1756.0
11ac80SISO	5530	Type5	4	10	225175.0	16	2	71.3	1225.0	1815.0	---
11ac80SISO	5530	Type5	4	11	394825.0	16	3	97.5	1884.0	1465.0	1132.0
11ac80SISO	5530	Type5	4	12	565361.0	16	3	90.6	1561.0	1040.0	1354.0
11ac80SISO	5530	Type5	4	13	33643.0	16	3	86.3	1596.0	1183.0	1792.0
11ac80SISO	5530	Type5	4	14	203957.0	16	3	97.6	1365.0	1073.0	1361.0
11ac80SISO	5530	Type5	4	15	373812.0	16	3	84.7	1021.0	1718.0	1854.0
11ac80SISO	5530	Type5	4	16	544060.0	16	3	99.7	1150.0	1244.0	1988.0



Unless otherwise agreed in writing, this document is issued by the Company subject to its General Conditions of Service printed overleaf, available on request or accessible at <http://www.sgs.com/en/Terms-and-Conditions.aspx> and, for electronic format documents, subject to Terms and Conditions for Electronic Documents at <http://www.sgs.com/en/Terms-and-Conditions/Terms-e-Documents.aspx>. Attention is drawn to the limitation of liability, indemnification and jurisdiction issues defined therein. Any holder of this document is advised that information contained hereon reflects the Company's findings at the time of its intervention only and within the limits of Client's instructions, if any. The Company's sole responsibility is to its Client and this document does not exonerate parties to a transaction from exercising all their rights and obligations under the transaction documents. This document cannot be reproduced except in full, without prior written approval of the Company. Any unauthorized alteration, forgery or falsification of the content or appearance of this document is unlawful and offenders may be prosecuted to the fullest extent of the law. Unless otherwise stated the results shown in this test report refer only to the sample(s) tested and such sample(s) are retained for 30 days only.

Attention: To check the authenticity of testing/inspection report & certificate, please contact us at telephone: (86-755) 83071443, or email: CN.Doccheck@sgs.com

South of No. 6 Plant, No. 1, Runsheng Road, Suzhou Industrial Park, Suzhou Area, China (Jiangsu) Pilot Free Trade Zone 215000 t (86-512) 62992980 www.sgs.com.cn
 中国·苏州·中国(江苏)自由贸易试验区苏州片区苏州工业园区润胜路1号的6号厂房南楼 邮编: 215000 t (86-512) 62992980 sgs.china@sgs.com

@FCC_RLAN_DFS_SPC_Radar_T5_SP2_Tr5@											
TestMode	Channel	Radar Type	Trial ID	Burst ID	Burst Offset (μs)	Chirp Width (MHz)	Number Of Pulses	Pulse Width (μs)	PRI1 (μs)	PRI2 (μs)	PRI3 (μs)
11ac20SISO	5500	Type5	5	0	15438.0	12	3	92.9	1085.0	1564.0	1407.0
11ac20SISO	5500	Type5	5	1	222486.0	12	2	67.7	1744.0	1747.0	---
11ac20SISO	5500	Type5	5	2	430731.0	12	1	65.8	1092.0	---	---
11ac20SISO	5500	Type5	5	3	637784.0	12	1	56.3	1851.0	---	---
11ac20SISO	5500	Type5	5	4	845342.0	12	1	53.7	1727.0	---	---
11ac20SISO	5500	Type5	5	5	196720.0	12	3	83.5	1679.0	1930.0	1025.0
11ac20SISO	5500	Type5	5	6	404955.0	12	1	65.8	1519.0	---	---
11ac20SISO	5500	Type5	5	7	610711.0	12	3	85.9	1134.0	1034.0	1808.0
11ac20SISO	5500	Type5	5	8	818057.0	12	2	76.3	1606.0	1926.0	---
11ac20SISO	5500	Type5	5	9	171459.0	12	2	81.5	1891.0	1714.0	---
11ac20SISO	5500	Type5	5	10	377969.0	12	3	89.4	1310.0	1594.0	1827.0
11ac20SISO	5500	Type5	5	11	586875.0	12	1	63.4	1568.0	---	---
11ac20SISO	5500	Type5	5	12	792834.0	12	2	69.6	1307.0	1925.0	---
11ac20SISO	5500	Type5	5	13	146044.0	12	2	74.5	1264.0	1846.0	---
11ac40SISO	5510	Type5	5	0	15438.0	12	3	92.9	1085.0	1564.0	1407.0
11ac40SISO	5510	Type5	5	1	222486.0	12	2	67.7	1744.0	1747.0	---
11ac40SISO	5510	Type5	5	2	430731.0	12	1	65.8	1092.0	---	---
11ac40SISO	5510	Type5	5	3	637784.0	12	1	56.3	1851.0	---	---
11ac40SISO	5510	Type5	5	4	845342.0	12	1	53.7	1727.0	---	---
11ac40SISO	5510	Type5	5	5	196720.0	12	3	83.5	1679.0	1930.0	1025.0
11ac40SISO	5510	Type5	5	6	404955.0	12	1	65.8	1519.0	---	---
11ac40SISO	5510	Type5	5	7	610711.0	12	3	85.9	1134.0	1034.0	1808.0
11ac40SISO	5510	Type5	5	8	818057.0	12	2	76.3	1606.0	1926.0	---
11ac40SISO	5510	Type5	5	9	171459.0	12	2	81.5	1891.0	1714.0	---
11ac40SISO	5510	Type5	5	10	377969.0	12	3	89.4	1310.0	1594.0	1827.0
11ac40SISO	5510	Type5	5	11	586875.0	12	1	63.4	1568.0	---	---
11ac40SISO	5510	Type5	5	12	792834.0	12	2	69.6	1307.0	1925.0	---
11ac40SISO	5510	Type5	5	13	146044.0	12	2	74.5	1264.0	1846.0	---
11ac80SISO	5530	Type5	5	0	15438.0	12	3	92.9	1085.0	1564.0	1407.0
11ac80SISO	5530	Type5	5	1	222486.0	12	2	67.7	1744.0	1747.0	---
11ac80SISO	5530	Type5	5	2	430731.0	12	1	65.8	1092.0	---	---
11ac80SISO	5530	Type5	5	3	637784.0	12	1	56.3	1851.0	---	---
11ac80SISO	5530	Type5	5	4	845342.0	12	1	53.7	1727.0	---	---
11ac80SISO	5530	Type5	5	5	196720.0	12	3	83.5	1679.0	1930.0	1025.0
11ac80SISO	5530	Type5	5	6	404955.0	12	1	65.8	1519.0	---	---
11ac80SISO	5530	Type5	5	7	610711.0	12	3	85.9	1134.0	1034.0	1808.0
11ac80SISO	5530	Type5	5	8	818057.0	12	2	76.3	1606.0	1926.0	---
11ac80SISO	5530	Type5	5	9	171459.0	12	2	81.5	1891.0	1714.0	---
11ac80SISO	5530	Type5	5	10	377969.0	12	3	89.4	1310.0	1594.0	1827.0
11ac80SISO	5530	Type5	5	11	586875.0	12	1	63.4	1568.0	---	---
11ac80SISO	5530	Type5	5	12	792834.0	12	2	69.6	1307.0	1925.0	---
11ac80SISO	5530	Type5	5	13	146044.0	12	2	74.5	1264.0	1846.0	---



Unless otherwise agreed in writing, this document is issued by the Company subject to its General Conditions of Service printed overleaf, available on request or accessible at <http://www.sgs.com/en/Terms-and-Conditions.aspx> and, for electronic format documents, subject to Terms and Conditions for Electronic Documents at <http://www.sgs.com/en/Terms-and-Conditions/Terms-e-Documents.aspx>. Attention is drawn to the limitation of liability, indemnification and jurisdiction issues defined therein. Any holder of this document is advised that information contained hereon reflects the Company's findings at the time of its intervention only and within the limits of Client's instructions, if any. The Company's sole responsibility is to its Client and this document does not exonerate parties to a transaction from exercising all their rights and obligations under the transaction documents. This document cannot be reproduced except in full, without prior written approval of the Company. Any unauthorized alteration, forgery or falsification of the content or appearance of this document is unlawful and offenders may be prosecuted to the fullest extent of the law. Unless otherwise stated the results shown in this test report refer only to the sample(s) tested and such sample(s) are retained for 30 days only.

Attention: To check the authenticity of testing/inspection report & certificate, please contact us at telephone: (86-755) 83071443, or email: CN.Doccheck@sgs.com

South of No. 6 Plant, No. 1, Runsheng Road, Suzhou Industrial Park, Suzhou Area, China (Jiangsu) Pilot Free Trade Zone 215000 t (86-512) 62992980 www.sgs.com.cn
 中国·苏州·中国(江苏)自由贸易试验区苏州片区苏州工业园区润胜路1号的6号厂房南楼 邮编: 215000 t (86-512) 62992980 sgs.china@sgs.com

@FCC_RLAN_DFS_SPC_Radar_T5_SP2_Tr6@											
TestMode	Channel	Radar Type	Trial ID	Burst ID	Burst Offset (μs)	Chirp Width (MHz)	Number Of Pulses	Pulse Width (μs)	PRI1 (μs)	PRI2 (μs)	PRI3 (μs)
11ac20SISO	5500	Type5	6	0	329022.0	13	3	96.6	1182.0	1609.0	1581.0
11ac20SISO	5500	Type5	6	1	521718.0	13	3	96.7	1829.0	1799.0	1154.0
11ac20SISO	5500	Type5	6	2	714222.0	13	3	86.5	1923.0	1396.0	1865.0
11ac20SISO	5500	Type5	6	3	112450.0	13	2	73.3	1908.0	1318.0	---
11ac20SISO	5500	Type5	6	4	306283.0	13	1	55.8	1688.0	---	---
11ac20SISO	5500	Type5	6	5	500239.0	13	1	55.4	1145.0	---	---
11ac20SISO	5500	Type5	6	6	690932.0	13	3	85.3	1336.0	1504.0	1820.0
11ac20SISO	5500	Type5	6	7	88645.0	13	2	79.4	1344.0	1893.0	---
11ac20SISO	5500	Type5	6	8	282508.0	13	1	65.7	1476.0	---	---
11ac20SISO	5500	Type5	6	9	475842.0	13	2	68.6	1008.0	1028.0	---
11ac20SISO	5500	Type5	6	10	667887.0	13	2	77.7	1972.0	1835.0	---
11ac20SISO	5500	Type5	6	11	64845.0	13	2	79.6	1882.0	1331.0	---
11ac20SISO	5500	Type5	6	12	257755.0	13	3	94.9	1830.0	1070.0	1349.0
11ac20SISO	5500	Type5	6	13	452335.0	13	1	61.4	1451.0	---	---
11ac20SISO	5500	Type5	6	14	643395.0	13	3	90.6	1233.0	1562.0	1887.0
11ac40SISO	5510	Type5	6	0	329022.0	13	3	96.6	1182.0	1609.0	1581.0
11ac40SISO	5510	Type5	6	1	521718.0	13	3	96.7	1829.0	1799.0	1154.0
11ac40SISO	5510	Type5	6	2	714222.0	13	3	86.5	1923.0	1396.0	1865.0
11ac40SISO	5510	Type5	6	3	112450.0	13	2	73.3	1908.0	1318.0	---
11ac40SISO	5510	Type5	6	4	306283.0	13	1	55.8	1688.0	---	---
11ac40SISO	5510	Type5	6	5	500239.0	13	1	55.4	1145.0	---	---
11ac40SISO	5510	Type5	6	6	690932.0	13	3	85.3	1336.0	1504.0	1820.0
11ac40SISO	5510	Type5	6	7	88645.0	13	2	79.4	1344.0	1893.0	---
11ac40SISO	5510	Type5	6	8	282508.0	13	1	65.7	1476.0	---	---
11ac40SISO	5510	Type5	6	9	475842.0	13	2	68.6	1008.0	1028.0	---
11ac40SISO	5510	Type5	6	10	667887.0	13	2	77.7	1972.0	1835.0	---
11ac40SISO	5510	Type5	6	11	64845.0	13	2	79.6	1882.0	1331.0	---
11ac40SISO	5510	Type5	6	12	257755.0	13	3	94.9	1830.0	1070.0	1349.0
11ac40SISO	5510	Type5	6	13	452335.0	13	1	61.4	1451.0	---	---
11ac40SISO	5510	Type5	6	14	643395.0	13	3	90.6	1233.0	1562.0	1887.0
11ac80SISO	5530	Type5	6	0	329022.0	13	3	96.6	1182.0	1609.0	1581.0
11ac80SISO	5530	Type5	6	1	521718.0	13	3	96.7	1829.0	1799.0	1154.0
11ac80SISO	5530	Type5	6	2	714222.0	13	3	86.5	1923.0	1396.0	1865.0
11ac80SISO	5530	Type5	6	3	112450.0	13	2	73.3	1908.0	1318.0	---
11ac80SISO	5530	Type5	6	4	306283.0	13	1	55.8	1688.0	---	---
11ac80SISO	5530	Type5	6	5	500239.0	13	1	55.4	1145.0	---	---
11ac80SISO	5530	Type5	6	6	690932.0	13	3	85.3	1336.0	1504.0	1820.0
11ac80SISO	5530	Type5	6	7	88645.0	13	2	79.4	1344.0	1893.0	---
11ac80SISO	5530	Type5	6	8	282508.0	13	1	65.7	1476.0	---	---
11ac80SISO	5530	Type5	6	9	475842.0	13	2	68.6	1008.0	1028.0	---
11ac80SISO	5530	Type5	6	10	667887.0	13	2	77.7	1972.0	1835.0	---
11ac80SISO	5530	Type5	6	11	64845.0	13	2	79.6	1882.0	1331.0	---
11ac80SISO	5530	Type5	6	12	257755.0	13	3	94.9	1830.0	1070.0	1349.0
11ac80SISO	5530	Type5	6	13	452335.0	13	1	61.4	1451.0	---	---
11ac80SISO	5530	Type5	6	14	643395.0	13	3	90.6	1233.0	1562.0	1887.0



Unless otherwise agreed in writing, this document is issued by the Company subject to its General Conditions of Service printed overleaf, available on request or accessible at <http://www.sgs.com/en/Terms-and-Conditions.aspx> and, for electronic format documents, subject to Terms and Conditions for Electronic Documents at <http://www.sgs.com/en/Terms-and-Conditions/Terms-e-Documents.aspx>. Attention is drawn to the limitation of liability, indemnification and jurisdiction issues defined therein. Any holder of this document is advised that information contained hereon reflects the Company's findings at the time of its intervention only and within the limits of Client's instructions, if any. The Company's sole responsibility is to its Client and this document does not exonerate parties to a transaction from exercising all their rights and obligations under the transaction documents. This document cannot be reproduced except in full, without prior written approval of the Company. Any unauthorized alteration, forgery or falsification of the content or appearance of this document is unlawful and offenders may be prosecuted to the fullest extent of the law. Unless otherwise stated the results shown in this test report refer only to the sample(s) tested and such sample(s) are retained for 30 days only.

Attention: To check the authenticity of testing/inspection report & certificate, please contact us at telephone: (86-755) 8307 1443, or email: CN.Doccheck@sgs.com

South of No. 6 Plant, No. 1, Runsheng Road, Suzhou Industrial Park, Suzhou Area, China (Jiangsu) Pilot Free Trade Zone 215000
 中国·苏州·中国(江苏)自由贸易试验区苏州片区苏州工业园区润胜路1号的6号厂房南楼 邮编: 215000

t (86-512) 62992980 www.sgs.com.cn
 t (86-512) 62992980 sgs.china@sgs.com

@FCC_RLAN_DFS_SPC_Radar_T5_SP2_Tr7@

TestMode	Channel	Radar Type	Trial ID	Burst ID	Burst Offset (μs)	Chirp Width (MHz)	Number Of Pulses	Pulse Width (μs)	PRI1 (μs)	PRI2 (μs)	PRI3 (μs)
11ac20SISO	5500	Type5	7	0	51446.0	10	1	52.6	1210.0	---	---
11ac20SISO	5500	Type5	7	1	292696.0	10	3	84.1	1314.0	1725.0	1529.0
11ac20SISO	5500	Type5	7	2	533989.0	10	3	97.7	1139.0	1868.0	1805.0
11ac20SISO	5500	Type5	7	3	775564.0	10	3	97.3	1341.0	1446.0	1755.0
11ac20SISO	5500	Type5	7	4	21542.0	10	3	98.8	1544.0	1386.0	1302.0
11ac20SISO	5500	Type5	7	5	263385.0	10	2	72.2	1771.0	1184.0	---
11ac20SISO	5500	Type5	7	6	505581.0	10	2	67.6	1175.0	1027.0	---
11ac20SISO	5500	Type5	7	7	747058.0	10	2	75.7	1026.0	1871.0	---
11ac20SISO	5500	Type5	7	8	989976.0	10	1	60.9	1798.0	---	---
11ac20SISO	5500	Type5	7	9	234024.0	10	1	64.2	1138.0	---	---
11ac20SISO	5500	Type5	7	10	475207.0	10	2	78.8	1784.0	1604.0	---
11ac20SISO	5500	Type5	7	11	715825.0	10	3	87.5	1511.0	1712.0	1683.0
11ac40SISO	5510	Type5	7	0	51446.0	10	1	52.6	1210.0	---	---
11ac40SISO	5510	Type5	7	1	292696.0	10	3	84.1	1314.0	1725.0	1529.0
11ac40SISO	5510	Type5	7	2	533989.0	10	3	97.7	1139.0	1868.0	1805.0
11ac40SISO	5510	Type5	7	3	775564.0	10	3	97.3	1341.0	1446.0	1755.0
11ac40SISO	5510	Type5	7	4	21542.0	10	3	98.8	1544.0	1386.0	1302.0
11ac40SISO	5510	Type5	7	5	263385.0	10	2	72.2	1771.0	1184.0	---
11ac40SISO	5510	Type5	7	6	505581.0	10	2	67.6	1175.0	1027.0	---
11ac40SISO	5510	Type5	7	7	747058.0	10	2	75.7	1026.0	1871.0	---
11ac40SISO	5510	Type5	7	8	989976.0	10	1	60.9	1798.0	---	---
11ac40SISO	5510	Type5	7	9	234024.0	10	1	64.2	1138.0	---	---
11ac40SISO	5510	Type5	7	10	475207.0	10	2	78.8	1784.0	1604.0	---
11ac40SISO	5510	Type5	7	11	715825.0	10	3	87.5	1511.0	1712.0	1683.0
11ac80SISO	5530	Type5	7	0	51446.0	10	1	52.6	1210.0	---	---
11ac80SISO	5530	Type5	7	1	292696.0	10	3	84.1	1314.0	1725.0	1529.0
11ac80SISO	5530	Type5	7	2	533989.0	10	3	97.7	1139.0	1868.0	1805.0
11ac80SISO	5530	Type5	7	3	775564.0	10	3	97.3	1341.0	1446.0	1755.0
11ac80SISO	5530	Type5	7	4	21542.0	10	3	98.8	1544.0	1386.0	1302.0
11ac80SISO	5530	Type5	7	5	263385.0	10	2	72.2	1771.0	1184.0	---
11ac80SISO	5530	Type5	7	6	505581.0	10	2	67.6	1175.0	1027.0	---
11ac80SISO	5530	Type5	7	7	747058.0	10	2	75.7	1026.0	1871.0	---
11ac80SISO	5530	Type5	7	8	989976.0	10	1	60.9	1798.0	---	---
11ac80SISO	5530	Type5	7	9	234024.0	10	1	64.2	1138.0	---	---
11ac80SISO	5530	Type5	7	10	475207.0	10	2	78.8	1784.0	1604.0	---
11ac80SISO	5530	Type5	7	11	715825.0	10	3	87.5	1511.0	1712.0	1683.0



Unless otherwise agreed in writing, this document is issued by the Company subject to its General Conditions of Service printed overleaf, available on request or accessible at <http://www.sgs.com/en/Terms-and-Conditions.aspx> and, for electronic format documents, subject to Terms and Conditions for Electronic Documents at <http://www.sgs.com/en/Terms-and-Conditions/Terms-e-Documents.aspx>. Attention is drawn to the limitation of liability, indemnification and jurisdiction issues defined therein. Any holder of this document is advised that information contained hereon reflects the Company's findings at the time of its intervention only and within the limits of Client's instructions, if any. The Company's sole responsibility is to its Client and this document does not exonerate parties to a transaction from exercising all their rights and obligations under the transaction documents. This document cannot be reproduced except in full, without prior written approval of the Company. Any unauthorized alteration, forgery or falsification of the content or appearance of this document is unlawful and offenders may be prosecuted to the fullest extent of the law. Unless otherwise stated the results shown in this test report refer only to the sample(s) tested and such sample(s) are retained for 30 days only.

Attention: To check the authenticity of testing/inspection report & certificate, please contact us at telephone: (86-755) 8307 1443, or email: CN.Doccheck@sgs.com

South of No. 6 Plant, No. 1, Runsheng Road, Suzhou Industrial Park, Suzhou Area, China (Jiangsu) Pilot Free Trade Zone 215000 t (86-512) 62992980 www.sgs.com.cn
 中国·苏州·中国(江苏)自由贸易试验区苏州片区苏州工业园区润胜路1号的6号厂房南楼 邮编: 215000 t (86-512) 62992980 sgs.china@sgs.com

@FCC_RLAN_DFS_SPC_Radar_T5_SP2_Tr8@											
TestMode	Channel	Radar Type	Trial ID	Burst ID	Burst Offset (μs)	Chirp Width (MHz)	Number Of Pulses	Pulse Width (μs)	PRI1 (μs)	PRI2 (μs)	PRI3 (μs)
11ac20SISO	5500	Type5	8	0	823112.0	13	1	54.1	1415.0	---	---
11ac20SISO	5500	Type5	8	1	174965.0	13	1	50.7	1221.0	---	---
11ac20SISO	5500	Type5	8	2	382216.0	13	1	52.3	1974.0	---	---
11ac20SISO	5500	Type5	8	3	587395.0	13	3	99.8	1558.0	1696.0	1949.0
11ac20SISO	5500	Type5	8	4	796897.0	13	2	68.4	1014.0	1099.0	---
11ac20SISO	5500	Type5	8	5	149042.0	13	2	80.8	1736.0	1505.0	---
11ac20SISO	5500	Type5	8	6	356750.0	13	1	62.5	1778.0	---	---
11ac20SISO	5500	Type5	8	7	563824.0	13	2	74.8	1149.0	1204.0	---
11ac20SISO	5500	Type5	8	8	772314.0	13	1	50.8	1049.0	---	---
11ac20SISO	5500	Type5	8	9	123796.0	13	1	54.0	1417.0	---	---
11ac20SISO	5500	Type5	8	10	331215.0	13	1	63.0	1730.0	---	---
11ac20SISO	5500	Type5	8	11	537402.0	13	3	91.8	1143.0	1270.0	1347.0
11ac20SISO	5500	Type5	8	12	744805.0	13	2	79.3	1274.0	1992.0	---
11ac20SISO	5500	Type5	8	13	98172.0	13	1	64.3	1937.0	---	---
11ac40SISO	5510	Type5	8	0	823112.0	13	1	54.1	1415.0	---	---
11ac40SISO	5510	Type5	8	1	174965.0	13	1	50.7	1221.0	---	---
11ac40SISO	5510	Type5	8	2	382216.0	13	1	52.3	1974.0	---	---
11ac40SISO	5510	Type5	8	3	587395.0	13	3	99.8	1558.0	1696.0	1949.0
11ac40SISO	5510	Type5	8	4	796897.0	13	2	68.4	1014.0	1099.0	---
11ac40SISO	5510	Type5	8	5	149042.0	13	2	80.8	1736.0	1505.0	---
11ac40SISO	5510	Type5	8	6	356750.0	13	1	62.5	1778.0	---	---
11ac40SISO	5510	Type5	8	7	563824.0	13	2	74.8	1149.0	1204.0	---
11ac40SISO	5510	Type5	8	8	772314.0	13	1	50.8	1049.0	---	---
11ac40SISO	5510	Type5	8	9	123796.0	13	1	54.0	1417.0	---	---
11ac40SISO	5510	Type5	8	10	331215.0	13	1	63.0	1730.0	---	---
11ac40SISO	5510	Type5	8	11	537402.0	13	3	91.8	1143.0	1270.0	1347.0
11ac40SISO	5510	Type5	8	12	744805.0	13	2	79.3	1274.0	1992.0	---
11ac40SISO	5510	Type5	8	13	98172.0	13	1	64.3	1937.0	---	---
11ac80SISO	5530	Type5	8	0	823112.0	13	1	54.1	1415.0	---	---
11ac80SISO	5530	Type5	8	1	174965.0	13	1	50.7	1221.0	---	---
11ac80SISO	5530	Type5	8	2	382216.0	13	1	52.3	1974.0	---	---
11ac80SISO	5530	Type5	8	3	587395.0	13	3	99.8	1558.0	1696.0	1949.0
11ac80SISO	5530	Type5	8	4	796897.0	13	2	68.4	1014.0	1099.0	---
11ac80SISO	5530	Type5	8	5	149042.0	13	2	80.8	1736.0	1505.0	---
11ac80SISO	5530	Type5	8	6	356750.0	13	1	62.5	1778.0	---	---
11ac80SISO	5530	Type5	8	7	563824.0	13	2	74.8	1149.0	1204.0	---
11ac80SISO	5530	Type5	8	8	772314.0	13	1	50.8	1049.0	---	---
11ac80SISO	5530	Type5	8	9	123796.0	13	1	54.0	1417.0	---	---
11ac80SISO	5530	Type5	8	10	331215.0	13	1	63.0	1730.0	---	---
11ac80SISO	5530	Type5	8	11	537402.0	13	3	91.8	1143.0	1270.0	1347.0
11ac80SISO	5530	Type5	8	12	744805.0	13	2	79.3	1274.0	1992.0	---
11ac80SISO	5530	Type5	8	13	98172.0	13	1	64.3	1937.0	---	---



Unless otherwise agreed in writing, this document is issued by the Company subject to its General Conditions of Service printed overleaf, available on request or accessible at <http://www.sgs.com/en/Terms-and-Conditions.aspx> and, for electronic format documents, subject to Terms and Conditions for Electronic Documents at <http://www.sgs.com/en/Terms-and-Conditions/Terms-e-Documents.aspx>. Attention is drawn to the limitation of liability, indemnification and jurisdiction issues defined therein. Any holder of this document is advised that information contained hereon reflects the Company's findings at the time of its intervention only and within the limits of Client's instructions, if any. The Company's sole responsibility is to its Client and this document does not exonerate parties to a transaction from exercising all their rights and obligations under the transaction documents. This document cannot be reproduced except in full, without prior written approval of the Company. Any unauthorized alteration, forgery or falsification of the content or appearance of this document is unlawful and offenders may be prosecuted to the fullest extent of the law. Unless otherwise stated the results shown in this test report refer only to the sample(s) tested and such sample(s) are retained for 30 days only.

Attention: To check the authenticity of testing/inspection report & certificate, please contact us at telephone: (86-755) 8307 1443, or email: CN.Doccheck@sgs.com

South of No. 6 Plant, No. 1, Runsheng Road, Suzhou Industrial Park, Suzhou Area, China (Jiangsu) Pilot Free Trade Zone 215000 t (86-512) 62992980 www.sgs.com.cn
 中国·苏州·中国(江苏)自由贸易试验区苏州片区苏州工业园区润胜路1号的6号厂房南楼 邮编: 215000 t (86-512) 62992980 sgs.china@sgs.com

@FCC_RLAN_DFS_SPC_Radar_T5_SP2_Tr9@											
TestMode	Channel	Radar Type	Trial ID	Burst ID	Burst Offset (μs)	Chirp Width (MHz)	Number Of Pulses	Pulse Width (μs)	PRI1 (μs)	PRI2 (μs)	PRI3 (μs)
11ac20SISO	5500	Type5	9	0	535615.0	6	1	63.4	1043.0	---	---
11ac20SISO	5500	Type5	9	1	898668.0	6	1	52.0	1863.0	---	---
11ac20SISO	5500	Type5	9	2	1259235.0	6	3	97.2	1973.0	1605.0	1583.0
11ac20SISO	5500	Type5	9	3	127106.0	6	2	78.7	1466.0	1743.0	---
11ac20SISO	5500	Type5	9	4	490358.0	6	2	74.2	1280.0	1219.0	---
11ac20SISO	5500	Type5	9	5	852409.0	6	3	88.7	1293.0	1934.0	1273.0
11ac20SISO	5500	Type5	9	6	1217152.0	6	1	54.3	1991.0	---	---
11ac20SISO	5500	Type5	9	7	82296.0	6	3	95.4	1580.0	1555.0	1791.0
11ac40SISO	5510	Type5	9	0	535615.0	6	1	63.4	1043.0	---	---
11ac40SISO	5510	Type5	9	1	898668.0	6	1	52.0	1863.0	---	---
11ac40SISO	5510	Type5	9	2	1259235.0	6	3	97.2	1973.0	1605.0	1583.0
11ac40SISO	5510	Type5	9	3	127106.0	6	2	78.7	1466.0	1743.0	---
11ac40SISO	5510	Type5	9	4	490358.0	6	2	74.2	1280.0	1219.0	---
11ac40SISO	5510	Type5	9	5	852409.0	6	3	88.7	1293.0	1934.0	1273.0
11ac40SISO	5510	Type5	9	6	1217152.0	6	1	54.3	1991.0	---	---
11ac40SISO	5510	Type5	9	7	82296.0	6	3	95.4	1580.0	1555.0	1791.0
11ac80SISO	5530	Type5	9	0	535615.0	6	1	63.4	1043.0	---	---
11ac80SISO	5530	Type5	9	1	898668.0	6	1	52.0	1863.0	---	---
11ac80SISO	5530	Type5	9	2	1259235.0	6	3	97.2	1973.0	1605.0	1583.0
11ac80SISO	5530	Type5	9	3	127106.0	6	2	78.7	1466.0	1743.0	---
11ac80SISO	5530	Type5	9	4	490358.0	6	2	74.2	1280.0	1219.0	---
11ac80SISO	5530	Type5	9	5	852409.0	6	3	88.7	1293.0	1934.0	1273.0
11ac80SISO	5530	Type5	9	6	1217152.0	6	1	54.3	1991.0	---	---
11ac80SISO	5530	Type5	9	7	82296.0	6	3	95.4	1580.0	1555.0	1791.0



Unless otherwise agreed in writing, this document is issued by the Company subject to its General Conditions of Service printed overleaf, available on request or accessible at <http://www.sgs.com/en/Terms-and-Conditions.aspx> and, for electronic format documents, subject to Terms and Conditions for Electronic Documents at <http://www.sgs.com/en/Terms-and-Conditions/Terms-e-Documents.aspx>. Attention is drawn to the limitation of liability, indemnification and jurisdiction issues defined therein. Any holder of this document is advised that information contained hereon reflects the Company's findings at the time of its intervention only and within the limits of Client's instructions, if any. The Company's sole responsibility is to its Client and this document does not exonerate parties to a transaction from exercising all their rights and obligations under the transaction documents. This document cannot be reproduced except in full, without prior written approval of the Company. Any unauthorized alteration, forgery or falsification of the content or appearance of this document is unlawful and offenders may be prosecuted to the fullest extent of the law. Unless otherwise stated the results shown in this test report refer only to the sample(s) tested and such sample(s) are retained for 30 days only.

Attention: To check the authenticity of testing/inspection report & certificate, please contact us at telephone: (86-755) 83071443, or email: CN.Doccheck@sgs.com

South of No. 6 Plant, No. 1, Runsheng Road, Suzhou Industrial Park, Suzhou Area, China (Jiangsu) Pilot Free Trade Zone 215000 t (86-512) 62992980 www.sgs.com.cn
 中国·苏州·中国(江苏)自由贸易试验区苏州片区苏州工业园区润胜路1号的6号厂房南楼 邮编: 215000 t (86-512) 62992980 sgs.china@sgs.com

@FCC_RLAN_DFS_SPC_Radar_T5_SP2_Tr10@											
TestMode	Channel	Radar Type	Trial ID	Burst ID	Burst Offset (μs)	Chirp Width (MHz)	Number Of Pulses	Pulse Width (μs)	PRI1 (μs)	PRI2 (μs)	PRI3 (μs)
11ac20SISO	5500	Type5	10	0	209249.0	16	2	73.7	1208.0	1497.0	---
11ac20SISO	5500	Type5	10	1	378386.0	16	3	97.4	1942.0	1754.0	1613.0
11ac20SISO	5500	Type5	10	2	548411.0	16	3	91.7	1999.0	1702.0	1462.0
11ac20SISO	5500	Type5	10	3	17733.0	16	1	66.2	1393.0	---	---
11ac20SISO	5500	Type5	10	4	187952.0	16	2	70.8	1968.0	1821.0	---
11ac20SISO	5500	Type5	10	5	359277.0	16	1	52.3	1740.0	---	---
11ac20SISO	5500	Type5	10	6	528886.0	16	2	78.9	1308.0	1984.0	---
11ac20SISO	5500	Type5	10	7	700166.0	16	2	70.9	1050.0	1358.0	---
11ac20SISO	5500	Type5	10	8	167197.0	16	2	75.6	1437.0	1430.0	---
11ac20SISO	5500	Type5	10	9	338262.0	16	1	59.1	1697.0	---	---
11ac20SISO	5500	Type5	10	10	508324.0	16	2	77.0	1397.0	1304.0	---
11ac20SISO	5500	Type5	10	11	678689.0	16	2	67.9	1803.0	1083.0	---
11ac20SISO	5500	Type5	10	12	146031.0	16	2	81.2	1720.0	1932.0	---
11ac20SISO	5500	Type5	10	13	316923.0	16	2	78.7	1247.0	1121.0	---
11ac20SISO	5500	Type5	10	14	488056.0	16	1	63.3	1634.0	---	---
11ac20SISO	5500	Type5	10	15	657326.0	16	2	68.9	1849.0	1423.0	---
11ac20SISO	5500	Type5	10	16	125509.0	16	1	59.3	1093.0	---	---
11ac40SISO	5510	Type5	10	0	209249.0	16	2	73.7	1208.0	1497.0	---
11ac40SISO	5510	Type5	10	1	378386.0	16	3	97.4	1942.0	1754.0	1613.0
11ac40SISO	5510	Type5	10	2	548411.0	16	3	91.7	1999.0	1702.0	1462.0
11ac40SISO	5510	Type5	10	3	17733.0	16	1	66.2	1393.0	---	---
11ac40SISO	5510	Type5	10	4	187952.0	16	2	70.8	1968.0	1821.0	---
11ac40SISO	5510	Type5	10	5	359277.0	16	1	52.3	1740.0	---	---
11ac40SISO	5510	Type5	10	6	528886.0	16	2	78.9	1308.0	1984.0	---
11ac40SISO	5510	Type5	10	7	700166.0	16	2	70.9	1050.0	1358.0	---
11ac40SISO	5510	Type5	10	8	167197.0	16	2	75.6	1437.0	1430.0	---
11ac40SISO	5510	Type5	10	9	338262.0	16	1	59.1	1697.0	---	---
11ac40SISO	5510	Type5	10	10	508324.0	16	2	77.0	1397.0	1304.0	---
11ac40SISO	5510	Type5	10	11	678689.0	16	2	67.9	1803.0	1083.0	---
11ac40SISO	5510	Type5	10	12	146031.0	16	2	81.2	1720.0	1932.0	---
11ac40SISO	5510	Type5	10	13	316923.0	16	2	78.7	1247.0	1121.0	---
11ac40SISO	5510	Type5	10	14	488056.0	16	1	63.3	1634.0	---	---
11ac40SISO	5510	Type5	10	15	657326.0	16	2	68.9	1849.0	1423.0	---
11ac40SISO	5510	Type5	10	16	125509.0	16	1	59.3	1093.0	---	---
11ac80SISO	5530	Type5	10	0	209249.0	16	2	73.7	1208.0	1497.0	---
11ac80SISO	5530	Type5	10	1	378386.0	16	3	97.4	1942.0	1754.0	1613.0
11ac80SISO	5530	Type5	10	2	548411.0	16	3	91.7	1999.0	1702.0	1462.0
11ac80SISO	5530	Type5	10	3	17733.0	16	1	66.2	1393.0	---	---
11ac80SISO	5530	Type5	10	4	187952.0	16	2	70.8	1968.0	1821.0	---
11ac80SISO	5530	Type5	10	5	359277.0	16	1	52.3	1740.0	---	---
11ac80SISO	5530	Type5	10	6	528886.0	16	2	78.9	1308.0	1984.0	---
11ac80SISO	5530	Type5	10	7	700166.0	16	2	70.9	1050.0	1358.0	---
11ac80SISO	5530	Type5	10	8	167197.0	16	2	75.6	1437.0	1430.0	---
11ac80SISO	5530	Type5	10	9	338262.0	16	1	59.1	1697.0	---	---
11ac80SISO	5530	Type5	10	10	508324.0	16	2	77.0	1397.0	1304.0	---
11ac80SISO	5530	Type5	10	11	678689.0	16	2	67.9	1803.0	1083.0	---
11ac80SISO	5530	Type5	10	12	146031.0	16	2	81.2	1720.0	1932.0	---
11ac80SISO	5530	Type5	10	13	316923.0	16	2	78.7	1247.0	1121.0	---
11ac80SISO	5530	Type5	10	14	488056.0	16	1	63.3	1634.0	---	---
11ac80SISO	5530	Type5	10	15	657326.0	16	2	68.9	1849.0	1423.0	---
11ac80SISO	5530	Type5	10	16	125509.0	16	1	59.3	1093.0	---	---



Unless otherwise agreed in writing, this document is issued by the Company subject to its General Conditions of Service printed overleaf, available on request or accessible at <http://www.sgs.com/en/Terms-and-Conditions.aspx> and, for electronic format documents, subject to Terms and Conditions for Electronic Documents at <http://www.sgs.com/en/Terms-and-Conditions/Terms-e-Documents.aspx>. Attention is drawn to the limitation of liability, indemnification and jurisdiction issues defined therein. Any holder of this document is advised that information contained hereon reflects the Company's findings at the time of its intervention only and within the limits of Client's instructions, if any. The Company's sole responsibility is to its Client and this document does not exonerate parties to a transaction from exercising all their rights and obligations under the transaction documents. This document cannot be reproduced except in full, without prior written approval of the Company. Any unauthorized alteration, forgery or falsification of the content or appearance of this document is unlawful and offenders may be prosecuted to the fullest extent of the law. Unless otherwise stated the results shown in this test report refer only to the sample(s) tested and such sample(s) are retained for 30 days only.

Attention: To check the authenticity of testing/inspection report & certificate, please contact us at telephone: (86-755) 83071443, or email: CN.Doccheck@sgs.com

South of No. 6 Plant, No. 1, Runsheng Road, Suzhou Industrial Park, Suzhou Area, China (Jiangsu) Pilot Free Trade Zone 215000 t (86-512) 62992980 www.sgs.com.cn
 中国·苏州·中国(江苏)自由贸易试验区苏州片区苏州工业园区润胜路1号的6号厂房南楼 邮编: 215000 t (86-512) 62992980 sgs.china@sgs.com

@FCC_RLAN_DFS_SPC_Radar_T5_SP2_Tr11@											
TestMode	Channel	Radar Type	Trial ID	Burst ID	Burst Offset (μs)	Chirp Width (MHz)	Number Of Pulses	Pulse Width (μs)	PRI1 (μs)	PRI2 (μs)	PRI3 (μs)
11ac20SISO	5500	Type5	11	0	263736.0	19	3	98.9	1381.0	1680.0	1488.0
11ac20SISO	5500	Type5	11	1	416459.0	19	2	82.3	1716.0	1855.0	---
11ac20SISO	5500	Type5	11	2	567902.0	19	3	86.7	1211.0	1400.0	1919.0
11ac20SISO	5500	Type5	11	3	92979.0	19	3	89.7	1861.0	1068.0	1282.0
11ac20SISO	5500	Type5	11	4	245155.0	19	3	98.6	1507.0	1194.0	1461.0
11ac20SISO	5500	Type5	11	5	397609.0	19	2	71.1	1921.0	1789.0	---
11ac20SISO	5500	Type5	11	6	551431.0	19	1	55.9	1947.0	---	---
11ac20SISO	5500	Type5	11	7	74413.0	19	2	67.9	1350.0	1372.0	---
11ac20SISO	5500	Type5	11	8	226559.0	19	3	84.4	1203.0	1107.0	1443.0
11ac20SISO	5500	Type5	11	9	380056.0	19	1	58.8	1715.0	---	---
11ac20SISO	5500	Type5	11	10	533408.0	19	1	65.6	1017.0	---	---
11ac20SISO	5500	Type5	11	11	55547.0	19	2	78.5	1911.0	1704.0	---
11ac20SISO	5500	Type5	11	12	207876.0	19	2	82.3	1845.0	1686.0	---
11ac20SISO	5500	Type5	11	13	359771.0	19	3	90.1	1938.0	1071.0	1266.0
11ac20SISO	5500	Type5	11	14	511297.0	19	3	90.2	1989.0	1089.0	1950.0
11ac20SISO	5500	Type5	11	15	36803.0	19	2	83.1	1943.0	1406.0	---
11ac20SISO	5500	Type5	11	16	189652.0	19	1	58.8	1742.0	---	---
11ac20SISO	5500	Type5	11	17	341809.0	19	2	77.0	1187.0	1657.0	---
11ac20SISO	5500	Type5	11	18	495737.0	19	1	55.0	1012.0	---	---
11ac40SISO	5510	Type5	11	0	263736.0	19	3	98.9	1381.0	1680.0	1488.0
11ac40SISO	5510	Type5	11	1	416459.0	19	2	82.3	1716.0	1855.0	---
11ac40SISO	5510	Type5	11	2	567902.0	19	3	86.7	1211.0	1400.0	1919.0
11ac40SISO	5510	Type5	11	3	92979.0	19	3	89.7	1861.0	1068.0	1282.0
11ac40SISO	5510	Type5	11	4	245155.0	19	3	98.6	1507.0	1194.0	1461.0
11ac40SISO	5510	Type5	11	5	397609.0	19	2	71.1	1921.0	1789.0	---
11ac40SISO	5510	Type5	11	6	551431.0	19	1	55.9	1947.0	---	---
11ac40SISO	5510	Type5	11	7	74413.0	19	2	67.9	1350.0	1372.0	---
11ac40SISO	5510	Type5	11	8	226559.0	19	3	84.4	1203.0	1107.0	1443.0
11ac40SISO	5510	Type5	11	9	380056.0	19	1	58.8	1715.0	---	---
11ac40SISO	5510	Type5	11	10	533408.0	19	1	65.6	1017.0	---	---
11ac40SISO	5510	Type5	11	11	55547.0	19	2	78.5	1911.0	1704.0	---
11ac40SISO	5510	Type5	11	12	207876.0	19	2	82.3	1845.0	1686.0	---
11ac40SISO	5510	Type5	11	13	359771.0	19	3	90.1	1938.0	1071.0	1266.0
11ac40SISO	5510	Type5	11	14	511297.0	19	3	90.2	1989.0	1089.0	1950.0
11ac40SISO	5510	Type5	11	15	36803.0	19	2	83.1	1943.0	1406.0	---
11ac40SISO	5510	Type5	11	16	189652.0	19	1	58.8	1742.0	---	---
11ac40SISO	5510	Type5	11	17	341809.0	19	2	77.0	1187.0	1657.0	---
11ac40SISO	5510	Type5	11	18	495737.0	19	1	55.0	1012.0	---	---
11ac80SISO	5530	Type5	11	0	263736.0	19	3	98.9	1381.0	1680.0	1488.0
11ac80SISO	5530	Type5	11	1	416459.0	19	2	82.3	1716.0	1855.0	---
11ac80SISO	5530	Type5	11	2	567902.0	19	3	86.7	1211.0	1400.0	1919.0
11ac80SISO	5530	Type5	11	3	92979.0	19	3	89.7	1861.0	1068.0	1282.0
11ac80SISO	5530	Type5	11	4	245155.0	19	3	98.6	1507.0	1194.0	1461.0
11ac80SISO	5530	Type5	11	5	397609.0	19	2	71.1	1921.0	1789.0	---
11ac80SISO	5530	Type5	11	6	551431.0	19	1	55.9	1947.0	---	---
11ac80SISO	5530	Type5	11	7	74413.0	19	2	67.9	1350.0	1372.0	---
11ac80SISO	5530	Type5	11	8	226559.0	19	3	84.4	1203.0	1107.0	1443.0
11ac80SISO	5530	Type5	11	9	380056.0	19	1	58.8	1715.0	---	---
11ac80SISO	5530	Type5	11	10	533408.0	19	1	65.6	1017.0	---	---
11ac80SISO	5530	Type5	11	11	55547.0	19	2	78.5	1911.0	1704.0	---
11ac80SISO	5530	Type5	11	12	207876.0	19	2	82.3	1845.0	1686.0	---
11ac80SISO	5530	Type5	11	13	359771.0	19	3	90.1	1938.0	1071.0	1266.0
11ac80SISO	5530	Type5	11	14	511297.0	19	3	90.2	1989.0	1089.0	1950.0
11ac80SISO	5530	Type5	11	15	36803.0	19	2	83.1	1943.0	1406.0	---
11ac80SISO	5530	Type5	11	16	189652.0	19	1	58.8	1742.0	---	---
11ac80SISO	5530	Type5	11	17	341809.0	19	2	77.0	1187.0	1657.0	---
11ac80SISO	5530	Type5	11	18	495737.0	19	1	55.0	1012.0	---	---



Unless otherwise agreed in writing, this document is issued by the Company subject to its General Conditions of Service printed overleaf, available on request or accessible at <http://www.sgs.com/en/Terms-and-Conditions.aspx> and, for electronic format documents, subject to Terms and Conditions for Electronic Documents at <http://www.sgs.com/en/Terms-and-Conditions/Terms-e-Documents.aspx>. Attention is drawn to the limitation of liability, indemnification and jurisdiction issues defined therein. Any holder of this document is advised that information contained hereon reflects the Company's findings at the time of its intervention only and within the limits of Client's instructions, if any. The Company's sole responsibility is to its Client and this document does not exonerate parties to a transaction from exercising all their rights and obligations under the transaction documents. This document cannot be reproduced except in full, without prior written approval of the Company. Any unauthorized alteration, forgery or falsification of the content or appearance of this document is unlawful and offenders may be prosecuted to the fullest extent of the law. Unless otherwise stated the results shown in this test report refer only to the sample(s) tested and such sample(s) are retained for 30 days only.

Attention: To check the authenticity of testing/inspection report & certificate, please contact us at telephone: (86-755) 83071443, or email: CN.Doccheck@sgs.com

South of No. 6 Plant, No. 1, Runsheng Road, Suzhou Industrial Park, Suzhou Area, China (Jiangsu) Pilot Free Trade Zone 215000 t (86-512) 62992980 www.sgs.com.cn
 中国·苏州·中国(江苏)自由贸易试验区苏州片区工业园区润胜路1号的6号厂房南部 邮编: 215000 t (86-512) 62992980 sgs.china@sgs.com

@FCC_RLAN_DFS_SPC_Radar_T5_SP2_Tr12@											
TestMode	Channel	Radar Type	Trial ID	Burst ID	Burst Offset (μs)	Chirp Width (MHz)	Number Of Pulses	Pulse Width (μs)	PRI1 (μs)	PRI2 (μs)	PRI3 (μs)
11ac20SISO	5500	Type5	12	0	22911.0	13	1	58.1	1929.0	---	---
11ac20SISO	5500	Type5	12	1	216473.0	13	1	52.1	1910.0	---	---
11ac20SISO	5500	Type5	12	2	410004.0	13	1	59.9	1971.0	---	---
11ac20SISO	5500	Type5	12	3	603671.0	13	1	60.2	1812.0	---	---
11ac20SISO	5500	Type5	12	4	794160.0	13	3	95.9	1399.0	1906.0	1608.0
11ac20SISO	5500	Type5	12	5	192251.0	13	2	79.9	1626.0	1859.0	---
11ac20SISO	5500	Type5	12	6	385590.0	13	2	78.5	1238.0	1917.0	---
11ac20SISO	5500	Type5	12	7	579862.0	13	1	53.8	1763.0	---	---
11ac20SISO	5500	Type5	12	8	773423.0	13	1	64.7	1800.0	---	---
11ac20SISO	5500	Type5	12	9	168898.0	13	1	61.4	1390.0	---	---
11ac20SISO	5500	Type5	12	10	361606.0	13	2	83.2	1692.0	1858.0	---
11ac20SISO	5500	Type5	12	11	553866.0	13	3	84.7	1533.0	1677.0	1638.0
11ac20SISO	5500	Type5	12	12	747241.0	13	3	88.7	1703.0	1528.0	1058.0
11ac20SISO	5500	Type5	12	13	144710.0	13	2	78.3	1258.0	1951.0	---
11ac20SISO	5500	Type5	12	14	337856.0	13	2	69.3	1731.0	1717.0	---
11ac40SISO	5510	Type5	12	0	22911.0	13	1	58.1	1929.0	---	---
11ac40SISO	5510	Type5	12	1	216473.0	13	1	52.1	1910.0	---	---
11ac40SISO	5510	Type5	12	2	410004.0	13	1	59.9	1971.0	---	---
11ac40SISO	5510	Type5	12	3	603671.0	13	1	60.2	1812.0	---	---
11ac40SISO	5510	Type5	12	4	794160.0	13	3	95.9	1399.0	1906.0	1608.0
11ac40SISO	5510	Type5	12	5	192251.0	13	2	79.9	1626.0	1859.0	---
11ac40SISO	5510	Type5	12	6	385590.0	13	2	78.5	1238.0	1917.0	---
11ac40SISO	5510	Type5	12	7	579862.0	13	1	53.8	1763.0	---	---
11ac40SISO	5510	Type5	12	8	773423.0	13	1	64.7	1800.0	---	---
11ac40SISO	5510	Type5	12	9	168898.0	13	1	61.4	1390.0	---	---
11ac40SISO	5510	Type5	12	10	361606.0	13	2	83.2	1692.0	1858.0	---
11ac40SISO	5510	Type5	12	11	553866.0	13	3	84.7	1533.0	1677.0	1638.0
11ac40SISO	5510	Type5	12	12	747241.0	13	3	88.7	1703.0	1528.0	1058.0
11ac40SISO	5510	Type5	12	13	144710.0	13	2	78.3	1258.0	1951.0	---
11ac40SISO	5510	Type5	12	14	337856.0	13	2	69.3	1731.0	1717.0	---
11ac80SISO	5530	Type5	12	0	22911.0	13	1	58.1	1929.0	---	---
11ac80SISO	5530	Type5	12	1	216473.0	13	1	52.1	1910.0	---	---
11ac80SISO	5530	Type5	12	2	410004.0	13	1	59.9	1971.0	---	---
11ac80SISO	5530	Type5	12	3	603671.0	13	1	60.2	1812.0	---	---
11ac80SISO	5530	Type5	12	4	794160.0	13	3	95.9	1399.0	1906.0	1608.0
11ac80SISO	5530	Type5	12	5	192251.0	13	2	79.9	1626.0	1859.0	---
11ac80SISO	5530	Type5	12	6	385590.0	13	2	78.5	1238.0	1917.0	---
11ac80SISO	5530	Type5	12	7	579862.0	13	1	53.8	1763.0	---	---
11ac80SISO	5530	Type5	12	8	773423.0	13	1	64.7	1800.0	---	---
11ac80SISO	5530	Type5	12	9	168898.0	13	1	61.4	1390.0	---	---
11ac80SISO	5530	Type5	12	10	361606.0	13	2	83.2	1692.0	1858.0	---
11ac80SISO	5530	Type5	12	11	553866.0	13	3	84.7	1533.0	1677.0	1638.0
11ac80SISO	5530	Type5	12	12	747241.0	13	3	88.7	1703.0	1528.0	1058.0
11ac80SISO	5530	Type5	12	13	144710.0	13	2	78.3	1258.0	1951.0	---
11ac80SISO	5530	Type5	12	14	337856.0	13	2	69.3	1731.0	1717.0	---



Unless otherwise agreed in writing, this document is issued by the Company subject to its General Conditions of Service printed overleaf, available on request or accessible at <http://www.sgs.com/en/Terms-and-Conditions.aspx> and, for electronic format documents, subject to Terms and Conditions for Electronic Documents at <http://www.sgs.com/en/Terms-and-Conditions/Terms-e-Documents.aspx>. Attention is drawn to the limitation of liability, indemnification and jurisdiction issues defined therein. Any holder of this document is advised that information contained hereon reflects the Company's findings at the time of its intervention only and within the limits of Client's instructions, if any. The Company's sole responsibility is to its Client and this document does not exonerate parties to a transaction from exercising all their rights and obligations under the transaction documents. This document cannot be reproduced except in full, without prior written approval of the Company. Any unauthorized alteration, forgery or falsification of the content or appearance of this document is unlawful and offenders may be prosecuted to the fullest extent of the law. Unless otherwise stated the results shown in this test report refer only to the sample(s) tested and such sample(s) are retained for 30 days only.

Attention: To check the authenticity of testing/inspection report & certificate, please contact us at telephone: (86-755) 8307 1443, or email: CN.Doccheck@sgs.com

South of No. 6 Plant, No. 1, Runsheng Road, Suzhou Industrial Park, Suzhou Area, China (Jiangsu) Pilot Free Trade Zone 215000 t (86-512) 62992980 www.sgs.com.cn
 中国·苏州·中国(江苏)自由贸易试验区苏州片区苏州工业园区润胜路1号的6号厂房南楼 邮编: 215000 t (86-512) 62992980 sgs.china@sgs.com

@FCC_RLAN_DFS_SPC_Radar_T5_SP2_Tr13@											
TestMode	Channel	Radar Type	Trial ID	Burst ID	Burst Offset (μs)	Chirp Width (MHz)	Number Of Pulses	Pulse Width (μs)	PRI1 (μs)	PRI2 (μs)	PRI3 (μs)
11ac20SISO	5500	Type5	13	0	664275.0	10	2	75.3	1994.0	1612.0	---
11ac20SISO	5500	Type5	13	1	907886.0	10	1	56.3	1456.0	---	---
11ac20SISO	5500	Type5	13	2	151316.0	10	2	67.7	1617.0	1185.0	---
11ac20SISO	5500	Type5	13	3	393746.0	10	1	55.6	1337.0	---	---
11ac20SISO	5500	Type5	13	4	635093.0	10	2	75.2	1421.0	1267.0	---
11ac20SISO	5500	Type5	13	5	876993.0	10	2	76.3	1359.0	1305.0	---
11ac20SISO	5500	Type5	13	6	121278.0	10	3	85.7	1547.0	1362.0	1924.0
11ac20SISO	5500	Type5	13	7	362696.0	10	3	98.4	1873.0	1550.0	1249.0
11ac20SISO	5500	Type5	13	8	604342.0	10	3	86.4	1779.0	1439.0	1046.0
11ac20SISO	5500	Type5	13	9	846453.0	10	3	93.6	1059.0	1031.0	1452.0
11ac20SISO	5500	Type5	13	10	91871.0	10	1	63.3	1328.0	---	---
11ac20SISO	5500	Type5	13	11	333050.0	10	3	92.4	1412.0	1673.0	1322.0
11ac40SISO	5510	Type5	13	0	664275.0	10	2	75.3	1994.0	1612.0	---
11ac40SISO	5510	Type5	13	1	907886.0	10	1	56.3	1456.0	---	---
11ac40SISO	5510	Type5	13	2	151316.0	10	2	67.7	1617.0	1185.0	---
11ac40SISO	5510	Type5	13	3	393746.0	10	1	55.6	1337.0	---	---
11ac40SISO	5510	Type5	13	4	635093.0	10	2	75.2	1421.0	1267.0	---
11ac40SISO	5510	Type5	13	5	876993.0	10	2	76.3	1359.0	1305.0	---
11ac40SISO	5510	Type5	13	6	121278.0	10	3	85.7	1547.0	1362.0	1924.0
11ac40SISO	5510	Type5	13	7	362696.0	10	3	98.4	1873.0	1550.0	1249.0
11ac40SISO	5510	Type5	13	8	604342.0	10	3	86.4	1779.0	1439.0	1046.0
11ac40SISO	5510	Type5	13	9	846453.0	10	3	93.6	1059.0	1031.0	1452.0
11ac40SISO	5510	Type5	13	10	91871.0	10	1	63.3	1328.0	---	---
11ac40SISO	5510	Type5	13	11	333050.0	10	3	92.4	1412.0	1673.0	1322.0
11ac80SISO	5530	Type5	13	0	664275.0	10	2	75.3	1994.0	1612.0	---
11ac80SISO	5530	Type5	13	1	907886.0	10	1	56.3	1456.0	---	---
11ac80SISO	5530	Type5	13	2	151316.0	10	2	67.7	1617.0	1185.0	---
11ac80SISO	5530	Type5	13	3	393746.0	10	1	55.6	1337.0	---	---
11ac80SISO	5530	Type5	13	4	635093.0	10	2	75.2	1421.0	1267.0	---
11ac80SISO	5530	Type5	13	5	876993.0	10	2	76.3	1359.0	1305.0	---
11ac80SISO	5530	Type5	13	6	121278.0	10	3	85.7	1547.0	1362.0	1924.0
11ac80SISO	5530	Type5	13	7	362696.0	10	3	98.4	1873.0	1550.0	1249.0
11ac80SISO	5530	Type5	13	8	604342.0	10	3	86.4	1779.0	1439.0	1046.0
11ac80SISO	5530	Type5	13	9	846453.0	10	3	93.6	1059.0	1031.0	1452.0
11ac80SISO	5530	Type5	13	10	91871.0	10	1	63.3	1328.0	---	---
11ac80SISO	5530	Type5	13	11	333050.0	10	3	92.4	1412.0	1673.0	1322.0



Unless otherwise agreed in writing, this document is issued by the Company subject to its General Conditions of Service printed overleaf, available on request or accessible at <http://www.sgs.com/en/Terms-and-Conditions.aspx> and, for electronic format documents, subject to Terms and Conditions for Electronic Documents at <http://www.sgs.com/en/Terms-and-Conditions/Terms-e-Documents.aspx>. Attention is drawn to the limitation of liability, indemnification and jurisdiction issues defined therein. Any holder of this document is advised that information contained hereon reflects the Company's findings at the time of its intervention only and within the limits of Client's instructions, if any. The Company's sole responsibility is to its Client and this document does not exonerate parties to a transaction from exercising all their rights and obligations under the transaction documents. This document cannot be reproduced except in full, without prior written approval of the Company. Any unauthorized alteration, forgery or falsification of the content or appearance of this document is unlawful and offenders may be prosecuted to the fullest extent of the law. Unless otherwise stated the results shown in this test report refer only to the sample(s) tested and such sample(s) are retained for 30 days only.

Attention: To check the authenticity of testing/inspection report & certificate, please contact us at telephone: (86-755) 8307 1443, or email: CN.Doccheck@sgs.com

South of No. 6 Plant, No. 1, Runsheng Road, Suzhou Industrial Park, Suzhou Area, China (Jiangsu) Pilot Free Trade Zone 215000 t (86-512) 62992980 www.sgs.com.cn
 中国·苏州·中国(江苏)自由贸易试验区苏州片区苏州工业园区润胜路1号的6号厂房南楼 邮编: 215000 t (86-512) 62992980 sgs.china@sgs.com

@FCC_RLAN_DFS_SPC_Radar_T5_SP2_Tr14@											
TestMode	Channel	Radar Type	Trial ID	Burst ID	Burst Offset (μs)	Chirp Width (MHz)	Number Of Pulses	Pulse Width (μs)	PRI1 (μs)	PRI2 (μs)	PRI3 (μs)
11ac20SISO	5500	Type5	14	0	361323.0	18	3	93.3	1983.0	1912.0	1535.0
11ac20SISO	5500	Type5	14	1	515261.0	18	2	69.1	1102.0	1794.0	---
11ac20SISO	5500	Type5	14	2	39025.0	18	3	86.9	1044.0	1152.0	1148.0
11ac20SISO	5500	Type5	14	3	190900.0	18	3	84.9	1894.0	1948.0	1118.0
11ac20SISO	5500	Type5	14	4	343941.0	18	2	72.3	1094.0	1916.0	---
11ac20SISO	5500	Type5	14	5	497624.0	18	1	51.7	1447.0	---	---
11ac20SISO	5500	Type5	14	6	20319.0	18	1	58.3	1429.0	---	---
11ac20SISO	5500	Type5	14	7	172999.0	18	1	60.8	1979.0	---	---
11ac20SISO	5500	Type5	14	8	325872.0	18	1	57.1	1641.0	---	---
11ac20SISO	5500	Type5	14	9	475841.0	18	3	88.9	1886.0	1964.0	1489.0
11ac20SISO	5500	Type5	14	10	1489.0	18	2	72.0	1909.0	1297.0	---
11ac20SISO	5500	Type5	14	11	153647.0	18	3	90.9	1261.0	1566.0	1370.0
11ac20SISO	5500	Type5	14	12	307096.0	18	1	59.8	1552.0	---	---
11ac20SISO	5500	Type5	14	13	458804.0	18	2	70.0	1759.0	1291.0	---
11ac20SISO	5500	Type5	14	14	610798.0	18	2	67.2	1625.0	1881.0	---
11ac20SISO	5500	Type5	14	15	134759.0	18	3	91.2	1382.0	1832.0	1661.0
11ac20SISO	5500	Type5	14	16	288306.0	18	1	56.5	1483.0	---	---
11ac20SISO	5500	Type5	14	17	441296.0	18	1	51.2	1237.0	---	---
11ac20SISO	5500	Type5	14	18	592780.0	18	2	74.1	1471.0	1245.0	---
11ac40SISO	5510	Type5	14	0	361323.0	18	3	93.3	1983.0	1912.0	1535.0
11ac40SISO	5510	Type5	14	1	515261.0	18	2	69.1	1102.0	1794.0	---
11ac40SISO	5510	Type5	14	2	39025.0	18	3	86.9	1044.0	1152.0	1148.0
11ac40SISO	5510	Type5	14	3	190900.0	18	3	84.9	1894.0	1948.0	1118.0
11ac40SISO	5510	Type5	14	4	343941.0	18	2	72.3	1094.0	1916.0	---
11ac40SISO	5510	Type5	14	5	497624.0	18	1	51.7	1447.0	---	---
11ac40SISO	5510	Type5	14	6	20319.0	18	1	58.3	1429.0	---	---
11ac40SISO	5510	Type5	14	7	172999.0	18	1	60.8	1979.0	---	---
11ac40SISO	5510	Type5	14	8	325872.0	18	1	57.1	1641.0	---	---
11ac40SISO	5510	Type5	14	9	475841.0	18	3	88.9	1886.0	1964.0	1489.0
11ac40SISO	5510	Type5	14	10	1489.0	18	2	72.0	1909.0	1297.0	---
11ac40SISO	5510	Type5	14	11	153647.0	18	3	90.9	1261.0	1566.0	1370.0
11ac40SISO	5510	Type5	14	12	307096.0	18	1	59.8	1552.0	---	---
11ac40SISO	5510	Type5	14	13	458804.0	18	2	70.0	1759.0	1291.0	---
11ac40SISO	5510	Type5	14	14	610798.0	18	2	67.2	1625.0	1881.0	---
11ac40SISO	5510	Type5	14	15	134759.0	18	3	91.2	1382.0	1832.0	1661.0
11ac40SISO	5510	Type5	14	16	288306.0	18	1	56.5	1483.0	---	---
11ac40SISO	5510	Type5	14	17	441296.0	18	1	51.2	1237.0	---	---
11ac40SISO	5510	Type5	14	18	592780.0	18	2	74.1	1471.0	1245.0	---
11ac80SISO	5530	Type5	14	0	361323.0	18	3	93.3	1983.0	1912.0	1535.0
11ac80SISO	5530	Type5	14	1	515261.0	18	2	69.1	1102.0	1794.0	---
11ac80SISO	5530	Type5	14	2	39025.0	18	3	86.9	1044.0	1152.0	1148.0
11ac80SISO	5530	Type5	14	3	190900.0	18	3	84.9	1894.0	1948.0	1118.0
11ac80SISO	5530	Type5	14	4	343941.0	18	2	72.3	1094.0	1916.0	---
11ac80SISO	5530	Type5	14	5	497624.0	18	1	51.7	1447.0	---	---
11ac80SISO	5530	Type5	14	6	20319.0	18	1	58.3	1429.0	---	---
11ac80SISO	5530	Type5	14	7	172999.0	18	1	60.8	1979.0	---	---
11ac80SISO	5530	Type5	14	8	325872.0	18	1	57.1	1641.0	---	---
11ac80SISO	5530	Type5	14	9	475841.0	18	3	88.9	1886.0	1964.0	1489.0
11ac80SISO	5530	Type5	14	10	1489.0	18	2	72.0	1909.0	1297.0	---
11ac80SISO	5530	Type5	14	11	153647.0	18	3	90.9	1261.0	1566.0	1370.0
11ac80SISO	5530	Type5	14	12	307096.0	18	1	59.8	1552.0	---	---
11ac80SISO	5530	Type5	14	13	458804.0	18	2	70.0	1759.0	1291.0	---
11ac80SISO	5530	Type5	14	14	610798.0	18	2	67.2	1625.0	1881.0	---
11ac80SISO	5530	Type5	14	15	134759.0	18	3	91.2	1382.0	1832.0	1661.0
11ac80SISO	5530	Type5	14	16	288306.0	18	1	56.5	1483.0	---	---
11ac80SISO	5530	Type5	14	17	441296.0	18	1	51.2	1237.0	---	---
11ac80SISO	5530	Type5	14	18	592780.0	18	2	74.1	1471.0	1245.0	---



Unless otherwise agreed in writing, this document is issued by the Company subject to its General Conditions of Service printed overleaf, available on request or accessible at <http://www.sgs.com/en/Terms-and-Conditions.aspx> and, for electronic format documents, subject to Terms and Conditions for Electronic Documents at <http://www.sgs.com/en/Terms-and-Conditions/Terms-e-Documents.aspx>. Attention is drawn to the limitation of liability, indemnification and jurisdiction issues defined therein. Any holder of this document is advised that information contained hereon reflects the Company's findings at the time of its intervention only and within the limits of Client's instructions, if any. The Company's sole responsibility is to its Client and this document does not exonerate parties to a transaction from exercising all their rights and obligations under the transaction documents. This document cannot be reproduced except in full, without prior written approval of the Company. Any unauthorized alteration, forgery or falsification of the content or appearance of this document is unlawful and offenders may be prosecuted to the fullest extent of the law. Unless otherwise stated the results shown in this test report refer only to the sample(s) tested and such sample(s) are retained for 30 days only.

Attention: To check the authenticity of testing/inspection report & certificate, please contact us at telephone: (86-755) 83071443, or email: CN.Doccheck@sgs.com

South of No. 6 Plant, No. 1, Runsheng Road, Suzhou Industrial Park, Suzhou Area, China (Jiangsu) Pilot Free Trade Zone 215000 t (86-512) 62992980 www.sgs.com.cn
 中国·苏州·中国(江苏)自由贸易试验区苏州片区工业园区润胜路1号的6号厂房南部 邮编: 215000 t (86-512) 62992980 sgs.china@sgs.com

@FCC_RLAN_DFS_SPC_Radar_T5_SP2_Tr15@											
TestMode	Channel	Radar Type	Trial ID	Burst ID	Burst Offset (μs)	Chirp Width (MHz)	Number Of Pulses	Pulse Width (μs)	PRI1 (μs)	PRI2 (μs)	PRI3 (μs)
11ac20SISO	5500	Type5	15	0	158286.0	12	2	76.9	1110.0	1140.0	---
11ac20SISO	5500	Type5	15	1	366024.0	12	1	50.2	1316.0	---	---
11ac20SISO	5500	Type5	15	2	573452.0	12	1	62.9	1520.0	---	---
11ac20SISO	5500	Type5	15	3	780619.0	12	1	64.7	1902.0	---	---
11ac20SISO	5500	Type5	15	4	132455.0	12	3	83.8	1410.0	1097.0	1621.0
11ac20SISO	5500	Type5	15	5	340207.0	12	1	65.4	1944.0	---	---
11ac20SISO	5500	Type5	15	6	548208.0	12	1	53.2	1024.0	---	---
11ac20SISO	5500	Type5	15	7	755333.0	12	1	51.7	1603.0	---	---
11ac20SISO	5500	Type5	15	8	107117.0	12	2	78.7	1804.0	1168.0	---
11ac20SISO	5500	Type5	15	9	314500.0	12	2	72.4	1030.0	1343.0	---
11ac20SISO	5500	Type5	15	10	522447.0	12	1	53.8	1327.0	---	---
11ac20SISO	5500	Type5	15	11	728517.0	12	2	73.6	1524.0	1553.0	---
11ac20SISO	5500	Type5	15	12	81611.0	12	2	66.7	1722.0	1122.0	---
11ac20SISO	5500	Type5	15	13	288948.0	12	2	82.5	1404.0	1019.0	---
11ac40SISO	5510	Type5	15	0	158286.0	12	2	76.9	1110.0	1140.0	---
11ac40SISO	5510	Type5	15	1	366024.0	12	1	50.2	1316.0	---	---
11ac40SISO	5510	Type5	15	2	573452.0	12	1	62.9	1520.0	---	---
11ac40SISO	5510	Type5	15	3	780619.0	12	1	64.7	1902.0	---	---
11ac40SISO	5510	Type5	15	4	132455.0	12	3	83.8	1410.0	1097.0	1621.0
11ac40SISO	5510	Type5	15	5	340207.0	12	1	65.4	1944.0	---	---
11ac40SISO	5510	Type5	15	6	548208.0	12	1	53.2	1024.0	---	---
11ac40SISO	5510	Type5	15	7	755333.0	12	1	51.7	1603.0	---	---
11ac40SISO	5510	Type5	15	8	107117.0	12	2	78.7	1804.0	1168.0	---
11ac40SISO	5510	Type5	15	9	314500.0	12	2	72.4	1030.0	1343.0	---
11ac40SISO	5510	Type5	15	10	522447.0	12	1	53.8	1327.0	---	---
11ac40SISO	5510	Type5	15	11	728517.0	12	2	73.6	1524.0	1553.0	---
11ac40SISO	5510	Type5	15	12	81611.0	12	2	66.7	1722.0	1122.0	---
11ac40SISO	5510	Type5	15	13	288948.0	12	2	82.5	1404.0	1019.0	---
11ac80SISO	5530	Type5	15	0	158286.0	12	2	76.9	1110.0	1140.0	---
11ac80SISO	5530	Type5	15	1	366024.0	12	1	50.2	1316.0	---	---
11ac80SISO	5530	Type5	15	2	573452.0	12	1	62.9	1520.0	---	---
11ac80SISO	5530	Type5	15	3	780619.0	12	1	64.7	1902.0	---	---
11ac80SISO	5530	Type5	15	4	132455.0	12	3	83.8	1410.0	1097.0	1621.0
11ac80SISO	5530	Type5	15	5	340207.0	12	1	65.4	1944.0	---	---
11ac80SISO	5530	Type5	15	6	548208.0	12	1	53.2	1024.0	---	---
11ac80SISO	5530	Type5	15	7	755333.0	12	1	51.7	1603.0	---	---
11ac80SISO	5530	Type5	15	8	107117.0	12	2	78.7	1804.0	1168.0	---
11ac80SISO	5530	Type5	15	9	314500.0	12	2	72.4	1030.0	1343.0	---
11ac80SISO	5530	Type5	15	10	522447.0	12	1	53.8	1327.0	---	---
11ac80SISO	5530	Type5	15	11	728517.0	12	2	73.6	1524.0	1553.0	---
11ac80SISO	5530	Type5	15	12	81611.0	12	2	66.7	1722.0	1122.0	---
11ac80SISO	5530	Type5	15	13	288948.0	12	2	82.5	1404.0	1019.0	---



Unless otherwise agreed in writing, this document is issued by the Company subject to its General Conditions of Service printed overleaf, available on request or accessible at <http://www.sgs.com/en/Terms-and-Conditions.aspx> and, for electronic format documents, subject to Terms and Conditions for Electronic Documents at <http://www.sgs.com/en/Terms-and-Conditions/Terms-e-Documents.aspx>. Attention is drawn to the limitation of liability, indemnification and jurisdiction issues defined therein. Any holder of this document is advised that information contained hereon reflects the Company's findings at the time of its intervention only and within the limits of Client's instructions, if any. The Company's sole responsibility is to its Client and this document does not exonerate parties to a transaction from exercising all their rights and obligations under the transaction documents. This document cannot be reproduced except in full, without prior written approval of the Company. Any unauthorized alteration, forgery or falsification of the content or appearance of this document is unlawful and offenders may be prosecuted to the fullest extent of the law. Unless otherwise stated the results shown in this test report refer only to the sample(s) tested and such sample(s) are retained for 30 days only.

Attention: To check the authenticity of testing/inspection report & certificate, please contact us at telephone: (86-755) 83071443, or email: CN.Doccheck@sgs.com

South of No. 6 Plant, No. 1, Runsheng Road, Suzhou Industrial Park, Suzhou Area, China (Jiangsu) Pilot Free Trade Zone 215000 t (86-512) 62992980 www.sgs.com.cn
 中国·苏州·中国(江苏)自由贸易试验区苏州片区苏州工业园区润胜路1号的6号厂房南楼 邮编: 215000 t (86-512) 62992980 sgs.china@sgs.com

@FCC_RLAN_DFS_SPC_Radar_T5_SP2_Tr16@											
TestMode	Channel	Radar Type	Trial ID	Burst ID	Burst Offset (μs)	Chirp Width (MHz)	Number Of Pulses	Pulse Width (μs)	PRI1 (μs)	PRI2 (μs)	PRI3 (μs)
11ac20SISO	5500	Type5	16	0	345766.0	20	3	87.6	1565.0	1055.0	1840.0
11ac20SISO	5500	Type5	16	1	490019.0	20	3	85.2	1735.0	1541.0	1408.0
11ac20SISO	5500	Type5	16	2	39073.0	20	3	84.8	1534.0	1889.0	1463.0
11ac20SISO	5500	Type5	16	3	183923.0	20	2	77.9	1749.0	1460.0	---
11ac20SISO	5500	Type5	16	4	328777.0	20	2	76.5	1518.0	1485.0	---
11ac20SISO	5500	Type5	16	5	474728.0	20	1	60.9	1540.0	---	---
11ac20SISO	5500	Type5	16	6	21394.0	20	2	83.0	1080.0	1010.0	---
11ac20SISO	5500	Type5	16	7	165992.0	20	2	80.4	1824.0	1752.0	---
11ac20SISO	5500	Type5	16	8	310973.0	20	2	67.5	1764.0	1181.0	---
11ac20SISO	5500	Type5	16	9	456884.0	20	1	62.1	1495.0	---	---
11ac20SISO	5500	Type5	16	10	3515.0	20	3	86.4	1773.0	1966.0	1263.0
11ac20SISO	5500	Type5	16	11	147928.0	20	3	84.3	1593.0	1188.0	1788.0
11ac20SISO	5500	Type5	16	12	293225.0	20	2	76.9	1226.0	1537.0	---
11ac20SISO	5500	Type5	16	13	436922.0	20	3	95.8	1192.0	1298.0	1844.0
11ac20SISO	5500	Type5	16	14	584015.0	20	1	55.2	1644.0	---	---
11ac20SISO	5500	Type5	16	15	130832.0	20	1	59.0	1402.0	---	---
11ac20SISO	5500	Type5	16	16	274684.0	20	3	94.5	1296.0	1700.0	1283.0
11ac20SISO	5500	Type5	16	17	418579.0	20	3	91.9	1970.0	1978.0	1165.0
11ac20SISO	5500	Type5	16	18	563464.0	20	3	85.2	1732.0	1551.0	1189.0
11ac20SISO	5500	Type5	16	19	112787.0	20	2	69.5	1038.0	1224.0	---
11ac40SISO	5510	Type5	16	0	345766.0	20	3	87.6	1565.0	1055.0	1840.0
11ac40SISO	5510	Type5	16	1	490019.0	20	3	85.2	1735.0	1541.0	1408.0
11ac40SISO	5510	Type5	16	2	39073.0	20	3	84.8	1534.0	1889.0	1463.0
11ac40SISO	5510	Type5	16	3	183923.0	20	2	77.9	1749.0	1460.0	---
11ac40SISO	5510	Type5	16	4	328777.0	20	2	76.5	1518.0	1485.0	---
11ac40SISO	5510	Type5	16	5	474728.0	20	1	60.9	1540.0	---	---
11ac40SISO	5510	Type5	16	6	21394.0	20	2	83.0	1080.0	1010.0	---
11ac40SISO	5510	Type5	16	7	165992.0	20	2	80.4	1824.0	1752.0	---
11ac40SISO	5510	Type5	16	8	310973.0	20	2	67.5	1764.0	1181.0	---
11ac40SISO	5510	Type5	16	9	456884.0	20	1	62.1	1495.0	---	---
11ac40SISO	5510	Type5	16	10	3515.0	20	3	86.4	1773.0	1966.0	1263.0
11ac40SISO	5510	Type5	16	11	147928.0	20	3	84.3	1593.0	1188.0	1788.0
11ac40SISO	5510	Type5	16	12	293225.0	20	2	76.9	1226.0	1537.0	---
11ac40SISO	5510	Type5	16	13	436922.0	20	3	95.8	1192.0	1298.0	1844.0
11ac40SISO	5510	Type5	16	14	584015.0	20	1	55.2	1644.0	---	---
11ac40SISO	5510	Type5	16	15	130832.0	20	1	59.0	1402.0	---	---
11ac40SISO	5510	Type5	16	16	274684.0	20	3	94.5	1296.0	1700.0	1283.0
11ac40SISO	5510	Type5	16	17	418579.0	20	3	91.9	1970.0	1978.0	1165.0
11ac40SISO	5510	Type5	16	18	563464.0	20	3	85.2	1732.0	1551.0	1189.0
11ac40SISO	5510	Type5	16	19	112787.0	20	2	69.5	1038.0	1224.0	---
11ac80SISO	5530	Type5	16	0	345766.0	20	3	87.6	1565.0	1055.0	1840.0
11ac80SISO	5530	Type5	16	1	490019.0	20	3	85.2	1735.0	1541.0	1408.0
11ac80SISO	5530	Type5	16	2	39073.0	20	3	84.8	1534.0	1889.0	1463.0
11ac80SISO	5530	Type5	16	3	183923.0	20	2	77.9	1749.0	1460.0	---
11ac80SISO	5530	Type5	16	4	328777.0	20	2	76.5	1518.0	1485.0	---
11ac80SISO	5530	Type5	16	5	474728.0	20	1	60.9	1540.0	---	---
11ac80SISO	5530	Type5	16	6	21394.0	20	2	83.0	1080.0	1010.0	---
11ac80SISO	5530	Type5	16	7	165992.0	20	2	80.4	1824.0	1752.0	---
11ac80SISO	5530	Type5	16	8	310973.0	20	2	67.5	1764.0	1181.0	---
11ac80SISO	5530	Type5	16	9	456884.0	20	1	62.1	1495.0	---	---
11ac80SISO	5530	Type5	16	10	3515.0	20	3	86.4	1773.0	1966.0	1263.0
11ac80SISO	5530	Type5	16	11	147928.0	20	3	84.3	1593.0	1188.0	1788.0
11ac80SISO	5530	Type5	16	12	293225.0	20	2	76.9	1226.0	1537.0	---
11ac80SISO	5530	Type5	16	13	436922.0	20	3	95.8	1192.0	1298.0	1844.0
11ac80SISO	5530	Type5	16	14	584015.0	20	1	55.2	1644.0	---	---
11ac80SISO	5530	Type5	16	15	130832.0	20	1	59.0	1402.0	---	---
11ac80SISO	5530	Type5	16	16	274684.0	20	3	94.5	1296.0	1700.0	1283.0



Unless otherwise agreed in writing, this document is issued by the Company subject to its General Conditions of Service printed overleaf, available on request or accessible at <http://www.sgs.com/en/Terms-and-Conditions.aspx> and, for electronic format documents, subject to Terms and Conditions for Electronic Documents at <http://www.sgs.com/en/Terms-and-Conditions/Terms-e-Documents.aspx>. Attention is drawn to the limitation of liability, indemnification and jurisdiction issues defined therein. Any holder of this document is advised that information contained hereon reflects the Company's findings at the time of its intervention only and within the limits of Client's instructions, if any. The Company's sole responsibility is to its Client and this document does not exonerate parties to a transaction from exercising all their rights and obligations under the transaction documents. This document cannot be reproduced except in full, without prior written approval of the Company. Any unauthorized alteration, forgery or falsification of the content or appearance of this document is unlawful and offenders may be prosecuted to the fullest extent of the law. Unless otherwise stated the results shown in this test report refer only to the sample(s) tested and such sample(s) are retained for 30 days only.

Attention: To check the authenticity of testing/inspection report & certificate, please contact us at telephone: (86-755) 83071443, or email: CN.Doccheck@sgs.com

South of No. 6 Plant, No. 1, Runsheng Road, Suzhou Industrial Park, Suzhou Area, China (Jiangsu) Pilot Free Trade Zone 215000 t (86-512) 62992980 www.sgs.com.cn
 中国·苏州·中国(江苏)自由贸易试验区苏州片区工业园区润胜路1号的6号厂房南部 邮编: 215000 t (86-512) 62992980 sgs.china@sgs.com

Report No.: SEWA2209000044RG06

Rev.: 01

Page: 69 of 85

11ac80SISO	5530	Type5	16	17	418579.0	20	3	91.9	1970.0	1978.0	1165.0
11ac80SISO	5530	Type5	16	18	563464.0	20	3	85.2	1732.0	1551.0	1189.0
11ac80SISO	5530	Type5	16	19	112787.0	20	2	69.5	1038.0	1224.0	---



Unless otherwise agreed in writing, this document is issued by the Company subject to its General Conditions of Service printed overleaf, available on request or accessible at <http://www.sgs.com/en/Terms-and-Conditions.aspx> and, for electronic format documents, subject to Terms and Conditions for Electronic Documents at <http://www.sgs.com/en/Terms-and-Conditions/Terms-e-Documents.aspx>. Attention is drawn to the limitation of liability, indemnification and jurisdiction issues defined therein. Any holder of this document is advised that information contained hereon reflects the Company's findings at the time of its intervention only and within the limits of Client's instructions, if any. The Company's sole responsibility is to its Client and this document does not exonerate parties to a transaction from exercising all their rights and obligations under the transaction documents. This document cannot be reproduced except in full, without prior written approval of the Company. Any unauthorized alteration, forgery or falsification of the content or appearance of this document is unlawful and offenders may be prosecuted to the fullest extent of the law. Unless otherwise stated the results shown in this test report refer only to the sample(s) tested and such sample(s) are retained for 30 days only.
Attention: To check the authenticity of testing/inspection report & certificate, please contact us at telephone: (86-755) 8307 1443, or email: CN.Doccheck@sgs.com

South of No. 6 Plant, No. 1, Runsheng Road, Suzhou Industrial Park, Suzhou Area, China (Jiangsu) Pilot Free Trade Zone 215000 t (86-512) 62992980 www.sgsgroup.com.cn
 中国·苏州·中国(江苏)自由贸易试验区苏州片区苏州工业园区润胜路1号的6号厂房南部 邮编: 215000 t (86-512) 62992980 sgs.china@sgs.com

@FCC_RLAN_DFS_SPC_Radar_T5_SP2_Tr17@											
TestMode	Channel	Radar Type	Trial ID	Burst ID	Burst Offset (μs)	Chirp Width (MHz)	Number Of Pulses	Pulse Width (μs)	PRI1 (μs)	PRI2 (μs)	PRI3 (μs)
11ac20SISO	5500	Type5	17	0	429224.0	10	3	86.4	1259.0	1918.0	1455.0
11ac20SISO	5500	Type5	17	1	670241.0	10	3	92.2	1598.0	1719.0	1895.0
11ac20SISO	5500	Type5	17	2	912880.0	10	2	80.4	1816.0	1899.0	---
11ac20SISO	5500	Type5	17	3	158603.0	10	1	54.3	1335.0	---	---
11ac20SISO	5500	Type5	17	4	400824.0	10	1	53.1	1303.0	---	---
11ac20SISO	5500	Type5	17	5	641915.0	10	2	69.4	1503.0	1546.0	---
11ac20SISO	5500	Type5	17	6	883823.0	10	2	69.1	1279.0	1639.0	---
11ac20SISO	5500	Type5	17	7	128373.0	10	3	100.0	1375.0	1438.0	1595.0
11ac20SISO	5500	Type5	17	8	370379.0	10	2	79.6	1239.0	1705.0	---
11ac20SISO	5500	Type5	17	9	611194.0	10	3	88.4	1374.0	1579.0	1623.0
11ac20SISO	5500	Type5	17	10	855665.0	10	1	53.3	1016.0	---	---
11ac20SISO	5500	Type5	17	11	98897.0	10	1	65.3	1709.0	---	---
11ac40SISO	5510	Type5	17	0	429224.0	10	3	86.4	1259.0	1918.0	1455.0
11ac40SISO	5510	Type5	17	1	670241.0	10	3	92.2	1598.0	1719.0	1895.0
11ac40SISO	5510	Type5	17	2	912880.0	10	2	80.4	1816.0	1899.0	---
11ac40SISO	5510	Type5	17	3	158603.0	10	1	54.3	1335.0	---	---
11ac40SISO	5510	Type5	17	4	400824.0	10	1	53.1	1303.0	---	---
11ac40SISO	5510	Type5	17	5	641915.0	10	2	69.4	1503.0	1546.0	---
11ac40SISO	5510	Type5	17	6	883823.0	10	2	69.1	1279.0	1639.0	---
11ac40SISO	5510	Type5	17	7	128373.0	10	3	100.0	1375.0	1438.0	1595.0
11ac40SISO	5510	Type5	17	8	370379.0	10	2	79.6	1239.0	1705.0	---
11ac40SISO	5510	Type5	17	9	611194.0	10	3	88.4	1374.0	1579.0	1623.0
11ac40SISO	5510	Type5	17	10	855665.0	10	1	53.3	1016.0	---	---
11ac40SISO	5510	Type5	17	11	98897.0	10	1	65.3	1709.0	---	---
11ac80SISO	5530	Type5	17	0	429224.0	10	3	86.4	1259.0	1918.0	1455.0
11ac80SISO	5530	Type5	17	1	670241.0	10	3	92.2	1598.0	1719.0	1895.0
11ac80SISO	5530	Type5	17	2	912880.0	10	2	80.4	1816.0	1899.0	---
11ac80SISO	5530	Type5	17	3	158603.0	10	1	54.3	1335.0	---	---
11ac80SISO	5530	Type5	17	4	400824.0	10	1	53.1	1303.0	---	---
11ac80SISO	5530	Type5	17	5	641915.0	10	2	69.4	1503.0	1546.0	---
11ac80SISO	5530	Type5	17	6	883823.0	10	2	69.1	1279.0	1639.0	---
11ac80SISO	5530	Type5	17	7	128373.0	10	3	100.0	1375.0	1438.0	1595.0
11ac80SISO	5530	Type5	17	8	370379.0	10	2	79.6	1239.0	1705.0	---
11ac80SISO	5530	Type5	17	9	611194.0	10	3	88.4	1374.0	1579.0	1623.0
11ac80SISO	5530	Type5	17	10	855665.0	10	1	53.3	1016.0	---	---
11ac80SISO	5530	Type5	17	11	98897.0	10	1	65.3	1709.0	---	---



Unless otherwise agreed in writing, this document is issued by the Company subject to its General Conditions of Service printed overleaf, available on request or accessible at <http://www.sgs.com/en/Terms-and-Conditions.aspx> and, for electronic format documents, subject to Terms and Conditions for Electronic Documents at <http://www.sgs.com/en/Terms-and-Conditions/Terms-e-Documents.aspx>. Attention is drawn to the limitation of liability, indemnification and jurisdiction issues defined therein. Any holder of this document is advised that information contained hereon reflects the Company's findings at the time of its intervention only and within the limits of Client's instructions, if any. The Company's sole responsibility is to its Client and this document does not exonerate parties to a transaction from exercising all their rights and obligations under the transaction documents. This document cannot be reproduced except in full, without prior written approval of the Company. Any unauthorized alteration, forgery or falsification of the content or appearance of this document is unlawful and offenders may be prosecuted to the fullest extent of the law. Unless otherwise stated the results shown in this test report refer only to the sample(s) tested and such sample(s) are retained for 30 days only.

Attention: To check the authenticity of testing/inspection report & certificate, please contact us at telephone: (86-755) 8307 1443, or email: CN.Doccheck@sgs.com

South of No. 6 Plant, No. 1, Runsheng Road, Suzhou Industrial Park, Suzhou Area, China (Jiangsu) Pilot Free Trade Zone 215000 t (86-512) 62992980 www.sgs.com.cn
 中国·苏州·中国(江苏)自由贸易试验区苏州片区苏州工业园区润胜路1号的6号厂房南楼 邮编: 215000 t (86-512) 62992980 sgs.china@sgs.com

@FCC_RLAN_DFS_SPC_Radar_T5_SP2_Tr18@											
TestMode	Channel	Radar Type	Trial ID	Burst ID	Burst Offset (μs)	Chirp Width (MHz)	Number Of Pulses	Pulse Width (μs)	PRI1 (μs)	PRI2 (μs)	PRI3 (μs)
11ac20SISO	5500	Type5	18	0	292143.0	12	1	55.3	1920.0	---	---
11ac20SISO	5500	Type5	18	1	499633.0	12	1	58.3	1797.0	---	---
11ac20SISO	5500	Type5	18	2	706377.0	12	2	72.3	1610.0	1039.0	---
11ac20SISO	5500	Type5	18	3	58989.0	12	3	84.8	1131.0	1761.0	1721.0
11ac20SISO	5500	Type5	18	4	266161.0	12	2	82.5	1875.0	1431.0	---
11ac20SISO	5500	Type5	18	5	474469.0	12	1	63.3	1095.0	---	---
11ac20SISO	5500	Type5	18	6	680544.0	12	2	80.0	1119.0	1913.0	---
11ac20SISO	5500	Type5	18	7	33519.0	12	3	90.3	1660.0	1853.0	1123.0
11ac20SISO	5500	Type5	18	8	240319.0	12	3	91.1	1539.0	1783.0	1172.0
11ac20SISO	5500	Type5	18	9	447400.0	12	3	96.6	1525.0	1036.0	1385.0
11ac20SISO	5500	Type5	18	10	654516.0	12	2	82.7	1710.0	1990.0	---
11ac20SISO	5500	Type5	18	11	8083.0	12	1	50.7	1234.0	---	---
11ac20SISO	5500	Type5	18	12	215435.0	12	2	78.4	1047.0	1109.0	---
11ac20SISO	5500	Type5	18	13	421325.0	12	3	99.5	1299.0	1965.0	1869.0
11ac40SISO	5510	Type5	18	0	292143.0	12	1	55.3	1920.0	---	---
11ac40SISO	5510	Type5	18	1	499633.0	12	1	58.3	1797.0	---	---
11ac40SISO	5510	Type5	18	2	706377.0	12	2	72.3	1610.0	1039.0	---
11ac40SISO	5510	Type5	18	3	58989.0	12	3	84.8	1131.0	1761.0	1721.0
11ac40SISO	5510	Type5	18	4	266161.0	12	2	82.5	1875.0	1431.0	---
11ac40SISO	5510	Type5	18	5	474469.0	12	1	63.3	1095.0	---	---
11ac40SISO	5510	Type5	18	6	680544.0	12	2	80.0	1119.0	1913.0	---
11ac40SISO	5510	Type5	18	7	33519.0	12	3	90.3	1660.0	1853.0	1123.0
11ac40SISO	5510	Type5	18	8	240319.0	12	3	91.1	1539.0	1783.0	1172.0
11ac40SISO	5510	Type5	18	9	447400.0	12	3	96.6	1525.0	1036.0	1385.0
11ac40SISO	5510	Type5	18	10	654516.0	12	2	82.7	1710.0	1990.0	---
11ac40SISO	5510	Type5	18	11	8083.0	12	1	50.7	1234.0	---	---
11ac40SISO	5510	Type5	18	12	215435.0	12	2	78.4	1047.0	1109.0	---
11ac40SISO	5510	Type5	18	13	421325.0	12	3	99.5	1299.0	1965.0	1869.0
11ac80SISO	5530	Type5	18	0	292143.0	12	1	55.3	1920.0	---	---
11ac80SISO	5530	Type5	18	1	499633.0	12	1	58.3	1797.0	---	---
11ac80SISO	5530	Type5	18	2	706377.0	12	2	72.3	1610.0	1039.0	---
11ac80SISO	5530	Type5	18	3	58989.0	12	3	84.8	1131.0	1761.0	1721.0
11ac80SISO	5530	Type5	18	4	266161.0	12	2	82.5	1875.0	1431.0	---
11ac80SISO	5530	Type5	18	5	474469.0	12	1	63.3	1095.0	---	---
11ac80SISO	5530	Type5	18	6	680544.0	12	2	80.0	1119.0	1913.0	---
11ac80SISO	5530	Type5	18	7	33519.0	12	3	90.3	1660.0	1853.0	1123.0
11ac80SISO	5530	Type5	18	8	240319.0	12	3	91.1	1539.0	1783.0	1172.0
11ac80SISO	5530	Type5	18	9	447400.0	12	3	96.6	1525.0	1036.0	1385.0
11ac80SISO	5530	Type5	18	10	654516.0	12	2	82.7	1710.0	1990.0	---
11ac80SISO	5530	Type5	18	11	8083.0	12	1	50.7	1234.0	---	---
11ac80SISO	5530	Type5	18	12	215435.0	12	2	78.4	1047.0	1109.0	---
11ac80SISO	5530	Type5	18	13	421325.0	12	3	99.5	1299.0	1965.0	1869.0



Unless otherwise agreed in writing, this document is issued by the Company subject to its General Conditions of Service printed overleaf, available on request or accessible at <http://www.sgs.com/en/Terms-and-Conditions.aspx> and, for electronic format documents, subject to Terms and Conditions for Electronic Documents at <http://www.sgs.com/en/Terms-and-Conditions/Terms-e-Documents.aspx>. Attention is drawn to the limitation of liability, indemnification and jurisdiction issues defined therein. Any holder of this document is advised that information contained hereon reflects the Company's findings at the time of its intervention only and within the limits of Client's instructions, if any. The Company's sole responsibility is to its Client and this document does not exonerate parties to a transaction from exercising all their rights and obligations under the transaction documents. This document cannot be reproduced except in full, without prior written approval of the Company. Any unauthorized alteration, forgery or falsification of the content or appearance of this document is unlawful and offenders may be prosecuted to the fullest extent of the law. Unless otherwise stated the results shown in this test report refer only to the sample(s) tested and such sample(s) are retained for 30 days only.

Attention: To check the authenticity of testing/inspection report & certificate, please contact us at telephone: (86-755) 8307 1443, or email: CN.Doccheck@sgs.com

South of No. 6 Plant, No. 1, Runsheng Road, Suzhou Industrial Park, Suzhou Area, China (Jiangsu) Pilot Free Trade Zone 215000 t (86-512) 62992980 www.sgs.com.cn
 中国·苏州·中国(江苏)自由贸易试验区苏州片区苏州工业园区润胜路1号的6号厂房南楼 邮编: 215000 t (86-512) 62992980 sgs.china@sgs.com

@FCC_RLAN_DFS_SPC_Radar_T5_SP2_Tr19@											
TestMode	Channel	Radar Type	Trial ID	Burst ID	Burst Offset (μs)	Chirp Width (MHz)	Number Of Pulses	Pulse Width (μs)	PRI1 (μs)	PRI2 (μs)	PRI3 (μs)
11ac20SISO	5500	Type5	19	0	733725.0	10	3	88.6	1501.0	1067.0	1927.0
11ac20SISO	5500	Type5	19	1	977882.0	10	1	57.4	1723.0	---	---
11ac20SISO	5500	Type5	19	2	221197.0	10	3	96.6	1086.0	1658.0	1324.0
11ac20SISO	5500	Type5	19	3	462915.0	10	2	69.7	1751.0	1945.0	---
11ac20SISO	5500	Type5	19	4	705071.0	10	2	77.9	1642.0	1317.0	---
11ac20SISO	5500	Type5	19	5	947923.0	10	1	62.0	1866.0	---	---
11ac20SISO	5500	Type5	19	6	191373.0	10	3	88.4	1997.0	1077.0	1366.0
11ac20SISO	5500	Type5	19	7	432561.0	10	3	97.3	1790.0	1896.0	1367.0
11ac20SISO	5500	Type5	19	8	674004.0	10	3	96.2	1391.0	1787.0	1672.0
11ac20SISO	5500	Type5	19	9	915842.0	10	3	95.4	1020.0	1892.0	1414.0
11ac20SISO	5500	Type5	19	10	162176.0	10	1	54.8	1084.0	---	---
11ac20SISO	5500	Type5	19	11	403553.0	10	2	80.4	1850.0	1436.0	---
11ac40SISO	5510	Type5	19	0	733725.0	10	3	88.6	1501.0	1067.0	1927.0
11ac40SISO	5510	Type5	19	1	977882.0	10	1	57.4	1723.0	---	---
11ac40SISO	5510	Type5	19	2	221197.0	10	3	96.6	1086.0	1658.0	1324.0
11ac40SISO	5510	Type5	19	3	462915.0	10	2	69.7	1751.0	1945.0	---
11ac40SISO	5510	Type5	19	4	705071.0	10	2	77.9	1642.0	1317.0	---
11ac40SISO	5510	Type5	19	5	947923.0	10	1	62.0	1866.0	---	---
11ac40SISO	5510	Type5	19	6	191373.0	10	3	88.4	1997.0	1077.0	1366.0
11ac40SISO	5510	Type5	19	7	432561.0	10	3	97.3	1790.0	1896.0	1367.0
11ac40SISO	5510	Type5	19	8	674004.0	10	3	96.2	1391.0	1787.0	1672.0
11ac40SISO	5510	Type5	19	9	915842.0	10	3	95.4	1020.0	1892.0	1414.0
11ac40SISO	5510	Type5	19	10	162176.0	10	1	54.8	1084.0	---	---
11ac40SISO	5510	Type5	19	11	403553.0	10	2	80.4	1850.0	1436.0	---
11ac80SISO	5530	Type5	19	0	733725.0	10	3	88.6	1501.0	1067.0	1927.0
11ac80SISO	5530	Type5	19	1	977882.0	10	1	57.4	1723.0	---	---
11ac80SISO	5530	Type5	19	2	221197.0	10	3	96.6	1086.0	1658.0	1324.0
11ac80SISO	5530	Type5	19	3	462915.0	10	2	69.7	1751.0	1945.0	---
11ac80SISO	5530	Type5	19	4	705071.0	10	2	77.9	1642.0	1317.0	---
11ac80SISO	5530	Type5	19	5	947923.0	10	1	62.0	1866.0	---	---
11ac80SISO	5530	Type5	19	6	191373.0	10	3	88.4	1997.0	1077.0	1366.0
11ac80SISO	5530	Type5	19	7	432561.0	10	3	97.3	1790.0	1896.0	1367.0
11ac80SISO	5530	Type5	19	8	674004.0	10	3	96.2	1391.0	1787.0	1672.0
11ac80SISO	5530	Type5	19	9	915842.0	10	3	95.4	1020.0	1892.0	1414.0
11ac80SISO	5530	Type5	19	10	162176.0	10	1	54.8	1084.0	---	---
11ac80SISO	5530	Type5	19	11	403553.0	10	2	80.4	1850.0	1436.0	---



Unless otherwise agreed in writing, this document is issued by the Company subject to its General Conditions of Service printed overleaf, available on request or accessible at <http://www.sgs.com/en/Terms-and-Conditions.aspx> and, for electronic format documents, subject to Terms and Conditions for Electronic Documents at <http://www.sgs.com/en/Terms-and-Conditions/Terms-e-Documents.aspx>. Attention is drawn to the limitation of liability, indemnification and jurisdiction issues defined therein. Any holder of this document is advised that information contained hereon reflects the Company's findings at the time of its intervention only and within the limits of Client's instructions, if any. The Company's sole responsibility is to its Client and this document does not exonerate parties to a transaction from exercising all their rights and obligations under the transaction documents. This document cannot be reproduced except in full, without prior written approval of the Company. Any unauthorized alteration, forgery or falsification of the content or appearance of this document is unlawful and offenders may be prosecuted to the fullest extent of the law. Unless otherwise stated the results shown in this test report refer only to the sample(s) tested and such sample(s) are retained for 30 days only.

Attention: To check the authenticity of testing/inspection report & certificate, please contact us at telephone: (86-755) 8307 1443, or email: CN.Doccheck@sgs.com

South of No. 6 Plant, No. 1, Runsheng Road, Suzhou Industrial Park, Suzhou Area, China (Jiangsu) Pilot Free Trade Zone 215000 t (86-512) 62992980 www.sgs.com.cn
 中国·苏州·中国(江苏)自由贸易试验区苏州片区苏州工业园区润胜路1号的6号厂房南楼 邮编: 215000 t (86-512) 62992980 sgs.china@sgs.com

@FCC_RLAN_DFS_SPC_Radar_T5_SP2_Tr20@											
TestMode	Channel	Radar Type	Trial ID	Burst ID	Burst Offset (μs)	Chirp Width (MHz)	Number Of Pulses	Pulse Width (μs)	PRI1 (μs)	PRI2 (μs)	PRI3 (μs)
11ac20SISO	5500	Type5	20	0	483470.0	15	2	74.7	1619.0	1611.0	---
11ac20SISO	5500	Type5	20	1	666072.0	15	1	57.1	1560.0	---	---
11ac20SISO	5500	Type5	20	2	98810.0	15	3	91.9	1392.0	1475.0	1276.0
11ac20SISO	5500	Type5	20	3	279914.0	15	2	83.1	1809.0	1772.0	---
11ac20SISO	5500	Type5	20	4	462536.0	15	1	50.7	1003.0	---	---
11ac20SISO	5500	Type5	20	5	642324.0	15	2	79.2	1574.0	1600.0	---
11ac20SISO	5500	Type5	20	6	76831.0	15	1	58.7	1186.0	---	---
11ac20SISO	5500	Type5	20	7	257785.0	15	2	71.0	1521.0	1567.0	---
11ac20SISO	5500	Type5	20	8	438554.0	15	2	79.0	1777.0	1960.0	---
11ac20SISO	5500	Type5	20	9	620397.0	15	2	68.5	1284.0	1428.0	---
11ac20SISO	5500	Type5	20	10	54310.0	15	2	73.5	1904.0	1352.0	---
11ac20SISO	5500	Type5	20	11	235506.0	15	2	70.5	1864.0	1115.0	---
11ac20SISO	5500	Type5	20	12	417036.0	15	2	76.6	1045.0	1300.0	---
11ac20SISO	5500	Type5	20	13	597974.0	15	2	81.2	1160.0	1675.0	---
11ac20SISO	5500	Type5	20	14	32086.0	15	1	61.8	1277.0	---	---
11ac20SISO	5500	Type5	20	15	212751.0	15	3	94.9	1450.0	1206.0	1860.0
11ac40SISO	5510	Type5	20	0	483470.0	15	2	74.7	1619.0	1611.0	---
11ac40SISO	5510	Type5	20	1	666072.0	15	1	57.1	1560.0	---	---
11ac40SISO	5510	Type5	20	2	98810.0	15	3	91.9	1392.0	1475.0	1276.0
11ac40SISO	5510	Type5	20	3	279914.0	15	2	83.1	1809.0	1772.0	---
11ac40SISO	5510	Type5	20	4	462536.0	15	1	50.7	1003.0	---	---
11ac40SISO	5510	Type5	20	5	642324.0	15	2	79.2	1574.0	1600.0	---
11ac40SISO	5510	Type5	20	6	76831.0	15	1	58.7	1186.0	---	---
11ac40SISO	5510	Type5	20	7	257785.0	15	2	71.0	1521.0	1567.0	---
11ac40SISO	5510	Type5	20	8	438554.0	15	2	79.0	1777.0	1960.0	---
11ac40SISO	5510	Type5	20	9	620397.0	15	2	68.5	1284.0	1428.0	---
11ac40SISO	5510	Type5	20	10	54310.0	15	2	73.5	1904.0	1352.0	---
11ac40SISO	5510	Type5	20	11	235506.0	15	2	70.5	1864.0	1115.0	---
11ac40SISO	5510	Type5	20	12	417036.0	15	2	76.6	1045.0	1300.0	---
11ac40SISO	5510	Type5	20	13	597974.0	15	2	81.2	1160.0	1675.0	---
11ac40SISO	5510	Type5	20	14	32086.0	15	1	61.8	1277.0	---	---
11ac40SISO	5510	Type5	20	15	212751.0	15	3	94.9	1450.0	1206.0	1860.0
11ac80SISO	5530	Type5	20	0	483470.0	15	2	74.7	1619.0	1611.0	---
11ac80SISO	5530	Type5	20	1	666072.0	15	1	57.1	1560.0	---	---
11ac80SISO	5530	Type5	20	2	98810.0	15	3	91.9	1392.0	1475.0	1276.0
11ac80SISO	5530	Type5	20	3	279914.0	15	2	83.1	1809.0	1772.0	---
11ac80SISO	5530	Type5	20	4	462536.0	15	1	50.7	1003.0	---	---
11ac80SISO	5530	Type5	20	5	642324.0	15	2	79.2	1574.0	1600.0	---
11ac80SISO	5530	Type5	20	6	76831.0	15	1	58.7	1186.0	---	---
11ac80SISO	5530	Type5	20	7	257785.0	15	2	71.0	1521.0	1567.0	---
11ac80SISO	5530	Type5	20	8	438554.0	15	2	79.0	1777.0	1960.0	---
11ac80SISO	5530	Type5	20	9	620397.0	15	2	68.5	1284.0	1428.0	---
11ac80SISO	5530	Type5	20	10	54310.0	15	2	73.5	1904.0	1352.0	---
11ac80SISO	5530	Type5	20	11	235506.0	15	2	70.5	1864.0	1115.0	---
11ac80SISO	5530	Type5	20	12	417036.0	15	2	76.6	1045.0	1300.0	---
11ac80SISO	5530	Type5	20	13	597974.0	15	2	81.2	1160.0	1675.0	---
11ac80SISO	5530	Type5	20	14	32086.0	15	1	61.8	1277.0	---	---
11ac80SISO	5530	Type5	20	15	212751.0	15	3	94.9	1450.0	1206.0	1860.0



Unless otherwise agreed in writing, this document is issued by the Company subject to its General Conditions of Service printed overleaf, available on request or accessible at <http://www.sgs.com/en/Terms-and-Conditions.aspx> and, for electronic format documents, subject to Terms and Conditions for Electronic Documents at <http://www.sgs.com/en/Terms-and-Conditions/Terms-e-Documents.aspx>. Attention is drawn to the limitation of liability, indemnification and jurisdiction issues defined therein. Any holder of this document is advised that information contained hereon reflects the Company's findings at the time of its intervention only and within the limits of Client's instructions, if any. The Company's sole responsibility is to its Client and this document does not exonerate parties to a transaction from exercising all their rights and obligations under the transaction documents. This document cannot be reproduced except in full, without prior written approval of the Company. Any unauthorized alteration, forgery or falsification of the content or appearance of this document is unlawful and offenders may be prosecuted to the fullest extent of the law. Unless otherwise stated the results shown in this test report refer only to the sample(s) tested and such sample(s) are retained for 30 days only.

Attention: To check the authenticity of testing/inspection report & certificate, please contact us at telephone: (86-755) 83071443, or email: CN.Doccheck@sgs.com

South of No. 6 Plant, No. 1, Runsheng Road, Suzhou Industrial Park, Suzhou Area, China (Jiangsu) Pilot Free Trade Zone 215000 t (86-512) 62992980 www.sgs.com.cn
 中国·苏州·中国(江苏)自由贸易试验区苏州片区苏州工业园区润胜路1号的6号厂房南楼 邮编: 215000 t (86-512) 62992980 sgs.china@sgs.com

@FCC_RLAN_DFS_SPC_Radar_T5_SP2_Tr21@											
TestMode	Channel	Radar Type	Trial ID	Burst ID	Burst Offset (μs)	Chirp Width (MHz)	Number Of Pulses	Pulse Width (μs)	PRI1 (μs)	PRI2 (μs)	PRI3 (μs)
11ac20SISO	5500	Type5	21	0	526149.0	9	2	78.5	1653.0	1698.0	---
11ac20SISO	5500	Type5	21	1	767135.0	9	3	89.8	1174.0	1962.0	1167.0
11ac20SISO	5500	Type5	21	2	12955.0	9	1	59.4	1982.0	---	---
11ac20SISO	5500	Type5	21	3	254612.0	9	2	79.6	1633.0	1890.0	---
11ac20SISO	5500	Type5	21	4	496588.0	9	2	76.0	1112.0	1811.0	---
11ac20SISO	5500	Type5	21	5	739728.0	9	1	53.6	1144.0	---	---
11ac20SISO	5500	Type5	21	6	980872.0	9	2	80.9	1220.0	1053.0	---
11ac20SISO	5500	Type5	21	7	225249.0	9	1	61.6	1724.0	---	---
11ac20SISO	5500	Type5	21	8	467279.0	9	1	53.4	1901.0	---	---
11ac20SISO	5500	Type5	21	9	709720.0	9	1	59.9	1379.0	---	---
11ac20SISO	5500	Type5	21	10	951847.0	9	1	60.4	1453.0	---	---
11ac20SISO	5500	Type5	21	11	194839.0	9	3	91.4	1768.0	1726.0	1227.0
11ac40SISO	5510	Type5	21	0	526149.0	9	2	78.5	1653.0	1698.0	---
11ac40SISO	5510	Type5	21	1	767135.0	9	3	89.8	1174.0	1962.0	1167.0
11ac40SISO	5510	Type5	21	2	12955.0	9	1	59.4	1982.0	---	---
11ac40SISO	5510	Type5	21	3	254612.0	9	2	79.6	1633.0	1890.0	---
11ac40SISO	5510	Type5	21	4	496588.0	9	2	76.0	1112.0	1811.0	---
11ac40SISO	5510	Type5	21	5	739728.0	9	1	53.6	1144.0	---	---
11ac40SISO	5510	Type5	21	6	980872.0	9	2	80.9	1220.0	1053.0	---
11ac40SISO	5510	Type5	21	7	225249.0	9	1	61.6	1724.0	---	---
11ac40SISO	5510	Type5	21	8	467279.0	9	1	53.4	1901.0	---	---
11ac40SISO	5510	Type5	21	9	709720.0	9	1	59.9	1379.0	---	---
11ac40SISO	5510	Type5	21	10	951847.0	9	1	60.4	1453.0	---	---
11ac40SISO	5510	Type5	21	11	194839.0	9	3	91.4	1768.0	1726.0	1227.0
11ac80SISO	5530	Type5	21	0	526149.0	9	2	78.5	1653.0	1698.0	---
11ac80SISO	5530	Type5	21	1	767135.0	9	3	89.8	1174.0	1962.0	1167.0
11ac80SISO	5530	Type5	21	2	12955.0	9	1	59.4	1982.0	---	---
11ac80SISO	5530	Type5	21	3	254612.0	9	2	79.6	1633.0	1890.0	---
11ac80SISO	5530	Type5	21	4	496588.0	9	2	76.0	1112.0	1811.0	---
11ac80SISO	5530	Type5	21	5	739728.0	9	1	53.6	1144.0	---	---
11ac80SISO	5530	Type5	21	6	980872.0	9	2	80.9	1220.0	1053.0	---
11ac80SISO	5530	Type5	21	7	225249.0	9	1	61.6	1724.0	---	---
11ac80SISO	5530	Type5	21	8	467279.0	9	1	53.4	1901.0	---	---
11ac80SISO	5530	Type5	21	9	709720.0	9	1	59.9	1379.0	---	---
11ac80SISO	5530	Type5	21	10	951847.0	9	1	60.4	1453.0	---	---
11ac80SISO	5530	Type5	21	11	194839.0	9	3	91.4	1768.0	1726.0	1227.0



Unless otherwise agreed in writing, this document is issued by the Company subject to its General Conditions of Service printed overleaf, available on request or accessible at <http://www.sgs.com/en/Terms-and-Conditions.aspx> and, for electronic format documents, subject to Terms and Conditions for Electronic Documents at <http://www.sgs.com/en/Terms-and-Conditions/Terms-e-Documents.aspx>. Attention is drawn to the limitation of liability, indemnification and jurisdiction issues defined therein. Any holder of this document is advised that information contained hereon reflects the Company's findings at the time of its intervention only and within the limits of Client's instructions, if any. The Company's sole responsibility is to its Client and this document does not exonerate parties to a transaction from exercising all their rights and obligations under the transaction documents. This document cannot be reproduced except in full, without prior written approval of the Company. Any unauthorized alteration, forgery or falsification of the content or appearance of this document is unlawful and offenders may be prosecuted to the fullest extent of the law. Unless otherwise stated the results shown in this test report refer only to the sample(s) tested and such sample(s) are retained for 30 days only.

Attention: To check the authenticity of testing/inspection report & certificate, please contact us at telephone: (86-755) 8307 1443, or email: CN.Doccheck@sgs.com

South of No. 6 Plant, No. 1, Runsheng Road, Suzhou Industrial Park, Suzhou Area, China (Jiangsu) Pilot Free Trade Zone 215000 t (86-512) 62992980 www.sgs.com.cn
 中国·苏州·中国(江苏)自由贸易试验区苏州片区苏州工业园区润胜路1号的6号厂房南楼 邮编: 215000 t (86-512) 62992980 sgs.china@sgs.com

@FCC_RLAN_DFS_SPC_Radar_T5_SP2_Tr22@

TestMode	Channel	Radar Type	Trial ID	Burst ID	Burst Offset (μs)	Chirp Width (MHz)	Number Of Pulses	Pulse Width (μs)	PRI1 (μs)	PRI2 (μs)	PRI3 (μs)
11ac20SISO	5500	Type5	22	0	261858.0	20	2	77.0	1191.0	1363.0	---
11ac20SISO	5500	Type5	22	1	407646.0	20	1	58.1	1248.0	---	---
11ac20SISO	5500	Type5	22	2	552319.0	20	1	62.1	1836.0	---	---
11ac20SISO	5500	Type5	22	3	99107.0	20	2	76.9	1334.0	1236.0	---
11ac20SISO	5500	Type5	22	4	243514.0	20	2	80.0	1914.0	1852.0	---
11ac20SISO	5500	Type5	22	5	389464.0	20	1	52.0	1701.0	---	---
11ac20SISO	5500	Type5	22	6	531093.0	20	3	88.6	1693.0	1995.0	1905.0
11ac20SISO	5500	Type5	22	7	81159.0	20	2	72.9	1922.0	1387.0	---
11ac20SISO	5500	Type5	22	8	225245.0	20	3	98.5	1839.0	1746.0	1389.0
11ac20SISO	5500	Type5	22	9	371906.0	20	1	57.9	1193.0	---	---
11ac20SISO	5500	Type5	22	10	514197.0	20	3	95.9	1659.0	1870.0	1066.0
11ac20SISO	5500	Type5	22	11	63561.0	20	1	53.5	1162.0	---	---
11ac20SISO	5500	Type5	22	12	207510.0	20	3	92.0	1745.0	1654.0	1458.0
11ac20SISO	5500	Type5	22	13	353638.0	20	1	57.3	1834.0	---	---
11ac20SISO	5500	Type5	22	14	497515.0	20	2	70.5	1684.0	1586.0	---
11ac20SISO	5500	Type5	22	15	45553.0	20	2	70.0	1042.0	1664.0	---
11ac20SISO	5500	Type5	22	16	189821.0	20	3	84.0	1765.0	1630.0	1176.0
11ac20SISO	5500	Type5	22	17	335330.0	20	2	76.1	1557.0	1057.0	---
11ac20SISO	5500	Type5	22	18	478825.0	20	3	93.2	1985.0	1018.0	1340.0
11ac20SISO	5500	Type5	22	19	27594.0	20	3	96.8	1760.0	1614.0	1817.0
11ac40SISO	5510	Type5	22	0	261858.0	20	2	77.0	1191.0	1363.0	---
11ac40SISO	5510	Type5	22	1	407646.0	20	1	58.1	1248.0	---	---
11ac40SISO	5510	Type5	22	2	552319.0	20	1	62.1	1836.0	---	---
11ac40SISO	5510	Type5	22	3	99107.0	20	2	76.9	1334.0	1236.0	---
11ac40SISO	5510	Type5	22	4	243514.0	20	2	80.0	1914.0	1852.0	---
11ac40SISO	5510	Type5	22	5	389464.0	20	1	52.0	1701.0	---	---
11ac40SISO	5510	Type5	22	6	531093.0	20	3	88.6	1693.0	1995.0	1905.0
11ac40SISO	5510	Type5	22	7	81159.0	20	2	72.9	1922.0	1387.0	---
11ac40SISO	5510	Type5	22	8	225245.0	20	3	98.5	1839.0	1746.0	1389.0
11ac40SISO	5510	Type5	22	9	371906.0	20	1	57.9	1193.0	---	---
11ac40SISO	5510	Type5	22	10	514197.0	20	3	95.9	1659.0	1870.0	1066.0
11ac40SISO	5510	Type5	22	11	63561.0	20	1	53.5	1162.0	---	---
11ac40SISO	5510	Type5	22	12	207510.0	20	3	92.0	1745.0	1654.0	1458.0
11ac40SISO	5510	Type5	22	13	353638.0	20	1	57.3	1834.0	---	---
11ac40SISO	5510	Type5	22	14	497515.0	20	2	70.5	1684.0	1586.0	---
11ac40SISO	5510	Type5	22	15	45553.0	20	2	70.0	1042.0	1664.0	---
11ac40SISO	5510	Type5	22	16	189821.0	20	3	84.0	1765.0	1630.0	1176.0
11ac40SISO	5510	Type5	22	17	335330.0	20	2	76.1	1557.0	1057.0	---
11ac40SISO	5510	Type5	22	18	478825.0	20	3	93.2	1985.0	1018.0	1340.0
11ac40SISO	5510	Type5	22	19	27594.0	20	3	96.8	1760.0	1614.0	1817.0
11ac80SISO	5530	Type5	22	0	261858.0	20	2	77.0	1191.0	1363.0	---
11ac80SISO	5530	Type5	22	1	407646.0	20	1	58.1	1248.0	---	---
11ac80SISO	5530	Type5	22	2	552319.0	20	1	62.1	1836.0	---	---
11ac80SISO	5530	Type5	22	3	99107.0	20	2	76.9	1334.0	1236.0	---
11ac80SISO	5530	Type5	22	4	243514.0	20	2	80.0	1914.0	1852.0	---
11ac80SISO	5530	Type5	22	5	389464.0	20	1	52.0	1701.0	---	---
11ac80SISO	5530	Type5	22	6	531093.0	20	3	88.6	1693.0	1995.0	1905.0
11ac80SISO	5530	Type5	22	7	81159.0	20	2	72.9	1922.0	1387.0	---
11ac80SISO	5530	Type5	22	8	225245.0	20	3	98.5	1839.0	1746.0	1389.0
11ac80SISO	5530	Type5	22	9	371906.0	20	1	57.9	1193.0	---	---
11ac80SISO	5530	Type5	22	10	514197.0	20	3	95.9	1659.0	1870.0	1066.0
11ac80SISO	5530	Type5	22	11	63561.0	20	1	53.5	1162.0	---	---
11ac80SISO	5530	Type5	22	12	207510.0	20	3	92.0	1745.0	1654.0	1458.0
11ac80SISO	5530	Type5	22	13	353638.0	20	1	57.3	1834.0	---	---
11ac80SISO	5530	Type5	22	14	497515.0	20	2	70.5	1684.0	1586.0	---
11ac80SISO	5530	Type5	22	15	45553.0	20	2	70.0	1042.0	1664.0	---
11ac80SISO	5530	Type5	22	16	189821.0	20	3	84.0	1765.0	1630.0	1176.0
11ac80SISO	5530	Type5	22	17	335330.0	20	2	76.1	1557.0	1057.0	---



Unless otherwise agreed in writing, this document is issued by the Company subject to its General Conditions of Service printed overleaf, available on request or accessible at <http://www.sgs.com/en/Terms-and-Conditions.aspx> and, for electronic format documents, subject to Terms and Conditions for Electronic Documents at <http://www.sgs.com/en/Terms-and-Conditions/Terms-e-Documents.aspx>. Attention is drawn to the limitation of liability, indemnification and jurisdiction issues defined therein. Any holder of this document is advised that information contained hereon reflects the Company's findings at the time of its intervention only and within the limits of Client's instructions, if any. The Company's sole responsibility is to its Client and this document does not exonerate parties to a transaction from exercising all their rights and obligations under the transaction documents. This document cannot be reproduced except in full, without prior written approval of the Company. Any unauthorized alteration, forgery or falsification of the content or appearance of this document is unlawful and offenders may be prosecuted to the fullest extent of the law. Unless otherwise stated the results shown in this test report refer only to the sample(s) tested and such sample(s) are retained for 30 days only.

Attention: To check the authenticity of testing/inspection report & certificate, please contact us at telephone: (86-755) 83071443, or email: CN.Doccheck@sgs.com

South of No. 6 Plant, No. 1, Runsheng Road, Suzhou Industrial Park, Suzhou Area, China (Jiangsu) Pilot Free Trade Zone 215000 t (86-512) 62992980 www.sgs.com.cn
 中国·苏州·中国(江苏)自由贸易试验区苏州片区工业园区润胜路1号6号厂房南楼 邮编: 215000 t (86-512) 62992980 sgs.china@sgs.com



Report No.: SEWA2209000044RG06

Rev.: 01

Page: 76 of 85

11ac80SISO	5530	Type5	22	18	478825.0	20	3	93.2	1985.0	1018.0	1340.0
11ac80SISO	5530	Type5	22	19	27594.0	20	3	96.8	1760.0	1614.0	1817.0



Unless otherwise agreed in writing, this document is issued by the Company subject to its General Conditions of Service printed overleaf, available on request or accessible at <http://www.sgs.com/en/Terms-and-Conditions.aspx> and, for electronic format documents, subject to Terms and Conditions for Electronic Documents at <http://www.sgs.com/en/Terms-and-Conditions/Terms-e-Documents.aspx>. Attention is drawn to the limitation of liability, indemnification and jurisdiction issues defined therein. Any holder of this document is advised that information contained hereon reflects the Company's findings at the time of its intervention only and within the limits of Client's instructions, if any. The Company's sole responsibility is to its Client and this document does not exonerate parties to a transaction from exercising all their rights and obligations under the transaction documents. This document cannot be reproduced except in full, without prior written approval of the Company. Any unauthorized alteration, forgery or falsification of the content or appearance of this document is unlawful and offenders may be prosecuted to the fullest extent of the law. Unless otherwise stated the results shown in this test report refer only to the sample(s) tested and such sample(s) are retained for 30 days only.

Attention: To check the authenticity of testing/inspection report & certificate, please contact us at telephone: (86-755) 8307 1443, or email: CN.Doccheck@sgs.com

South of No. 6 Plant, No. 1, Runsheng Road, Suzhou Industrial Park, Suzhou Area, China (Jiangsu) Pilot Free Trade Zone 215000 t (86-512) 62992980 www.sgsgroup.com.cn
 中国·苏州·中国(江苏)自由贸易试验区苏州片区苏州工业园区润胜路1号的6号厂房南部 邮编: 215000 t (86-512) 62992980 sgs.china@sgs.com

@FCC_RLAN_DFS_SPC_Radar_T5_SP2_Tr23@											
TestMode	Channel	Radar Type	Trial ID	Burst ID	Burst Offset (μs)	Chirp Width (MHz)	Number Of Pulses	Pulse Width (μs)	PRI1 (μs)	PRI2 (μs)	PRI3 (μs)
11ac20SISO	5500	Type5	23	0	247117.0	12	1	50.1	1841.0	---	---
11ac20SISO	5500	Type5	23	1	453362.0	12	3	93.5	1590.0	1081.0	1413.0
11ac20SISO	5500	Type5	23	2	660875.0	12	2	68.8	1707.0	1577.0	---
11ac20SISO	5500	Type5	23	3	14140.0	12	1	56.3	1056.0	---	---
11ac20SISO	5500	Type5	23	4	220734.0	12	3	86.0	1953.0	1108.0	1987.0
11ac20SISO	5500	Type5	23	5	428367.0	12	2	75.2	1572.0	1536.0	---
11ac20SISO	5500	Type5	23	6	636681.0	12	1	54.4	1517.0	---	---
11ac20SISO	5500	Type5	23	7	843157.0	12	2	71.1	1329.0	1243.0	---
11ac20SISO	5500	Type5	23	8	195585.0	12	2	76.2	1940.0	1770.0	---
11ac20SISO	5500	Type5	23	9	403231.0	12	2	80.2	1098.0	1209.0	---
11ac20SISO	5500	Type5	23	10	610202.0	12	2	79.7	1588.0	1214.0	---
11ac20SISO	5500	Type5	23	11	815229.0	12	3	90.9	1615.0	1862.0	1601.0
11ac20SISO	5500	Type5	23	12	170267.0	12	2	68.7	1377.0	1441.0	---
11ac20SISO	5500	Type5	23	13	377306.0	12	2	67.4	1872.0	1313.0	---
11ac40SISO	5510	Type5	23	0	247117.0	12	1	50.1	1841.0	---	---
11ac40SISO	5510	Type5	23	1	453362.0	12	3	93.5	1590.0	1081.0	1413.0
11ac40SISO	5510	Type5	23	2	660875.0	12	2	68.8	1707.0	1577.0	---
11ac40SISO	5510	Type5	23	3	14140.0	12	1	56.3	1056.0	---	---
11ac40SISO	5510	Type5	23	4	220734.0	12	3	86.0	1953.0	1108.0	1987.0
11ac40SISO	5510	Type5	23	5	428367.0	12	2	75.2	1572.0	1536.0	---
11ac40SISO	5510	Type5	23	6	636681.0	12	1	54.4	1517.0	---	---
11ac40SISO	5510	Type5	23	7	843157.0	12	2	71.1	1329.0	1243.0	---
11ac40SISO	5510	Type5	23	8	195585.0	12	2	76.2	1940.0	1770.0	---
11ac40SISO	5510	Type5	23	9	403231.0	12	2	80.2	1098.0	1209.0	---
11ac40SISO	5510	Type5	23	10	610202.0	12	2	79.7	1588.0	1214.0	---
11ac40SISO	5510	Type5	23	11	815229.0	12	3	90.9	1615.0	1862.0	1601.0
11ac40SISO	5510	Type5	23	12	170267.0	12	2	68.7	1377.0	1441.0	---
11ac40SISO	5510	Type5	23	13	377306.0	12	2	67.4	1872.0	1313.0	---
11ac80SISO	5530	Type5	23	0	247117.0	12	1	50.1	1841.0	---	---
11ac80SISO	5530	Type5	23	1	453362.0	12	3	93.5	1590.0	1081.0	1413.0
11ac80SISO	5530	Type5	23	2	660875.0	12	2	68.8	1707.0	1577.0	---
11ac80SISO	5530	Type5	23	3	14140.0	12	1	56.3	1056.0	---	---
11ac80SISO	5530	Type5	23	4	220734.0	12	3	86.0	1953.0	1108.0	1987.0
11ac80SISO	5530	Type5	23	5	428367.0	12	2	75.2	1572.0	1536.0	---
11ac80SISO	5530	Type5	23	6	636681.0	12	1	54.4	1517.0	---	---
11ac80SISO	5530	Type5	23	7	843157.0	12	2	71.1	1329.0	1243.0	---
11ac80SISO	5530	Type5	23	8	195585.0	12	2	76.2	1940.0	1770.0	---
11ac80SISO	5530	Type5	23	9	403231.0	12	2	80.2	1098.0	1209.0	---
11ac80SISO	5530	Type5	23	10	610202.0	12	2	79.7	1588.0	1214.0	---
11ac80SISO	5530	Type5	23	11	815229.0	12	3	90.9	1615.0	1862.0	1601.0
11ac80SISO	5530	Type5	23	12	170267.0	12	2	68.7	1377.0	1441.0	---
11ac80SISO	5530	Type5	23	13	377306.0	12	2	67.4	1872.0	1313.0	---



Unless otherwise agreed in writing, this document is issued by the Company subject to its General Conditions of Service printed overleaf, available on request or accessible at <http://www.sgs.com/en/Terms-and-Conditions.aspx> and, for electronic format documents, subject to Terms and Conditions for Electronic Documents at <http://www.sgs.com/en/Terms-and-Conditions/Terms-e-Documents.aspx>. Attention is drawn to the limitation of liability, indemnification and jurisdiction issues defined therein. Any holder of this document is advised that information contained hereon reflects the Company's findings at the time of its intervention only and within the limits of Client's instructions, if any. The Company's sole responsibility is to its Client and this document does not exonerate parties to a transaction from exercising all their rights and obligations under the transaction documents. This document cannot be reproduced except in full, without prior written approval of the Company. Any unauthorized alteration, forgery or falsification of the content or appearance of this document is unlawful and offenders may be prosecuted to the fullest extent of the law. Unless otherwise stated the results shown in this test report refer only to the sample(s) tested and such sample(s) are retained for 30 days only.

Attention: To check the authenticity of testing/inspection report & certificate, please contact us at telephone: (86-755) 8307 1443, or email: CN.Doccheck@sgs.com

South of No. 6 Plant, No. 1, Runsheng Road, Suzhou Industrial Park, Suzhou Area, China (Jiangsu) Pilot Free Trade Zone 215000
 中国·苏州·中国(江苏)自由贸易试验区苏州片区苏州工业园区润胜路1号的6号厂房南楼 邮编: 215000

t (86-512) 62992980 www.sgs.com.cn
 t (86-512) 62992980 sgs.china@sgs.com

@FCC_RLAN_DFS_SPC_Radar_T5_SP2_Tr24@											
TestMode	Channel	Radar Type	Trial ID	Burst ID	Burst Offset (μs)	Chirp Width (MHz)	Number Of Pulses	Pulse Width (μs)	PRI1 (μs)	PRI2 (μs)	PRI3 (μs)
11ac20SISO	5500	Type5	24	0	628071.0	11	3	94.0	1643.0	1748.0	1941.0
11ac20SISO	5500	Type5	24	1	853391.0	11	2	70.8	1177.0	1201.0	---
11ac20SISO	5500	Type5	24	2	156223.0	11	1	56.3	1006.0	---	---
11ac20SISO	5500	Type5	24	3	378734.0	11	3	96.7	1230.0	1163.0	1332.0
11ac20SISO	5500	Type5	24	4	601331.0	11	3	90.6	1217.0	1582.0	1498.0
11ac20SISO	5500	Type5	24	5	825462.0	11	2	74.5	1569.0	1281.0	---
11ac20SISO	5500	Type5	24	6	128265.0	11	3	92.6	1065.0	1669.0	1222.0
11ac20SISO	5500	Type5	24	7	351161.0	11	3	89.0	1493.0	1135.0	1380.0
11ac20SISO	5500	Type5	24	8	573425.0	11	3	96.5	1607.0	1822.0	1602.0
11ac20SISO	5500	Type5	24	9	798431.0	11	2	70.5	1141.0	1178.0	---
11ac20SISO	5500	Type5	24	10	100737.0	11	3	94.0	1009.0	1629.0	1956.0
11ac20SISO	5500	Type5	24	11	324661.0	11	1	55.8	1290.0	---	---
11ac20SISO	5500	Type5	24	12	546278.0	11	3	87.7	1435.0	1963.0	1164.0
11ac40SISO	5510	Type5	24	0	628071.0	11	3	94.0	1643.0	1748.0	1941.0
11ac40SISO	5510	Type5	24	1	853391.0	11	2	70.8	1177.0	1201.0	---
11ac40SISO	5510	Type5	24	2	156223.0	11	1	56.3	1006.0	---	---
11ac40SISO	5510	Type5	24	3	378734.0	11	3	96.7	1230.0	1163.0	1332.0
11ac40SISO	5510	Type5	24	4	601331.0	11	3	90.6	1217.0	1582.0	1498.0
11ac40SISO	5510	Type5	24	5	825462.0	11	2	74.5	1569.0	1281.0	---
11ac40SISO	5510	Type5	24	6	128265.0	11	3	92.6	1065.0	1669.0	1222.0
11ac40SISO	5510	Type5	24	7	351161.0	11	3	89.0	1493.0	1135.0	1380.0
11ac40SISO	5510	Type5	24	8	573425.0	11	3	96.5	1607.0	1822.0	1602.0
11ac40SISO	5510	Type5	24	9	798431.0	11	2	70.5	1141.0	1178.0	---
11ac40SISO	5510	Type5	24	10	100737.0	11	3	94.0	1009.0	1629.0	1956.0
11ac40SISO	5510	Type5	24	11	324661.0	11	1	55.8	1290.0	---	---
11ac40SISO	5510	Type5	24	12	546278.0	11	3	87.7	1435.0	1963.0	1164.0
11ac80SISO	5530	Type5	24	0	628071.0	11	3	94.0	1643.0	1748.0	1941.0
11ac80SISO	5530	Type5	24	1	853391.0	11	2	70.8	1177.0	1201.0	---
11ac80SISO	5530	Type5	24	2	156223.0	11	1	56.3	1006.0	---	---
11ac80SISO	5530	Type5	24	3	378734.0	11	3	96.7	1230.0	1163.0	1332.0
11ac80SISO	5530	Type5	24	4	601331.0	11	3	90.6	1217.0	1582.0	1498.0
11ac80SISO	5530	Type5	24	5	825462.0	11	2	74.5	1569.0	1281.0	---
11ac80SISO	5530	Type5	24	6	128265.0	11	3	92.6	1065.0	1669.0	1222.0
11ac80SISO	5530	Type5	24	7	351161.0	11	3	89.0	1493.0	1135.0	1380.0
11ac80SISO	5530	Type5	24	8	573425.0	11	3	96.5	1607.0	1822.0	1602.0
11ac80SISO	5530	Type5	24	9	798431.0	11	2	70.5	1141.0	1178.0	---
11ac80SISO	5530	Type5	24	10	100737.0	11	3	94.0	1009.0	1629.0	1956.0
11ac80SISO	5530	Type5	24	11	324661.0	11	1	55.8	1290.0	---	---
11ac80SISO	5530	Type5	24	12	546278.0	11	3	87.7	1435.0	1963.0	1164.0



Unless otherwise agreed in writing, this document is issued by the Company subject to its General Conditions of Service printed overleaf, available on request or accessible at <http://www.sgs.com/en/Terms-and-Conditions.aspx> and, for electronic format documents, subject to Terms and Conditions for Electronic Documents at <http://www.sgs.com/en/Terms-and-Conditions/Terms-e-Documents.aspx>. Attention is drawn to the limitation of liability, indemnification and jurisdiction issues defined therein. Any holder of this document is advised that information contained hereon reflects the Company's findings at the time of its intervention only and within the limits of Client's instructions, if any. The Company's sole responsibility is to its Client and this document does not exonerate parties to a transaction from exercising all their rights and obligations under the transaction documents. This document cannot be reproduced except in full, without prior written approval of the Company. Any unauthorized alteration, forgery or falsification of the content or appearance of this document is unlawful and offenders may be prosecuted to the fullest extent of the law. Unless otherwise stated the results shown in this test report refer only to the sample(s) tested and such sample(s) are retained for 30 days only.

Attention: To check the authenticity of testing/inspection report & certificate, please contact us at telephone: (86-755) 8307 1443, or email: CN.Doccheck@sgs.com

South of No. 6 Plant, No. 1, Runsheng Road, Suzhou Industrial Park, Suzhou Area, China (Jiangsu) Pilot Free Trade Zone 215000 t (86-512) 62992980 www.sgs.com.cn
 中国·苏州·中国(江苏)自由贸易试验区苏州片区苏州工业园区润胜路1号的6号厂房南楼 邮编: 215000 t (86-512) 62992980 sgs.china@sgs.com

@FCC_RLAN_DFS_SPC_Radar_T5_SP2_Tr25@											
TestMode	Channel	Radar Type	Trial ID	Burst ID	Burst Offset (µs)	Chirp Width (MHz)	Number Of Pulses	Pulse Width (µs)	PRI1 (µs)	PRI2 (µs)	PRI3 (µs)
11ac20SISO	5500	Type5	25	0	1253842.0	5	2	68.6	1306.0	1161.0	---
11ac20SISO	5500	Type5	25	1	119486.0	5	2	83.1	1420.0	1315.0	---
11ac20SISO	5500	Type5	25	2	482958.0	5	1	60.9	1687.0	---	---
11ac20SISO	5500	Type5	25	3	845641.0	5	2	77.7	1776.0	1158.0	---
11ac20SISO	5500	Type5	25	4	1208428.0	5	2	77.4	1793.0	1510.0	---
11ac20SISO	5500	Type5	25	5	74748.0	5	2	66.8	1576.0	1323.0	---
11ac20SISO	5500	Type5	25	6	438300.0	5	1	63.7	1333.0	---	---
11ac20SISO	5500	Type5	25	7	800152.0	5	3	91.2	1409.0	1681.0	1275.0
11ac40SISO	5510	Type5	25	0	1253842.0	5	2	68.6	1306.0	1161.0	---
11ac40SISO	5510	Type5	25	1	119486.0	5	2	83.1	1420.0	1315.0	---
11ac40SISO	5510	Type5	25	2	482958.0	5	1	60.9	1687.0	---	---
11ac40SISO	5510	Type5	25	3	845641.0	5	2	77.7	1776.0	1158.0	---
11ac40SISO	5510	Type5	25	4	1208428.0	5	2	77.4	1793.0	1510.0	---
11ac40SISO	5510	Type5	25	5	74748.0	5	2	66.8	1576.0	1323.0	---
11ac40SISO	5510	Type5	25	6	438300.0	5	1	63.7	1333.0	---	---
11ac40SISO	5510	Type5	25	7	800152.0	5	3	91.2	1409.0	1681.0	1275.0
11ac80SISO	5530	Type5	25	0	1253842.0	5	2	68.6	1306.0	1161.0	---
11ac80SISO	5530	Type5	25	1	119486.0	5	2	83.1	1420.0	1315.0	---
11ac80SISO	5530	Type5	25	2	482958.0	5	1	60.9	1687.0	---	---
11ac80SISO	5530	Type5	25	3	845641.0	5	2	77.7	1776.0	1158.0	---
11ac80SISO	5530	Type5	25	4	1208428.0	5	2	77.4	1793.0	1510.0	---
11ac80SISO	5530	Type5	25	5	74748.0	5	2	66.8	1576.0	1323.0	---
11ac80SISO	5530	Type5	25	6	438300.0	5	1	63.7	1333.0	---	---
11ac80SISO	5530	Type5	25	7	800152.0	5	3	91.2	1409.0	1681.0	1275.0



Unless otherwise agreed in writing, this document is issued by the Company subject to its General Conditions of Service printed overleaf, available on request or accessible at <http://www.sgs.com/en/Terms-and-Conditions.aspx> and, for electronic format documents, subject to Terms and Conditions for Electronic Documents at <http://www.sgs.com/en/Terms-and-Conditions/Terms-e-Documents.aspx>. Attention is drawn to the limitation of liability, indemnification and jurisdiction issues defined therein. Any holder of this document is advised that information contained hereon reflects the Company's findings at the time of its intervention only and within the limits of Client's instructions, if any. The Company's sole responsibility is to its Client and this document does not exonerate parties to a transaction from exercising all their rights and obligations under the transaction documents. This document cannot be reproduced except in full, without prior written approval of the Company. Any unauthorized alteration, forgery or falsification of the content or appearance of this document is unlawful and offenders may be prosecuted to the fullest extent of the law. Unless otherwise stated the results shown in this test report refer only to the sample(s) tested and such sample(s) are retained for 30 days only.

Attention: To check the authenticity of testing/inspection report & certificate, please contact us at telephone: (86-755) 8307 1443, or email: CN.Doccheck@sgs.com

South of No. 6 Plant, No. 1, Runsheng Road, Suzhou Industrial Park, Suzhou Area, China (Jiangsu) Pilot Free Trade Zone 215000 t (86-512) 62992980 www.sgs.com.cn
 中国·苏州·中国(江苏)自由贸易试验区苏州片区苏州工业园区润胜路1号的6号厂房南楼 邮编: 215000 t (86-512) 62992980 sgs.china@sgs.com

@FCC_RLAN_DFS_SPC_Radar_T5_SP2_Tr26@											
TestMode	Channel	Radar Type	Trial ID	Burst ID	Burst Offset (μs)	Chirp Width (MHz)	Number Of Pulses	Pulse Width (μs)	PRI1 (μs)	PRI2 (μs)	PRI3 (μs)
11ac20SISO	5500	Type5	26	0	545865.0	16	3	83.6	1632.0	1195.0	1000.0
11ac20SISO	5500	Type5	26	1	14067.0	16	3	89.4	1173.0	1627.0	1656.0
11ac20SISO	5500	Type5	26	2	184953.0	16	1	55.8	1532.0	---	---
11ac20SISO	5500	Type5	26	3	353759.0	16	3	90.9	1981.0	1554.0	1998.0
11ac20SISO	5500	Type5	26	4	526388.0	16	1	54.7	1825.0	---	---
11ac20SISO	5500	Type5	26	5	694806.0	16	3	97.7	1734.0	1202.0	1250.0
11ac20SISO	5500	Type5	26	6	163568.0	16	2	67.5	1571.0	1434.0	---
11ac20SISO	5500	Type5	26	7	333410.0	16	3	96.7	1589.0	1469.0	1268.0
11ac20SISO	5500	Type5	26	8	504006.0	16	2	68.3	1750.0	1954.0	---
11ac20SISO	5500	Type5	26	9	675297.0	16	2	78.3	1591.0	1082.0	---
11ac20SISO	5500	Type5	26	10	142890.0	16	1	55.0	1427.0	---	---
11ac20SISO	5500	Type5	26	11	312479.0	16	3	84.9	1129.0	1936.0	1199.0
11ac20SISO	5500	Type5	26	12	482953.0	16	2	74.6	1959.0	1856.0	---
11ac20SISO	5500	Type5	26	13	655022.0	16	1	63.3	1885.0	---	---
11ac20SISO	5500	Type5	26	14	121457.0	16	3	99.8	1035.0	1515.0	1120.0
11ac20SISO	5500	Type5	26	15	292606.0	16	1	63.6	1647.0	---	---
11ac20SISO	5500	Type5	26	16	461322.0	16	3	87.3	1931.0	1051.0	1831.0
11ac40SISO	5510	Type5	26	0	545865.0	16	3	83.6	1632.0	1195.0	1000.0
11ac40SISO	5510	Type5	26	1	14067.0	16	3	89.4	1173.0	1627.0	1656.0
11ac40SISO	5510	Type5	26	2	184953.0	16	1	55.8	1532.0	---	---
11ac40SISO	5510	Type5	26	3	353759.0	16	3	90.9	1981.0	1554.0	1998.0
11ac40SISO	5510	Type5	26	4	526388.0	16	1	54.7	1825.0	---	---
11ac40SISO	5510	Type5	26	5	694806.0	16	3	97.7	1734.0	1202.0	1250.0
11ac40SISO	5510	Type5	26	6	163568.0	16	2	67.5	1571.0	1434.0	---
11ac40SISO	5510	Type5	26	7	333410.0	16	3	96.7	1589.0	1469.0	1268.0
11ac40SISO	5510	Type5	26	8	504006.0	16	2	68.3	1750.0	1954.0	---
11ac40SISO	5510	Type5	26	9	675297.0	16	2	78.3	1591.0	1082.0	---
11ac40SISO	5510	Type5	26	10	142890.0	16	1	55.0	1427.0	---	---
11ac40SISO	5510	Type5	26	11	312479.0	16	3	84.9	1129.0	1936.0	1199.0
11ac40SISO	5510	Type5	26	12	482953.0	16	2	74.6	1959.0	1856.0	---
11ac40SISO	5510	Type5	26	13	655022.0	16	1	63.3	1885.0	---	---
11ac40SISO	5510	Type5	26	14	121457.0	16	3	99.8	1035.0	1515.0	1120.0
11ac40SISO	5510	Type5	26	15	292606.0	16	1	63.6	1647.0	---	---
11ac40SISO	5510	Type5	26	16	461322.0	16	3	87.3	1931.0	1051.0	1831.0
11ac80SISO	5530	Type5	26	0	545865.0	16	3	83.6	1632.0	1195.0	1000.0
11ac80SISO	5530	Type5	26	1	14067.0	16	3	89.4	1173.0	1627.0	1656.0
11ac80SISO	5530	Type5	26	2	184953.0	16	1	55.8	1532.0	---	---
11ac80SISO	5530	Type5	26	3	353759.0	16	3	90.9	1981.0	1554.0	1998.0
11ac80SISO	5530	Type5	26	4	526388.0	16	1	54.7	1825.0	---	---
11ac80SISO	5530	Type5	26	5	694806.0	16	3	97.7	1734.0	1202.0	1250.0
11ac80SISO	5530	Type5	26	6	163568.0	16	2	67.5	1571.0	1434.0	---
11ac80SISO	5530	Type5	26	7	333410.0	16	3	96.7	1589.0	1469.0	1268.0
11ac80SISO	5530	Type5	26	8	504006.0	16	2	68.3	1750.0	1954.0	---
11ac80SISO	5530	Type5	26	9	675297.0	16	2	78.3	1591.0	1082.0	---
11ac80SISO	5530	Type5	26	10	142890.0	16	1	55.0	1427.0	---	---
11ac80SISO	5530	Type5	26	11	312479.0	16	3	84.9	1129.0	1936.0	1199.0
11ac80SISO	5530	Type5	26	12	482953.0	16	2	74.6	1959.0	1856.0	---
11ac80SISO	5530	Type5	26	13	655022.0	16	1	63.3	1885.0	---	---
11ac80SISO	5530	Type5	26	14	121457.0	16	3	99.8	1035.0	1515.0	1120.0
11ac80SISO	5530	Type5	26	15	292606.0	16	1	63.6	1647.0	---	---
11ac80SISO	5530	Type5	26	16	461322.0	16	3	87.3	1931.0	1051.0	1831.0



Unless otherwise agreed in writing, this document is issued by the Company subject to its General Conditions of Service printed overleaf, available on request or accessible at <http://www.sgs.com/en/Terms-and-Conditions.aspx> and, for electronic format documents, subject to Terms and Conditions for Electronic Documents at <http://www.sgs.com/en/Terms-and-Conditions/Terms-e-Documents.aspx>. Attention is drawn to the limitation of liability, indemnification and jurisdiction issues defined therein. Any holder of this document is advised that information contained hereon reflects the Company's findings at the time of its intervention only and within the limits of Client's instructions, if any. The Company's sole responsibility is to its Client and this document does not exonerate parties to a transaction from exercising all their rights and obligations under the transaction documents. This document cannot be reproduced except in full, without prior written approval of the Company. Any unauthorized alteration, forgery or falsification of the content or appearance of this document is unlawful and offenders may be prosecuted to the fullest extent of the law. Unless otherwise stated the results shown in this test report refer only to the sample(s) tested and such sample(s) are retained for 30 days only.

Attention: To check the authenticity of testing/inspection report & certificate, please contact us at telephone: (86-755) 8307 1443, or email: CN.Doccheck@sgs.com

South of No. 6 Plant, No. 1, Runsheng Road, Suzhou Industrial Park, Suzhou Area, China (Jiangsu) Pilot Free Trade Zone 215000 t (86-512) 62992980 www.sgs.com.cn
 中国·苏州·中国(江苏)自由贸易试验区苏州片区苏州工业园区润胜路1号的6号厂房南楼 邮编: 215000 t (86-512) 62992980 sgs.china@sgs.com

@FCC_RLAN_DFS_SPC_Radar_T5_SP2_Tr27@

TestMode	Channel	Radar Type	Trial ID	Burst ID	Burst Offset (μs)	Chirp Width (MHz)	Number Of Pulses	Pulse Width (μs)	PRI1 (μs)	PRI2 (μs)	PRI3 (μs)
11ac20SISO	5500	Type5	27	0	565136.0	19	3	85.6	1946.0	1078.0	1015.0
11ac20SISO	5500	Type5	27	1	89970.0	19	2	68.6	1029.0	1780.0	---
11ac20SISO	5500	Type5	27	2	243121.0	19	1	54.2	1111.0	---	---
11ac20SISO	5500	Type5	27	3	396034.0	19	1	61.2	1104.0	---	---
11ac20SISO	5500	Type5	27	4	546225.0	19	3	97.1	1157.0	1969.0	1100.0
11ac20SISO	5500	Type5	27	5	70998.0	19	3	98.3	1142.0	1699.0	1622.0
11ac20SISO	5500	Type5	27	6	224093.0	19	1	62.4	1655.0	---	---
11ac20SISO	5500	Type5	27	7	376127.0	19	2	80.2	1126.0	1769.0	---
11ac20SISO	5500	Type5	27	8	527806.0	19	3	87.5	1216.0	1448.0	1179.0
11ac20SISO	5500	Type5	27	9	52247.0	19	3	85.8	1847.0	1348.0	1472.0
11ac20SISO	5500	Type5	27	10	204582.0	19	3	88.1	1023.0	1124.0	1631.0
11ac20SISO	5500	Type5	27	11	357941.0	19	1	65.3	1848.0	---	---
11ac20SISO	5500	Type5	27	12	510977.0	19	1	52.5	1470.0	---	---
11ac20SISO	5500	Type5	27	13	33698.0	19	1	52.3	1312.0	---	---
11ac20SISO	5500	Type5	27	14	186023.0	19	2	74.1	1915.0	1200.0	---
11ac20SISO	5500	Type5	27	15	339327.0	19	1	54.9	1479.0	---	---
11ac20SISO	5500	Type5	27	16	491053.0	19	2	76.2	1376.0	1502.0	---
11ac20SISO	5500	Type5	27	17	14858.0	19	1	60.4	1758.0	---	---
11ac20SISO	5500	Type5	27	18	167387.0	19	2	81.5	1491.0	1103.0	---
11ac40SISO	5510	Type5	27	0	565136.0	19	3	85.6	1946.0	1078.0	1015.0
11ac40SISO	5510	Type5	27	1	89970.0	19	2	68.6	1029.0	1780.0	---
11ac40SISO	5510	Type5	27	2	243121.0	19	1	54.2	1111.0	---	---
11ac40SISO	5510	Type5	27	3	396034.0	19	1	61.2	1104.0	---	---
11ac40SISO	5510	Type5	27	4	546225.0	19	3	97.1	1157.0	1969.0	1100.0
11ac40SISO	5510	Type5	27	5	70998.0	19	3	98.3	1142.0	1699.0	1622.0
11ac40SISO	5510	Type5	27	6	224093.0	19	1	62.4	1655.0	---	---
11ac40SISO	5510	Type5	27	7	376127.0	19	2	80.2	1126.0	1769.0	---
11ac40SISO	5510	Type5	27	8	527806.0	19	3	87.5	1216.0	1448.0	1179.0
11ac40SISO	5510	Type5	27	9	52247.0	19	3	85.8	1847.0	1348.0	1472.0
11ac40SISO	5510	Type5	27	10	204582.0	19	3	88.1	1023.0	1124.0	1631.0
11ac40SISO	5510	Type5	27	11	357941.0	19	1	65.3	1848.0	---	---
11ac40SISO	5510	Type5	27	12	510977.0	19	1	52.5	1470.0	---	---
11ac40SISO	5510	Type5	27	13	33698.0	19	1	52.3	1312.0	---	---
11ac40SISO	5510	Type5	27	14	186023.0	19	2	74.1	1915.0	1200.0	---
11ac40SISO	5510	Type5	27	15	339327.0	19	1	54.9	1479.0	---	---
11ac40SISO	5510	Type5	27	16	491053.0	19	2	76.2	1376.0	1502.0	---
11ac40SISO	5510	Type5	27	17	14858.0	19	1	60.4	1758.0	---	---
11ac40SISO	5510	Type5	27	18	167387.0	19	2	81.5	1491.0	1103.0	---
11ac80SISO	5530	Type5	27	0	565136.0	19	3	85.6	1946.0	1078.0	1015.0
11ac80SISO	5530	Type5	27	1	89970.0	19	2	68.6	1029.0	1780.0	---
11ac80SISO	5530	Type5	27	2	243121.0	19	1	54.2	1111.0	---	---
11ac80SISO	5530	Type5	27	3	396034.0	19	1	61.2	1104.0	---	---
11ac80SISO	5530	Type5	27	4	546225.0	19	3	97.1	1157.0	1969.0	1100.0
11ac80SISO	5530	Type5	27	5	70998.0	19	3	98.3	1142.0	1699.0	1622.0
11ac80SISO	5530	Type5	27	6	224093.0	19	1	62.4	1655.0	---	---
11ac80SISO	5530	Type5	27	7	376127.0	19	2	80.2	1126.0	1769.0	---
11ac80SISO	5530	Type5	27	8	527806.0	19	3	87.5	1216.0	1448.0	1179.0
11ac80SISO	5530	Type5	27	9	52247.0	19	3	85.8	1847.0	1348.0	1472.0
11ac80SISO	5530	Type5	27	10	204582.0	19	3	88.1	1023.0	1124.0	1631.0
11ac80SISO	5530	Type5	27	11	357941.0	19	1	65.3	1848.0	---	---
11ac80SISO	5530	Type5	27	12	510977.0	19	1	52.5	1470.0	---	---
11ac80SISO	5530	Type5	27	13	33698.0	19	1	52.3	1312.0	---	---
11ac80SISO	5530	Type5	27	14	186023.0	19	2	74.1	1915.0	1200.0	---
11ac80SISO	5530	Type5	27	15	339327.0	19	1	54.9	1479.0	---	---
11ac80SISO	5530	Type5	27	16	491053.0	19	2	76.2	1376.0	1502.0	---
11ac80SISO	5530	Type5	27	17	14858.0	19	1	60.4	1758.0	---	---
11ac80SISO	5530	Type5	27	18	167387.0	19	2	81.5	1491.0	1103.0	---



Unless otherwise agreed in writing, this document is issued by the Company subject to its General Conditions of Service printed overleaf, available on request or accessible at <http://www.sgs.com/en/Terms-and-Conditions.aspx> and, for electronic format documents, subject to Terms and Conditions for Electronic Documents at <http://www.sgs.com/en/Terms-and-Conditions/Terms-e-Documents.aspx>. Attention is drawn to the limitation of liability, indemnification and jurisdiction issues defined therein. Any holder of this document is advised that information contained hereon reflects the Company's findings at the time of its intervention only and within the limits of Client's instructions, if any. The Company's sole responsibility is to its Client and this document does not exonerate parties to a transaction from exercising all their rights and obligations under the transaction documents. This document cannot be reproduced except in full, without prior written approval of the Company. Any unauthorized alteration, forgery or falsification of the content or appearance of this document is unlawful and offenders may be prosecuted to the fullest extent of the law. Unless otherwise stated the results shown in this test report refer only to the sample(s) tested and such sample(s) are retained for 30 days only.

Attention: To check the authenticity of testing/inspection report & certificate, please contact us at telephone: (86-755) 8307 1443, or email: CN.Doccheck@sgs.com

South of No. 6 Plant, No. 1, Runsheng Road, Suzhou Industrial Park, Suzhou Area, China (Jiangsu) Pilot Free Trade Zone 215000 t (86-512) 62992980 www.sgs.com.cn
 中国·苏州·中国(江苏)自由贸易试验区苏州片区工业园区润胜路1号的6号厂房南部 邮编: 215000 t (86-512) 62992980 sgs.china@sgs.com

@FCC_RLAN_DFS_SPC_Radar_T5_SP2_Tr28@											
TestMode	Channel	Radar Type	Trial ID	Burst ID	Burst Offset (μs)	Chirp Width (MHz)	Number Of Pulses	Pulse Width (μs)	PRI1 (μs)	PRI2 (μs)	PRI3 (μs)
11ac20SISO	5500	Type5	28	0	507709.0	10	1	50.5	1857.0	---	---
11ac20SISO	5500	Type5	28	1	750249.0	10	1	55.7	1246.0	---	---
11ac20SISO	5500	Type5	28	2	989003.0	10	3	85.8	1774.0	1002.0	1967.0
11ac20SISO	5500	Type5	28	3	235634.0	10	2	76.9	1125.0	1474.0	---
11ac20SISO	5500	Type5	28	4	477675.0	10	2	75.1	1254.0	1052.0	---
11ac20SISO	5500	Type5	28	5	718312.0	10	3	92.3	1180.0	1486.0	1492.0
11ac20SISO	5500	Type5	28	6	960895.0	10	2	78.1	1301.0	1757.0	---
11ac20SISO	5500	Type5	28	7	205370.0	10	3	92.2	1898.0	1252.0	1713.0
11ac20SISO	5500	Type5	28	8	446940.0	10	3	89.0	1260.0	1706.0	1411.0
11ac20SISO	5500	Type5	28	9	689225.0	10	2	70.9	1578.0	1620.0	---
11ac20SISO	5500	Type5	28	10	932305.0	10	1	63.1	1782.0	---	---
11ac20SISO	5500	Type5	28	11	176231.0	10	1	55.3	1522.0	---	---
11ac40SISO	5510	Type5	28	0	507709.0	10	1	50.5	1857.0	---	---
11ac40SISO	5510	Type5	28	1	750249.0	10	1	55.7	1246.0	---	---
11ac40SISO	5510	Type5	28	2	989003.0	10	3	85.8	1774.0	1002.0	1967.0
11ac40SISO	5510	Type5	28	3	235634.0	10	2	76.9	1125.0	1474.0	---
11ac40SISO	5510	Type5	28	4	477675.0	10	2	75.1	1254.0	1052.0	---
11ac40SISO	5510	Type5	28	5	718312.0	10	3	92.3	1180.0	1486.0	1492.0
11ac40SISO	5510	Type5	28	6	960895.0	10	2	78.1	1301.0	1757.0	---
11ac40SISO	5510	Type5	28	7	205370.0	10	3	92.2	1898.0	1252.0	1713.0
11ac40SISO	5510	Type5	28	8	446940.0	10	3	89.0	1260.0	1706.0	1411.0
11ac40SISO	5510	Type5	28	9	689225.0	10	2	70.9	1578.0	1620.0	---
11ac40SISO	5510	Type5	28	10	932305.0	10	1	63.1	1782.0	---	---
11ac40SISO	5510	Type5	28	11	176231.0	10	1	55.3	1522.0	---	---
11ac80SISO	5530	Type5	28	0	507709.0	10	1	50.5	1857.0	---	---
11ac80SISO	5530	Type5	28	1	750249.0	10	1	55.7	1246.0	---	---
11ac80SISO	5530	Type5	28	2	989003.0	10	3	85.8	1774.0	1002.0	1967.0
11ac80SISO	5530	Type5	28	3	235634.0	10	2	76.9	1125.0	1474.0	---
11ac80SISO	5530	Type5	28	4	477675.0	10	2	75.1	1254.0	1052.0	---
11ac80SISO	5530	Type5	28	5	718312.0	10	3	92.3	1180.0	1486.0	1492.0
11ac80SISO	5530	Type5	28	6	960895.0	10	2	78.1	1301.0	1757.0	---
11ac80SISO	5530	Type5	28	7	205370.0	10	3	92.2	1898.0	1252.0	1713.0
11ac80SISO	5530	Type5	28	8	446940.0	10	3	89.0	1260.0	1706.0	1411.0
11ac80SISO	5530	Type5	28	9	689225.0	10	2	70.9	1578.0	1620.0	---
11ac80SISO	5530	Type5	28	10	932305.0	10	1	63.1	1782.0	---	---
11ac80SISO	5530	Type5	28	11	176231.0	10	1	55.3	1522.0	---	---



Unless otherwise agreed in writing, this document is issued by the Company subject to its General Conditions of Service printed overleaf, available on request or accessible at <http://www.sgs.com/en/Terms-and-Conditions.aspx> and, for electronic format documents, subject to Terms and Conditions for Electronic Documents at <http://www.sgs.com/en/Terms-and-Conditions/Terms-e-Documents.aspx>. Attention is drawn to the limitation of liability, indemnification and jurisdiction issues defined therein. Any holder of this document is advised that information contained hereon reflects the Company's findings at the time of its intervention only and within the limits of Client's instructions, if any. The Company's sole responsibility is to its Client and this document does not exonerate parties to a transaction from exercising all their rights and obligations under the transaction documents. This document cannot be reproduced except in full, without prior written approval of the Company. Any unauthorized alteration, forgery or falsification of the content or appearance of this document is unlawful and offenders may be prosecuted to the fullest extent of the law. Unless otherwise stated the results shown in this test report refer only to the sample(s) tested and such sample(s) are retained for 30 days only.

Attention: To check the authenticity of testing/inspection report & certificate, please contact us at telephone: (86-755) 8307 1443, or email: CN.Doccheck@sgs.com

South of No. 6 Plant, No. 1, Runsheng Road, Suzhou Industrial Park, Suzhou Area, China (Jiangsu) Pilot Free Trade Zone 215000 t (86-512) 62992980 www.sgs.com.cn
 中国·苏州·中国(江苏)自由贸易试验区苏州片区苏州工业园区润胜路1号的6号厂房南楼 邮编: 215000 t (86-512) 62992980 sgs.china@sgs.com

@FCC_RLAN_DFS_SPC_Radar_T5_SP2_Tr29@

TestMode	Channel	Radar Type	Trial ID	Burst ID	Burst Offset (μs)	Chirp Width (MHz)	Number Of Pulses	Pulse Width (μs)	PRI1 (μs)	PRI2 (μs)	PRI3 (μs)
11ac20SISO	5500	Type5	29	0	277485.0	17	3	83.4	1454.0	1205.0	1801.0
11ac20SISO	5500	Type5	29	1	437880.0	17	3	97.3	1319.0	1826.0	1635.0
11ac20SISO	5500	Type5	29	2	598445.0	17	3	90.4	1079.0	1986.0	1674.0
11ac20SISO	5500	Type5	29	3	97088.0	17	3	91.8	1563.0	1151.0	1802.0
11ac20SISO	5500	Type5	29	4	257251.0	17	3	98.2	1876.0	1977.0	1766.0
11ac20SISO	5500	Type5	29	5	419893.0	17	1	59.5	1952.0	---	---
11ac20SISO	5500	Type5	29	6	580724.0	17	2	80.0	1253.0	1137.0	---
11ac20SISO	5500	Type5	29	7	77366.0	17	3	86.5	1054.0	1128.0	1828.0
11ac20SISO	5500	Type5	29	8	238032.0	17	3	91.1	1105.0	1599.0	1442.0
11ac20SISO	5500	Type5	29	9	398605.0	17	3	93.5	1867.0	1373.0	1087.0
11ac20SISO	5500	Type5	29	10	562025.0	17	1	60.7	1033.0	---	---
11ac20SISO	5500	Type5	29	11	57684.0	17	2	67.2	1288.0	1405.0	---
11ac20SISO	5500	Type5	29	12	219083.0	17	1	61.8	1585.0	---	---
11ac20SISO	5500	Type5	29	13	379234.0	17	2	79.4	1933.0	1667.0	---
11ac20SISO	5500	Type5	29	14	540896.0	17	2	81.4	1096.0	1464.0	---
11ac20SISO	5500	Type5	29	15	37916.0	17	1	65.7	1496.0	---	---
11ac20SISO	5500	Type5	29	16	198794.0	17	2	76.0	1733.0	1255.0	---
11ac20SISO	5500	Type5	29	17	359754.0	17	2	81.0	1326.0	1668.0	---
11ac40SISO	5510	Type5	29	0	277485.0	17	3	83.4	1454.0	1205.0	1801.0
11ac40SISO	5510	Type5	29	1	437880.0	17	3	97.3	1319.0	1826.0	1635.0
11ac40SISO	5510	Type5	29	2	598445.0	17	3	90.4	1079.0	1986.0	1674.0
11ac40SISO	5510	Type5	29	3	97088.0	17	3	91.8	1563.0	1151.0	1802.0
11ac40SISO	5510	Type5	29	4	257251.0	17	3	98.2	1876.0	1977.0	1766.0
11ac40SISO	5510	Type5	29	5	419893.0	17	1	59.5	1952.0	---	---
11ac40SISO	5510	Type5	29	6	580724.0	17	2	80.0	1253.0	1137.0	---
11ac40SISO	5510	Type5	29	7	77366.0	17	3	86.5	1054.0	1128.0	1828.0
11ac40SISO	5510	Type5	29	8	238032.0	17	3	91.1	1105.0	1599.0	1442.0
11ac40SISO	5510	Type5	29	9	398605.0	17	3	93.5	1867.0	1373.0	1087.0
11ac40SISO	5510	Type5	29	10	562025.0	17	1	60.7	1033.0	---	---
11ac40SISO	5510	Type5	29	11	57684.0	17	2	67.2	1288.0	1405.0	---
11ac40SISO	5510	Type5	29	12	219083.0	17	1	61.8	1585.0	---	---
11ac40SISO	5510	Type5	29	13	379234.0	17	2	79.4	1933.0	1667.0	---
11ac40SISO	5510	Type5	29	14	540896.0	17	2	81.4	1096.0	1464.0	---
11ac40SISO	5510	Type5	29	15	37916.0	17	1	65.7	1496.0	---	---
11ac40SISO	5510	Type5	29	16	198794.0	17	2	76.0	1733.0	1255.0	---
11ac40SISO	5510	Type5	29	17	359754.0	17	2	81.0	1326.0	1668.0	---
11ac80SISO	5530	Type5	29	0	277485.0	17	3	83.4	1454.0	1205.0	1801.0
11ac80SISO	5530	Type5	29	1	437880.0	17	3	97.3	1319.0	1826.0	1635.0
11ac80SISO	5530	Type5	29	2	598445.0	17	3	90.4	1079.0	1986.0	1674.0
11ac80SISO	5530	Type5	29	3	97088.0	17	3	91.8	1563.0	1151.0	1802.0
11ac80SISO	5530	Type5	29	4	257251.0	17	3	98.2	1876.0	1977.0	1766.0
11ac80SISO	5530	Type5	29	5	419893.0	17	1	59.5	1952.0	---	---
11ac80SISO	5530	Type5	29	6	580724.0	17	2	80.0	1253.0	1137.0	---
11ac80SISO	5530	Type5	29	7	77366.0	17	3	86.5	1054.0	1128.0	1828.0
11ac80SISO	5530	Type5	29	8	238032.0	17	3	91.1	1105.0	1599.0	1442.0
11ac80SISO	5530	Type5	29	9	398605.0	17	3	93.5	1867.0	1373.0	1087.0
11ac80SISO	5530	Type5	29	10	562025.0	17	1	60.7	1033.0	---	---
11ac80SISO	5530	Type5	29	11	57684.0	17	2	67.2	1288.0	1405.0	---
11ac80SISO	5530	Type5	29	12	219083.0	17	1	61.8	1585.0	---	---
11ac80SISO	5530	Type5	29	13	379234.0	17	2	79.4	1933.0	1667.0	---
11ac80SISO	5530	Type5	29	14	540896.0	17	2	81.4	1096.0	1464.0	---
11ac80SISO	5530	Type5	29	15	37916.0	17	1	65.7	1496.0	---	---
11ac80SISO	5530	Type5	29	16	198794.0	17	2	76.0	1733.0	1255.0	---
11ac80SISO	5530	Type5	29	17	359754.0	17	2	81.0	1326.0	1668.0	---



Unless otherwise agreed in writing, this document is issued by the Company subject to its General Conditions of Service printed overleaf, available on request or accessible at <http://www.sgs.com/en/Terms-and-Conditions.aspx> and, for electronic format documents, subject to Terms and Conditions for Electronic Documents at <http://www.sgs.com/en/Terms-and-Conditions/Terms-e-Documents.aspx>. Attention is drawn to the limitation of liability, indemnification and jurisdiction issues defined therein. Any holder of this document is advised that information contained hereon reflects the Company's findings at the time of its intervention only and within the limits of Client's instructions, if any. The Company's sole responsibility is to its Client and this document does not exonerate parties to a transaction from exercising all their rights and obligations under the transaction documents. This document cannot be reproduced except in full, without prior written approval of the Company. Any unauthorized alteration, forgery or falsification of the content or appearance of this document is unlawful and offenders may be prosecuted to the fullest extent of the law. Unless otherwise stated the results shown in this test report refer only to the sample(s) tested and such sample(s) are retained for 30 days only.

Attention: To check the authenticity of testing/inspection report & certificate, please contact us at telephone: (86-755) 8307 1443, or email: CN.Doccheck@sgs.com

South of No. 6 Plant, No. 1, Runsheng Road, Suzhou Industrial Park, Suzhou Area, China (Jiangsu) Pilot Free Trade Zone 215000
 中国·苏州·中国(江苏)自由贸易试验区苏州片区工业园区润胜路1号的6号厂房南部 邮编: 215000

t (86-512) 62992980 www.sgs.com.cn
 t (86-512) 62992980 sgs.china@sgs.com

TestMode	Frequency[MHz]	Radar Type	Trial ID	Pulse width (μs)	PRI (μs)	Pulses per Hop	Detection (1: Yes; 0: No)
11ac20SISO	5500	Type6	0	1	333.3	9	1
		Type6	1	1	333.3	9	1
		Type6	2	1	333.3	9	1
		Type6	3	1	333.3	9	1
		Type6	4	1	333.3	9	1
		Type6	5	1	333.3	9	1
		Type6	6	1	333.3	9	1
		Type6	7	1	333.3	9	1
		Type6	8	1	333.3	9	1
		Type6	9	1	333.3	9	1
		Type6	10	1	333.3	9	1
		Type6	11	1	333.3	9	1
		Type6	12	1	333.3	9	1
		Type6	13	1	333.3	9	1
		Type6	14	1	333.3	9	1
		Type6	15	1	333.3	9	1
		Type6	16	1	333.3	9	1
		Type6	17	1	333.3	9	1
		Type6	18	1	333.3	9	1
		Type6	19	1	333.3	9	1
		Type6	20	1	333.3	9	1
		Type6	21	1	333.3	9	1
		Type6	22	1	333.3	9	1
		Type6	23	1	333.3	9	1
		Type6	24	1	333.3	9	1
		Type6	25	1	333.3	9	1
		Type6	26	1	333.3	9	1
		Type6	27	1	333.3	9	1
		Type6	28	1	333.3	9	1
Type6	29	1	333.3	9	1		
11ac40SISO	5510	Type6	0	1	333.3	9	1
		Type6	1	1	333.3	9	1
		Type6	2	1	333.3	9	1
		Type6	3	1	333.3	9	1
		Type6	4	1	333.3	9	1
		Type6	5	1	333.3	9	1
		Type6	6	1	333.3	9	1
		Type6	7	1	333.3	9	1
		Type6	8	1	333.3	9	1
		Type6	9	1	333.3	9	1
		Type6	10	1	333.3	9	1
		Type6	11	1	333.3	9	1
		Type6	12	1	333.3	9	1
		Type6	13	1	333.3	9	1
		Type6	14	1	333.3	9	1
		Type6	15	1	333.3	9	1
		Type6	16	1	333.3	9	1
		Type6	17	1	333.3	9	1
		Type6	18	1	333.3	9	1
		Type6	19	1	333.3	9	1
		Type6	20	1	333.3	9	1
		Type6	21	1	333.3	9	1
		Type6	22	1	333.3	9	1
		Type6	23	1	333.3	9	1



Unless otherwise agreed in writing, this document is issued by the Company subject to its General Conditions of Service printed overleaf, available on request or accessible at <http://www.sgs.com/en/Terms-and-Conditions.aspx> and, for electronic format documents, subject to Terms and Conditions for Electronic Documents at <http://www.sgs.com/en/Terms-and-Conditions/Terms-e-Documents.aspx>. Attention is drawn to the limitation of liability, indemnification and jurisdiction issues defined therein. Any holder of this document is advised that information contained hereon reflects the Company's findings at the time of its intervention only and within the limits of Client's instructions, if any. The Company's sole responsibility is to its Client and this document does not exonerate parties to a transaction from exercising all their rights and obligations under the transaction documents. This document cannot be reproduced except in full, without prior written approval of the Company. Any unauthorized alteration, forgery or falsification of the content or appearance of this document is unlawful and offenders may be prosecuted to the fullest extent of the law. Unless otherwise stated the results shown in this test report refer only to the sample(s) tested and such sample(s) are retained for 30 days only.

Attention: To check the authenticity of testing/inspection report & certificate, please contact us at telephone: (86-755) 8307 1443, or email: CN.Doccheck@sgs.com

South of No. 6 Plant, No. 1, Runsheng Road, Suzhou Industrial Park, Suzhou Area, China (Jiangsu) Pilot Free Trade Zone 215000 t (86-512) 62992980 www.sgs.com.cn
 中国·苏州·中国(江苏)自由贸易试验区苏州片区苏州工业园区润胜路1号的6号厂房南部 邮编: 215000 t (86-512) 62992980 sgs.china@sgs.com

		Type6	24	1	333.3	9	1
		Type6	25	1	333.3	9	1
		Type6	26	1	333.3	9	1
		Type6	27	1	333.3	9	1
		Type6	28	1	333.3	9	1
		Type6	29	1	333.3	9	1
11ac80SISO	5530	Type6	0	1	333.3	9	1
		Type6	1	1	333.3	9	1
		Type6	2	1	333.3	9	1
		Type6	3	1	333.3	9	1
		Type6	4	1	333.3	9	1
		Type6	5	1	333.3	9	1
		Type6	6	1	333.3	9	1
		Type6	7	1	333.3	9	1
		Type6	8	1	333.3	9	1
		Type6	9	1	333.3	9	0
		Type6	10	1	333.3	9	1
		Type6	11	1	333.3	9	1
		Type6	12	1	333.3	9	1
		Type6	13	1	333.3	9	1
		Type6	14	1	333.3	9	1
		Type6	15	1	333.3	9	0
		Type6	16	1	333.3	9	1
		Type6	17	1	333.3	9	1
		Type6	18	1	333.3	9	1
		Type6	19	1	333.3	9	1
		Type6	20	1	333.3	9	1
		Type6	21	1	333.3	9	1
		Type6	22	1	333.3	9	1
		Type6	23	1	333.3	9	1
		Type6	24	1	333.3	9	1
		Type6	25	1	333.3	9	1
		Type6	26	1	333.3	9	1
		Type6	27	1	333.3	9	1
		Type6	28	1	333.3	9	1
Type6	29	1	333.3	9	1		

---End of Report---



Unless otherwise agreed in writing, this document is issued by the Company subject to its General Conditions of Service printed overleaf, available on request or accessible at <http://www.sgs.com/en/Terms-and-Conditions.aspx> and, for electronic format documents, subject to Terms and Conditions for Electronic Documents at <http://www.sgs.com/en/Terms-and-Conditions/Terms-e-Documents.aspx>. Attention is drawn to the limitation of liability, indemnification and jurisdiction issues defined therein. Any holder of this document is advised that information contained hereon reflects the Company's findings at the time of its intervention only and within the limits of Client's instructions, if any. The Company's sole responsibility is to its Client and this document does not exonerate parties to a transaction from exercising all their rights and obligations under the transaction documents. This document cannot be reproduced except in full, without prior written approval of the Company. Any unauthorized alteration, forgery or falsification of the content or appearance of this document is unlawful and offenders may be prosecuted to the fullest extent of the law. Unless otherwise stated the results shown in this test report refer only to the sample(s) tested and such sample(s) are retained for 30 days only.

Attention: To check the authenticity of testing/inspection report & certificate, please contact us at telephone: (86-755) 8307 1443, or email: CN.Doccheck@sgs.com

South of No. 6 Plant, No. 1, Runsheng Road, Suzhou Industrial Park, Suzhou Area, China (Jiangsu) Pilot Free Trade Zone 215000 t (86-512) 62992980 www.sgs.com.cn
 中国·苏州·中国(江苏)自由贸易试验区苏州片区苏州工业园区润胜路1号的6号厂房南楼 邮编: 215000 t (86-512) 62992980 sgs.china@sgs.com