



中认信通
CHINA CERTIFICATION ICT CO., LTD (DONGGUAN)



TEST REPORT

Applicant: WAC LIGHTING CO

Address: No.390 Qingfeng RD, Qingxi TW Dongguan City, Guangdong Province, China

FCC ID: 2APNFWAC000003

Product Name: W System-Sensor

Model Number: S2SN-1-BK, S2SN-1*

**Standard(s): 47 CFR Part 15, Subpart C(15.245)
ANSI C63.10-2013**

The above equipment has been tested and found compliance with the requirement of the relative standards by China Certification ICT Co., Ltd (Dongguan)

Report Number: CR22030057-00

Date Of Issue: 2022-04-19

Reviewed By: Sun Zhong

Sun Zhong

Title: Manager

Test Laboratory: China Certification ICT Co., Ltd (Dongguan)

No. 113, Pingkang Road, Dalang Town, Dongguan,
Guangdong, China

Tel: +86-769-82016888

Test Facility

The Test site used by China Certification ICT Co., Ltd (Dongguan) to collect test data is located on the No. 113, Pingkang Road, Dalang Town, Dongguan, Guangdong, China.

The lab has been recognized as the FCC accredited lab under the KDB 974614 D01 and is listed in the FCC Public Access Link (PAL) database, FCC Registration No. : 442868, the FCC Designation No. : CN1314.

The lab has been recognized by Innovation, Science and Economic Development Canada to test to Canadian radio equipment requirements, the CAB identifier: CN0123.

Declarations

China Certification ICT Co., Ltd (Dongguan) is not responsible for the authenticity of any test data provided by the applicant. Data included from the applicant that may affect test results are marked with a triangle symbol “▲”. Customer model name, addresses, names, trademarks etc. are not considered data.

Unless otherwise stated the results shown in this test report refer only to the sample(s) tested.

This report cannot be reproduced except in full, without prior written approval of the Company.

This report is valid only with a valid digital signature. The digital signature may be available only under the Adobe software above version 7.0.

This report may contain data that are not covered by the accreditation scope and shall be marked with an asterisk “★”.

CONTENTS

TEST FACILITY	2
DECLARATIONS.....	2
1. GENERAL INFORMATION	4
1.1 PRODUCT DESCRIPTION FOR EQUIPMENT UNDER TEST (EUT)	4
1.2 DESCRIPTION OF TEST CONFIGURATION.....	5
1.2.2 Support Equipment List and Details	5
1.2.3 Support Cable List and Details	5
1.2.4 Block Diagram of Test Setup.....	5
1.3 MEASUREMENT UNCERTAINTY	7
2. SUMMARY OF TEST RESULTS	8
3. REQUIREMENTS AND TEST PROCEDURES	9
3.1 AC LINE CONDUCTED EMISSIONS	9
3.1.1 Applicable Standard.....	9
3.1.2 EUT Setup.....	10
3.1.3 EMI Test Receiver Setup	10
3.1.4 Test Procedure	11
3.1.5 Corrected Amplitude & Margin Calculation.....	11
3.2 RADIATION SPURIOUS EMISSIONS	12
3.2.1 Applicable Standard.....	12
3.2.2 EUT Setup.....	13
3.2.3 EMI Test Receiver & Spectrum Analyzer Setup	14
3.2.4 Test Procedure	15
3.2.5 Corrected Amplitude & Margin Calculation.....	15
3.3 20 DB BANDWIDTH.....	16
3.3.1 Applicable Standard.....	16
3.3.2 EUT Setup.....	16
3.3.3 Test Procedure	16
3.4 ANTENNA REQUIREMENT.....	17
3.4.1 Applicable Standard.....	17
3.4.2 Judgment.....	17
4. TEST DATA AND RESULTS	18
4.1 AC LINE CONDUCTED EMISSIONS	18
4.2 RADIATION SPURIOUS EMISSIONS	21
4.3 20 DB EMISSION BANDWIDTH:.....	29

1. GENERAL INFORMATION

1.1 Product Description for Equipment under Test (EUT)

EUT Name:	W System-Sensor
EUT Model:	S2SN-1-BK
Multiple Model:	S2SN-1*
Operation Frequency:	10525 MHz
Maximum Field strength of fundamental:	92.65 dB μ V/m@3m
Modulation Type:	CW
Rated Input Voltage:	DC 48V
Serial Number:	CR220030057-RF-S1
EUT Received Date:	2022.03.29
EUT Received Status:	Good
Note: The Multiple models are electrically identical with Test model, please refer to the declaration letter for more detail, which was provided by manufacturer.	

Operation Frequency Detail:

Channel	Frequency (MHz)
0	10525

Per section 15.31(m), the frequency was performed the test as below:

Test Channel	Frequency (MHz)
0	10525

Antenna Information Detail ▲:

Antenna Manufacturer	Antenna Type	input impedance (Ohm)	Antenna Gain /Frequency Range	§15.203 Requirement
WAC LIGHTING CO	PCB	50	3.3 dBi/ 10.5~10.55GHz	Compliance

The Method of §15.203 Compliance:

- Antenna must be permanently attached to the unit.
- Antenna must use a unique type of connector to attach to the EUT.
- Unit must be professionally installed, and installer shall be responsible for verifying that the correct antenna is employed with the unit.

Accessory Information:

No.

1.2 Description of Test Configuration

1.2.1 EUT Operation Condition:

EUT Operation Mode:	The system was configured for testing in Engineering Mode, which was provided by the manufacturer.
Equipment Modifications:	No
EUT Exercise Software:	No
Engineering Mode was provided by manufacturer ▲. The maximum power was configured default setting.	

1.2.2 Support Equipment List and Details

Manufacturer	Description	Model	Serial Number
WAC LIGHTING CO	Guide	N/A	CR220030057-RF-S3
ZHAOXIN	DC Power Supply	RXN-6010D	21R6010D0912386

1.2.3 Support Cable List and Details

Cable Description	Shielding Type	Ferrite Core	Length (m)	From Port	To
Power Cable	No	No	1.5	DC Power Supply	EUT
Power Cable	No	No	1.5	DC Power Supply	LISN

1.2.4 Block Diagram of Test Setup

AC line conducted emissions:

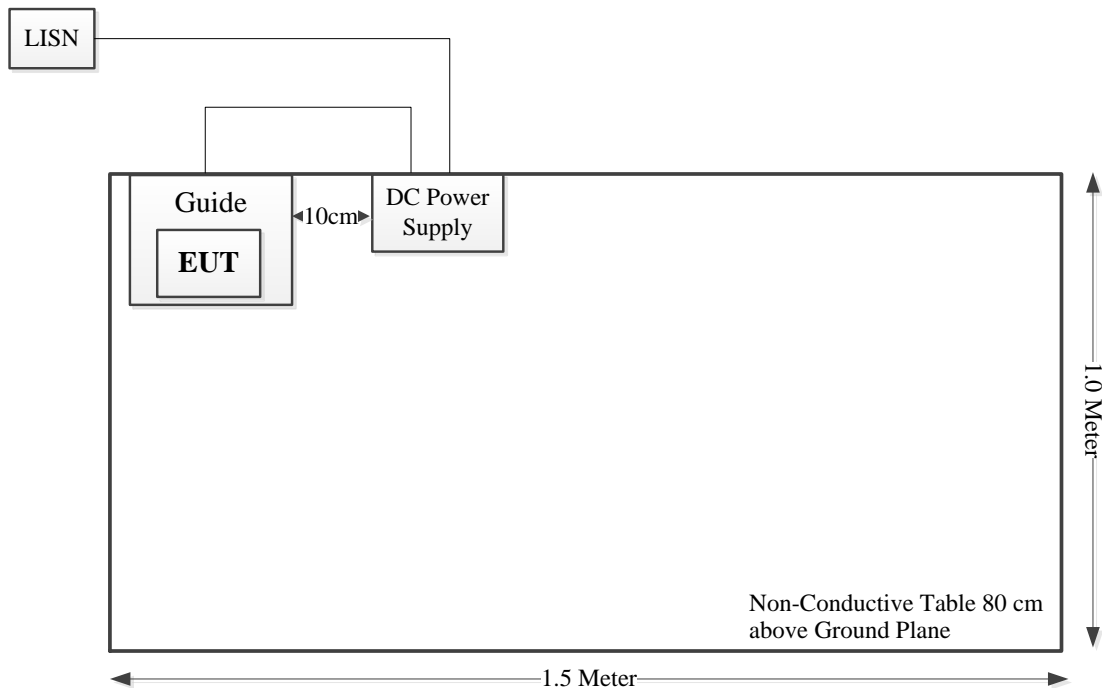

Radiation spurious emissions below 1G:

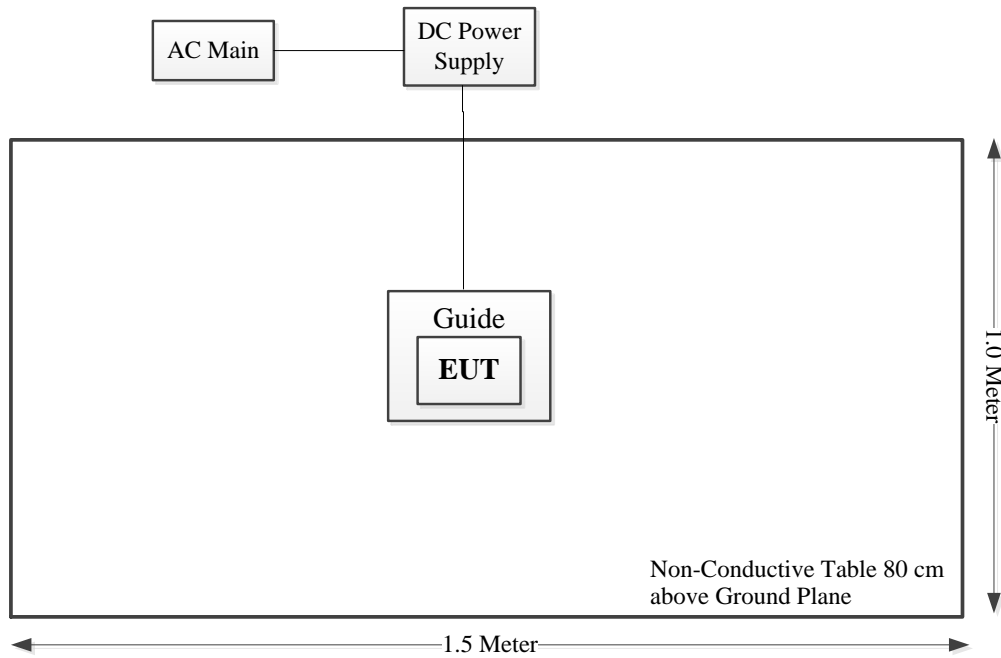

Radiation spurious emissions above 1G:

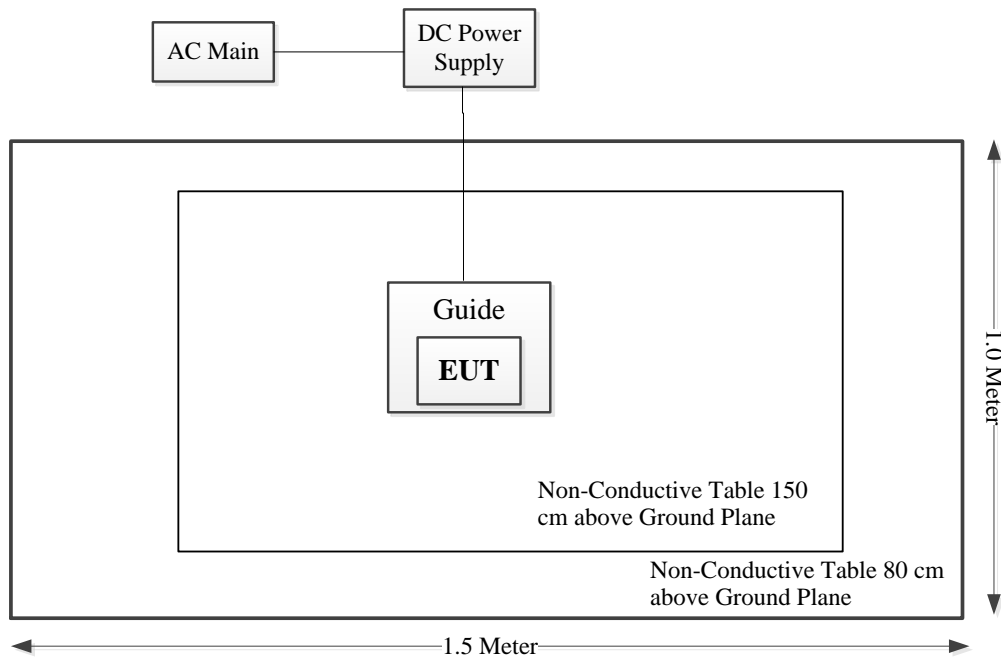

1.3 Measurement Uncertainty

Otherwise required by the applicant or Product Regulations, Decision Rule in this report did not consider the uncertainty. The extended uncertainty given in this report is obtained by combining the standard uncertainty times the coverage factor K with the 95% confidence interval.

Parameter	Measurement Uncertainty
Occupied Channel Bandwidth	$\pm 5\%$
RF output power, conducted	$\pm 0.61\text{dB}$
Power Spectral Density, conducted	$\pm 0.61\text{dB}$
Unwanted Emissions, radiated	30M~200MHz: 4.15 dB, 200M~1GHz: 5.61 dB, 1G~6GHz: 5.14 dB, 6G~18GHz: 5.93 dB, 18G~26.5G: 5.47 dB, 26.5G~40G: 5.63 dB
Unwanted Emissions, conducted	$\pm 1.26\text{dB}$
Temperature	$\pm 1^\circ\text{C}$
Humidity	$\pm 5\%$
DC and low frequency voltages	$\pm 0.4\%$
Duty Cycle	1%
AC Power Lines Conducted Emission	2.8 dB (150 kHz to 30 MHz)

2. SUMMARY OF TEST RESULTS

FCC Rules	Description of Test	Result
FCC §15.207(a)	AC line conducted emissions	Compliance
FCC §15.205, §15.209, §15.245	Radiation Spurious Emissions	Compliance
FCC §15.215 (c)	20 dB Bandwidth	Compliance
FCC §15.203	Antenna requirement	Compliance

3. REQUIREMENTS AND TEST PROCEDURES

3.1 AC Line Conducted Emissions

3.1.1 Applicable Standard

FCC §15.207(a).

(a) Except as shown in paragraphs (b) and (c) of this section, for an intentional radiator that is designed to be connected to the public utility (AC) power line, the radio frequency voltage that is conducted back onto the AC power line on any frequency or frequencies, within the band 150 kHz to 30 MHz, shall not exceed the limits in the following table, as measured using a 50 μ H/50 ohms line impedance stabilization network (LISN). Compliance with the provisions of this paragraph shall be based on the measurement of the radio frequency voltage between each power line and ground at the power terminal. The lower limit applies at the boundary between the frequency ranges.

Frequency of emission (MHz)	Conducted limit (dB μ V)	
	Quasi-peak	Average
0.15-0.5	66 to 56*	56 to 46*
0.5-5	56	46
5-30	60	50

*Decreases with the logarithm of the frequency.

(b) The limit shown in paragraph (a) of this section shall not apply to carrier current systems operating as intentional radiators on frequencies below 30 MHz. In lieu thereof, these carrier current systems shall be subject to the following standards:

- (1) For carrier current system containing their fundamental emission within the frequency band 535-1705 kHz and intended to be received using a standard AM broadcast receiver: no limit on conducted emissions.
- (2) For all other carrier current systems: 1000 μ V within the frequency band 535-1705 kHz, as measured using a 50 μ H/50 ohms LISN.
- (3) Carrier current systems operating below 30 MHz are also subject to the radiated emission limits in §15.205, §15.209, §15.221, §15.223, or §15.227, as appropriate.

(c) Measurements to demonstrate compliance with the conducted limits are not required for devices which only employ battery power for operation and which do not operate from the AC power lines or contain provisions for operation while connected to the AC power lines. Devices that include, or make provisions for, the use of battery chargers which permit operating while charging, AC adapters or battery eliminators or that connect to the AC power lines indirectly, obtaining their power through another device which is connected to the AC power lines, shall be tested to demonstrate compliance with the conducted limits.

3.1.2 EUT Setup

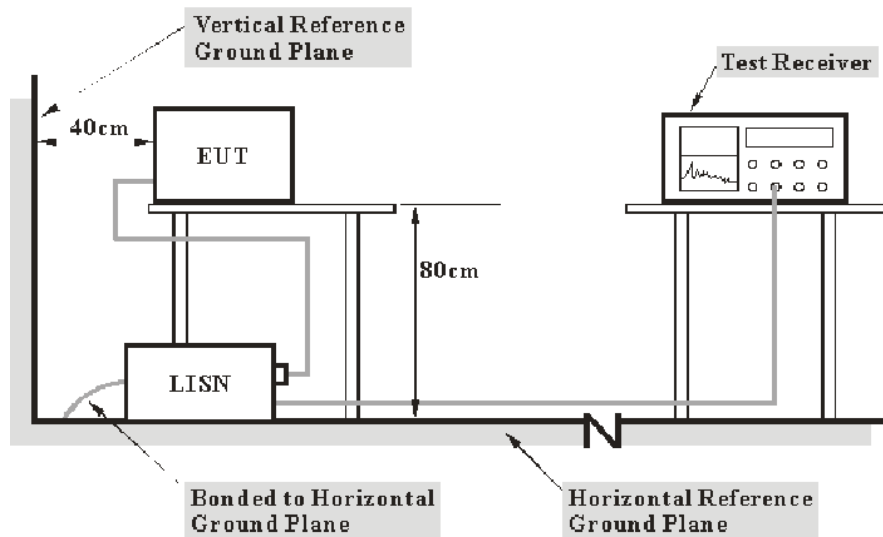

- Note: 1. Support units were connected to second LISN.
 2. Both of LISNs (AMN) 80 cm from EUT and at the least 80 cm from other units and other metal planes support units.

The setup of EUT is according with per ANSI C63.10-2013 measurement procedure. The specification used was with the FCC Part 15.207 limits.

The spacing between the peripherals was 10 cm.

The DC power supply was connected to the main LISN with a 120 V/60 Hz AC power source.

3.1.3 EMI Test Receiver Setup

The EMI test receiver was set to investigate the spectrum from 150 kHz to 30 MHz.

During the conducted emission test, the EMI test receiver was set with the following configurations:

Frequency Range	IF B/W
150 kHz – 30 MHz	9 kHz

3.1.4 Test Procedure

The frequency and amplitude of the six highest ac power-line conducted emissions relative to the limit, measured over all the current-carrying conductors of the EUT power cords, and the operating frequency or frequency to which the EUT is tuned (if appropriate), should be reported, unless such emissions are more than 20 dB below the limit. AC power-line conducted emissions measurements are to be separately carried out only on each of the phase (“hot”) line(s) and (if used) on the neutral line(s), but not on the ground [protective earth] line(s). If less than six emission frequencies are within 20 dB of the limit, then the noise level of the measuring instrument at representative frequencies should be reported. The specific conductor of the power-line cord for each of the reported emissions should be identified. Measure the six highest emissions with respect to the limit on each current-carrying conductor of each power cord associated with the EUT (but not the power cords of associated or peripheral equipment that are part of the test configuration). Then, report the six highest emissions with respect to the limit from among all the measurements identifying the frequency and specific current-carrying conductor identified with the emission. The six highest emissions should be reported for each of the current-carrying conductors, or the six highest emissions may be reported over all the current-carrying conductors.

3.1.5 Corrected Amplitude & Margin Calculation

The basic equation is as follows:

Result = Reading + Factor

Factor = attenuation caused by cable loss + voltage division factor of AMN

The “**Margin**” column of the following data tables indicates the degree of compliance within the applicable limit. The equation for margin calculation is as follows:

Margin = Limit – Result

3.2 Radiation Spurious Emissions

3.2.1 Applicable Standard

FCC §15.245 (b);

The field strength of emissions from intentional radiators operated within these frequency bands shall comply with the following:

Fundamental frequency (MHz)	Field strength of fundamental (millivolts/meter)	Field strength of harmonics (millivolts/meter)
902-928	500	1.6
2435-2465	500	1.6
5785-5815	500	1.6
10500-10550	2500	25.0
24075-24175	2500	25.0

(1) Regardless of the limits shown in the above table, harmonic emissions in the restricted bands below 17.7 GHz, as specified in §15.205, shall not exceed the field strength limits shown in §15.209. Harmonic emissions in the restricted bands at and above 17.7 GHz shall not exceed the following field strength limits:

(i) For the second and third harmonics of field disturbance sensors operating in the 24075-24175 MHz band and for other field disturbance sensors designed for use only within a building or to open building doors, 25.0 mV/m.

(ii) For all other field disturbance sensors, 7.5 mV/m.

(iii) Field disturbance sensors designed to be used in motor vehicles or aircraft must include features to prevent continuous operation unless their emissions in the restricted bands, other than the second and third harmonics from devices operating in the 24075-24175 MHz band, fully comply with the limits given in §15.209. Continuous operation of field disturbance sensors designed to be used in farm equipment, vehicles such as fork lifts that are intended primarily for use indoors or for very specialized operations, or railroad locomotives, railroad cars and other equipment which travels on fixed tracks is permitted. A field disturbance sensor will be considered not to be operating in a continuous mode if its operation is limited to specific activities of limited duration (e.g., putting a vehicle into reverse gear, activating a turn signal, etc.).

(2) Field strength limits are specified at a distance of 3 meters.

(3) Emissions radiated outside of the specified frequency bands, except for harmonics, shall be attenuated by at least 50 dB below the level of the fundamental or to the general radiated emission limits in §15.209, whichever is the lesser attenuation.

(4) The emission limits shown above are based on measurement instrumentation employing an average detector. The provisions in §15.35 for limiting peak emissions apply.

3.2.2 EUT Setup

Below 1GHz:

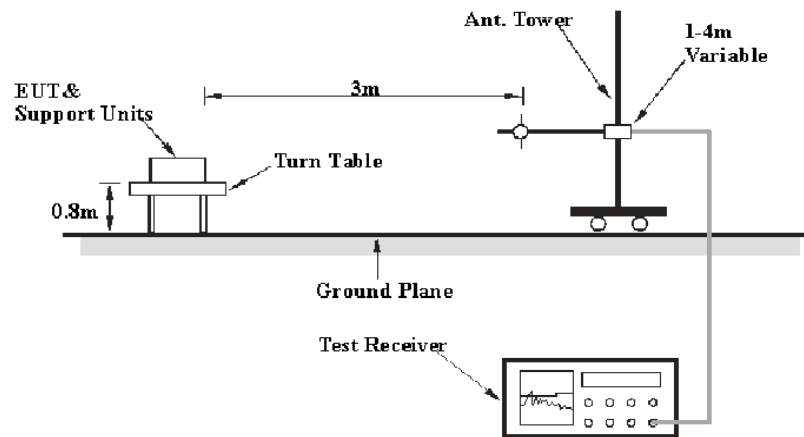

1-26.5 GHz:

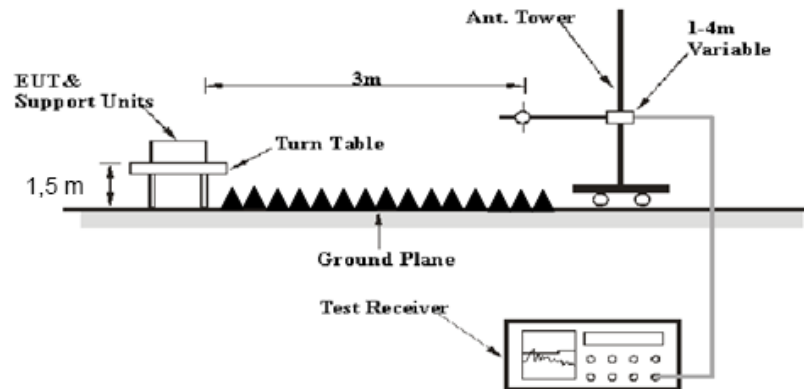

26.5-40 GHz:

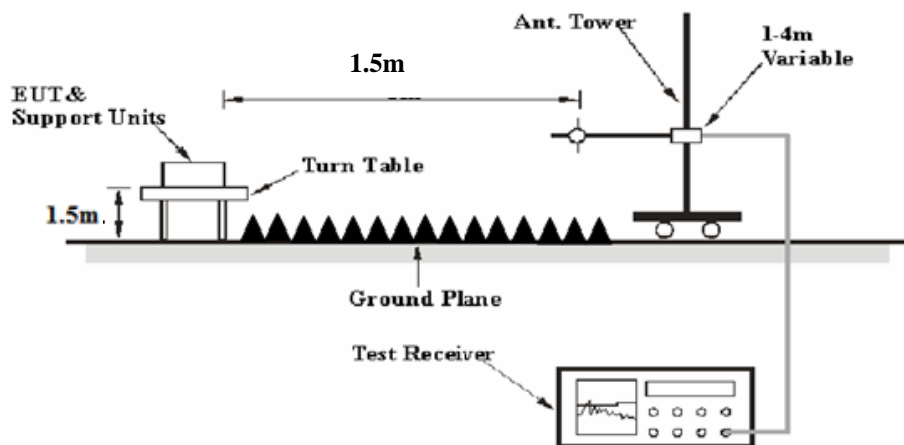

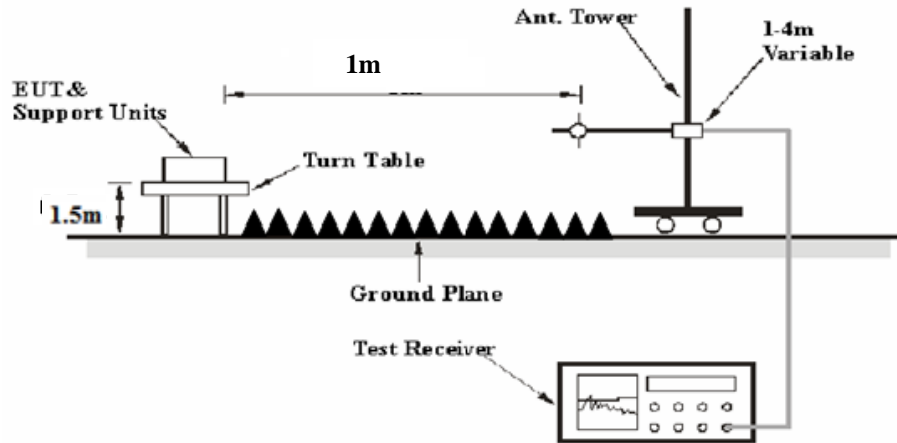
40-60 GHz:

The radiated emission tests were performed in the 3 meters chamber test site, using the setup accordance with the ANSI C63.10-2013. The specification used was the FCC 15.209,15.205 and FCC 15.245 limits.

The external I/O cables were draped along the test table and formed a bundle 30 to 40 cm long in the middle.

The spacing between the peripherals was 10 cm.

3.2.3 EMI Test Receiver & Spectrum Analyzer Setup

The system was investigated from 30 MHz to 60GHz.

During the radiated emission test, the EMI test receiver & Spectrum Analyzer Setup were set with the following configurations:

Frequency Range	RBW	Video B/W	IF B/W	Measurement
30 MHz – 1000 MHz	120 kHz	300 kHz	120 kHz	QP
Above 1 GHz	1MHz	3 MHz	/	PK
	1MHz	10 Hz	/	AV

If the maximized peak measured value complies with under the QP/Average limit more than 6dB, then it is unnecessary to perform an QP/Average measurement.

3.2.4 Test Procedure

Maximizing procedure was performed on the highest emissions to ensure that the EUT complied with all installation combinations.

Data was recorded in Quasi-peak detection mode for frequency range of 30 MHz-1 GHz, peak and Average detection modes for frequencies above 1 GHz.

According to C63.10, the 26.5- 60GHz test result shall be extrapolated to the specified distance using an extrapolation factor of 20dB/decade from 3m to 1.5m, 1m

For 26.5-40GHz

Distance extrapolation factor = $20 \log (\text{specific distance [3m]}/\text{test distance [1.5m]})$ dB=6.02dB

For 40-60GHz

Distance extrapolation factor = $20 \log (\text{specific distance [3m]}/\text{test distance [1m]})$ dB=9.54dB

For above 40GHz, external harmonic mixers are utilized. The antenna is scanned around the entire perimeter surface of the EUT, in both horizontal and vertical polarizations. The Mixers and it's RF cables is compose a system for calibration, the conversion factor was added into the test Spectrum Analyzer in testing.

3.2.5 Corrected Amplitude & Margin Calculation

The basic equation is as follows:

Factor = Antenna Factor + Cable Loss- Amplifier Gain

For 30MHz-26.5GHz:

Result = Reading + Factor

For 26.5GHz-60GHz

Result = Reading + Factor-Distance extrapolation Factor

The "Margin" column of the following data tables indicates the degree of compliance within the applicable limit. The equation for margin calculation is as follows:

Margin = Limit – Result

3.3 20 dB Bandwidth

3.3.1 Applicable Standard

FCC §15.215(c)

Intentional radiators operating under the alternative provisions to the general emission limits, as contained in §§ 15.217 through 15.257 and in Subpart E of this part, must be designed to ensure that the 20 dB bandwidth of the emission, or whatever bandwidth may otherwise be specified in the specific rule section under which the equipment operates, is contained within the frequency band designated in the rule section under which the equipment is operated.

3.3.2 EUT Setup

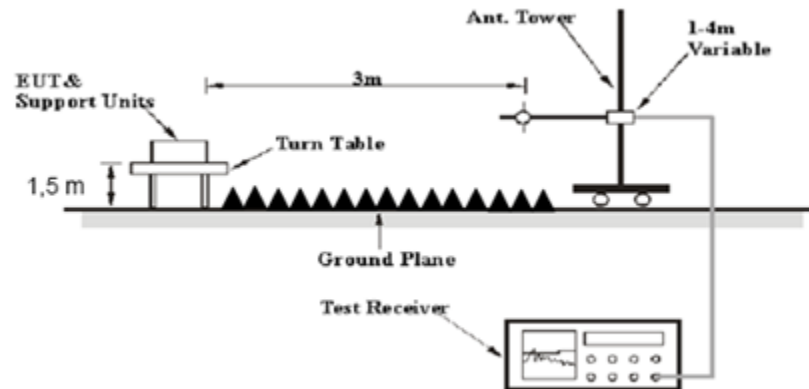

3.3.3 Test Procedure

Measure the frequency difference of two frequencies that were attenuated 20 dB from the reference level. Record the frequency difference as the emission bandwidth.

3.4 Antenna Requirement

3.4.1 Applicable Standard

FCC §15.203

An intentional radiator shall be designed to ensure that no antenna other than that furnished by the responsible party shall be used with the device. The use of a permanently attached antenna or of an antenna that uses a unique coupling to the intentional radiator shall be considered sufficient to comply with the provisions of this section. The manufacturer may design the unit so that a broken antenna can be replaced by the user, but the user of a standard antenna jack or electrical connector is prohibited. The structure and application of the EUT were analyzed to determine compliance with section §15.203 of the rules. §15.203 state that the subject device must meet the following criteria:

- a. Antenna must be permanently attached to the unit.
- b. Antenna must use a unique type of connector to attach to the EUT.
- c. Unit must be professionally installed, and installer shall be responsible for verifying that the correct antenna is employed with the unit.

3.4.2 Judgment

Please refer to the Antenna Information detail in Section 1.

4. TEST DATA AND RESULTS

4.1 AC Line Conducted Emissions

Serial Number:	CR220030057-RF-S1	Test Date:	2022-04-02
Test Site:	CE	Test Mode:	Transmitting
Tester:	Nick Tang	Test Result:	Pass

Environmental Conditions:

Temperature: (°C)	21.2	Relative Humidity: (%)	59	ATM Pressure: (kPa)	101.8
----------------------	------	------------------------------	----	------------------------	-------

Test Equipment List and Details:

Manufacturer	Description	Model	Serial Number	Calibration Date	Calibration Due Date
R&S	LISN	ENV216	101134	2021-04-25	2022-04-24
R&S	EMI Test Receiver	ESR3	102726	2021-07-22	2022-07-21
MICRO-COAX	Coaxial Cable	UTIFLEX	C-0200-01	2021-08-08	2022-08-07
Audix	Test Software	E3	190306 (V9)	N/A	N/A

* Statement of Traceability: China Certification ICT Co., Ltd (Dongguan) attests that all calibrations have been performed, traceable to National Primary Standards and International System of Units (SI).

Line:

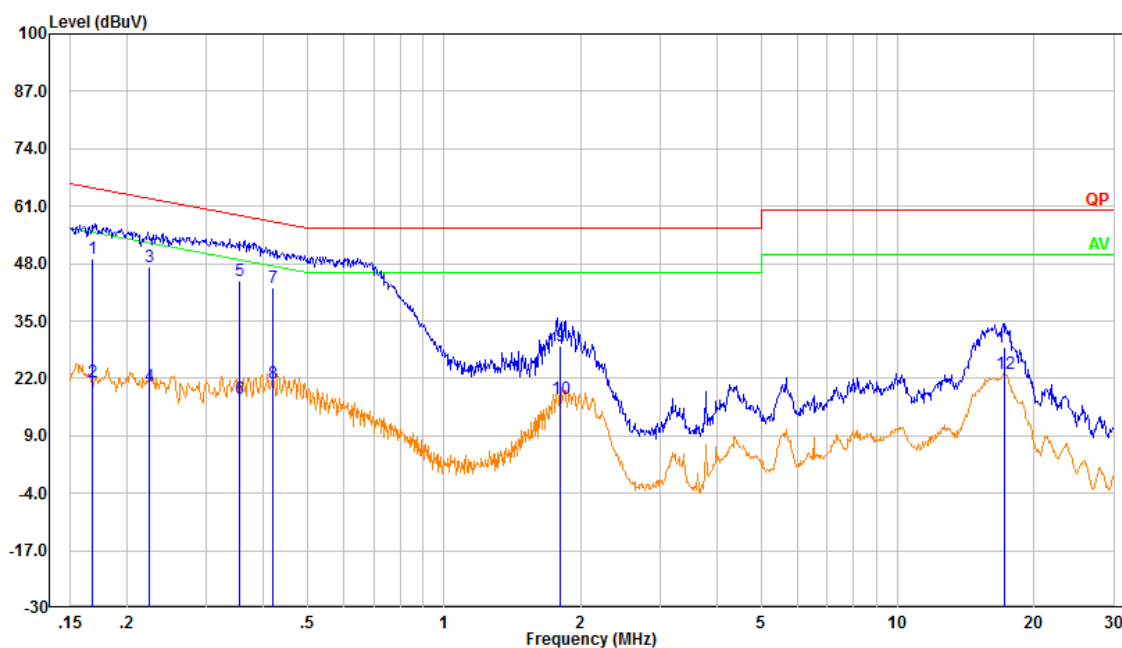

No.	Frequency (MHz)	Reading (dBμV)	Factor (dB)	Result (dBμV)	Limit (dBμV)	Margin (dB)	Detector
1	0.168	39.66	9.61	49.27	65.04	15.77	QP
2	0.168	11.46	9.61	21.07	55.04	33.97	Average
3	0.224	37.66	9.61	47.27	62.66	15.39	QP
4	0.224	10.76	9.61	20.37	52.66	32.29	Average
5	0.355	34.54	9.61	44.15	58.84	14.69	QP
6	0.355	7.87	9.61	17.48	48.84	31.36	Average
7	0.421	32.92	9.61	42.53	57.44	14.91	QP
8	0.421	11.35	9.61	20.96	47.44	26.48	Average
9	1.806	19.64	9.63	29.27	56.00	26.73	QP
10	1.806	7.84	9.63	17.47	46.00	28.53	Average
11	17.167	19.15	9.73	28.88	60.00	31.12	QP
12	17.167	13.18	9.73	22.91	50.00	27.09	Average

Neutral:

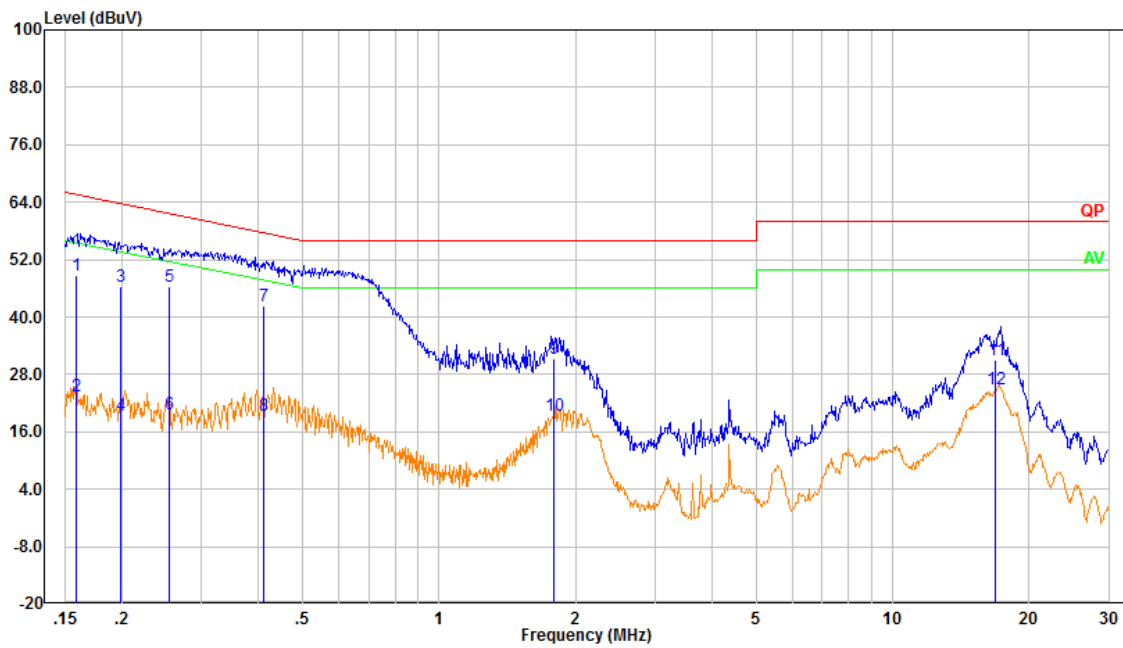

No.	Frequency (MHz)	Reading (dB μ V)	Factor (dB)	Result (dB μ V)	Limit (dB μ V)	Margin (dB)	Detector
1	0.158	39.08	9.61	48.69	65.55	16.86	QP
2	0.158	13.96	9.61	23.57	55.55	31.98	Average
3	0.199	36.86	9.61	46.47	63.66	17.19	QP
4	0.199	9.94	9.61	19.55	53.66	34.11	Average
5	0.255	36.65	9.61	46.26	61.59	15.33	QP
6	0.255	10.02	9.61	19.63	51.59	31.96	Average
7	0.412	32.71	9.61	42.32	57.60	15.28	QP
8	0.412	9.80	9.61	19.41	47.60	28.19	Average
9	1.793	21.74	9.63	31.37	56.00	24.63	QP
10	1.793	9.80	9.63	19.43	46.00	26.57	Average
11	16.890	21.35	9.69	31.04	60.00	28.96	QP
12	16.890	15.37	9.69	25.06	50.00	24.94	Average

4.2 Radiation Spurious Emissions

Serial Number:	CR220030057-RF-S1	Test Date:	2022-04-12~2022-04-18
Test Site:	966-1, 966-2	Test Mode:	Transmitting
Tester:	Veyo Zhang, Tommy Luo	Test Result:	Pass

Environmental Conditions:

Temperature: (°C)	23.1~25	Relative Humidity: (%)	59~64	ATM Pressure: (kPa)	100.4~101.1
----------------------	---------	------------------------------	-------	------------------------	-------------

Test Equipment List and Details:

Manufacturer	Description	Model	Serial Number	Calibration Date	Calibration Due Date
Sunol Sciences	Antenna	JB6	A082520-5	2020-10-19	2023-10-18
R&S	EMI Test Receiver	ESR3	102724	2021-07-22	2022-07-21
TIMES MICROWAVE	Coaxial Cable	LMR-600-UltraFlex	C-0470-02	2021-07-18	2022-07-17
TIMES MICROWAVE	Coaxial Cable	LMR-600-UltraFlex	C-0780-01	2021-07-18	2022-07-17
Sonoma	Amplifier	310N	186165	2021-07-18	2022-07-17
Audix	Test Software	E3	201021 (V9)	N/A	N/A
ETS-Lindgren	Horn Antenna	3115	9912-5985	2020-10-13	2023-10-12
R&S	Spectrum Analyzer	FSV40	101591	2021-07-22	2022-07-21
MICRO-COAX	Coaxial Cable	UFA210A-1-1200-70U300	217423-008	2021-08-08	2022-08-07
MICRO-COAX	Coaxial Cable	UFA210A-1-2362-300300	235780-001	2021-08-08	2022-08-07
Mini	Pre-amplifier	ZVA-183-S+	5969001149	2021-11-10	2022-11-09
Audix	Test Software	E3	201021 (V9)	N/A	N/A
PASTERNAK	Horn Antenna	PE9852/2F-20	112002	2021-02-05	2024-02-04
AH	Preamplifier	PAM-1840VH	190	2021-11-19	2022-11-18
MICRO-COAX	Coaxial Cable	UFB142A-1-2362-200200	235772-001	2021-08-08	2022-08-07
PASTERNAK	Horn Antenna	PE9850/2F-20	072001	2021-02-05	2024-02-04
OML	Harmonic Mixer	WR19/M19HWD	U60314-1	2020-10-16	2023-10-15
OML	Horn Antenna	M19RH	11648-03	2020-10-16	2023-10-15

* Statement of Traceability: China Certification ICT Co., Ltd (Dongguan) attests that all calibrations have been performed, traceable to National Primary Standards and International System of Units (SI).

1) 30MHz-1GHz(Low channel was the worst)

Horizontal:

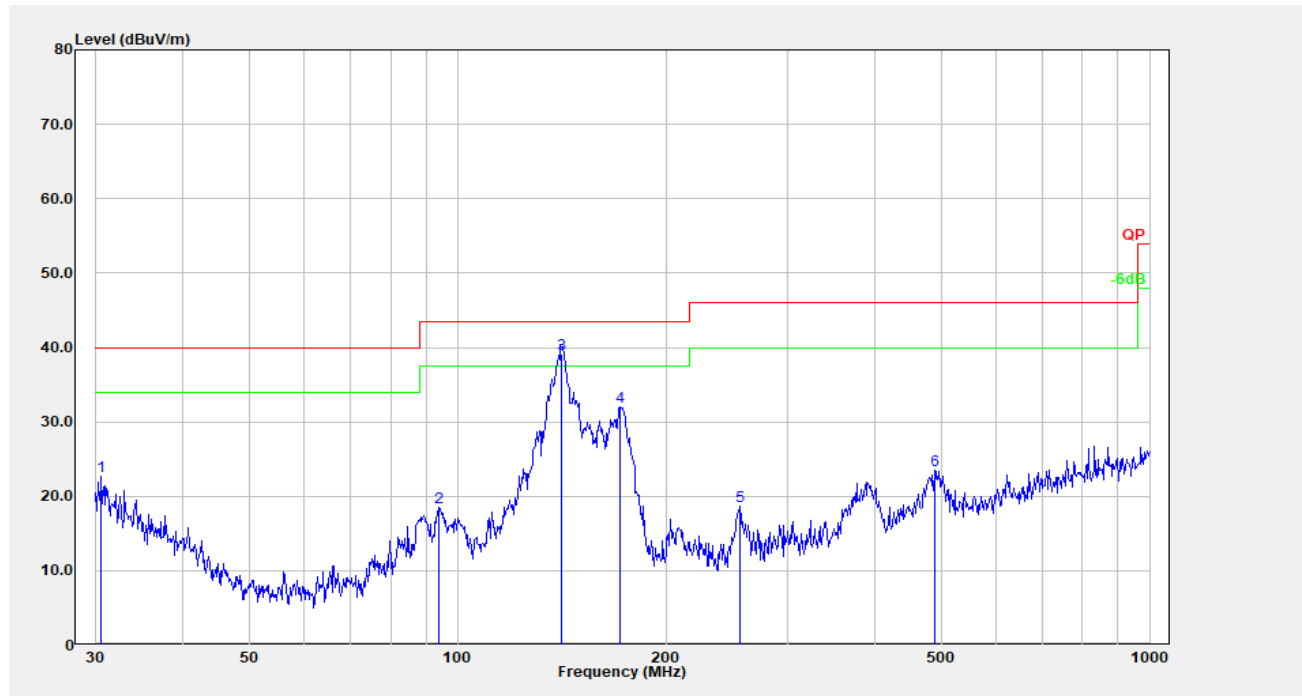

No.	Frequency (MHz)	Reading (dB μ V)	Factor (dB/m)	Result (dB μ V/m)	Limit (dB μ V/m)	Margin (dB)	Detector
1	30.531	26.88	-4.20	22.68	40.00	17.32	Peak
2	94.098	34.66	-16.14	18.52	43.50	24.98	Peak
3	141.117	51.27	-12.19	39.08	43.50	4.42	QP
4	171.995	45.37	-13.30	32.07	43.50	11.43	Peak
5	255.623	31.53	-12.94	18.59	46.00	27.41	Peak
6	489.027	30.06	-6.50	23.56	46.00	22.44	Peak

Vertical:

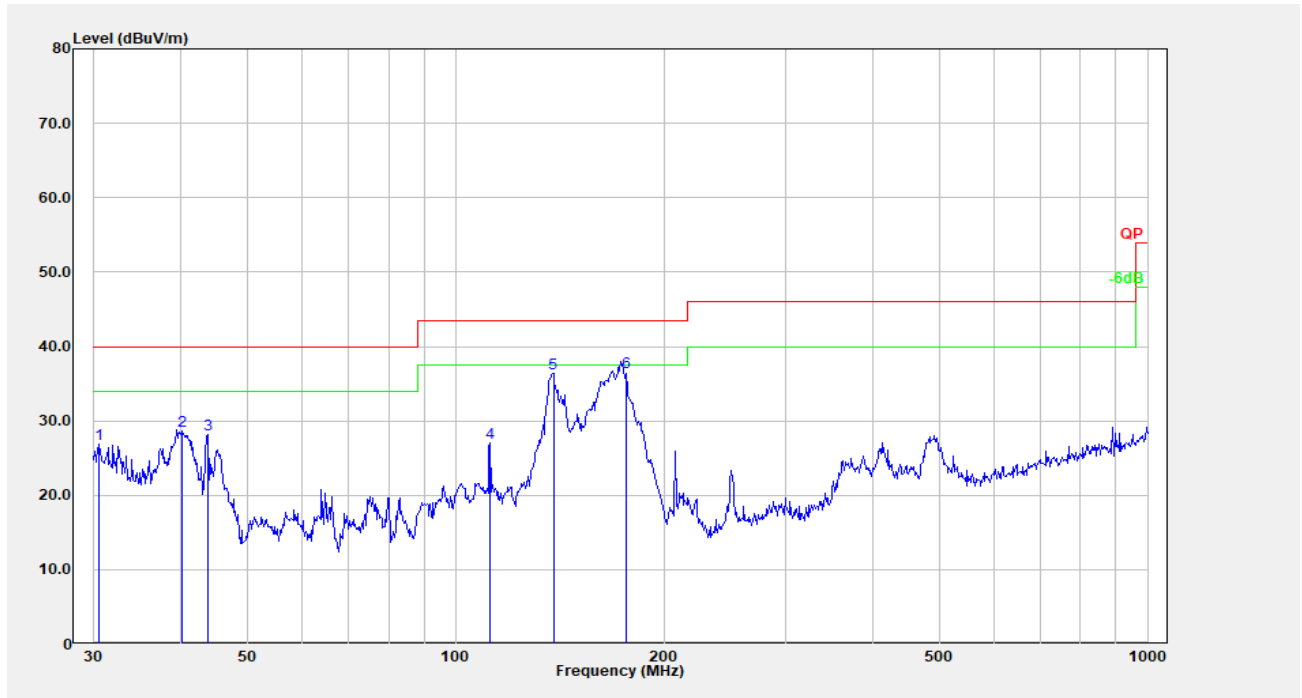

No.	Frequency (MHz)	Reading (dB μ V)	Factor (dB/m)	Result (dB μ V/m)	Limit (dB μ V/m)	Margin (dB)	Detector
1	30.531	31.07	-4.20	26.87	40.00	13.13	Peak
2	40.135	40.30	-11.60	28.70	40.00	11.30	Peak
3	43.812	41.96	-13.80	28.17	40.00	11.83	Peak
4	112.131	39.36	-12.40	26.97	43.50	16.53	Peak
5	138.387	48.51	-12.06	36.44	43.50	7.06	Peak
6	176.022	49.97	-13.50	36.47	43.50	7.03	QP

2) 1-40GHz:

Frequency (MHz)	Receiver		Polar (H/V)	Factor (dB/m)	Result (dB μ V/m)	Limit (dB μ V/m)	Margin (dB)
	Reading (dB μ V)	Detector					
Test Channel: 10525 MHz							
10525.00	69.09	PK	H	18.96	88.05	147.96	59.91
10525.00	60.29	AV	H	18.96	79.25	127.96	48.71
10525.00	73.69	PK	V	18.96	92.65	147.96	55.31
10525.00	64.94	AV	V	18.96	83.90	127.96	44.06
10500.00	46.10	PK	V	18.79	64.89	74.00	9.11
10500.00	34.65	AV	V	18.79	53.44	54.00	0.56
10550.00	43.58	PK	V	19.14	62.72	74.00	11.28
10550.00	32.04	AV	V	19.14	51.18	54.00	2.82
21050.00	48.48	PK	V	8.36	56.84	107.96	51.12
21050.00	35.82	AV	V	8.36	44.18	87.96	43.78
31575.00	49.18	PK	V	15.93	59.09	107.96	48.87
31575.00	37.36	AV	V	15.93	47.27	87.96	40.69

Note:

Result = Reading + Factor- Distance extrapolation Factor

For 26.5-40GHz:

Distance extrapolation Factor = $20 \log (\text{specific distance [3m]}/\text{test distance [1.5m]})$ dB = 6.02 dB

3) 40-60GHz:

Frequency (GHz)	Receiver		Polar (H/V)	Factor (dB/m)	Result (dB μ V/m)	Limit (dB μ V/m)	Margin (dB)
	Reading (dB μ V)	Detector					
Test Channel: 10.525 GHz							
42.10	43.32	PK	H	39.12	72.90	107.96	35.06
42.10	31.26	AV	H	39.12	60.84	87.96	27.12
42.10	43.57	PK	V	39.12	73.15	107.96	34.81
42.10	31.48	AV	V	39.12	61.06	87.96	26.90
52.63	43.89	PK	H	40.76	75.11	107.96	32.85
52.63	21.74	AV	H	40.76	52.96	87.96	35.00
52.63	43.84	PK	V	40.76	75.06	107.96	32.90
52.63	21.71	AV	V	40.76	52.93	87.96	35.03

Note:

Result = Reading + Factor- Distance extrapolation Factor

For 40-60GHz:

Distance extrapolation Factor = $20 \log (\text{specific distance [3m]}/\text{test distance [1m]})$ dB= 9.54 dB

Worst Test plots
Horizontal:

Fundamental

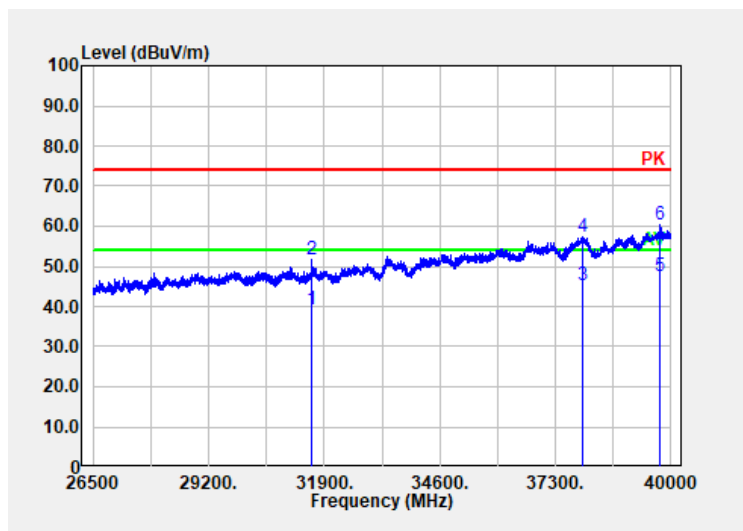
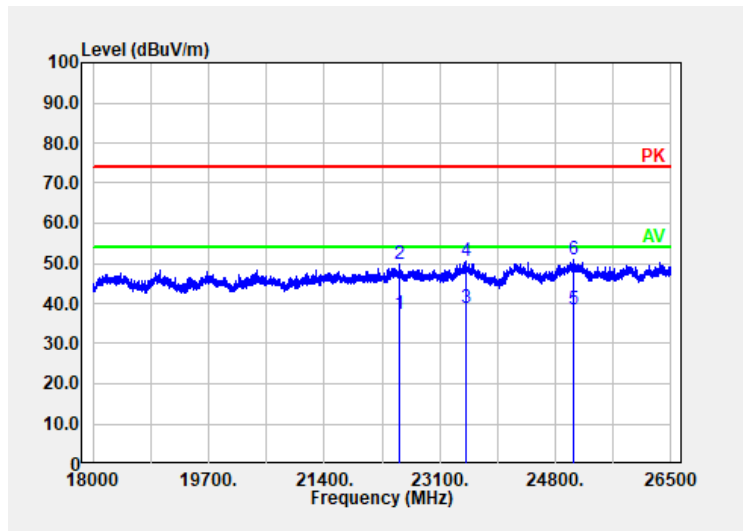
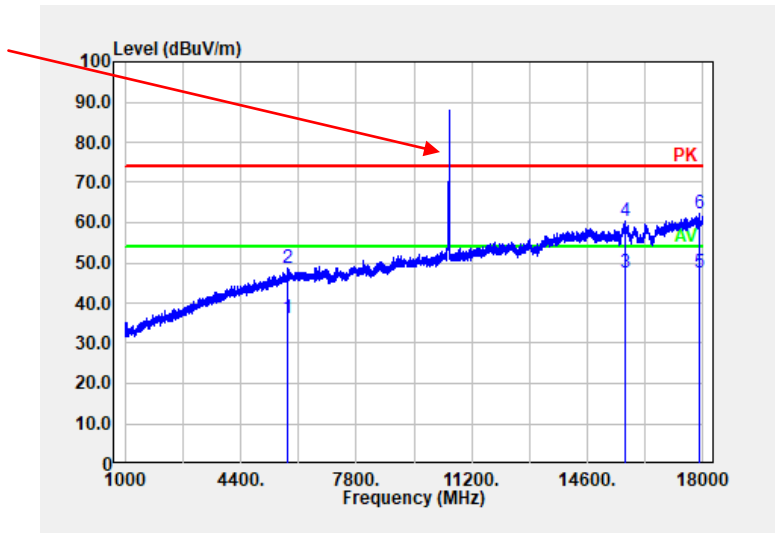

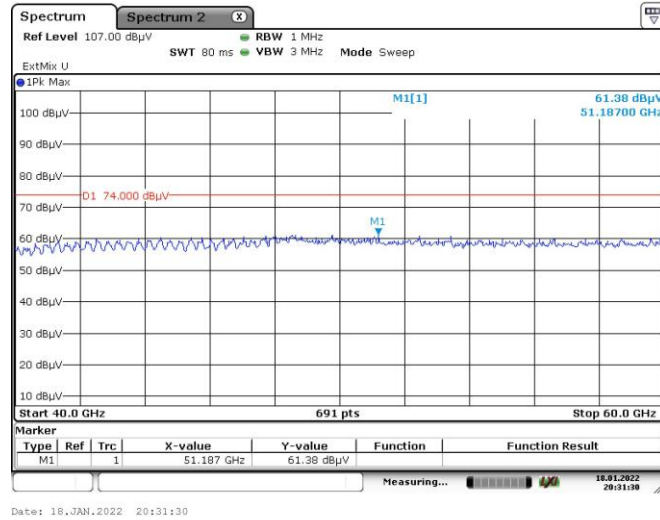

Vertical:

Fundamental

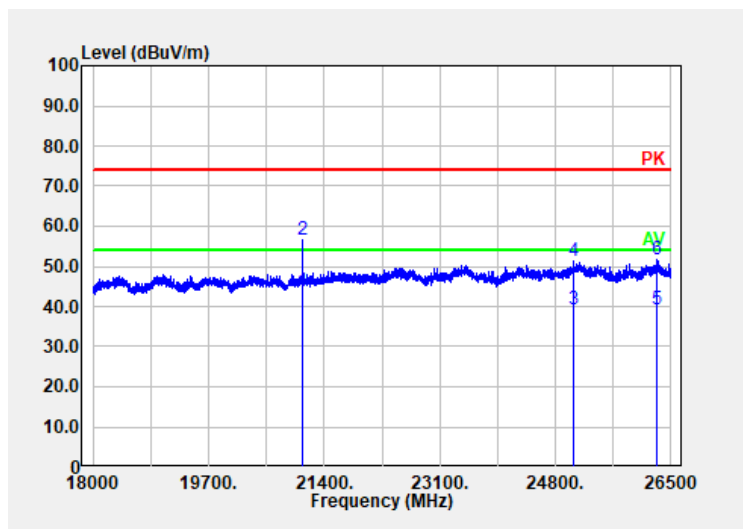
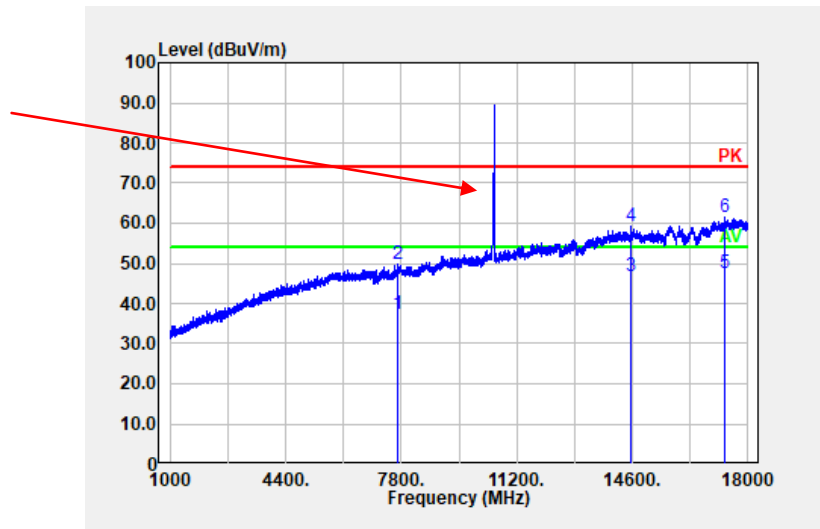

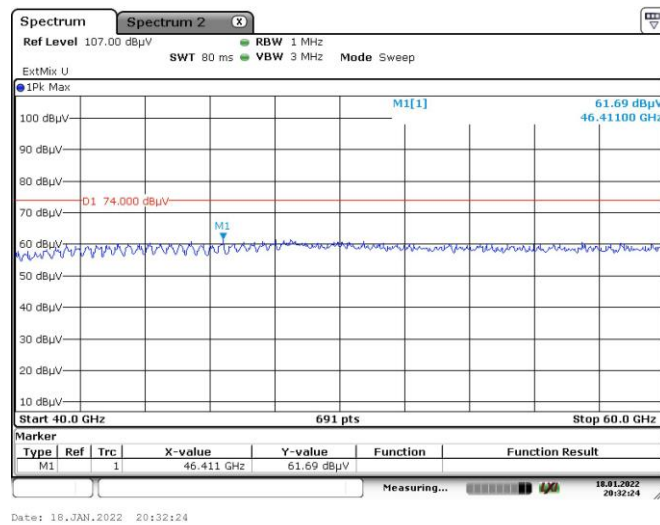
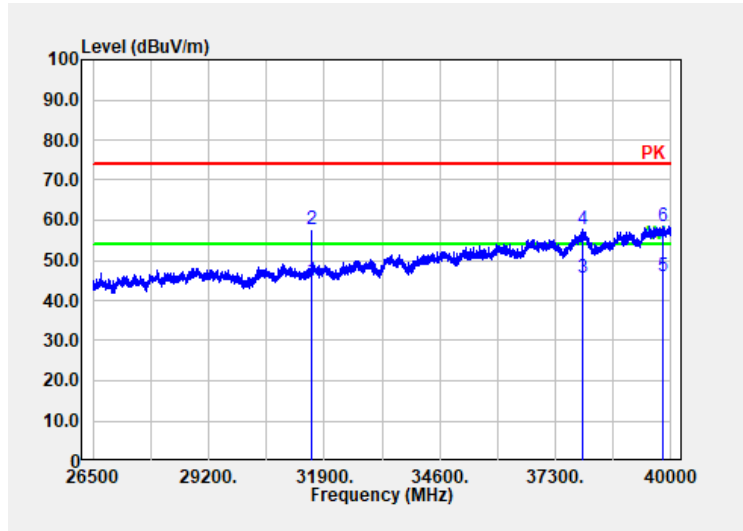

Date: 18.JAN.2022 20:32:24

4.3 20 dB Emission Bandwidth:

Serial Number:	CR220030057-RF-S1	Test Date:	2022-04-12
Test Site:	966-1	Test Mode:	Transmitting
Tester:	Tommy Luo	Test Result:	N/A

Environmental Conditions:

Temperature: (°C)	23.1	Relative Humidity: (%)	59	ATM Pressure: (kPa)	101.1
----------------------	------	---------------------------	----	------------------------	-------

Test Equipment List and Details:

Manufacturer	Description	Model	Serial Number	Calibration Date	Calibration Due Date
R&S	Spectrum Analyzer	FSV40	101591	2021-07-22	2022-07-21
ETS-Lindgren	Horn Antenna	3115	9912-5985	2020-10-13	2023-10-12
MICRO-COAX	Coaxial Cable	UFA210A-1-1200-70U300	217423-008	2021-08-08	2022-08-07
MICRO-COAX	Coaxial Cable	UFA210A-1-2362-300300	235780-001	2021-08-08	2022-08-07
Mini	Pre-amplifier	ZVA-183-S+	5969001149	2021-11-10	2022-11-09

** Statement of Traceability: China Certification ICT Co., Ltd (Dongguan) attests that all calibrations have been performed, traceable to National Primary Standards and International System of Units (SI).*

Test Data:

Test Frequency (MHz)	20 dB Bandwidth (MHz)
10525	18.510

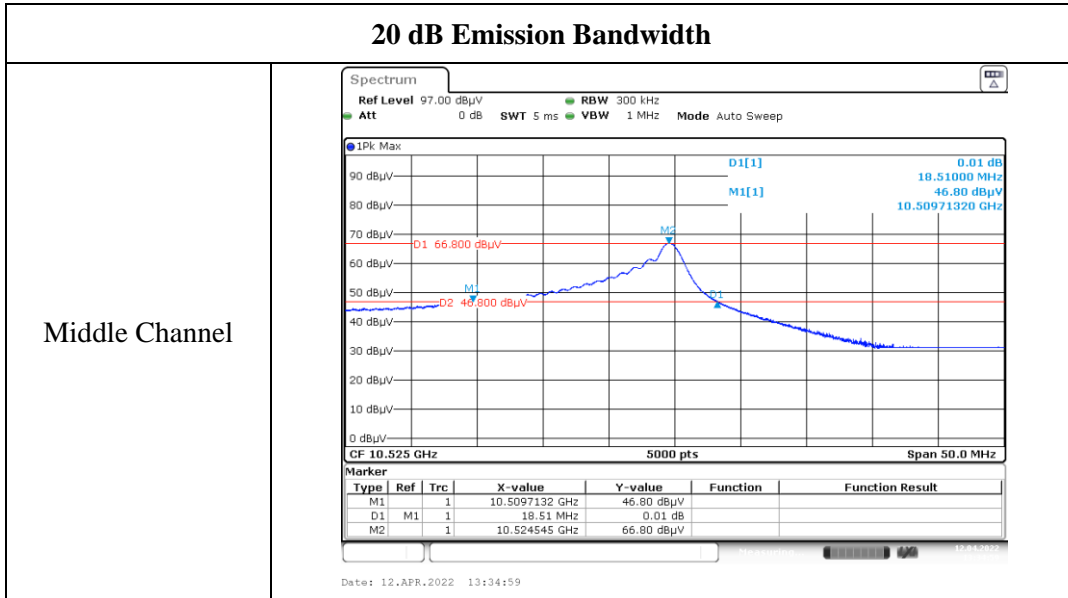

******* END OF REPORT *******