

FCC Test Report

SmartSky Networks. LLC
ABR Transceiver, Model: Not Applicable

In accordance with FCC 47 CFR Part 15B
(2.4 GHz Transmitter)

Prepared for: SmartSky Networks. LLC
430 Davis Drive
Suite 350
Morrisville
NC, 27560, USA



Add value.
Inspire trust.

FCC ID: 2APND-ABR2

COMMERCIAL-IN-CONFIDENCE

Document 75955247-01 Issue 01

SIGNATURE

NAME	JOB TITLE	RESPONSIBLE FOR	ISSUE DATE
Andrew Lawson	Chief Engineer, EMC	Authorised Signatory	25 October 2022

Signatures in this approval box have checked this document in line with the requirements of TÜV SÜD document control rules.

ENGINEERING STATEMENT

The measurements shown in this report were made in accordance with the procedures described on test pages. All reported testing was carried out on a sample equipment to demonstrate limited compliance with FCC 47 CFR Part 15B. The sample tested was found to comply with the requirements defined in the applied rules.

RESPONSIBLE FOR	NAME	DATE	SIGNATURE
Testing	Graeme Lawler	25 October 2022	

FCC Accreditation
90987 Octagon House, Fareham Test Laboratory

EXECUTIVE SUMMARY

A sample of this product was tested and found to be compliant with FCC 47 CFR Part 15B: 2020 for the tests detailed in section 1.3.



DISCLAIMER AND COPYRIGHT

This non-binding report has been prepared by TÜV SÜD with all reasonable skill and care. The document is confidential to the potential Client and TÜV SÜD. No part of this document may be reproduced without the prior written approval of TÜV SÜD. © 2022 TÜV SÜD. This report relates only to the actual item/items tested.

ACCREDITATION

Our UKAS Accreditation does not cover opinions and interpretations and any expressed are outside the scope of our UKAS Accreditation. Results of tests not covered by our UKAS Accreditation Schedule are marked NUA (Not UKAS Accredited).

TÜV SÜD
is a trading name of TÜV SÜD Ltd
Registered in Scotland at East Kilbride,
Glasgow G75 0QF, United Kingdom
Registered number: SC215164

TÜV SÜD Ltd is a
TÜV SÜD Group Company

Phone: +44 (0) 1489 558100
Fax: +44 (0) 1489 558101
www.tuvsud.com/en

TÜV SÜD
Octagon House
Concorde Way
Fareham
Hampshire PO15 5RL
United Kingdom

TÜV SÜD



Contents

1	Report Summary	2
1.1	Report Modification Record.....	2
1.2	Introduction.....	2
1.3	Brief Summary of Results	3
1.4	Declaration of Build Status	4
1.5	Product Information	7
1.6	Deviations from the Standard.....	8
1.7	EUT Modification Record	8
1.8	Test Location	8
2	Test Details	9
2.1	Radiated Disturbance.....	9
3	Test Equipment Information	22
3.1	General Test Equipment Used.....	22
4	Incident Reports	23
5	Measurement Uncertainty	24



1 Report Summary

1.1 Report Modification Record

Alterations and additions to this report will be issued to the holders of each copy in the form of a complete document.

Issue	Description of Change	Date of Issue
1	First Issue	25 October 2022

Table 1

1.2 Introduction

Applicant	SmartSky Networks. LLC
Manufacturer	Avidyne, Inc.
Model Number(s)	Not Applicable
Serial Number(s)	1819V0007
Hardware Version(s)	G
Software Version(s)	Rocket 3.8.18
Number of Samples Tested	1
Test Specification/Issue/Date	FCC 47 CFR Part 15B: 2020
Order Number	76011
Date	28-March-2022
Date of Receipt of EUT	13-May-2022
Start of Test	19-July-2022
Finish of Test	24-July-2022
Name of Engineer(s)	Graeme Lawler
Related Document(s)	ANSI C63.4: 2014



1.3 Brief Summary of Results

A brief summary of the tests carried out in accordance with FCC 47 CFR Part 15B is shown below.

Section	Specification Clause	Test Description	Result	Comments/Base Standard
Configuration and Mode: DC Powered - Idle				
2.1	15.109	Radiated Disturbance	Pass	ANSI C63.4: 2014

Table 2



1.4 Declaration of Build Status

Equipment Description

Technical Description: <i>(Please provide a brief description of the intended use of the equipment including the technologies the product supports)</i>	The EUT is an air based 2.4GHz transceiver intended to communicate with ground stations	
Manufacturer:	Avidyne, Inc.	
Model:	N/A	
Part Number:	3243489-201	
Hardware Version:	G	
Software Version:	Rocket 3.8.18	
FCC ID of the product under test – see guidance here	2APND-ABR2	
IC ID of the product under test – see guidance here	N/A	

Table 3

Intentional Radiators

Technology	LTE-based	LTE-based	LTE-based
Frequency Range (MHz to MHz)	2410.3 to 2435.3	2412.8 to 2432.8	2408.57 to 2437.03
Conducted Declared Output Power (dBm)	30 (with no cable loss) 33 (with 3dB cable loss)	30 (with no cable loss) 33 (with 3dB cable loss)	30 (with no cable loss) 33 (with 3dB cable loss)
Antenna Gain (dBi)	4.25 or 6.08	4.25 or 6.08	4.25 or 6.08
Supported Bandwidth(s) (MHz) (e.g. 1 MHz, 20 MHz, 40 MHz)	5MHz nominal (4.5 MHz actual)	10MHz nominal (9 MHz actual)	540kHz
Modulation Scheme(s) (e.g. GFSK, QPSK etc)	QPSK, QAM-16	QPSK, QAM-16	QPSK, QAM-16
ITU Emission Designator (see guidance here) (not mandatory for Part 15 devices)	N/A	N/A	N/A
Bottom Frequency (MHz)	2410.3	2412.8	2408.57
Middle Frequency (MHz)	2420.3 or 2425.3	2422.8	2422.8
Top Frequency (MHz)	2435.3	2432.8	2437.03

Table 4

Un-intentional Radiators

Highest frequency generated or used in the device or on which the device operates or tunes	9893 MHz
Lowest frequency generated or used in the device or on which the device operates or tunes	200kHz
Class A Digital Device (Use in commercial, industrial or business environment) <input checked="" type="checkbox"/>	
Class B Digital Device (Use in residential environment only) <input type="checkbox"/>	

Table 5



AC Power Source

AC supply frequency:	N/A	Hz
Voltage	N/A	V
Max current:	N/A	A
Single Phase <input type="checkbox"/> Three Phase <input type="checkbox"/>		

Table 6

DC Power Source

Nominal voltage:	28	V
Extreme upper voltage:	32	V
Extreme lower voltage:	22	V
Max current:	9	A

Table 7

Battery Power Source

Voltage:	N/A	V
End-point voltage:	N/A	V (Point at which the battery will terminate)
Alkaline <input type="checkbox"/> Leclanche <input type="checkbox"/> Lithium <input type="checkbox"/> Nickel Cadmium <input type="checkbox"/> Lead Acid* <input type="checkbox"/> *(Vehicle regulated)		
Other <input type="checkbox"/>	Please detail:	

Table 8

Charging

Can the EUT transmit whilst being charged	Yes <input type="checkbox"/> No <input checked="" type="checkbox"/>
---	---

Table 9

Temperature

Minimum temperature:	-55	°C
Maximum temperature:	70	°C

Table 10

Cable Loss

Adapter Cable Loss (Conducted sample)	3.2	dB
---------------------------------------	-----	----

Table 11



Antenna Characteristics

Antenna connector <input checked="" type="checkbox"/>		State impedance	50	Ohm
Temporary antenna connector <input type="checkbox"/>		State impedance		Ohm
Integral antenna <input type="checkbox"/>	Type:		Gain	dBi
External antenna <input checked="" type="checkbox"/>	Type:	2 part phased array	Gain	4.25 or 6.08 dBi
For external antenna only: Standard Antenna Jack <input type="checkbox"/> If yes, describe how user is prohibited from changing antenna (if not professional installed): Equipment is only ever professionally installed <input checked="" type="checkbox"/> Non-standard Antenna Jack <input type="checkbox"/>				

Table 12

Ancillaries (if applicable)

Manufacturer:	Not supplied	Part Number:	
Model:		Country of Origin:	

Table 13

I hereby declare that the information supplied is correct and complete.

Name: Leah Ward
 Position held: DSP Engineer
 Date: 2021/01/10



1.5 Product Information

1.5.1 Technical Description

The EUT is an air based 2.4 GHz transceiver intended to communicate with ground stations.

1.5.2 EUT Port/Cable Identification

Port	Max Cable Length specified	Usage	Type	Screened
Configuration and Mode: DC Powered - Idle				
ABR to FDQ Antenna	9.4 m	Control & Power Line for FDQ Antenna	Control Line for FDQ Antenna	Yes
ABR to HPB Antenna	9.4 m	Control & Power for HPB Antenna	Control Line for HPB Antenna	Yes
ABR to HPB Antenna Rx1	2.6 m	Connection of ABR to Rx1 CH-B on HPB antenna	Signal Cable	Yes
ABR to HPB Antenna Rx2	2.6 m	Connection of ABR to Rx2 CH-A on HPB antenna	Signal Cable	Yes
ABR to HPB Antenna Rx3	2.6 m	Connection of ABR to Rx3 CH-C on HPB antenna	Signal Cable	Yes
ABR to FDQ Antenna Tx	7.0 m	Connection of ABR to Tx1 on FDQ antenna	Signal Cable	Yes
ABR to FDQ Antenna Rx	7.0 m	Connection of ABR to Rx1 on FDQ antenna	Signal Cable	Yes
GPS	Not Specified	Connection to GPS antenna	Signal Cable	Yes
DC Power	1.3 m	Connection of ABR to DC Power Supply	28V DC Power Line	Yes

Table 14

1.5.3 Test Configuration

Configuration	Description
DC Powered	The EUT was powered from a 28 V DC supply.

Table 15

1.5.4 Modes of Operation

Mode	Description
Idle	A call was established and then power to the RRH was removed forcing the ABR into an idle state. The antenna mode was Yagi. EUT current draw during testing was 4725 mA.

Table 16



1.6 Deviations from the Standard

No deviations from the applicable test standard were made during testing.

1.7 EUT Modification Record

The table below details modifications made to the EUT during the test programme.

The modifications incorporated during each test are recorded on the appropriate test pages.

Modification State	Description of Modification still fitted to EUT	Modification Fitted By	Date Modification Fitted
Model: Not Applicable, Serial Number: 1819V0007			
0	As supplied by the customer	Not Applicable	Not Applicable

Table 17

1.8 Test Location

TÜV SÜD conducted the following tests at our Fareham Test Laboratory.

Test Name	Name of Engineer(s)	Accreditation
Configuration and Mode: DC Powered - Idle		
Radiated Disturbance	Graeme Lawler	UKAS

Table 18

Office Address:

TÜV SÜD
Octagon House
Concorde Way
Fareham
Hampshire
PO15 5RL
United Kingdom



2 Test Details

2.1 Radiated Disturbance

2.1.1 Specification Reference

FCC 47 CFR Part 15B, Clause 15.109

2.1.2 Equipment Under Test and Modification State

Not Applicable, S/N: 1819V0007 - Modification State 0

2.1.3 Date of Test

19-July-2022 to 24-July-2022

2.1.4 Test Method

The EUT was set up on a non-conductive table 0.8 m above a reference ground plane within a semi-anechoic chamber on a remotely controlled turntable. Above 18 GHz the height of the EUT was increased to 1 m.

A pre-scan of the EUT emissions profile using a peak detector was made at a 3 m antenna distance whilst varying the antenna-to-EUT azimuth and polarisation. Above 18 GHz, the measurement distance was reduced to 1 m and the limit lines increased by a factor of $20 \log(3/1)$ dB i.e. 9.54 dB

For an EUT which could reasonable be used in multiple planes, pre-scans were performed with the EUT orientated in X, Y and Z planes with reference to the ground plane. Due to the beamwidth of the test antenna above 18 GHz, pre-scans were performed in two horizontal positions relative to the EUT.

Using a list of the highest emissions detected during the pre-scan along with their bearing and associated antenna polarisation, the EUT was then formally measured using a Quasi-Peak, Peak or CISPR Average detector as appropriate.

The readings were maximised by adjusting the antenna height, polarisation and turntable azimuth, in accordance with the specification.

2.1.5 Example Calculation

Below 1 GHz:

$$\begin{aligned} \text{Quasi-Peak level (dB}\mu\text{V/m)} &= \text{Receiver level (dB}\mu\text{V)} + \text{Correction Factor (dB/m)} \\ \text{Margin (dB)} &= \text{Quasi-Peak level (dB}\mu\text{V/m)} - \text{Limit (dB}\mu\text{V/m)} \end{aligned}$$

Above 1 GHz:

$$\begin{aligned} \text{CISPR Average level (dB}\mu\text{V/m)} &= \text{Receiver level (dB}\mu\text{V)} + \text{Correction Factor (dB/m)} \\ \text{Margin (dB)} &= \text{CISPR Average level (dB}\mu\text{V/m)} - \text{Limit (dB}\mu\text{V/m)} \end{aligned}$$

$$\begin{aligned} \text{Peak level (dB}\mu\text{V/m)} &= \text{Receiver level (dB}\mu\text{V)} + \text{Correction Factor (dB/m)} \\ \text{Margin (dB)} &= \text{Peak level (dB}\mu\text{V/m)} - \text{Limit (dB}\mu\text{V/m)} \end{aligned}$$

2.1.6 Example Test Setup Diagram

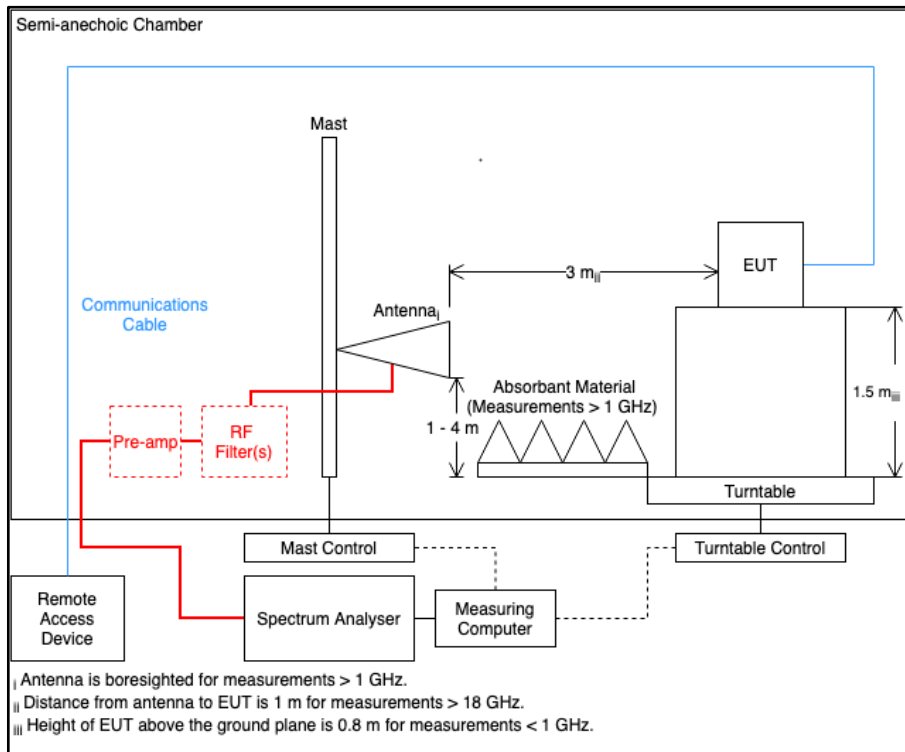

Figure 1

2.1.7 Environmental Conditions

Ambient Temperature 18.6 - 19.5 °C
 Relative Humidity 51.6 - 60.8 %

2.1.8 Specification Limits

Required Specification Limits, Field Strength - Class A Test Limit at a 10 m Measurement Distance		
Frequency Range (MHz)	Test Limit (µV/m)	Test Limit (dBµV/m)
30 to 88	90	39.1
88 to 216	150	43.5
216 to 960	210	46.4
Above 960	300	49.5

Supplementary information:
 Note 1. A Quasi-Peak detector is to be used for measurements below 1 GHz.
 Note 2. A CISPR Average detector is to be used for measurements above 1 GHz.
 Note 3. The Peak test limit above 1 GHz is 20 dB higher than the CISPR Average test limit.

Table 19



2.1.9 Test Results

Results for Configuration and Mode: DC Powered - Idle.

This test was performed to the requirements of the Class A limits.

Performance assessment of the EUT made during this test: Pass.

Detailed results are shown below.

Highest frequency generated or used within the EUT: 9893 MHz
 Which necessitates an upper frequency test limit of: 40 GHz

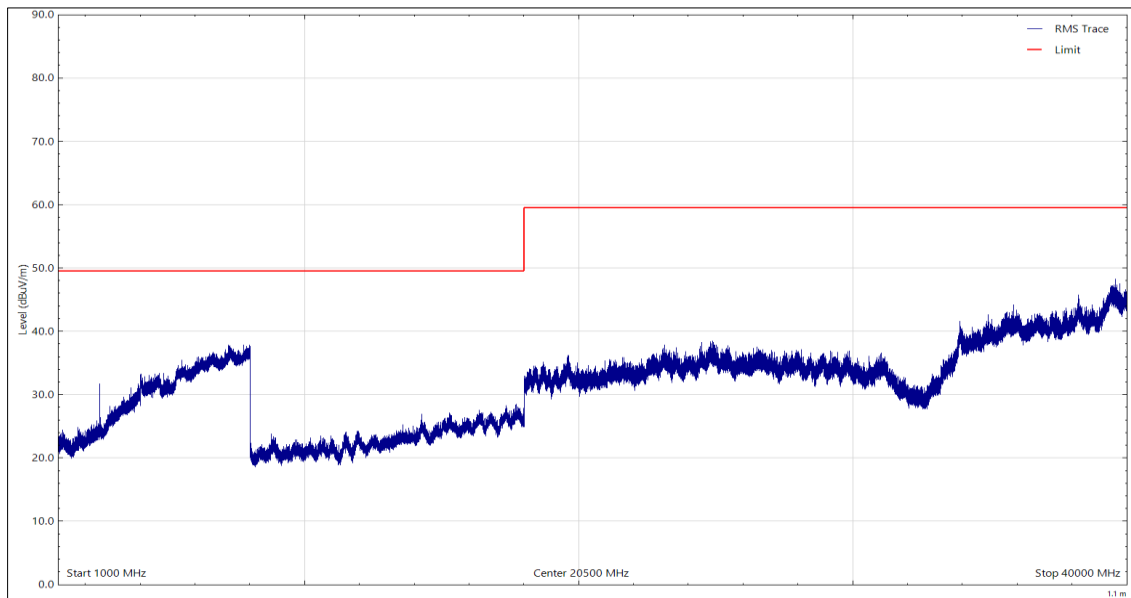

Figure 2 - 1 GHz to 40 GHz, CISPR Average, Horizontal

Frequency (MHz)	Level (dBuV/m)	Limit (dBuV/m)	Margin (dB)	Detector	Angle (°)	Height (cm)	Polarisation
*							

Table 20

*No final measurements were made as all peak emissions seen above the measurement system noise floor during the pre-scan were greater than 10 dB below the test limit.

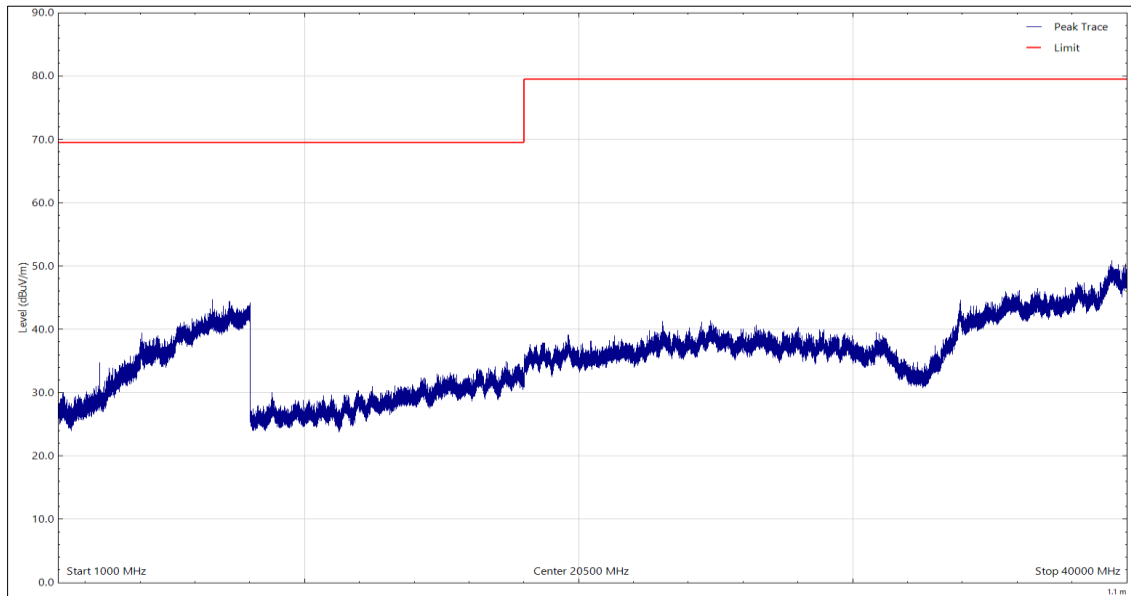

Figure 3 - 1 GHz to 40 GHz, Peak, Horizontal

Frequency (MHz)	Level (dBuV/m)	Limit (dBuV/m)	Margin (dB)	Detector	Angle (°)	Height (cm)	Polarisation
*							

Table 21

*No final measurements were made as all peak emissions seen above the measurement system noise floor during the pre-scan were greater than 10 dB below the test limit.

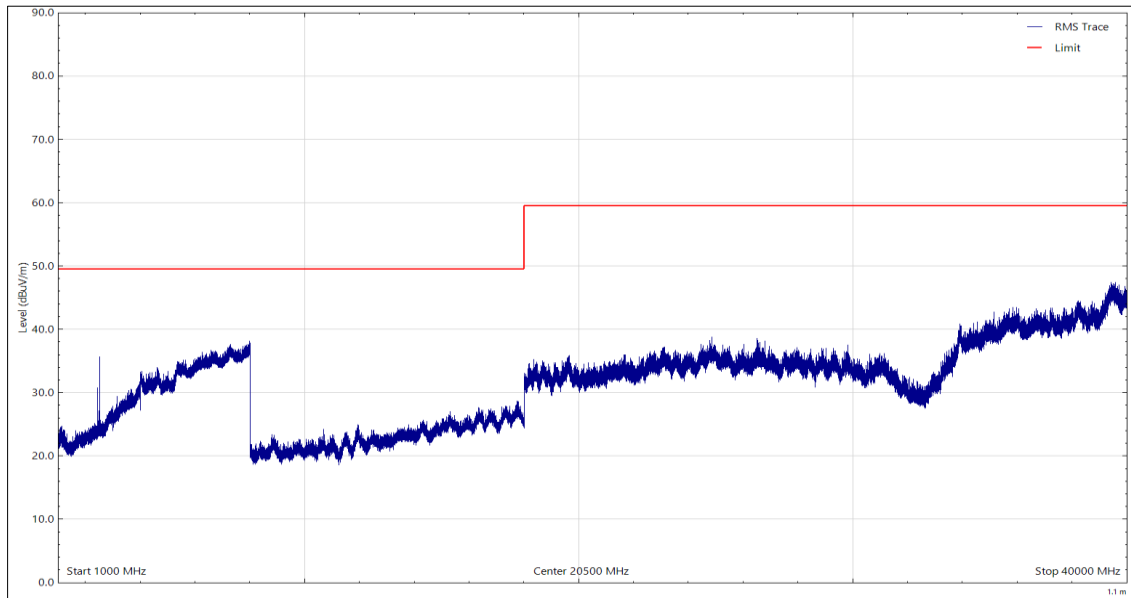

Figure 4 - 1 GHz to 40 GHz, CISPR Average, Vertical

Frequency (MHz)	Level (dBuV/m)	Limit (dBuV/m)	Margin (dB)	Detector	Angle (°)	Height (cm)	Polarisation
*							

Table 22

*No final measurements were made as all peak emissions seen above the measurement system noise floor during the pre-scan were greater than 10 dB below the test limit.

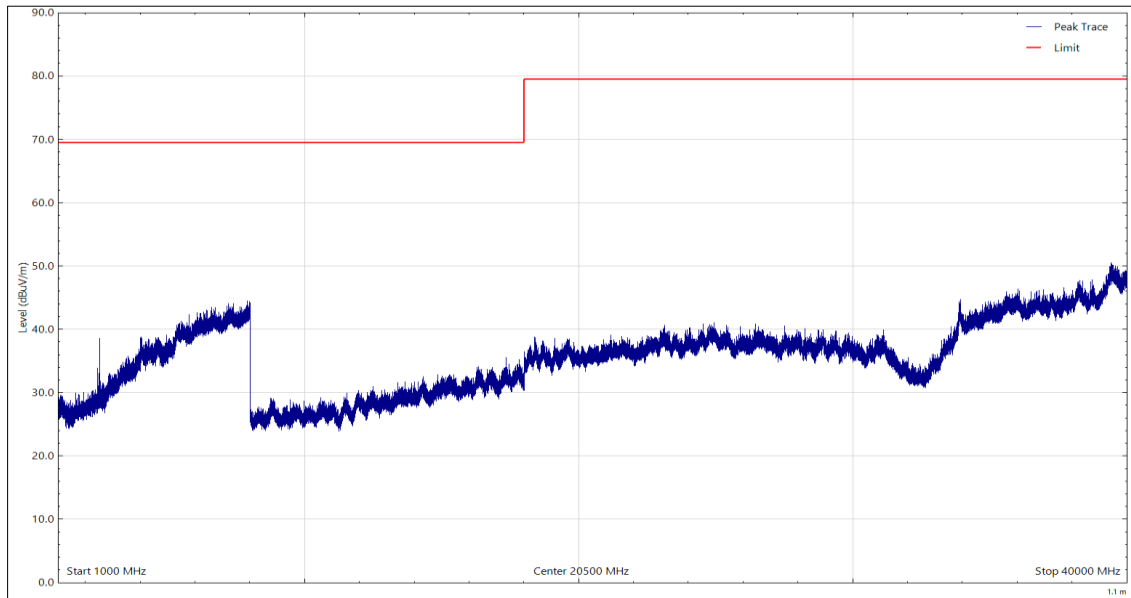

Figure 5 - 1 GHz to 40 GHz, Peak, Vertical

Frequency (MHz)	Level (dBuV/m)	Limit (dBuV/m)	Margin (dB)	Detector	Angle (°)	Height (cm)	Polarisation
*							

Table 23

*No final measurements were made as all peak emissions seen above the measurement system noise floor during the pre-scan were greater than 10 dB below the test limit.

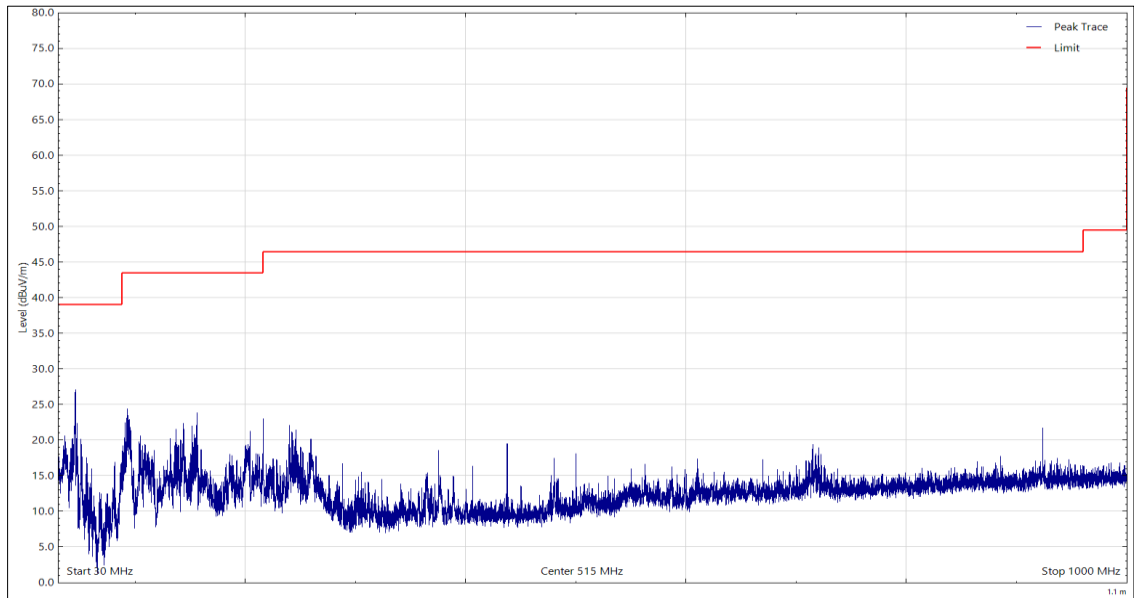

Figure 6 - 30 MHz to 1 GHz, Quasi-Peak, Horizontal

Frequency (MHz)	Level (dBuV/m)	Limit (dBuV/m)	Margin (dB)	Detector	Angle (°)	Height (cm)	Polarisation
*							

Table 24

*No final measurements were made as all peak emissions seen above the measurement system noise floor during the pre-scan were greater than 10 dB below the test limit.

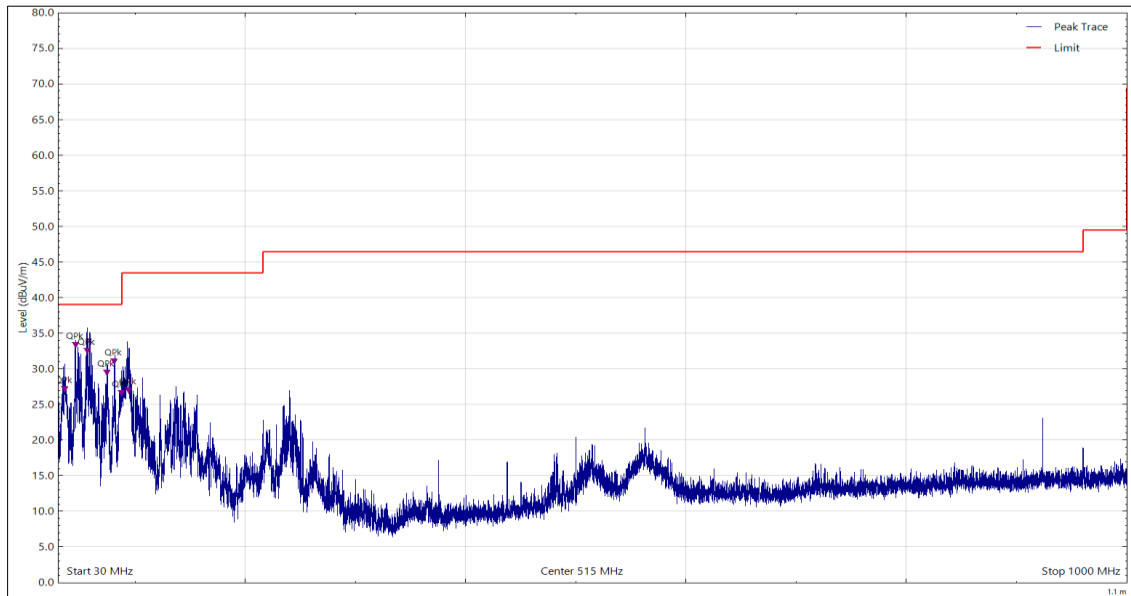

Figure 7 - 30 MHz to 1 GHz, Quasi-Peak, Vertical

Frequency (MHz)	Level (dBuV/m)	Limit (dBuV/m)	Margin (dB)	Detector	Angle (°)	Height (cm)	Polarisation
36.139	26.5	39.1	-12.6	Q-Peak	62	195	Vertical
46.000	32.7	39.1	-6.4	Q-Peak	195	100	Vertical
56.786	31.8	39.1	-7.3	Q-Peak	16	105	Vertical
74.552	28.8	39.1	-10.3	Q-Peak	232	105	Vertical
81.199	30.4	39.1	-8.7	Q-Peak	251	110	Vertical
87.498	26.0	39.1	-13.1	Q-Peak	267	110	Vertical
94.393	26.3	43.5	-17.2	Q-Peak	221	110	Vertical

Table 25

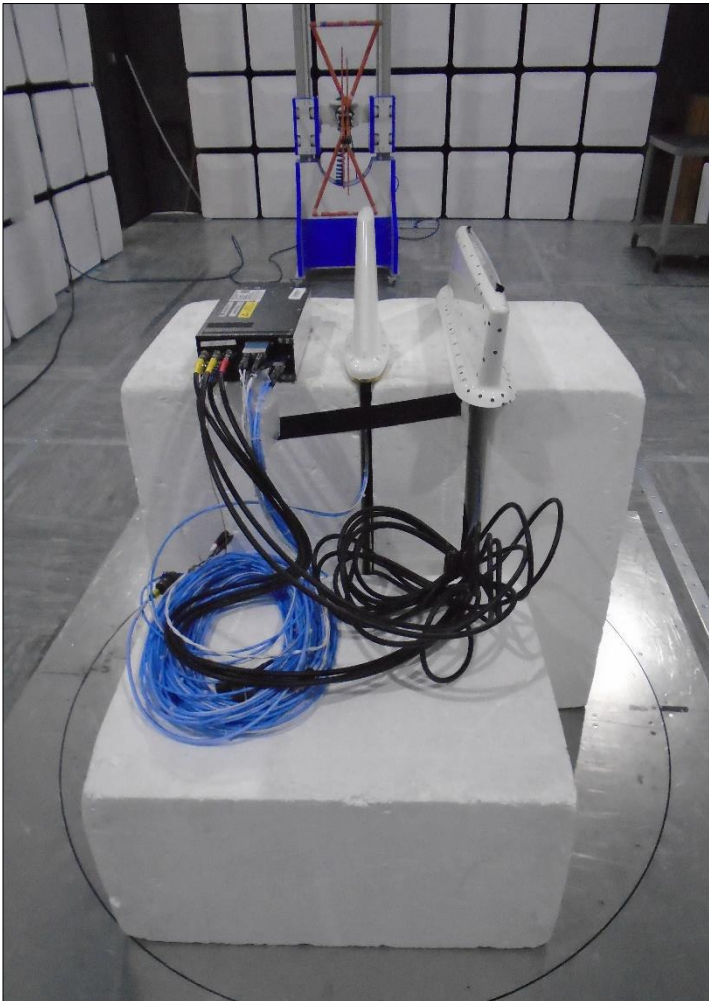

Figure 8 - 30 MHz to 1 GHz

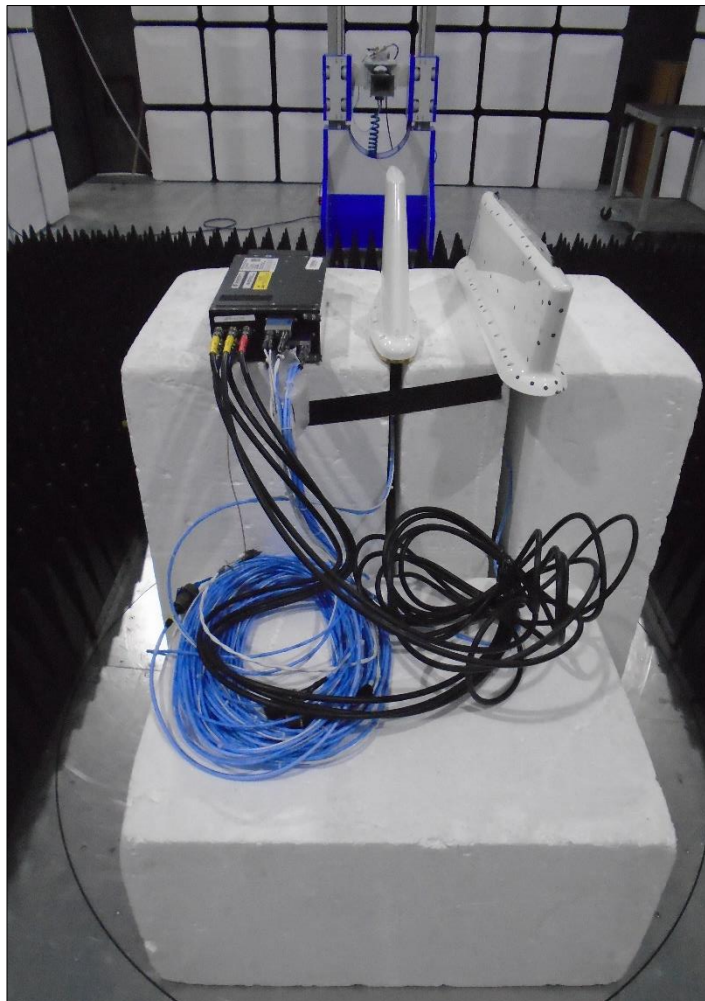

Figure 9 - 1 GHz to 18 GHz



Figure 10 - 18 GHz to 40 GHz - Position 1

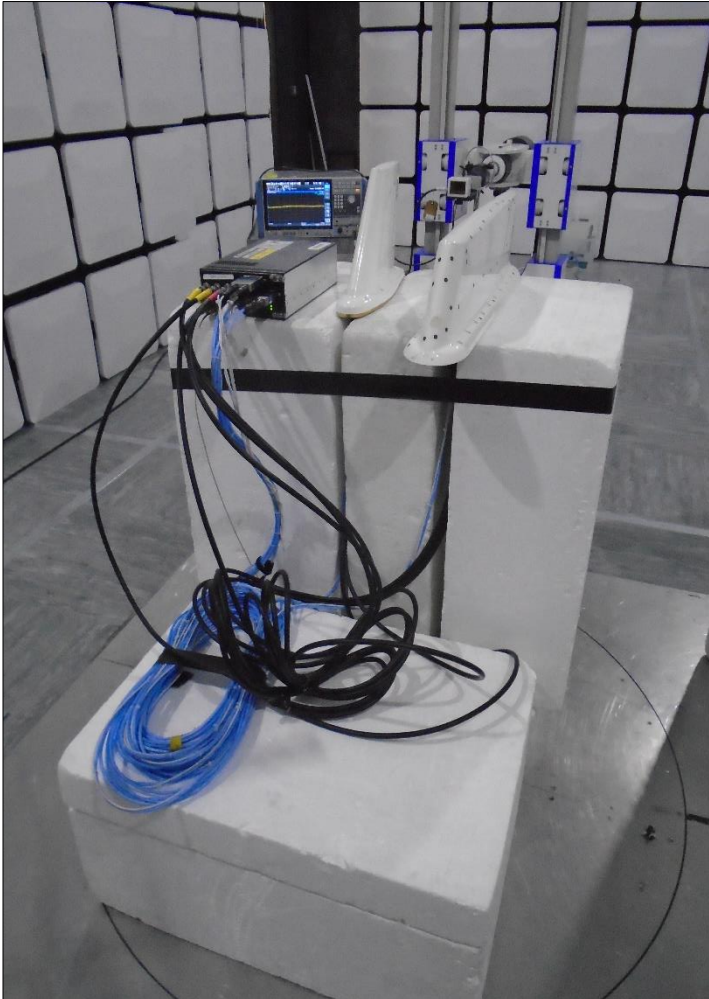

Figure 11 - 18 GHz to 40 GHz - Position 2



2.1.10 Test Location and Test Equipment Used

This test was carried out in EMC Chamber 12.

Instrument	Manufacturer	Type No	TE No	Calibration Period (months)	Calibration Expires
Screened Room (12)	MVG	EMC-3	5621	36	11-Aug-2023
Emissions Software	TUV SUD	EmX V3.1.2	5125	-	Software
Test Receiver	Rohde & Schwarz	ESW44	5914	12	21-Feb-2023
Turntable & Mast Controller	Maturo Gmbh	NCD/498/2799.01	5612	-	TU
Tilt Antenna Mast	Maturo Gmbh	TAM 4.0-P	5613	-	TU
Turntable	Maturo Gmbh	Turntable 1.5 SI-2t	5614	-	TU
Cable (SMA to SMA, 2 m)	Rhophase	3PS-1801A-2000-3PS	4113	12	27-Jan-2023
Cable (N-Type to N-Type, 1 m)	Rosenberger	LU7-036-1000	5031	12	23-Jul-2022
Cable (N-Type to N-Type, 8 m)	Teledyne	PR90-088-8MTR	5450	6	06-Oct-2022
Cable (K-Type to K-Type, 1 m)	Junkosha	MWX241-01000KMSKMS/A	5511	12	14-Apr-2023
Pre-Amplifier (8 GHz to 18 GHz)	Phase One	PS04-0086	1533	12	21-Feb-2023
Pre-Amplifier (18 GHz to 40 GHz)	Schwarzbeck	BBV 9721	5218	12	25-Jan-2023
Antenna with attenuator (Bilog, 30 MHz to 3 GHz)	Schaffner	CBL6143	287	24	14-Oct-2022
Antenna (DRG 1-10.5GHz)	Schwarzbeck	BBHA9120B	5611	12	15-Oct-2022
Antenna (DRG, 7.5 GHz to 18 GHz)	Schwarzbeck	HWRD750	5610	12	15-Oct-2022
Antenna (DRG, 15 GHz to 40 GHz)	Schwarzbeck	BBHA 9170	5217	12	25-Jan-2023

Table 26

TU - Traceability Unscheduled



3 Test Equipment Information

3.1 General Test Equipment Used

Instrument	Manufacturer	Type No	TE No	Calibration Period (months)	Calibration Due
Comb Generator	Schaffner	RSG1000	3034	-	TU
Thermo-hygro-Barometer	PCE Instruments	PCE-THB-40	5472	12	25-Mar-2023

Table 27

TU - Traceability Unscheduled



4 Incident Reports

No incidents reports were raised.



5 Measurement Uncertainty

For a 95% confidence level, the measurement uncertainties for defined systems are:

Test Name	Measurement Uncertainty
Radiated Disturbance	30 MHz to 1 GHz, Bilog Antenna, ± 5.2 dB 1 GHz to 40 GHz, Horn Antenna, ± 6.3 dB

Table 28

Worst case error for both Time and Frequency measurement 12 parts in 10^6 .

Measurement Uncertainty Decision Rule

Determination of conformity with the specification limits is based on the decision rule according to IEC Guide 115:2007, Clause 4.4.3 and 4.5.1. (Procedure 2). The measurement results are directly compared with the test limit to determine conformance with the requirements of the standard.

Risk: The uncertainty of measurement about the measured result is negligible with regard to the final pass/fail decision. The measurement result can be directly compared with the test limit to determine conformance with the requirement (compare IEC Guide 115). The level of risk to falsely accept and falsely reject items is further described in ILAC-G8.