

SONOFF

ZBCurtain

User manual V1.0

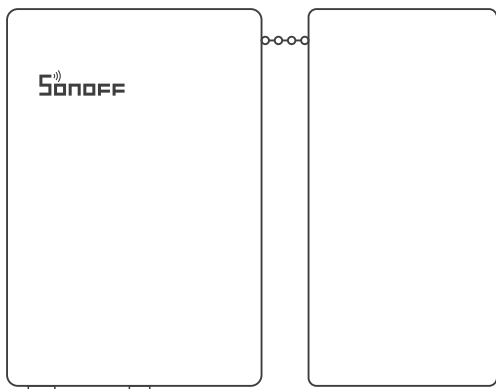

Zigbee Smart Curtain Motor



安装设备前, 请务必先扫码观看设备安装教程

- ⚠ 设备不支持罗马杆及弯曲窗帘轨道。
- ⚠ 确保窗帘轨道顶部空间大于2mm, 且轨道宽度小于40mm, 否则无法安装C型夹。

产品介绍

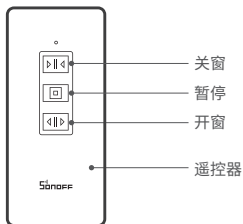
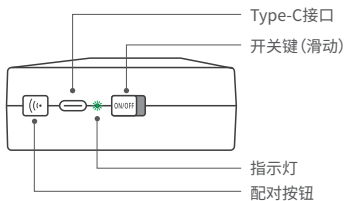
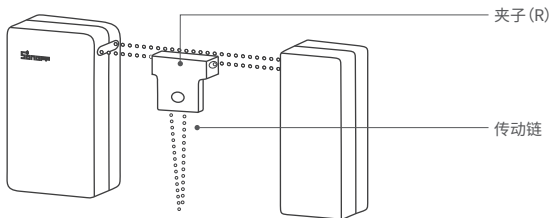

指示灯状态说明

状态	说明
绿灯慢闪	Zigbee配对模式
绿色常亮	遥控器配对模式
绿色快闪	遥控器清除

功能特点

SONOFF ZBCurtain是一款Zigbee智能窗帘电机,可以将家中窗帘智能化,具有远程控制、本地遥控、语音控制、手拉启停等功能,您可以按照百分比精准打开或关闭窗帘,也可以通过智能场景、定时器使窗帘更加自动化。



远程控制



智能定时/延时



语音控制



分享控制



场景联动



手拉启/停



本地遥控



自定义百分比

安装C型夹

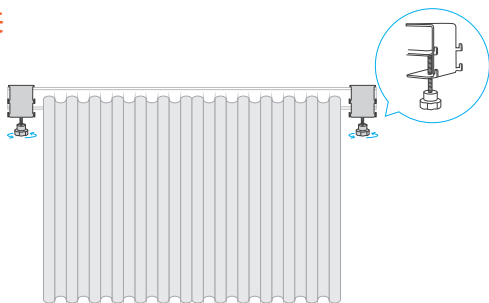

安装窗帘电机

1. 打开卷盘, 取出链子

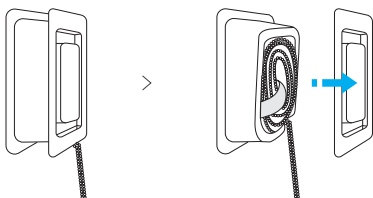

2. 先把主机扣在左侧C型夹上, 并向下扣紧

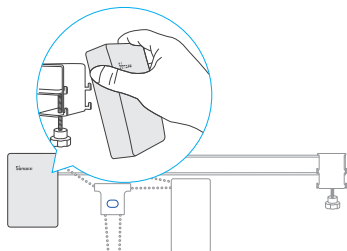

3. 拿住副机同时按住夹子(R)按钮, 往右侧逐步延长链子至另一侧C型夹位置

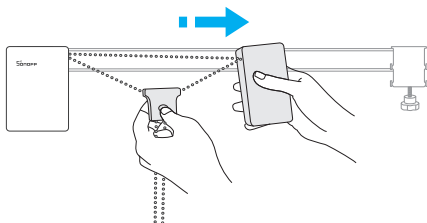

ⓘ 如链子长度不够, 可将绑好的链子拆出来使用。

4. 将副机扣在右侧C型夹上, 并向下扣紧

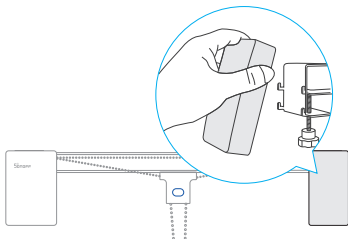

5. 按住夹子(R)按钮同时向下拉紧链子

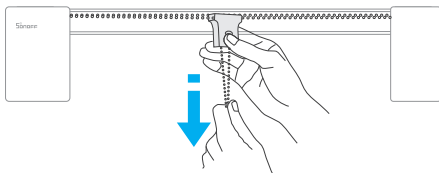

安装窗帘夹子

⚠ 装夹子前,先关上窗帘。

1. 双开窗帘

1-1 将夹子(R)夹在右边窗帘

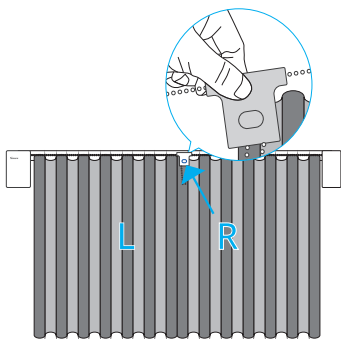

1-2 夹子(L)夹在左边窗帘 再把夹子(L)安装至内侧链子上

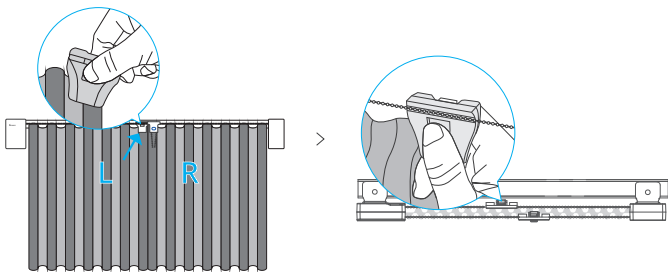

2.单开窗帘

将夹子(R)夹在打开的一侧(无须再安装夹子L)

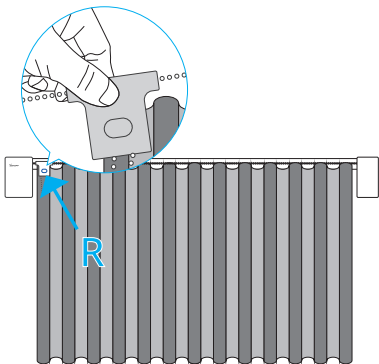

配对至易微联App

1. 下载易微联App

请前往应用商店、Google Play Store或Apple App Store搜索"易微联"进行下载。



2. 添加 SONOFF Zigbee网关

⚠ 确保网关版本为: ZBBridge-P V1.1.0及以上, ZBBridge V1.6.0及以上

3.将窗帘电机添加至Zigbee网关

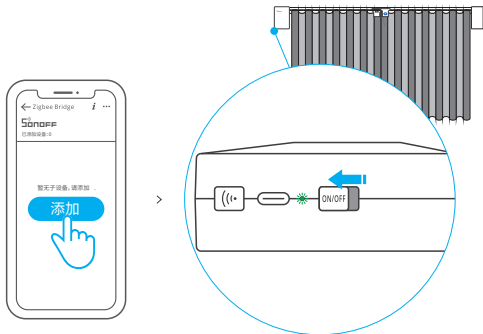

打开eWeLink App, 选择要连接的网关, 点击 "添加" 子设备。然后将窗帘电机开机, 开机后LED指示灯呈 “绿色慢闪” 状态, 此时设备进入配对模式, 等待设备添加, 添加成功后设备LED指示灯会常亮3秒。

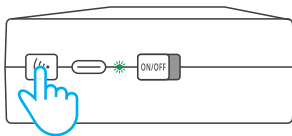

⚠ 30秒内没配对成功, 窗帘电机将退出配对模式, 如需再次进入, 请长按窗帘电机配对按键5秒直到LED指示灯呈 “绿色慢闪” 状态即可。

4.有效距离验证

在选定的设备安装位置，短按设备的配对按键，设备指示灯双闪，表明该设备和Zigbee网络下的设备(路由设备或网关)处于有效通讯距离。

设置开关窗行程点

⚠ 必须先设置开窗行程点,再设置关窗行程点(否则会影响手拉停止功能)

1. 开窗行程点设置

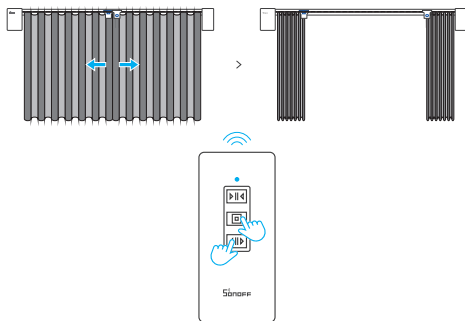

同时按住遥控器“开窗+暂停”按键，待窗帘移动至开窗时需要停下的位置松开按键即可。

2. 关窗行程点设置

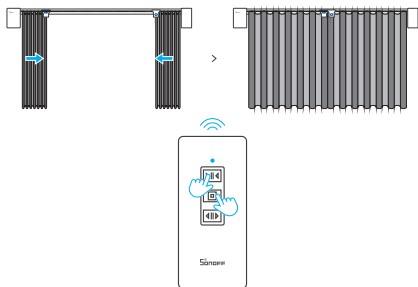

同时按住遥控器“关窗+暂停”按键，待窗帘移动至关窗时需要停下的位置松开按键即可。

- ⚠ 如果设备断电期间，窗帘位置发生变化，再次上电后请重新设置行程点。
- ⚠ 当遥控器配对了多个窗帘电机时，请逐个窗帘电机设置行程点，其他窗帘电机请暂时关机。

充电

1. 用USB Type-C线连接适配器充电

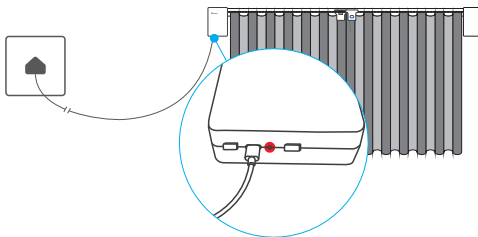

2.太阳能板充电

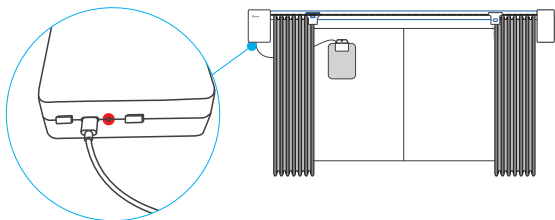

使用太阳能板充电时，请把太阳能板安装在有阳光处。

ⓘ 本设备不包括适配器和太阳能板，请另行购买。

遥控器与窗帘电机配对&清除

配对

1. 关闭窗帘电机电源，按住配对按键，再上电，约等待5秒至LED指示灯呈绿色常亮，再松开配对按键，此时窗帘电机进入遥控器配对状态。
2. 在10s内按一下遥控器任意按键，LED指示灯熄灭且窗帘电机短暂正反转一次表示配对成功。

ⓘ 10秒内没进行遥控配对，请跟据以上步骤，重复操作。

清除

关闭窗帘电机电源，按住配对按键，再上电，约等待10秒至LED指示灯呈绿色快闪，再松开配对按键，此时与该窗帘电机配对的所有遥控器都被清除。

产品参数

产品型号	ZBCurtain
输入	DC 5V 1A
接口类型	Type-C
最大功率	5W
电池容量	4000mAh
电池型号	103450 (103450 x 2 3.7V)
无线连接	Zigbee 3.0
工作温度	-5°C~40°C
外壳材料	ABS
产品规格	主机: 115x78x29mm, 副机: 115x58x28mm
开关次数	≤3000次
适用窗帘长度	≤3.5m
搭载窗帘重量	≤8公斤

零件清单

零件名称	数量
窗帘电机【主电机、副电机、驱动链、夹子(R)】	1
夹子(L)	1
遥控器	1
遥控器底座(含3M胶)	1
螺丝	2
USB Type-C线	1
C型夹	2
快速指南	1



Please scan the QR code to watch the installation tutorial before installing the device.

- ⚠ This device does not support the curtain rod and curved curtain track.
- ⚠ Make sure the top space of the curtain track is greater than 2mm and the track width is less than 40mm, so that you can install the C-shape brackets properly.

Introduction

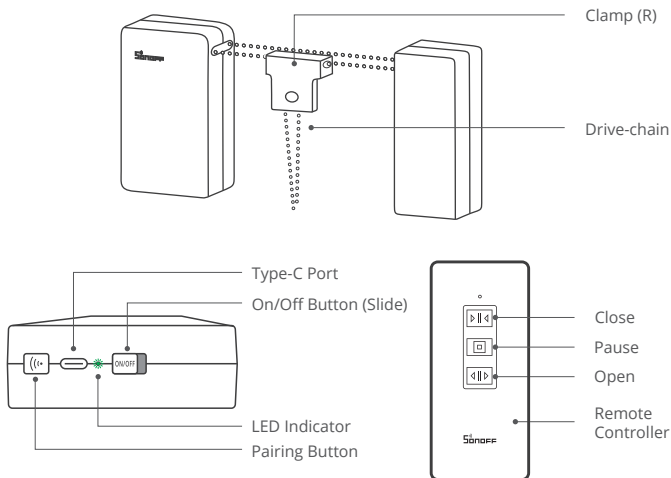

Indicator Status Description

Status	Description
LED indicator flashes green slowly	Zigbee pairing mode
LED indicator keeps green	Remote controller pairing mode
LED indicator flashes green quickly	Remote controller cleared

Features

SONOFF ZBCurtain is a Zigbee smart curtain motor, which allows you to remote control, local control, voice control and manually open/pause your curtains. You can also open or close the curtains to percentage, set smart scenes, timers and etc. to make your curtains more automatic.



Remote Control



Timing Schedule



Voice Control



Share Control



Smart Scene



Manual Open/Pause



Local Control

Custom Opening
/Closing Position

Install the C-shape brackets

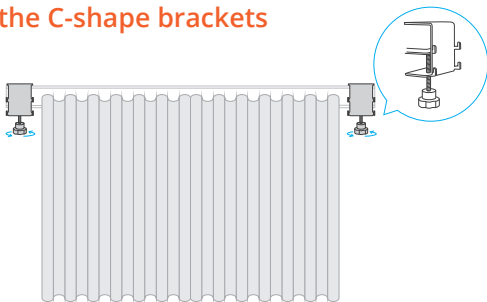

Install the curtain motors

1. Remove the cover of the reel, then take out the drive-chain.

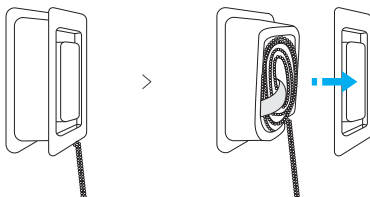

2. Mount the main-motor on the left C-shape bracket and fasten it downwards.

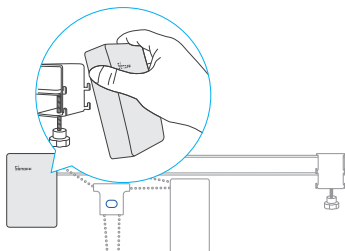

3. Hold the vice-motor and press the button on the clamp(R), then gradually extend the drive-chain to the right to the C-shape bracket position.

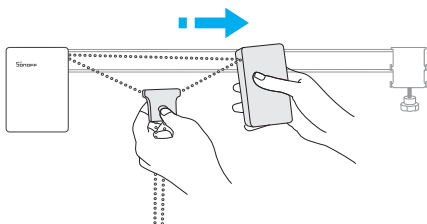

- ⚠ The tied part can be disassembled and used if the drive-chain is not long enough.

4. Mount the vice-motor on the right C-shape bracket and fasten it downwards.

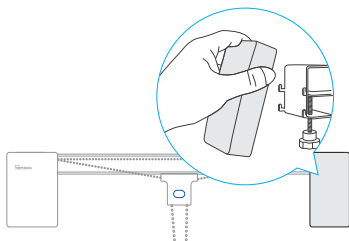

5. Press and hold the button on the clamp(R) while pulling down the chain tightly.

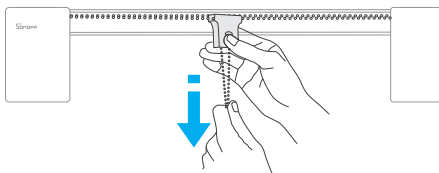

Mount the curtain clamps

⚠ Close the curtains before mounting the curtain clamps.

1. Double-side opening curtain

1-1 Clip the clamp(R) on the right curtain.

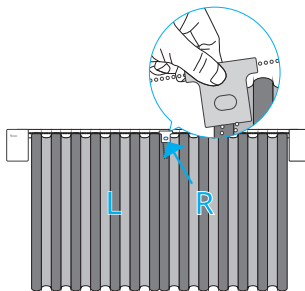

1-2 Clip the clamp(L) on the left curtain, and mount the clamp(L) on the inner curtain drive-chain.

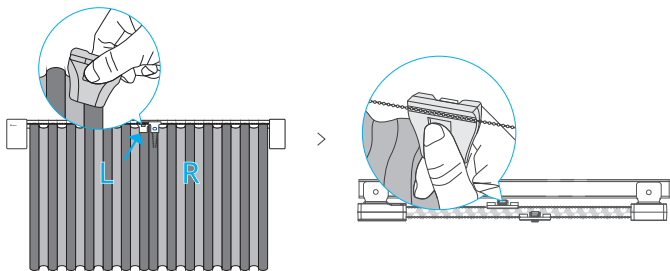

2.Single-side opening curtain

Clip the clamp(R) on the opening side of the curtain (The clamp L is not required).

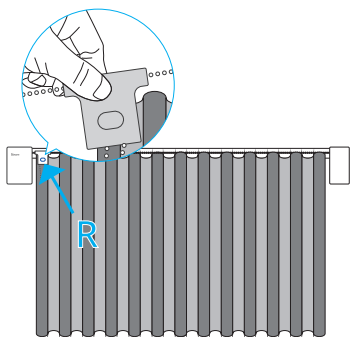

Pair with eWeLink App

1. Download the eWeLink App

Please download the "eWeLink" App from Google Play Store or Apple App Store.



2.Add SONOFF Zigbee Bridge to your eWeLink account

- ⓘ Make sure the proper versions of Zigbee gateway: ZBBridge-P V1.1.0 and later, ZBBridge V1.6.0 and later.

3.Add curtain motor to Zigbee Bridge

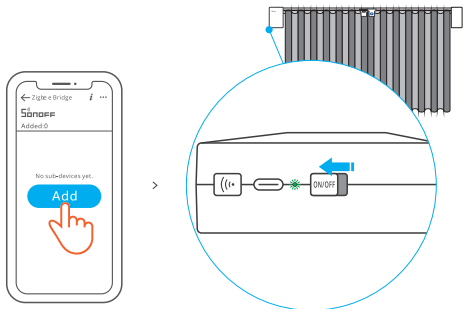

Open the eWeLink App, select the gateway you want to pair and tap the "Add" icon, then power on the curtain motor. After powering on, LED indicator will "flash green slowly", now the device is in pairing mode and waiting for been added. The LED indicator on the device will keep on for 3s when adding the device successfully.

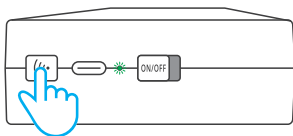

- ⓘ The device will exit the pairing mode when it doesn't be paired successfully within 30s. If you want to enter the pairing mode again, press and hold the pairing button for 5s until the LED indicator "flashes green slowly" and then release.

4.Effective Communication Distance Verification

Install the device in the desired place, then press the Pairing button on the device. The LED indicator flashes twice means the device and the device under the same Zigbee network (the router device or hub) are in the effective communication distance.

Set up the curtain opening and closing limit position

- ⓘ Please set up the opening limit position first and then set up the closing limit position (Otherwise it will affect the manual pause feature).

1. Curtain opening limit position setting:

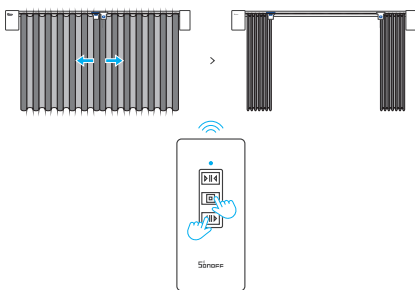

Press and hold the "Open+Pause" buttons on the remote controller at the same time, and release the buttons when the curtain moves to the desired position that you want to open the curtain.

2. Curtain closing limit position setting:

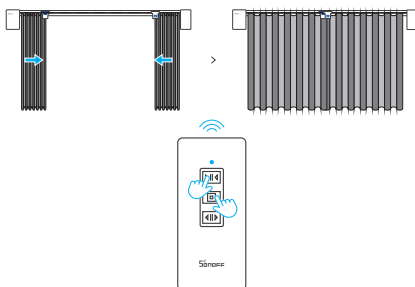

Press and hold the "Close+Pause" buttons on the remote controller at the same time, and release the buttons when the curtain moves to the desired position that you want to close the curtain.

- ⚠ If the curtain position changes while the device is powered off, please reset the limit position after the device powers on again.
- ⚠ When the remote controller is paired with more than one curtain motor, please set the limit points one by one for each curtain motor and switch off the other curtain motors temporarily.

Charge

1. Charged by USB Type-C and proper adapter

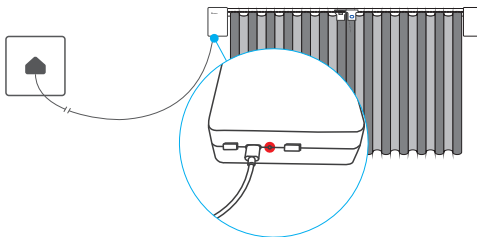

2.Charged by solar panel

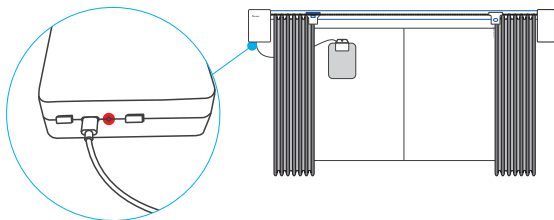

When you using the solar panel to charge the curtain motor, please install the solar panel in a sunny spot.

- ⓘ The adapter and the solar panel are not included in the product, please purchase them separately.

Pairing & Clearing of Curtain Remote and Curtain Motor

Pairing

1. Power off the Curtain Motor, long press the pairing button and then power on the Curtain Motor to wait for about 5s until the LED indicator turns green and keeps on, then release. Now Curtain Motor has entered the Curtain Remote pairing state.
2. Press any button on the Curtain Remote within 10s, then LED indicator will turn off and the Curtain Motor will move forward and backward briefly once, now the pairing is successful between Curtain Motor and Curtain Remote.

- ⓘ If the Curtain Remote does not been paired within 10s, please follow the above steps and pair them again.

Clearing

Power off the Curtain Motor, press and hold the pairing button, then power on the Curtain Motor, wait for about 10s until the LED indicator flashes green quickly and then release. Now all paired Curtain Remotes are cleared from ZBCurtain.

Specifications

Model	ZBCurtain
Input	DC 5V 1A
Port Type	Type-C
Max. Power	5W
Battery Capacity	4000mAh
Battery Model	103450 (103450 x 2 3.7V)
Wireless Connection	Zigbee 3.0
Working Temperature	-5°C~40°C
Casing Material	ABS
Product Dimension	Main-motor: 115x78x29mm, Vice-motor: 115x58x28mm
Switching Times	≤3000 times
Curtain Length Requirement	≤3.5m
Curtain Weight Requirement	≤8kg

List of Parts

Part Name	Quantity
Curtain Motor [Main-motor, Vice-motor, Drive-chain, Clamp (R)]	1
Clamp (L)	1
Remote Controller	1
Remote Controller Base(3M adhesive included)	1
Screws	2
USB Type-C Cable (3m)	1
C-Shape Brackets	2
Quick Guide	1

FCC Warning

Changes or modifications not expressly approved by the party responsible for compliance could avoid the user's authority to operate the equipment.

This device complies with part 15 of the FCC Rules. Operation is subject to the following two conditions: (1) This device may not cause harmful interference, and (2) this device must accept any interference received, including interference that may cause undesired operation.

FCC Radiation Exposure Statement:

This equipment complies with FCC radiation exposure limits set forth for an uncontrolled environment. This equipment should be installed and operated with minimum distance 20cm between the radiator & your body. This transmitter must not be co-located or operating in conjunction with any other antenna or transmitter.

Note:

This equipment has been tested and found to comply with the limits for a Class B digital device, pursuant to part 15 of the FCC Rules. These limits are designed to provide reasonable protection against harmful interference in a residential installation. This equipment generates, uses and can radiate radio frequency energy and, if not installed and used in accordance with the instructions, may cause harmful interference to radio communications. However, there is no guarantee that interference will not occur in a particular installation. If this equipment does cause harmful interference to radio or television reception, which can be determined by turning the equipment off and on, the user is encouraged to try to correct the interference by one or more of the following measures:

- Reorient or relocate the receiving antenna.
- Increase the separation between the equipment and receiver.
- Connect the equipment into an outlet on a circuit different from that to which the receiver is connected.
- Consult the dealer or an experienced radio/TV technician for help.

WARNING: Import safety instructions. It is important for the safety of persons to follow these instructions. Save these instructions.

This appliance can be used by children aged from 8 years and above and persons with reduced physical, sensory or mental capabilities or lack of experience and knowledge if they have been given supervision or instruction concerning use of the appliance in a safe way and understand the hazards involved. Children shall not play with the appliance. Cleaning and user maintenance shall not be made by children without supervision.

- do not allow children to play with fixed controls. Keep remote controls away from children.

- frequently examine the installation for imbalance and signs of wear or damage to cables and springs. Do not use if repair or adjustment is necessary;

WARNING: Import safety instructions. Follow all instructions, since incorrect installation can lead to severe injury- before installing the drive, remove any unnecessary cords and disable any equipment not needed for powered operation;-fixed controls have to be clearly visible after installation

Hereby, Shenzhen Sonoff Technologies Co., Ltd. declares that the radio equipment type ZBCurtain is in compliance with Directive 2014/53/EU. The full text of the EU declaration of conformity is available at the following internet address:

<https://sonoff.tech/usermanuals>

For CE frequency

Operation frequency Range: 2402-2480MHz(BLE) / 2405-2480MHz(Zigbee)

RF Output Power: 4.12dBm(BLE) / 4.12dBm(Zigbee)

SONOFF

Shenzhen Sonoff Technologies Co., Ltd.

3F & 6F, Bldg A, No. 663, Bulong Rd, Shenzhen, Guangdong, China

ZIP code: 518000

Website: sonoff.tech

MADE IN CHINA

