



# CTC Laboratories, Inc.

1-2/F., Building 2, Jiaquan Building, Guanlan High-Tech Park, Shenzhen, Guangdong, China  
Tel: +86-755-27521059 Fax: +86-755-27521011 <http://www.sz-ctc.org.cn>

## TEST REPORT

**Report No.** .....: **CTC20240121E04**

**FCC ID**.....: **2APN5SNZB05P**

**IC**.....: **29127-SNZB05P**

**Applicant**.....: **Shenzhen Sonoff Technologies Co.,Ltd.**

Address.....: 3F & 6F, Bldg A, No. 663, Bulong Rd, Shenzhen, Guangdong, China

Manufacturer.....: Shenzhen Sonoff Technologies Co.,Ltd.

Address.....: 3F & 6F, Bldg A, No. 663, Bulong Rd, Shenzhen, Guangdong, China

**Product Name**.....: **Zigbee Water Leak Sensor**

Trade Mark.....: , Sonoff

Model/Type reference.....: SNZB-05P

Listed Model(s) .....: /

**Standard**.....: **FCC CFR Title 47 Part 15 Subpart C Section 15.247  
RSS-247 Issue 3**

Date of receipt of test sample...: Jan. 24, 2024

Date of testing.....: Jan. 24, 2024 to Mar. 8, 2024

Date of issue.....: Mar. 13, 2024

**Result**.....: **PASS**

Compiled by:		
(Printed name+signature)	Jim Jiang	-----
Supervised by:		
(Printed name+signature)	Eric Zhang	-----
Approved by:		
(Printed name+signature)	Totti Zhao	

This test report may be duplicated completely for legal use with the approval of the applicant. It should not be reproduced except in full, without the written approval of our laboratory. The client should not use it to claim product endorsement by CTC. The test results in the report only apply to the tested sample. The test report shall be invalid without all the signatures of testing engineers, reviewer and approver. Any objections must be raised to CTC within 15 days since the date when the report is received. It will not be taken into consideration beyond this limit. The test report merely correspond to the test sample.



Table of Contents

Page

**1. TEST SUMMARY .....3**

1.1. TEST STANDARDS.....3

1.2. REPORT VERSION .....3

1.3. TEST DESCRIPTION.....3

1.4. TEST FACILITY .....4

1.5. MEASUREMENT UNCERTAINTY .....4

1.6. ENVIRONMENTAL CONDITIONS.....5

**2. GENERAL INFORMATION .....6**

2.1. CLIENT INFORMATION .....6

2.2. GENERAL DESCRIPTION OF EUT .....6

2.3. ACCESSORY EQUIPMENT INFORMATION .....7

2.4. OPERATION STATE .....8

2.5. MEASUREMENT INSTRUMENTS LIST .....9

**3. TEST ITEM AND RESULTS .....11**

3.1. CONDUCTED EMISSION.....11

3.2. RADIATED EMISSION .....13

3.3. BAND EDGE EMISSIONS (RADIATED) .....21

3.4. BAND EDGE AND SPURIOUS EMISSIONS (CONDUCTED) .....26

3.5. DTS BANDWIDTH.....29

3.6. PEAK OUTPUT POWER .....32

3.7. POWER SPECTRAL DENSITY .....33

3.8. DUTY CYCLE .....35

3.9. ANTENNA REQUIREMENT.....37



# 1. TEST SUMMARY

## 1.1. Test Standards

The tests were performed according to following standards:

[FCC Rules Part 15.247](#): Operation within the bands of 902-928MHz, 2400-2483.5MHz, and 5725-5850MHz.

[RSS-247 Issue 3](#): Standard Specifications for Frequency Hopping Systems (FHSs) and Digital Transmission Systems (DTSS) Operating in the Bands 902-928MHz, 2400-2483.5MHz and 5725-5850MHz.

[ANSI C63.10-2013](#): American National Standard for Testing Unlicensed Wireless Devices.

## 1.2. Report Version

Revised No.	Date of issue	Description
01	Mar. 13, 2024	Original

## 1.3. Test Description

FCC Part 15 Subpart C (15.247) / RSS-247 Issue 3				
Test Item	Standard Section		Result	Test Engineer
	FCC	IC		
Antenna Requirement	15.203	/	Pass	Jim Jiang
Conducted Emission	15.207	RSS-Gen 8.8	Pass	N/A
Band Edge Emissions	15.247(d)	RSS-247 5.5	Pass	Jim Jiang
6dB Bandwidth	15.247(a)(2)	RSS-247 5.2 (a)	Pass	Jim Jiang
Conducted Max Output Power	15.247(b)(3)	RSS-247 5.4 (d)	Pass	Jim Jiang
Power Spectral Density	15.247(e)	RSS-247 5.2 (b)	Pass	Jim Jiang
Transmitter Radiated Spurious	15.209&15.247(d)	RSS-247 5.5& RSS-Gen 8.9	Pass	Jim Jiang

Note:

N/A: Not applicable.

The measurement uncertainty is not included in the test result.



## 1.4. Test Facility

### CTC Laboratories, Inc.

Add: 1-2/F., Building 2, Jiaquan Building, Guanlan High-Tech Park, Shenzhen, Guangdong, China

### Laboratory accreditation

The test facility is recognized, certified, or accredited by the following organizations:

#### **A2LA-Lab Cert. No.: 4340.01**

CTC Laboratories, Inc. EMC Laboratory has been accredited by A2LA for technical competence in the field of electrical testing, and proved to be in compliance with ISO/IEC 17025:2017 General Requirements for the Competence of Testing and Calibration Laboratories and any additional program requirements in the identified field of testing.

#### **Industry Canada (Registration No.: 9783A, CAB Identifier: CN0029)**

CTC Laboratories, Inc. EMC Laboratory has been registered by Certification and Engineer Bureau of Industry Canada for the performance of with Registration NO.: 9783A on Jan, 2016.

#### **FCC (Registration No.: 951311, Designation Number CN1208)**

CTC Laboratories, Inc. EMC Laboratory has been registered and fully described in a report filed with the (FCC) Federal Communications Commission. The acceptance letter from the FCC is maintained in our files. Registration 951311, Aug 26, 2017.

## 1.5. Measurement Uncertainty

The data and results referenced in this document are true and accurate. The reader is cautioned that there may be errors within the calibration limits of the equipment and facilities. The measurement uncertainty was calculated for all measurements listed in this test report acc. to TR-100028-01 "Electromagnetic compatibility and Radio spectrum Matters (ERM); Uncertainties in the measurement of mobile radio equipment characteristics; Part 1" and TR-100028-02 "Electromagnetic compatibility and Radio spectrum Matters (ERM); Uncertainties in the measurement of mobile radio equipment characteristics; Part 2" and is documented in the CTC Laboratories, Inc. quality system acc. to DIN EN ISO/IEC 17025. Furthermore, component and process variability of devices similar to that tested may result in additional deviation. The manufacturer has the sole responsibility of continued compliance of the device.

Below is the best measurement capability for CTC Laboratories, Inc.



Test Items	Measurement Uncertainty	Notes
Transmitter power conducted	0.42 dB	(1)
Transmitter power Radiated	2.14 dB	(1)
Conducted spurious emissions 9kHz~40GHz	1.60 dB	(1)
Radiated spurious emissions 9kHz~40GHz	2.20 dB	(1)
Conducted Emissions 9kHz~30MHz	3.20 dB	(1)
Radiated Emissions 30~1000MHz	4.70 dB	(1)
Radiated Emissions 1~18GHz	5.00 dB	(1)
Radiated Emissions 18~40GHz	5.54 dB	(1)
Occupied Bandwidth	-----	(1)

Note (1): This uncertainty represents an expanded uncertainty expressed at approximately the 95% confidence level using a coverage factor of  $k=2$ .

## 1.6. Environmental Conditions

During the measurement the environmental conditions were within the listed ranges:

Temperature:	15 °C to 35 °C
Relative Humidity:	20 % to 75 %
Air Pressure:	101 kPa

## 2. GENERAL INFORMATION

### 2.1. Client Information

Applicant:	Shenzhen Sonoff Technologies Co.,Ltd.
Address:	3F & 6F, Bldg A, No. 663, Bulong Rd, Shenzhen, Guangdong, China
Manufacturer:	Shenzhen Sonoff Technologies Co.,Ltd.
Address:	3F & 6F, Bldg A, No. 663, Bulong Rd, Shenzhen, Guangdong, China

### 2.2. General Description of EUT

Product Name:	Zigbee Water Leak Sensor
Trade Mark:	 SONOFF, Sonoff
Model/Type reference:	SNZB-05P
Listed Model(s):	/
Model Difference:	/
Power supply:	DC3V from lithium cell
Hardware version:	V1.1
Software version:	V1.0.1
<b>Zigbee 3.0</b>	
Modulation:	OQPSK
Operation frequency:	2405MHz~2480MHz
Channel number:	16
Channel separation:	5MHz
Antenna type:	PCB Antenna
Antenna gain:	2.07dBi



## 2.3. Accessory Equipment Information

Equipment Information			
Name	Model	S/N	Manufacturer
Notebook	ThinkPad E14 Gen 3	PF-3384L3	Lenovo
Cable Information			
Name	Shielded Type	Ferrite Core	Length
USB Cable	Unshielded	NO	120cm
Test Software Information			
Name	Version	/	/
SSCOM	V5.13.1	/	/

## 2.4. Operation State

The EUT has been tested under typical operating condition. The Applicant provides communication tools software to control the EUT for staying in continuous transmitting and receiving mode for testing. Zigbee, 16 channels are provided to the EUT. Channels 11/18/26 were selected for testing.

Operation Frequency List:

Channel	Frequency (MHz)
<b>11</b>	<b>2405</b>
12	2410
:	:
17	2435
<b>18</b>	<b>2440</b>
19	2445
:	:
25	2475
<b>26</b>	<b>2480</b>

Note: The display in grey were the channel selected for testing.

Test Mode:

For RF test items:
The engineering test program was provided and enabled to make EUT continuous transmit.
For AC power line conducted emissions:
The EUT was set to connect with the Bluetooth instrument under large package sizes transmission.
For Radiated spurious emissions test item:
The engineering test program was provided and enabled to make EUT continuous transmit. The EUT in each of three orthogonal axis emissions had been tested, but only the worst case (X axis) data recorded in the report.

The worse case configurations:

The Worse Case Power Setting Parameter under 2400 ~ 2483.5MHz Band		
Test Software	SSCOM V5.13.1	
Modulation Mode	Test Channel	Power Level
OQPSK	11	6 6
	18	6 6
	26	6 6





## 2.5. Measurement Instruments List

Tonscend JS0806-2 Test system					
Item	Test Equipment	Manufacturer	Model No.	Serial No.	Calibrated until
1	Spectrum Analyzer	R&S	FSV40-N	101331	Mar. 14, 2024
2	Spectrum Analyzer	R&S	FSV40-N	101654	Aug. 07, 2024
3	Spectrum Analyzer	R&S	FSU26	100105	Dec. 12, 2024
4	MXA Signal Analyzer	Keysight	N9020A	MY46471737	Dec. 12, 2024
5	MXA Signal Analyzer	Keysight	N9020A	MY52091402	Aug. 22, 2024
6	MXG Vector Signal Generator	Agilent	N5182A	MY47420864	Dec. 12, 2024
7	PSG Analog Signal Generator	Agilent	E8257D	MY46521908	Dec. 12, 2024
8	EXG Analog Signal Generator	Keysight	N5173B	MY59100842	Dec. 12, 2024
9	MXG Vector Signal Generator	Keysight	N5182B	MY59100212	Dec. 12, 2024
10	USB Wideband Power Sensor	Keysight	U2021XA	MY55130004	Mar. 14, 2024
11	USB Wideband Power Sensor	Keysight	U2021XA	MY55130006	Mar. 14, 2024
12	Wideband Radio Communication Tester	R&S	CMW500	102257	May 25, 2024
13	Wideband Radio Communication Tester	R&S	CMW500	102414	Dec. 12, 2024
14	RF Control Unit	Tonscend	JS0806-2	/	Aug. 22, 2024
15	High and low temperature test chamber	ESPEC	MT3035	/	Mar. 24, 2024

Radiated emission					
Item	Test Equipment	Manufacturer	Model No.	Serial No.	Calibrated until
1	Trilog-Broadband Antenna	Schwarzbeck	VULB 9163	01026	Dec. 18, 2024
2	Horn Antenna	Schwarzbeck	BBHA 9120D	9120D-647	Sep. 25, 2025
3	Test Receiver	Keysight	N9038A	MY56400071	Dec. 12, 2024
4	Broadband Prempplier	SCHWARZBECK	BBV9743B	259	Dec. 12, 2024
5	Mirowave Broadband Amplifier	SCHWARZBECK	BBV9718C	111	Dec. 12, 2024
6	3m chamber 3	YIHENG	EE106	/	Aug. 28, 2026
7	Test Software	FARA	EZ-EMC	FA-03A2	/

CTC Laboratories, Inc.

1-2/F., Building 2, Jiaquan Building, Guanlan High-Tech Park, Shenzhen, Guangdong, China

Tel.: (86)755-27521059

Fax: (86)755-27521011

Http://www.sz-ctc.org.cn



For anti-fake verification, please visit the official website of Certification and Accreditation Administration of the People's Republic of China : [yz.cnca.cn](http://yz.cnca.cn)



Conducted Emission					
Item	Test Equipment	Manufacturer	Model No.	Serial No.	Calibrated until
1	LISN	R&S	ENV216	101112	Dec. 12, 2024
2	LISN	R&S	ENV216	101113	Dec. 12, 2024
3	EMI Test Receiver	R&S	ESCS30	100353	Dec. 12, 2024
4	ISN CAT6	Schwarzbeck	NTFM 8158	CAT6-8158-0046	Dec. 12, 2024
5	ISN CAT5	Schwarzbeck	NTFM 8158	CAT5-8158-0046	Dec. 12, 2024
6	Test Software	R&S	EMC32	6.10.10	/

Note: 1. The Cal. Interval was one year.

2. The Cal. Interval was three years of the antenna.

3. The cable loss has been calculated in test result which connection between each test instruments.

### 3. TEST ITEM AND RESULTS

#### 3.1. Conducted Emission

**Limit**

FCC CFR Title 47 Part 15 Subpart C Section 15.207/ RSS - Gen 8.8

Frequency range (MHz)	Limit (dBuV)	
	Quasi-peak	Average
0.15-0.5	66 to 56*	56 to 46*
0.5-5	56	46
5-30	60	50

\* Decreases with the logarithm of the frequency.

**Test Configuration**

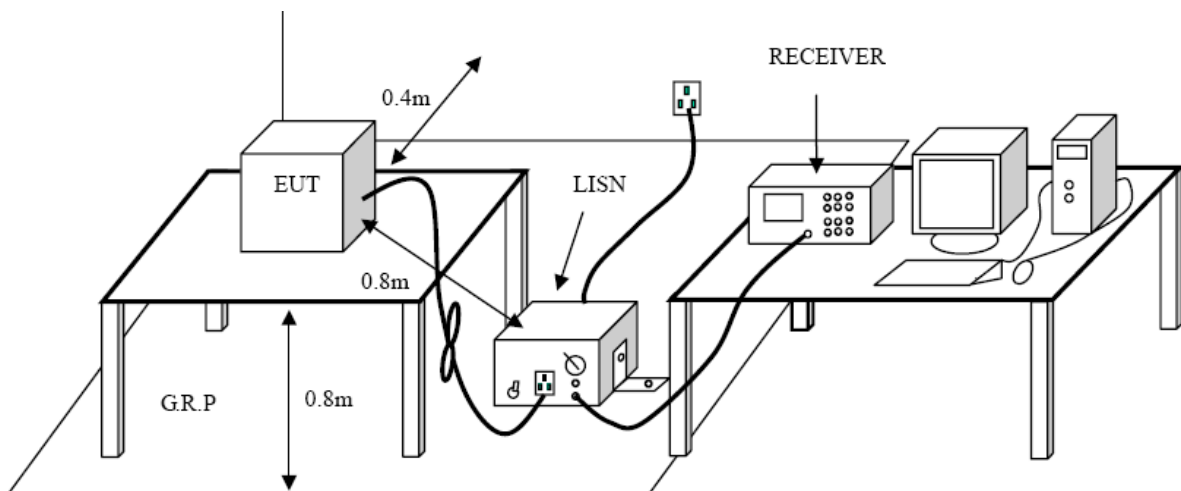

**Test Procedure**

1. The EUT was setup according to ANSI C63.10:2013 requirements.
2. The EUT was placed on a platform of nominal size, 1 m by 1.5 m, raised 80 cm above the conducting ground plane. The vertical conducting plane was located 40 cm to the rear of the EUT. All other surfaces of EUT were at least 80 cm from any other grounded conducting surface.
3. The EUT and simulators are connected to the main power through a line impedances stabilization network (LISN). The LISN provides a 50ohm /50uH coupling impedance for the measuring equipment. The peripheral devices are also connected to the main power through a LISN. (Please refer to the block diagram of the test setup and photographs)
4. Each current-carrying conductor of the EUT power cord, except the ground (safety) conductor, was individually connected through a LISN to the input power source.
5. The excess length of the power cord between the EUT and the LISN receptacle were folded back and forth at the center of the lead to form a bundle not exceeding 40 cm in length.
6. Conducted Emissions were investigated over the frequency range from 0.15MHz to 30MHz using a receiver bandwidth of 9 kHz.
7. During the above scans, the emissions were maximized by cable manipulation.



**Test Mode:**

Please refer to the clause 2.4.

**Test Results**

Not applicable.

### 3.2. Radiated Emission

**Limit**

FCC CFR Title 47 Part 15 Subpart C Section 15.209/ RSS – Gen 8.9

Frequency (MHz)	Field Strength (microvolts/meter)	Measurement Distance (meters)
0.009~0.490	2400/F(KHz)	300
0.490~1.705	24000/F(KHz)	30
1.705~30.0	30	30
30~88	100	3
88~216	150	3
216~960	200	3
960~1000	500	3

Frequency (MHz)	dB(uV/m) (at 3 meters)	
	Peak	Average
Above 1000	74	54

**Note:**

- (1) The tighter limit applies at the band edges.
- (2) Emission Level (dBuV/m)=20log Emission Level (uV/m).

**Test Configuration**

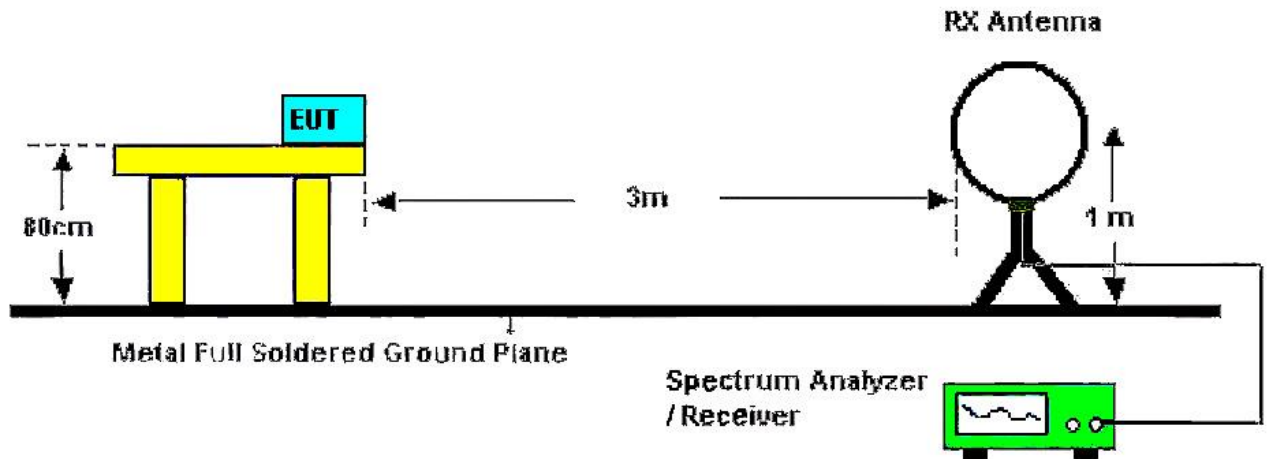

Below 30MHz Test Setup

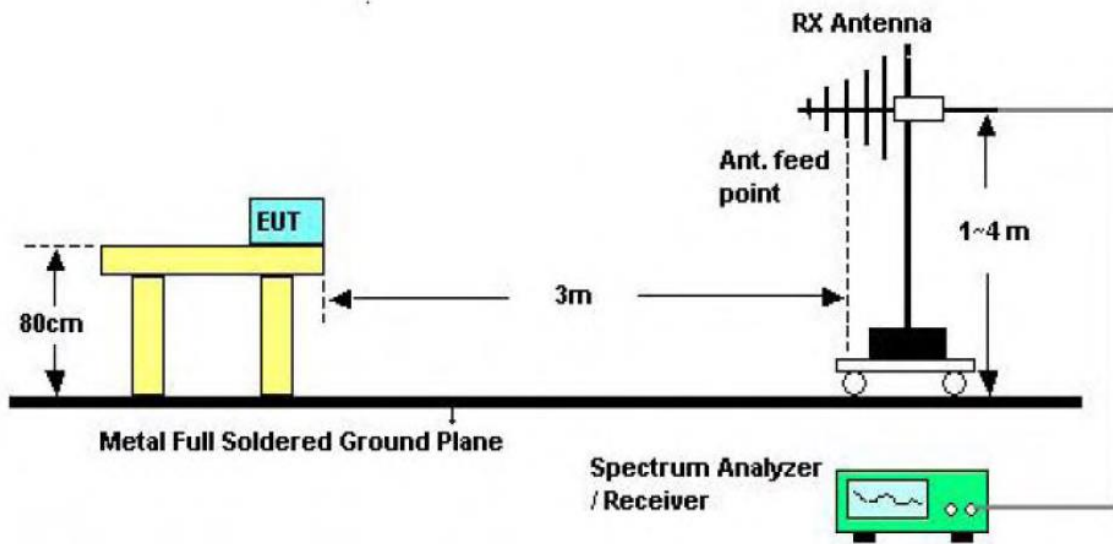

30-1000MHz Test Setup

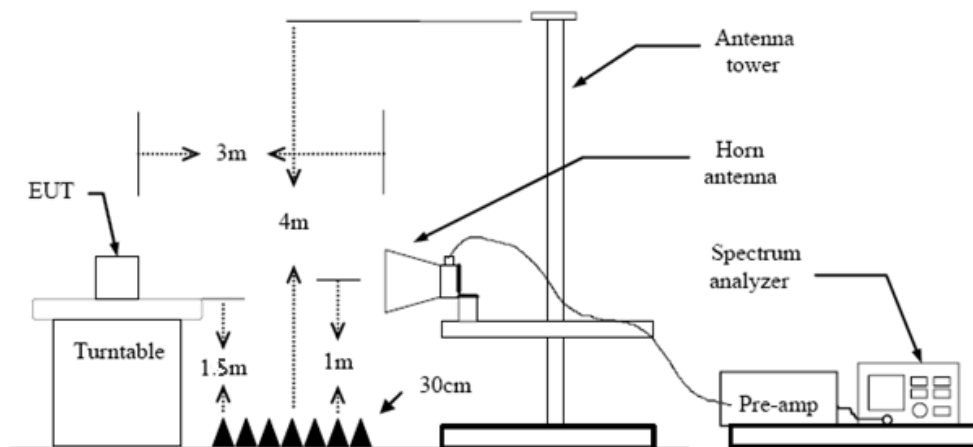

Above 1GHz Test Setup

### Test Procedure

1. The EUT was setup and tested according to ANSI C63.10:2013.
2. The EUT is placed on a turn table which is 0.8 meter above ground for below 1 GHz, and 1.5 m for above 1 GHz. The turn table is rotated 360 degrees to determine the position of the maximum emission level.
3. The EUT was set 3 meters from the receiving antenna, which was mounted on the top of a variable height antenna tower.
4. For each suspected emission, the EUT was arranged to its worst case and then tune the Antenna tower (from 1 m to 4 m) and turntable (from 0 degree to 360 degrees) to find the maximum reading. A pre-amp and a high pass filter are used for the test in order to get better signal level to comply with the guidelines.
5. Set to the maximum power setting and enable the EUT transmit continuously.
6. Use the following spectrum analyzer settings
  - (1) Span shall wide enough to fully capture the emission being measured;



(2) 9k – 150kHz:

RBW=300 Hz, VBW=1 kHz, Sweep=auto, Detector function=peak, Trace=max hold

(3) 0.15M – 30MHz:

RBW=10 kHz, VBW=30 kHz, Sweep=auto, Detector function=peak, Trace=max hold

(4) 30M - 1 GHz:

RBW=120 kHz, VBW=300 kHz, Sweep=auto, Detector function=peak, Trace=max hold

If the emission level of the EUT measured by the peak detector is 3 dB lower than the applicable limit, the peak emission level will be reported. Otherwise, the emission measurement will be repeated using the quasi-peak detector and reported.

(5) From 1 GHz to 10<sup>th</sup> harmonic:

RBW=1MHz, VBW=3MHz Peak detector for Peak value.

RBW=1MHz, VBW see note 1 with Peak Detector for Average Value.

Note 1: For measurements above 1 GHz the resolution bandwidth is set to 1 MHz, then the video bandwidth is set to 3 MHz for peak measurements and 1 MHz resolution bandwidth with 1/T video bandwidth with peak detector for average measurements. For the Duty Cycle please refer to clause 3.8 Duty Cycle.

### **Test Mode**

Please refer to the clause 2.4.

### **Test Result**

#### **9 KHz~30 MHz**

From 9 KHz to 30 MHz: Conclusion: PASS

Note: The amplitude of spurious emissions which are attenuated by more than 20dB below the permissible value has no need to be reported.



30MHz-1GHz

Ant. Pol.	Horizontal
Test Mode:	TX Zigbee Mode 2405MHz
Remark:	Only worse case is reported.

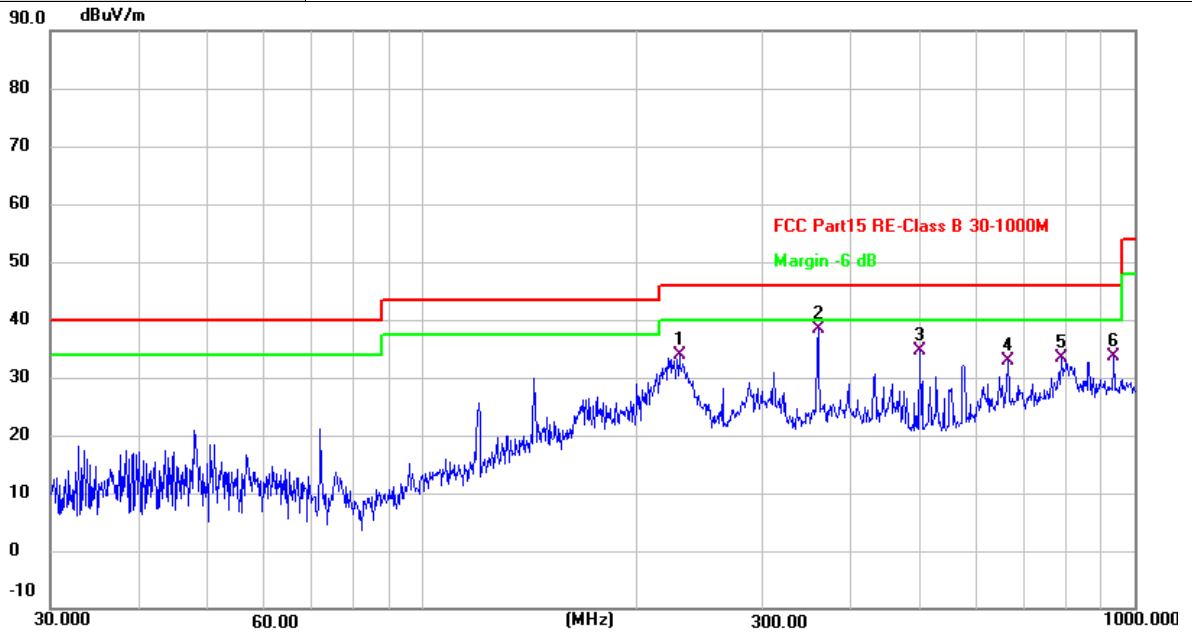

No.	Frequency (MHz)	Reading (dBuV)	Factor (dB/m)	Level (dBuV/m)	Limit (dBuV/m)	Margin (dB)	Detector
1	229.2930	50.74	-16.85	33.89	46.00	-12.11	QP
2 *	359.1860	51.52	-13.19	38.33	46.00	-7.67	QP
3	499.4246	45.02	-10.50	34.52	46.00	-11.48	QP
4	663.4728	40.32	-7.43	32.89	46.00	-13.11	QP
5	790.6187	38.98	-5.50	33.48	46.00	-12.52	QP
6	935.5463	37.30	-3.72	33.58	46.00	-12.42	QP

Remarks:

- 1. Factor (dB/m) = Antenna Factor (dB/m)+Cable Factor (dB)-Pre-amplifier Factor
- 2. Margin value = Level -Limit value





<b>Ant. Pol.</b>	Vertical
<b>Test Mode:</b>	TX Zigbee Mode 2405MHz
<b>Remark:</b>	Only worse case is reported.

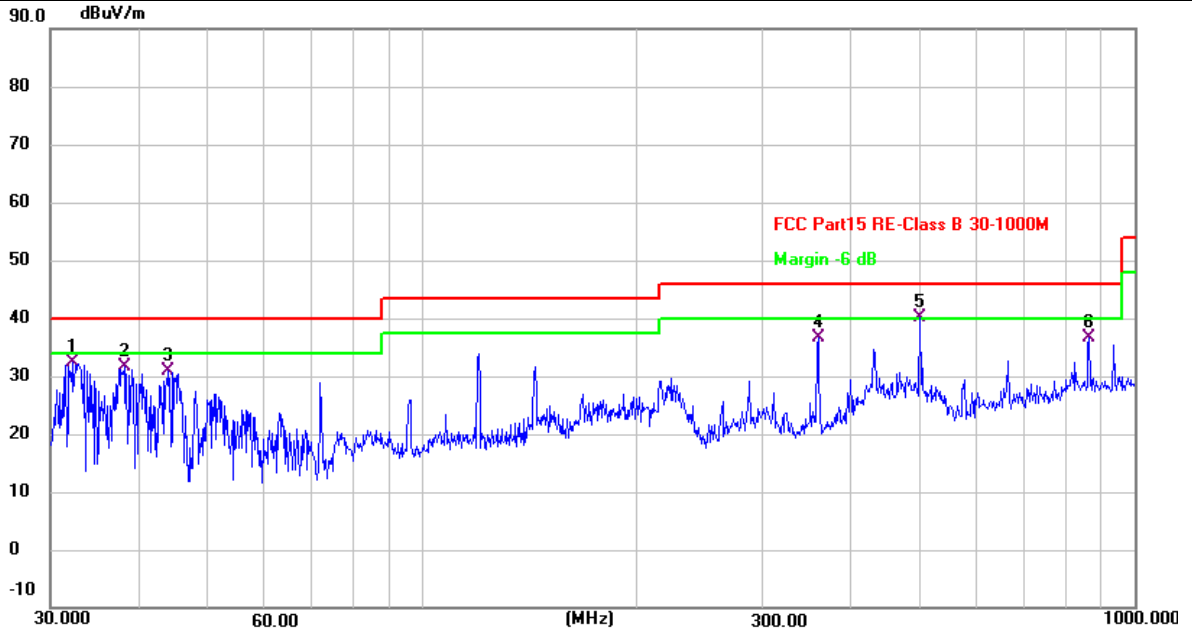

No.	Frequency (MHz)	Reading (dBuV)	Factor (dB/m)	Level (dBuV/m)	Limit (dBuV/m)	Margin (dB)	Detector
1	32.1795	50.20	-17.76	32.44	40.00	-7.56	QP
2	38.0783	48.51	-16.96	31.55	40.00	-8.45	QP
3	43.8119	46.79	-15.81	30.98	40.00	-9.02	QP
4	359.1860	49.86	-13.19	36.67	46.00	-9.33	QP
5 *	499.4247	50.53	-10.50	40.03	46.00	-5.97	QP
6	863.0561	41.10	-4.56	36.54	46.00	-9.46	QP

Remarks:

- 1. Factor (dB/m) = Antenna Factor (dB/m)+Cable Factor (dB)-Pre-amplifier Factor
- 2. Margin value = Level -Limit value



## Above 1GHz

<b>Ant. Pol.</b>	Horizontal
<b>Test Mode:</b>	TX Zigbee Mode 2405MHz
<b>Remark:</b>	No report for the emission which more than 20 dB below the prescribed limit.

No.	Frequency (MHz)	Reading (dBUV)	Factor (dB/m)	Level (dBUV/m)	Limit (dBUV/m)	Margin (dB)	Detector
1	1007.833	52.19	-8.34	43.85	74.00	-30.15	peak
2	1787.250	47.64	-6.56	41.08	74.00	-32.92	peak
3	4525.000	40.26	1.42	41.68	74.00	-32.32	peak
4	7211.833	38.86	10.03	48.89	74.00	-25.11	peak
5 *	9765.500	38.71	12.89	51.60	74.00	-22.40	peak
6	12620.750	34.85	16.13	50.98	74.00	-23.02	peak

## Remarks:

- Factor (dB/m) = Antenna Factor (dB/m)+Cable Factor (dB)-Pre-amplifier Factor
- Margin value = Level -Limit value

<b>Ant. Pol.</b>	Vertical
<b>Test Mode:</b>	TX Zigbee Mode 2405MHz
<b>Remark:</b>	No report for the emission which more than 20 dB below the prescribed limit.

No.	Frequency (MHz)	Reading (dBUV)	Factor (dB/m)	Level (dBUV/m)	Limit (dBUV/m)	Margin (dB)	Detector
1	1078.333	50.31	-8.11	42.20	74.00	-31.80	peak
2	1994.833	51.54	-5.27	46.27	74.00	-27.73	peak
3	2656.750	44.49	-2.74	41.75	74.00	-32.25	peak
4	5171.250	39.65	2.78	42.43	74.00	-31.57	peak
5	7215.750	41.75	10.03	51.78	74.00	-22.22	peak
6 *	12295.667	36.75	15.62	52.37	74.00	-21.63	peak

## Remarks:

- Factor (dB/m) = Antenna Factor (dB/m)+Cable Factor (dB)-Pre-amplifier Factor
- Margin value = Level -Limit value



<b>Ant. Pol.</b>	Horizontal
<b>Test Mode:</b>	TX Zigbee Mode 2440MHz
<b>Remark:</b>	No report for the emission which more than 20 dB below the prescribed limit.

No.	Frequency (MHz)	Reading (dBUV)	Factor (dB/m)	Level (dBUV/m)	Limit (dBUV/m)	Margin (dB)	Detector
1	1007.833	52.67	-8.34	44.33	74.00	-29.67	peak
2	1078.333	50.80	-8.11	42.69	74.00	-31.31	peak
3	1994.833	46.93	-5.27	41.66	74.00	-32.34	peak
4	5641.250	40.35	4.28	44.63	74.00	-29.37	peak
5	7317.583	39.16	10.07	49.23	74.00	-24.77	peak
6 *	10819.083	37.12	14.47	51.59	74.00	-22.41	peak

Remarks:

- 1.Factor (dB/m) = Antenna Factor (dB/m)+Cable Factor (dB)-Pre-amplifier Factor
- 2.Margin value = Level -Limit value

<b>Ant. Pol.</b>	Vertical
<b>Test Mode:</b>	TX Zigbee Mode 2440MHz
<b>Remark:</b>	No report for the emission which more than 20 dB below the prescribed limit.

No.	Frequency (MHz)	Reading (dBUV)	Factor (dB/m)	Level (dBUV/m)	Limit (dBUV/m)	Margin (dB)	Detector
1	1007.833	50.27	-8.34	41.93	74.00	-32.07	peak
2	1994.833	56.62	-5.27	51.35	74.00	-22.65	peak
3	2660.667	44.33	-2.73	41.60	74.00	-32.40	peak
4	5613.833	39.66	4.17	43.83	74.00	-30.17	peak
5 *	7321.500	41.96	10.07	52.03	74.00	-21.97	peak
6	10513.583	37.97	13.95	51.92	74.00	-22.08	peak

Remarks:

- 1.Factor (dB/m) = Antenna Factor (dB/m)+Cable Factor (dB)-Pre-amplifier Factor
- 2.Margin value = Level -Limit value



<b>Ant. Pol.</b>	Horizontal
<b>Test Mode:</b>	TX Zigbee Mode 2480MHz
<b>Remark:</b>	No report for the emission which more than 20 dB below the prescribed limit.

No.	Frequency (MHz)	Reading (dBUV)	Factor (dB/m)	Level (dBUV/m)	Limit (dBUV/m)	Margin (dB)	Detector
1	1007.833	52.75	-8.34	44.41	74.00	-29.59	peak
2	1078.333	50.81	-8.11	42.70	74.00	-31.30	peak
3	3972.750	40.54	0.44	40.98	74.00	-33.02	peak
4	6444.167	39.92	7.18	47.10	74.00	-26.90	peak
5	7442.917	39.97	10.10	50.07	74.00	-23.93	peak
6 *	11261.667	37.86	14.79	52.65	74.00	-21.35	peak

Remarks:

- 1.Factor (dB/m) = Antenna Factor (dB/m)+Cable Factor (dB)-Pre-amplifier Factor
- 2.Margin value = Level -Limit value

<b>Ant. Pol.</b>	Vertical
<b>Test Mode:</b>	TX Zigbee Mode 2480MHz
<b>Remark:</b>	No report for the emission which more than 20 dB below the prescribed limit.

No.	Frequency (MHz)	Reading (dBUV)	Factor (dB/m)	Level (dBUV/m)	Limit (dBUV/m)	Margin (dB)	Detector
1	1007.833	49.65	-8.34	41.31	74.00	-32.69	peak
2	1990.917	50.99	-5.30	45.69	74.00	-28.31	peak
3	3890.500	43.41	0.11	43.52	74.00	-30.48	peak
4	5637.333	39.44	4.26	43.70	74.00	-30.30	peak
5	7442.917	40.53	10.10	50.63	74.00	-23.37	peak
6 *	10928.750	36.81	14.59	51.40	74.00	-22.60	peak

Remarks:

- 1.Factor (dB/m) = Antenna Factor (dB/m)+Cable Factor (dB)-Pre-amplifier Factor
- 2.Margin value = Level -Limit value

### 3.3. Band Edge Emissions (Radiated)

**Limit**

FCC CFR Title 47 Part 15 Subpart C Section 15.247 (d)/ RSS-247 5.5:

Restricted Frequency Band (MHz)	(dBuV/m)(at 3m)	
	Peak	Average
2310 ~ 2390	74	54
2483.5 ~ 2500	74	54

Conducted band edge limit: The highest point of the operating frequency waveform down 20dB

**Test Configuration**

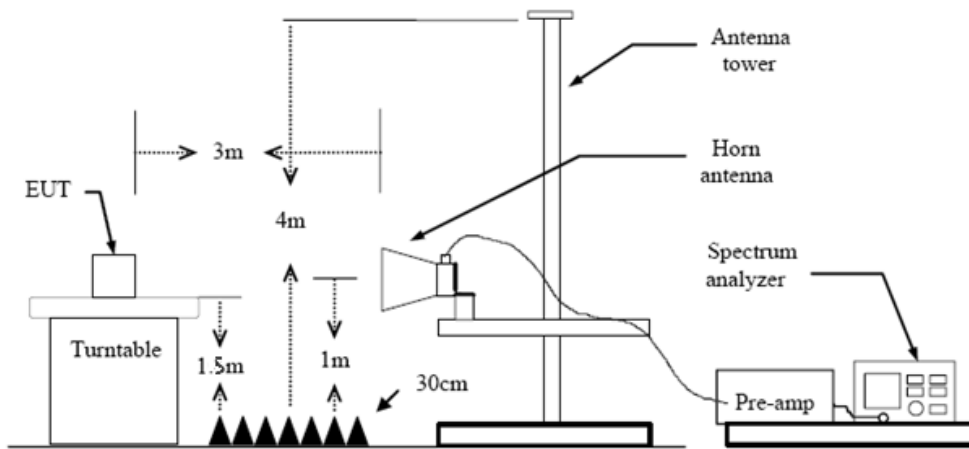

**Test Procedure**

1. The EUT was setup and tested according to ANSI C63.10:2013 requirements.
2. The EUT is placed on a turn table which is 1.5 meter above ground. The turn table is rotated 360 degrees to determine the position of the maximum emission level.
3. The EUT was positioned such that the distance from antenna to the EUT was 3 meters.
4. The antenna is scanned from 1 meter to 4 meters to find out the maximum emission level. This is repeated for both horizontal and vertical polarization of the antenna. In order to find the maximum emission, all of the interface cables were manipulated according to ANSI C63.10:2013 on radiated measurement.
5. The receiver set as follow:  
 RBW=1MHz, VBW=3MHz Peak detector for Peak value.  
 RBW=1MHz, VBW see note 1 with Peak Detector for Average Value.  
 Note 1: For measurements above 1 GHz the resolution bandwidth is set to 1 MHz, then the video bandwidth is set to 3 MHz for peak measurements and 1 MHz resolution bandwidth with 1/T video bandwidth with peak detector for average measurements. For the Duty Cycle please refer to clause 3.8 Duty Cycle.

**Test Mode**

Please refer to the clause 2.4.

**Test Results**

(1) Radiation Test

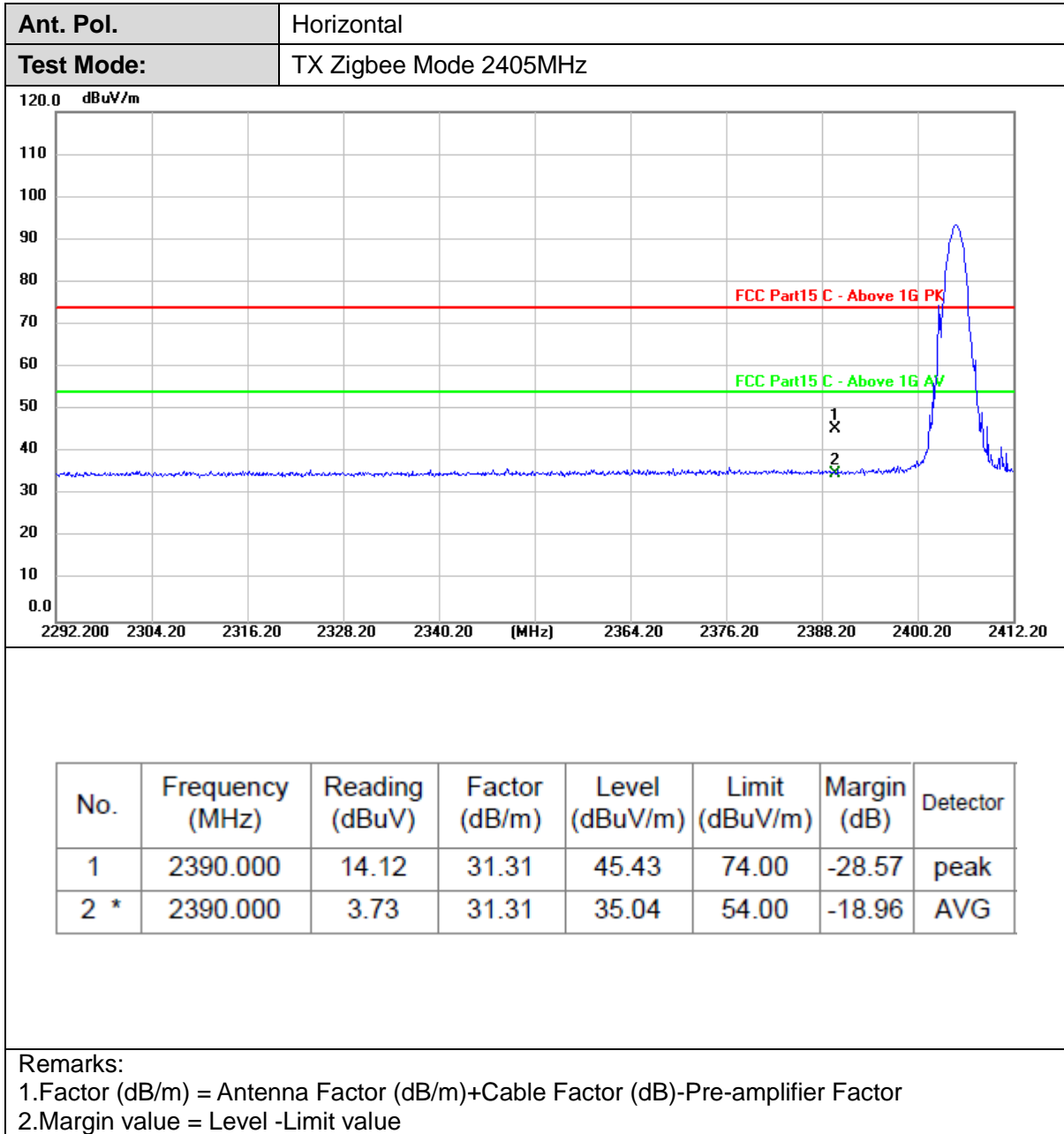



<b>Ant. Pol.</b>	Vertical
<b>Test Mode:</b>	TX Zigbee Mode 2405MHz

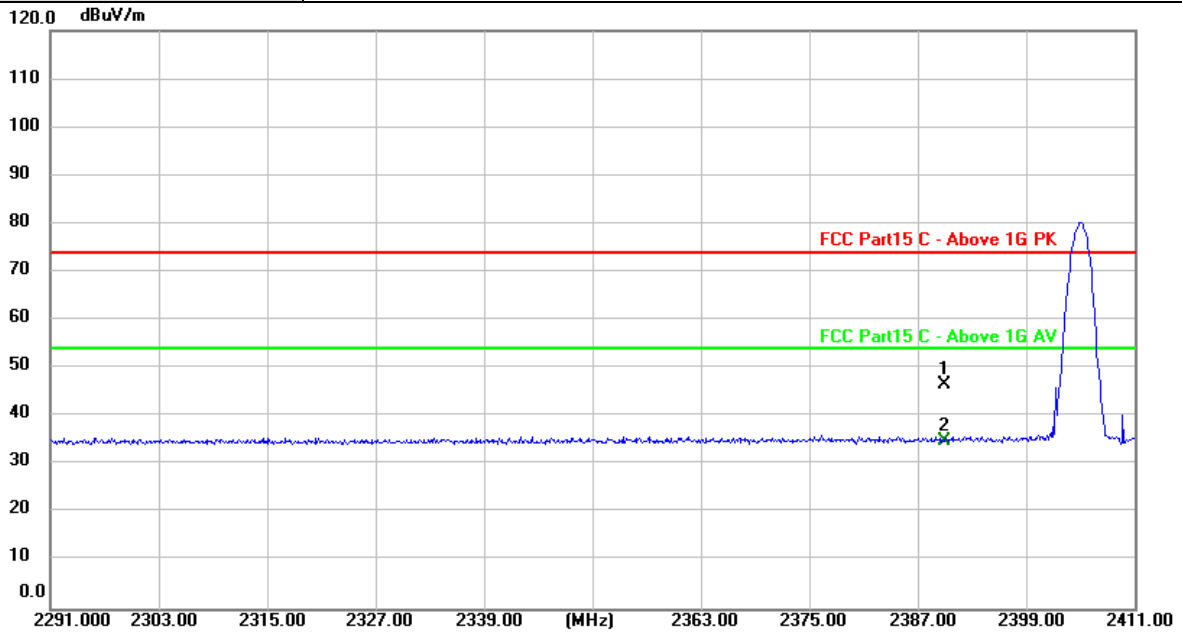

No.	Frequency (MHz)	Reading (dBuV)	Factor (dB/m)	Level (dBuV/m)	Limit (dBuV/m)	Margin (dB)	Detector
1	2390.000	15.31	31.31	46.62	74.00	-27.38	peak
2 *	2390.000	3.72	31.31	35.03	54.00	-18.97	AVG

Remarks:

- 1. Factor (dB/m) = Antenna Factor (dB/m)+Cable Factor (dB)-Pre-amplifier Factor
- 2. Margin value = Level -Limit value



Ant. Pol.	Horizontal
Test Mode:	TX Zigbee Mode 2480MHz

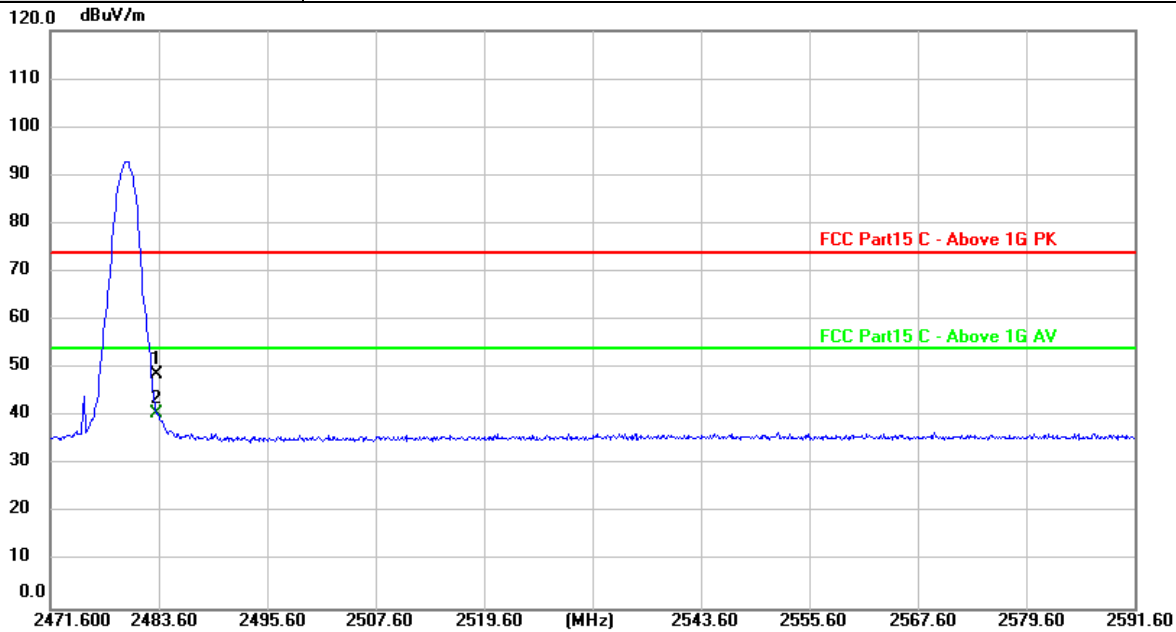

No.	Frequency (MHz)	Reading (dBuV)	Factor (dB/m)	Level (dBuV/m)	Limit (dBuV/m)	Margin (dB)	Detector
1	2483.500	17.15	31.48	48.63	74.00	-25.37	peak
2 *	2483.500	9.21	31.48	40.69	54.00	-13.31	AVG

Remarks:

- 1. Factor (dB/m) = Antenna Factor (dB/m)+Cable Factor (dB)-Pre-amplifier Factor
- 2. Margin value = Level -Limit value





<b>Ant. Pol.</b>	Vertical
<b>Test Mode:</b>	TX Zigbee Mode 2480MHz

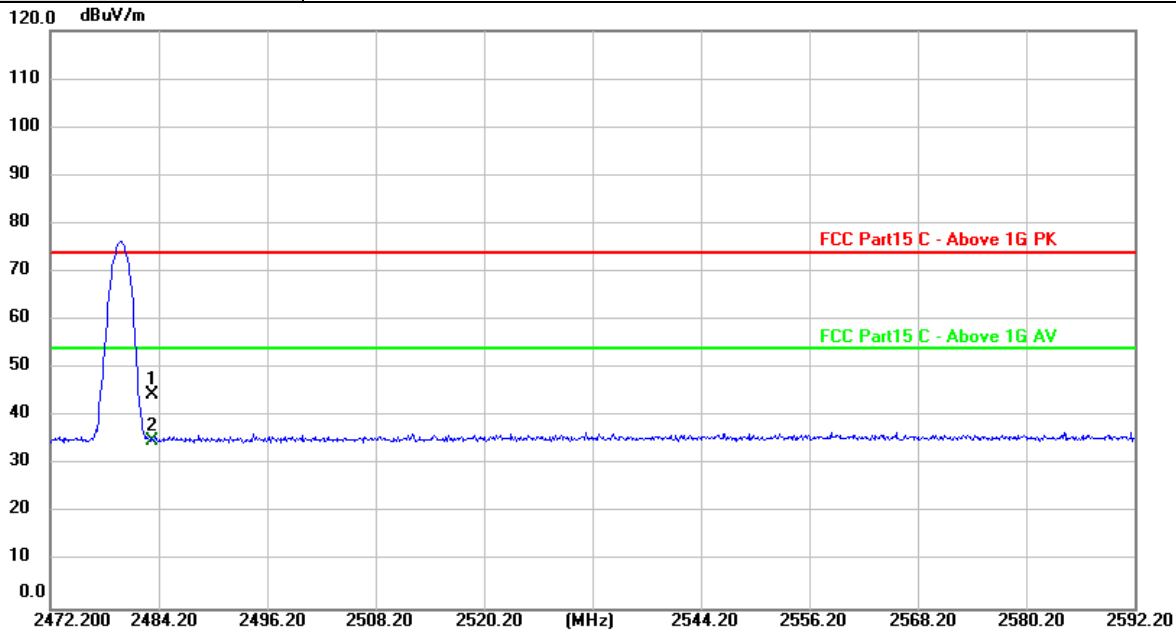

No.	Frequency (MHz)	Reading (dBuV)	Factor (dB/m)	Level (dBuV/m)	Limit (dBuV/m)	Margin (dB)	Detector
1	2483.500	13.08	31.48	44.56	74.00	-29.44	peak
2 *	2483.500	3.56	31.48	35.04	54.00	-18.96	AVG

Remarks:

1. Factor (dB/m) = Antenna Factor (dB/m)+Cable Factor (dB)-Pre-amplifier Factor
2. Margin value = Level -Limit value

### 3.4. Band edge and Spurious Emissions (Conducted)

#### Limit

FCC CFR Title 47 Part 15 Subpart C Section 15.247 (d): In any 100 kHz bandwidth outside the frequency band in which the spread spectrum intentional radiator is operating, the radio frequency power that is produced by the intentional radiator shall be at least 20 dB below that in the 100 kHz bandwidth within the band that contains the highest level of the desired power, based on either an RF conducted or a radiated measurement.

#### Test Configuration

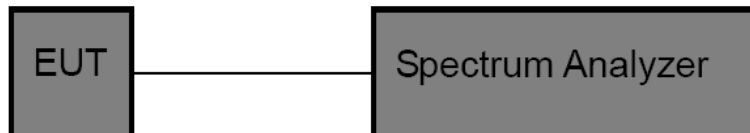

#### Test Procedure

1. The transmitter output was connected to the spectrum analyzer through an attenuator, the path loss was compensated to the results for each measurement.
2. Set to the maximum power setting and enable the EUT transmit continuously
3. Use the following spectrum analyzer settings:  
RBW = 100 kHz, VBW ≥ RBW, scan up through 10<sup>th</sup> harmonic.  
Sweep = auto, Detector function = peak, Trace = max hold
4. Measure and record the results in the test report.

#### Test Mode

Please refer to the clause 2.4.

#### Test Results

Mode	Channel	OOB Emission Frequency (MHz)	OOB Emission Level (dBm)	Limit (dBm)	Over Limit (dB)	Result
Zigbee	CH11	2400.00	-54.741	-15.37	-39.371	PASS
		2395.40	-47.802	-15.37	-32.432	PASS
	CH18	21649.6	-52.440	-15.37	-37.070	PASS
	CH26	14639.70	-42.593	-15.01	-27.583	PASS
		2483.50	-48.818	-15.49	-33.328	PASS



Test Graphs:



In-Band Reference Level Channel 11

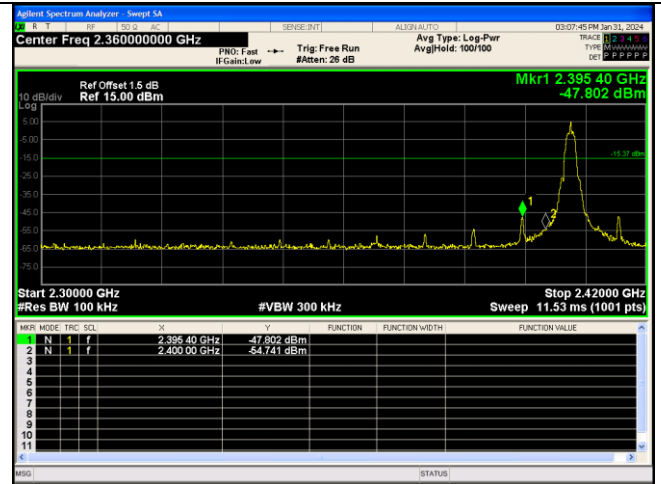

Out Of Band Emission Channel 11

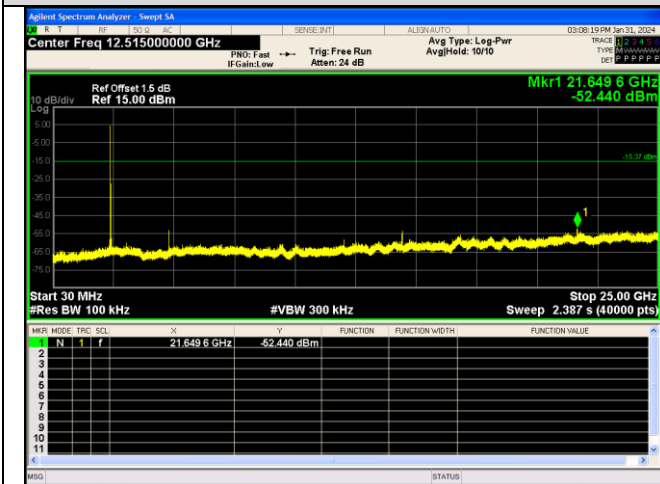

Spurious Emission Channel 11

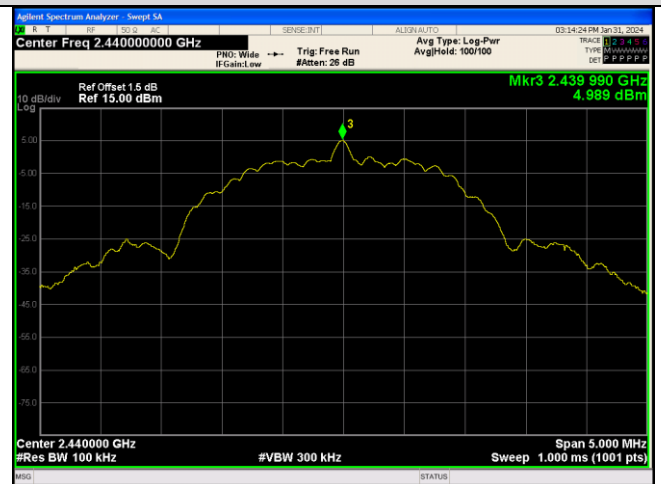

In-Band Reference Level Channel 18

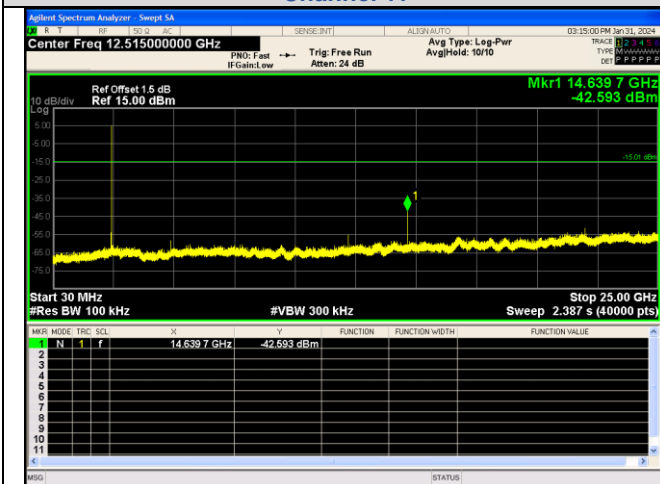

Spurious Emissions Channel 18

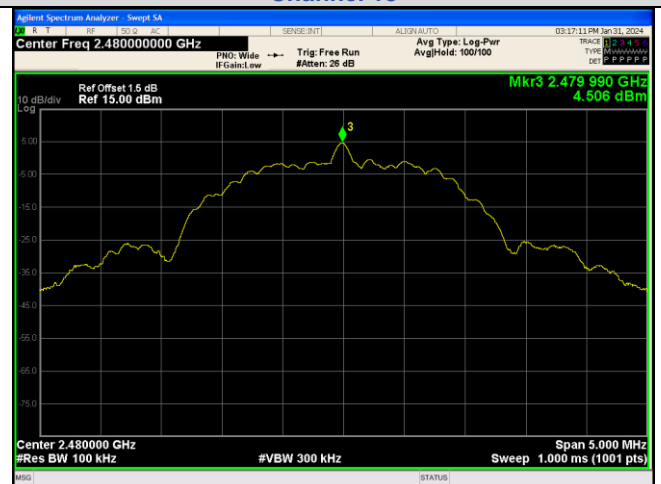

In-Band Reference Level Channel 26

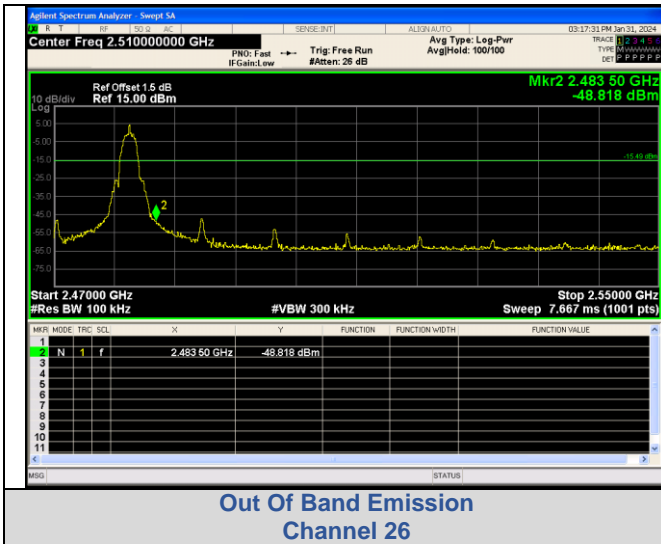

Out Of Band Emission Channel 26

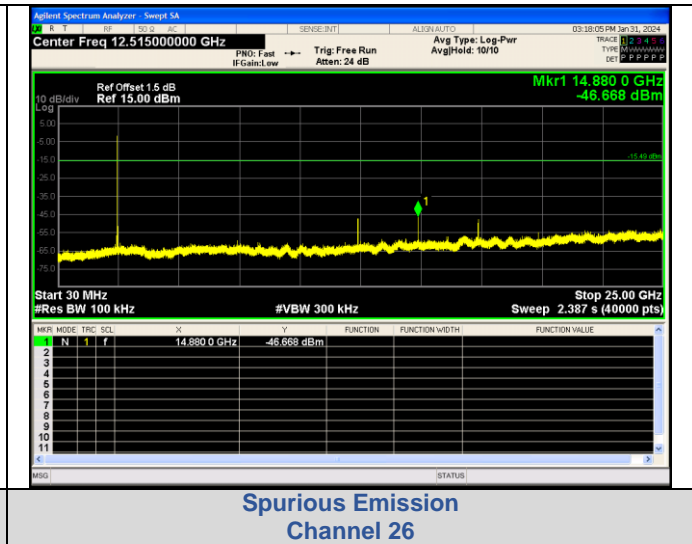

Spurious Emission Channel 26

### 3.5. DTS Bandwidth

**Limit**

FCC CFR Title 47 Part 15 Subpart C Section 15.247 (a)(2)/ RSS-247 5.2 a:

Test Item	Limit	Frequency Range(MHz)
DTS Bandwidth	≥500 KHz (6dB bandwidth)	2400~2483.5

**Test Configuration**

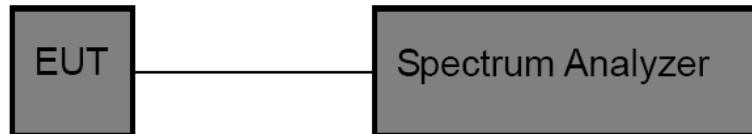

**Test Procedure**

- The EUT was directly connected to the spectrum analyzer and antenna output port as show in the block diagram above.
- DTS Spectrum Setting:
  - Set RBW = 100 kHz.
  - Set the video bandwidth (VBW) ≥ 3 RBW.
  - Detector = Peak.
  - Trace mode = Max hold.
  - Sweep = Auto couple.
- OCB Spectrum Setting:
  - Set RBW = 1% ~ 5% occupied bandwidth.
  - Set the video bandwidth (VBW) ≥ 3 RBW.
  - Detector = Peak.
  - Trace mode = Max hold.
  - Sweep = Auto couple.

NOTE: The EUT was set to continuously transmitting in each mode and low, Middle and high channel for the test.

**Test Mode**

Please refer to the clause 2.4.

**Test Results**

Test Mode	Channel	99% Bandwidth (MHz)	DTS Bandwidth (MHz)	Limit (kHz)	Result
Zigbee	CH11	2.1549	0.7878	≥500	Pass
	CH18	2.1578	0.7901		
	CH26	2.1626	0.7831		



99% Bandwidth:

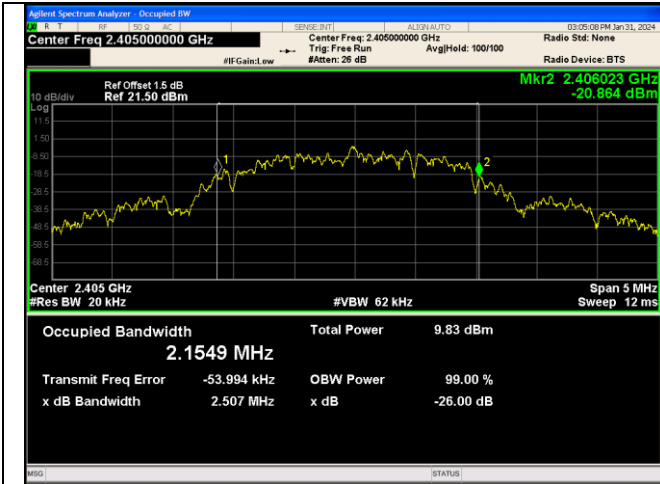

Channel 11

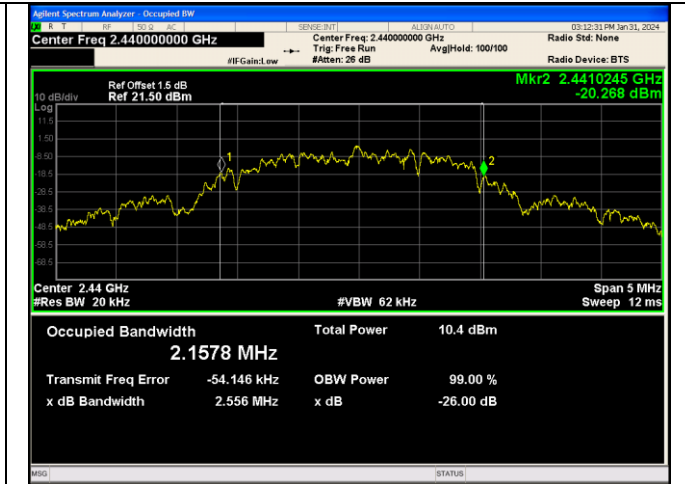

Channel 18

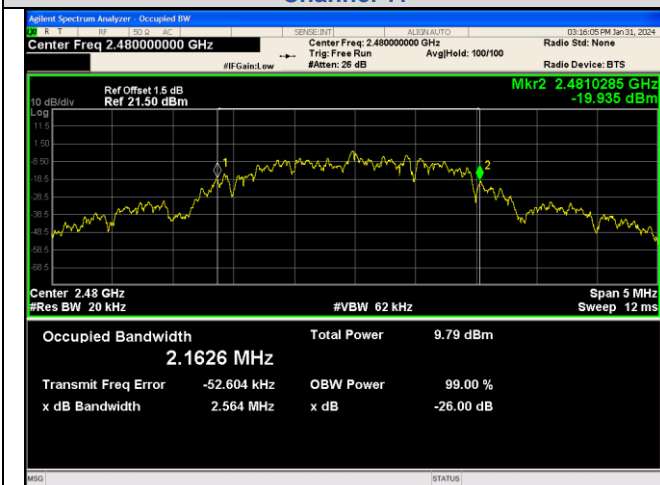

Channel 26



DTS Bandwidth:

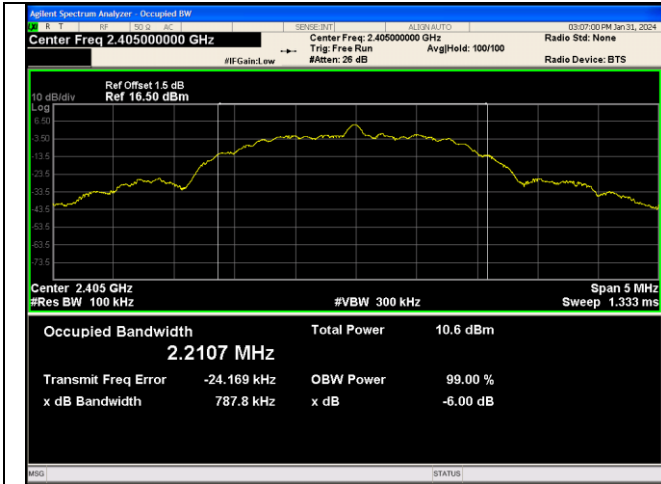

Channel 11

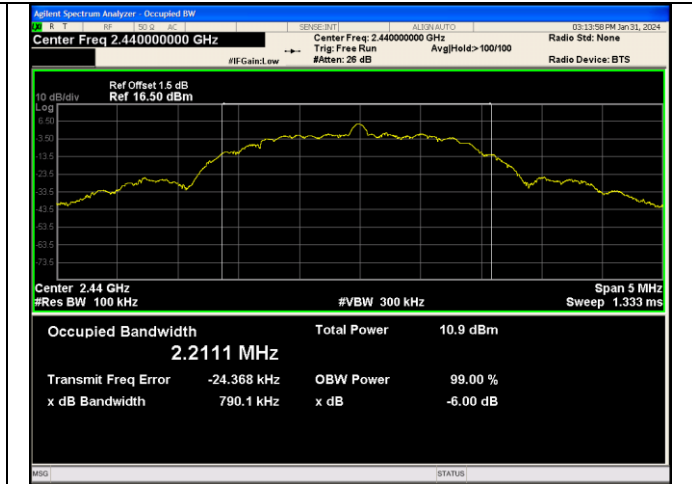

Channel 11

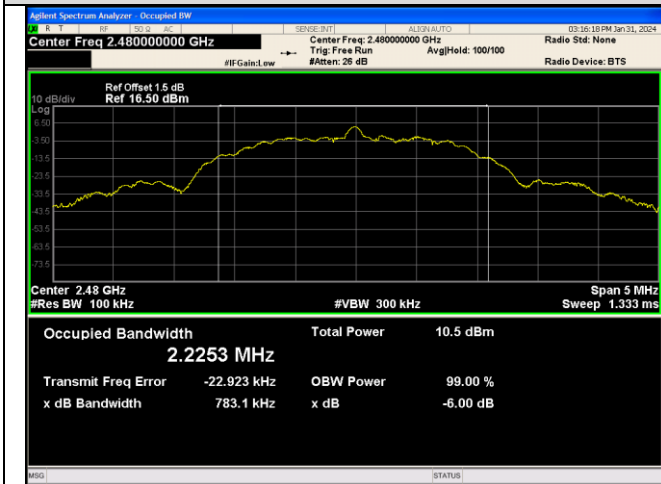

Channel 26

### 3.6. Peak Output Power

**Limit**

FCC CFR Title 47 Part 15 Subpart C Section 15.247 (b)(3)/ RSS-247 5.4 d:

Section	Test Item	Limit	Frequency Range(MHz)
CFR 47 FCC 15.247(b)(3)	Maximum conducted output power	1 Watt or 30dBm	2400~2483.5
ISED RSS-247 5.4 d	EIRP	4 Watt or 36dBm	2400~2483.5

**Test Configuration**

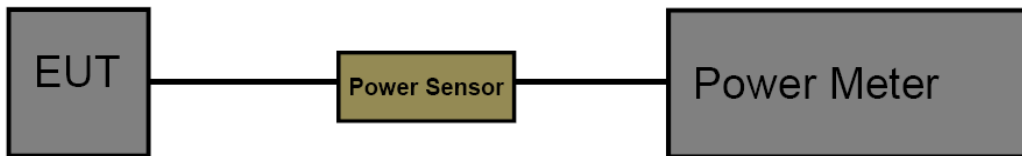

**Test Procedure**

1. The maximum conducted output power may be measured using a broadband Peak RF power meter.
2. Peak power measurements were performed only when the EUT was transmitting at its maximum power control level using a broadband power meter with a pulse sensor.
3. The power meter implemented triggering and gating capabilities which were set up such that power measurements were recorded only during the ON time of the transmitter.
4. Record the measurement data.

**Test Mode**

Please refer to the clause 2.4.

**Test Result**

Test Mode	Channel	Peak Output power (dBm)	Limit (dBm)	Result
Zigbee	CH11	4.556	≤30.00	Pass
	CH18	5.019		
	CH26	4.529		

Test Mode	Channel	EIRP (dBm)	Limit (dBm)	Result
Zigbee	CH11	6.626	≤36.00	Pass
	CH18	7.089		
	CH26	6.599		



### 3.7. Power Spectral Density

#### Limit

FCC CFR Title 47 Part 15 Subpart C Section 15.247 (e)/ RSS-247 5.2 b:

Test Item	Limit	Frequency Range(MHz)
Power Spectral Density	8dBm(in any 3 kHz)	2400~2483.5

#### Test Configuration

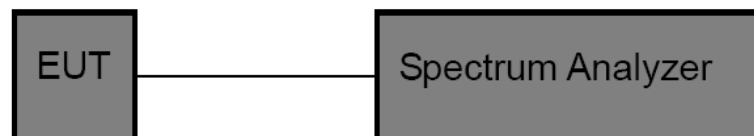

#### Test Procedure

1. The EUT was directly connected to the spectrum analyzer and antenna output port as show in the block diagram above.
2. The EUT was directly connected to the Spectrum Analyzer and antenna output port as show in the block diagram above. The measurement according to section 10.2 of KDB 558074 D01 DTS Meas Guidance v05r02.
3. Spectrum Setting:  
Set analyzer center frequency to DTS channel center frequency.  
Set the span to 1.5 times the DTS bandwidth.  
Set the RBW to: 3 kHz  
Set the VBW to: 10 kHz  
Detector: peak  
Sweep time: auto  
Allow trace to fully stabilize. Then use the peak marker function to determine the maximum amplitude level.

#### Test Mode

Please refer to the clause 2.4.

#### Test Result

Test Mode	Channel	Power Spectral Density (dBm/3kHz)	Limit (dBm/3kHz)	Result
Zigbee	CH11	-9.544	≤8.00	Pass
	CH18	-8.957		
	CH26	-9.534		



Test Graphs:

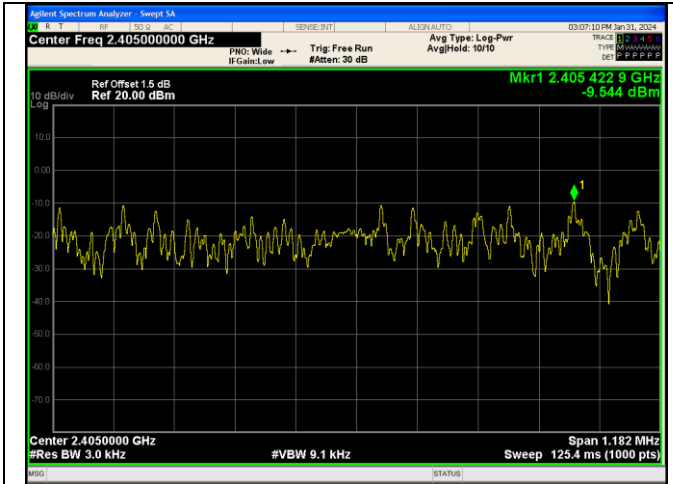

Channel 11

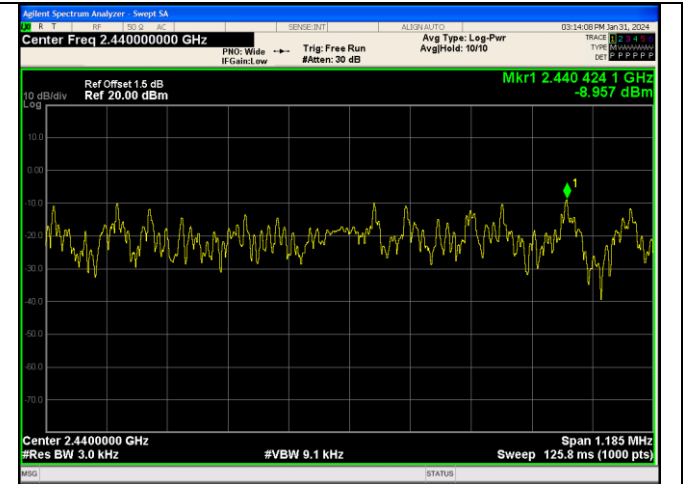

Channel 18

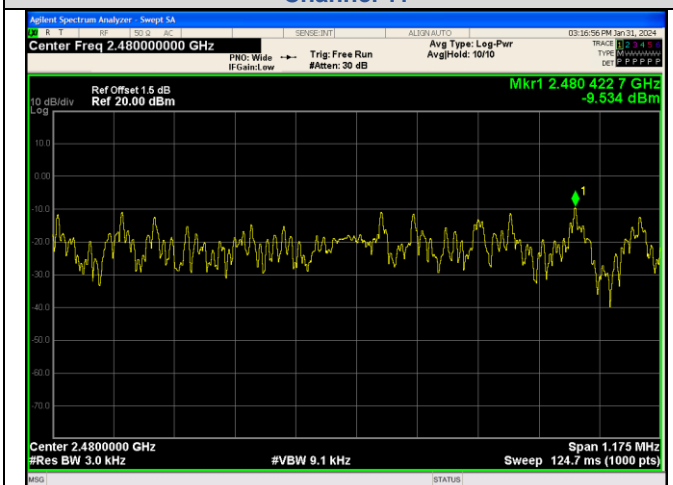

Channel 26

### 3.8. Duty Cycle

#### Limit

None, for report purposes only.

#### Test Configuration

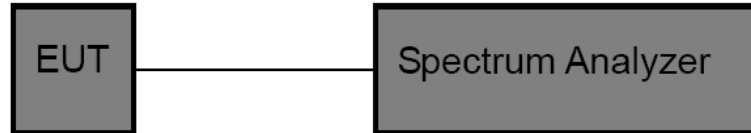

#### Test Procedure

1. The EUT was directly connected to the spectrum analyzer and antenna output port as show in the block diagram above.
2. The EUT was directly connected to the Spectrum Analyzer and antenna output port as show in the block diagram above. The measurement according to section 10.2 of KDB 558074 D01 DTS Meas Guidance v05r02.
3. Spectrum Setting:  
Set analyzer center frequency to test channel center frequency.  
Set the span to 0Hz  
Set the RBW to 10MHz  
Set the VBW to 10MHz  
Detector: Peak  
Sweep time: Auto  
Allow trace to fully stabilize. Then use the peak marker function to determine the maximum amplitude level.

#### Test Mode

Please refer to the clause 2.4.

#### Test Result

Mode	Channel	On Time (ms)	Period (ms)	Duty Cycle (%)	1/T Minimum VBW (kHz)	Final setting For VBW (kHz)
Zigbee	CH11	0.382	0.655	58.27	2.62	3
	CH18	0.382	0.655	58.27	2.62	3
	CH26	0.382	0.655	58.27	2.62	3

Note: Duty Cycle>98%, VBW=10Hz



Test Graphs:

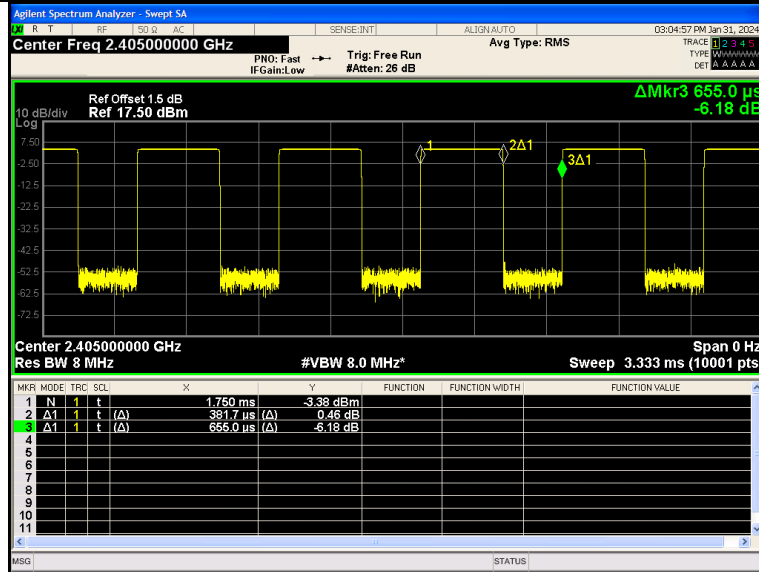

Channel 11

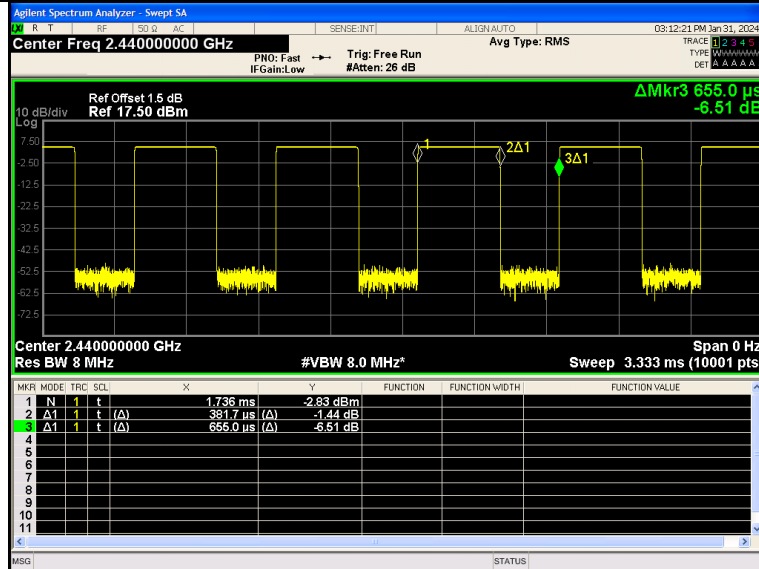

Channel 18

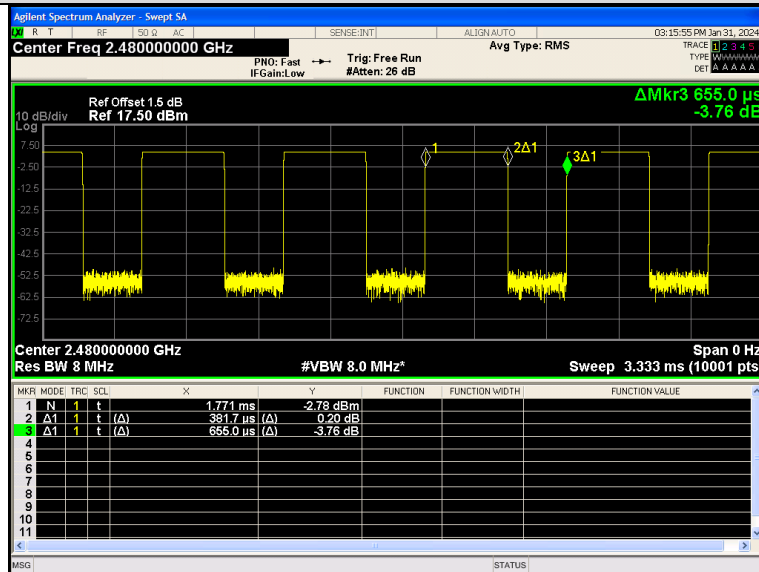

Channel 26





### 3.9. Antenna Requirement

#### Requirement

**FCC CFR Title 47 Part 15 Subpart C Section 15.203:**

An intentional radiator shall be designed to ensure that no antenna other than that furnished by the responsible party shall be used with the device. The use of a permanently attached antenna or of antenna that uses a unique coupling to the intentional radiator, the manufacturer may design the unit so that a broken antenna can be replaced by the user, but the use of a standard antenna jack or electrical connector is prohibited.

**FCC CFR Title 47 Part 15 Subpart C Section 15.247(c) (1)(i):**

(i) Systems operating in the 2400~2483.5 MHz band that is used exclusively for fixed. Point-to-point operations may employ transmitting antennas with directional gain greater than 6dBi provided the maximum conducted output power of the intentional radiator is reduced by 1 dB for every 3 dB that the directional gain of the antenna exceeds 6dBi.

#### Test Result

The directional gain of the antenna less than 6dBi, please refer to the EUT internal photographs antenna photo.

\*\*\*\*\*THE END\*\*\*\*\*