

镭雕位置

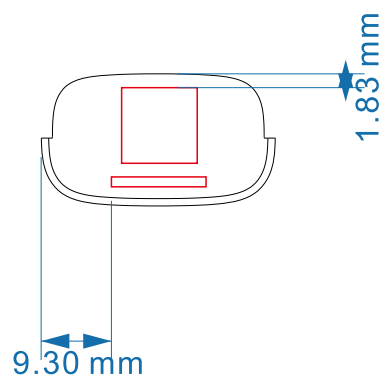

二维码镭雕

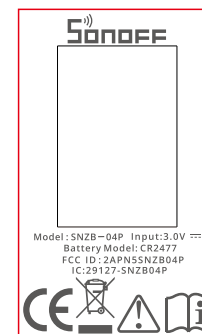

镭雕内容

SONOFF
松诺技术

物料名称：SNZB-04P镭雕 V1.0

材料工艺：镭雕

尺寸规格：

编制日期：2023.4.23

备注：镭雕灰色跟样品，红色线框不镭雕