



CTC Laboratories, Inc.

1-2/F., Building 2, Jiaquan Building, Guanlan High-Tech Park, Shenzhen, Guangdong, China
Tel: +86-755-27521059 Fax: +86-755-27521011 <http://www.sz-ctc.org.cn>

TEST REPORT

Report No.: **CTC20230838E03**

FCC ID.....: **2APN5NSPANELPRO**

Applicant.....: **Shenzhen Sonoff Technologies Co.,Ltd.**

Address.....: 3F & 6F, Bldg A, No. 663, Bulong Rd, Shenzhen, Guangdong, China

Manufacturer.....: Shenzhen Sonoff Technologies Co.,Ltd.

Address.....: 3F & 6F, Bldg A, No. 663, Bulong Rd, Shenzhen, Guangdong, China

Product Name.....: **SONOFF NSPanel Pro Smart Home Control Panel**

Trade Mark.....: Sonoff

Model/Type reference.....: NSPanel86PB

Listed Model(s): NSPanel86PW, NSPanel86PG

Standard.....: **FCC CFR Title 47 Part 15 Subpart C Section 15.247**

Date of receipt of test sample...: Apr. 14, 2023

Date of testing.....: Apr. 14, 2023 to May 23, 2023

Date of issue.....: May 24, 2023

Result.....: **PASS**

Compiled by:		
(Printed name+signature)	Jim Jiang	
Supervised by:		
(Printed name+signature)	Eric Zhang	
Approved by:		
(Printed name+signature)	Totti Zhao	

This test report may be duplicated completely for legal use with the approval of the applicant. It should not be reproduced except in full, without the written approval of our laboratory. The client should not use it to claim product endorsement by CTC. The test results in the report only apply to the tested sample. The test report shall be invalid without all the signatures of testing engineers, reviewer and approver. Any objections must be raised to CTC within 15 days since the date when the report is received. It will not be taken into consideration beyond this limit. The test report merely correspond to the test sample.



Table of Contents

Page

1. TEST SUMMARY 3

1.1. TEST STANDARDS..... 3

1.2. REPORT VERSION 3

1.3. TEST DESCRIPTION..... 3

1.4. TEST FACILITY 4

1.5. MEASUREMENT UNCERTAINTY 4

1.6. ENVIRONMENTAL CONDITIONS..... 5

2. GENERAL INFORMATION 6

2.1. CLIENT INFORMATION 6

2.2. GENERAL DESCRIPTION OF EUT 6

2.3. ACCESSORY EQUIPMENT INFORMATION 7

2.4. OPERATION STATE 8

2.5. MEASUREMENT INSTRUMENTS LIST 9

3. TEST ITEM AND RESULTS 11

3.1. CONDUCTED EMISSION..... 11

3.2. RADIATED EMISSION 14

3.3. BAND EDGE EMISSIONS (RADIATED) 31

3.4. BAND EDGE AND SPURIOUS EMISSIONS (CONDUCTED) 48

3.5. DTS BANDWIDTH..... 65

3.6. PEAK OUTPUT POWER 75

3.7. POWER SPECTRAL DENSITY 76

3.8. DUTY CYCLE 81

3.9. ANTENNA REQUIREMENT..... 86



1. TEST SUMMARY

1.1. Test Standards

The tests were performed according to following standards:

[FCC Rules Part 15.247](#): Operation within the bands of 902-928MHz, 2400-2483.5MHz, and 5725-5850MHz.

[RSS 247 Issue 2](#): Standard Specifications for Frequency Hopping Systems (FHSs) and Digital Transmission Systems (DTSs) Operating in the Bands 902-928MHz, 2400-2483.5MHz and 5725-5850MHz.

[ANSI C63.10-2013](#): American National Standard for Testing Unlicensed Wireless Devices.

1.2. Report Version

Revised No.	Date of issue	Description
01	May 24, 2023	Original

1.3. Test Description

FCC Part 15 Subpart C (15.247) / RSS 247 Issue 2				
Test Item	Standard Section		Result	Test Engineer
	FCC	IC		
Antenna Requirement	15.203	/	Pass	Jim Jiang
Conducted Emission	15.207	RSS-Gen 8.8	Pass	Jim Jiang
Band Edge Emissions	15.247(d)	RSS 247 5.5	Pass	Jim Jiang
6dB Bandwidth	15.247(a)(2)	RSS 247 5.2 (a)	Pass	Jim Jiang
Conducted Max Output Power	15.247(b)(3)	RSS 247 5.4 (d)	Pass	Jim Jiang
Power Spectral Density	15.247(e)	RSS 247 5.2 (b)	Pass	Jim Jiang
Transmitter Radiated Spurious	15.209&15.247(d)	RSS 247 5.5& RSS-Gen 8.9	Pass	Jim Jiang

Note:

(1)N/A: Not applicable.

(2)The measurement uncertainty is not included in the test result.



1.4. Test Facility

CTC Laboratories, Inc.

Add: 1-2/F., Building 2, Jiaquan Building, Guanlan High-Tech Park, Shenzhen, Guangdong, China

Laboratory accreditation

The test facility is recognized, certified, or accredited by the following organizations:

A2LA-Lab Cert. No.: 4340.01

CTC Laboratories, Inc. EMC Laboratory has been accredited by A2LA for technical competence in the field of electrical testing, and proved to be in compliance with ISO/IEC 17025:2017 General Requirements for the Competence of Testing and Calibration Laboratories and any additional program requirements in the identified field of testing.

Industry Canada (Registration No.: 9783A, CAB Identifier: CN0029)

CTC Laboratories, Inc. EMC Laboratory has been registered by Certification and Engineer Bureau of Industry Canada for the performance of with Registration NO.: 9783A on Jan, 2016.

FCC (Registration No.: 951311, Designation Number CN1208)

CTC Laboratories, Inc. EMC Laboratory has been registered and fully described in a report filed with the (FCC) Federal Communications Commission. The acceptance letter from the FCC is maintained in our files. Registration 951311, Aug 26, 2017.

1.5. Measurement Uncertainty

The data and results referenced in this document are true and accurate. The reader is cautioned that there may be errors within the calibration limits of the equipment and facilities. The measurement uncertainty was calculated for all measurements listed in this test report acc. to TR-100028-01 "Electromagnetic compatibility and Radio spectrum Matters (ERM); Uncertainties in the measurement of mobile radio equipment characteristics; Part 1" and TR-100028-02 "Electromagnetic compatibility and Radio spectrum Matters (ERM); Uncertainties in the measurement of mobile radio equipment characteristics; Part 2" and is documented in the CTC Laboratories, Inc. quality system acc. to DIN EN ISO/IEC 17025. Furthermore, component and process variability of devices similar to that tested may result in additional deviation. The manufacturer has the sole responsibility of continued compliance of the device.

Below is the best measurement capability for CTC Laboratories, Inc.



Test Items	Measurement Uncertainty	Notes
Transmitter power conducted	0.42 dB	(1)
Transmitter power Radiated	2.14 dB	(1)
Conducted spurious emissions 9kHz~40GHz	1.60 dB	(1)
Radiated spurious emissions 9kHz~40GHz	2.20 dB	(1)
Conducted Emissions 9kHz~30MHz	3.20 dB	(1)
Radiated Emissions 30~1000MHz	4.70 dB	(1)
Radiated Emissions 1~18GHz	5.00 dB	(1)
Radiated Emissions 18~40GHz	5.54 dB	(1)
Occupied Bandwidth	-----	(1)

Note (1): This uncertainty represents an expanded uncertainty expressed at approximately the 95% confidence level using a coverage factor of k=2.

1.6. Environmental Conditions

During the measurement the environmental conditions were within the listed ranges:

Temperature:	21°C~27°C
Relative Humidity:	40%~60%
Atmospheric Pressure:	101kPa



2. GENERAL INFORMATION

2.1. Client Information

Applicant:	Shenzhen Sonoff Technologies Co.,Ltd.
Address:	3F & 6F, Bldg A, No. 663, Bulong Rd, Shenzhen, Guangdong, China
Manufacturer:	Shenzhen Sonoff Technologies Co.,Ltd.
Address:	3F & 6F, Bldg A, No. 663, Bulong Rd, Shenzhen, Guangdong, China

2.2. General Description of EUT

Product Name:	SONOFF NSPanel Pro Smart Home Control Panel
Trade Mark:	Sonoff
Model/Type reference:	NSPanel86PB
Listed Model(s):	NSPanel86PW, NSPanel86PG
Model Difference:	All these models are identical in the same PCB, layout, electrical circuit and enclosure. The difference is the model name and appearance color.
Power supply:	Input: 100-240V~ 50/60Hz 150mA
Hardware version:	/
Software version:	/
2.4G WIFI 802.11b/ g/ n(HT20)/ n(HT40)	
Modulation:	802.11b: DSSS(CCK, DQPSK, DBPSK) 802.11g/n: OFDM(BPSK, QPSK, 16QAM, 64QAM)
Operation frequency:	802.11b/g/n(HT20): 2412MHz~2462MHz 802.11n(HT40): 2422MHz~2452MHz
Channel number:	802.11b/g/n(HT20): 11 channels 802.11n(HT40): 7 channels
Channel separation:	5MHz
Antenna type:	FPC Antenna
Antenna gain:	2.0dBi



2.3. Accessory Equipment Information

Equipment Information			
Name	Model	S/N	Manufacturer
Notebook	ThinkPad X220	/	Lenovo
Cable Information			
Name	Shielded Type	Ferrite Core	Length
USB Cable	Unshielded	NO	120cm
Test Software Information			
Name	Version	/	/
adb driver	/	/	/



2.4. Operation State

Operation Frequency List: The EUT has been tested under typical operating condition. The Applicant provides communication tools software to control the EUT for staying in continuous transmitting and receiving mode for testing.

Operation Frequency List:

Channel	Frequency (MHz)
01	2412
02	2417
03	2422
04	2427
05	2432
06	2437
07	2442
08	2447
09	2452
10	2457
11	2462

Note: CH 01~CH 11 for 802.11b/g/n(HT20), CH 03~CH 09 for 802.11n(HT40)

Data Rated:

Preliminary tests were performed in different data rate, and found which the below bit rate is worst case mode, so only show data which it is a worst case mode.

Mode	Data rate (worst mode)
802.11b	1Mbps
802.11g	6Mbps
802.11n(HT20)	HT-MCS0
802.11n(HT40)	HT-MCS0

Test Mode:

For RF test items:
The engineering test program was provided and enabled to make EUT continuous transmit.
For AC power line conducted emissions:
The EUT was set to connect with the WLAN AP under large package sizes transmission.
For Radiated spurious emissions test item:
The engineering test program was provided and enabled to make EUT continuous transmit. The EUT in each of three orthogonal axis emissions had been tested, but only the worst case (X axis) data Recorded in the report.



2.5. Measurement Instruments List

Tonscend JS0806-2 Test system					
Item	Test Equipment	Manufacturer	Model No.	Serial No.	Calibrated until
1	MXA Signal Analyzer	Keysight	N9020A	MY46471737	Dec. 16, 2023
2	Spectrum Analyzer	R&S	FSU26	100105	Dec. 16, 2023
3	Spectrum Analyzer	R&S	FSV40-N	101331	Mar. 14, 2024
4	MXG Vector Signal Generator	Agilent	N5182A	MY47420864	Dec. 16, 2023
5	PSG Analog Signal Generator	Agilent	E8257D	MY46521908	Dec. 16, 2023
6	Power Sensor	Keysight	U2021XA	MY55130004	Mar. 14, 2024
7	Power Sensor	Keysight	U2021XA	MY55130006	Mar. 14, 2024
8	Wideband Radio Communication Tester	R&S	CMW500	102414	Dec. 16, 2023
9	High and low temperature box	ESPEC	MT3035	/	Mar. 24, 2024
10	JS1120 RF Test system	TONSCEND	v2.6	/	/

Radiated emission					
Item	Test Equipment	Manufacturer	Model No.	Serial No.	Calibrated until
1	Trilog-Broadband Antenna	Schwarzbeck	VULB 9163	01026	Dec. 18, 2024
2	Horn Antenna	Schwarzbeck	BBHA 9120D	9120D-647	Dec. 01, 2024
3	Test Receiver	Keysight	N9038A	MY56400071	Dec. 16, 2023
4	Broadband Prempplier	SCHWARZBECK	BBV9743B	259	Dec. 16, 2023
5	Mirowave Broadband Amplifier	SCHWARZBECK	BBV9718C	111	Dec. 16, 2023
6	3m chamber 3	YIHENG	EE106	/	Sep. 09, 2023



Conducted Emission					
Item	Test Equipment	Manufacturer	Model No.	Serial No.	Calibrated until
1	LISN	R&S	ENV216	101112	Dec. 16, 2023
2	LISN	R&S	ENV216	101113	Dec. 16, 2023
3	EMI Test Receiver	R&S	ESCS30	100353	Dec. 16, 2023
4	ISN CAT6	Schwarzbeck	NTFM 8158	CAT6-8158-0046	Dec. 16, 2023
5	ISN CAT5	Schwarzbeck	NTFM 8158	CAT5-8158-0046	Dec. 16, 2023

Note: The Cal. Interval was one year.

3. TEST ITEM AND RESULTS

3.1. Conducted Emission

Limit

FCC CFR Title 47 Part 15 Subpart C Section 15.207/ RSS - Gen 8.8:

Frequency range (MHz)	Limit (dBuV)	
	Quasi-peak	Average
0.15-0.5	66 to 56*	56 to 46*
0.5-5	56	46
5-30	60	50

* Decreases with the logarithm of the frequency.

Test Configuration

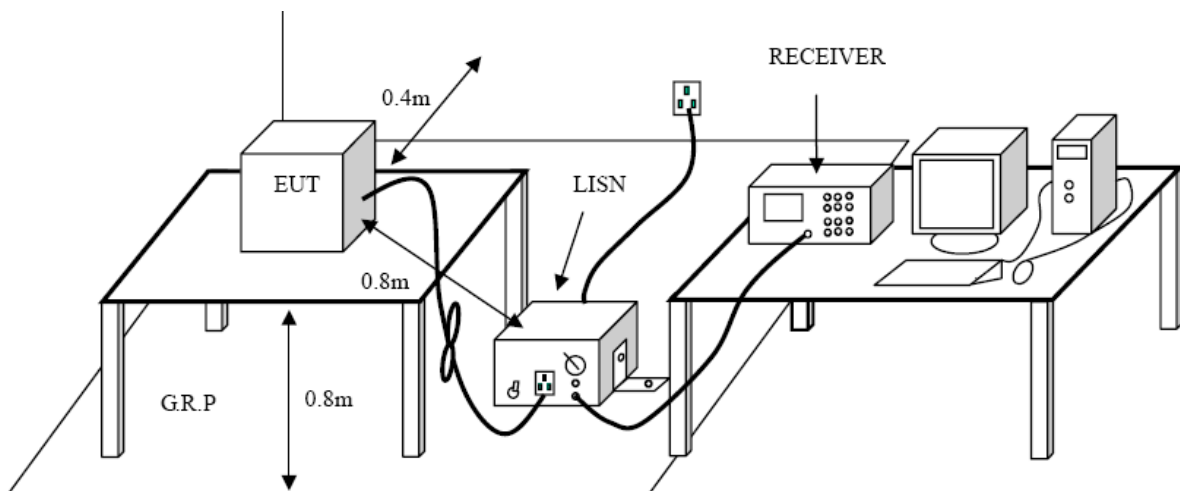

Test Procedure

1. The EUT was setup according to ANSI C63.10:2013 requirements.
2. The EUT was placed on a platform of nominal size, 1 m by 1.5 m, raised 80 cm above the conducting ground plane. The vertical conducting plane was located 40 cm to the rear of the EUT. All other surfaces of EUT were at least 80 cm from any other grounded conducting surface.
3. The EUT and simulators are connected to the main power through a line impedances stabilization network (LISN). The LISN provides a 50ohm /50uH coupling impedance for the measuring equipment. The peripheral devices are also connected to the main power through a LISN. (Please refer to the block diagram of the test setup and photographs)
4. Each current-carrying conductor of the EUT power cord, except the ground (safety) conductor, was individually connected through a LISN to the input power source.
5. The excess length of the power cord between the EUT and the LISN receptacle were folded back and forth at the center of the lead to form a bundle not exceeding 40 cm in length.
6. Conducted Emissions were investigated over the frequency range from 0.15MHz to 30MHz using a receiver bandwidth of 9 kHz.
7. During the above scans, the emissions were maximized by cable manipulation.



Test Mode:

Please refer to the clause 2.4.

Test Results

Test Voltage:	AC 120V/60 Hz
Terminal:	Line
Remark:	Only worse case is reported.

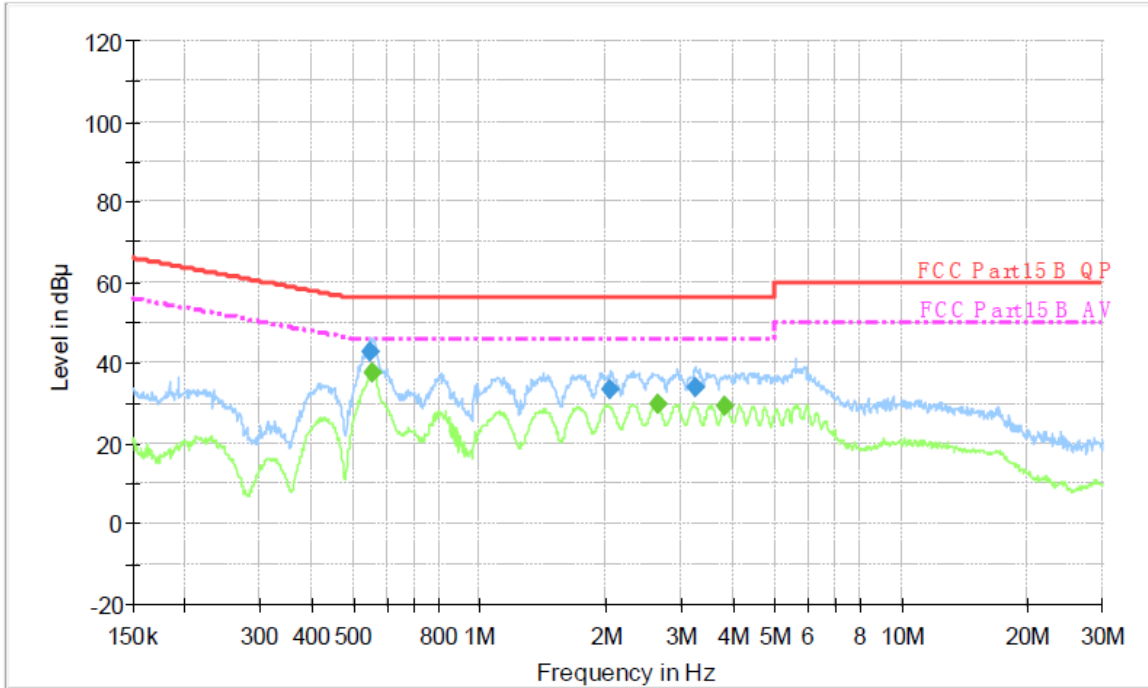

Final Measurement Detector 1

Frequency (MHz)	QuasiPeak (dBu V)	Meas. Time (ms)	Bandwidth (kHz)	Filter	Line	Corr. (dB)	Margin (dB)	Limit (dBu V)	Comment
0.551170	42.5	1000.00	9.000	On	L1	9.7	13.5	56.0	
2.049620	33.4	1000.00	9.000	On	L1	9.7	22.6	56.0	
3.243770	34.0	1000.00	9.000	On	L1	9.7	22.0	56.0	

Final Measurement Detector 2

Frequency (MHz)	Average (dBu V)	Meas. Time (ms)	Bandwidth (kHz)	Filter	Line	Corr. (dB)	Margin (dB)	Limit (dBu V)	Comment
0.555580	37.5	1000.00	9.000	On	L1	9.7	8.5	46.0	
2.635710	29.7	1000.00	9.000	On	L1	9.7	16.3	46.0	
3.835890	29.4	1000.00	9.000	On	L1	9.7	16.6	46.0	

Emission Level= Read Level+ Correct Factor



Test Voltage:	AC 120V/60 Hz
Terminal:	Neutral
Remark:	Only worse case is reported.

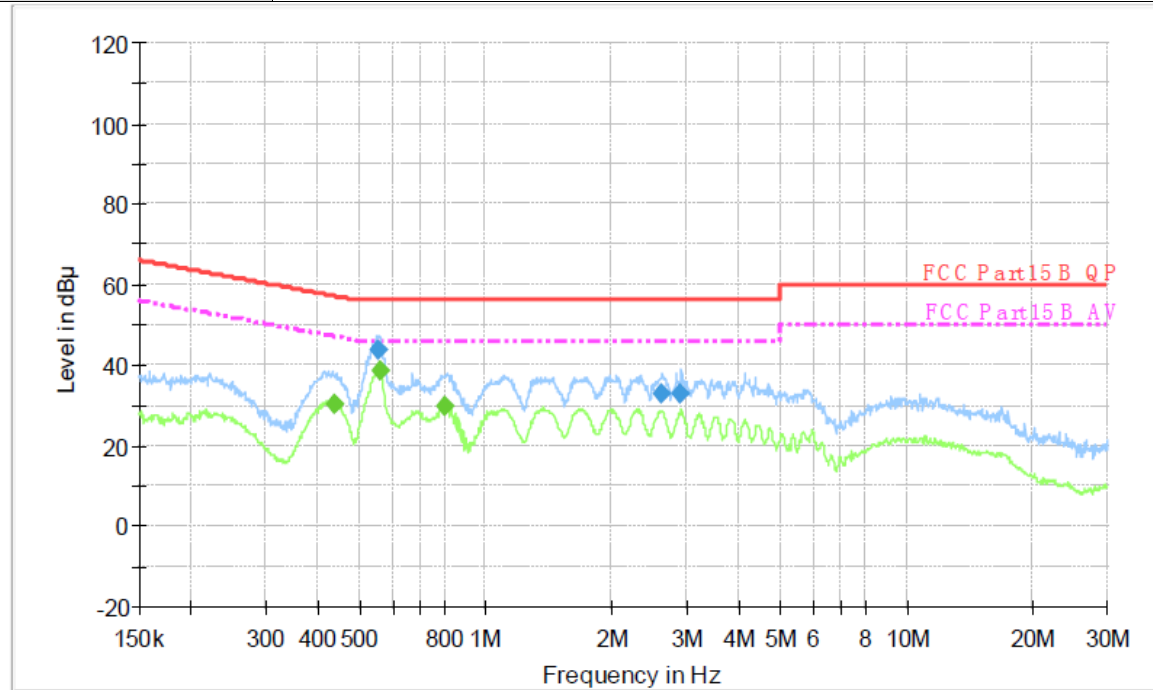

Final Measurement Detector 1

Frequency (MHz)	QuasiPeak (dBμ V)	Meas. Time (ms)	Bandwidth (kHz)	Filter	Line	Corr. (dB)	Margin (dB)	Limit (dBμ V)	Comment
0.557810	43.6	1000.00	9.000	On	N	10.0	12.4	56.0	
2.614750	33.0	1000.00	9.000	On	N	10.0	23.0	56.0	
2.912330	33.0	1000.00	9.000	On	N	10.0	23.0	56.0	

Final Measurement Detector 2

Frequency (MHz)	Average (dBμ V)	Meas. Time (ms)	Bandwidth (kHz)	Filter	Line	Corr. (dB)	Margin (dB)	Limit (dBμ V)	Comment
0.435500	30.5	1000.00	9.000	On	N	10.0	16.6	47.1	
0.560040	38.7	1000.00	9.000	On	N	10.0	7.3	46.0	
0.798950	29.7	1000.00	9.000	On	N	10.0	16.3	46.0	

Emission Level= Read Level+ Correct Factor



3.2. Radiated Emission

Limit

FCC CFR Title 47 Part 15 Subpart C Section 15.209/ RSS – Gen 8.9:

Frequency (MHz)	Field Strength (microvolts/meter)	Measurement Distance (meters)
0.009~0.490	2400/F(KHz)	300
0.490~1.705	24000/F(KHz)	30
1.705~30.0	30	30
30~88	100	3
88~216	150	3
216~960	200	3
960~1000	500	3

Frequency (MHz)	dB(uV/m) (at 3 meters)	
	Peak	Average
Above 1000	74	54

Note:

- (1) The tighter limit applies at the band edges.
- (2) Emission Level (dBuV/m)=20log Emission Level (uV/m).

Test Configuration

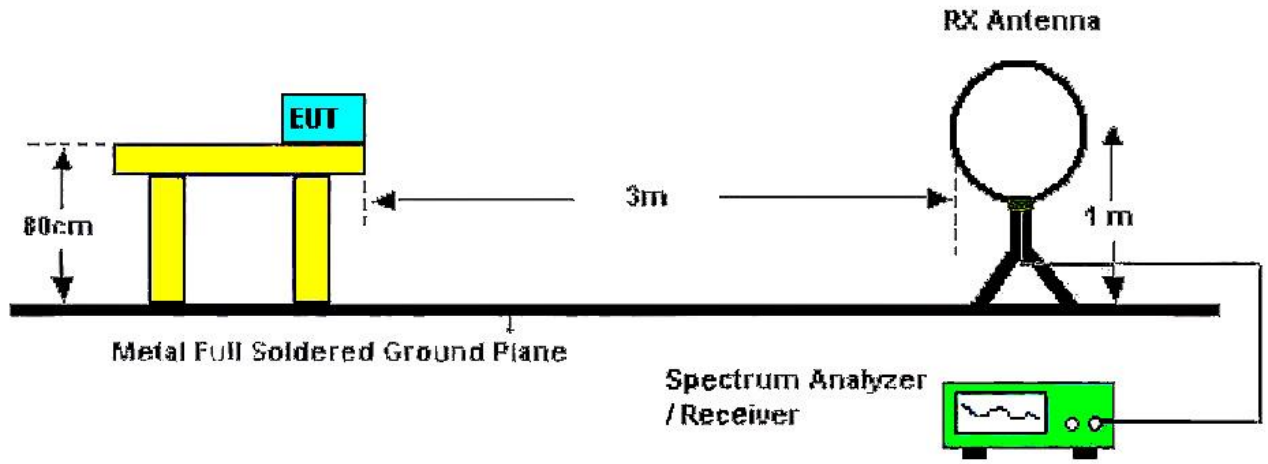

Below 30MHz Test Setup

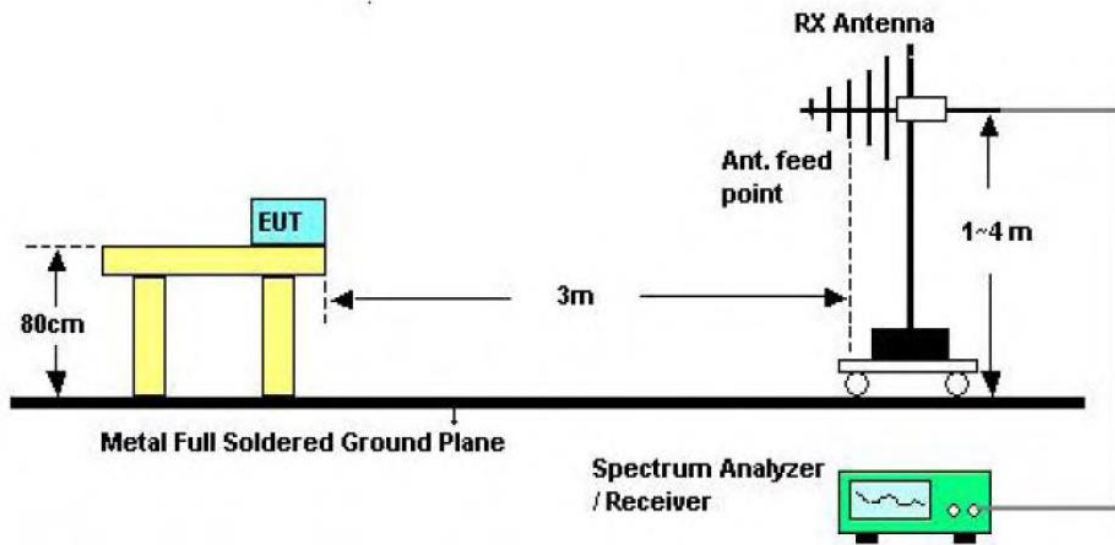

30-1000MHz Test Setup

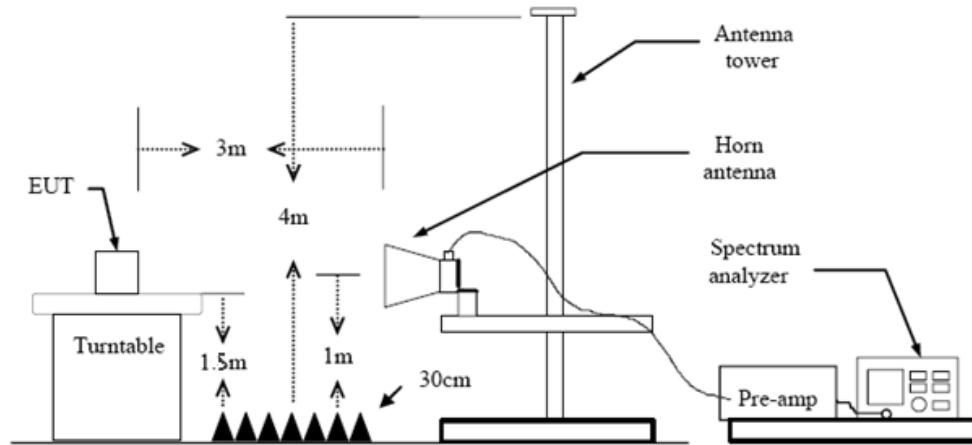

Above 1GHz Test Setup

Test Procedure

1. The EUT was setup and tested according to ANSI C63.10:2013
2. The EUT is placed on a turn table which is 0.8 meter above ground for below 1 GHz, and 1.5 m for above 1 GHz. The turn table is rotated 360 degrees to determine the position of the maximum emission level.
3. The EUT was set 3 meters from the receiving antenna, which was mounted on the top of a variable height antenna tower.
4. For each suspected emission, the EUT was arranged to its worst case and then tune the Antenna tower (from 1 m to 4 m) and turntable (from 0 degree to 360 degrees) to find the maximum reading. A pre-amp and a high pass filter are used for the test in order to get better signal level to comply with the guidelines.
5. Set to the maximum power setting and enable the EUT transmit continuously.

6. Use the following spectrum analyzer settings

- (1) Span shall wide enough to fully capture the emission being measured;

- (2) Below 1 GHz:

RBW=120 kHz, VBW=300 kHz, Sweep=auto, Detector function=peak, Trace=max hold;

If the emission level of the EUT measured by the peak detector is 3 dB lower than the applicable limit, the peak emission level will be reported. Otherwise, the emission measurement will be repeated using the quasi-peak detector and reported.

- (3) From 1 GHz to 10th harmonic:

RBW=1MHz, VBW=3MHz Peak detector for Peak value.

RBW=1MHz, VBW see note 1 with Peak Detector for Average Value.

Note 1: For measurements above 1 GHz the resolution bandwidth is set to 1 MHz, then the video bandwidth is set to 3 MHz for peak measurements and 1 MHz resolution bandwidth with 1/T video bandwidth with peak detector for average measurements. For the Duty Cycle please refer to clause 3.8 Duty Cycle.

Test Mode

Please refer to the clause 2.4.

Test Result

9 KHz~30 MHz

From 9 KHz to 30 MHz: Conclusion: PASS

Note: The amplitude of spurious emissions which are attenuated by more than 20dB below the permissible value has no need to be reported.



30MHz-1GHz

Ant. Pol.	Horizontal
Test Mode:	802.11b Mode 2412MHz
Remark:	Only worse case is reported.

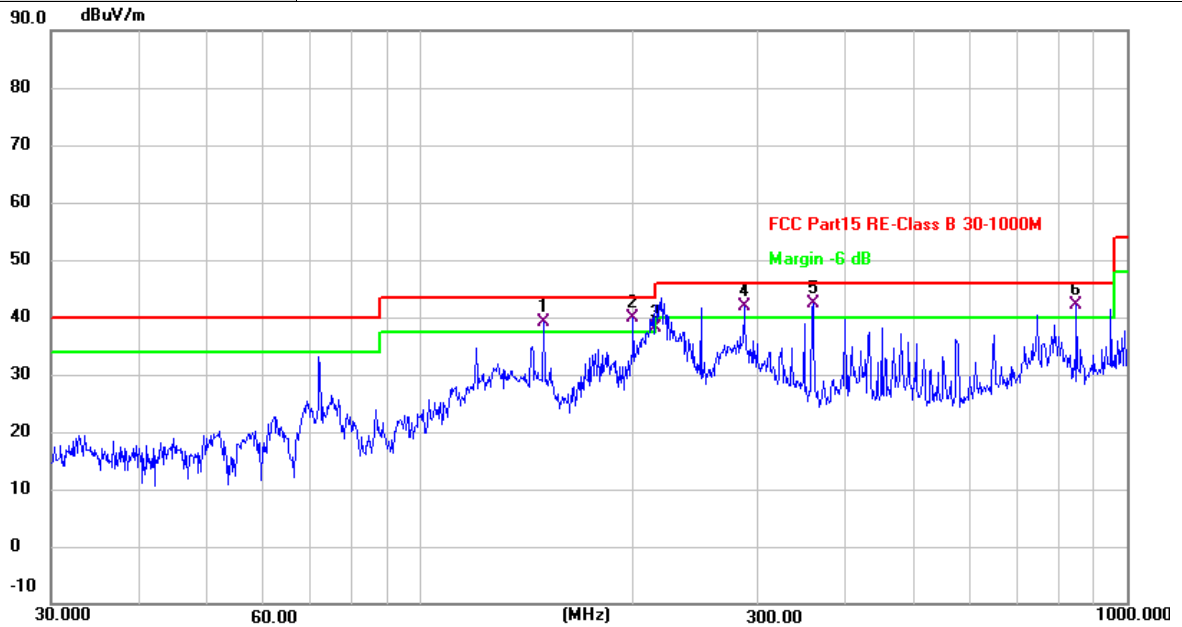

No.	Frequency (MHz)	Reading (dBuV)	Factor (dB/m)	Level (dBuV/m)	Limit (dBuV/m)	Margin (dB)	Detector
1 !	149.4857	58.86	-19.62	39.24	43.50	-4.26	QP
2 *	199.9855	55.85	-16.07	39.78	43.50	-3.72	QP
3 !	215.2678	53.86	-15.64	38.22	43.50	-5.28	QP
4 !	286.9823	55.73	-13.83	41.90	46.00	-4.10	QP
5 !	359.1860	54.35	-12.07	42.28	46.00	-3.72	QP
6 !	848.0563	45.58	-3.37	42.21	46.00	-3.79	QP

Remarks:

- 1.Factor (dB/m) = Antenna Factor (dB/m)+Cable Factor (dB)-Pre-amplifier Factor
- 2.Margin value = Level -Limit value



Ant. Pol.	Vertical
Test Mode:	802.11b Mode 2412MHz
Remark:	Only worse case is reported.

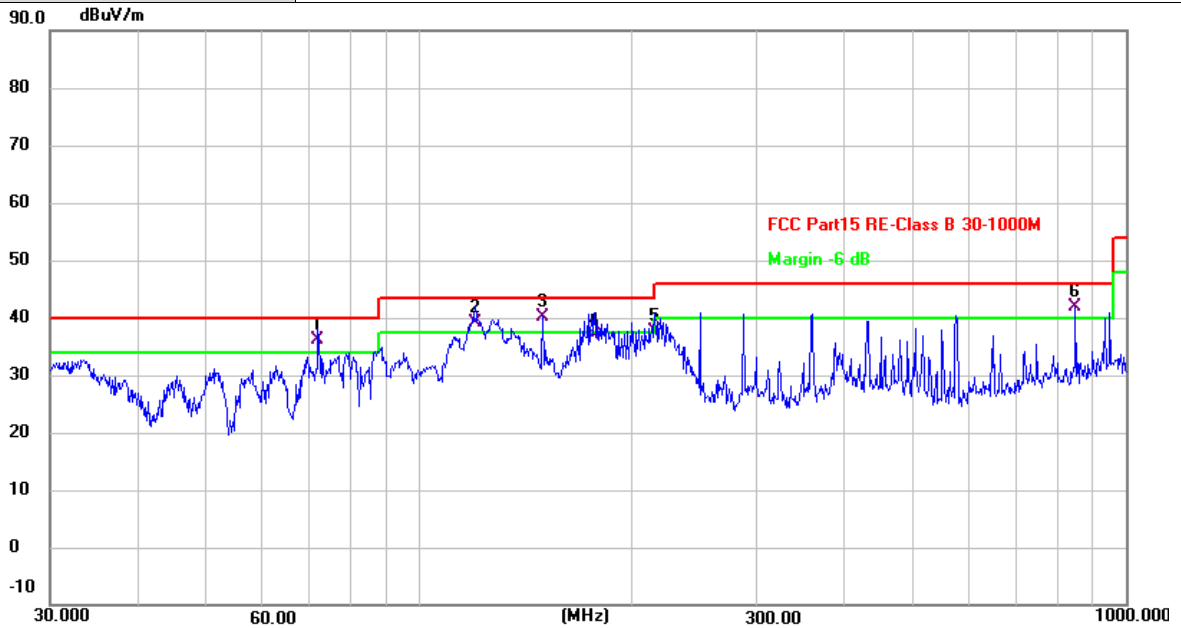

No.	Frequency (MHz)	Reading (dBuV)	Factor (dB/m)	Level (dBuV/m)	Limit (dBuV/m)	Margin (dB)	Detector
1 !	71.8320	55.01	-18.83	36.18	40.00	-3.82	QP
2 !	119.8556	57.11	-18.06	39.05	43.50	-4.45	QP
3 *	149.4857	59.72	-19.62	40.10	43.50	-3.40	QP
4	176.8878	55.08	-18.22	36.86	43.50	-6.64	QP
5 !	215.2678	53.35	-15.64	37.71	43.50	-5.79	QP
6 !	848.0563	45.33	-3.37	41.96	46.00	-4.04	QP

Remarks:

- Factor (dB/m) = Antenna Factor (dB/m)+Cable Factor (dB)-Pre-amplifier Factor
- Margin value = Level -Limit value



Adobe 1GHz

Ant. Pol.	Horizontal
Test Mode:	TX B Mode 2412MHz
Remark:	No report for the emission which more than 20 dB below the prescribed limit.

No.	Frequency (MHz)	Reading (dBuV)	Factor (dB/m)	Level (dBuV/m)	Limit (dBuV/m)	Margin (dB)	Detector
1	1049.833	50.39	-8.09	42.30	74.00	-31.70	peak
2	4825.667	43.72	2.20	45.92	74.00	-28.08	peak
3	5975.667	40.32	5.37	45.69	74.00	-28.31	peak
4	7647.000	39.61	10.29	49.90	74.00	-24.10	peak
5	8724.167	39.29	10.96	50.25	74.00	-23.75	peak
6 *	10905.333	38.31	14.76	53.07	74.00	-20.93	peak

Remarks:

- 1.Factor (dB/m) = Antenna Factor (dB/m)+Cable Factor (dB)-Pre-amplifier Factor
- 2.Margin value = Level -Limit value

Ant. Pol.	Vertical
Test Mode:	TX B Mode 2412MHz
Remark:	No report for the emission which more than 20 dB below the prescribed limit.

No.	Frequency (MHz)	Reading (dBuV)	Factor (dB/m)	Level (dBuV/m)	Limit (dBuV/m)	Margin (dB)	Detector
1	1049.833	49.47	-8.09	41.38	74.00	-32.62	peak
2	1801.167	46.62	-6.53	40.09	74.00	-33.91	peak
3	4745.167	39.64	2.03	41.67	74.00	-32.33	peak
4	7175.500	38.08	9.46	47.54	74.00	-26.46	peak
5	8889.000	39.27	11.10	50.37	74.00	-23.63	peak
6 *	11269.500	38.20	14.98	53.18	74.00	-20.82	peak

Remarks:

- 1.Factor (dB/m) = Antenna Factor (dB/m)+Cable Factor (dB)-Pre-amplifier Factor
- 2.Margin value = Level -Limit value



Ant. Pol.	Horizontal
Test Mode:	TX B Mode 2437MHz
Remark:	No report for the emission which more than 20 dB below the prescribed limit.

No.	Frequency (MHz)	Reading (dBuV)	Factor (dB/m)	Level (dBuV/m)	Limit (dBuV/m)	Margin (dB)	Detector
1	1049.833	50.01	-8.09	41.92	74.00	-32.08	peak
2	3970.833	41.12	0.43	41.55	74.00	-32.45	peak
3	4875.500	43.48	2.30	45.78	74.00	-28.22	peak
4	5807.000	40.15	4.81	44.96	74.00	-29.04	peak
5	8536.333	39.32	10.81	50.13	74.00	-23.87	peak
6 *	11166.000	38.19	14.98	53.17	74.00	-20.83	peak

Remarks:

1.Factor (dB/m) = Antenna Factor (dB/m)+Cable Factor (dB)-Pre-amplifier Factor

2.Margin value = Level -Limit value

Ant. Pol.	Vertical
Test Mode:	TX B Mode 2437MHz
Remark:	No report for the emission which more than 20 dB below the prescribed limit.

No.	Frequency (MHz)	Reading (dBuV)	Factor (dB/m)	Level (dBuV/m)	Limit (dBuV/m)	Margin (dB)	Detector
1	1049.833	48.88	-8.09	40.79	74.00	-33.21	peak
2	1651.667	46.88	-6.75	40.13	74.00	-33.87	peak
3	4875.500	40.34	2.30	42.64	74.00	-31.36	peak
4	7240.667	38.88	9.57	48.45	74.00	-25.55	peak
5	7900.000	39.76	10.70	50.46	74.00	-23.54	peak
6 *	11146.833	38.45	14.98	53.43	74.00	-20.57	peak

Remarks:

1.Factor (dB/m) = Antenna Factor (dB/m)+Cable Factor (dB)-Pre-amplifier Factor

2.Margin value = Level -Limit value



Ant. Pol.	Horizontal
Test Mode:	TX B Mode 2462MHz
Remark:	No report for the emission which more than 20 dB below the prescribed limit.

No.	Frequency (MHz)	Reading (dBuV)	Factor (dB/m)	Level (dBuV/m)	Limit (dBuV/m)	Margin (dB)	Detector
1	1049.833	50.53	-8.09	42.44	74.00	-31.56	peak
2	1651.667	46.45	-6.75	39.70	74.00	-34.30	peak
3	4925.333	38.98	2.41	41.39	74.00	-32.61	peak
4	8038.000	38.89	10.87	49.76	74.00	-24.24	peak
5	9816.667	38.11	12.67	50.78	74.00	-23.22	peak
6 *	11997.833	37.72	15.45	53.17	74.00	-20.83	peak

Remarks:

1.Factor (dB/m) = Antenna Factor (dB/m)+Cable Factor (dB)-Pre-amplifier Factor

2.Margin value = Level -Limit value

Ant. Pol.	Vertical
Test Mode:	TX B Mode 2462MHz
Remark:	No report for the emission which more than 20 dB below the prescribed limit.

No.	Frequency (MHz)	Reading (dBuV)	Factor (dB/m)	Level (dBuV/m)	Limit (dBuV/m)	Margin (dB)	Detector
1	1049.833	49.01	-8.09	40.92	74.00	-33.08	peak
2	1801.167	45.96	-6.53	39.43	74.00	-34.57	peak
3	4925.333	39.57	2.41	41.98	74.00	-32.02	peak
4	5971.833	39.33	5.36	44.69	74.00	-29.31	peak
5	7965.167	39.01	10.81	49.82	74.00	-24.18	peak
6 *	11058.667	38.48	14.98	53.46	74.00	-20.54	peak

Remarks:

1.Factor (dB/m) = Antenna Factor (dB/m)+Cable Factor (dB)-Pre-amplifier Factor

2.Margin value = Level -Limit value



Ant. Pol.	Horizontal
Test Mode:	TX G Mode 2412MHz
Remark:	No report for the emission which more than 20 dB below the prescribed limit.

No.	Frequency (MHz)	Reading (dBuV)	Factor (dB/m)	Level (dBuV/m)	Limit (dBuV/m)	Margin (dB)	Detector
1	1049.833	49.74	-8.09	41.65	74.00	-32.35	peak
2	1801.167	45.74	-6.53	39.21	74.00	-34.79	peak
3	4737.500	40.94	2.02	42.96	74.00	-31.04	peak
4	7865.500	38.13	10.65	48.78	74.00	-25.22	peak
5	10805.667	38.21	14.53	52.74	74.00	-21.26	peak
6 *	12427.167	37.23	16.12	53.35	74.00	-20.65	peak

Remarks:

1. Factor (dB/m) = Antenna Factor (dB/m)+Cable Factor (dB)-Pre-amplifier Factor

2. Margin value = Level -Limit value

Ant. Pol.	Vertical
Test Mode:	TX G Mode 2412MHz
Remark:	No report for the emission which more than 20 dB below the prescribed limit.

No.	Frequency (MHz)	Reading (dBuV)	Factor (dB/m)	Level (dBuV/m)	Limit (dBuV/m)	Margin (dB)	Detector
1	1049.833	48.95	-8.09	40.86	74.00	-33.14	peak
2	1651.667	46.63	-6.75	39.88	74.00	-34.12	peak
3	4074.333	40.74	0.68	41.42	74.00	-32.58	peak
4	5764.833	40.02	4.67	44.69	74.00	-29.31	peak
5	8068.667	38.68	10.86	49.54	74.00	-24.46	peak
6 *	11150.667	38.37	14.98	53.35	74.00	-20.65	peak

Remarks:

1. Factor (dB/m) = Antenna Factor (dB/m)+Cable Factor (dB)-Pre-amplifier Factor

2. Margin value = Level -Limit value



Ant. Pol.	Horizontal
Test Mode:	TX G Mode 2437MHz
Remark:	No report for the emission which more than 20 dB below the prescribed limit.

No.	Frequency (MHz)	Reading (dBuV)	Factor (dB/m)	Level (dBuV/m)	Limit (dBuV/m)	Margin (dB)	Detector
1	1049.833	49.64	-8.09	41.55	74.00	-32.45	peak
2	1801.167	45.62	-6.53	39.09	74.00	-34.91	peak
3	4745.167	39.89	2.03	41.92	74.00	-32.08	peak
4	8310.167	39.37	10.81	50.18	74.00	-23.82	peak
5	9697.833	39.54	12.47	52.01	74.00	-21.99	peak
6 *	11005.000	38.18	14.97	53.15	74.00	-20.85	peak

Remarks:

1.Factor (dB/m) = Antenna Factor (dB/m)+Cable Factor (dB)-Pre-amplifier Factor

2.Margin value = Level -Limit value

Ant. Pol.	Vertical
Test Mode:	TX G Mode 2437MHz
Remark:	No report for the emission which more than 20 dB below the prescribed limit.

No.	Frequency (MHz)	Reading (dBuV)	Factor (dB/m)	Level (dBuV/m)	Limit (dBuV/m)	Margin (dB)	Detector
1	1049.833	48.59	-8.09	40.50	74.00	-33.50	peak
2	1651.667	45.75	-6.75	39.00	74.00	-35.00	peak
3	4871.667	38.47	2.29	40.76	74.00	-33.24	peak
4	6071.500	39.73	5.71	45.44	74.00	-28.56	peak
5	9230.167	39.77	11.62	51.39	74.00	-22.61	peak
6 *	12178.000	37.36	15.72	53.08	74.00	-20.92	peak

Remarks:

1.Factor (dB/m) = Antenna Factor (dB/m)+Cable Factor (dB)-Pre-amplifier Factor

2.Margin value = Level -Limit value



Ant. Pol.	Horizontal
Test Mode:	TX G Mode 2462MHz
Remark:	No report for the emission which more than 20 dB below the prescribed limit.

No.	Frequency (MHz)	Reading (dBuV)	Factor (dB/m)	Level (dBuV/m)	Limit (dBuV/m)	Margin (dB)	Detector
1	1049.833	49.51	-8.09	41.42	74.00	-32.58	peak
2	3664.167	42.16	-0.64	41.52	74.00	-32.48	peak
3	4733.667	39.86	2.01	41.87	74.00	-32.13	peak
4	5902.833	39.70	5.12	44.82	74.00	-29.18	peak
5	9069.167	39.14	11.32	50.46	74.00	-23.54	peak
6 *	11012.667	38.18	14.98	53.16	74.00	-20.84	peak

Remarks:

1.Factor (dB/m) = Antenna Factor (dB/m)+Cable Factor (dB)-Pre-amplifier Factor

2.Margin value = Level -Limit value

Ant. Pol.	Vertical
Test Mode:	TX G Mode 2462MHz
Remark:	No report for the emission which more than 20 dB below the prescribed limit.

No.	Frequency (MHz)	Reading (dBuV)	Factor (dB/m)	Level (dBuV/m)	Limit (dBuV/m)	Margin (dB)	Detector
1	1049.833	49.10	-8.09	41.01	74.00	-32.99	peak
2	1651.667	45.92	-6.75	39.17	74.00	-34.83	peak
3	4718.333	39.81	1.98	41.79	74.00	-32.21	peak
4	6443.333	38.91	7.07	45.98	74.00	-28.02	peak
5	7144.833	38.87	9.41	48.28	74.00	-25.72	peak
6 *	11618.333	38.18	15.10	53.28	74.00	-20.72	peak

Remarks:

1.Factor (dB/m) = Antenna Factor (dB/m)+Cable Factor (dB)-Pre-amplifier Factor

2.Margin value = Level -Limit value



Ant. Pol.	Horizontal
Test Mode:	TX N20 Mode 2412MHz
Remark:	No report for the emission which more than 20 dB below the prescribed limit.

No.	Frequency (MHz)	Reading (dBuV)	Factor (dB/m)	Level (dBuV/m)	Limit (dBuV/m)	Margin (dB)	Detector
1	1049.833	49.76	-8.09	41.67	74.00	-32.33	peak
2	4354.167	41.03	1.23	42.26	74.00	-31.74	peak
3	4821.833	41.35	2.19	43.54	74.00	-30.46	peak
4	5634.500	39.63	4.25	43.88	74.00	-30.12	peak
5	8283.333	39.19	10.82	50.01	74.00	-23.99	peak
6 *	11476.500	38.02	15.00	53.02	74.00	-20.98	peak

Remarks:

1.Factor (dB/m) = Antenna Factor (dB/m)+Cable Factor (dB)-Pre-amplifier Factor

2.Margin value = Level -Limit value

Ant. Pol.	Vertical
Test Mode:	TX N20 Mode 2412MHz
Remark:	No report for the emission which more than 20 dB below the prescribed limit.

No.	Frequency (MHz)	Reading (dBuV)	Factor (dB/m)	Level (dBuV/m)	Limit (dBuV/m)	Margin (dB)	Detector
1	1049.833	48.54	-8.09	40.45	74.00	-33.55	peak
2	1651.667	45.79	-6.75	39.04	74.00	-34.96	peak
3	3859.667	42.23	0.05	42.28	74.00	-31.72	peak
4	7137.167	38.02	9.39	47.41	74.00	-26.59	peak
5	9234.000	39.19	11.63	50.82	74.00	-23.18	peak
6 *	11534.000	38.21	15.03	53.24	74.00	-20.76	peak

Remarks:

1.Factor (dB/m) = Antenna Factor (dB/m)+Cable Factor (dB)-Pre-amplifier Factor

2.Margin value = Level -Limit value



Ant. Pol.	Horizontal
Test Mode:	TX N20 Mode 2437MHz
Remark:	No report for the emission which more than 20 dB below the prescribed limit.

No.	Frequency (MHz)	Reading (dBuV)	Factor (dB/m)	Level (dBuV/m)	Limit (dBuV/m)	Margin (dB)	Detector
1	1049.833	49.74	-8.09	41.65	74.00	-32.35	peak
2	1801.167	45.51	-6.53	38.98	74.00	-35.02	peak
3	4465.333	40.44	1.46	41.90	74.00	-32.10	peak
4	7198.500	38.51	9.50	48.01	74.00	-25.99	peak
5	10054.333	38.19	13.08	51.27	74.00	-22.73	peak
6 *	11192.833	38.04	14.99	53.03	74.00	-20.97	peak

Remarks:

1.Factor (dB/m) = Antenna Factor (dB/m)+Cable Factor (dB)-Pre-amplifier Factor

2.Margin value = Level -Limit value

Ant. Pol.	Vertical
Test Mode:	TX N20 Mode 2437MHz
Remark:	No report for the emission which more than 20 dB below the prescribed limit.

No.	Frequency (MHz)	Reading (dBuV)	Factor (dB/m)	Level (dBuV/m)	Limit (dBuV/m)	Margin (dB)	Detector
1	1049.833	49.45	-8.09	41.36	74.00	-32.64	peak
2	1651.667	46.35	-6.75	39.60	74.00	-34.40	peak
3	4764.333	39.52	2.07	41.59	74.00	-32.41	peak
4	7060.500	38.01	9.25	47.26	74.00	-26.74	peak
5	10326.500	39.12	13.54	52.66	74.00	-21.34	peak
6 *	11560.833	38.15	15.06	53.21	74.00	-20.79	peak

Remarks:

1.Factor (dB/m) = Antenna Factor (dB/m)+Cable Factor (dB)-Pre-amplifier Factor

2.Margin value = Level -Limit value



Ant. Pol.	Horizontal
Test Mode:	TX N20 Mode 2462MHz
Remark:	No report for the emission which more than 20 dB below the prescribed limit.

No.	Frequency (MHz)	Reading (dBuV)	Factor (dB/m)	Level (dBuV/m)	Limit (dBuV/m)	Margin (dB)	Detector
1	1049.833	49.86	-8.09	41.77	74.00	-32.23	peak
2	4423.167	40.34	1.37	41.71	74.00	-32.29	peak
3	4921.500	39.45	2.39	41.84	74.00	-32.16	peak
4	8103.167	38.56	10.85	49.41	74.00	-24.59	peak
5	9881.833	38.46	12.78	51.24	74.00	-22.76	peak
6 *	11319.333	38.48	14.99	53.47	74.00	-20.53	peak

Remarks:

1.Factor (dB/m) = Antenna Factor (dB/m)+Cable Factor (dB)-Pre-amplifier Factor

2.Margin value = Level -Limit value

Ant. Pol.	Vertical
Test Mode:	TX N20 Mode 2462MHz
Remark:	No report for the emission which more than 20 dB below the prescribed limit.

No.	Frequency (MHz)	Reading (dBuV)	Factor (dB/m)	Level (dBuV/m)	Limit (dBuV/m)	Margin (dB)	Detector
1	1049.833	48.94	-8.09	40.85	74.00	-33.15	peak
2	1651.667	45.92	-6.75	39.17	74.00	-34.83	peak
3	3909.500	41.20	0.22	41.42	74.00	-32.58	peak
4	4745.167	40.00	2.03	42.03	74.00	-31.97	peak
5	7988.167	39.89	10.84	50.73	74.00	-23.27	peak
6 *	11399.833	38.46	14.99	53.45	74.00	-20.55	peak

Remarks:

1.Factor (dB/m) = Antenna Factor (dB/m)+Cable Factor (dB)-Pre-amplifier Factor

2.Margin value = Level -Limit value



Ant. Pol.	Horizontal
Test Mode:	TX N40 Mode 2422MHz
Remark:	No report for the emission which more than 20 dB below the prescribed limit.

No.	Frequency (MHz)	Reading (dBuV)	Factor (dB/m)	Level (dBuV/m)	Limit (dBuV/m)	Margin (dB)	Detector
1	1049.833	49.37	-8.09	41.28	74.00	-32.72	peak
2	1801.167	46.07	-6.53	39.54	74.00	-34.46	peak
3	4039.833	40.75	0.62	41.37	74.00	-32.63	peak
4	4737.500	40.42	2.02	42.44	74.00	-31.56	peak
5	7206.167	38.60	9.51	48.11	74.00	-25.89	peak
6 *	11035.667	37.86	14.98	52.84	74.00	-21.16	peak

Remarks:

1.Factor (dB/m) = Antenna Factor (dB/m)+Cable Factor (dB)-Pre-amplifier Factor

2.Margin value = Level -Limit value

Ant. Pol.	Vertical
Test Mode:	TX N40 Mode 2422MHz
Remark:	No report for the emission which more than 20 dB below the prescribed limit.

No.	Frequency (MHz)	Reading (dBuV)	Factor (dB/m)	Level (dBuV/m)	Limit (dBuV/m)	Margin (dB)	Detector
1	1049.833	49.49	-8.09	41.40	74.00	-32.60	peak
2	1651.667	45.97	-6.75	39.22	74.00	-34.78	peak
3	4733.667	39.18	2.01	41.19	74.00	-32.81	peak
4	5580.833	39.00	4.07	43.07	74.00	-30.93	peak
5	8712.667	38.50	10.95	49.45	74.00	-24.55	peak
6 *	10870.833	38.29	14.68	52.97	74.00	-21.03	peak

Remarks:

1.Factor (dB/m) = Antenna Factor (dB/m)+Cable Factor (dB)-Pre-amplifier Factor

2.Margin value = Level -Limit value



Ant. Pol.	Horizontal
Test Mode:	TX N40 Mode 2437MHz
Remark:	No report for the emission which more than 20 dB below the prescribed limit.

No.	Frequency (MHz)	Reading (dBuV)	Factor (dB/m)	Level (dBuV/m)	Limit (dBuV/m)	Margin (dB)	Detector
1	1049.833	49.53	-8.09	41.44	74.00	-32.56	peak
2	1801.167	45.50	-6.53	38.97	74.00	-35.03	peak
3	4791.167	39.46	2.12	41.58	74.00	-32.42	peak
4	7608.667	38.64	10.22	48.86	74.00	-25.14	peak
5	9092.167	39.94	11.36	51.30	74.00	-22.70	peak
6 *	11039.500	38.01	14.97	52.98	74.00	-21.02	peak

Remarks:

1.Factor (dB/m) = Antenna Factor (dB/m)+Cable Factor (dB)-Pre-amplifier Factor

2.Margin value = Level -Limit value

Ant. Pol.	Vertical
Test Mode:	TX N40 Mode 2437MHz
Remark:	No report for the emission which more than 20 dB below the prescribed limit.

No.	Frequency (MHz)	Reading (dBuV)	Factor (dB/m)	Level (dBuV/m)	Limit (dBuV/m)	Margin (dB)	Detector
1	1049.833	49.34	-8.09	41.25	74.00	-32.75	peak
2	1801.167	45.49	-6.53	38.96	74.00	-35.04	peak
3	4733.667	40.39	2.01	42.40	74.00	-31.60	peak
4	8137.667	38.61	10.85	49.46	74.00	-24.54	peak
5	9709.333	37.82	12.49	50.31	74.00	-23.69	peak
6 *	11541.667	38.09	15.03	53.12	74.00	-20.88	peak

Remarks:

1.Factor (dB/m) = Antenna Factor (dB/m)+Cable Factor (dB)-Pre-amplifier Factor

2.Margin value = Level -Limit value



Ant. Pol.	Horizontal
Test Mode:	TX N40 Mode 2452MHz
Remark:	No report for the emission which more than 20 dB below the prescribed limit.

No.	Frequency (MHz)	Reading (dBuV)	Factor (dB/m)	Level (dBuV/m)	Limit (dBuV/m)	Margin (dB)	Detector
1	1049.833	49.88	-8.09	41.79	74.00	-32.21	peak
2	1801.167	45.75	-6.53	39.22	74.00	-34.78	peak
3	4427.000	40.62	1.38	42.00	74.00	-32.00	peak
4	6424.167	38.99	7.00	45.99	74.00	-28.01	peak
5	8866.000	39.60	11.08	50.68	74.00	-23.32	peak
6 *	10798.000	38.57	14.52	53.09	74.00	-20.91	peak

Remarks:

1.Factor (dB/m) = Antenna Factor (dB/m)+Cable Factor (dB)-Pre-amplifier Factor

2.Margin value = Level -Limit value

Ant. Pol.	Vertical
Test Mode:	TX N40 Mode 2452MHz
Remark:	No report for the emission which more than 20 dB below the prescribed limit.

No.	Frequency (MHz)	Reading (dBuV)	Factor (dB/m)	Level (dBuV/m)	Limit (dBuV/m)	Margin (dB)	Detector
1	1049.833	48.83	-8.09	40.74	74.00	-33.26	peak
2	3894.167	41.08	0.17	41.25	74.00	-32.75	peak
3	4733.667	39.90	2.01	41.91	74.00	-32.09	peak
4	6880.333	38.02	8.69	46.71	74.00	-27.29	peak
5	8743.333	39.35	10.99	50.34	74.00	-23.66	peak
6 *	11097.000	38.17	14.97	53.14	74.00	-20.86	peak

Remarks:

1.Factor (dB/m) = Antenna Factor (dB/m)+Cable Factor (dB)-Pre-amplifier Factor

2.Margin value = Level -Limit value

3.3. Band Edge Emissions (Radiated)

Limit

FCC CFR Title 47 Part 15 Subpart C Section 15.247 (d)/ RSS 247 5.5:

Restricted Frequency Band (MHz)	(dBuV/m)(at 3m)	
	Peak	Average
2310 ~ 2390	74	54
2483.5 ~ 2500	74	54

Conducted band edge limit: The highest point of the operating frequency waveform down 20dB

Test Configuration

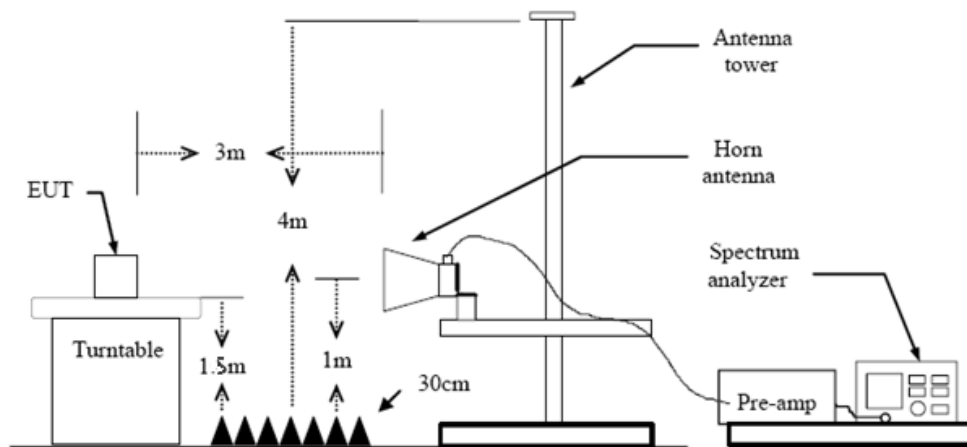

Test Procedure

1. The EUT was setup and tested according to ANSI C63.10:2013 requirements.
2. The EUT is placed on a turn table which is 1.5 meter above ground. The turn table is rotated 360 degrees to determine the position of the maximum emission level.
3. The EUT was positioned such that the distance from antenna to the EUT was 3 meters.
4. The antenna is scanned from 1 meter to 4 meters to find out the maximum emission level. This is repeated for both horizontal and vertical polarization of the antenna. In order to find the maximum emission, all of the interface cables were manipulated according to ANSI C63.10:2013 on radiated measurement.
5. The receiver set as follow:
 RBW=1MHz, VBW=3MHz Peak detector for Peak value.
 RBW=1MHz, VBW see note 1 with Peak Detector for Average Value.
 Note 1: For measurements above 1 GHz the resolution bandwidth is set to 1 MHz, then the video bandwidth is set to 3 MHz for peak measurements and 1 MHz resolution bandwidth with 1/T video bandwidth with peak detector for average measurements. For the Duty Cycle please refer to clause 3.8 Duty Cycle.

Test Mode

Please refer to the clause 2.4.

Test Results



(1) Radiation Test

Ant. Pol.	Horizontal
Test Mode:	B Mode 2412MHz

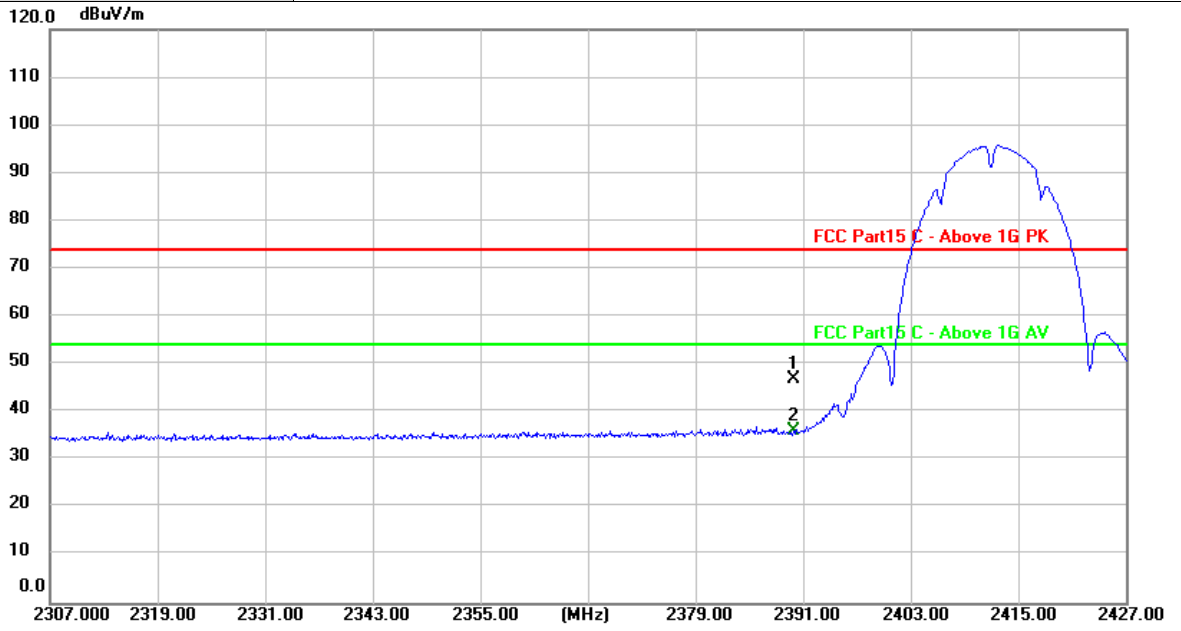

No.	Frequency (MHz)	Reading (dBuV)	Factor (dB/m)	Level (dBuV/m)	Limit (dBuV/m)	Margin (dB)	Detector
1	2390.000	16.24	30.84	47.08	74.00	-26.92	peak
2 *	2390.000	5.30	30.84	36.14	54.00	-17.86	AVG

Remarks:

1. Factor (dB/m) = Antenna Factor (dB/m)+Cable Factor (dB)-Pre-amplifier Factor
2. Margin value = Level -Limit value



Ant. Pol.	Vertical
Test Mode:	B Mode 2412MHz

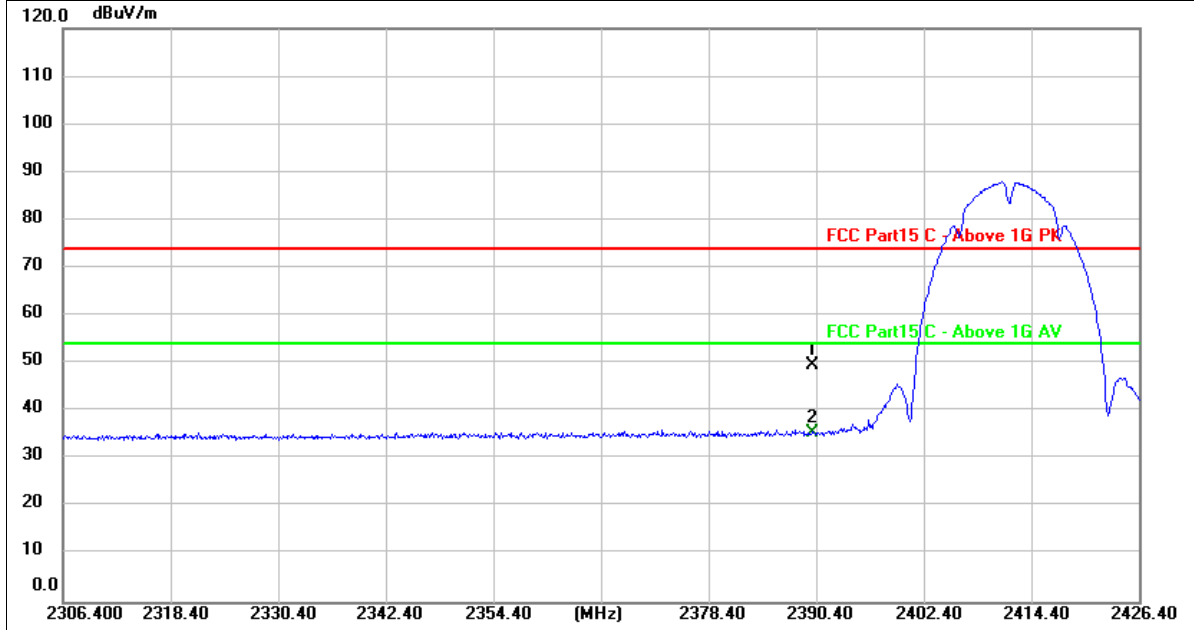

No.	Frequency (MHz)	Reading (dBuV)	Factor (dB/m)	Level (dBuV/m)	Limit (dBuV/m)	Margin (dB)	Detector
1	2390.000	18.76	30.84	49.60	74.00	-24.40	peak
2 *	2390.000	4.82	30.84	35.66	54.00	-18.34	AVG

Remarks:
 1. Factor (dB/m) = Antenna Factor (dB/m)+Cable Factor (dB)-Pre-amplifier Factor
 2. Margin value = Level -Limit value



Ant. Pol.	Horizontal
Test Mode:	B Mode 2462 MHz

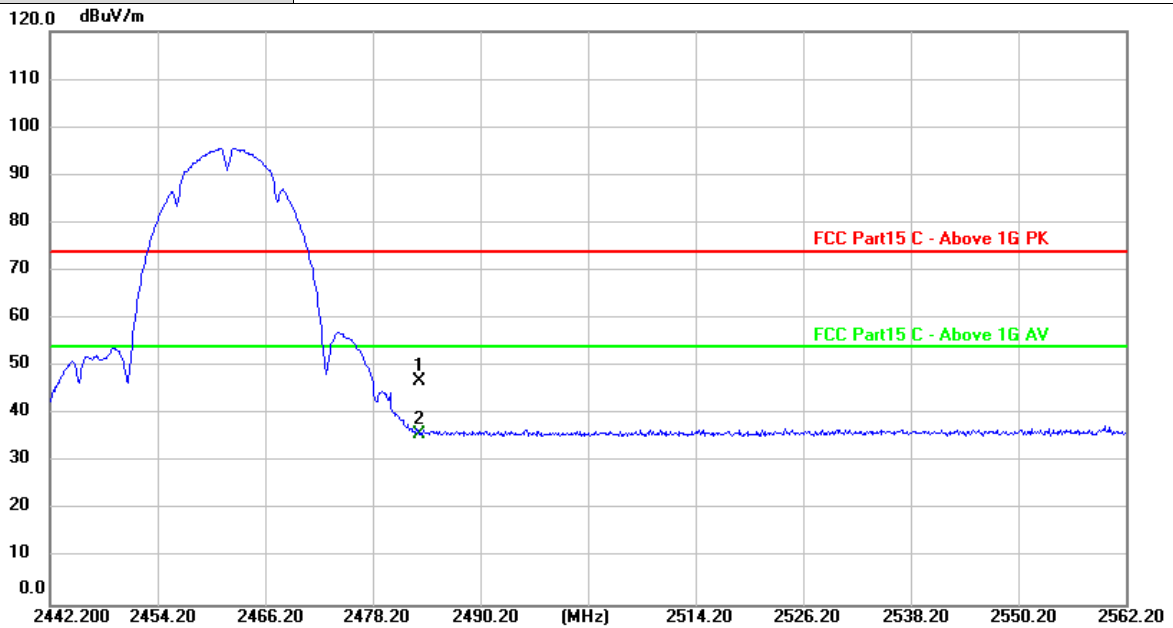

No.	Frequency (MHz)	Reading (dBuV)	Factor (dB/m)	Level (dBuV/m)	Limit (dBuV/m)	Margin (dB)	Detector
1	2483.500	15.71	31.24	46.95	74.00	-27.05	peak
2 *	2483.500	4.71	31.24	35.95	54.00	-18.05	AVG

Remarks:

1. Factor (dB/m) = Antenna Factor (dB/m)+Cable Factor (dB)-Pre-amplifier Factor
2. Margin value = Level -Limit value



Ant. Pol.	Vertical
Test Mode:	B Mode 2462 MHz

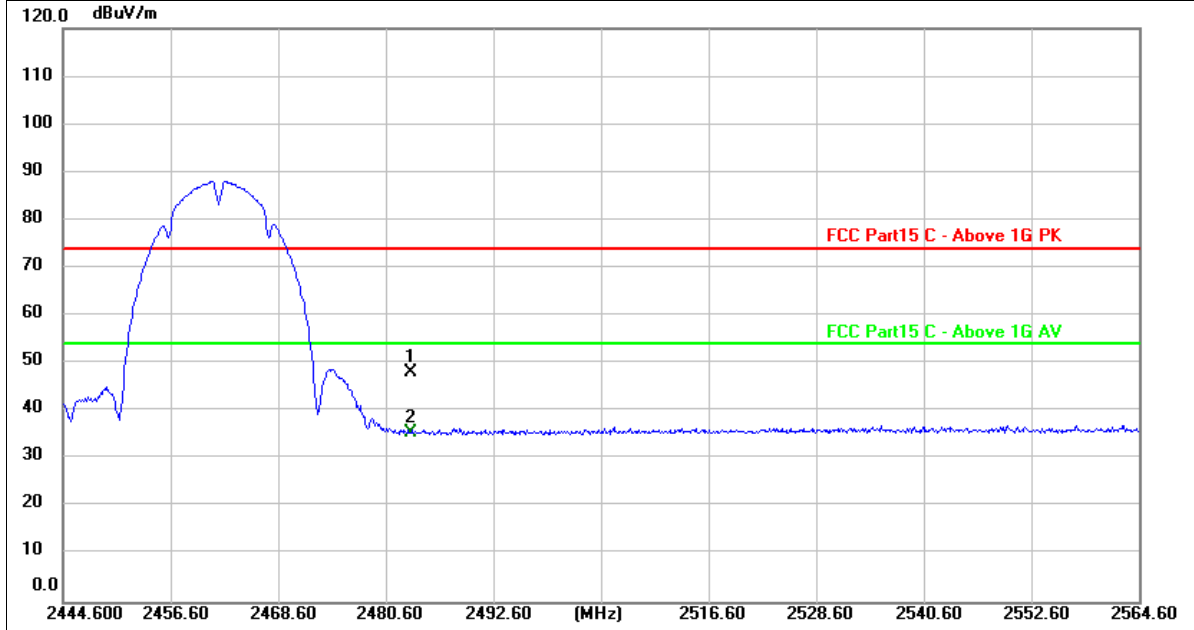

No.	Frequency (MHz)	Reading (dBuV)	Factor (dB/m)	Level (dBuV/m)	Limit (dBuV/m)	Margin (dB)	Detector
1	2483.500	16.80	31.24	48.04	74.00	-25.96	peak
2 *	2483.500	4.20	31.24	35.44	54.00	-18.56	AVG

Remarks:
 1. Factor (dB/m) = Antenna Factor (dB/m)+Cable Factor (dB)-Pre-amplifier Factor
 2. Margin value = Level -Limit value



Ant. Pol.	Horizontal
Test Mode:	G Mode 2412MHz

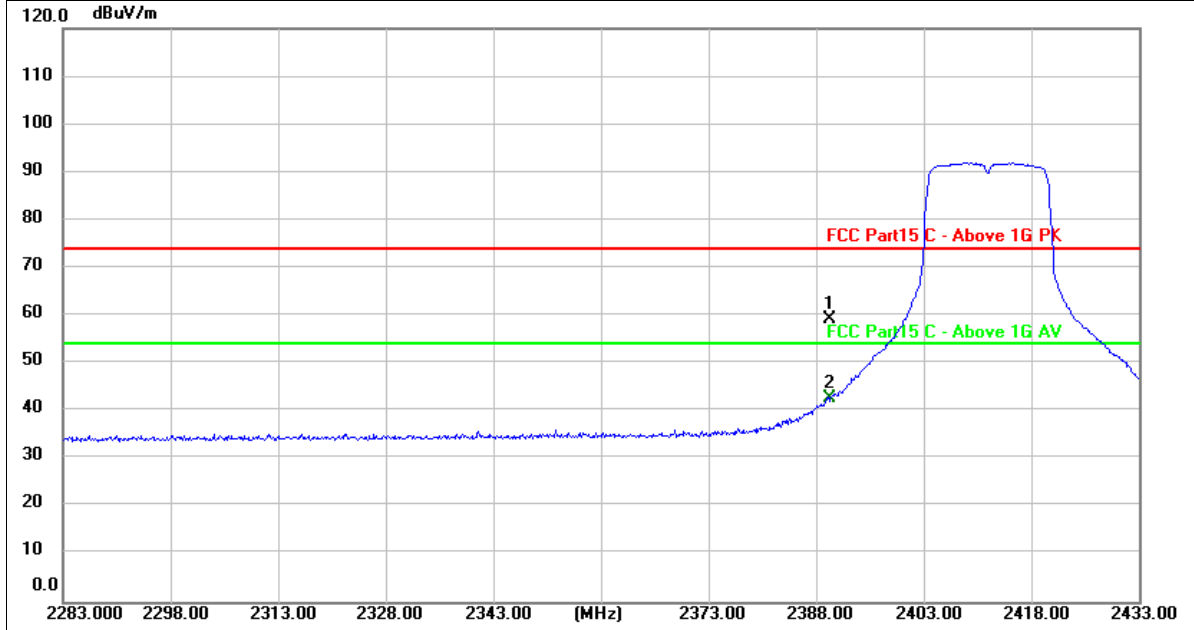

No.	Frequency (MHz)	Reading (dBuV)	Factor (dB/m)	Level (dBuV/m)	Limit (dBuV/m)	Margin (dB)	Detector
1	2390.000	28.44	30.84	59.28	74.00	-14.72	peak
2 *	2390.000	11.97	30.84	42.81	54.00	-11.19	AVG

Remarks:

- Factor (dB/m) = Antenna Factor (dB/m)+Cable Factor (dB)-Pre-amplifier Factor
- Margin value = Level -Limit value



Ant. Pol.	Vertical
Test Mode:	G Mode 2412MHz

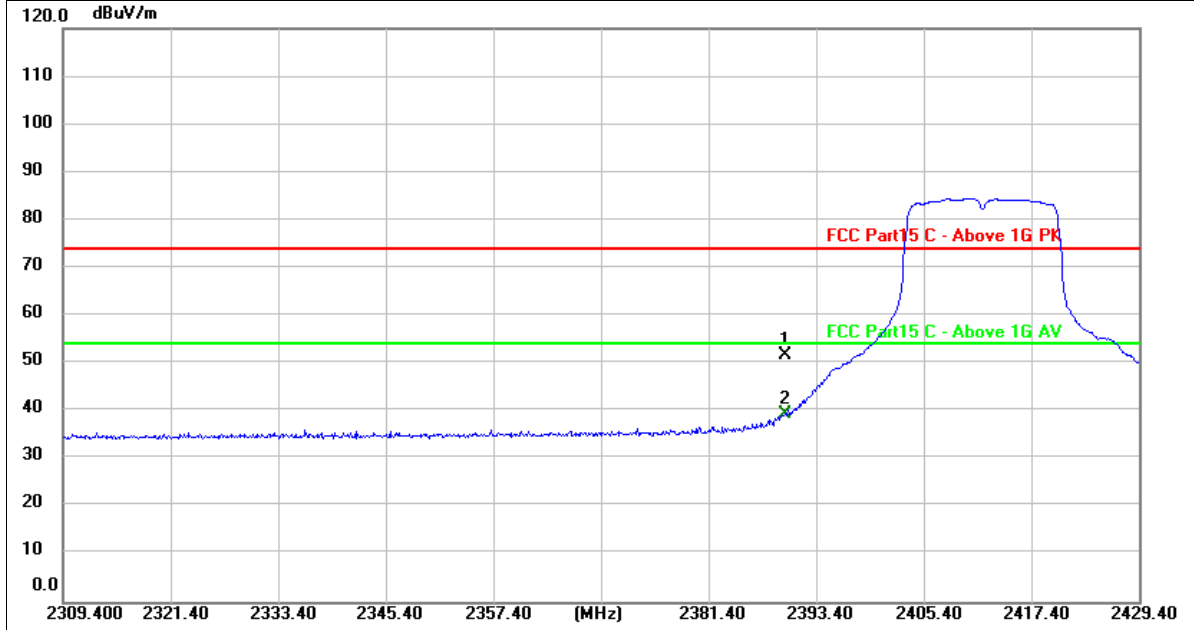

No.	Frequency (MHz)	Reading (dBuV)	Factor (dB/m)	Level (dBuV/m)	Limit (dBuV/m)	Margin (dB)	Detector
1	2390.000	20.77	30.84	51.61	74.00	-22.39	peak
2 *	2390.000	8.49	30.84	39.33	54.00	-14.67	AVG

Remarks:

- 1. Factor (dB/m) = Antenna Factor (dB/m)+Cable Factor (dB)-Pre-amplifier Factor
- 2. Margin value = Level -Limit value



Ant. Pol.	Horizontal
Test Mode:	G Mode 2462MHz

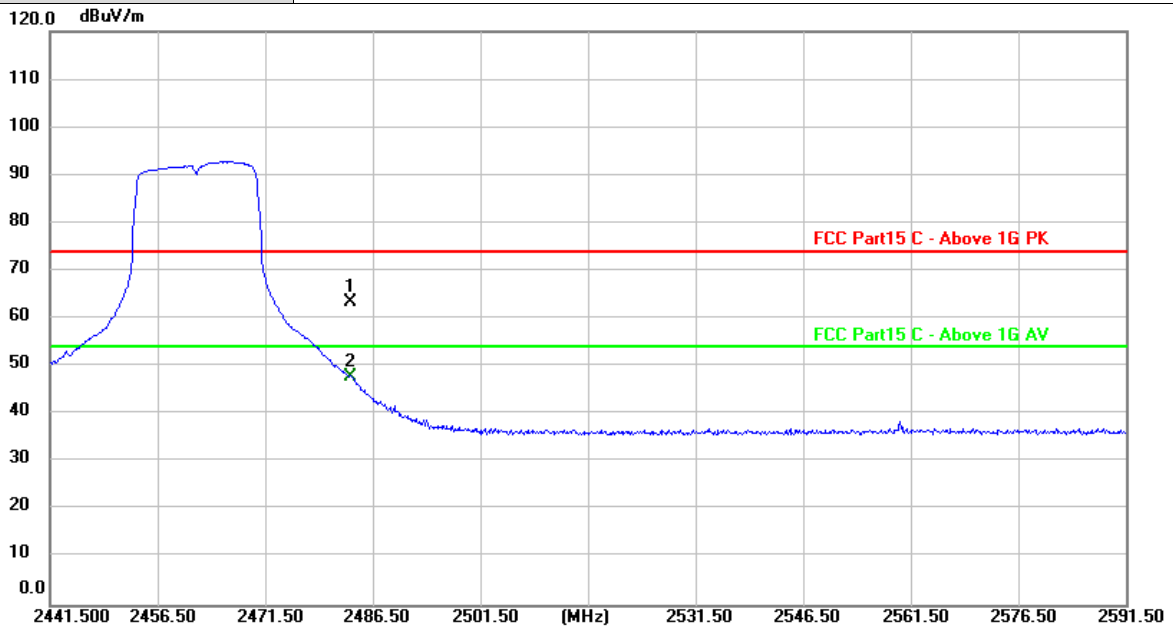

No.	Frequency (MHz)	Reading (dBuV)	Factor (dB/m)	Level (dBuV/m)	Limit (dBuV/m)	Margin (dB)	Detector
1	2483.500	32.25	31.24	63.49	74.00	-10.51	peak
2 *	2483.500	16.59	31.24	47.83	54.00	-6.17	AVG

Remarks:

1. Factor (dB/m) = Antenna Factor (dB/m)+Cable Factor (dB)-Pre-amplifier Factor
2. Margin value = Level -Limit value



Ant. Pol.	Vertical
Test Mode:	G Mode 2462MHz

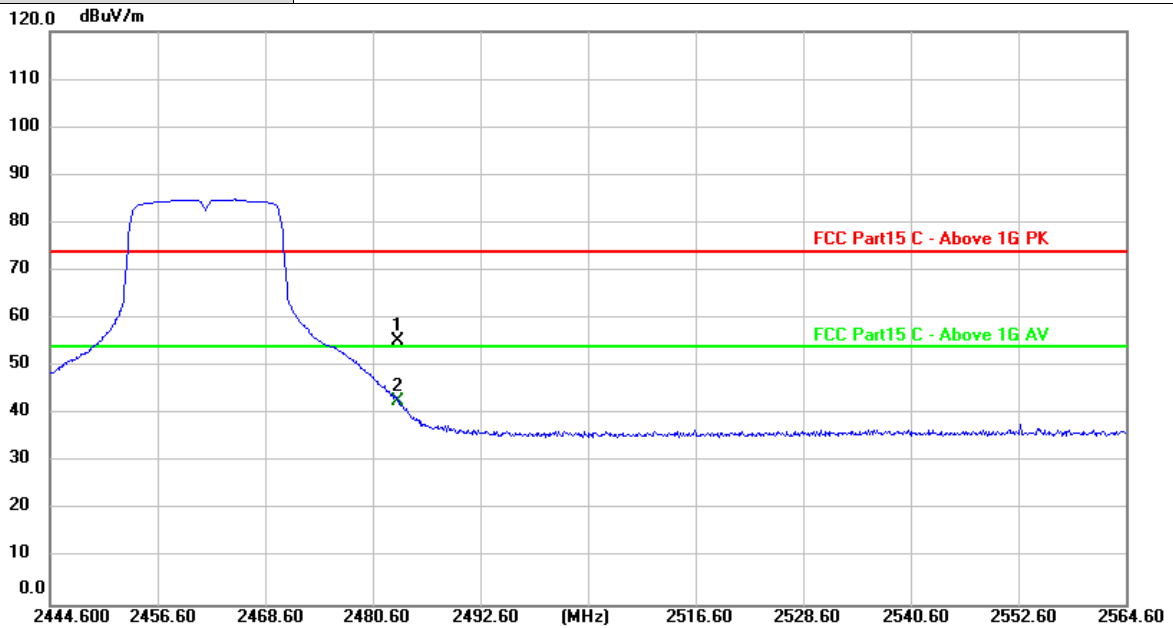

No.	Frequency (MHz)	Reading (dBuV)	Factor (dB/m)	Level (dBuV/m)	Limit (dBuV/m)	Margin (dB)	Detector
1	2483.500	24.02	31.24	55.26	74.00	-18.74	peak
2 *	2483.500	11.47	31.24	42.71	54.00	-11.29	AVG

Remarks:

1. Factor (dB/m) = Antenna Factor (dB/m)+Cable Factor (dB)-Pre-amplifier Factor
2. Margin value = Level -Limit value



Ant. Pol.	Horizontal
Test Mode:	N(HT20) Mode 2412MHz

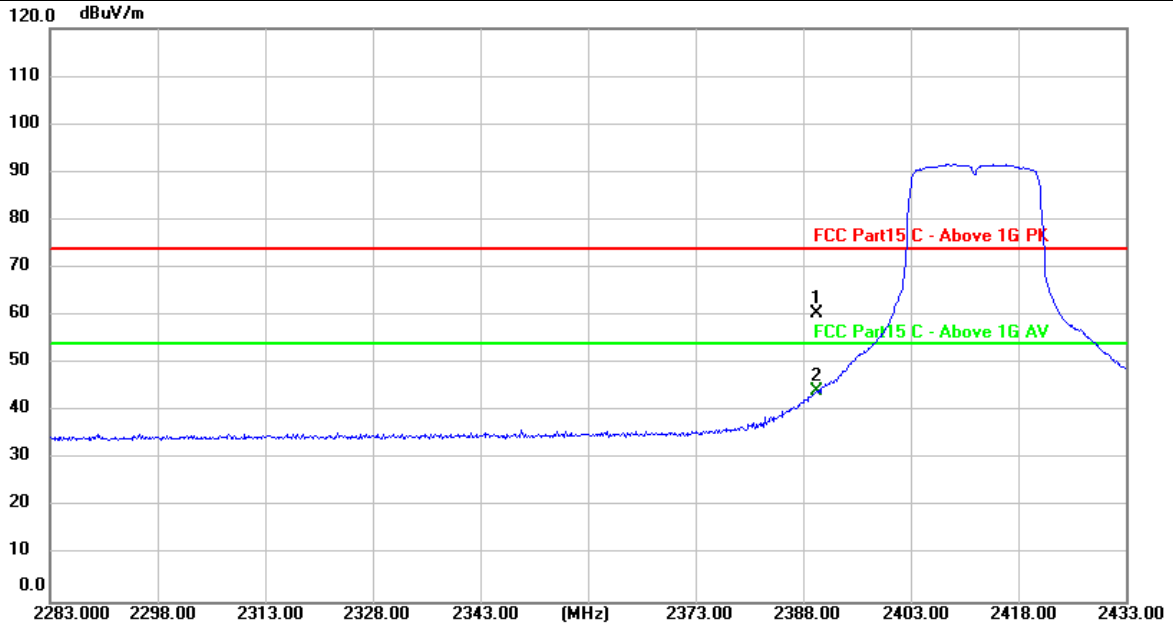

No.	Frequency (MHz)	Reading (dBuV)	Factor (dB/m)	Level (dBuV/m)	Limit (dBuV/m)	Margin (dB)	Detector
1	2390.000	29.64	30.84	60.48	74.00	-13.52	peak
2 *	2390.000	13.37	30.84	44.21	54.00	-9.79	AVG

Remarks:

- 1. Factor (dB/m) = Antenna Factor (dB/m)+Cable Factor (dB)-Pre-amplifier Factor
- 2. Margin value = Level -Limit value



Ant. Pol.	Vertical
Test Mode:	N(HT20) Mode 2412MHz

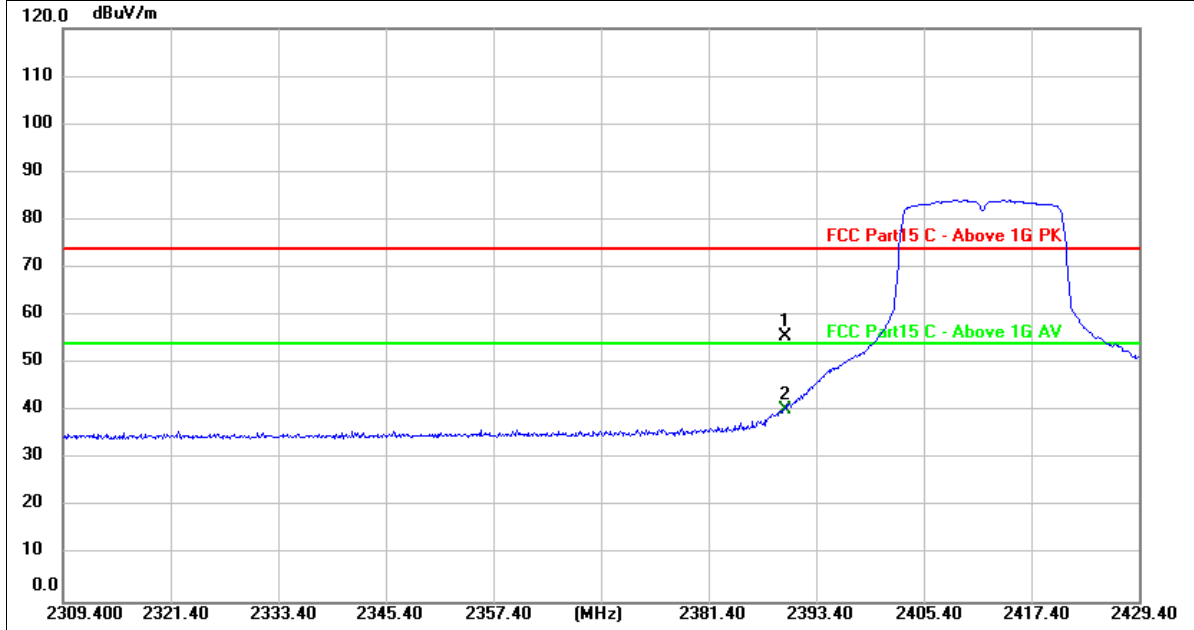

No.	Frequency (MHz)	Reading (dBuV)	Factor (dB/m)	Level (dBuV/m)	Limit (dBuV/m)	Margin (dB)	Detector
1	2390.000	24.89	30.84	55.73	74.00	-18.27	peak
2 *	2390.000	9.66	30.84	40.50	54.00	-13.50	AVG

Remarks:

- Factor (dB/m) = Antenna Factor (dB/m)+Cable Factor (dB)-Pre-amplifier Factor
- Margin value = Level -Limit value



Ant. Pol.	Horizontal
Test Mode:	N(HT20) Mode 2462MHz

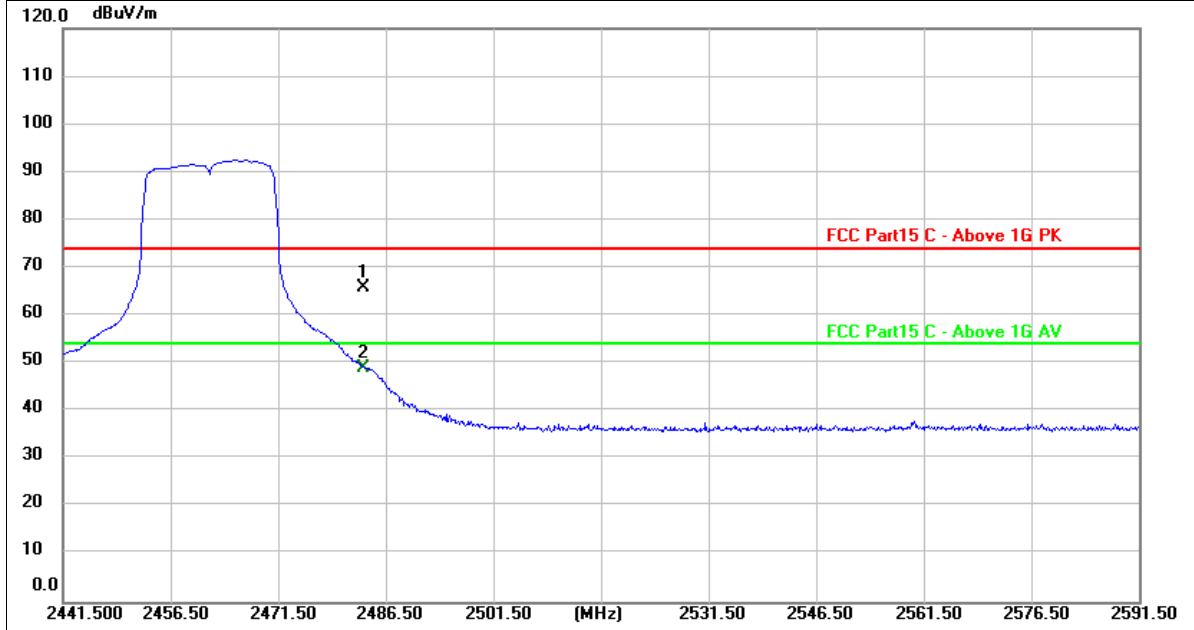

No.	Frequency (MHz)	Reading (dBuV)	Factor (dB/m)	Level (dBuV/m)	Limit (dBuV/m)	Margin (dB)	Detector
1	2483.500	34.74	31.24	65.98	74.00	-8.02	peak
2 *	2483.500	17.87	31.24	49.11	54.00	-4.89	AVG

Remarks:

- 1. Factor (dB/m) = Antenna Factor (dB/m)+Cable Factor (dB)-Pre-amplifier Factor
- 2. Margin value = Level -Limit value



Ant. Pol.	Vertical
Test Mode:	N(HT20) Mode 2462MHz

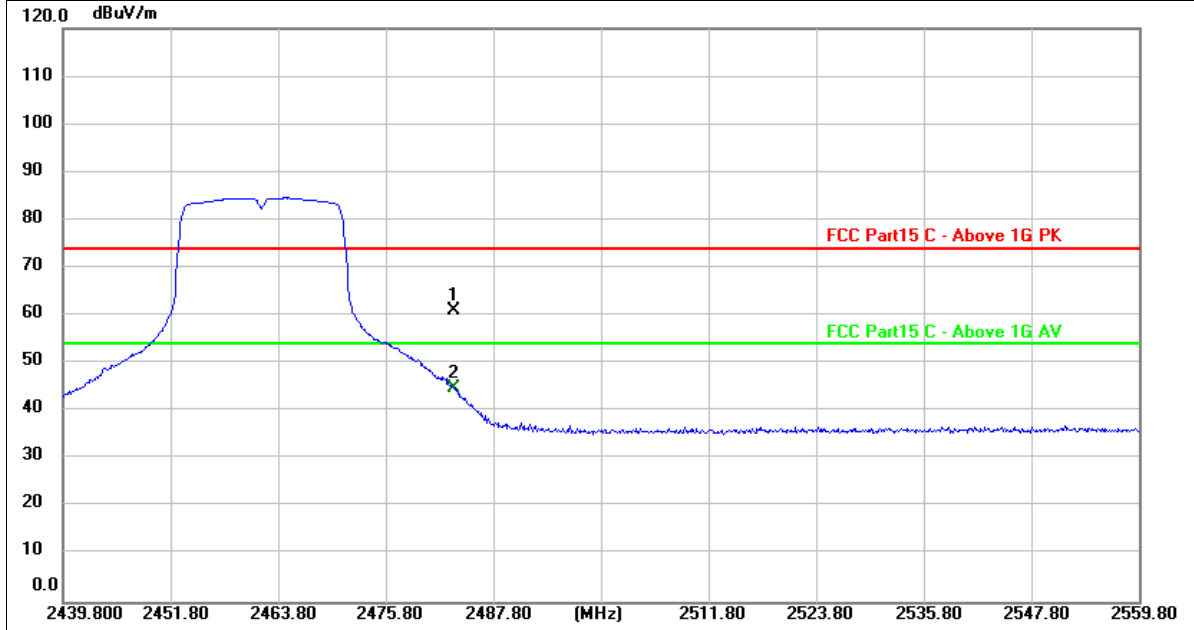

No.	Frequency (MHz)	Reading (dBuV)	Factor (dB/m)	Level (dBuV/m)	Limit (dBuV/m)	Margin (dB)	Detector
1	2483.500	29.76	31.24	61.00	74.00	-13.00	peak
2 *	2483.500	13.71	31.24	44.95	54.00	-9.05	AVG

Remarks:
 1. Factor (dB/m) = Antenna Factor (dB/m)+Cable Factor (dB)-Pre-amplifier Factor
 2. Margin value = Level -Limit value



Ant. Pol.	Horizontal
Test Mode:	N(HT40) Mode 2422MHz

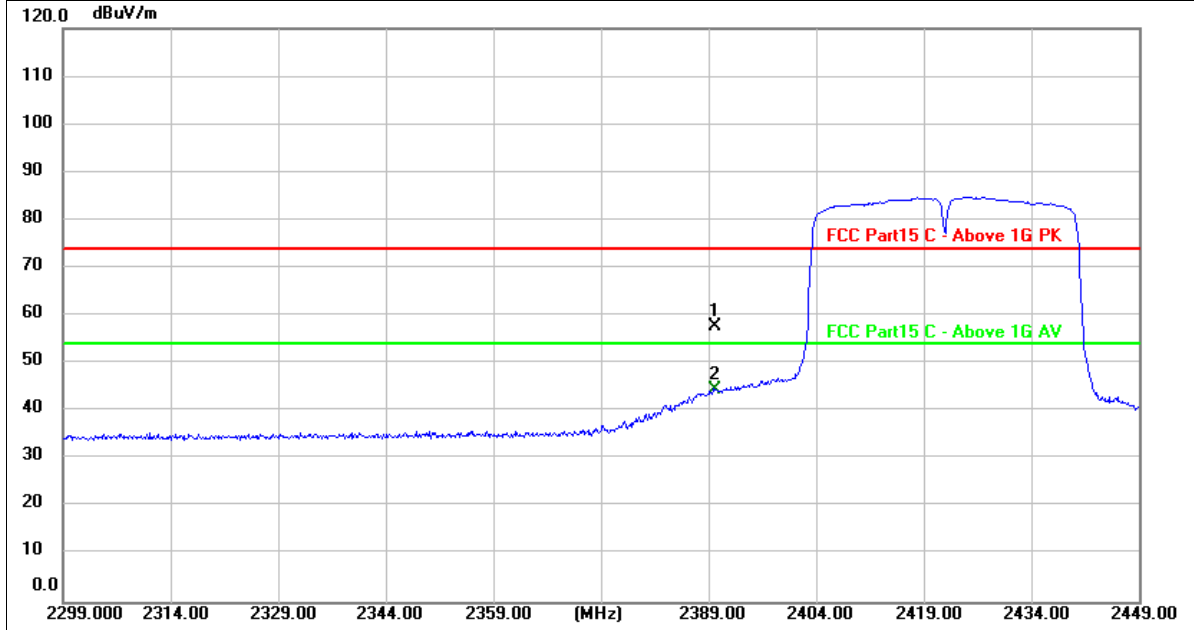

No.	Frequency (MHz)	Reading (dBuV)	Factor (dB/m)	Level (dBuV/m)	Limit (dBuV/m)	Margin (dB)	Detector
1	2390.000	27.06	30.84	57.90	74.00	-16.10	peak
2 *	2390.000	13.69	30.84	44.53	54.00	-9.47	AVG

Remarks:

- 1. Factor (dB/m) = Antenna Factor (dB/m)+Cable Factor (dB)-Pre-amplifier Factor
- 2. Margin value = Level -Limit value



Ant. Pol.	Vertical
Test Mode:	N(HT40) Mode 2422MHz

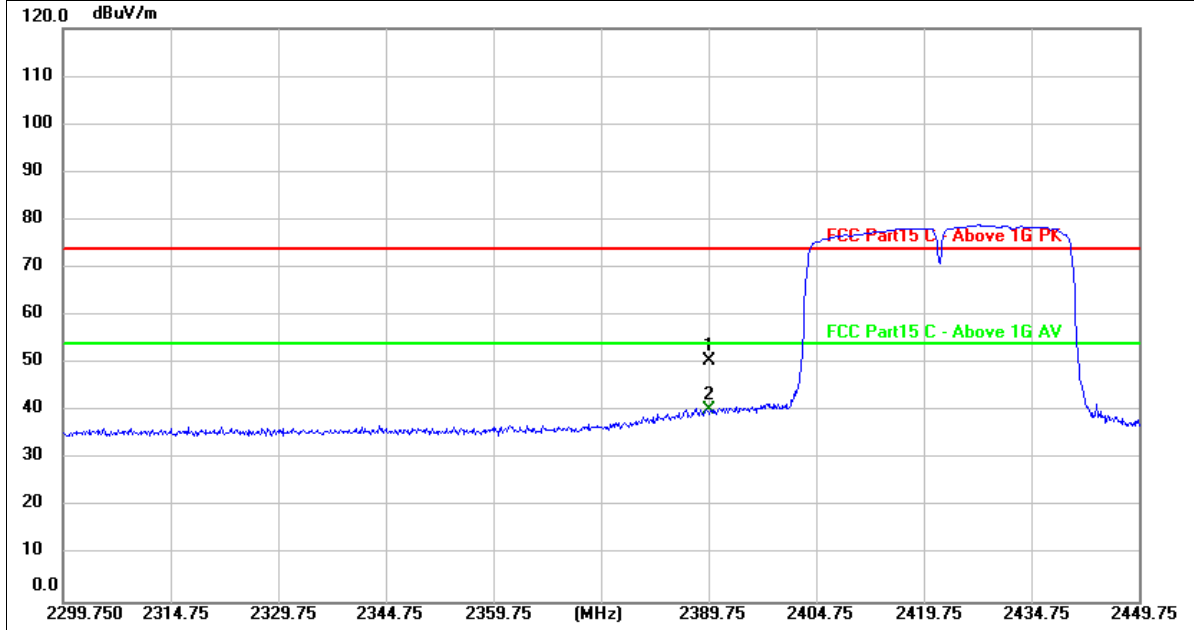

No.	Frequency (MHz)	Reading (dBuV)	Factor (dB/m)	Level (dBuV/m)	Limit (dBuV/m)	Margin (dB)	Detector
1	2390.000	19.73	30.84	50.57	74.00	-23.43	peak
2 *	2390.000	9.44	30.84	40.28	54.00	-13.72	AVG

Remarks:
 1. Factor (dB/m) = Antenna Factor (dB/m)+Cable Factor (dB)-Pre-amplifier Factor
 2. Margin value = Level -Limit value



Ant. Pol.	Horizontal
Test Mode:	N(HT40) Mode 2452MHz

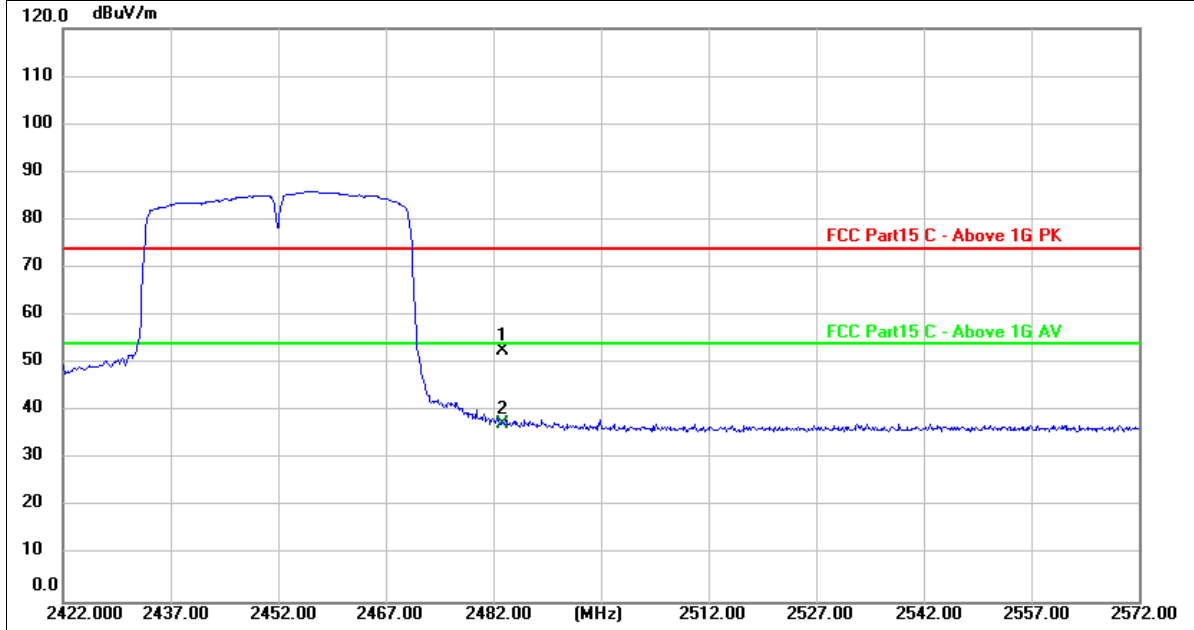

No.	Frequency (MHz)	Reading (dBuV)	Factor (dB/m)	Level (dBuV/m)	Limit (dBuV/m)	Margin (dB)	Detector
1	2483.500	21.47	31.24	52.71	74.00	-21.29	peak
2 *	2483.500	6.11	31.24	37.35	54.00	-16.65	AVG

Remarks:

- 1. Factor (dB/m) = Antenna Factor (dB/m)+Cable Factor (dB)-Pre-amplifier Factor
- 2. Margin value = Level -Limit value



Ant. Pol.	Vertical
Test Mode:	N(HT40) Mode 2452MHz

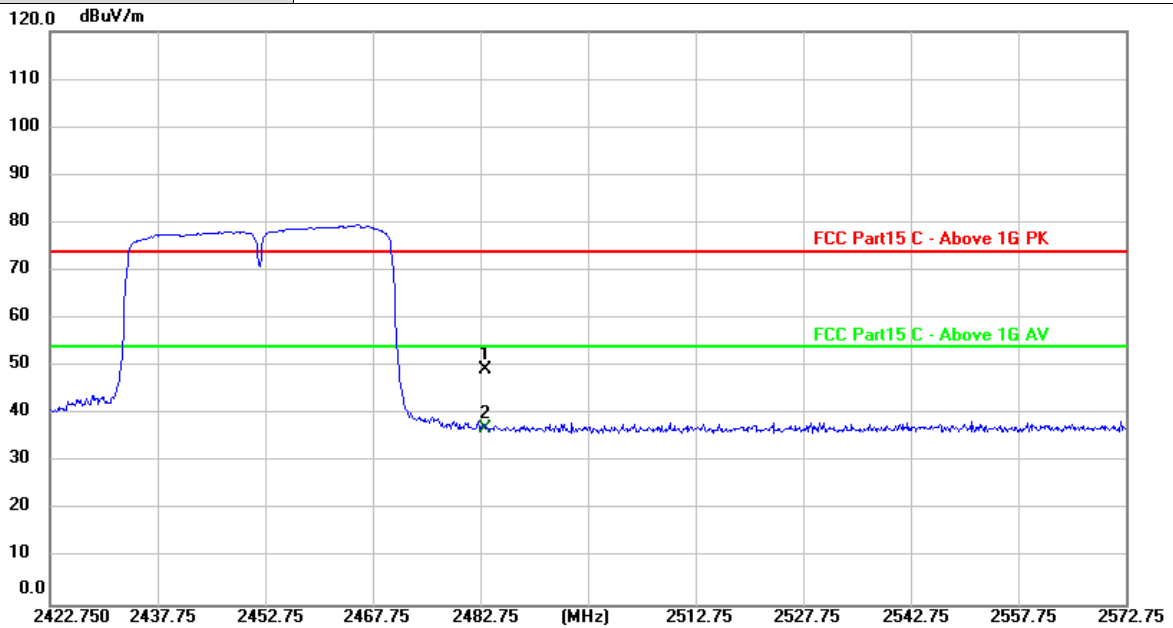

No.	Frequency (MHz)	Reading (dBuV)	Factor (dB/m)	Level (dBuV/m)	Limit (dBuV/m)	Margin (dB)	Detector
1	2483.500	18.02	31.24	49.26	74.00	-24.74	peak
2 *	2483.500	5.69	31.24	36.93	54.00	-17.07	AVG

Remarks:

1. Factor (dB/m) = Antenna Factor (dB/m)+Cable Factor (dB)-Pre-amplifier Factor
2. Margin value = Level -Limit value

3.4. Band edge and Spurious Emissions (Conducted)

Limit

FCC CFR Title 47 Part 15 Subpart C Section 15.247 (d): In any 100 kHz bandwidth outside the frequency band in which the spread spectrum intentional radiator is operating, the radio frequency power that is produced by the intentional radiator shall be at least 20 dB below that in the 100 kHz bandwidth within the band that contains the highest level of the desired power, based on either an RF conducted or a radiated measurement.

Test Configuration

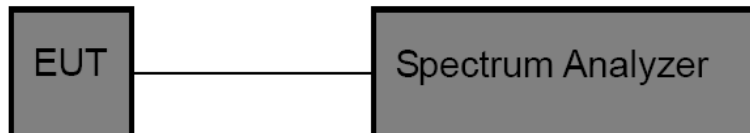

Test Procedure

1. The transmitter output was connected to the spectrum analyzer through an attenuator, the path loss was compensated to the results for each measurement.
2. Set to the maximum power setting and enable the EUT transmit continuously
3. Use the following spectrum analyzer settings:
RBW = 100 kHz, VBW ≥ RBW, scan up through 10th harmonic.
Sweep = auto, Detector function = peak, Trace = max hold
4. Measure and record the results in the test report.

Test Mode

Please refer to the clause 2.4.

Test Results

(1) Band edge Conducted Test

Test Mode	Antenna	ChName	Channel	RefLevel[dBm]	Result[dBm]	Limit[dBm]	Verdict
11B	Ant1	Low	2412	5.06	-38.65	≤-14.94	PASS
		High	2462	5.52	-55.62	≤-14.48	PASS
11G	Ant1	Low	2412	3.30	-31.50	≤-16.70	PASS
		High	2462	1.49	-32.03	≤-18.51	PASS
11N20SISO	Ant1	Low	2412	2.28	-29.48	≤-17.72	PASS
		High	2462	3.09	-30.23	≤-16.91	PASS
11N40SISO	Ant1	Low	2422	1.16	-32.30	≤-18.84	PASS
		High	2452	1.72	-25.54	≤-18.28	PASS



Test plot as follows:

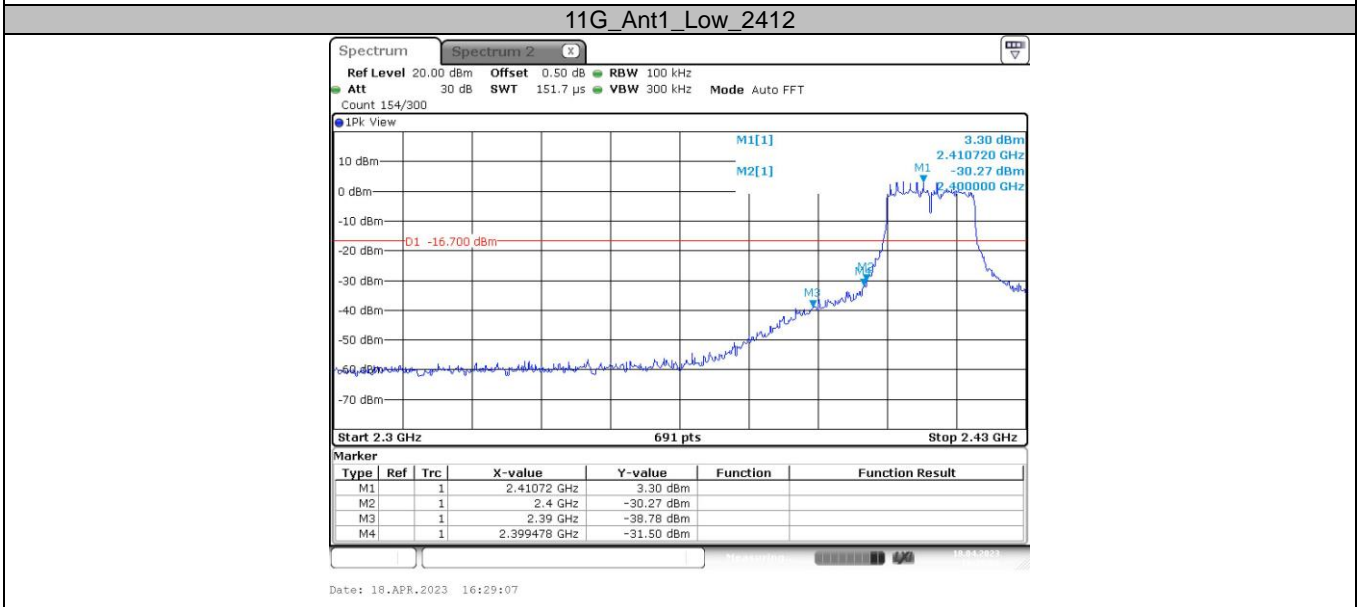
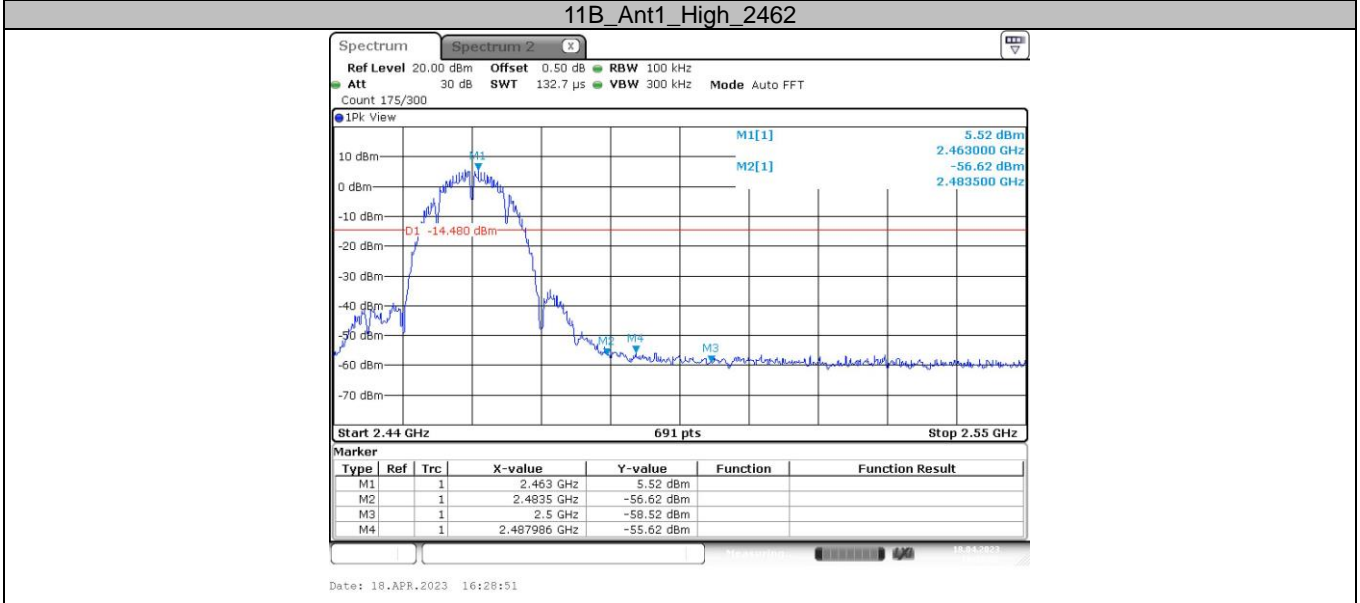
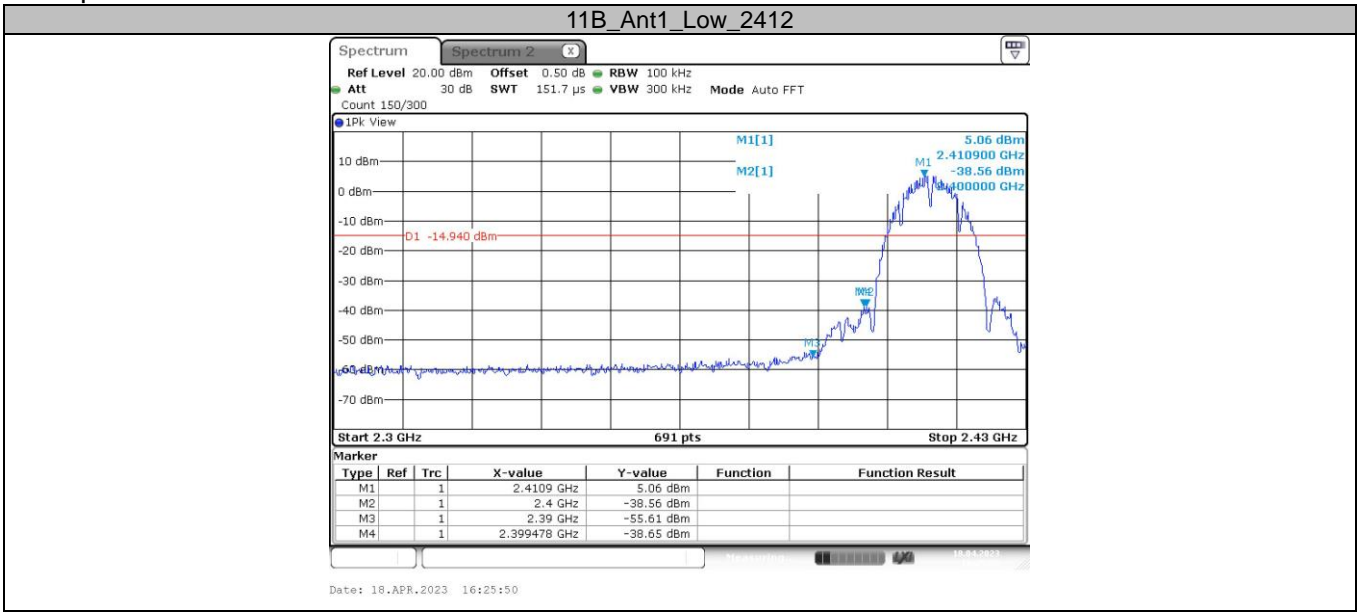

11G_Ant1_High_2462

CTC Laboratories, Inc.

1-2/F., Building 2, Jiaquan Building, Guanlan High-Tech Park, Shenzhen, Guangdong, China
Tel.: (86)755-27521059 Fax: (86)755-27521011 Http://www.sz-ctc.org.cn



For anti-fake verification, please visit the official website of Certification and Accreditation Administration of the People's Republic of China : yz.cnca.cn

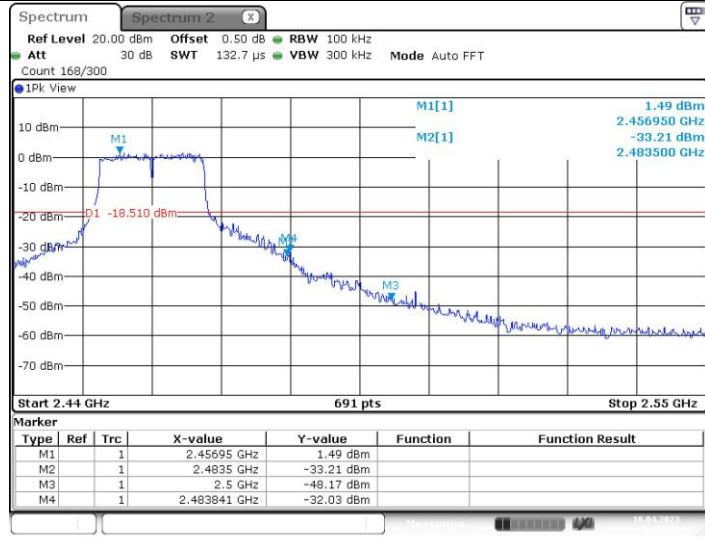

Date: 18.APR.2023 16:29:25

11N20SISO_Ant1_Low_2412

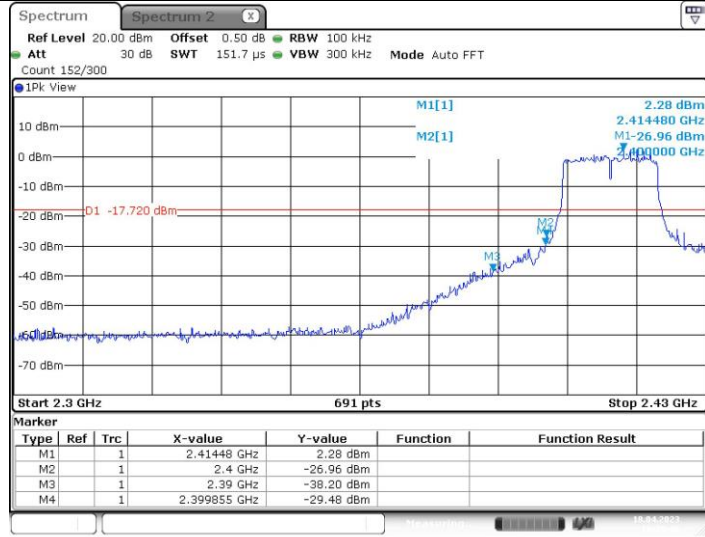

Date: 18.APR.2023 16:29:48

11N20SISO_Ant1_High_2462

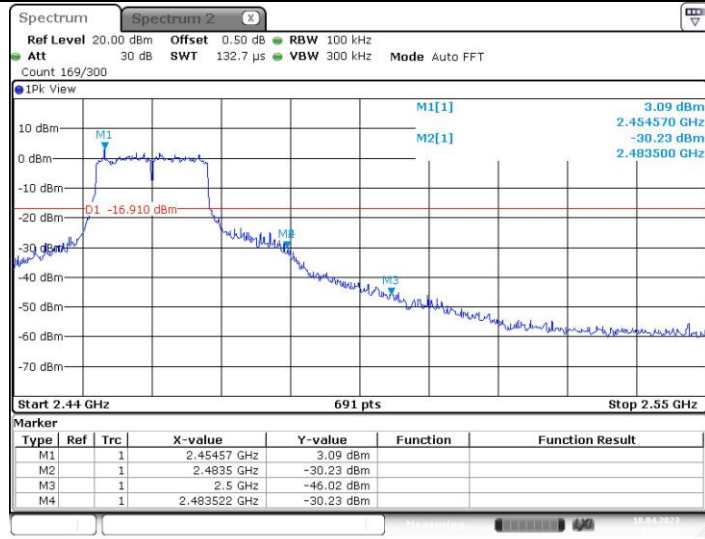

Date: 18.APR.2023 16:30:01

11N40SISO_Ant1_Low_2422

CTC Laboratories, Inc.

1-2/F., Building 2, Jiaquan Building, Guanlan High-Tech Park, Shenzhen, Guangdong, China
Tel.: (86)755-27521059 Fax: (86)755-27521011 Http://www.sz-ctc.org.cn



For anti-fake verification, please visit the official website of Certification and Accreditation Administration of the People's Republic of China : yz.cnca.cn

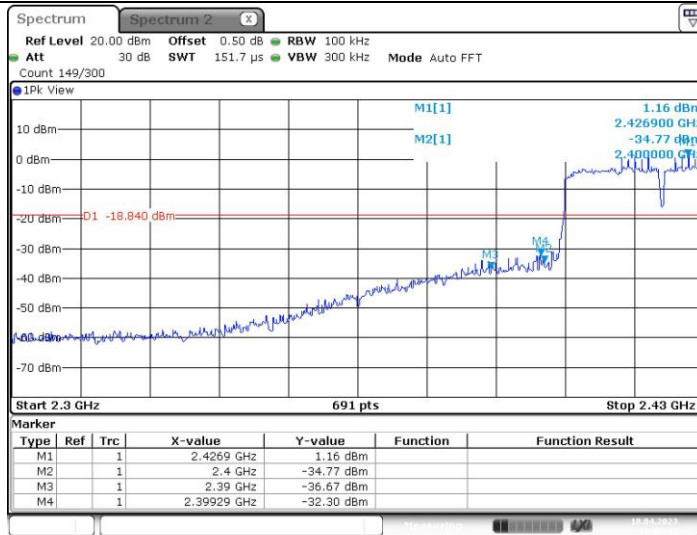

Date: 18.APR.2023 16:30:15

11N40SISO_Ant1_High_2452

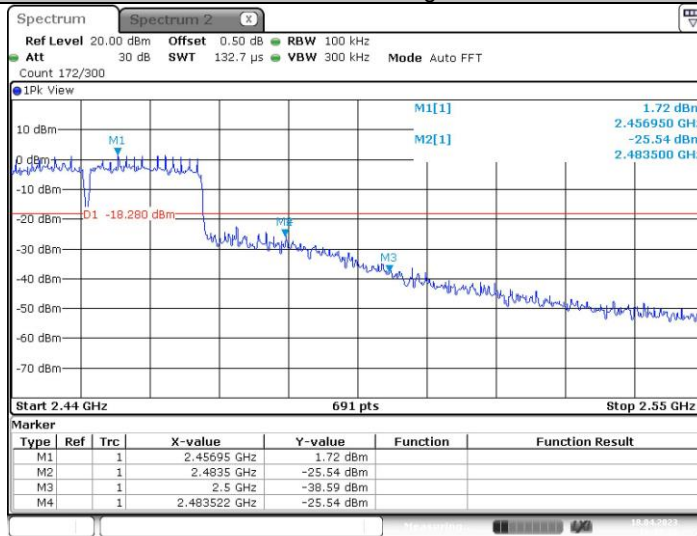

Date: 18.APR.2023 16:30:28



(2) Conducted Spurious Emissions Test

Test Mode	Antenna	Channel	FreqRange [Mhz]	RefLevel [dBm]	Result [dBm]	Limit [dBm]	Verdict		
11B	Ant1	2412	Reference	5.57	5.57	---	PASS		
			30~1000	5.57	-60.94	≤-14.43	PASS		
			1000~26500	5.57	-42.45	≤-14.43	PASS		
		2437	Ant1	2437	Reference	5.45	5.45	---	PASS
					30~1000	5.45	-60.86	≤-14.55	PASS
					1000~26500	5.45	-42.43	≤-14.55	PASS
		2462	Ant1	2462	Reference	5.33	5.33	---	PASS
					30~1000	5.33	-58.20	≤-14.67	PASS
					1000~26500	5.33	-42.72	≤-14.67	PASS
11G	Ant1	2412	Reference	3.40	3.40	---	PASS		
			30~1000	3.40	-61.53	≤-16.60	PASS		
			1000~26500	3.40	-42.29	≤-16.60	PASS		
		2437	Ant1	2437	Reference	1.94	1.94	---	PASS
					30~1000	1.94	-60.41	≤-18.06	PASS
					1000~26500	1.94	-41.84	≤-18.06	PASS
		2462	Ant1	2462	Reference	4.19	4.19	---	PASS
					30~1000	4.19	-61.38	≤-15.81	PASS
					1000~26500	4.19	-41.36	≤-15.81	PASS
11N20SISO	Ant1	2412	Reference	3.45	3.45	---	PASS		
			30~1000	3.45	-60.30	≤-16.55	PASS		
			1000~26500	3.45	-42.46	≤-16.55	PASS		
		2437	Ant1	2437	Reference	2.92	2.92	---	PASS
					30~1000	2.92	-60.32	≤-17.08	PASS
					1000~26500	2.92	-42.90	≤-17.08	PASS
		2462	Ant1	2462	Reference	3.24	3.24	---	PASS
					30~1000	3.24	-60.41	≤-16.76	PASS
					1000~26500	3.24	-42.55	≤-16.76	PASS
11N40SISO	Ant1	2422	Reference	-0.32	-0.32	---	PASS		
			30~1000	-0.32	-54.54	≤-20.32	PASS		
			1000~26500	-0.32	-42.63	≤-20.32	PASS		
		2437	Ant1	2437	Reference	1.30	1.30	---	PASS
					30~1000	1.30	-54.27	≤-18.70	PASS
					1000~26500	1.30	-41.59	≤-18.70	PASS
		2452	Ant1	2452	Reference	1.48	1.48	---	PASS
					30~1000	1.48	-54.72	≤-18.52	PASS
					1000~26500	1.48	-42.40	≤-18.52	PASS



Test plot as follows:

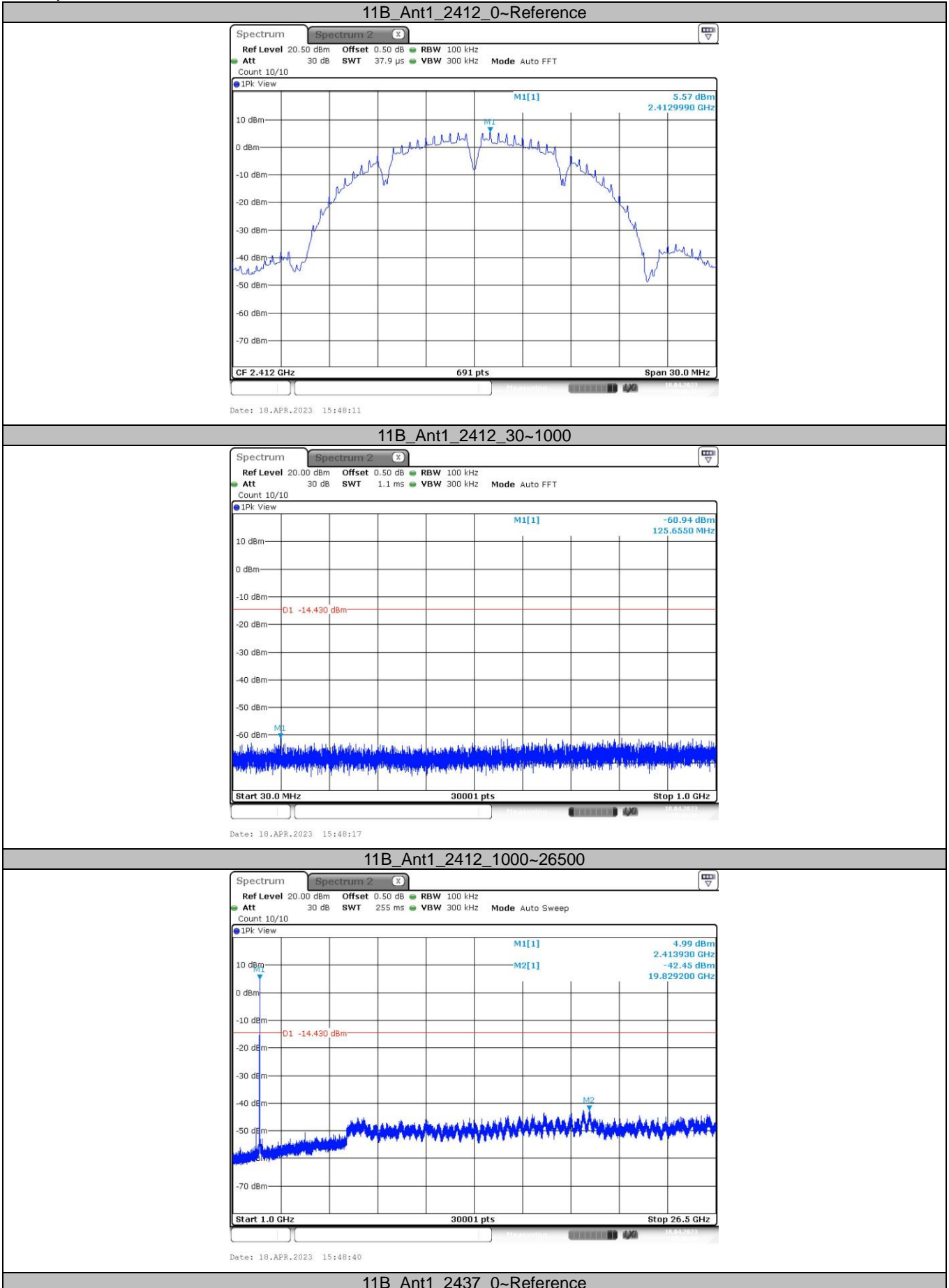

11B_Ant1_2437_0-Reference

CTC Laboratories, Inc.

1-2/F., Building 2, Jiaquan Building, Guanlan High-Tech Park, Shenzhen, Guangdong, China
Tel.: (86)755-27521059 Fax: (86)755-27521011 Http://www.sz-ctc.org.cn



For anti-fake verification, please visit the official website of Certification and Accreditation Administration of the People's Republic of China : yz.cnca.cn

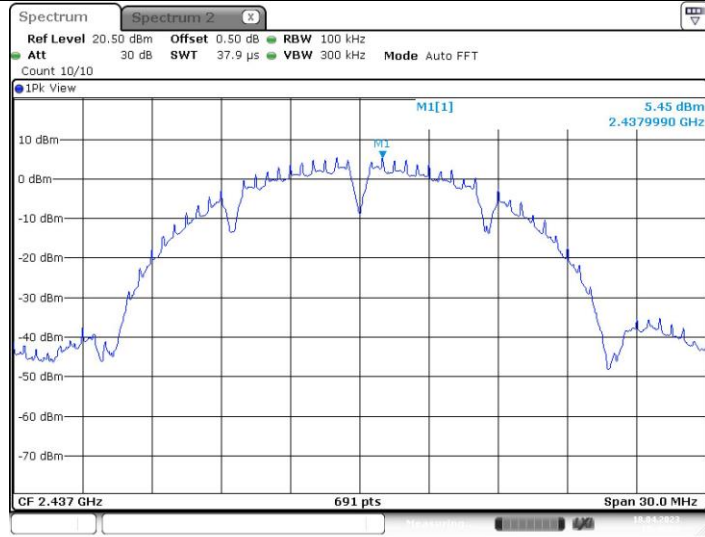

Date: 18.APR.2023 15:49:10

11B_Ant1_2437_30~1000

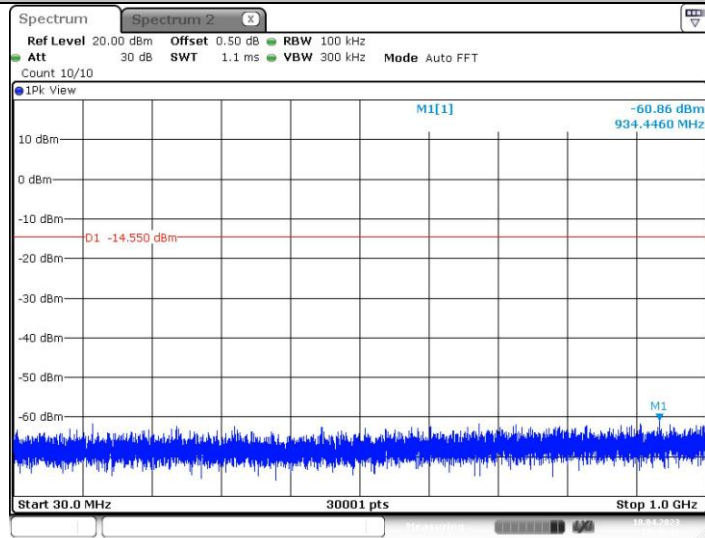

Date: 18.APR.2023 15:49:15

11B_Ant1_2437_1000~26500

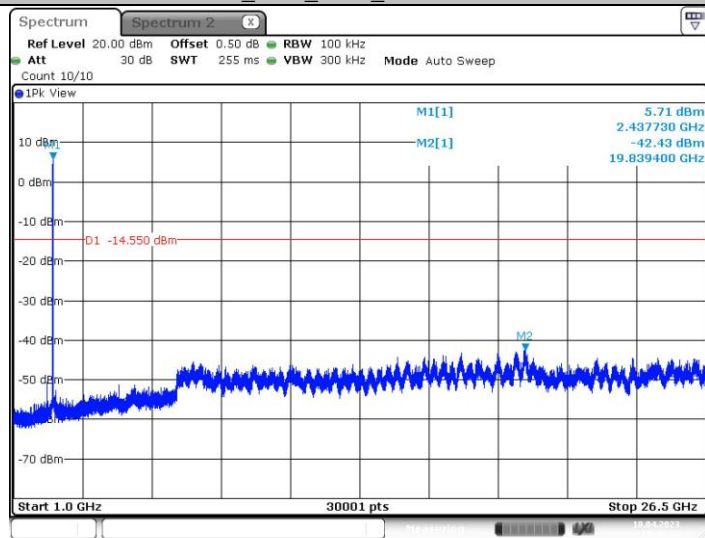

Date: 18.APR.2023 15:49:38

11B_Ant1_2462_0~Reference

CTC Laboratories, Inc.

1-2/F., Building 2, Jiaquan Building, Guanlan High-Tech Park, Shenzhen, Guangdong, China
Tel.: (86)755-27521059 Fax: (86)755-27521011 Http://www.sz-ctc.org.cn



For anti-fake verification, please visit the official website of Certification and Accreditation Administration of the People's Republic of China : yz.cnca.cn

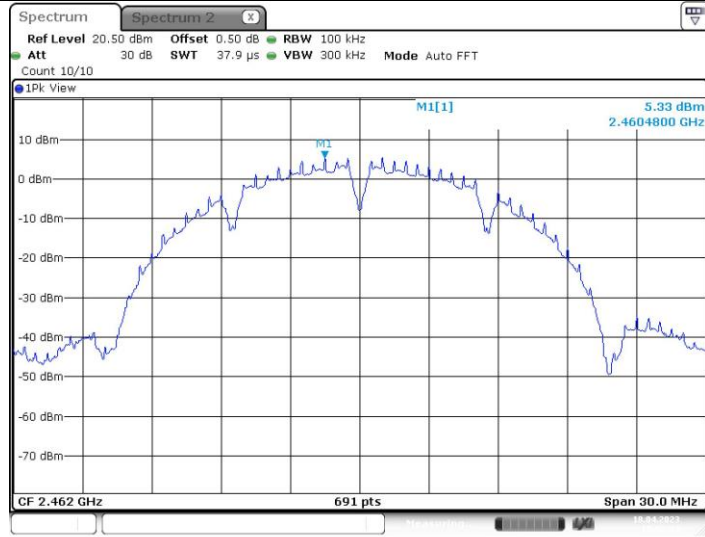

Date: 18.APR.2023 15:52:53

11B_Ant1_2462_30~1000

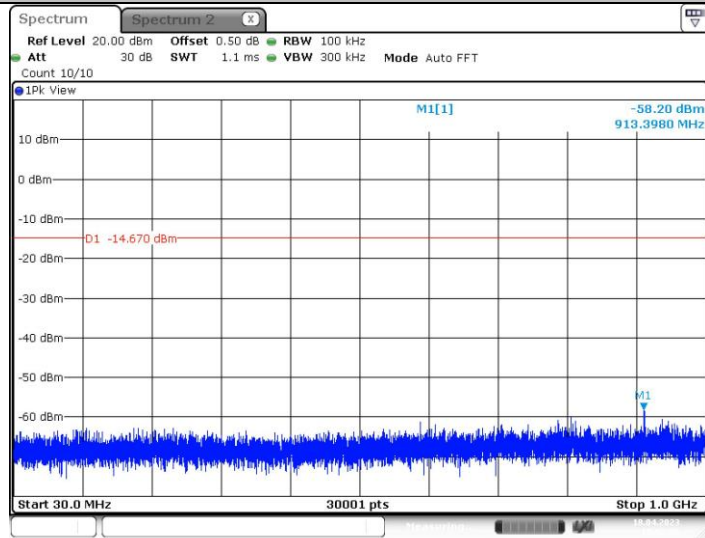

Date: 18.APR.2023 15:52:59

11B_Ant1_2462_1000~26500

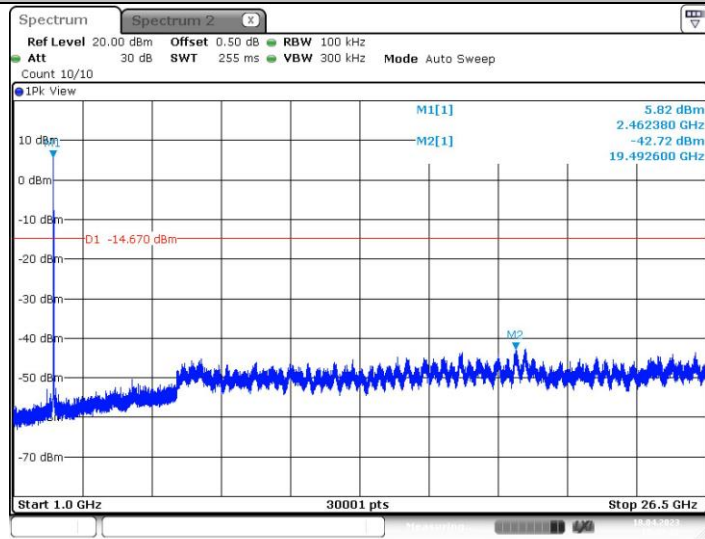

Date: 18.APR.2023 15:53:22

11G_Ant1_2412_0~Reference

CTC Laboratories, Inc.

1-2/F., Building 2, Jiaquan Building, Guanlan High-Tech Park, Shenzhen, Guangdong, China
Tel.: (86)755-27521059 Fax: (86)755-27521011 Http://www.sz-ctc.org.cn



For anti-fake verification, please visit the official website of Certification and Accreditation Administration of the People's Republic of China : yz.cnca.cn

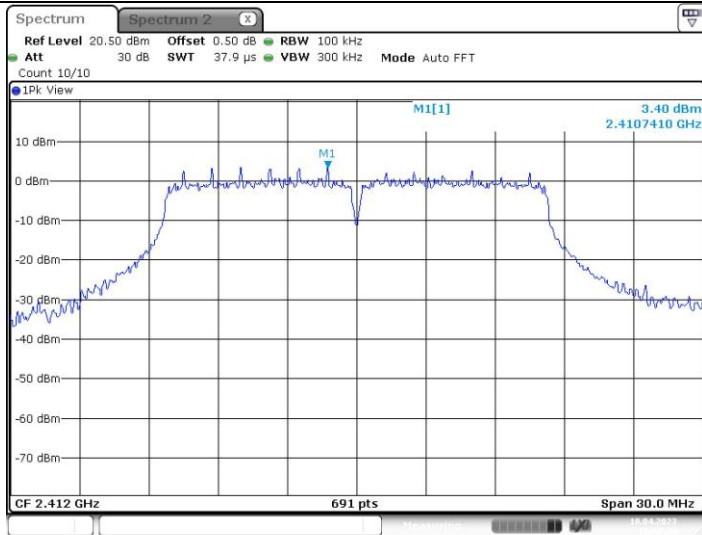

11G_Ant1_2412_30~1000

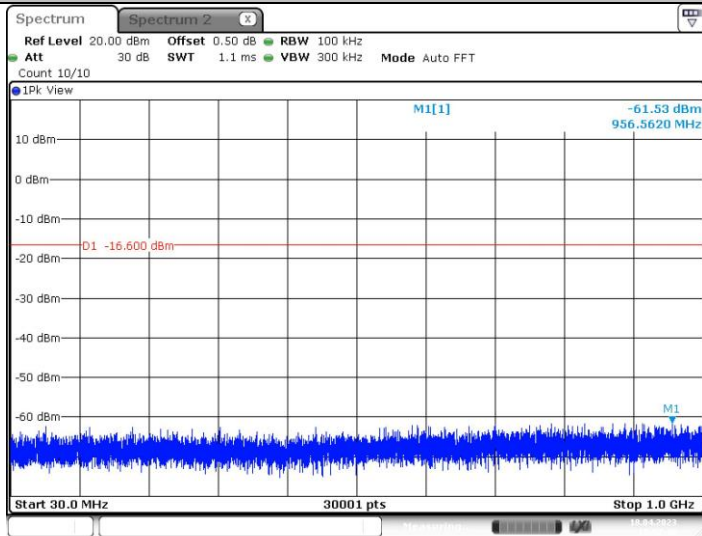

11G_Ant1_2412_1000~26500

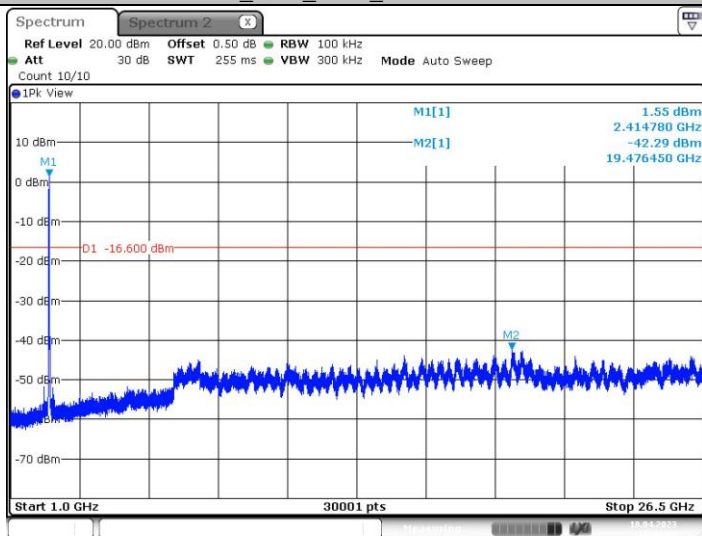

11G_Ant1_2437_0~Reference

CTC Laboratories, Inc.

1-2/F., Building 2, Jiaquan Building, Guanlan High-Tech Park, Shenzhen, Guangdong, China
Tel.: (86)755-27521059 Fax: (86)755-27521011 Http://www.sz-ctc.org.cn



For anti-fake verification, please visit the official website of Certification and Accreditation Administration of the People's Republic of China : yz.cnca.cn

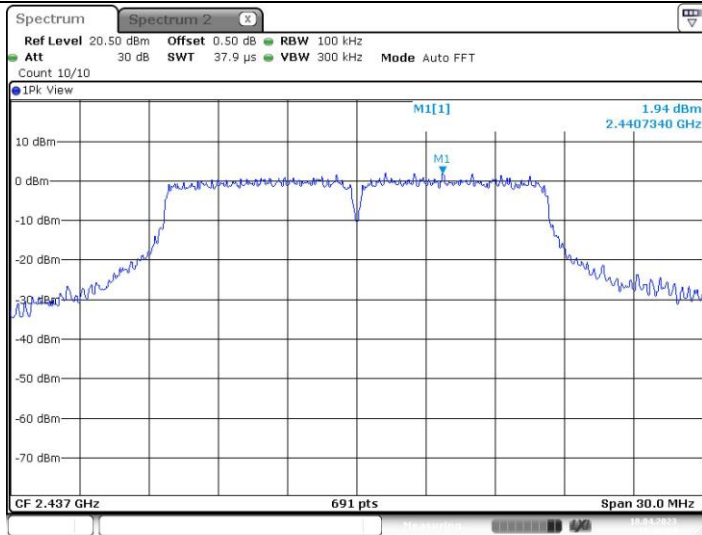

Date: 18.APR.2023 15:58:54

11G_Ant1_2437_30~1000

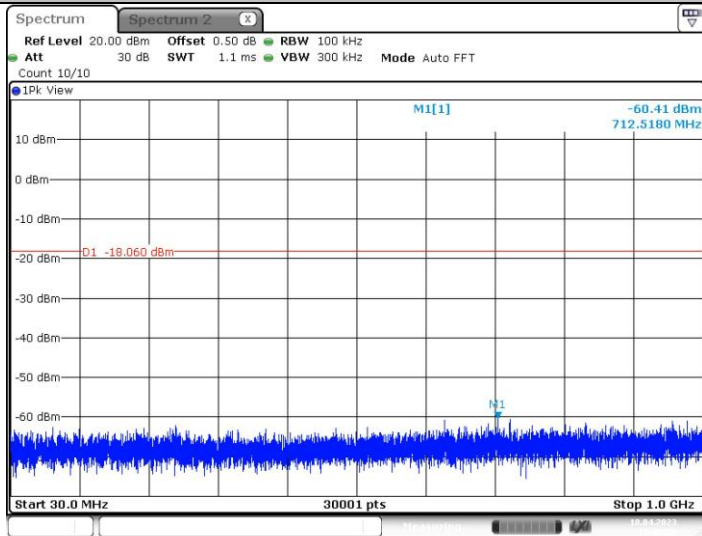

Date: 18.APR.2023 15:58:59

11G_Ant1_2437_1000~26500

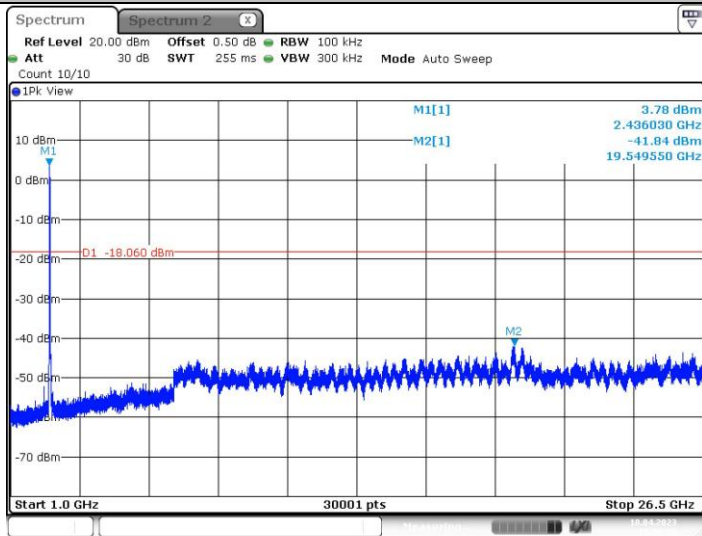

Date: 18.APR.2023 15:59:22

11G_Ant1_2462_0~Reference

CTC Laboratories, Inc.

1-2/F., Building 2, Jiaquan Building, Guanlan High-Tech Park, Shenzhen, Guangdong, China
 Tel.: (86)755-27521059 Fax: (86)755-27521011 Http://www.sz-ctc.org.cn



For anti-fake verification, please visit the official website of Certification and Accreditation Administration of the People's Republic of China : yz.cnca.cn

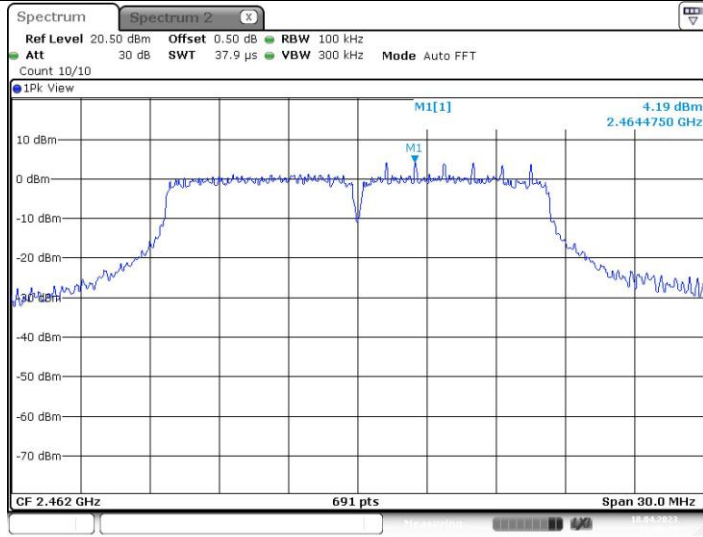

11G_Ant1_2462_30~1000

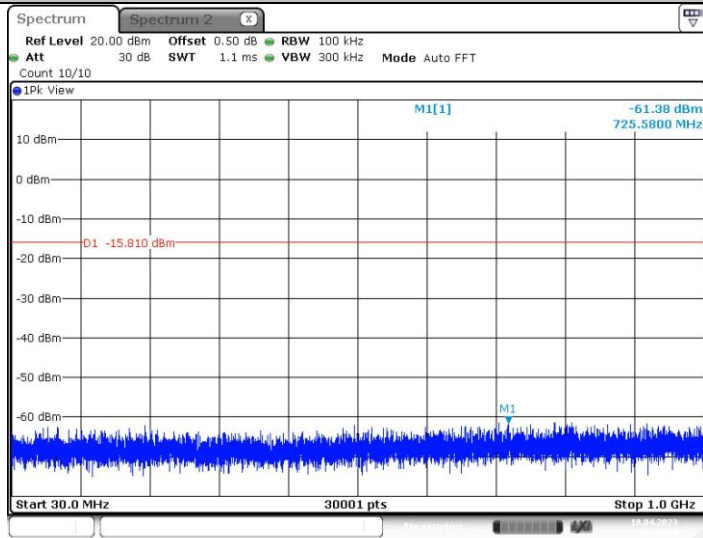

11G_Ant1_2462_1000~26500

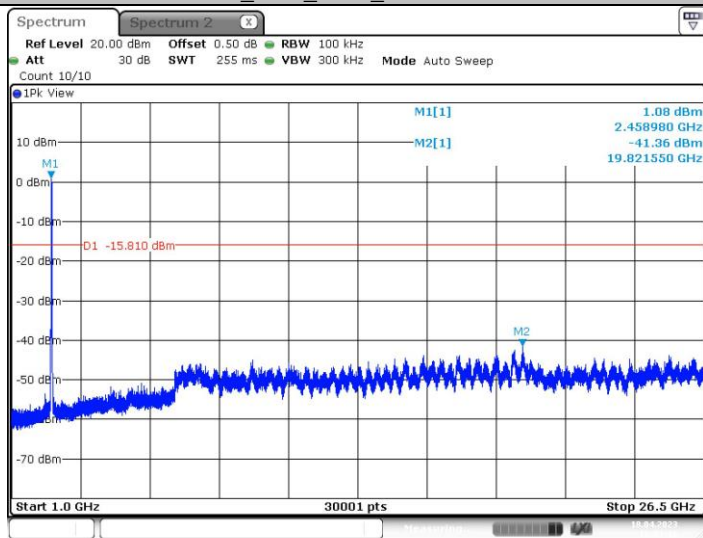

11N20SISO_Ant1_2412_0~Reference

CTC Laboratories, Inc.

1-2/F., Building 2, Jiaquan Building, Guanlan High-Tech Park, Shenzhen, Guangdong, China
Tel.: (86)755-27521059 Fax: (86)755-27521011 Http://www.sz-ctc.org.cn



For anti-fake verification, please visit the official website of Certification and Accreditation Administration of the People's Republic of China : yz.cnca.cn

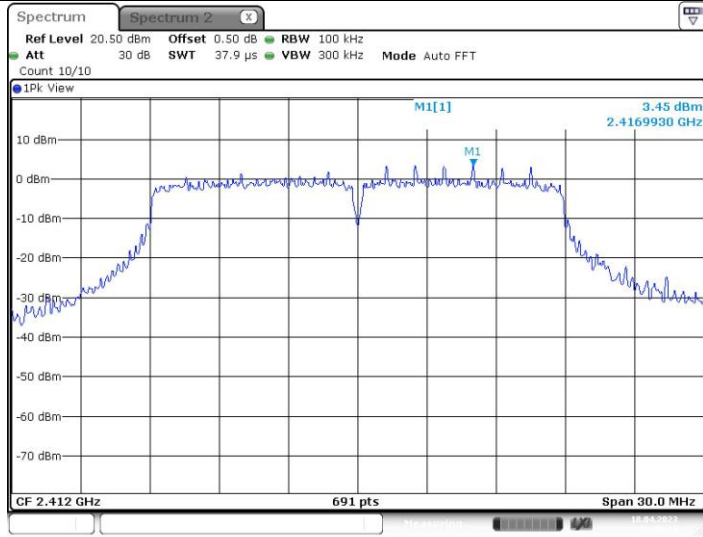

Date: 18.APR.2023 16:02:10

11N20SISO_Ant1_2412_30~1000

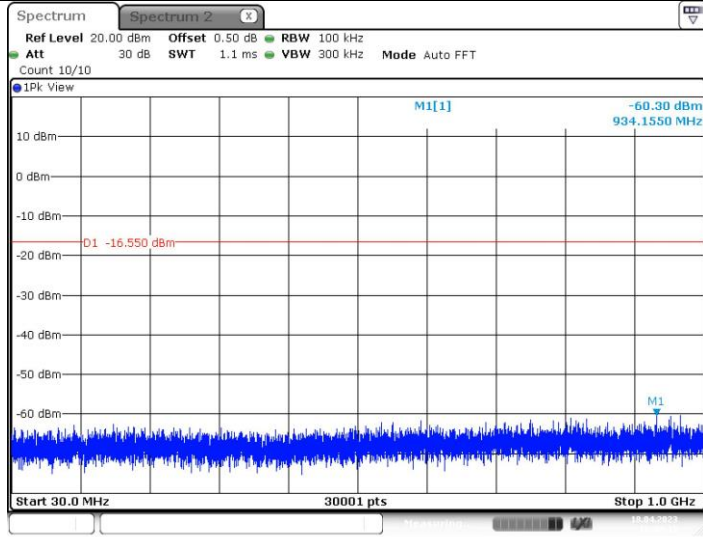

Date: 18.APR.2023 16:02:15

11N20SISO_Ant1_2412_1000~26500

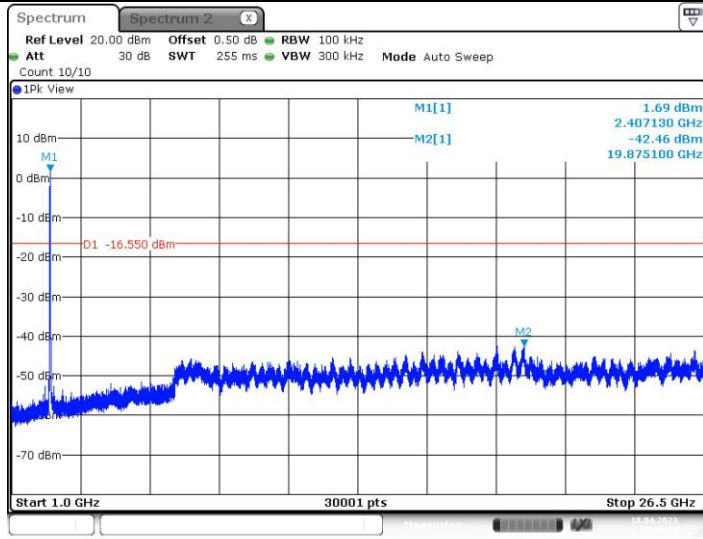

Date: 18.APR.2023 16:02:38

11N20SISO_Ant1_2437_0~Reference

CTC Laboratories, Inc.

1-2/F., Building 2, Jiaquan Building, Guanlan High-Tech Park, Shenzhen, Guangdong, China
 Tel.: (86)755-27521059 Fax: (86)755-27521011 Http://www.sz-ctc.org.cn



For anti-fake verification, please visit the official website of Certification and Accreditation Administration of the People's Republic of China : yz.cnca.cn

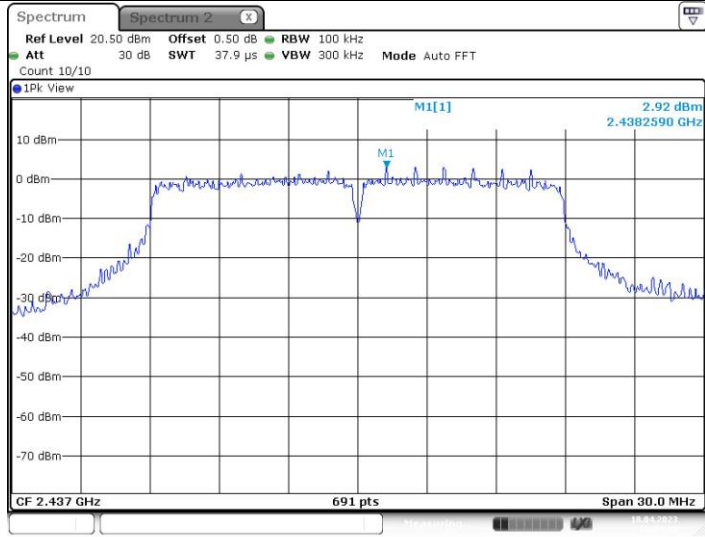

Date: 18.APR.2023 16:03:21

11N20SISO_Ant1_2437_30~1000

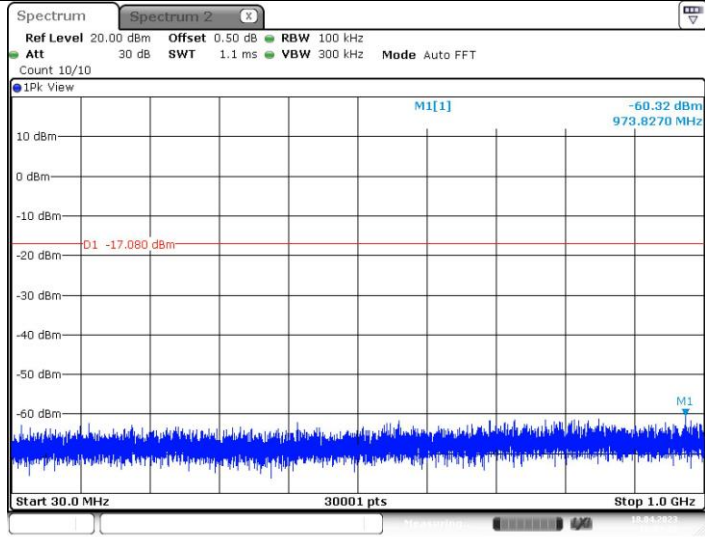

Date: 18.APR.2023 16:03:26

11N20SISO_Ant1_2437_1000~26500

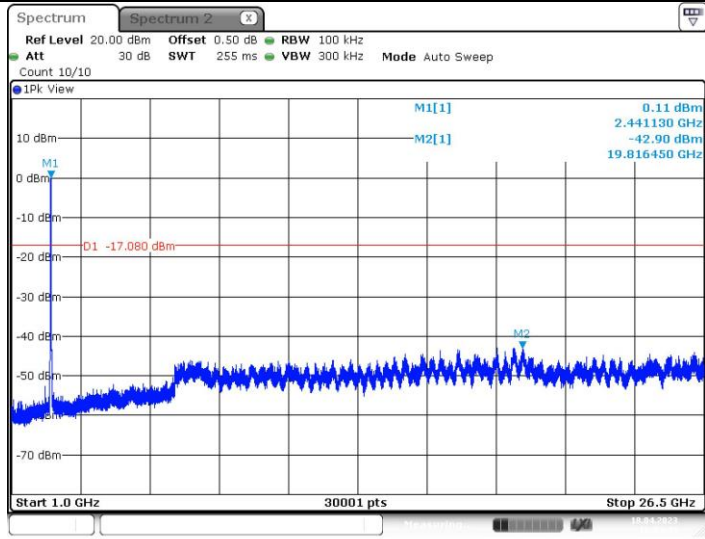

Date: 18.APR.2023 16:03:49

11N20SISO_Ant1_2462_0~Reference

CTC Laboratories, Inc.

1-2/F., Building 2, Jiaquan Building, Guanlan High-Tech Park, Shenzhen, Guangdong, China
 Tel.: (86)755-27521059 Fax: (86)755-27521011 Http://www.sz-ctc.org.cn



For anti-fake verification, please visit the official website of Certification and Accreditation Administration of the People's Republic of China : yz.cnca.cn

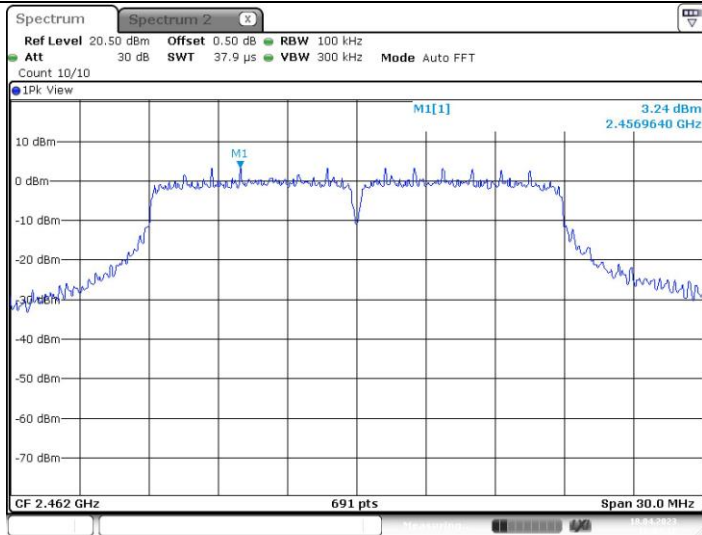

11N20SISO_Ant1_2462_30~1000

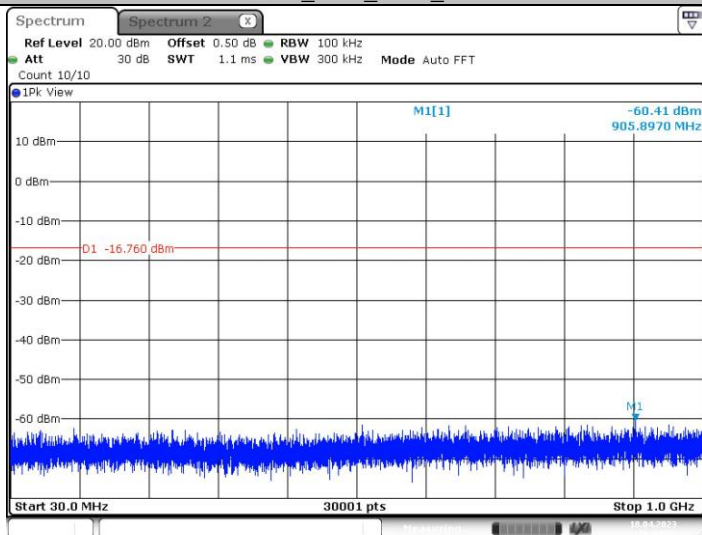

11N20SISO_Ant1_2462_1000~26500

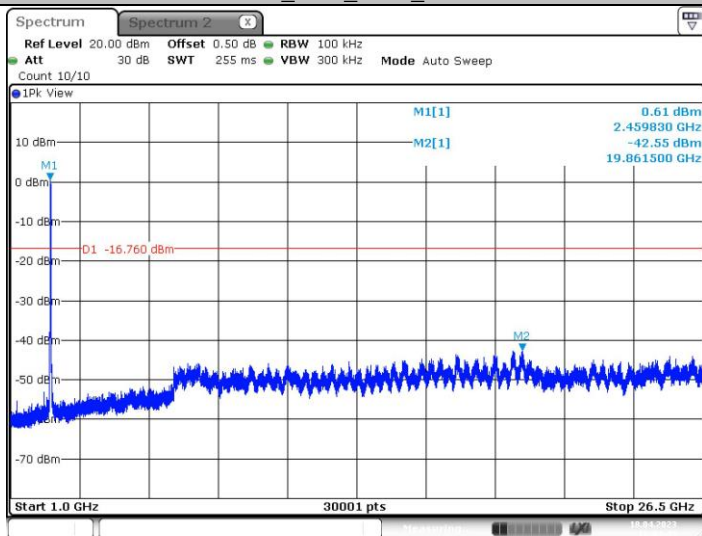

11N40SISO_Ant1_2422_0~Reference

CTC Laboratories, Inc.

1-2/F., Building 2, Jiaquan Building, Guanlan High-Tech Park, Shenzhen, Guangdong, China
 Tel.: (86)755-27521059 Fax: (86)755-27521011 Http://www.sz-ctc.org.cn



For anti-fake verification, please visit the official website of Certification and Accreditation Administration of the People's Republic of China : yz.cnca.cn

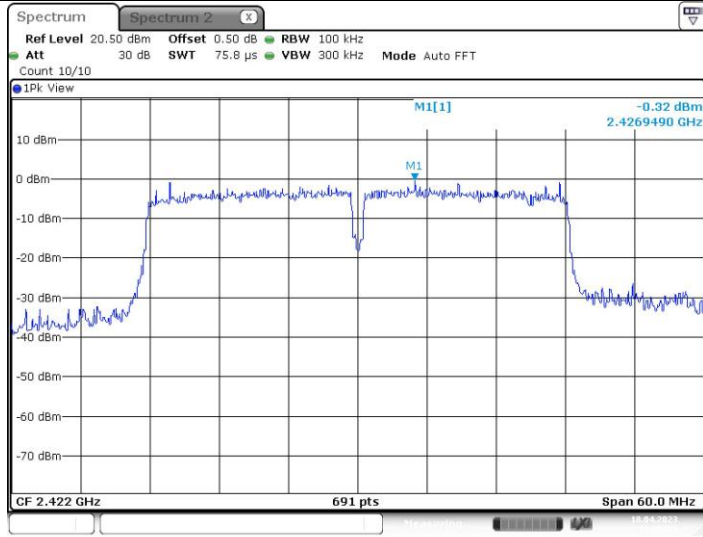

Date: 18.APR.2023 16:05:53

11N40SISO_Ant1_2422_30~1000

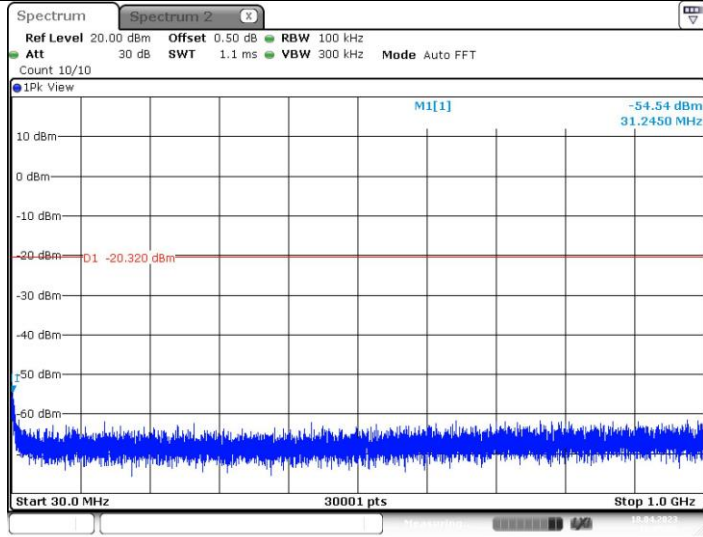

Date: 18.APR.2023 16:05:58

11N40SISO_Ant1_2422_1000~26500

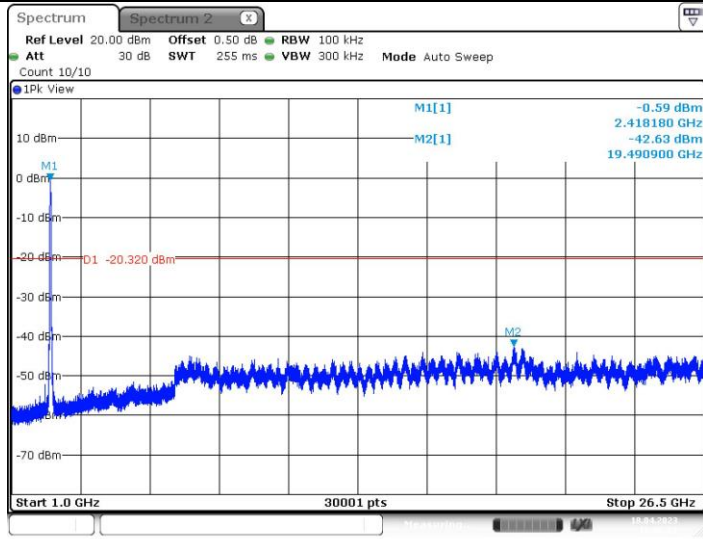

Date: 18.APR.2023 16:06:21

11N40SISO_Ant1_2437_0~Reference

CTC Laboratories, Inc.

1-2/F., Building 2, Jiaquan Building, Guanlan High-Tech Park, Shenzhen, Guangdong, China
Tel.: (86)755-27521059 Fax: (86)755-27521011 Http://www.sz-ctc.org.cn



For anti-fake verification, please visit the official website of Certification and Accreditation Administration of the People's Republic of China : yz.cnca.cn

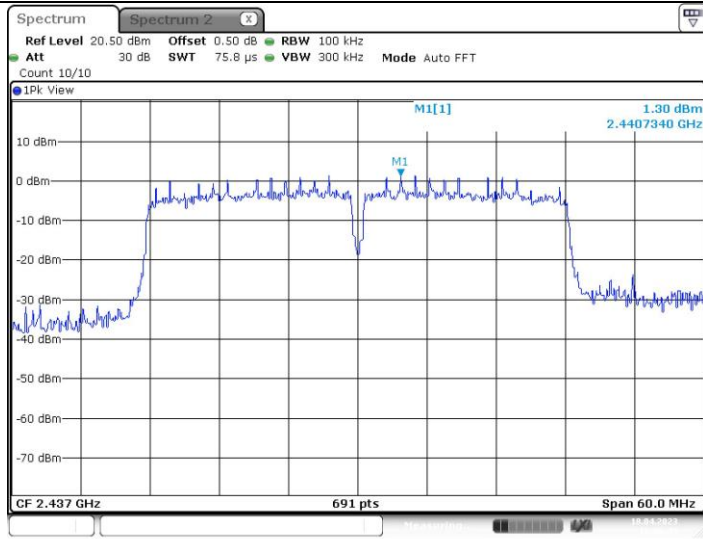

Date: 18.APR.2023 16:06:49

11N40SISO_Ant1_2437_30~1000

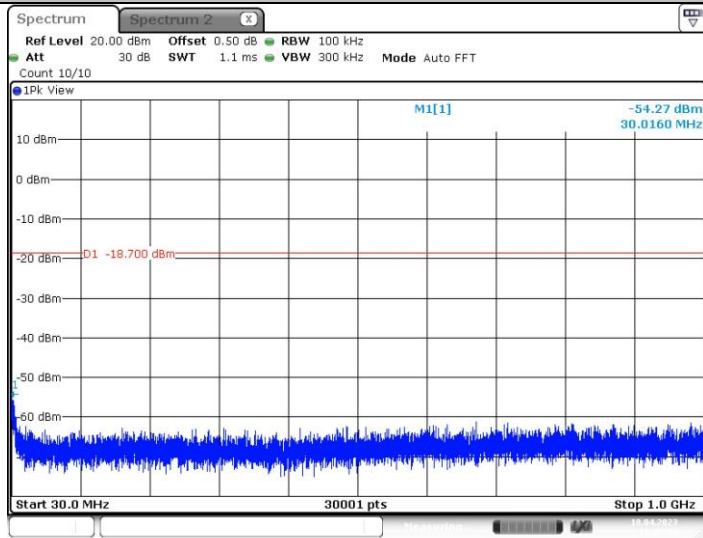

Date: 18.APR.2023 16:06:54

11N40SISO_Ant1_2437_1000~26500

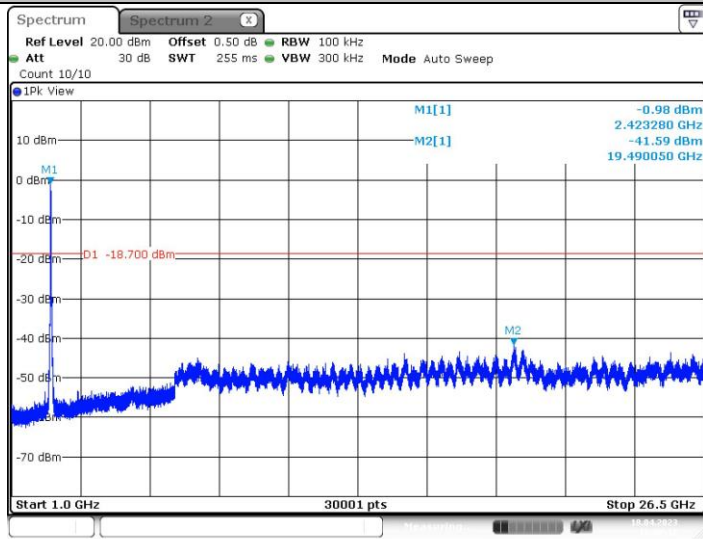

Date: 18.APR.2023 16:07:18

11N40SISO_Ant1_2452_0~Reference

CTC Laboratories, Inc.

1-2/F., Building 2, Jiaquan Building, Guanlan High-Tech Park, Shenzhen, Guangdong, China
 Tel.: (86)755-27521059 Fax: (86)755-27521011 Http://www.sz-ctc.org.cn



For anti-fake verification, please visit the official website of Certification and Accreditation Administration of the People's Republic of China : yz.cnca.cn

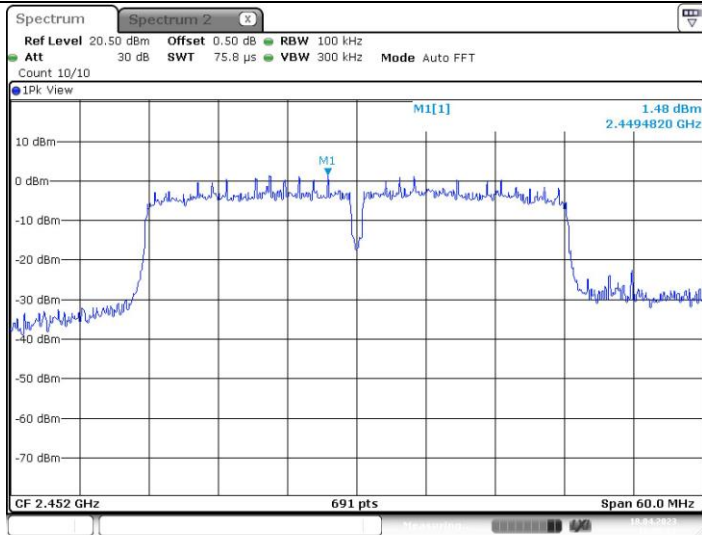

Date: 18.APR.2023 16:09:21

11N40SISO_Ant1_2452_30~1000

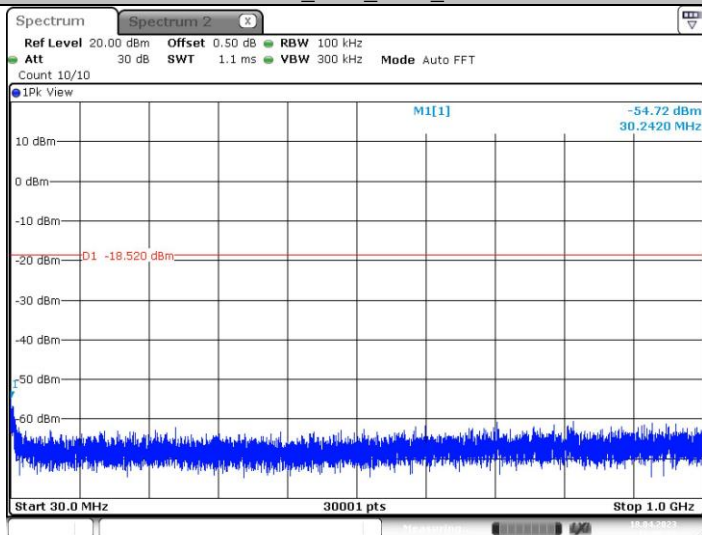

Date: 18.APR.2023 16:09:26

11N40SISO_Ant1_2452_1000~26500

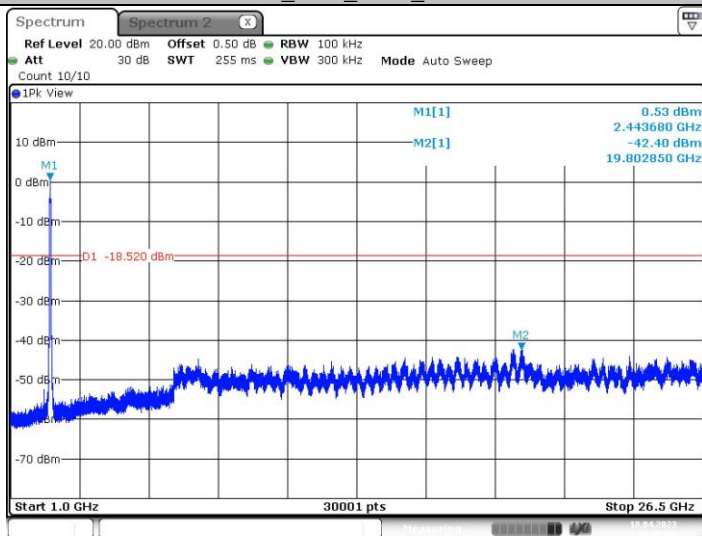

Date: 18.APR.2023 16:09:49

CTC Laboratories, Inc.

1-2/F., Building 2, Jiaquan Building, Guanlan High-Tech Park, Shenzhen, Guangdong, China
Tel.: (86)755-27521059 Fax: (86)755-27521011 Http://www.sz-ctc.org.cn



For anti-fake verification, please visit the official website of Certification and Accreditation Administration of the People's Republic of China : yz.cnca.cn