

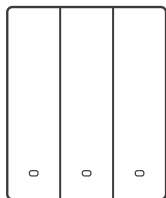

SwitchMan M5

User manual V1.0



80

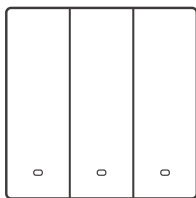

86

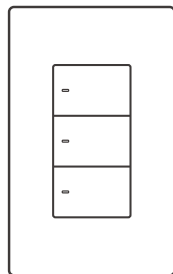

120

SwitchMan Smart Wall Switch

产品介绍

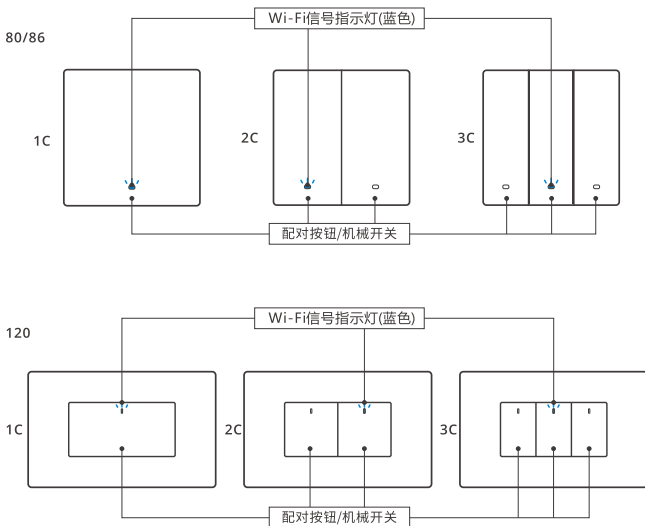

⚠ 设备重量 < 1Kg, 建议安装高度 < 2米。

Wi-Fi信号指示灯状态说明

指示灯状态	状态描述
两短一长闪烁	蓝牙配网模式
快速闪烁	兼容配网模式
常亮	设备在线
快闪一下	未连接路由器
快闪二下	已连接上路由器, 但未连接到云端
快闪三下	固件升级中

功能特点

本设备为一款智能墙壁机械开关,通过在易微联App端配网成功后,可用您的智能手机实现远程控制该设备的开/关,设置定时开/关、分享给您的家人一起控制等等。



远程控制



智能定时/延时



语音控制



分享功能



智能场景



点动功能



添加摄像头



群组功能



操作记录



局域网功能

使用说明

1. 断电

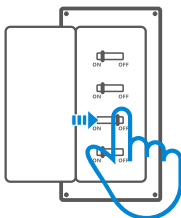

⚠ 设备安装、故障维修请由专业资质电工操作。切勿在设备通电时进行接线操作或触碰到接线端子,以免发生触电危险!

2. 接线

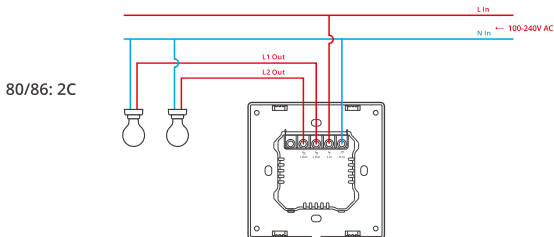

120: 3C

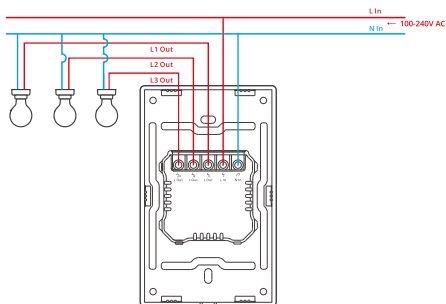

⚠ 确保线路接入无误。

3. 下载“易微联”App



Android™ & iOS

4. 上电

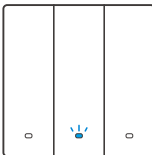

通电后，设备首次使用，默认进入蓝牙配网模式。Wi-Fi指示灯呈“两短一长闪烁”。

- ⓘ 三分钟内没有进行配网,设备将退出蓝牙配网模式。如需再次进入,长按任意配对按钮5秒直到Wi-Fi指示灯呈两短一长闪烁即可。

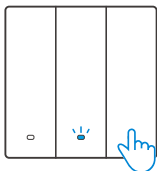

5. 添加设备

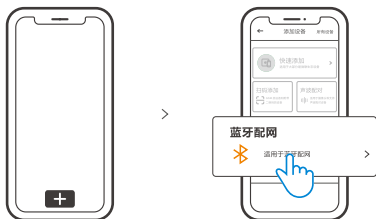

点击“+”,选择“蓝牙配网”,再根据App提示进行操作。

兼容配网模式

如使用蓝牙配网模式配网失败,请使用“兼容模式”进行配对。

- ① 长按任意配对按钮5秒直到Wi-Fi信号指示灯呈“两短一长闪烁”状态,松开。再次长按任意配对按钮5秒直到Wi-Fi信号指示灯呈“快闪”状态,此时设备进入兼容模式。
- ② 在易微联App界面,点击“+”,选择“兼容模式”。
输入Wi-Fi密码,点击“下一步”再点击“去连接”,将移动设备连接上Wi-Fi账号为:ITEAD-*****,密码为:12345678,然后回到“易微联”App,点击“下一步”,等待配对完成。

产品参数

型号	M5-1C-80, M5-2C-80, M5-3C-80 M5-1C-86, M5-2C-86, M5-3C-86 M5-1C-120, M5-2C-120, M5-3C-120
输入	1C: 100-240V ~ 50/60Hz 10A/总负载 2C: 100-240V ~ 50/60Hz 10A/总负载 3C: 100-240V ~ 50/60Hz 6A/总负载
输出	1C: 100-240V ~ 50/60Hz 10A/总负载 2C: 100-240V ~ 50/60Hz 5A/通道 10A/总负载 3C: 100-240V ~ 50/60Hz 2A/通道 6A/总负载
最大负载	1C: 2200W 2C: 2200W(1-1100W/通道) 3C: 1320W(1-440W/通道)
LED负载	1C: 300W/220V, 150W/110V 2C: 300W/220V/通道, 150W/110V/通道 3C: 100W/220V/通道, 600W/110V/通道
Wi-Fi	IEEE 802.11 b/g/n 2.4GHz
蓝牙标准	4.2 BLE
App支持系统	Android & iOS
工作温度	-10°C~40°C
外壳材料	PC V0
产品规格	80: 86x71x41.5mm 86: 86x86x41.5mm 120: 120x74x41.5mm

恢复出厂设置

在eWeLink app端“删除设备”，设备即恢复出厂设置。

常见问题

Wi-Fi设备与易微联APP配对失败

1. 确保设备进入配对模式。

三分钟内设备没有配对成功，则自动退出配对模式。

2. 请开启定位模式以及允许获取定位权限。

配网前，请先开启手机的定位服务并允许获取定位权限，位置信息权限用于获取Wi-Fi列表信息。如果“禁用”手机定位服务，设备将无法添加。

3. 确保Wi-Fi运行在2.4GHz频段。

4. 确保正确输入Wi-Fi网络名称和密码，且没有包含特殊字符。

密码错误是常见的配对失败原因。

5. 配对时为了确保良好的信号传输，请将设备靠近路由器。

6. 请尝试在兼容模式下进行配对。

Wi-Fi设备“离线”问题

请根据Wi-Fi LED指示灯状态检查以下问题：

LED灯每2秒闪烁一次，路由器连接失败。

1. 输入不正确的Wi-Fi网络名称和密码。

2. 确保你的Wi-Fi网络名称和密码没有包含特殊字符。例如，我们的系统无法识别希伯来语和阿拉伯语字符，导致Wi-Fi连接失败；

3. 路由器承载力较低。

4. Wi-Fi信号太弱。路由器和设备间隔太远，或者路由器与设备之前有障碍物导致信号无法传输。

5. 确保设备的MAC地址在MAC管理的白名单中。

LED指示灯连续闪烁两次，服务器连接失败

1. 确保网络连接正常。你可以通过手机或者电脑连接网络。如果连接失败，请检查网络。

2. 路由器承载力较低。连接到路由器的设备超过最大值。请查看你的路由器可以连接的最大设备数量。如果超过最大值，请删除个别设备或者更换一个承载力较高的路由器再次连接。

3. 请联系你的网络服务供应商以确认服务器地址没有被屏蔽：

cn-disp.coolkit.cc (中国大陆)

as-disp.coolkit.cc (除中国外亚洲地区)

eu-disp.coolkit.cc (欧洲)

us-disp.coolkit.cc (美国)

如果以上方法均无法解决此问题，请在易微联APP上通过“帮助&反馈”提交你的问题。

Product Introduction

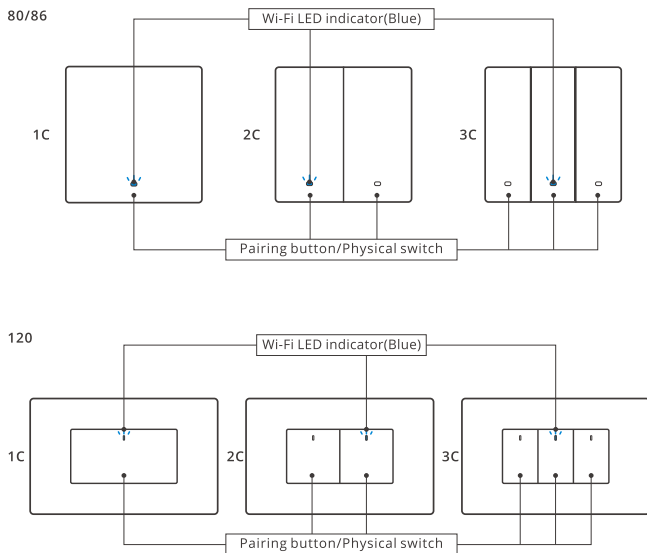

⚠ The device weight is less than 1 kg. The installation height of less than 2 m is recommended.

Wi-Fi LED indicator status instruction

Wi-Fi LED indicator status	Status instruction
Flashes (one long and two short)	Bluetooth Pairing Mode
Flashes quickly	Compatible Pairing Mode
Keeps on	Device is Online
Flashes quickly once	Fail to Connect to Router
Flashes quickly twice	Connected to Router but Fail to Connect to Serve
Flashes quickly three times	Firmware Updating

Features

This device is a smart physical wall switch. After pairing it with eWeLink App, you can turn on/off the connected devices via the smart phone wherever you are, schedule its on/off, share it with your families to control together, etc.



Remote Control

Single/Countdown
Timing

Voice Control



Share Control



Smart Scene



Inching Mode



Camera Linking



Group Control

History Operation
Record

LAN Control

Operating Instruction

1. Power off

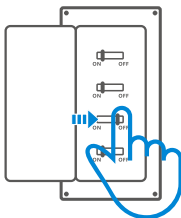

⚠ Please install and maintain the device by a professional electrician. To avoid electric shock hazard, do not operate any connection or contact the terminal connector while the device is powered on !

2. Wiring instruction

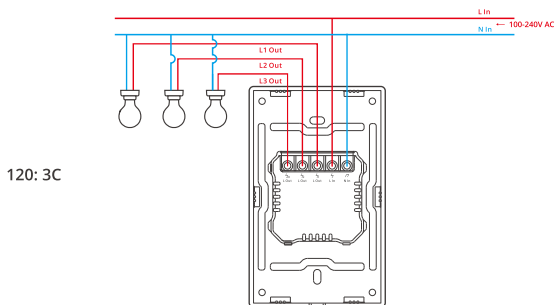
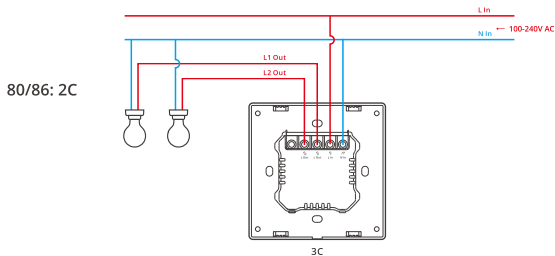

⚠ Make sure all wires are connected correctly.

3. Download the eWeLink App

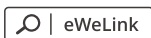

Android™ & iOS

4. Power on

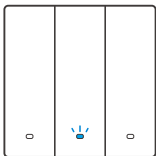

After powering on, the device will enter the Bluetooth Pairing Mode during the first use. The Wi-Fi LED indicator changes in a cycle of two short and one long flash and release.

- ⓘ The device will exit the Bluetooth Pairing Mode if not paired within 3mins. If you want to enter this mode, please long press any pairing button for about 5s until the Wi-Fi LED indicator changes in a cycle of two short and one long flash and release.

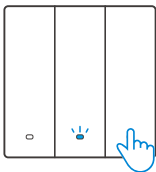

5. Add device



Tap "+" and select "Bluetooth Pairing", then operate following the prompt on the App.

Compatible Pairing Mode

If you fail to enter Bluetooth Pairing Mode, please try “Compatible Pairing Mode” to pair.

① Long press any Pairing button for 5s until the Wi-Fi LED indicator changes in a cycle of two short flashes and one long flash and release. Long press any Pairing button for 5s again until the Wi-Fi LED indicator flashes quickly. Then, the device enters Compatible Pairing Mode.

② Tap “+” and select “Compatible Pairing Mode” on App.

Enter Wi-Fi password, tap “Next” and then “Connect”. Select Wi-Fi SSID with ITEAD-***** and enter the password 12345678, and then go back to eWeLink app and tap “Next”. Be patient until pairing completes.

Specifications

Model	M5-1C-80, M5-2C-80, M5-3C-80 M5-1C-86, M5-2C-86, M5-3C-86 M5-1C-120, M5-2C-120, M5-3C-120
Input	1C: 100-240V ~ 50/60Hz 10A Max 2C: 100-240V ~ 50/60Hz 10A Max 3C: 100-240V ~ 50/60Hz 6A Max
Output	1C: 100-240V ~ 50/60Hz 10A Max 2C: 100-240V ~ 50/60Hz 5A/Gang 10A/Total Max 3C: 100-240V ~ 50/60Hz 2A/Gang 6A/Total Max
Max. load	1C: 2200W 2C: 2200W(1-1100W/Gang) 3C: 1320W(1-440W/Gang)
LED load	1C: 300W/220V, 150W/110V 2C: 300W/220V/Gang, 150W/110V/Gang 3C: 100W/220V/Gang, 600W/110V/Gang
Wi-Fi	IEEE 802.11 b/g/n 2.4GHz
Bluetooth Standard	4.2 BLE
App operating systems	Android & iOS
Working temperature	-10°C~40°C
Shell material	PC V0
Dimension	80: 86x71x41.5mm 86: 86x86x41.5mm 120: 120x74x41.5mm

Factory Reset

Deleting the device on the eWeLink App indicates you restore it to factory setting.

Common Problems

Fail to pair Wi-Fi devices with eWeLink APP

1. Make sure the device is in pairing mode.
The device will automatically exit the pairing mode if not paired within 3mins.
2. Please turn on the location service on your mobile phone and give the permission. Before choosing the Wi-Fi network, the location service should be turned on and the permission is given. Location information permission is used to obtain Wi-Fi list information. If you tap "Disable", the device will not be added.
3. Make sure your Wi-Fi network runs on the 2.4GHz band.
4. Make sure you entered a correct Wi-Fi SSID and password, no special characters contained. A wrong password is a very common reason for pairing failure.
5. You may get the device close to the router for a good signal transmission while pairing.
6. Please try to pair the device in the compatible mode.

Wi-Fi devices "Offline" issues

Please check the following issues by the Wi-Fi LED indicator status:

The LED indicator blinks once every 2s means you fail to connect to the router.

1. Maybe you entered a wrong Wi-Fi SSID and password.
2. Make sure your Wi-Fi SSID and password don't contain special characters, for example, the Hebrew, Arabic characters. Our system can't recognize these characters so that fail to connect to the Wi-Fi.
3. Maybe your router has a lower carrying capacity.
4. Maybe the Wi-Fi signal strength is weak. Your router is too far away from your device, or there may be some obstacles between the router and the device so that the signal transmission is blocked.
5. Be sure that the MAC of the device is not on the blacklist of your MAC management.

The LED indicator flashes twice on repeated means you fail to connect to the server.

1. Make sure the Internet connection is normal. You can use your phone or PC to connect to the Internet, and if you fail to access, please check the availability of the Internet connection.
2. Maybe your router has a low carrying capacity. The number of devices connected to the router exceeds its maximum value. Please check the maximum number of devices that your router can carry. If the number of connected devices exceeds the maximum value, please delete some devices or change a larger router and try again.
3. Please contact your ISP and confirm our server address is not shielded:
cn-disp.coolkit.cc (China Mainland)
as-disp.coolkit.cc (in Asia except China)
eu-disp.coolkit.cc (in EU)
us-disp.coolkit.cc (in US)

If none of the above methods solved this problem, please submit your issue via help & feedback on the eWeLink App.

FCC Warning

Changes or modifications not expressly approved by the party responsible for compliance could avoid the user's authority to operate the equipment.

This device complies with part 15 of the FCC Rules. Operation is subject to the following two conditions: (1) This device may not cause harmful interference, and (2) this device must accept any interference received, including interference that may cause undesired operation.

FCC Radiation Exposure Statement:

This equipment complies with FCC radiation exposure limits set forth for an uncontrolled environment. This equipment should be installed and operated with minimum distance 20cm between the radiator & your body. This transmitter must not be co-located or operating in conjunction with any other antenna or transmitter.

Note:

This equipment has been tested and found to comply with the limits for a Class B digital device, pursuant to part 15 of the FCC Rules. These limits are designed to provide reasonable protection against harmful interference in a residential installation. This equipment generates, uses and can radiate radio frequency energy and, if not installed and used in accordance with the instructions, may cause harmful interference to radio communications. However, there is no guarantee that interference will not occur in a particular installation. If this equipment does cause harmful interference to radio or television reception, which can be determined by turning the equipment off and on, the user is encouraged to try to correct the interference by one or more of the following measures:

- Reorient or relocate the receiving antenna.
- Increase the separation between the equipment and receiver.
- Connect the equipment into an outlet on a circuit different from that to which the receiver is connected.
- Consult the dealer or an experienced radio/TV technician for help.

Hereby, Shenzhen Sonoff Technologies Co., Ltd. declares that the radio equipment type M5-1C-80, M5-2C-80, M5-3C-80, M5-1C-86, M5-2C-86, M5-3C-86, M5-1C-120, M5-2C-120, M5-3C-120 are in compliance with Directive 2014/53/EU. The full text of the EU declaration of conformity is available at the following internet address:

<https://sonoff.tech/usermanuals>

The logo features the word "SONOFF" in a bold, black, sans-serif font. Above the letter "O" are three curved lines representing radio signal waves.

Shenzhen Sonoff Technologies Co., Ltd.

MADE IN CHINA

