

SONOFF

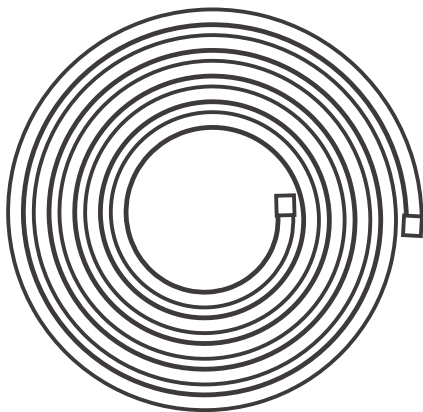

LBS L2/L2 Lite

User manual V1.0



Wi-Fi Smart LED RGB Light Strip

使用说明

1. 清理安装表面

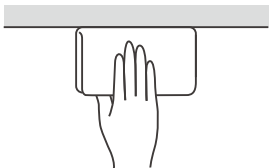

2. 撕开背部胶纸

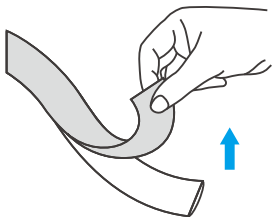

3. 将灯带粘贴在安装表面

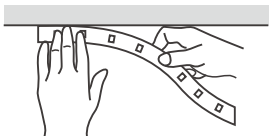

4. 下载“易微联”App

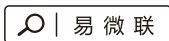

Android™ & iOS

5. 上电

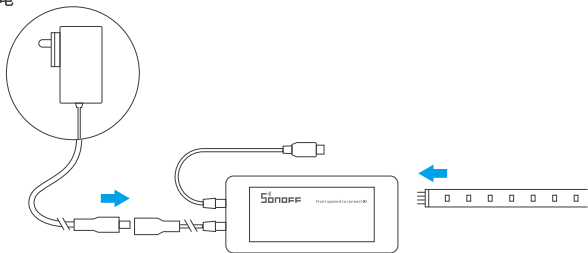

⊕ 每100mm可剪切

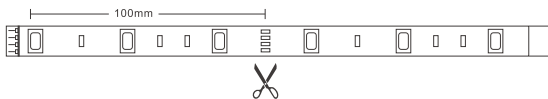

6. 取下遥控器电池绝缘片, 长按“on”按键5秒直至灯带呈“闪烁”状态, 设备进入蓝牙配网模式。

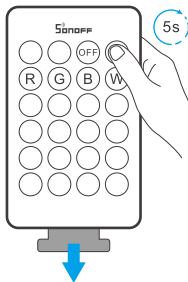

⊕ 一分钟内没有进行配网, 设备将退出蓝牙配网模式。如需再次进入, 长按遥控器“on”按键5秒直至灯带呈“闪烁”状态即可。

7. 添加设备



点击“+”，选择“蓝牙配网”，再根据 App 提示进行操作。

产品参数

产品型号: L2-2M, L2-5M, L2 Lite-5M-EU, L2 Lite-5M-US

灯带

输入电压	DC 12V	灯珠数量	30LEDs/m
光通量	≥300lumens/m	寿命	> 25000 小时
发光角度	L2: 140° L2 Lite: 120°	工作温度	-15°C ~ 50°C
工作湿度	≤95%	防护等级	L2: IP65 L2 Lite: IP20
材质	FPCB		
光衰	持续工作1000小时后就只有不到3% 的亮度		

电源适配器

输入	100-240V AC 50/60Hz 0.6A Max	输出	DC 12V 2000mA
保护	过压、过载、过温		

控制器

输入	DC 5-12V	最大功率	36W
遥控器	24键红外发射	Wi-Fi	IEEE 802.11 b 2.4GHz
遥控器电池	3V(CR2025)	蓝牙	5.0 BLE
支持平台	Android & iOS		

产品特点

- 采用SMD5050 LED灯珠，FPCB线路板，每三个LED为一段
- 发光颜色：主要为红光/蓝光/绿光



手机控制



语音控制



智能定时/延时



分享功能



亮度调节



光随乐动



1600万种颜色



遥控器控制



蓝牙控制



情景模式

Wi-Fi 控制设置

在 eWeLink App 设备设置界面选择“Wi-Fi设置”进行添加和更换网络。

⚠ 当设备断开Wi-Fi连接时，设备将切换为蓝牙控制(手机蓝牙必须为打开状态)。

恢复出厂设置

在eWeLink App端“删除设备”，设备即恢复出厂设置。

安全注意事项

1. 使用前先确认电压是否符合本产品的工作电压，使用不适当的电压可能会损坏产品并带来安全隐患；
2. LED光源不可更换，请勿私自拆产品；
3. 灯带在工作中会产生热量，请保存周围空气对流，以便散热。

Operation instruction

1. Clean the surface

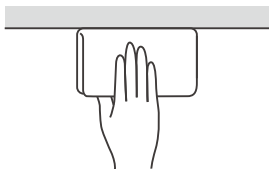

2. Tear the backing tape

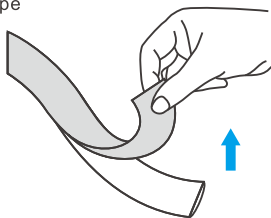

3. Adhere it to the surface

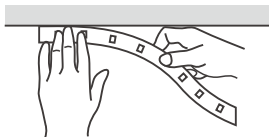

4. Download the eWeLink App

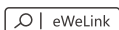

5. Power on

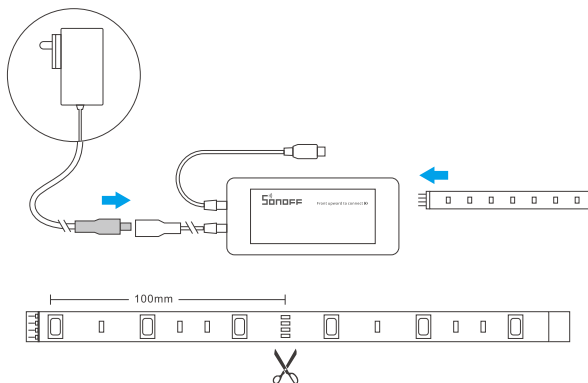

ⓘ Cuttable every 100mm

6. Pull out the insulation sheet, then long press “on” button for 5s until the light strip “flashes”, which means it enters the Bluetooth Pairing mode.

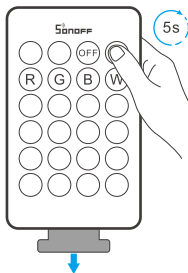

ⓘ The device will exit the Bluetooth Pairing mode if not paired within 1min. If you want to enter this mode again, long press the “on” button on the remote controller for 5s until the light strip “flashes” and release.

7. Add the device

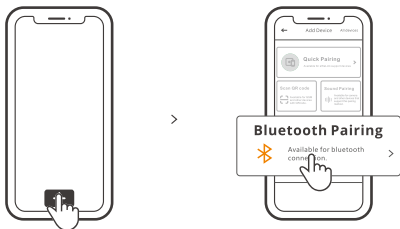

Tap "+" and select "Bluetooth Pairing", then operate following the prompt on the App.

Specifications

Model: L1-2M, L1-5M, L1 Lite-5M-EU, L1 Lite-5M-US

Light Strips

Input Voltage	DC 12V	LED QTY	30LEDs/m
Luminous Flux	≥300lumens/m	Life Expectancy	> 25000 hours
Beam Angle	L1: 140° L1 Lite: 120°	Operating Temperature	-15°C ~ 50°C
Working Humidity	≤95%	Protect Range	L1: IP65 L1 Lite: IP20
Material	FPCB		
Light Decay	Less than 3% after 1000 hours constant work		

Power Adapter

Input	100-240V AC 50/60Hz 0.6A Max	Output	DC 12V 2000mA
Protection	Anti-overvoltage, Anti-overload, Anti-temperature		

Wi-Fi Controller

Input	DC 5-12V	Power.max	36W
Remote Control	24 Keys IR Remote Controller	Wi-Fi	IEEE 802.11 b 2.4GHz
Remote controller battery	3V(CR2025)	Bluetooth	5.0 BLE
Operating systems	Android & iOS		

Features of the Smart LED Light Strip

- SMD5050 LED Beads; FPCB Circuit Board; Every 3 LED lights in one segment.
- Main Colors of the Light: Red/Blue/Green.



App Control



Voice Control

Single/Countdown
Timing

Share Control



Dimming

Music Reactive
Mode

16M Colors



Remote Control



Bluetooth Control



Scene Mode

Wi-Fi control setting

Select the "Wi-Fi Settings" on the "Device Settings" interface in the eWeLink App to add or change the network.

- ⓘ When Wi-Fi is not available, the device will automatically switch into Bluetooth control (Ensure Bluetooth is enable on your mobile phone).

Factory Reset

Deleting the device on the eWeLink app indicates you restore it to factory setting.

Safety Warning

1. Before using this product, please make sure that your voltage is appropriate for this product's working voltage. Using this product with a voltage other than the one specified may damage the product and cause safety hazards.
2. LED Light Sources are unchangeable, please don't dismantle them.
3. While the Light Strip is working, it will generate heat so please keep it in a cross-ventilation environment for heat dissipation.

FCC Warning

Changes or modifications not expressly approved by the party responsible for compliance could avoid the user's authority to operate the equipment.

This device complies with part 15 of the FCC Rules. Operation is subject to the following two conditions: (1) This device may not cause harmful interference, and (2) this device must accept any interference received, including interference that may cause undesired operation.

FCC Radiation Exposure Statement:

This equipment complies with FCC radiation exposure limits set forth for an uncontrolled environment. This equipment should be installed and operated with minimum distance 20cm between the radiator & your body. This transmitter must not be co-located or operating in conjunction with any other antenna or transmitter.

Note:

This equipment has been tested and found to comply with the limits for a Class B digital device, pursuant to part 15 of the FCC Rules. These limits are designed to provide reasonable protection against harmful interference in a residential installation. This equipment generates, uses and can radiate radio frequency energy and, if not installed and used in accordance with the instructions, may cause harmful interference to radio communications. However, there is no guarantee that interference will not occur in a particular installation. If this equipment does cause harmful interference to radio or television reception, which can be determined by turning the equipment off and on, the user is encouraged to try to correct the interference by one or more of the following measures:

- Reorient or relocate the receiving antenna.
- Increase the separation between the equipment and receiver.
- Connect the equipment into an outlet on a circuit different from that to which the receiver is connected.
- Consult the dealer or an experienced radio/TV technician for help.

Hereby, Shenzhen Sonoff Technologies Co., Ltd. declares that the radio equipment type L1-2M, L1-5M, L1 Lite-5M-US, L1 Lite-5M-EU are in compliance with Directive 2014/53/EU. The full text of the EU declaration of conformity is available at the following internet address:

<https://sonoff.tech/usermanuals>



Shenzhen Sonoff Technologies Co., Ltd.

1001, BLDG8, Lianhua Industrial Park, shenzhen, GD, China
ZIP code: 518000 Website: sonoff.tech

MADE IN CHINA



RoHS

