



CTC Laboratories, Inc.

2/F., Building 1 and 1-2/F., Building 2, Jiaquan Building, Guanlan High-Tech Park, Longhua District, Shenzhen, Guangdong, China

Tel: +86-755-27521059 Fax: +86-755-27521011 <http://www.sz-ctc.org.cn>

TEST REPORT

Report No. : **CTC20231495E01**

FCC ID..... : **2APN5-T5**

IC : **29127-T5**

Applicant : **Shenzhen Sonoff Technologies Co.,Ltd.**

Address..... : 3F & 6F, Bldg A, No. 663, Bulong Rd, Shenzhen, Guangdong, China

Manufacturer..... : Shenzhen Sonoff Technologies Co.,Ltd.

Address..... : 3F & 6F, Bldg A, No. 663, Bulong Rd, Shenzhen, Guangdong, China

Product Name : **Smart Touch Wall Switch**

Trade Mark : Sonoff

Model/Type reference..... : T5-3C-120

Listed Model(s) : T5-2C-120, T5-1C-120



Standard : **FCC CFR Title 47 Part 15 Subpart C Section 15.247
RSS-247 Issue 2**

Date of receipt of test sample..... : Jul. 27, 2023

Date of testing..... : Jul. 27, 2023 to Aug. 20, 2023

Date of issue..... : Aug. 21, 2023

Result..... : **PASS**

Compiled by:		
(Printed name+signature)	Jim Jiang	
Supervised by:		
(Printed name+signature)	Eric Zhang	
Approved by:		
(Printed name+signature)	Totti Zhao	

This test report may be duplicated completely for legal use with the approval of the applicant. It should not be reproduced except in full, without the written approval of our laboratory. The client should not use it to claim product endorsement by CTC. The Test Result in the report only apply to the tested sample. The test report shall be invalid without all the signatures of testing engineers, reviewer and approver. Any objections must be raised to CTC within 15 days since the date when the report is received. It will not be taken into consideration beyond this limit. The test report merely corresponds to the test sample.



Table of Contents

Page

1. TEST SUMMARY 3

1.1. TEST STANDARDS..... 3

1.2. REPORT VERSION 3

1.3. TEST DESCRIPTION..... 3

1.4. TEST FACILITY 4

1.5. MEASUREMENT UNCERTAINTY 5

1.6. ENVIRONMENTAL CONDITIONS..... 5

2. GENERAL INFORMATION 6

2.1. CLIENT INFORMATION 6

2.2. GENERAL DESCRIPTION OF EUT 6

2.3. ACCESSORY EQUIPMENT INFORMATION 7

2.4. OPERATION STATE 8

2.5. MEASUREMENT INSTRUMENTS LIST 9

3. TEST ITEM AND RESULTS 10

3.1. CONDUCTED EMISSION..... 10

3.2. RADIATED EMISSION..... 13

3.3. BAND EDGE EMISSIONS (RADIATED) 21

3.4. BAND EDGE AND SPURIOUS EMISSIONS (CONDUCTED) 26

3.5. DTS BANDWIDTH..... 29

3.6. PEAK OUTPUT POWER 32

3.7. POWER SPECTRAL DENSITY 34

3.8. DUTY CYCLE 36

3.9. ANTENNA REQUIREMENT..... 39



1. TEST SUMMARY

1.1. Test Standards

The tests were performed according to following standards:

[FCC Rules Part 15.247](#): Operation within the bands 902–928MHz, 2400–2483.5MHz, and 5725–5850MHz.

[RSS-247 Issue 2](#): Digital Transmission Systems (DTSs), Frequency Hopping Systems (FHSs) and Licence-Exempt Local Area Network (LE-LAN) Devices.

[RSS-Gen Issue 5](#): General Requirements for Compliance of Radio Apparatus.

[ANSI C63.10-2013](#): American National Standard of Procedures for Compliance Testing of Unlicensed Wireless Devices.

1.2. Report Version

Revised No.	Date of issue	Description
01	Aug. 21, 2023	Original

1.3. Test Description

FCC Part 15 Subpart C (15.247) / RSS-247 Issue 2				
Test Item	Standard Section		Result	Test Engineer
	FCC	IC		
Antenna Requirement	15.203	RSS-Gen 6.8	Pass	Jim Jiang
Conducted Emission	15.207	RSS-Gen 8.8	Pass	Jim Jiang
Conducted Band Edge and Spurious Emissions	15.247(d)	RSS-247 5.5	Pass	Jim Jiang
Radiated Band Edge and Spurious Emissions	15.205&15.209&15.247(d)	RSS-247 5.5	Pass	Jim Jiang
6dB Bandwidth	15.247(a)(2)	RSS-247 5.2 (a)	Pass	Jim Jiang
Conducted Max Output Power	15.247(b)(3)	RSS-247 5.4 (d)	Pass	Jim Jiang
Power Spectral Density	15.247(e)	RSS-247 5.2 (b)	Pass	Jim Jiang
Transmitter Radiated Spurious	15.209&15.247(d)	RSS-247 5.5&RSS-Gen 8.9	Pass	Jim Jiang

Note:

- The measurement uncertainty is not included in the test result.
- N/A: means this test item is not applicable for this device according to the technology characteristic of device.



1.4. Test Facility

Address of the report laboratory

CTC Laboratories, Inc.

Add: 2/F., Building 1 and 1-2/F., Building 2, Jiaquan Building, Guanlan High-Tech Park, Longhua District, Shenzhen, Guangdong, China

Laboratory accreditation

The test facility is recognized, certified, or accredited by the following organizations:

A2LA-Lab Cert. No.: 4340.01

CTC Laboratories, Inc. EMC Laboratory has been accredited by A2LA for technical competence in the field of electrical testing, and proved to be in compliance with ISO/IEC 17025:2017 General Requirements for the Competence of Testing and Calibration Laboratories and any additional program requirements in the identified field of testing.

Industry Canada (Registration No.: 9783A, CAB Identifier: CN0029)

CTC Laboratories, Inc. EMC Laboratory has been registered by Certification and Engineer Bureau of Industry Canada for the performance of with Registration NO.: 9783A on Jan, 2016.

FCC (Registration No.: 951311, Designation Number CN1208)

CTC Laboratories, Inc. EMC Laboratory has been registered and fully described in a report filed with the (FCC) Federal Communications Commission. The acceptance letter from the FCC is maintained in our files. Registration 951311, Aug 26, 2017.



1.5. Measurement Uncertainty

The data and results referenced in this document are true and accurate. The reader is cautioned that there may be errors within the calibration limits of the equipment and facilities. The measurement uncertainty was calculated for all measurements listed in this test report acc. to TR-100028-01 “Electromagnetic compatibility and Radio spectrum Matters (ERM);Uncertainties in the measurement of mobile radio equipment characteristics; Part 1” and TR-100028-02 “Electromagnetic compatibility and Radio spectrum Matters (ERM); Uncertainties in the measurement of mobile radio equipment characteristics; Part 2” and is documented in the CTC Laboratories, Inc. quality system acc. to DIN EN ISO/IEC 17025. Furthermore, component and process variability of devices similar to that tested may result in additional deviation. The manufacturer has the sole responsibility of continued compliance of the device.

Below is the best measurement capability for CTC Laboratories, Inc.

Test Items	Measurement Uncertainty	Notes
DTS Bandwidth	±0.0196%	(1)
Maximum Conducted Output Power	±0.686 dB	(1)
Maximum Power Spectral Density Level	±0.743 dB	(1)
Band-edge Compliance	±1.328 dB	(1)
Unwanted Emissions In Non-restricted Freq Bands	9kHz-1GHz: ±0.746dB 1GHz-26GHz: ±1.328dB	(1)
Conducted Emissions 9kHz~30MHz	±3.08 dB	(1)
Radiated Emissions 30~1000MHz	±4.51 dB	(1)
Radiated Emissions 1~18GHz	±5.84 dB	(1)
Radiated Emissions 18~40GHz	±6.12 dB	(1)

Note (1): This uncertainty represents an expanded uncertainty expressed at approximately the 95% confidence level using a coverage factor of k=2.

1.6. Environmental Conditions

During the measurement the environmental conditions were within the listed ranges:

Temperature:	15 °C to 35 °C
Relative Humidity:	20 % to 75 %
Air Pressure:	101 kPa



2. GENERAL INFORMATION

2.1. Client Information

Applicant:	Shenzhen Sonoff Technologies Co.,Ltd.
Address:	3F & 6F, Bldg A, No. 663, Bulong Rd, Shenzhen, Guangdong, China
Manufacturer:	Shenzhen Sonoff Technologies Co.,Ltd.
Address:	3F & 6F, Bldg A, No. 663, Bulong Rd, Shenzhen, Guangdong, China

2.2. General Description of EUT

Product Name:	Smart Touch Wall Switch
Trade Mark:	Sonoff
Model/Type reference:	T5-3C-120
Listed Model(s):	T5-2C-120, T5-1C-120
Model Difference:	All these models are identical in the same PCB, layout, electrical circuit. The difference is the number of output terminal blocks and the number of relays. Model: T5-1C-120, the product contains one relay and three terminal blocks on power supply board, but the rest are the same. Model: T5-2C-120, the product contains two relays and four terminal blocks on power supply board, but the rest are the same. Model: T5-3C-120, the product contains three relays and five terminal blocks on power supply board, but the rest are the same.
Power Supply:	Input: 100-240V~ 50/60Hz Max 15A Output: 100-240V~ 50/60Hz Max 5A/Gang 15A/Total
Hardware Version:	V1.0.1
Software Version:	V1.2.0
Bluetooth 5.0 / BLE	
Modulation:	GFSK
Operation Frequency:	2402MHz~2480MHz
Channel Number:	40
Channel Separation:	2MHz
Data Rate:	1Mbps
Antenna Type:	FPC Antenna
Antenna Gain:	2.82dBi



2.3. Accessory Equipment Information

Equipment Information			
Name	Model	S/N	Manufacturer
Notebook	ThinkPad T460s	/	Lenovo
Cable Information			
Name	Shielded Type	Ferrite Core	Length
USB Cable	Unshielded	NO	150cm
Test Software Information			
Name	Version	/	/
EspRFTTestTool	v2.8	/	/



2.4. Operation State

Operation Frequency List: The EUT has been tested under typical operating condition. The Applicant provides communication tools software to control the EUT for staying in continuous transmitting and receiving mode for testing. BT BLE, 40 channels are provided to the EUT. Channels 00/19/39 were selected for testing.

Operation Frequency List:

Channel	Frequency (MHz)
00	2402
01	2404
:	:
18	2438
19	2440
20	2442
:	:
38	2478
39	2480

Note: The display in grey were the channel selected for testing.

Test Mode:

For RF test items:
The engineering test program was provided and enabled to make EUT continuous transmit.
For AC power line conducted emissions:
The EUT was set to connect with the Bluetooth instrument under large package sizes transmission.
For Radiated spurious emissions test item:
The engineering test program was provided and enabled to make EUT continuous transmit. The EUT in each of three orthogonal axis emissions had been tested, but only the worst case (X axis) data recorded in the report.

The worse case configurations:

The Worse Case Power Setting Parameter under 2400 ~ 2483.5MHz Band		
Test Software	EspRFTTestTool_v2.8	
Modulation Mode	Test Channel	Power Level
GFSK	00	5
	19	5
	39	5



2.5. Measurement Instruments List

Tonscend RF Test System					
Item	Test Equipment	Manufacturer	Model No.	Serial No.	Calibrated Until
1	MXA Signal Analyzer	Keysight	N9020A	MY46471737	Dec. 16, 2023
2	Spectrum Analyzer	R&S	FSU26	100105	Dec. 16, 2023
3	Spectrum Analyzer	R&S	FSV40-N	101331	Mar. 14, 2024
4	MXG Vector Signal Generator	Agilent	N5182A	MY47420864	Dec. 16, 2023
5	PSG Analog Signal Generator	Agilent	E8257D	MY46521908	Dec. 16, 2023
6	Power Sensor	Keysight	U2021XA	MY55130004	Mar. 14, 2024
7	Power Sensor	Keysight	U2021XA	MY55130006	Mar. 14, 2024
8	Wideband Radio Communication Tester	R&S	CMW500	102414	Dec. 16, 2023
9	High and low temperature box	ESPEC	MT3035	/	Mar. 24, 2024
10	JS1120 RF Test System	TONSCEND	v2.6	/	/

Radiated Emission (3m chamber 2)					
Item	Test Equipment	Manufacturer	Model No.	Serial No.	Calibrated Until
1	Trilog-Broadband Antenna	Schwarzbeck	VULB 9168	9168-1013	Dec. 07, 2024
2	Horn Antenna	Schwarzbeck	BBHA 9120D	9120D-648	Dec. 07, 2024
3	Spectrum Analyzer	R&S	FSU26	100105	Dec. 16, 2023
4	Spectrum Analyzer	R&S	FSV40-N	101331	Mar. 14, 2024
5	Pre-Amplifier	SONOMA	310	186194	Dec. 16, 2023
6	Low Noise Pre-Amplifier	EMCI	EMC051835	980075	Dec. 16, 2023
7	Test Receiver	R&S	ESC17	100967	Dec. 16, 2023
8	3m chamber 2	Frankonia	EE025	/	Oct. 23, 2024

Conducted Emission					
Item	Test Equipment	Manufacturer	Model No.	Serial No.	Calibrated Until
1	LISN	R&S	ENV216	101112	Dec. 16, 2023
2	LISN	R&S	ENV216	101113	Dec. 16, 2023
3	EMI Test Receiver	R&S	ESCS30	100353	Dec. 16, 2023
4	ISN CAT6	Schwarzbeck	NTFM 8158	CAT6-8158-0046	Dec. 16, 2023
5	ISN CAT5	Schwarzbeck	NTFM 8158	CAT5-8158-0046	Dec. 16, 2023

Note: 1. The Cal. Interval was one year.

2. The Cal. Interval was three years of the antenna.

3. The cable loss has been calculated in test result which connection between each test instruments.

3. TEST ITEM AND RESULTS

3.1. Conducted Emission

Limit

FCC CFR Title 47 Part 15 Subpart C Section 15.207 / RSS-Gen 8.8

Frequency (MHz)	Conducted Limit (dBμV)	
	Quasi-peak	Average
0.15 - 0.5	66 to 56 *	56 to 46 *
0.5 - 5	56	46
5 - 30	60	50

* Decreases with the logarithm of the frequency.

Test Configuration

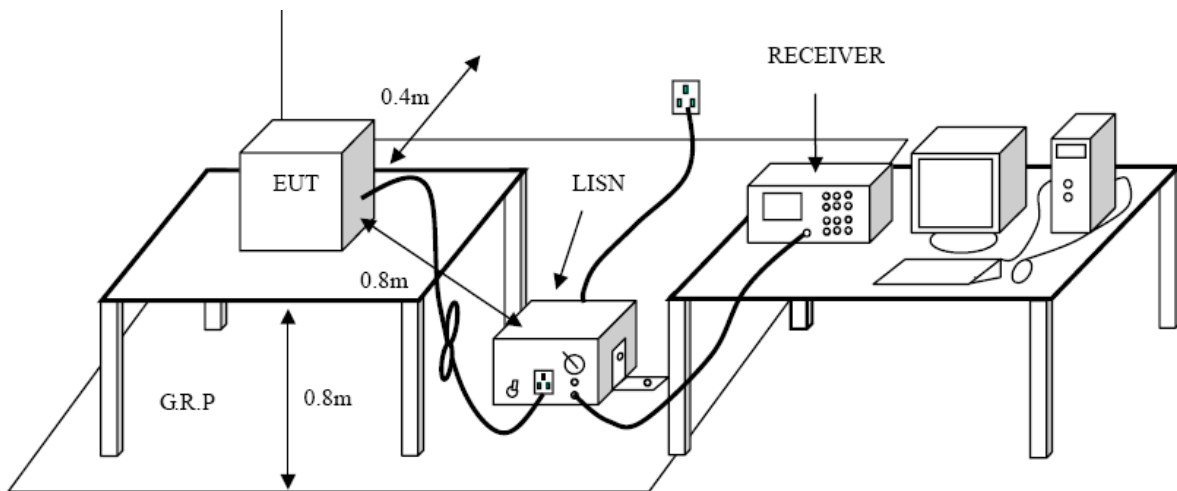

Test Procedure

1. The EUT was setup according to ANSI C63.10:2013 requirements.
2. The EUT was placed on a platform of nominal size, 1 m by 1.5 m, raised 80 cm above the conducting ground plane. The vertical conducting plane was located 40 cm to the rear of the EUT. All other surfaces of EUT were at least 80 cm from any other grounded conducting surface.
3. The EUT and simulators are connected to the main power through a line impedance stabilization network (LISN). The LISN provides a 50 ohm / 50 μH coupling impedance for the measuring equipment.
4. The peripheral devices are also connected to the main power through a LISN. (Please refer to the block diagram of the test setup and photographs)
5. Each current-carrying conductor of the EUT power cord, except the ground (safety) conductor, was individually connected through a LISN to the input power source.
6. The excess length of the power cord between the EUT and the LISN receptacle were folded back and forth at the center of the lead to form a bundle not exceeding 40 cm in length.
7. Conducted emissions were investigated over the frequency range from 0.15MHz to 30MHz using a receiver bandwidth of 9 kHz.
8. During the above scans, the emissions were maximized by cable manipulation.

Test Mode

Please refer to the clause 2.4.



Test Result

Test Voltage:	AC 120V/60Hz
Terminal:	Line
Remark:	Only worse case is reported

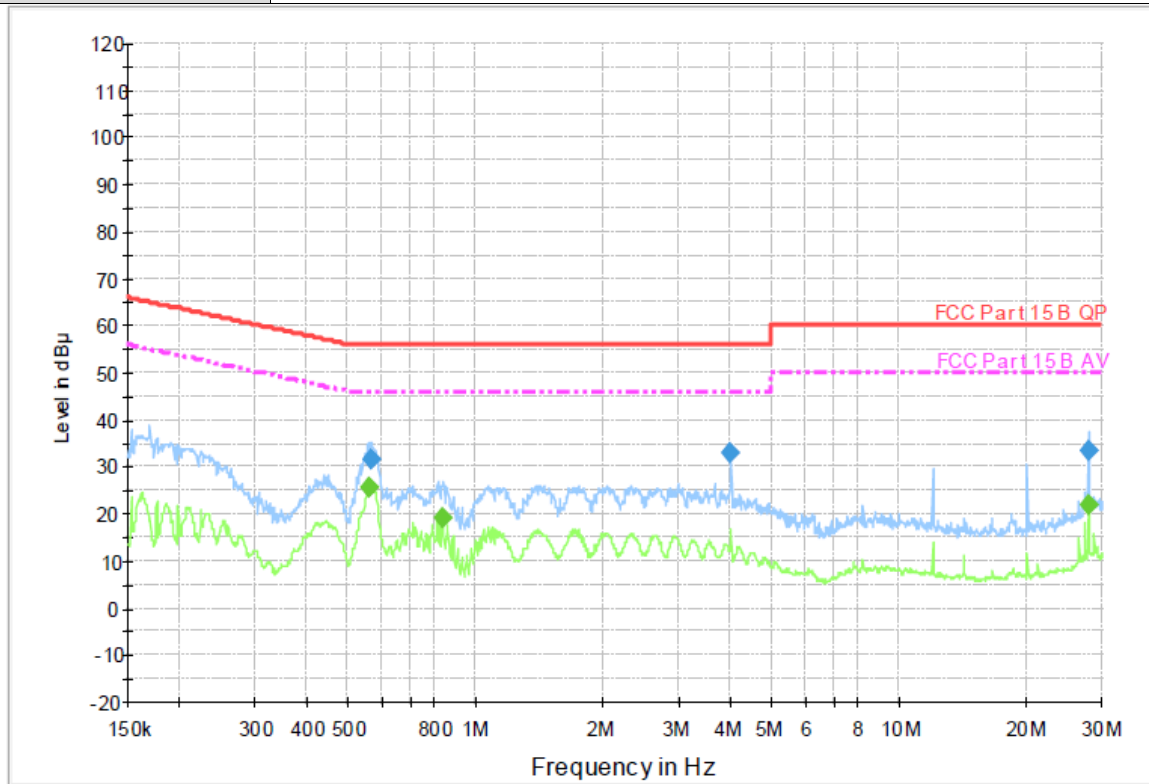

Final Measurement Detector 1

Frequency (MHz)	QuasiPeak (dBµ V)	Meas. Time (ms)	Bandwidth (kHz)	Filter	Line	Corr. (dB)	Margin (dB)	Limit (dBµ V)	Comment
0.566780	31.6	1000.00	9.000	On	L1	9.7	24.4	56.0	
3.992120	32.8	1000.00	9.000	On	L1	9.7	23.2	56.0	
27.894690	33.3	1000.00	9.000	On	L1	9.9	26.7	60.0	

Final Measurement Detector 2

Frequency (MHz)	Average (dBµ V)	Meas. Time (ms)	Bandwidth (kHz)	Filter	Line	Corr. (dB)	Margin (dB)	Limit (dBµ V)	Comment
0.560040	25.7	1000.00	9.000	On	L1	9.7	20.3	46.0	
0.831480	18.9	1000.00	9.000	On	L1	9.7	27.1	46.0	
27.894690	21.9	1000.00	9.000	On	L1	9.9	28.1	50.0	

Emission Level = Read Level + Correct Factor





Test Voltage:	AC 120V/60Hz
Terminal:	Neutral
Remark:	Only worse case is reported

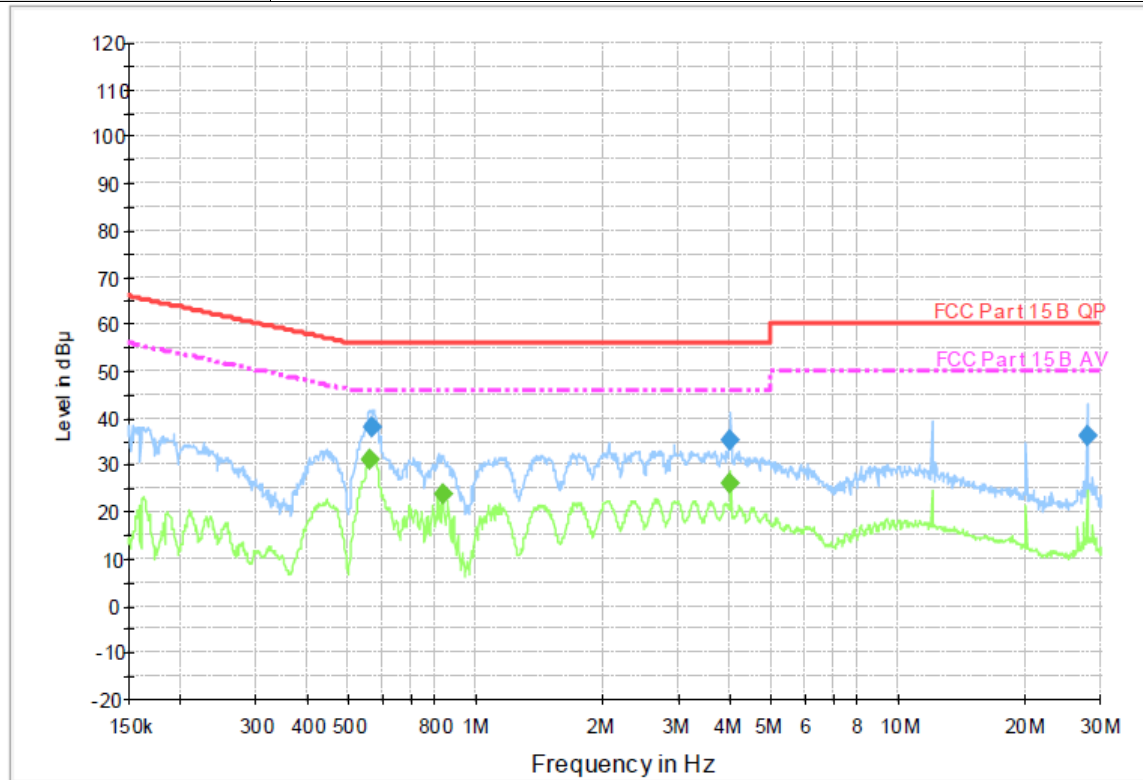

Final Measurement Detector 1

Frequency (MHz)	QuasiPeak (dBµ V)	Meas. Time (ms)	Bandwidth (kHz)	Filter	Line	Corr. (dB)	Margin (dB)	Limit (dBµ V)	Comment
0.569050	37.8	1000.00	9.000	On	N	10.0	18.2	56.0	
3.992120	35.1	1000.00	9.000	On	N	10.0	20.9	56.0	
27.894690	36.1	1000.00	9.000	On	N	10.0	23.9	60.0	

Final Measurement Detector 2

Frequency (MHz)	Average (dBµ V)	Meas. Time (ms)	Bandwidth (kHz)	Filter	Line	Corr. (dB)	Margin (dB)	Limit (dBµ V)	Comment
0.560040	31.3	1000.00	9.000	On	N	10.0	14.7	46.0	
0.831480	23.5	1000.00	9.000	On	N	10.0	22.5	46.0	
3.992120	26.2	1000.00	9.000	On	N	10.0	19.8	46.0	

Emission Level = Read Level + Correct Factor

3.2. Radiated Emission

Limit

FCC CFR Title 47 Part 15 Subpart C Section 15.209 / RSS-Gen 8.9

Frequency (MHz)	Field Strength (microvolts/meter)	Measurement Distance (meters)
0.009~0.490	2400/F (kHz)	300
0.490~1.705	24000/F (kHz)	30
1.705~30.0	30	30
30~88	100	3
88~216	150	3
216~960	200	3
960~1000	500	3

Frequency Range (MHz)	dBµV/m (at 3 meters)	
	Peak	Average
Above 1000	74	54

Note:

- (1) The tighter limit applies at the band edges.
- (2) Emission Level (dBµV/m)=20log Emission Level (µV/m).

Test Configuration

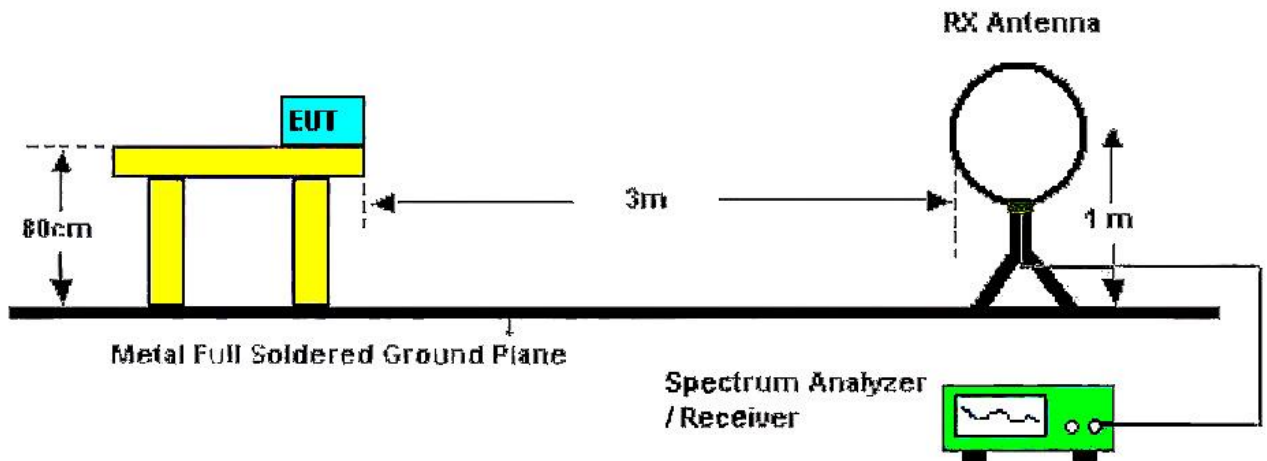

Below 30MHz Test Setup



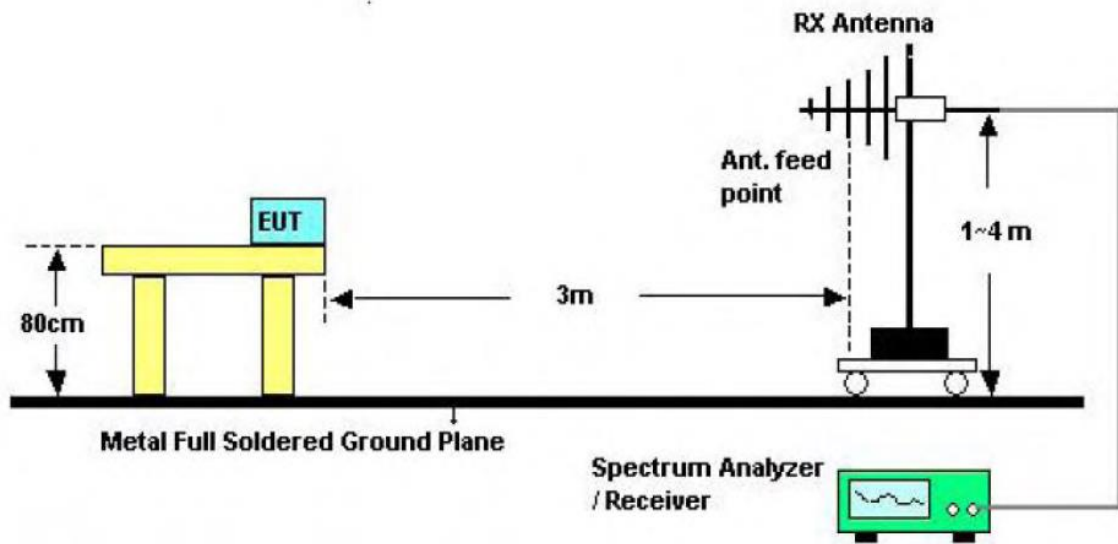

30-1000MHz Test Setup

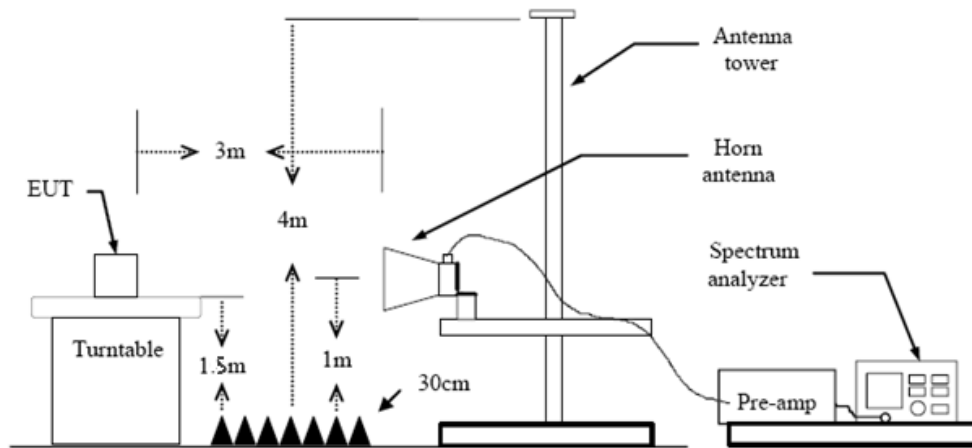

Above 1GHz Test Setup

Test Procedure

1. The EUT was setup and tested according to ANSI C63.10:2013.
2. The EUT is placed on a turn table which is 0.8 meter above ground for below 1 GHz, and 1.5 m for above 1 GHz. The turn table is rotated 360 degrees to determine the position of the maximum emission level.
3. The EUT was set 3 meters from the receiving antenna, which was mounted on the top of a variable height antenna tower.
4. For each suspected emission, the EUT was arranged to its worst case and then tune the Antenna tower (from 1 m to 4 m) and turntable (from 0 degree to 360 degrees) to find the maximum reading. A pre-amp and a high pass filter are used for the test in order to get better signal level to comply with the guidelines.
5. Set to the maximum power setting and enable the EUT transmit continuously.
6. Use the following spectrum analyzer settings
 - (1) Span shall wide enough to fully capture the emission being measured;



(2) Below 1 GHz:

RBW=120 kHz, VBW=300 kHz, Sweep=auto, Detector function=peak, Trace=max hold;

If the emission level of the EUT measured by the peak detector is 3 dB lower than the applicable limit, the peak emission level will be reported. Otherwise, the emission measurement will be repeated using the quasi-peak detector and reported.

(3) From 1 GHz to 10th harmonic:

RBW=1MHz, VBW=3MHz Peak detector for Peak value.

RBW=1MHz, VBW see note 1 with Peak Detector for Average Value.

Note 1: For measurements above 1 GHz the resolution bandwidth is set to 1 MHz, then the video bandwidth is set to 3 MHz for peak measurements and 1 MHz resolution bandwidth with 1/T video bandwidth with peak detector for average measurements. For the Duty Cycle please refer to clause 3.8 Duty Cycle.

Test Mode

Please refer to the clause 2.4.

Test Result

9 kHz~30 MHz

From 9 kHz to 30 MHz: The conclusion is PASS.

Note: The amplitude of spurious emissions which are attenuated by more than 20dB below the permissible value has no need to be reported.



30MHz-1GHz

Ant. Pol.	Horizontal
Test Mode:	TX BLE 1M Mode 2402MHz
Remark:	Only worse case is reported.

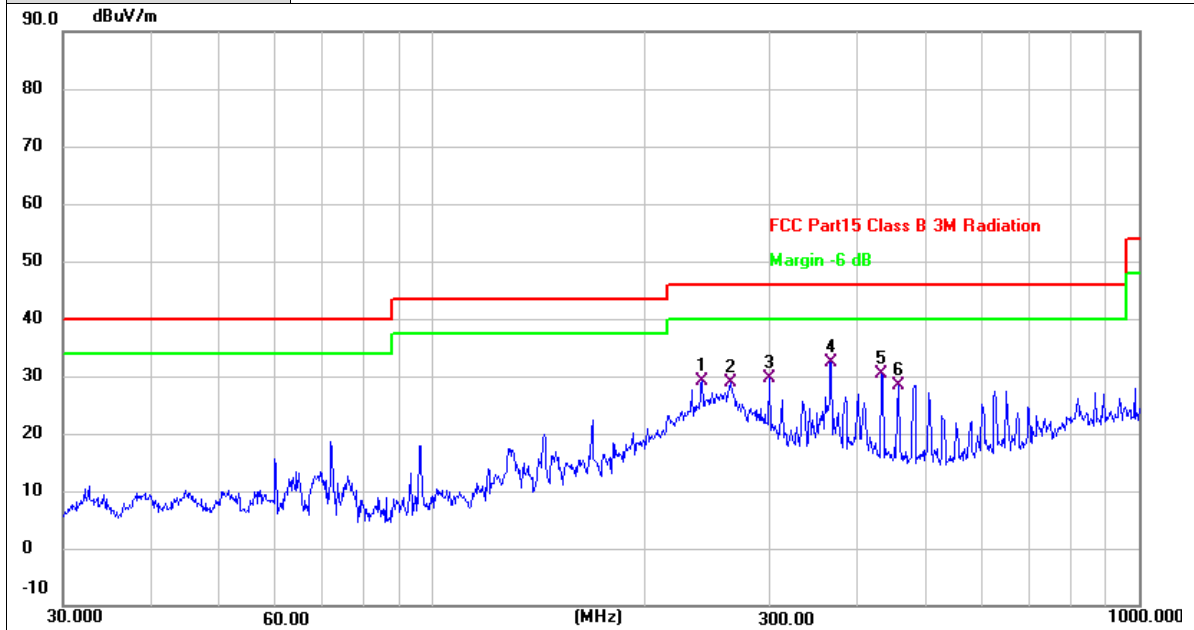

No.	Frequency (MHz)	Reading (dBuV)	Factor (dB/m)	Level (dBuV/m)	Limit (dBuV/m)	Margin (dB)	Detector
1	240.8303	47.96	-18.93	29.03	46.00	-16.97	QP
2	263.8190	47.20	-18.21	28.99	46.00	-17.01	QP
3	299.3158	46.94	-17.19	29.75	46.00	-16.25	QP
4 *	366.8231	48.03	-15.58	32.45	46.00	-13.55	QP
5	432.5456	44.38	-13.91	30.47	46.00	-15.53	QP
6	455.9058	41.81	-13.32	28.49	46.00	-17.51	QP

Remarks:

- 1. Factor (dB/m) = Antenna Factor (dB/m)+Cable Factor (dB)-Pre-amplifier Factor
- 2. Margin value = Level -Limit value



Ant. Pol.	Vertical
Test Mode:	TX BLE 1M Mode 2402MHz
Remark:	Only worse case is reported.

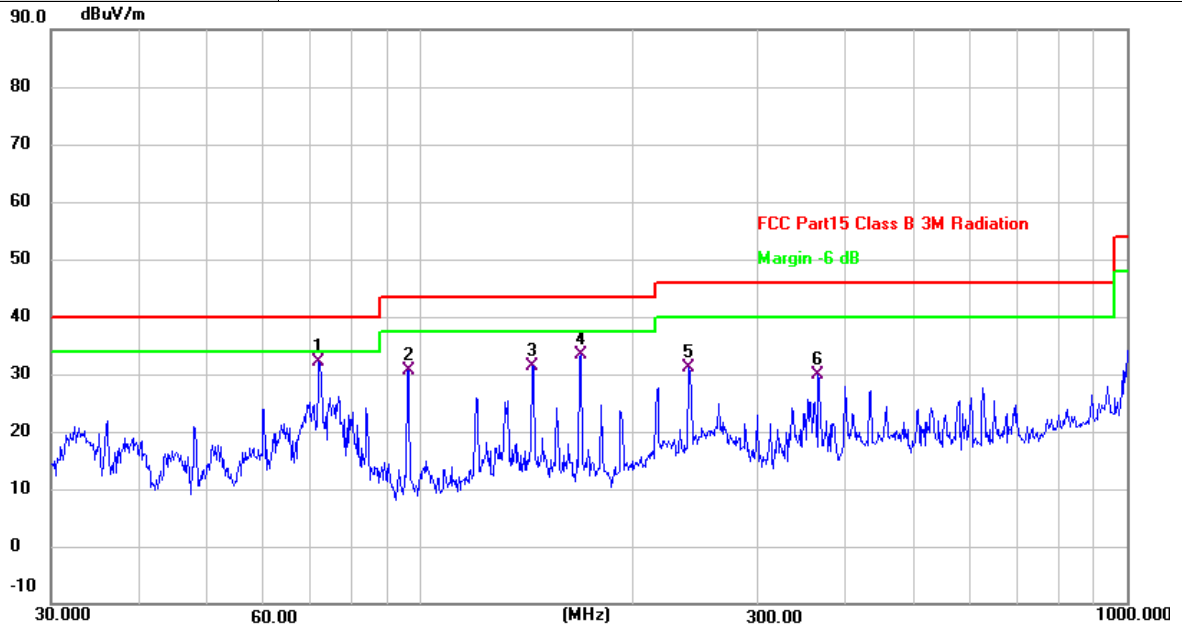

No.	Frequency (MHz)	Reading (dBuV)	Factor (dB/m)	Level (dBuV/m)	Limit (dBuV/m)	Margin (dB)	Detector
1 *	71.8320	52.95	-20.77	32.18	40.00	-7.82	QP
2	96.0985	51.91	-21.27	30.64	43.50	-12.86	QP
3	143.8295	48.52	-17.02	31.50	43.50	-12.00	QP
4	168.4137	51.21	-17.81	33.40	43.50	-10.10	QP
5	239.9873	49.99	-18.95	31.04	46.00	-14.96	QP
6	365.5390	45.38	-15.62	29.76	46.00	-16.24	QP

Remarks:

- 1. Factor (dB/m) = Antenna Factor (dB/m)+Cable Factor (dB)-Pre-amplifier Factor
- 2. Margin value = Level -Limit value



Above 1GHz

Ant. Pol.	Horizontal						
Test Mode:	TX BLE 1M Mode 2402MHz						
Remark:	No report for the emission which more than 20 dB below the prescribed limit.						
No.	Frequency (MHz)	Reading (dBUV)	Factor (dB/m)	Level (dBUV/m)	Limit (dBUV/m)	Margin (dB)	Detector
1	1991.760	58.39	-9.46	48.93	74.00	-25.07	peak
2	3202.257	55.63	-6.86	48.77	74.00	-25.23	peak
3	4954.527	48.40	-1.80	46.60	74.00	-27.40	peak
4	7013.535	47.25	2.82	50.07	74.00	-23.93	peak
5	9363.183	45.55	7.01	52.56	74.00	-21.44	peak
6 *	12349.371	43.50	9.95	53.45	74.00	-20.55	peak
Remarks:							
1.Factor (dB/m) = Antenna Factor (dB/m)+Cable Factor (dB)-Pre-amplifier Factor							
2.Margin value = Level -Limit value							

Ant. Pol.	Vertical						
Test Mode:	TX BLE 1M Mode 2402MHz						
Remark:	No report for the emission which more than 20 dB below the prescribed limit.						
No.	Frequency (MHz)	Reading (dBUV)	Factor (dB/m)	Level (dBUV/m)	Limit (dBUV/m)	Margin (dB)	Detector
1	1995.789	62.38	-9.43	52.95	74.00	-21.05	peak
2	3202.257	53.76	-6.86	46.90	74.00	-27.10	peak
3	4806.614	49.27	-2.43	46.84	74.00	-27.16	peak
4	6985.250	47.94	2.76	50.70	74.00	-23.30	peak
5	9363.183	45.76	7.01	52.77	74.00	-21.23	peak
6 *	10939.391	43.09	9.93	53.02	74.00	-20.98	peak
Remarks:							
1.Factor (dB/m) = Antenna Factor (dB/m)+Cable Factor (dB)-Pre-amplifier Factor							
2.Margin value = Level -Limit value							



Ant. Pol.	Horizontal
Test Mode:	TX BLE 1M Mode 2440MHz
Remark:	No report for the emission which more than 20 dB below the prescribed limit.

No.	Frequency (MHz)	Reading (dBuV)	Factor (dB/m)	Level (dBuV/m)	Limit (dBuV/m)	Margin (dB)	Detector
1	1991.760	60.00	-9.46	50.54	74.00	-23.46	peak
2	3254.441	56.53	-6.82	49.71	74.00	-24.29	peak
3	6943.035	47.82	2.65	50.47	74.00	-23.53	peak
4	7997.907	47.54	4.80	52.34	74.00	-21.66	peak
5	9325.421	46.12	6.96	53.08	74.00	-20.92	peak
6 *	12349.371	43.35	9.95	53.30	74.00	-20.70	peak

Remarks:

1. Factor (dB/m) = Antenna Factor (dB/m)+Cable Factor (dB)-Pre-amplifier Factor

2. Margin value = Level -Limit value

Ant. Pol.	Vertical
Test Mode:	TX BLE 1M Mode 2440MHz
Remark:	No report for the emission which more than 20 dB below the prescribed limit.

No.	Frequency (MHz)	Reading (dBuV)	Factor (dB/m)	Level (dBuV/m)	Limit (dBuV/m)	Margin (dB)	Detector
1	1995.789	64.79	-9.43	55.36	74.00	-18.64	peak
2 *	1995.789	49.56	-9.43	40.13	54.00	-13.87	AVG
3	3254.441	52.86	-6.82	46.04	74.00	-27.96	peak
4	4884.943	49.47	-2.10	47.37	74.00	-26.63	peak
5	7027.721	48.25	2.86	51.11	74.00	-22.89	peak
6	9306.597	45.45	6.92	52.37	74.00	-21.63	peak
7	11482.960	43.22	10.23	53.45	74.00	-20.55	peak

Remarks:

1. Factor (dB/m) = Antenna Factor (dB/m)+Cable Factor (dB)-Pre-amplifier Factor

2. Margin value = Level -Limit value



Ant. Pol.	Horizontal
Test Mode:	TX BLE 1M Mode 2480MHz
Remark:	No report for the emission which more than 20 dB below the prescribed limit.

No.	Frequency (MHz)	Reading (dBuV)	Factor (dB/m)	Level (dBuV/m)	Limit (dBuV/m)	Margin (dB)	Detector
1	1991.760	60.39	-9.46	50.93	74.00	-23.07	peak
2	3307.475	57.37	-6.79	50.58	74.00	-23.42	peak
3	6429.886	48.70	1.40	50.10	74.00	-23.90	peak
4	6915.034	48.38	2.57	50.95	74.00	-23.05	peak
5	9287.811	45.56	6.90	52.46	74.00	-21.54	peak
6 *	11693.690	43.03	9.99	53.02	74.00	-20.98	peak

Remarks:

1.Factor (dB/m) = Antenna Factor (dB/m)+Cable Factor (dB)-Pre-amplifier Factor

2.Margin value = Level -Limit value

Ant. Pol.	Vertical
Test Mode:	TX BLE 1M Mode 2480MHz
Remark:	No report for the emission which more than 20 dB below the prescribed limit.

No.	Frequency (MHz)	Reading (dBuV)	Factor (dB/m)	Level (dBuV/m)	Limit (dBuV/m)	Margin (dB)	Detector
1	1991.760	66.27	-9.46	56.81	74.00	-17.19	peak
2 *	1991.760	49.52	-9.46	40.06	54.00	-13.94	AVG
3	3307.475	52.92	-6.79	46.13	74.00	-27.87	peak
4	4964.548	48.40	-1.75	46.65	74.00	-27.35	peak
5	7041.936	47.63	2.88	50.51	74.00	-23.49	peak
6	9439.166	45.88	7.11	52.99	74.00	-21.01	peak
7	12349.371	43.52	9.95	53.47	74.00	-20.53	peak

Remarks:

1.Factor (dB/m) = Antenna Factor (dB/m)+Cable Factor (dB)-Pre-amplifier Factor

2.Margin value = Level -Limit value

3.3. Band Edge Emissions (Radiated)

Limit

FCC CFR Title 47 Part 15 Subpart C Section 15.247 (d) / RSS-247 5.5

Restricted Frequency Band (MHz)	(dB μ V/m) (at 3m)	
	Peak	Average
2310 ~ 2390	74	54
2483.5 ~ 2500	74	54

Test Configuration

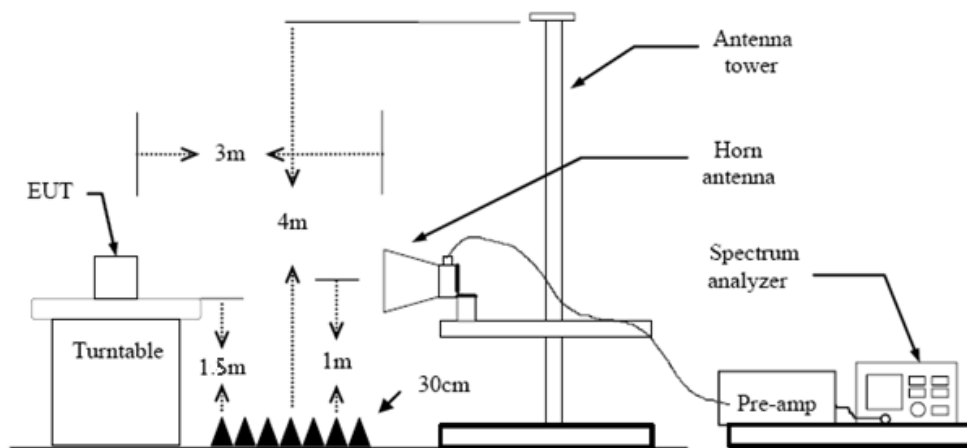

Test Procedure

1. The EUT was setup and tested according to ANSI C63.10:2013 requirements.
2. The EUT is placed on a turn table which is 1.5 meter above ground. The turn table is rotated 360 degrees to determine the position of the maximum emission level.
3. The EUT was positioned such that the distance from antenna to the EUT was 3 meters.
4. The antenna is scanned from 1 meter to 4 meters to find out the maximum emission level. This is repeated for both horizontal and vertical polarization of the antenna. In order to find the maximum emission, all of the interface cables were manipulated according to ANSI C63.10:2013 on radiated measurement.
5. The receiver set as follow:
 RBW=1MHz, VBW=3MHz Peak detector for Peak value.
 RBW=1MHz, VBW see note 1 with Peak Detector for Average Value.

Note 1: For measurements, above 1 GHz the resolution bandwidth is set to 1 MHz, then the video bandwidth is set to 3 MHz for peak measurements and 1 MHz resolution bandwidth with 1/T video bandwidth with peak detector for average measurements. For the Duty Cycle please refer to clause 3.8 Duty Cycle.

Test Mode

Please refer to the clause 2.4.



Test Result

Ant. Pol.	Horizontal
Test Mode:	TX BLE 1M Mode 2402MHz

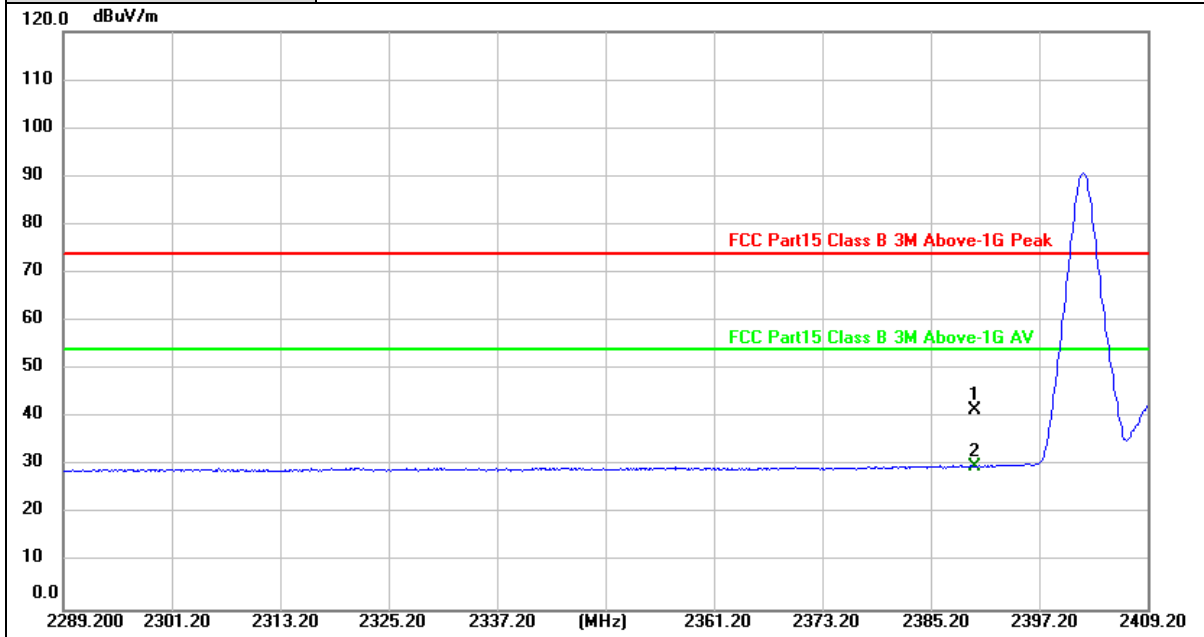

No.	Frequency (MHz)	Reading (dBuV)	Factor (dB/m)	Level (dBuV/m)	Limit (dBuV/m)	Margin (dB)	Detector
1	2390.000	49.41	-7.72	41.69	74.00	-32.31	peak
2 *	2390.000	37.69	-7.72	29.97	54.00	-24.03	AVG

Remarks:

- 1.Factor (dB/m) = Antenna Factor (dB/m)+Cable Factor (dB)-Pre-amplifier Factor
- 2.Margin value = Level -Limit value



Ant. Pol.	Vertical
Test Mode:	TX BLE 1M Mode 2402MHz

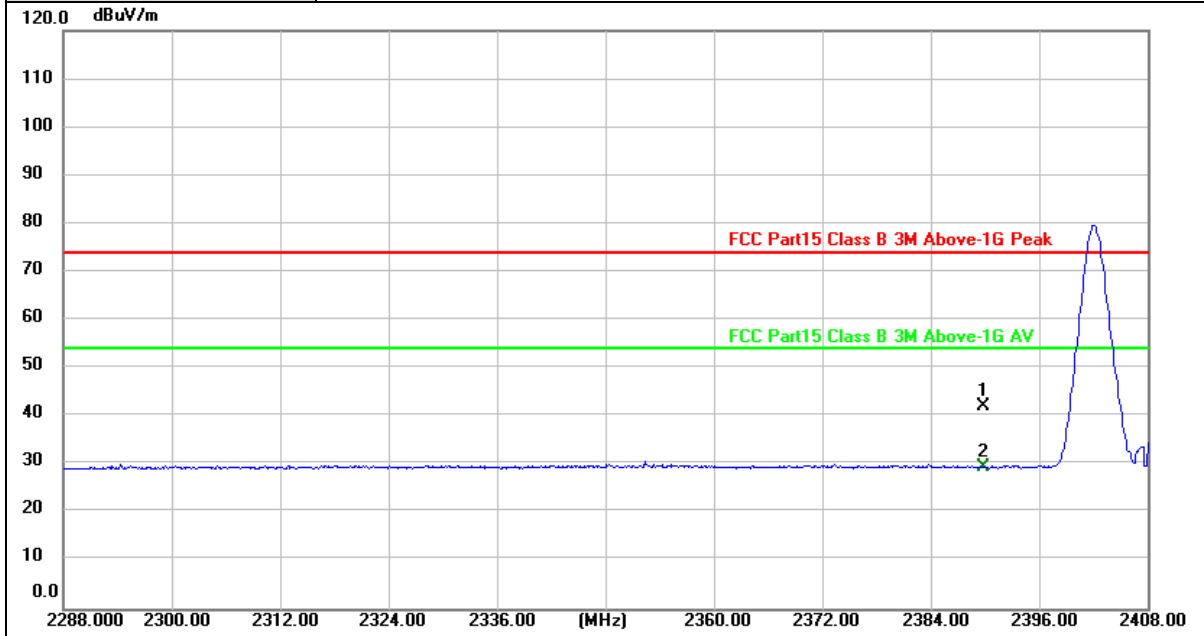

No.	Frequency (MHz)	Reading (dBuV)	Factor (dB/m)	Level (dBuV/m)	Limit (dBuV/m)	Margin (dB)	Detector
1	2390.000	49.84	-7.72	42.12	74.00	-31.88	peak
2 *	2390.000	37.20	-7.72	29.48	54.00	-24.52	AVG

Remarks:

- 1. Factor (dB/m) = Antenna Factor (dB/m) + Cable Factor (dB) - Pre-amplifier Factor
- 2. Margin value = Level - Limit value



Ant. Pol.	Horizontal
Test Mode:	TX BLE 1M Mode 2480MHz

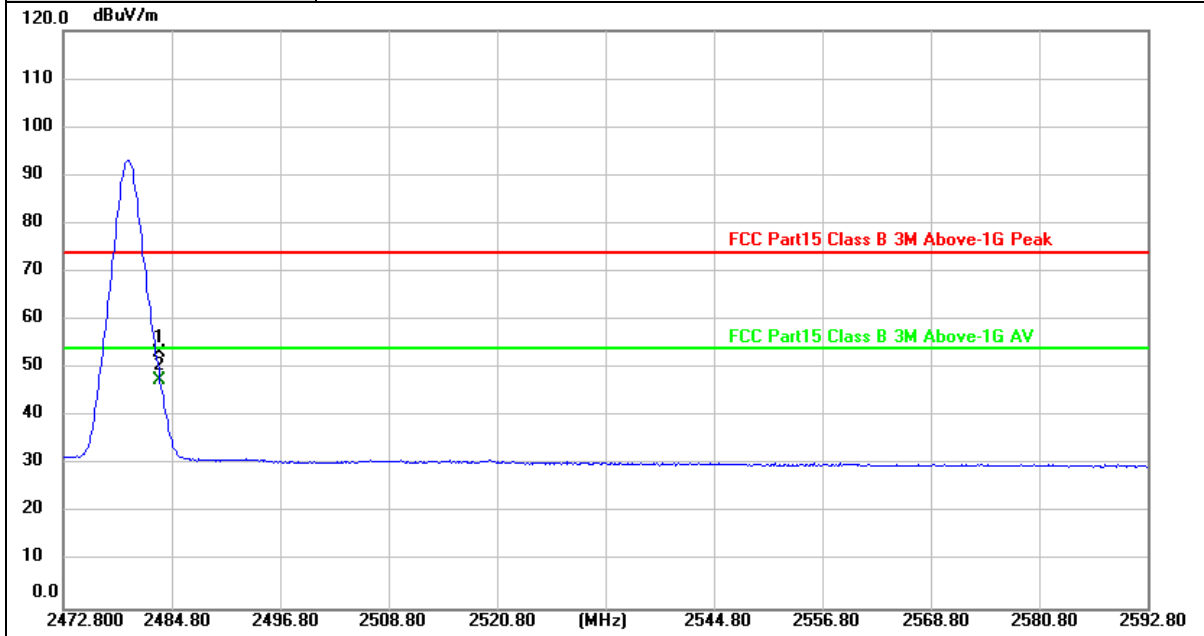

No.	Frequency (MHz)	Reading (dBuV)	Factor (dB/m)	Level (dBuV/m)	Limit (dBuV/m)	Margin (dB)	Detector
1	2483.500	60.72	-7.32	53.40	74.00	-20.60	peak
2 *	2483.500	54.82	-7.32	47.50	54.00	-6.50	AVG

Remarks:

- 1. Factor (dB/m) = Antenna Factor (dB/m)+Cable Factor (dB)-Pre-amplifier Factor
- 2. Margin value = Level -Limit value



Ant. Pol.	Vertical
Test Mode:	TX BLE 1M Mode 2480MHz

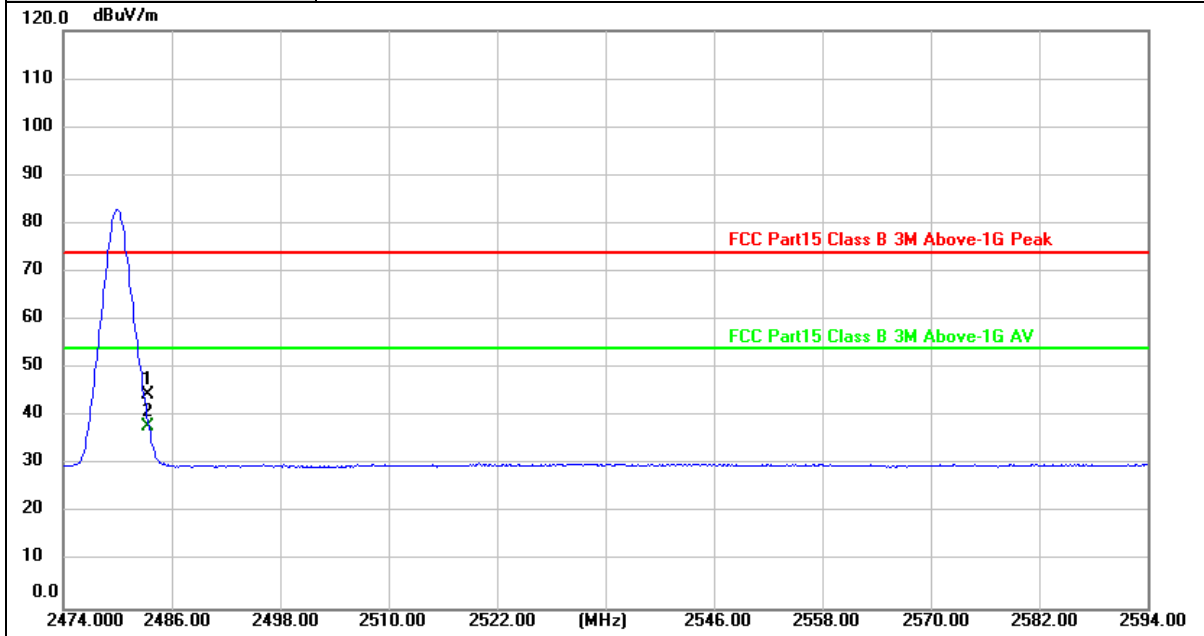

No.	Frequency (MHz)	Reading (dBuV)	Factor (dB/m)	Level (dBuV/m)	Limit (dBuV/m)	Margin (dB)	Detector
1	2483.500	51.78	-7.32	44.46	74.00	-29.54	peak
2 *	2483.500	45.17	-7.32	37.85	54.00	-16.15	AVG

Remarks:

- 1.Factor (dB/m) = Antenna Factor (dB/m)+Cable Factor (dB)-Pre-amplifier Factor
- 2.Margin value = Level -Limit value



3.4. Band Edge and Spurious Emissions (Conducted)

Limit

FCC CFR Title 47 Part 15 Subpart C Section 15.247 (d) / RSS-247 5.5

In any 100 kHz bandwidth outside the frequency band in which the spread spectrum intentional radiator is operating, the radio frequency power that is produced by the intentional radiator shall be at least 20 dB below that in the 100 kHz bandwidth within the band that contains the highest level of the desired power, based on either an RF conducted or a radiated measurement, provided the transmitter demonstrates compliance with the peak conducted power limits. If the transmitter complies with the conducted power limits based on the use of RMS averaging over a time interval, as permitted under paragraph (b)(3) of this section, the attenuation required under this paragraph shall be 30 dB instead of 20 dB.

Test Configuration

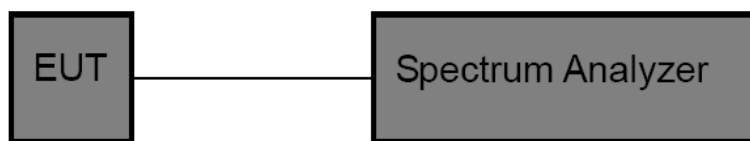

Test Procedure

1. The transmitter output was connected to the spectrum analyzer through an attenuator, the path loss was compensated to the results for each measurement.
2. Set to the maximum power setting and enable the EUT transmit continuously.
3. Use the following spectrum analyzer settings:
RBW = 100 kHz, VBW ≥ RBW, scan up through 10th harmonic.
Sweep = auto, Detector function = peak, Trace = max hold.
4. Measure and record the results in the test report.

Test Mode

Please refer to the clause 2.4.

Test Result

Mode	Channel	OOB Emission Frequency (MHz)	OOB Emission Level (dBm)	Limit (dBm)	Over Limit (dB)	Result
LE	0	2400.00	-38.939	-17.16	-22.000	PASS
		23852.0	-42.160	-17.16	-25.000	PASS
	19	23901.9	-40.873	-17.53	-23.343	PASS
	39	2483.50	-56.777	-18.49	-38.000	PASS
		23888.8	-42.594	-18.49	-24.104	PASS



Test Graphs:



In-Band Reference Level LE Channel 0

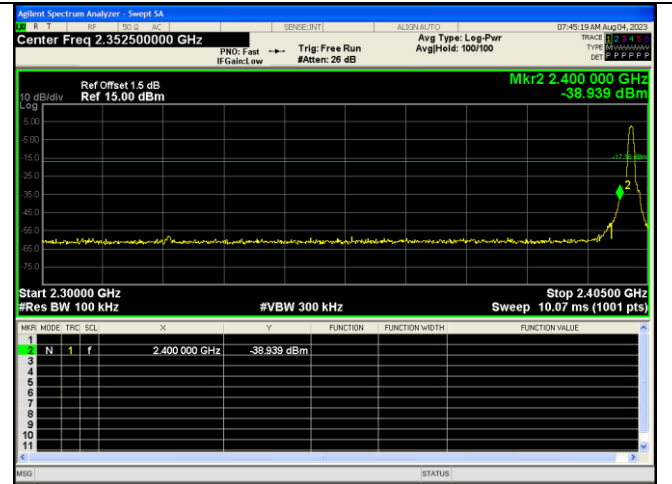

Out Of Band Emission LE Channel 0

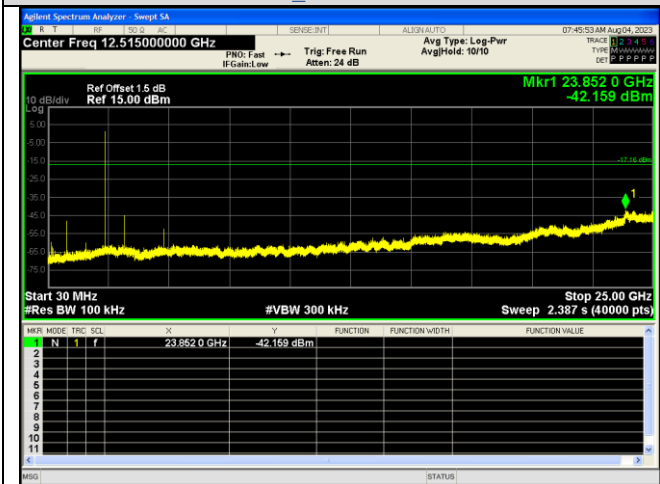

Spurious Emission LE Channel 0

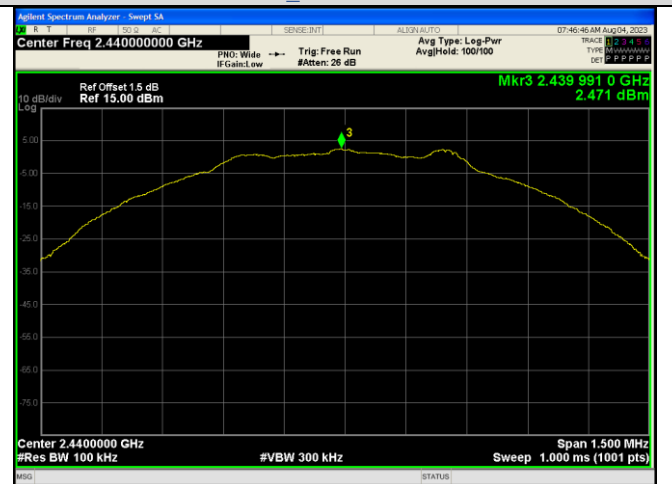

In-Band Reference Level LE Channel 19

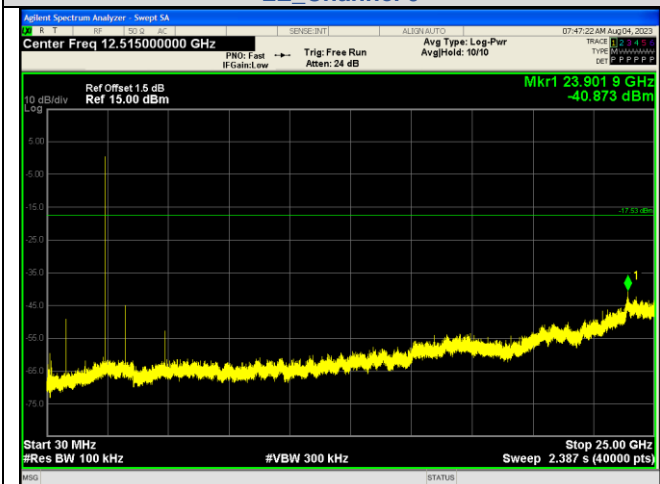

Spurious Emissions LE Channel 19

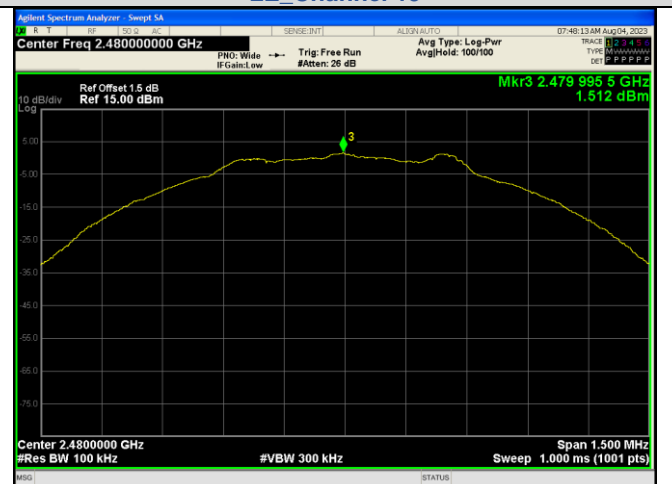

In-Band Reference Level LE Channel 39

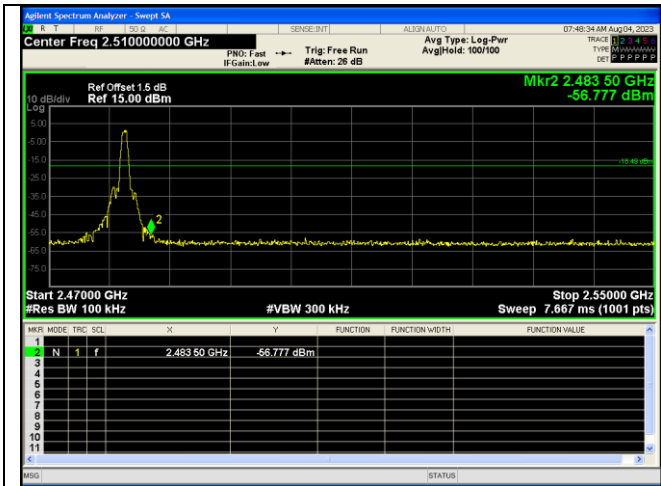

Out Of Band Emission
LE Channel 39

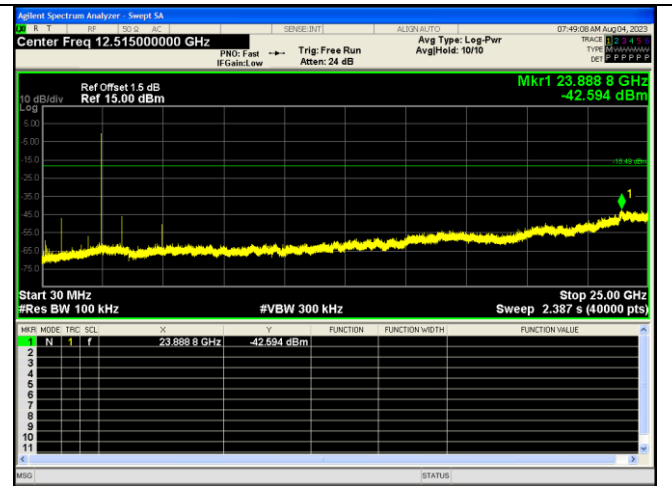

Spurious Emission
LE Channel 39



3.5. DTS Bandwidth

Limit

FCC CFR Title 47 Part 15 Subpart C Section 15.247 (a)(2) / RSS-247 5.2 a

Test Item	Limit	Frequency Range (MHz)
DTS Bandwidth	≥500 kHz (6dB bandwidth)	2400~2483.5

Test Configuration

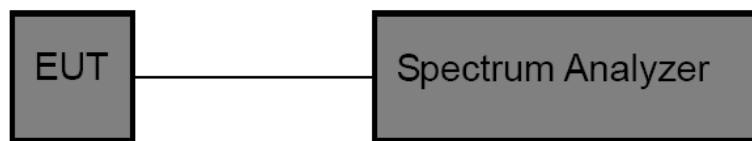

Test Procedure

- The EUT was directly connected to the spectrum analyzer and antenna output port as show in the block diagram above.
- DTS Spectrum Setting:
 - Set RBW = 100 kHz.
 - Set the video bandwidth (VBW) ≥ 3 RBW.
 - Detector = Peak.
 - Trace mode = Max hold.
 - Sweep = Auto couple.
- OCB Spectrum Setting:
 - Set RBW = 1% ~ 5% occupied bandwidth.
 - Set the video bandwidth (VBW) ≥ 3 RBW.
 - Detector = Peak.
 - Trace mode = Max hold.
 - Sweep = Auto couple.

NOTE: The EUT was set to continuously transmitting in each mode and low, Middle and high channel for the test.

Test Mode

Please refer to the clause 2.4.

Test Result

Mode	Channel	Occupied Bandwidth (MHz)	DTS Bandwidth (MHz)	Limit (MHz)	Result
LE	0	1.0221	0.6371	0.5	PASS
	19	1.0250	0.6416		PASS
	39	1.0208	0.6381		PASS



Occupied Bandwidth:

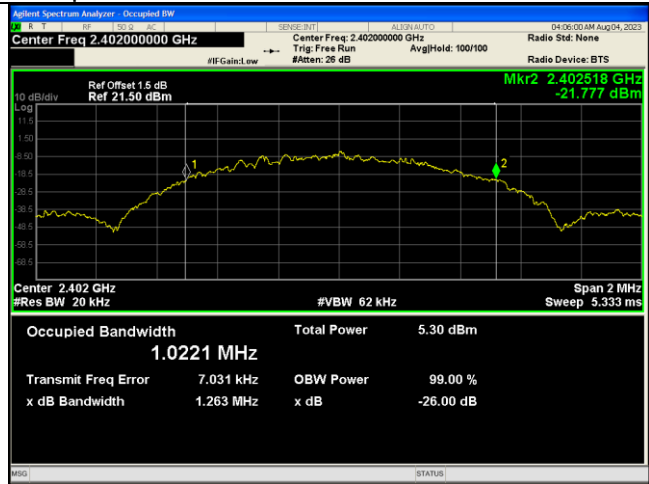

LE_Channel 0

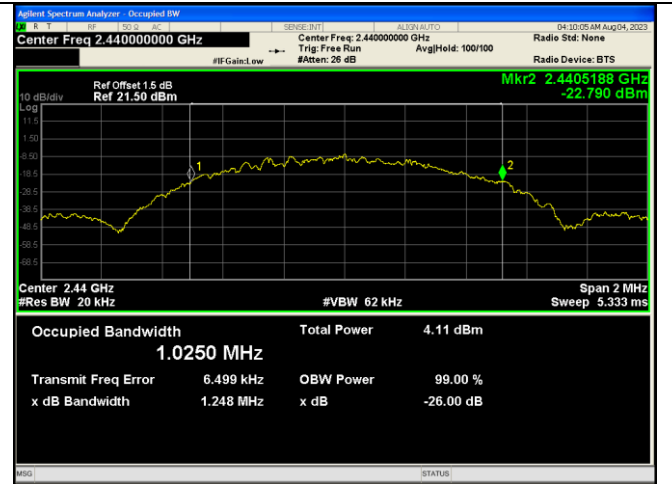

LE_Channel 19

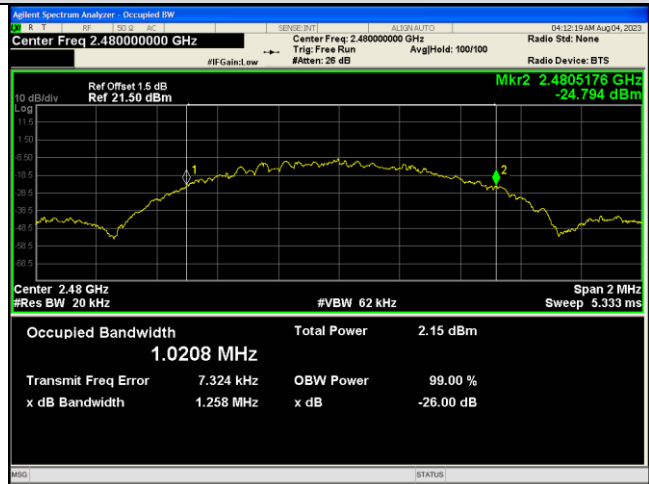

LE_Channel 39



DTS Bandwidth:

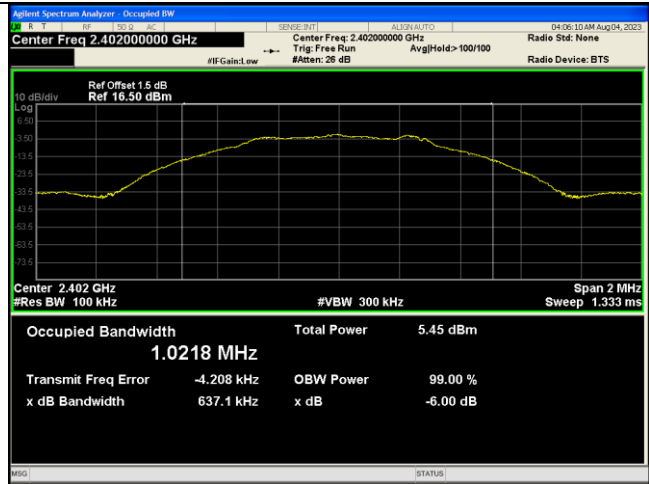

LE_Channel 0

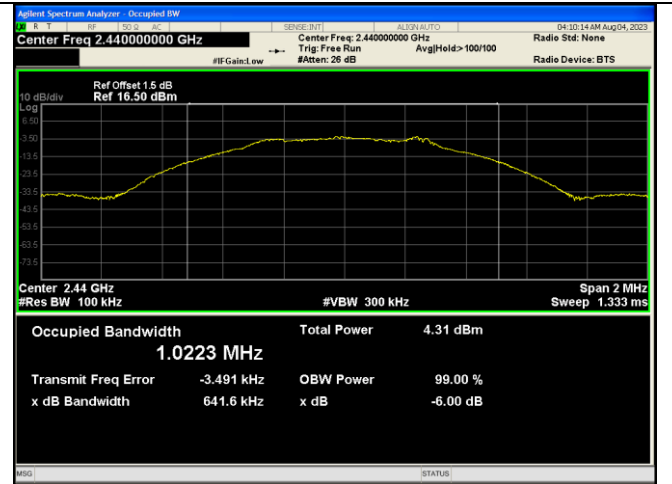

LE_Channel 19

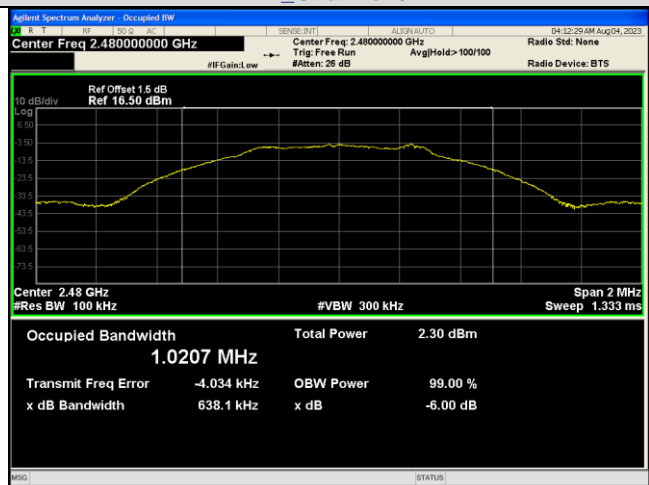

LE_Channel 39





3.6. Peak Output Power

Limit

FCC CFR Title 47 Part 15 Subpart C Section 15.247 (b)(3) / RSS-247 5.4 d

Section	Test Item	Limit	Frequency Range (MHz)
FCC CFR 47 Part15.247 (b)(3)	Maximum Conducted Output Power	1 Watt or 30dBm	2400~2483.5
ISED RSS-247 5.4 d	EIRP	4 Watt or 36dBm	2400~2483.5

Test Configuration

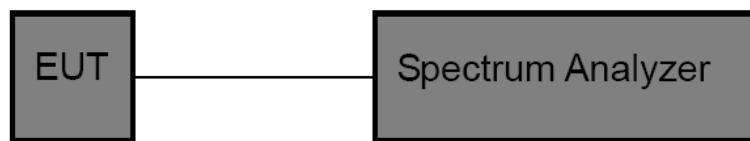

Test Procedure

- The EUT was directly connected to the spectrum analyzer and antenna output port as show in the block diagram above.
- Spectrum Setting:
 - Set RBW \geq DTS Bandwidth.
 - Set VBW \geq 3*RBW.
 - Set Span \geq 3*RBW.
 - Sweep time = Auto couple.
 - Detector = Peak.
 - Trace mode = Max hold.
 Allow trace to fully stabilize. Then use the peak marker function to determine the maximum amplitude level.

Test Mode

Please refer to the clause 2.4.

Test Result

Mode	Channel	Peak Output Power(dBm)	Limit (dBm)	Result
LE	0	3.061	30	PASS
	19	2.726	30	PASS
	39	1.692	30	PASS

Mode	Channel	Peak Output Power(dBm)	EIRP(dBm)	Limit (dBm)	Result
LE	0	3.061	5.881	36	PASS
	19	2.726	5.546	36	PASS
	39	1.692	4.512	36	PASS



Test Graphs:

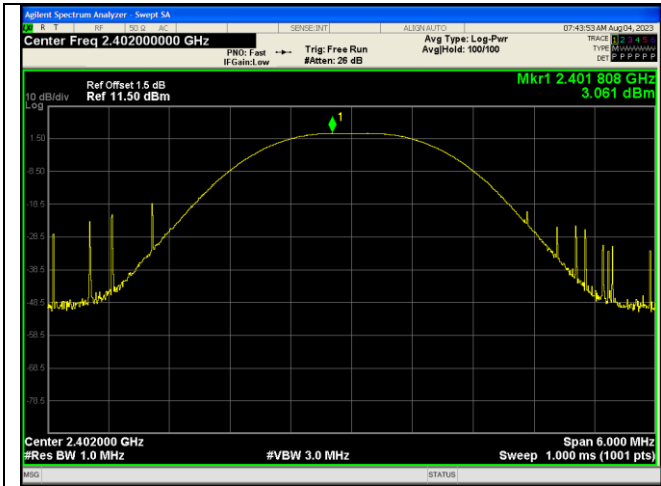

Peak Output Power LE_Channel 0

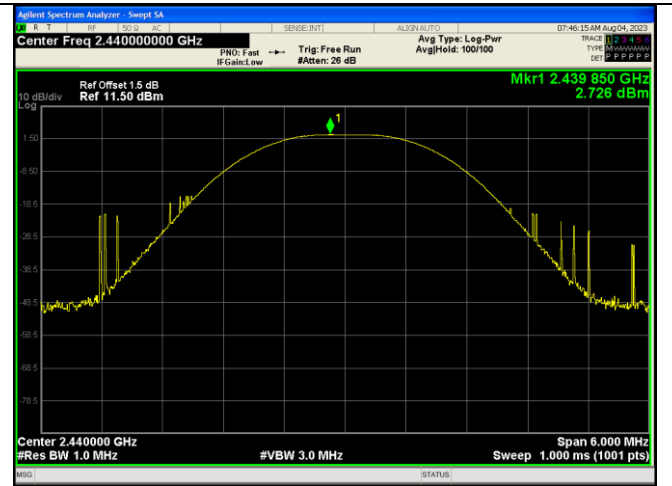

Peak Output Power LE_Channel 19

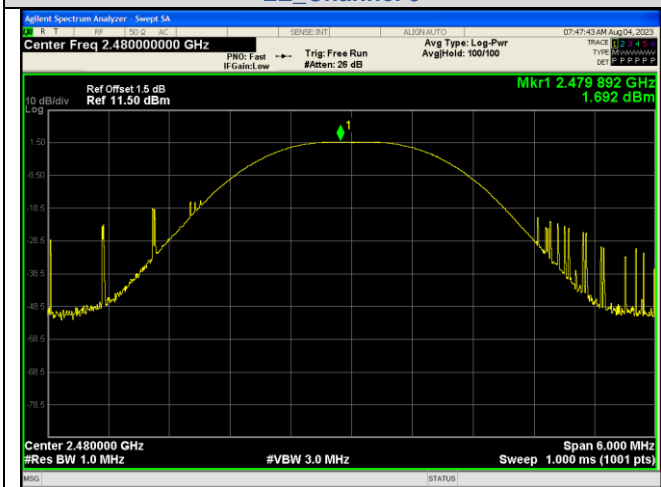

Peak Output Power LE_Channel 39

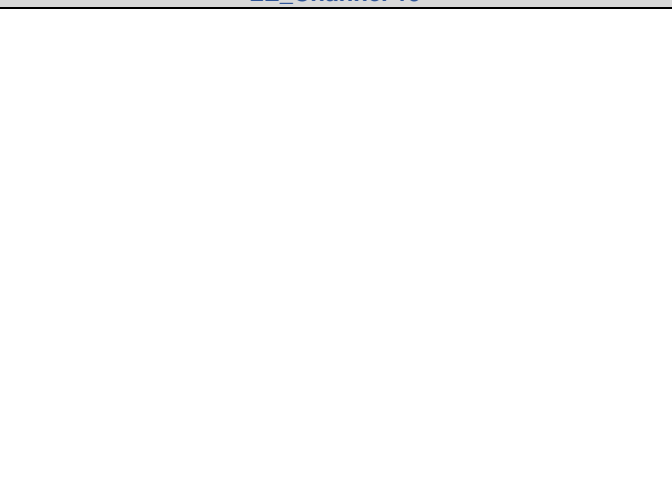



3.7. Power Spectral Density

Limit

FCC CFR Title 47 Part 15 Subpart C Section 15.247 (e) / RSS-247 5.2 b

Test Item	Limit	Frequency Range (MHz)
Power Spectral Density	8 dBm (in any 3 kHz)	2400~2483.5

Test Configuration

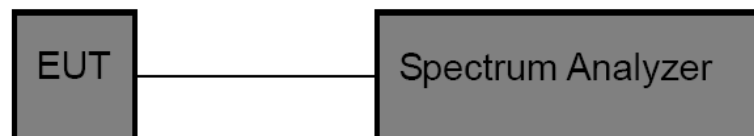

Test Procedure

1. The EUT was directly connected to the spectrum analyzer and antenna output port as show in the block diagram above.
2. The EUT was directly connected to the Spectrum Analyzer and antenna output port as show in the block diagram above. The measurement according to section 10.2 of KDB 558074 D01 DTS Meas Guidance v05r02.
3. Spectrum Setting:
Set analyzer center frequency to DTS channel center frequency.
Set the span to 1.5 times the DTS bandwidth.
Set the RBW to: 3 kHz.
Set the VBW to: 10 kHz.
Detector: peak.
Sweep time: auto.
Allow trace to fully stabilize. Then use the peak marker function to determine the maximum amplitude level.

Test Mode

Please refer to the clause 2.4.

Test Result

Mode	Channel	PSD (dBm/3kHz)	Limit (dBm/3kHz)	Result
LE	0	-12.341	8	PASS
	19	-12.875	8	PASS
	39	-13.750	8	PASS



Test Graphs:

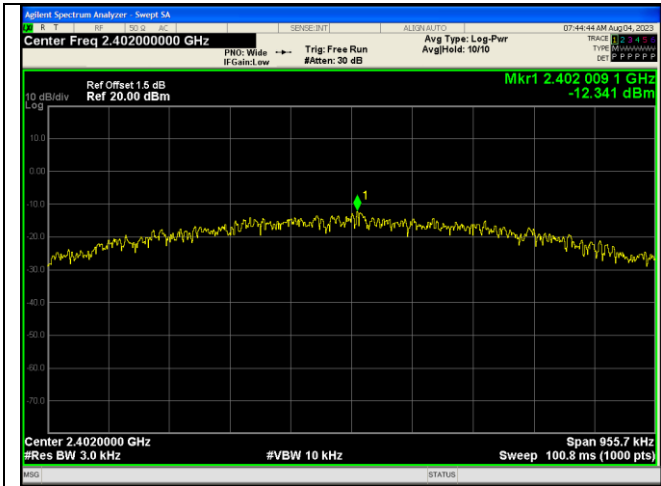

LE_Channel 0



LE_Channel 19

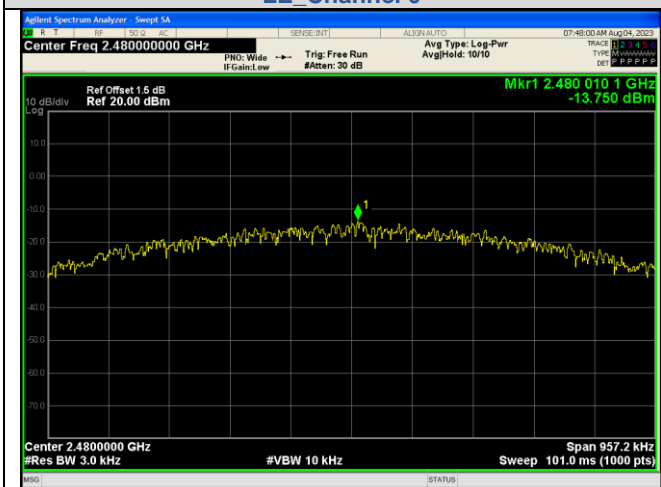

LE_Channel 39

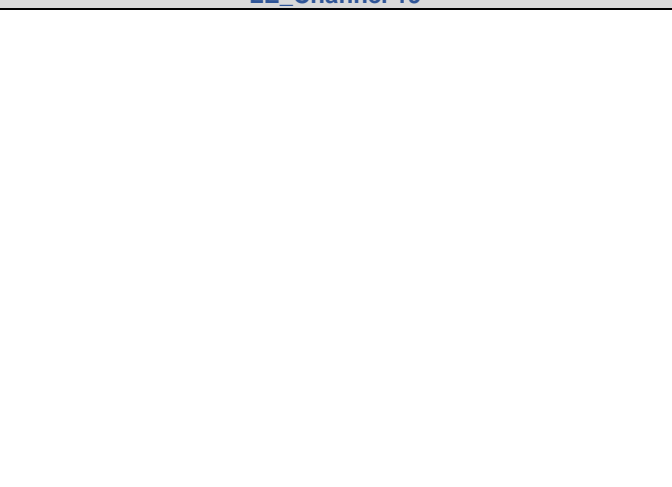



3.8. Duty Cycle

Limit

None, for report purposes only.

Test Configuration

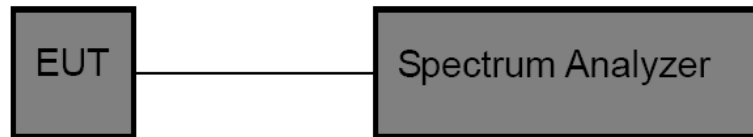

Test Procedure

1. The EUT was directly connected to the spectrum analyzer and antenna output port as show in the block diagram above.
2. The EUT was directly connected to the Spectrum Analyzer and antenna output port as show in the block diagram above. The measurement according to section 10.2 of KDB 558074 D01 DTS Meas Guidance v05r02.
3. Spectrum Setting:
 Set analyzer center frequency to test channel center frequency.
 Set the span to 0Hz.
 Set the RBW to 10MHz.
 Set the VBW to 10MHz.
 Detector: Peak.
 Sweep time: Auto.
 Allow trace to fully stabilize. Then use the peak marker function to determine the maximum amplitude level.

Test Mode

Please refer to the clause 2.4.

Test Result

Mode	Channel	On Time (ms)	Period (ms)	Duty Cycle (%)	1/T Minimum VBW (kHz)	Final Setting for VBW (kHz)
LE	0	2.091	2.500	83.65	0.48	1
	19	2.091	2.500	83.65	0.48	1
	39	2.091	2.500	83.65	0.48	1



Test Graphs:

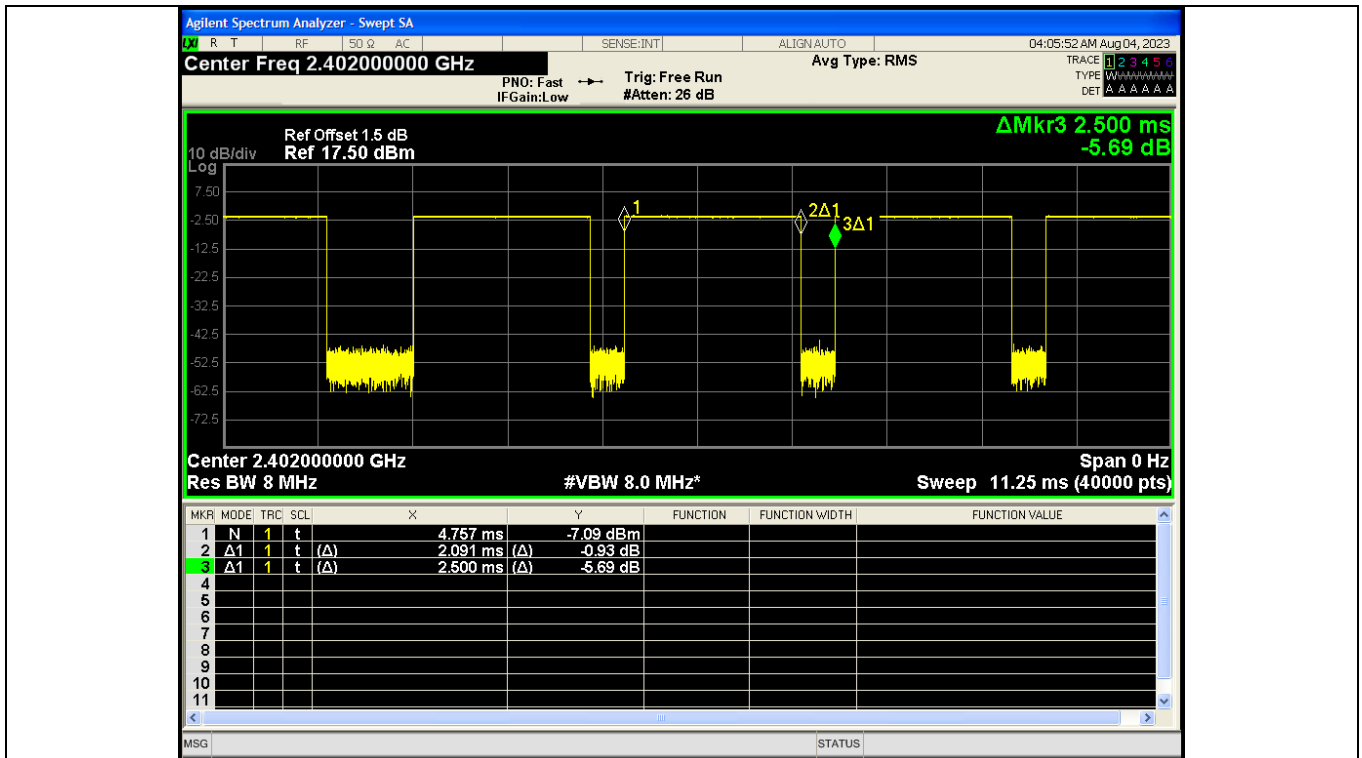

LE 2480

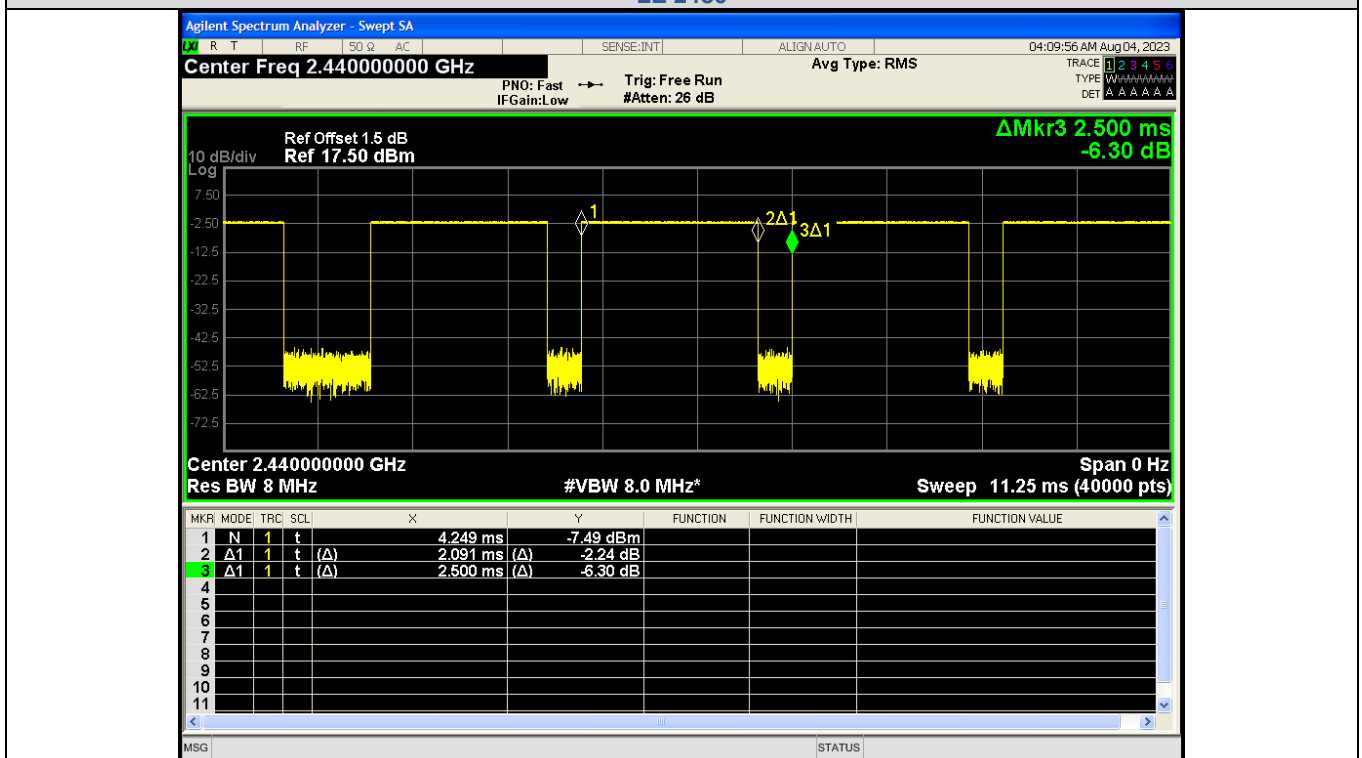

LE 2440

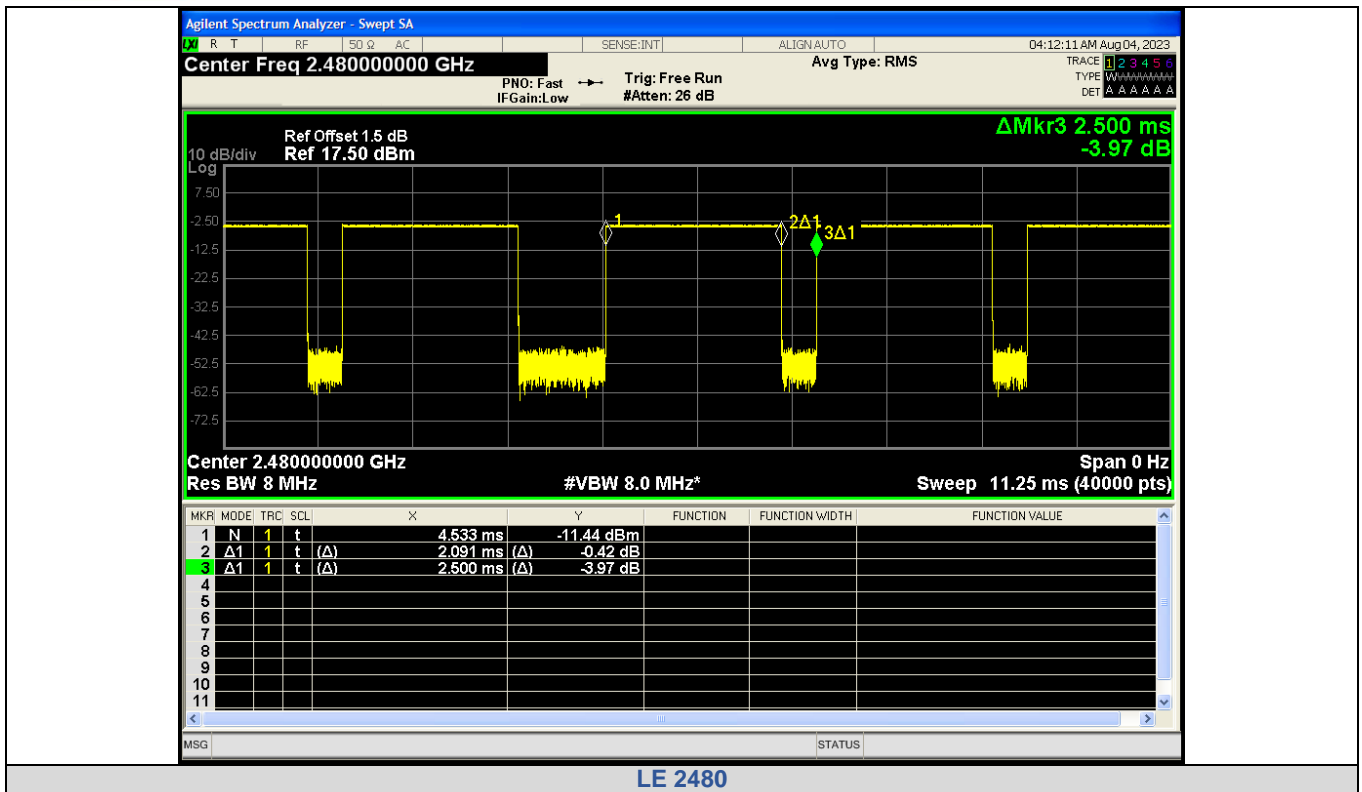



3.9. Antenna Requirement

Requirement

FCC CFR Title 47 Part 15 Subpart C Section 15.203

An intentional radiator shall be designed to ensure that no antenna other than that furnished by the responsible party shall be used with the device. The use of a permanently attached antenna or of antenna that uses a unique coupling to the intentional radiator, the manufacturer may design the unit so that a broken antenna can be replaced by the user, but the use of a standard antenna jack or electrical connector is prohibited.

FCC CFR Title 47 Part 15 Subpart C Section 15.247(c) (1)(i)

(i) Systems operating in the 2400~2483.5 MHz band that is used exclusively for fixed. Point-to-point operations may employ transmitting antennas with directional gain greater than 6dBi provided the maximum conducted output power of the intentional radiator is reduced by 1 dB for every 3 dB that the directional gain of the antenna exceeds 6dBi.

Test Result

The directional gain of the antenna is less than 6dBi, please refer to the EUT internal photographs antenna photo.

*****THE END*****