

# SONOFF

## MINI Extreme

### User manual V1.0

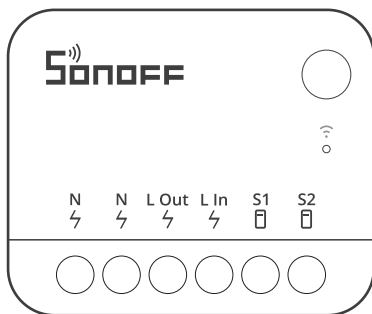

## Wi-Fi Smart Switch

## 产品介绍

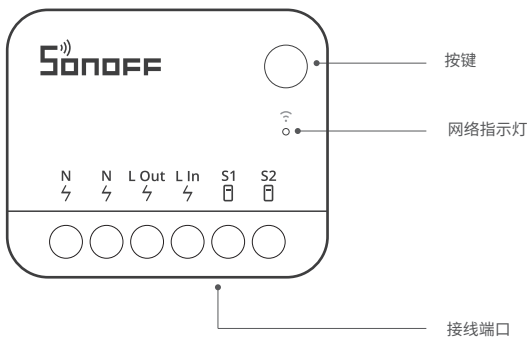

⚠ 设备重量 < 1Kg, 建议安装高度 < 2米。

## 信号指示灯状态说明

指示灯状态	状态说明
蓝灯呈两短一长闪烁	蓝牙配网模式
蓝色常亮	设备在线

## 功能特点

MINI Extreme紧凑小巧的机身,能够安装在开关暗盒中且最大支持10A负载,使普通开关变为智能开关。安全且智能,也可在智能场景中联动其他设备,实现你的家庭自动化。



远程控制



智能定时/延时



语音控制



局域网控制



通电反应



点动模式



智能场景



群组控制

## 设备安装

### 1. 断电

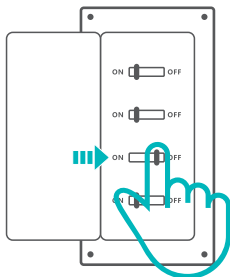

⚠ 设备安装、故障维修请由专业资质电工操作。切勿在设备通电时进行接线操作或触碰到接线端子,以免发生触电危险!

## 2. 接线

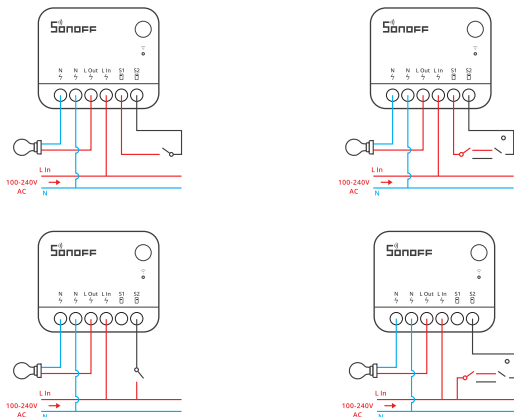

1. S1、S2 接或不接开关, 设备都可通过自动化或App来控制。
2. 禁止将S1连接零线、地线等强电, 禁止将S2连接火线、零线、地线等强电, 以免损坏设备, 造成危险。
3. 确保线路接入无误。

## 配对至易微联App

### 1. 下载易微联App

请前往应用商店、Google Play Store或Apple App Store搜索"易微联"进行下载。



## 2. 上电

通电后，设备首次使用，默认进入蓝牙配网模式。网络指示灯呈“两短一长闪烁”。

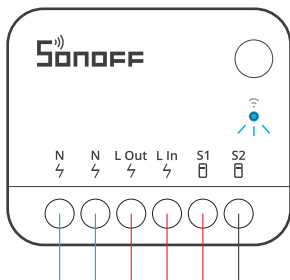

- ⓘ 10分钟内没有进行配网，设备将退出蓝牙配网模式。如需再次进入，长按设备按钮5秒直到网络指示灯呈两短一长闪烁即可。

## 3. 添加设备

点击“+”，选择“蓝牙配网”，再根据 App 提示进行操作。

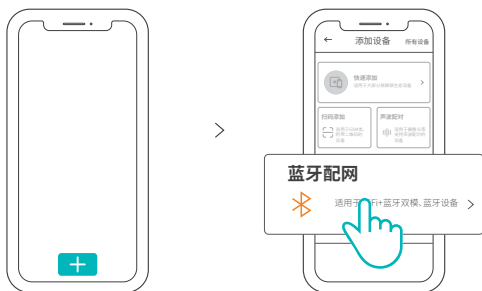

## 添加轻智能子设备

进入 eWeLink App 设备设置页面, 选择“轻智能子设备”再点击“添加”, 然后触发子设备, 即可添加成功。



## 将MINI Extreme安装在暗盒中

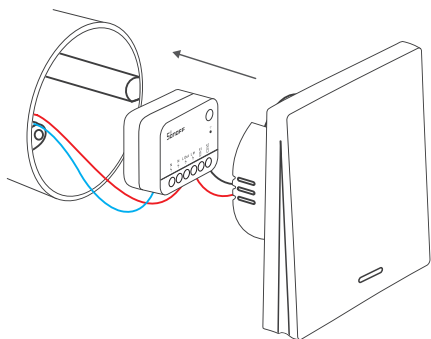

## 产品参数

产品型号	MINIR4
输入	100-240V ~ 50/60Hz 10A Max
输出	100-240V ~ 50/60Hz 10A Max
最大功率	2400W
Wi-Fi	IEEE 802.11b/g/n 2.4GHz
工作温度	-10°C-40°C
工作湿度	5%-95%RH,无冷凝
外壳材料	PC V0
产品规格	39.5x33x16.8mm

## 更换设备网络

在 eWeLink App 设备设置界面选择“WiFi设置”进行更换。

## 恢复出厂设置

在 eWeLink App 端“删除设备”，设备即恢复出厂设置。

## 常见问题

### 1. Wi-Fi设备与易微联App配对失败

1、确保设备进入配对模式。

10分钟内设备没有配对成功，则自动退出配对模式。

2、请开启定位服务以及允许获取定位权限

配网前，请先开启手机的定位服务并允许获取定位权限。位置信息权限用于获取Wi-Fi列表信息，如果“禁用”手机定位服务，设备将无法添加。

- 3、确保Wi-Fi运行在2.4GHz频段。
- 4、确保正确输入Wi-Fi网络名称和密码，且没有包含特殊字符。  
密码错误是常见的配对失败原因。
- 5、配对时为了确保良好的信号传输，请将设备靠近路由器。

## 2. LED指示灯连续闪烁两次，服务器连接失败

- 1、确保网络连接正常。你可以通过手机或者电脑连接网络。如果连接失败，请检查网络。
  - 2、路由器承载力较低，连接到路由器的设备超过最大值。请查看你的路由器可以连接的最大设备数量。如果超过最大值，请删除个别设备或者更换一个承载力较高的路由器再次连接。
- ❗ 如果以上方法均无法解决此问题，请在易微联APP上通过“帮助&反馈”提交你的问题。

## 3. Wi-Fi设备“离线”问题

- 1、路由器连接失败
- 2、输入不正确的Wi-Fi网络名称和密码
- 3、Wi-Fi网络名称和密码包含特殊字符。例如，我们的系统无法识别希伯来语和阿拉伯语字符，导致Wi-Fi连接失败
- 4、路由器承载力较低
- 5、Wi-Fi信号太弱。路由器和设备间隔太远，或者路由器与设备之前有障碍物导致信号无法传输。



## Product introduction

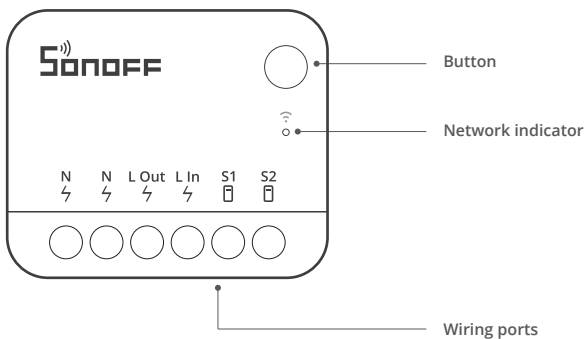

- ⚠ The device weight is less than 1kg, and the recommended installation height is less than 2m.

## Instruction of LED indicator status

LED indicator status	Status instruction
Blue LED indicator flashes (one long and two short)	Bluetooth pairing mode
Blue LED indicator keeps on	Device is online

## Features

MINI Extreme is compact and tiny enough to be installed in the mounted box, and it supports loads of up to 10A, enable to transform your ordinary switch into a smart switch. Safe and smart, allows you to set smart scenes with other smart devices to automate your home.



Remote Control



Timer Schedule



Voice Control



LAN Control



Power-on State



Inching Mode



Smart Scene



Group Control

## Installation

### 1. Power off

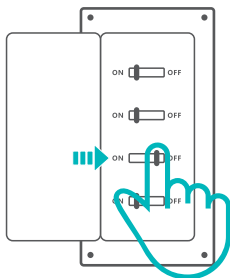

- ⚠ Please install and maintain the device by a professional electrician. To avoid electric shock hazard, do not operate any connection or contact the terminal connector while the device is powered on!

## 2. Wiring instruction

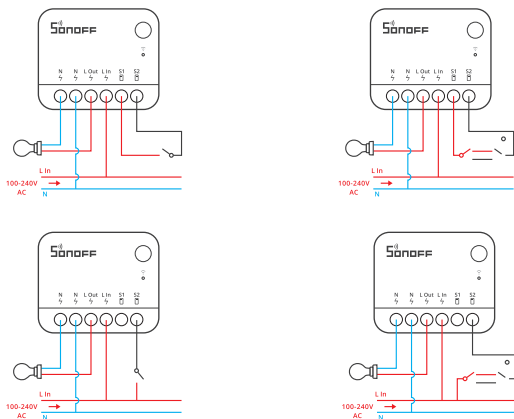

Before installing the device, please install an air switch as the protective device (Air switch: 10A/250V).

- 1、 No matter S1 and S2 are connected or left idle to the external switch, this device can be controlled by automation or the App.
- 2、 To avoid damaging the equipment and causing danger, it is forbidden to connect S1 to strong electricity such as neutral wire or earth wire or to connect S2 to strong electricity such as live wire, neutral wire, earth wire and etc.
- 3、 Make sure all wires are connected correctly.

## Pair with eWeLink App

### 1. Download the eWeLink App

Please download the "eWeLink" App from Google Play Store or Apple App Store.



## 2. Power on

After powering on, the device will enter the Bluetooth Pairing Mode defaulted during the first use, and the Network indicator flashes in a cycle of two short and one long.

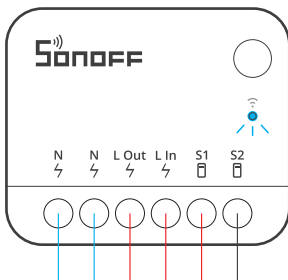

- ⓘ The device will exit the Bluetooth Pairing Mode if not been paired within 10mins. If you want to enter this mode again, please long press the button for 5s until the Network indicator flashes in a cycle of two short and one long and then release.

## 3. Add device

Tap "+" and select "Bluetooth Pairing", then operate following the prompt on the App.

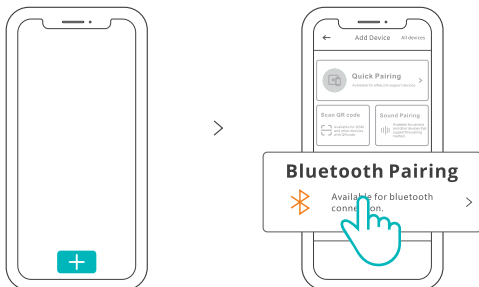

## Add eWeLink-Remote Sub-devices

Enter the Device Settings page on the eWeLink App, select "eWeLink-Remote sub-devices" and tap "Add", then trigger the sub-device to add it successfully.

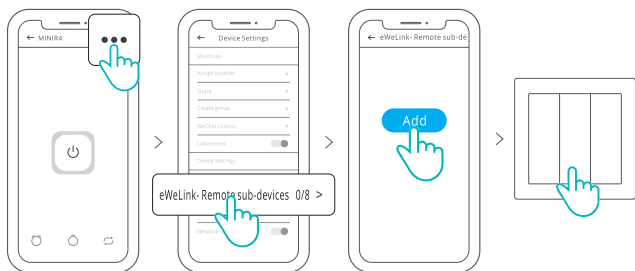

## Install the MINI Extreme in the mounting box

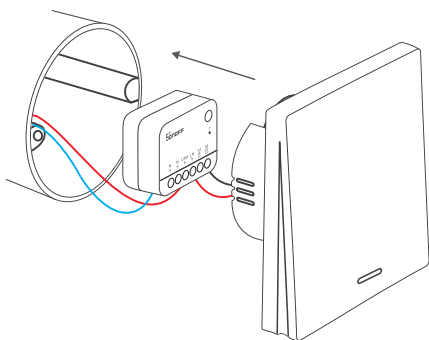

## Specifications

Model	MINIR4
Input	100-240V ~ 50/60Hz 10A Max
Output	100-240V ~ 50/60Hz 10A Max
Max. power	2400W
Wi-Fi	IEEE 802.11b/g/n 2.4GHz
Working temperature	-10°C-40°C
Working humidity	5%-95% RH, non-condensing
Casing material	PC V0
Dimension	39.5x33x16.8mm

## Device Network Changing

Change the device's network by "Wi-Fi Settings" in the "Device Settings" page on the eWeLink App.

## Factory Reset

Reset the device to factory settings by "Delete device" on the eWeLink App.

## FAQ (Frequently Asked Questions)

### 1. Fail to pair Wi-Fi devices with the eWeLink App

1、 Make sure the device is in pairing mode.

The device will automatically exit the pairing mode if it is not paired within 10mins.

2、 Please enable location service and allow access to location permission.

Before connecting Wi-Fi network, please enable the location service and allow access to the location permission. Location information permission is used to obtain Wi-Fi list information, if you "disable" the location service, the device cannot be paired.

3. Make sure your Wi-Fi works on 2.4GHz band.
4. Make sure to enter the Wi-Fi SSID and password correctly without special characters. Incorrect password is a common cause of pairing failure.
5. To ensure good signal transmission while pairing, please place the device close to the router.

## 2. The LED indicator flashes twice on repeated means the server fails to connect.

1. Make sure the networking is normal. Check the internet works well by connecting your phone or PC. If fail to connect, please check the availability of the Internet connection.
2. With the low load capacity of the router, the connected devices exceed the router's maximum load capacity. Please check the maximum number of devices that your router can carry, if the connected devices exceed the maximum value, remove some devices or use a higher load capacity router.

ⓘ If the above methods cannot help to solve the problem, please submit your problem to "Help & Feedback" on the eWeLink App.

## 3. Wi-Fi devices are "offline"

1. Devices fail to connect to the router.
2. Entered the wrong Wi-Fi SSID and password.
3. Wi-Fi SSID and password contain special characters, for example, our system can't recognize Hebrew and Arabic characters, which causes Wi-Fi connections to fail.
4. Low capacity of the router.
5. Wi-Fi signal is weak. The router and the devices are too far apart, or there is an obstacle between the router and the device, which prevents the signal from being transmitted.

## FCC Warning

Changes or modifications not expressly approved by the party responsible for compliance could avoid the user's authority to operate the equipment.

This device complies with part 15 of the FCC Rules. Operation is subject to the following two conditions: (1) This device may not cause harmful interference, and (2) this device must accept any interference received, including interference that may cause undesired operation.

### **FCC Radiation Exposure Statement:**

This equipment complies with FCC radiation exposure limits set forth for an uncontrolled environment. This equipment should be installed and operated with minimum distance 20cm between the radiator& your body.This transmitter must not be co-located or operating in conjunction with any other antenna or transmitter.

### **Note:**

This equipment has been tested and found to comply with the limits for a Class B digital device, pursuant to part 15 of the FCC Rules. These limits are designed to provide reasonable protection against harmful interference in a residential installation. This equipment generates, uses and can radiate radio frequency energy and, if not installed and used in accordance with the instructions, may cause harmful interference to radio communications. However, there is no guarantee that interference will not occur in a particular installation. If this equipment does cause harmful interference to radio or television reception, which can be determined by turning the equipment off and on, the user is encouraged to try to correct the interference by one or more of the following measures:

- Reorient or relocate the receiving antenna.
- Increase the separation between the equipment and receiver.
- Connect the equipment into an outlet on a circuit different from that to which the receiver is connected.
- Consult the dealer or an experienced radio/TV technician for help.



## IC Warning

This device complies with Innovation, Science and Economic Development Canada licence-exempt RSS standard (s). Operation is subject to the following two conditions: (1) this device may not cause interference, and (2) this device must accept any interference, including interference that may cause undesired operation of the device.

Le onjunc areil est conforme aux CNR d' l'innovation, la science et le développement économique Canada licables aux areils radio exempts de licence.

L'exploitation est autorisée aux deux conditions suivantes:

(1) l'areil ne doit pas produire de brouillage, et

(2) l'utilisateur de l'appareil doit accepter tout brouillage radioélectrique subi, onj si le brouillage est susceptible d'en compromettre le fonctionnement.

Any changes or modifications not expressly approved by the party responsible for compliance could void the user's authority to operate the equipment.

Tous les changements ou modifications non expressément approuvée par le responsable de la conformité pourrait vider l'utilisateur est habilité à exploiter l'équipemen.

### **IC exposition aux radiations:**

This equipment complies with ISEDC RF radiation exposure limits set forth for an uncontrolled environment. This transmitter must not be co-located or operating in conjunction with any other antenna or transmitter. This equipment should be installed and operated with minimum distance 20cm between the radiator& your body.

### **IC exposition aux radiations:**

Cet équipement est conforme avec ISEDC les limites d'exposition aux rayonnements définies pour un contrôlé environnement.

Cet émetteur ne doit pas être co-localisés ou fonctionner en conjonction avec une autre antenne ou émetteur. Cet équipement doit être installé et utilisé avec une distance minimale de 20cm entre le radiateur & votre corps.

Hereby, Shenzhen Sonoff Technologies Co., Ltd. declares that the radio equipment type MINIR4 is in compliance with Directive 2014/53/EU. The full text of the EU declaration of conformity is available at the following internet address:

<https://sonoff.tech/usermanuals>

**For CE Frequency:**

**Operation frequency Range:**

2402-2480MHz(BLE)

2412-2472MHz(Wi-Fi)

**RF Output Power:**

2dBm(BLE)

15dBm(802.11b),14dBm(802.11g),15dBm(802.11n20),

16dBm(802.11n40)(Wi-Fi)



# SONOFF

**Shenzhen Sonoff Technologies Co., Ltd.**

3F & 6F, Bldg A, No. 663, Bulong Rd, Shenzhen, Guangdong, China

ZIP code: 518000

Website: [sonoff.tech](https://sonoff.tech)

MADE IN CHINA

