

**ELECTROMAGNETIC EMISSIONS
COMPLIANCE REPORT**

Applicant: Arlo Technologies Inc
2200 Faraday Avenue, Suite 150, Carlsbad, CA 92008, USA

Product Name: Go 2 LTE/Wi-Fi Security Camera

Brand Name: Arlo

Model No.: VML2030

Model Difference: N/A

Report Number: ER/2021/70075

FCC ID 2APLE18300421

IC: 23815-18300421

Issue Date: August 23, 2021

Date of Test: July 23, 2021 ~ August 12, 2021

Date of EUT Received: July 22, 2021

Approved By _____

Jet Lu

Jet Lu

We hereby certify that:

The above equipment was tested by SGS Taiwan Ltd. Central RF Lab The test data, data evaluation, test procedures, and equipment configurations shown in this report were made in accordance with the procedures given in ANSI C63.26-2015 and the energy emitted by the sample EUT comply with FCC rule part 2 , 22H & 24E & 27 C & 90S and ISSED RSS-Gen, 132, 133.

The results of this report relate only to the sample identified in this report.

Unless otherwise stated the results shown in this test report refer only to the sample(s) tested and such sample(s) are retained for 90 days only.

除非另有說明，此報告結果僅對測試之樣品負責，同時此樣品僅保留90天。本報告未經本公司書面許可，不可部份複製。

This document is issued by the Company subject to its General Conditions of Service printed overleaf, available on request or accessible at <http://www.sgs.com.tw/Terms-and-Conditions> and for electronic format documents, subject to Terms and Conditions for Electronic Documents at <http://www.sgs.com.tw/Terms-and-Conditions>. Attention is drawn to the limitation of liability, indemnification and jurisdiction issues defined therein. Any holder of this document is advised that information contained hereon reflects the Company's findings at the time of its intervention only and within the limits of Client's instructions, if any. The Company's sole responsibility is to its Client and this document does not exonerate parties to a transaction from exercising all their rights and obligations under the transaction documents. This document cannot be reproduced except in full, without prior written approval of the Company. Any unauthorized alteration, forgery or falsification of the content or appearance of this document is unlawful and offenders may be prosecuted to the fullest extent of the law.

Revision History				
Report Number	Revision	Description	Issue Date	Revised By
ER/2021/70075	00	Original	August 23, 2021	Ariel Chang

Note:

1. Antenna information is provided by the applicant, test results of this report are applicable to the sample EUT received.

Unless otherwise stated the results shown in this test report refer only to the sample(s) tested and such sample(s) are retained for 90 days only.

除非另有說明，此報告結果僅對測試之樣品負責，同時此樣品僅保留90天。本報告未經本公司書面許可，不可部份複製。

This document is issued by the Company subject to its General Conditions of Service printed overleaf, available on request or accessible at <http://www.sgs.com.tw/Terms-and-Conditions> and for electronic format documents, subject to Terms and Conditions for Electronic Documents at <http://www.sgs.com.tw/Terms-and-Conditions>. Attention is drawn to the limitation of liability, indemnification and jurisdiction issues defined therein. Any holder of this document is advised that information contained hereon reflects the Company's findings at the time of its intervention only and within the limits of Client's instructions, if any. The Company's sole responsibility is to its Client and this document does not exonerate parties to a transaction from exercising all their rights and obligations under the transaction documents. This document cannot be reproduced except in full, without prior written approval of the Company. Any unauthorized alteration, forgery or falsification of the content or appearance of this document is unlawful and offenders may be prosecuted to the fullest extent of the law.

Contents

1	GENERAL PRODUCT INFORMATION.....	4
2	SYSTEM TEST CONFIGURATION.....	10
3	SUMMARY OF TEST RESULTS.....	14
4	DESCRIPTION OF TEST MODES.....	15
5	MEASUREMENT UNCERTAINTY	17
6	MAXMUM OUTPUT POWER.....	18
7	FIELD STRENGTH OF SPURIOUS RADIATION MEASUREMENT	56

Unless otherwise stated the results shown in this test report refer only to the sample(s) tested and such sample(s) are retained for 90 days only.

除非另有說明，此報告結果僅對測試之樣品負責，同時此樣品僅保留90天。本報告未經本公司書面許可，不可部份複製。

This document is issued by the Company subject to its General Conditions of Service printed overleaf, available on request or accessible at <http://www.sgs.com.tw/Terms-and-Conditions> and for electronic format documents, subject to Terms and Conditions for Electronic Documents at <http://www.sgs.com.tw/Terms-and-Conditions>. Attention is drawn to the limitation of liability, indemnification and jurisdiction issues defined therein. Any holder of this document is advised that information contained hereon reflects the Company's findings at the time of its intervention only and within the limits of Client's instructions, if any. The Company's sole responsibility is to its Client and this document does not exonerate parties to a transaction from exercising all their rights and obligations under the transaction documents. This document cannot be reproduced except in full, without prior written approval of the Company. Any unauthorized alteration, forgery or falsification of the content or appearance of this document is unlawful and offenders may be prosecuted to the fullest extent of the law.

1 GENERAL PRODUCT INFORMATION

1.1 Product Description

Product Name:	Go 2 LTE/Wi-Fi Security Camera	
Brand Name:	Arlo	
Model No.:	VML2030	
Model Difference:	N/A	
Hardware Version:	H4	
Firmware Version:	EC25AF.R07.A09	
EUT Series No.:	A8KU167EA009D	
WWAN Module	Module No.: EC25-AF Supplier: Quectel Wireless Solutions Company Limited	
Power Supply:	3.6Vdc from Rechargeable Li-polymer Battery or 5 / 9 / 12 / 15 / 20Vdc from AC/DC Adapter	
	Battery	Model No.: A-14 Supplier: Celxpert
IMEI:	356766550002865	

Unless otherwise stated the results shown in this test report refer only to the sample(s) tested and such sample(s) are retained for 90 days only.

除非另有說明，此報告結果僅對測試之樣品負責，同時此樣品僅保留90天。本報告未經本公司書面許可，不可部份複製。

This document is issued by the Company subject to its General Conditions of Service printed overleaf, available on request or accessible at <http://www.sgs.com.tw/Terms-and-Conditions> and for electronic format documents, subject to Terms and Conditions for Electronic Documents at <http://www.sgs.com.tw/Terms-and-Conditions>. Attention is drawn to the limitation of liability, indemnification and jurisdiction issues defined therein. Any holder of this document is advised that information contained hereon reflects the Company's findings at the time of its intervention only and within the limits of Client's instructions, if any. The Company's sole responsibility is to its Client and this document does not exonerate parties to a transaction from exercising all their rights and obligations under the transaction documents. This document cannot be reproduced except in full, without prior written approval of the Company. Any unauthorized alteration, forgery or falsification of the content or appearance of this document is unlawful and offenders may be prosecuted to the fullest extent of the law.

1.2 Operation Frequency Range

Operating Frequency (MHz)		
WCDMA / HSPA+ Band II	1852.4	- 1907.6
WCDMA / HSPA+ Band IV	1712.4	- 1752.6
WCDMA / HSPA+ Band V	826.4	- 846.6

LTE Band 2		
BW (MHz)	Operation Frequency (MHz)	
1.4	1850.7	- 1909.3
3	1851.5	- 1908.5
5	1852.5	- 1907.5
10	1855.0	- 1905.0
15	1857.5	- 1902.5
20	1860.0	- 1900.0
LTE Band 4		
BW (MHz)	Operation Frequency (MHz)	
1.4	1710.7	- 1754.3
3	1711.5	- 1753.5
5	1712.5	- 1752.5
10	1715.0	- 1750.0
15	1717.5	- 1747.5
20	1720.0	- 1745.0
LTE Band 5		
BW (MHz)	Operation Frequency (MHz)	
1.4	824.7	- 848.3
3	825.5	- 847.5
5	826.5	- 846.5
10	829.0	- 844.0
LTE Band 12		
BW (MHz)	Operation Frequency (MHz)	
1.4	699.7	- 715.3
3	700.5	- 714.5
5	701.5	- 713.5
10	704.0	- 711.0

LTE Band 13		
BW (MHz)	Operation Frequency (MHz)	
5	779.5	- 784.5
10	782	
LTE Band 14		
BW (MHz)	Operation Frequency (MHz)	
5	790.5	- 795.5
10	793	
LTE Band 66		
BW (MHz)	Operation Frequency (MHz)	
1.4	1710.7	- 1779.3
3	1711.5	- 1778.5
5	1712.5	- 1777.5
10	1715.0	- 1775.0
15	1717.5	- 1772.5
20	1720.0	- 1770.0
LTE Band 71		
BW (MHz)	Operation Frequency (MHz)	
5	665.5	- 695.5
10	688.0	- 693.0
15	670.5	- 690.5
20	673.0	- 688.0

Unless otherwise stated the results shown in this test report refer only to the sample(s) tested and such sample(s) are retained for 90 days only.

除非另有說明，此報告結果僅對測試之樣品負責，同時此樣品僅保留90天。本報告未經本公司書面許可，不可部份複製。

This document is issued by the Company subject to its General Conditions of Service printed overleaf, available on request or accessible at <http://www.sgs.com.tw/Terms-and-Conditions> and for electronic format documents, subject to Terms and Conditions for Electronic Documents at <http://www.sgs.com.tw/Terms-and-Conditions>. Attention is drawn to the limitation of liability, indemnification and jurisdiction issues defined therein. Any holder of this document is advised that information contained hereon reflects the Company's findings at the time of its intervention only and within the limits of Client's instructions, if any. The Company's sole responsibility is to its Client and this document does not exonerate parties to a transaction from exercising all their rights and obligations under the transaction documents. This document cannot be reproduced except in full, without prior written approval of the Company. Any unauthorized alteration, forgery or falsification of the content or appearance of this document is unlawful and offenders may be prosecuted to the fullest extent of the law.

1.3 Antenna Designation

Antenna Type	Antenna Model No.
PIFA	Ant0
Note: Transmission in frequencies in this test report are only available by the above antenna(s).	

Type	Modulation	Frequency (MHz)			Peak Antenna Gain (dBi)
					Ant0
PIFA	WCDMA / HSPA Band II	1850	~	1910	3.00
	WCDMA / HSPA Band IV	1710	~	1755	2.50
	WCDMA / HSPA Band V	824	~	849	0.30
	LTE-Band 2	1850	~	1910	3.00
	LTE-Band 4	1710	~	1755	2.50
	LTE-Band 5	824	~	849	0.30
	LTE-Band 12	699	~	716	0.00
	LTE-Band 13	777	~	787	-0.80
	LTE-Band 14	788	~	798	-1.10
	LTE-Band 66	1710	~	1780	2.50
	LTE-Band 71	663	~	698	-1.10

Note: Antenna information is provided by the applicant.

Unless otherwise stated the results shown in this test report refer only to the sample(s) tested and such sample(s) are retained for 90 days only.

除非另有說明，此報告結果僅對測試之樣品負責，同時此樣品僅保留90天。本報告未經本公司書面許可，不可部份複製。

This document is issued by the Company subject to its General Conditions of Service printed overleaf, available on request or accessible at <http://www.sgs.com.tw/Terms-and-Conditions> and for electronic format documents, subject to Terms and Conditions for Electronic Documents at <http://www.sgs.com.tw/Terms-and-Conditions>. Attention is drawn to the limitation of liability, indemnification and jurisdiction issues defined therein. Any holder of this document is advised that information contained hereon reflects the Company's findings at the time of its intervention only and within the limits of Client's instructions, if any. The Company's sole responsibility is to its Client and this document does not exonerate parties to a transaction from exercising all their rights and obligations under the transaction documents. This document cannot be reproduced except in full, without prior written approval of the Company. Any unauthorized alteration, forgery or falsification of the content or appearance of this document is unlawful and offenders may be prosecuted to the fullest extent of the law.

1.4 Test Methodology of Applied Standards

FCC 47 CFR Part 2, 24E, 27C, Part 90.

ISED RSS-130 Issue 2 Feb. 2019,

ISED RSS-133 Issue 6, Amendment 1 Jan. 18, 2018,

ISED RSS-140 Issue 1 Apr. 2018,

ISED RSS-132 Issue 3 Dec. 2016

ISED RSS-132 Issue 3 Jan. 2013

ISED RSS-139 Issue 3 July 16, 2015

ISED RSS-132 Issue 3 Dec. 2016

Unless otherwise stated the results shown in this test report refer only to the sample(s) tested and such sample(s) are retained for 90 days only.

除非另有說明，此報告結果僅對測試之樣品負責，同時此樣品僅保留90天。本報告未經本公司書面許可，不可部份複製。

This document is issued by the Company subject to its General Conditions of Service printed overleaf, available on request or accessible at <http://www.sgs.com.tw/Terms-and-Conditions> and for electronic format documents, subject to Terms and Conditions for Electronic Documents at <http://www.sgs.com.tw/Terms-and-Conditions>. Attention is drawn to the limitation of liability, indemnification and jurisdiction issues defined therein. Any holder of this document is advised that information contained hereon reflects the Company's findings at the time of its intervention only and within the limits of Client's instructions, if any. The Company's sole responsibility is to its Client and this document does not exonerate parties to a transaction from exercising all their rights and obligations under the transaction documents. This document cannot be reproduced except in full, without prior written approval of the Company. Any unauthorized alteration, forgery or falsification of the content or appearance of this document is unlawful and offenders may be prosecuted to the fullest extent of the law.

1.5 Test Facility

Laboratory	Test Site Address	Test Site Name	FCC Designation number	IC CAB identifier
SGS Taiwan Ltd. Central RF Lab. (TAF code 3702)	No.134, Wu Kung Road, New Taipei Industrial Park, Wuku District, New Taipei City, Taiwan.	SAC 1	TW0027	TW3702
		SAC 3		
		Conduction 1		
		Conducted 1		
		Conducted 2		
		Conducted 3		
		Conducted 4		
		Conducted 5		
	Conducted 6			
	No.2, Keji 1st Rd., Guishan District, Taoyuan City, Taiwan 333	Conduction C	TW0028	
		SAC C		
		SAC D		
		SAC G		
		Conducted A		
		Conducted B		
		Conducted C		
		Conducted D		
		Conducted E		
		Conducted F		
Conducted G				

Note: Test site name is remarked on the equipment list in each section of this report as an indication where measurements occurred in specific test site and address.

Unless otherwise stated the results shown in this test report refer only to the sample(s) tested and such sample(s) are retained for 90 days only.

除非另有說明，此報告結果僅對測試之樣品負責，同時此樣品僅保留90天。本報告未經本公司書面許可，不可部份複製。

This document is issued by the Company subject to its General Conditions of Service printed overleaf, available on request or accessible at <http://www.sgs.com.tw/Terms-and-Conditions> and for electronic format documents, subject to Terms and Conditions for Electronic Documents at <http://www.sgs.com.tw/Terms-and-Conditions>. Attention is drawn to the limitation of liability, indemnification and jurisdiction issues defined therein. Any holder of this document is advised that information contained hereon reflects the Company's findings at the time of its intervention only and within the limits of Client's instructions, if any. The Company's sole responsibility is to its Client and this document does not exonerate parties to a transaction from exercising all their rights and obligations under the transaction documents. This document cannot be reproduced except in full, without prior written approval of the Company. Any unauthorized alteration, forgery or falsification of the content or appearance of this document is unlawful and offenders may be prosecuted to the fullest extent of the law.

1.6 Special Accessories

No special accessories were used during testing.

1.7 Equipment Modifications

There was no modifications incorporated into the EUT.

1.8 Radiated Emission Test Sites For Measurements From 9 kHz To 30 MHz

Radiated emission below 30MHz is measured in a 9m*9m*6m semi-anechoic chamber, the measurements correspond to those obtained at an open-field test site.

There is a comparison data of both open-field test site and semi-Anechoic chamber, and the result came out very similar.

Unless otherwise stated the results shown in this test report refer only to the sample(s) tested and such sample(s) are retained for 90 days only.
除非另有說明，此報告結果僅對測試之樣品負責，同時此樣品僅保留90天。本報告未經本公司書面許可，不可部份複製。

This document is issued by the Company subject to its General Conditions of Service printed overleaf, available on request or accessible at <http://www.sgs.com.tw/Terms-and-Conditions> and for electronic format documents, subject to Terms and Conditions for Electronic Documents at <http://www.sgs.com.tw/Terms-and-Conditions>. Attention is drawn to the limitation of liability, indemnification and jurisdiction issues defined therein. Any holder of this document is advised that information contained hereon reflects the Company's findings at the time of its intervention only and within the limits of Client's instructions, if any. The Company's sole responsibility is to its Client and this document does not exonerate parties to a transaction from exercising all their rights and obligations under the transaction documents. This document cannot be reproduced except in full, without prior written approval of the Company. Any unauthorized alteration, forgery or falsification of the content or appearance of this document is unlawful and offenders may be prosecuted to the fullest extent of the law.

2 SYSTEM TEST CONFIGURATION

2.1 EUT Configuration

The EUT configuration for testing is installed on RF field strength measurement to meet the Commissions requirement and operating in a manner which intends to maximize its emission characteristics in a continuous normal application.

2.2 EUT Exercise

The EUT (Transmitter) was operated in the continuous transmission mode employed with the simulator of the Base Station that fixates at test default channels to fix the Tx frequency which was for the purpose of the measurements.

2.3 Test Procedure

2.3.1 Radiated Emissions (ERP/EIRP)

The EUT is placed on a turn table, for emission measurements below 1 GHz is 0.8 m above ground plane, for emission measurements above 1 GHz, the table height shall be 1.5 m. The turn table shall rotate 360 degrees to determine the position of maximum emission level. EUT is set 3m away from the receiving antenna which varied from 1m to 4m to find out the highest emission. And also, each emission was to be maximized by changing the polarization of receiving antenna both Horizontal and Vertical. In order to find out the max. emission, the relative positions of this hand-held transmitter (EUT) was rotated through three orthogonal axes and measurement procedures for electric field radiated emissions above 1 GHz the EUT measurement is to be made "while keeping the antenna in the 'cone of radiation' from that area and pointed at the area both in azimuth and elevation, with polarization oriented for maximum response." is still within the 3dB illumination BW of the measurement antenna.

Unless otherwise stated the results shown in this test report refer only to the sample(s) tested and such sample(s) are retained for 90 days only.

除非另有說明，此報告結果僅對測試之樣品負責，同時此樣品僅保留90天。本報告未經本公司書面許可，不可部份複製。

This document is issued by the Company subject to its General Conditions of Service printed overleaf, available on request or accessible at <http://www.sgs.com.tw/Terms-and-Conditions> and for electronic format documents, subject to Terms and Conditions for Electronic Documents at <http://www.sgs.com.tw/Terms-and-Conditions>. Attention is drawn to the limitation of liability, indemnification and jurisdiction issues defined therein. Any holder of this document is advised that information contained hereon reflects the Company's findings at the time of its intervention only and within the limits of Client's instructions, if any. The Company's sole responsibility is to its Client and this document does not exonerate parties to a transaction from exercising all their rights and obligations under the transaction documents. This document cannot be reproduced except in full, without prior written approval of the Company. Any unauthorized alteration, forgery or falsification of the content or appearance of this document is unlawful and offenders may be prosecuted to the fullest extent of the law.

2.4 Measurement Results Explanation Example

For all conducted test items:

The offset level is set in the spectrum analyzer to compensate the RF cable loss and attenuation factor between EUT conducted port and spectrum analyzer. With the offset compensation, the spectrum analyzer reading level is exactly EUT RF output level.

Note:

The spectrum analyzer offset is derived from RF cable loss and attenuator factor. Following shows an offset computation in physical test.

3G

Frequency	RF Cable loss (dB)	Attenuation (dB)	Offset (dB)
LB(1GHz below)	3.83	10	13.83
MB(1GHz - 2GHz)	4.01	10	14.01

4G

Frequency	RF Cable loss (dB)	Attenuation (dB)	Offset (dB)
LB(1GHz below)	3.83	10	13.83
MB(1GHz - 2GHz)	4.01	10	14.01
MB(2GHz - 3GHz)	4.42	10	14.42

Unless otherwise stated the results shown in this test report refer only to the sample(s) tested and such sample(s) are retained for 90 days only.

除非另有說明，此報告結果僅對測試之樣品負責，同時此樣品僅保留90天。本報告未經本公司書面許可，不可部份複製。

This document is issued by the Company subject to its General Conditions of Service printed overleaf, available on request or accessible at <http://www.sgs.com.tw/Terms-and-Conditions> and for electronic format documents, subject to Terms and Conditions for Electronic Documents at <http://www.sgs.com.tw/Terms-and-Conditions>. Attention is drawn to the limitation of liability, indemnification and jurisdiction issues defined therein. Any holder of this document is advised that information contained hereon reflects the Company's findings at the time of its intervention only and within the limits of Client's instructions, if any. The Company's sole responsibility is to its Client and this document does not exonerate parties to a transaction from exercising all their rights and obligations under the transaction documents. This document cannot be reproduced except in full, without prior written approval of the Company. Any unauthorized alteration, forgery or falsification of the content or appearance of this document is unlawful and offenders may be prosecuted to the fullest extent of the law.

2.5 Final Amplifier Voltage and Current Information:

Test Mode	DC voltage (V)	DC current (mA)
WCDMA / HSPA Band II	3.6	13000
WCDMA / HSPA Band IV		13000
WCDMA / HSPA Band V		13000
LTE Band 2		13000
LTE Band 4		13000
LTE Band 5		13000
LTE Band 12		13000
LTE Band 13		13000
LTE Band 14		13000
LTE Band 66		13000
LTE Band 71		13000

Unless otherwise stated the results shown in this test report refer only to the sample(s) tested and such sample(s) are retained for 90 days only.

除非另有說明，此報告結果僅對測試之樣品負責，同時此樣品僅保留90天。本報告未經本公司書面許可，不可部份複製。

This document is issued by the Company subject to its General Conditions of Service printed overleaf, available on request or accessible at <http://www.sgs.com.tw/Terms-and-Conditions> and for electronic format documents, subject to Terms and Conditions for Electronic Documents at <http://www.sgs.com.tw/Terms-and-Conditions>. Attention is drawn to the limitation of liability, indemnification and jurisdiction issues defined therein. Any holder of this document is advised that information contained hereon reflects the Company's findings at the time of its intervention only and within the limits of Client's instructions, if any. The Company's sole responsibility is to its Client and this document does not exonerate parties to a transaction from exercising all their rights and obligations under the transaction documents. This document cannot be reproduced except in full, without prior written approval of the Company. Any unauthorized alteration, forgery or falsification of the content or appearance of this document is unlawful and offenders may be prosecuted to the fullest extent of the law.

2.6 Test Configuration

2.6.1 Conducted _3G

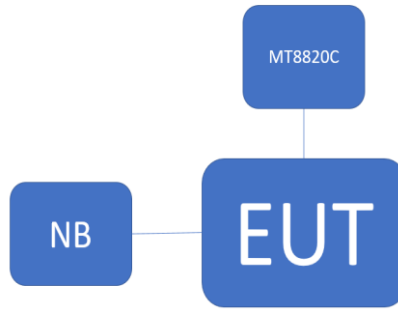

2.6.2 Conducted _4G

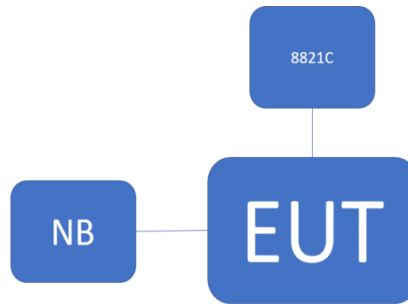

2.6.3 Radiated Emission

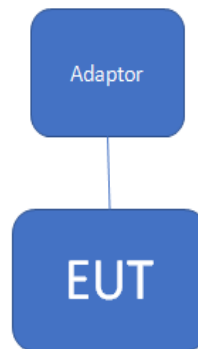

2.6.1 Equipment used for test

Equipment	Mfr/Brand	Model/Type No.	Series No.
Tera Term	N/A	N/A	4.105.0.0
Adaptor	arlo	AD2151320	N/A
Notebook	Lenovo	L480	PF-1S9NT5
1M USB	Baoyuanda	B015W003	N/A

Unless otherwise stated the results shown in this test report refer only to the sample(s) tested and such sample(s) are retained for 90 days only.

除非另有說明，此報告結果僅對測試之樣品負責，同時此樣品僅保留90天。本報告未經本公司書面許可，不可部份複製。

This document is issued by the Company subject to its General Conditions of Service printed overleaf, available on request or accessible at <http://www.sgs.com.tw/Terms-and-Conditions> and for electronic format documents, subject to Terms and Conditions for Electronic Documents at <http://www.sgs.com.tw/Terms-and-Conditions>. Attention is drawn to the limitation of liability, indemnification and jurisdiction issues defined therein. Any holder of this document is advised that information contained herein reflects the Company's findings at the time of its intervention only and within the limits of Client's instructions, if any. The Company's sole responsibility is to its Client and this document does not exonerate parties to a transaction from exercising all their rights and obligations under the transaction documents. This document cannot be reproduced except in full, without prior written approval of the Company. Any unauthorized alteration, forgery or falsification of the content or appearance of this document is unlawful and offenders may be prosecuted to the fullest extent of the law.

3 SUMMARY OF TEST RESULTS

FCC Rules	IC Rules	Description Of Test	Result
§2.1046(a)	RSS-GEN §6.12	RF Power Output	Compliant
§22.913(a)(5) §27.50(a)(3) §27.50(c)(10) §27.50(d)(4)	RSS-GEN §6.13 RSS-130 §4.6 RSS-132 §5.5 RSS-133 §6.5 RSS-139 §6.6 RSS-140 §4.4	ERP/ EIRP measurement	N/A
§2.1049(h)	RSS-GEN §6.7	99% & 26dB Occupied Bandwidth	N/A
§2.1051 §22.917(a) §24.238(a) §27.50(c)(5) §27.53(c) §27.53(g) §27.53(h)	RSS-GEN §6.13 RSS-130 §4.6 RSS-139 §6.5	Out of Band Emissions at Antenna Terminals and Band Edge / Emission mask requirements	N/A
§2.1053 §22.917(a) §24.238(a) §27.53(c) §27.50(c)(10) §27.53(f) §27.53(g) §27.53(h)	RSS-GEN §6.13 RSS-130 §4.7 RSS-132 §5.5 RSS-133 §6.5 RSS-139 §6.6 RSS-140 §4.4	Field Strength of Spurious Radiation	Compliant
§24.232(d) §27.50(a)(1)(B)	RSS-130 §4.6.1 RSS-132 §5.4 RSS-133 §6.4 RSS-139 §6.4 RSS-140 §4.3	Peak to Average Ratio	N/A
§2.1055(a)(1) §24.235 §27.54	RSS-130 §4.5 RSS-132 §5.3 RSS-133 §6.3 RSS-139 §6.5 RSS-140 §4.2	Frequency Stability	N/A

Unless otherwise stated the results shown in this test report refer only to the sample(s) tested and such sample(s) are retained for 90 days only.

除非另有說明，此報告結果僅對測試之樣品負責，同時此樣品僅保留90天。本報告未經本公司書面許可，不可部份複製。

This document is issued by the Company subject to its General Conditions of Service printed overleaf, available on request or accessible at <http://www.sgs.com.tw/Terms-and-Conditions> and for electronic format documents, subject to Terms and Conditions for Electronic Documents at <http://www.sgs.com.tw/Terms-and-Conditions>. Attention is drawn to the limitation of liability, indemnification and jurisdiction issues defined therein. Any holder of this document is advised that information contained hereon reflects the Company's findings at the time of its intervention only and within the limits of Client's instructions, if any. The Company's sole responsibility is to its Client and this document does not exonerate parties to a transaction from exercising all their rights and obligations under the transaction documents. This document cannot be reproduced except in full, without prior written approval of the Company. Any unauthorized alteration, forgery or falsification of the content or appearance of this document is unlawful and offenders may be prosecuted to the fullest extent of the law.

4 DESCRIPTION OF TEST MODES

4.1 The Worst Test Modes and Channel Details

1. The EUT has been tested under operating condition.
2. Pre-Scan has been conducted to determine the worst-case mode from all possible combinations between available modulations, data rates, X(E1)Y(E2)Z(H) axis and antenna ports. The worst case was found as listed below. Following channel(s) was (were) selected for the final test as listed below:

BAND	H PLANE	E1 PLANE	E2 PLANE
WCDMA / HSPA Band II	V		
WCDMA / HSPA Band IV	V		
WCDMA / HSPA Band V	V		
LTE Band 2	V		
LTE Band 4	V		
LTE Band 5	V		
LTE Band 12	V		
LTE Band 13	V		
LTE Band 14	V		
LTE Band 66	V		
LTE Band 71	V		

Unless otherwise stated the results shown in this test report refer only to the sample(s) tested and such sample(s) are retained for 90 days only.

除非另有說明，此報告結果僅對測試之樣品負責，同時此樣品僅保留90天。本報告未經本公司書面許可，不可部份複製。

This document is issued by the Company subject to its General Conditions of Service printed overleaf, available on request or accessible at <http://www.sgs.com.tw/Terms-and-Conditions> and for electronic format documents, subject to Terms and Conditions for Electronic Documents at <http://www.sgs.com.tw/Terms-and-Conditions>. Attention is drawn to the limitation of liability, indemnification and jurisdiction issues defined therein. Any holder of this document is advised that information contained hereon reflects the Company's findings at the time of its intervention only and within the limits of Client's instructions, if any. The Company's sole responsibility is to its Client and this document does not exonerate parties to a transaction from exercising all their rights and obligations under the transaction documents. This document cannot be reproduced except in full, without prior written approval of the Company. Any unauthorized alteration, forgery or falsification of the content or appearance of this document is unlawful and offenders may be prosecuted to the fullest extent of the law.

4.2 Measurement Configuration

Test Items	WCDMA / HSPA Bands	Test Channel		
		L	M	H
ERP	Band V	v	v	v
EIRP	Band II	v	v	v
	Band IV	v	v	v
RADIATED EMISSION	Band II			v
	Band IV	v		
	Band V	v		

Test Items	Band	Test Channel			Bandwidth (MHz)						Modulation				RB #		
		L	M	H	1.4	3	5	10	15	20	QPSK	16QAM	64QAM	256QAM	1	Half	Full
Max. Output Power	2	v	v	v	v	v	v	v	v	v	v	v	v	v	v	v	v
	4	v	v	v	v	v	v	v	v	v	v	v	v	v	v	v	v
	5	v	v	v	v	v	v	v	-	-	v	v			v	v	v
	12	v	v	v	v	v	v	v	-	-	v	v			v	v	v
	13	v	v	v	-	-	v	v	-	-	v	v			v	v	v
	14	v	v	v	-	-	v	v	-	-	v	v			v	v	v
	66	v	v	v	v	v	v	v	v	v	v	v			v	v	v
	71	v	v	v	-	-	v	v	v	v	v	v			v	v	v

Test Items	Band	Test Channel			Bandwidth (MHz)						Modulation				RB #		
		L	M	H	1.4	3	5	10	15	20	QPSK	16QAM	64QAM	256QAM	1	Half	Full
Radiated Emission	2	v	v	v							v						v
	4	v	v	v							v						v
	5	v	v	v							v						v
	12	v	v	v							v						v
	13	v	v	v	-	-	v	v	-	-	v						v
	14	v	v	v	-	-	v	v	-	-	v						v
	66	v	v	v							v						v
	71	v	v	v	-	-	v	v	v	v	v						v

E-UTRA Band	Channel Bandwidth (MHz)	Modulation	Resource Block Allocation	
			RBs allocated	RB Start
2	3	QPSK	1	14
4	15	QPSK	1	0
5	10	QPSK	1	49
12	3	QPSK	1	0
13	5	QPSK	1	24
14	5	QPSK	1	24
66	10	QPSK	1	49
71	10	QPSK	1	49

Unless otherwise stated the results shown in this test report refer only to the sample(s) tested and such sample(s) are retained for 90 days only.

除非另有說明，此報告結果僅對測試之樣品負責，同時此樣品僅保留90天。本報告未經本公司書面許可，不可部份複製。

This document is issued by the Company subject to its General Conditions of Service printed overleaf, available on request or accessible at <http://www.sgs.com.tw/Terms-and-Conditions> and for electronic format documents, subject to Terms and Conditions for Electronic Documents at <http://www.sgs.com.tw/Terms-and-Conditions>. Attention is drawn to the limitation of liability, indemnification and jurisdiction issues defined therein. Any holder of this document is advised that information contained hereon reflects the Company's findings at the time of its intervention only and within the limits of Client's instructions, if any. The Company's sole responsibility is to its Client and this document does not exonerate parties to a transaction from exercising all their rights and obligations under the transaction documents. This document cannot be reproduced except in full, without prior written approval of the Company. Any unauthorized alteration, forgery or falsification of the content or appearance of this document is unlawful and offenders may be prosecuted to the fullest extent of the law.

5 MEASUREMENT UNCERTAINTY

Test Items	Uncertainty
RF Power Output	+/- 1 dB
ERP/ EIRP measurement	+/- 3 dB
	+/- 3 dB
Emission Bandwidth	+/- 1.53 Hz
Out of Band Emissions at Antenna Terminals and Band Edge	+/- 1.69 dB
Peak to Average Ratio	+/- 1 dB
Frequency Stability vs. Temperature	+/- 1.53 Hz
Frequency Stability vs. Voltage	+/- 1.53 Hz
Temperature	+/- 0.4 °C
Humidity	+/- 3.5 %
DC / AC Power Source	+/- 1 %

Radiated Spurious Emission Measurement Uncertainty		
Polarization: Vertical	+/- 2.64 dB	9kHz~30MHz
	+/- 4.93 dB	30MHz - 1000MHz
	+/- 4.81 dB	1GHz - 18GHz
	+/- 4.52 dB	18GHz - 40GHz
Polarization: Horizontal	+/- 2.64 dB	9kHz~30MHz
	+/- 4.45 dB	30MHz - 1000MHz
	+/- 4.81 dB	1GHz - 18GHz
	+/- 4.52 dB	18GHz - 40GHz

This uncertainty represents an expanded uncertainty expressed at approximately the 95% confidence level using a coverage factor of k=2. OCCUPIED BANDWIDTH MEASUREMENT

Unless otherwise stated the results shown in this test report refer only to the sample(s) tested and such sample(s) are retained for 90 days only.

除非另有說明，此報告結果僅對測試之樣品負責，同時此樣品僅保留90天。本報告未經本公司書面許可，不可部份複製。

This document is issued by the Company subject to its General Conditions of Service printed overleaf, available on request or accessible at <http://www.sgs.com.tw/Terms-and-Conditions> and for electronic format documents, subject to Terms and Conditions for Electronic Documents at <http://www.sgs.com.tw/Terms-and-Conditions>. Attention is drawn to the limitation of liability, indemnification and jurisdiction issues defined therein. Any holder of this document is advised that information contained hereon reflects the Company's findings at the time of its intervention only and within the limits of Client's instructions, if any. The Company's sole responsibility is to its Client and this document does not exonerate parties to a transaction from exercising all their rights and obligations under the transaction documents. This document cannot be reproduced except in full, without prior written approval of the Company. Any unauthorized alteration, forgery or falsification of the content or appearance of this document is unlawful and offenders may be prosecuted to the fullest extent of the law.

6 MAXMUM OUTPUT POWER

6.1 Standard Applicable

A base station simulator was used to establish communication with the EUT. Its parameters were set to transmit the maximum power on the EUT. The measured power in the radio frequency on the transmitter output terminals.

6.1.1 ERP/EIRP LIMIT

According to FCC §2.1046

FCC 22.913(a) LTE 5

(5) mobile transmitters and auxiliary test transmitters must not exceed 7 watts.

FCC 24.232(c) LTE 2

Mobile and portable stations are limited to 2 W EIRP.

FCC 27.50 (b) LTE 13

(9) Control stations and mobile stations transmitting in the 746-757 MHz, 776-788 MHz, and 805-806 MHz bands are limited to 30 watts ERP.

FCC 27.50(c) LTE 12 / 71

(9) Control and mobile stations in the 698-746 MHz band are limited to 30 watts ERP.

FCC 27.50(d) LTE 4 / 66

(4) Mobile, and portable (hand-held) stations operating in the 1710-1755 MHz, 1695-1710 MHz and 1755-1780 MHz bands are limited to 1W EIRP.

FCC 90.542(a) LTE 14

(6) Control stations and mobile stations transmitting in the 758-768 MHz band and the 788-798 MHz band are limited to 30 watts ERP.

Unless otherwise stated the results shown in this test report refer only to the sample(s) tested and such sample(s) are retained for 90 days only.

除非另有說明，此報告結果僅對測試之樣品負責，同時此樣品僅保留90天。本報告未經本公司書面許可，不可部份複製。

This document is issued by the Company subject to its General Conditions of Service printed overleaf, available on request or accessible at <http://www.sgs.com.tw/Terms-and-Conditions> and for electronic format documents, subject to Terms and Conditions for Electronic Documents at <http://www.sgs.com.tw/Terms-and-Conditions>. Attention is drawn to the limitation of liability, indemnification and jurisdiction issues defined therein. Any holder of this document is advised that information contained hereon reflects the Company's findings at the time of its intervention only and within the limits of Client's instructions, if any. The Company's sole responsibility is to its Client and this document does not exonerate parties to a transaction from exercising all their rights and obligations under the transaction documents. This document cannot be reproduced except in full, without prior written approval of the Company. Any unauthorized alteration, forgery or falsification of the content or appearance of this document is unlawful and offenders may be prosecuted to the fullest extent of the law.

RSS-130 §4.6

The e.r.p. shall not exceed 3 watts for mobile equipment, fixed subscriber equipment and portable equipment operating in the Band 617-652 and 663-698MHz.

The e.r.p. shall not exceed 3 watts for portable equipment and indoor fixed subscriber equipment operating in 698-756 and 777-787 MHz. **LTE 12 / 13**

RSS-132 §5.4 LTE 5

The equivalent isotropically radiated power (e.i.r.p.) for mobile equipment in operating in the Bands 824-849 and 869-894MHz shall not exceed 11.5 watts.

RSS-133 §6.4 LTE 2

The equivalent isotropically radiated power (e.i.r.p.) for transmitters shall not exceed the limits given in SRSP-510.

According to section 5.1.2 of SRSP-510, Mobile stations and hand-held portables are limited to 2 watts maximum e.i.r.p. The equipment shall employ means to limit the power to the minimum necessary for successful communication.

RSS-139 §6.5 LTE 4 / 66

The equivalent isotropically radiated power (e.i.r.p.) for mobile and portable transmitters in the Bands 1710-1780MHz shall not exceed one watt.

RSS-140 §4.3 LTE 14

The equivalent radiated power (e.r.p.) for control and mobile equipment shall not exceed 30 W. The e.r.p. for portable equipment including handheld devices shall not exceed 3 W.

Unless otherwise stated the results shown in this test report refer only to the sample(s) tested and such sample(s) are retained for 90 days only.

除非另有說明，此報告結果僅對測試之樣品負責，同時此樣品僅保留90天。本報告未經本公司書面許可，不可部份複製。

This document is issued by the Company subject to its General Conditions of Service printed overleaf, available on request or accessible at <http://www.sgs.com.tw/Terms-and-Conditions> and for electronic format documents, subject to Terms and Conditions for Electronic Documents at <http://www.sgs.com.tw/Terms-and-Conditions>. Attention is drawn to the limitation of liability, indemnification and jurisdiction issues defined therein. Any holder of this document is advised that information contained hereon reflects the Company's findings at the time of its intervention only and within the limits of Client's instructions, if any. The Company's sole responsibility is to its Client and this document does not exonerate parties to a transaction from exercising all their rights and obligations under the transaction documents. This document cannot be reproduced except in full, without prior written approval of the Company. Any unauthorized alteration, forgery or falsification of the content or appearance of this document is unlawful and offenders may be prosecuted to the fullest extent of the law.

6.2 Test Set-up

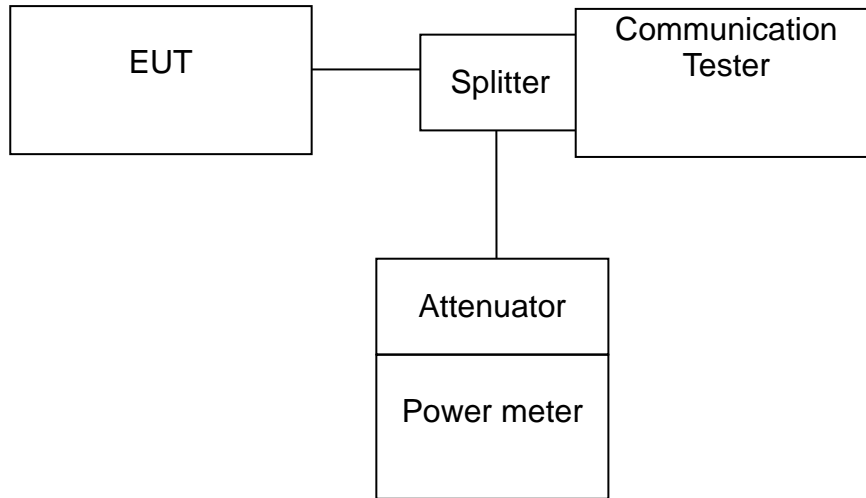

Note: Measurement setup for testing on Antenna connector

6.3 Output Power Measurement Applicable Guidance

The transmitter output was connected to a calibrated attenuator, the other end of which was connected to a power meter. Transmitter output was read off the power meter in dBm. The power output at the transmitter antenna port was determined by adding the value of the attenuator to the power meter reading.

KDB 971168 D01 Power Meas License Digital System as the supplemental test methodology to adjust the proper setting obtaining the measurement results.

All LTE bands conducted average power is obtained from the simulator telecommunication test set.

Unless otherwise stated the results shown in this test report refer only to the sample(s) tested and such sample(s) are retained for 90 days only.

除非另有說明，此報告結果僅對測試之樣品負責，同時此樣品僅保留90天。本報告未經本公司書面許可，不可部份複製。

This document is issued by the Company subject to its General Conditions of Service printed overleaf, available on request or accessible at <http://www.sgs.com.tw/Terms-and-Conditions> and for electronic format documents, subject to Terms and Conditions for Electronic Documents at <http://www.sgs.com.tw/Terms-and-Conditions>. Attention is drawn to the limitation of liability, indemnification and jurisdiction issues defined therein. Any holder of this document is advised that information contained hereon reflects the Company's findings at the time of its intervention only and within the limits of Client's instructions, if any. The Company's sole responsibility is to its Client and this document does not exonerate parties to a transaction from exercising all their rights and obligations under the transaction documents. This document cannot be reproduced except in full, without prior written approval of the Company. Any unauthorized alteration, forgery or falsification of the content or appearance of this document is unlawful and offenders may be prosecuted to the fullest extent of the law.

Determining ERP and/or EIRP from conducted RF output power measurements
According to KDB 412172 D01 Power Approach,

$$EIRP = P_T + G_T - L_C,$$

$$ERP = EIRP - 2.15,$$

Where:

- ERP or EIRP = effective radiated power or equivalent isotropically radiated power (expressed in the same units as P_T , typically dBW, dBm, or power spectral density (PSD)²), relative to either a dipole antenna (ERP) or an isotropic antenna (EIRP);
- P_T = transmitter output power, expressed in dBW, dBm, or PSD;
- G_T = gain of the transmitting antenna, in dBd (ERP) or dBi (EIRP);
- L_C = signal attenuation in the connecting cable between the transmitter and antenna, in dB.

6.4 Measurement Equipment Used

3G

Conducted Emission Test Site: Conducted 4					
EQUIPMENT TYPE	MFR	MODEL NUMBER	SERIAL NUMBER	LAST CAL.	CAL DUE.
Radio Communication Analyser	Anritsu	MT8815B	6200711454	04/07/2021	04/06/2022
Attenuator	Mini-Circuit	BW-S10W2+	4	12/16/2020	12/15/2021

4G

Conducted Emission Test Site: Conducted 4					
EQUIPMENT TYPE	MFR	MODEL NUMBER	SERIAL NUMBER	LAST CAL.	CAL DUE.
Radio Communication Analyser	Anritsu	MT8821C	6261786084	01/20/2021	01/19/2022
Attenuator	Mini-Circuit	BW-S10W2+	4	12/16/2020	12/15/2021

Unless otherwise stated the results shown in this test report refer only to the sample(s) tested and such sample(s) are retained for 90 days only.

除非另有說明，此報告結果僅對測試之樣品負責，同時此樣品僅保留90天。本報告未經本公司書面許可，不可部份複製。

This document is issued by the Company subject to its General Conditions of Service printed overleaf, available on request or accessible at <http://www.sgs.com.tw/Terms-and-Conditions> and for electronic format documents, subject to Terms and Conditions for Electronic Documents at <http://www.sgs.com.tw/Terms-and-Conditions>. Attention is drawn to the limitation of liability, indemnification and jurisdiction issues defined therein. Any holder of this document is advised that information contained hereon reflects the Company's findings at the time of its intervention only and within the limits of Client's instructions, if any. The Company's sole responsibility is to its Client and this document does not exonerate parties to a transaction from exercising all their rights and obligations under the transaction documents. This document cannot be reproduced except in full, without prior written approval of the Company. Any unauthorized alteration, forgery or falsification of the content or appearance of this document is unlawful and offenders may be prosecuted to the fullest extent of the law.

6.5 Measurement Results:

WCDMA/HSUPA/HSDPA Band II Result:

EUT Mode	Freq. (MHz)	CH	Conducted Avg. Power (dBm)	Antenna Gain (dBi)	ERP (dBm)	EIRP (dBm)	Limit (dBm)	Margin (dB)
WCDMA	1852.4	9262	22.64	3.00	23.49	25.64	33.00	-7.36
	1880.0	9400	22.88	3.00	23.73	25.88	33.00	-7.12
	1907.6	9538	22.90	3.00	23.75	25.90	33.00	-7.10
HSDPA	1852.4	9262	21.71	3.00	22.56	24.71	33.00	-8.29
	1880.0	9400	21.75	3.00	22.60	24.75	33.00	-8.25
	1907.6	9538	21.80	3.00	22.65	24.80	33.00	-8.20
HSUPA	1852.4	9262	21.60	3.00	22.45	24.60	33.00	-8.40
	1880.0	9400	21.57	3.00	22.42	24.57	33.00	-8.43
	1907.6	9538	21.60	3.00	22.45	24.60	33.00	-8.40

WCDMA/HSUPA/HSDPA Band IV Result:

EUT Mode	Freq. (MHz)	CH	Conducted Avg. Power (dBm)	Antenna Gain (dBi)	ERP (dBm)	EIRP (dBm)	Limit (dBm)	Margin (dB)
WCDMA	1712.4	1312	23.32	2.50	23.67	25.82	30.00	-4.18
	1732.6	1413	23.11	2.50	23.46	25.61	30.00	-4.39
	1752.6	1513	23.17	2.50	23.52	25.67	30.00	-4.33
HSDPA	1712.4	1312	22.08	2.50	22.43	24.58	30.00	-5.42
	1732.6	1413	21.97	2.50	22.32	24.47	30.00	-5.53
	1752.6	1513	21.95	2.50	22.30	24.45	30.00	-5.55
HSUPA	1712.4	1312	21.95	2.50	22.30	24.45	30.00	-5.55
	1732.6	1413	21.98	2.50	22.33	24.48	30.00	-5.52
	1752.6	1513	21.84	2.50	22.19	24.34	30.00	-5.66

Unless otherwise stated the results shown in this test report refer only to the sample(s) tested and such sample(s) are retained for 90 days only.

除非另有說明，此報告結果僅對測試之樣品負責，同時此樣品僅保留90天。本報告未經本公司書面許可，不可部份複製。

This document is issued by the Company subject to its General Conditions of Service printed overleaf, available on request or accessible at <http://www.sgs.com.tw/Terms-and-Conditions> and for electronic format documents, subject to Terms and Conditions for Electronic Documents at <http://www.sgs.com.tw/Terms-and-Conditions>. Attention is drawn to the limitation of liability, indemnification and jurisdiction issues defined therein. Any holder of this document is advised that information contained hereon reflects the Company's findings at the time of its intervention only and within the limits of Client's instructions, if any. The Company's sole responsibility is to its Client and this document does not exonerate parties to a transaction from exercising all their rights and obligations under the transaction documents. This document cannot be reproduced except in full, without prior written approval of the Company. Any unauthorized alteration, forgery or falsification of the content or appearance of this document is unlawful and offenders may be prosecuted to the fullest extent of the law.

WCDMA/HSUPA/HSDPA Band V Result:

EUT Mode	Freq. (MHz)	CH	Conducted Avg. Power (dBm)	Antenna Gain (dBi)	ERP (dBm)	EIRP (dBm)	Limit (dBm)	Margin (dB)
WCDMA	826.4	4132	23.18	0.30	21.33	23.48	38.50	-15.02
	836.6	4183	23.17	0.30	21.32	23.47	38.50	-15.03
	846.6	4233	23.14	0.30	21.29	23.44	38.50	-15.06
HSDPA	826.4	4132	22.15	0.30	20.30	22.45	38.50	-16.05
	836.6	4183	22.18	0.30	20.33	22.48	38.50	-16.02
	846.6	4233	22.25	0.30	20.40	22.55	38.50	-15.95
HSUPA	826.4	4132	22.13	0.30	20.28	22.43	38.50	-16.07
	836.6	4183	22.23	0.30	20.38	22.53	38.50	-15.97
	846.6	4233	22.21	0.30	20.36	22.51	38.50	-15.99

Unless otherwise stated the results shown in this test report refer only to the sample(s) tested and such sample(s) are retained for 90 days only.

除非另有說明，此報告結果僅對測試之樣品負責，同時此樣品僅保留90天。本報告未經本公司書面許可，不可部份複製。

This document is issued by the Company subject to its General Conditions of Service printed overleaf, available on request or accessible at <http://www.sgs.com.tw/Terms-and-Conditions> and for electronic format documents, subject to Terms and Conditions for Electronic Documents at <http://www.sgs.com.tw/Terms-and-Conditions>. Attention is drawn to the limitation of liability, indemnification and jurisdiction issues defined therein. Any holder of this document is advised that information contained hereon reflects the Company's findings at the time of its intervention only and within the limits of Client's instructions, if any. The Company's sole responsibility is to its Client and this document does not exonerate parties to a transaction from exercising all their rights and obligations under the transaction documents. This document cannot be reproduced except in full, without prior written approval of the Company. Any unauthorized alteration, forgery or falsification of the content or appearance of this document is unlawful and offenders may be prosecuted to the fullest extent of the law.

Antenna gain (dBi)		3		LTE Band 2_Uplink frequency band : 1850 to 1910 MHz					
BW (MHz)	UL Channel	Frequency (MHz)	Modulation	RB Size	RB Offset	Conducted Average (dBm)	EIRP Average (dBm)	EIRP Limit (dBm)	Margin (dB)
1.4	18607	1850.7	QPSK	1	0	22.79	25.79	33	-7.21
				1	5	22.84	25.84	33	-7.16
				3	2	22.99	25.99	33	-7.01
				6	0	21.84	24.84	33	-8.16
	18900	1880	QPSK	1	0	23.02	26.02	33	-6.98
				1	5	23.01	26.01	33	-6.99
				3	2	23.09	26.09	33	-6.91
				6	0	21.93	24.93	33	-8.07
	19193	1909.3	QPSK	1	0	22.91	25.91	33	-7.09
				1	5	22.99	25.99	33	-7.01
				3	2	23.07	26.07	33	-6.93
				6	0	21.87	24.87	33	-8.13
1.4	18607	1850.7	16QAM	1	0	21.76	24.76	33	-8.24
				1	5	21.64	24.64	33	-8.36
				3	2	21.73	24.73	33	-8.27
				6	0	20.73	23.73	33	-9.27
	18900	1880	16QAM	1	0	21.92	24.92	33	-8.08
				1	5	22.01	25.01	33	-7.99
				3	2	22.13	25.13	33	-7.87
				6	0	20.87	23.87	33	-9.13
	19193	1909.3	16QAM	1	0	21.93	24.93	33	-8.07
				1	5	21.76	24.76	33	-8.24
				3	2	21.81	24.81	33	-8.19
				6	0	20.68	23.68	33	-9.32

Unless otherwise stated the results shown in this test report refer only to the sample(s) tested and such sample(s) are retained for 90 days only.

除非另有說明，此報告結果僅對測試之樣品負責，同時此樣品僅保留90天。本報告未經本公司書面許可，不可部份複製。

This document is issued by the Company subject to its General Conditions of Service printed overleaf, available on request or accessible at <http://www.sgs.com.tw/Terms-and-Conditions> and for electronic format documents, subject to Terms and Conditions for Electronic Documents at <http://www.sgs.com.tw/Terms-and-Conditions>. Attention is drawn to the limitation of liability, indemnification and jurisdiction issues defined therein. Any holder of this document is advised that information contained hereon reflects the Company's findings at the time of its intervention only and within the limits of Client's instructions, if any. The Company's sole responsibility is to its Client and this document does not exonerate parties to a transaction from exercising all their rights and obligations under the transaction documents. This document cannot be reproduced except in full, without prior written approval of the Company. Any unauthorized alteration, forgery or falsification of the content or appearance of this document is unlawful and offenders may be prosecuted to the fullest extent of the law.

Antenna gain (dBi)		3							
LTE Band 2_Uplink frequency band : 1850 to 1910 MHz									
BW (MHz)	UL Channel	Frequency (MHz)	Modulation	RB Size	RB Offset	Conducted Average (dBm)	EIRP Average (dBm)	EIRP Limit (dBm)	Margin (dB)
3	18615	1851.5	QPSK	1	0	22.79	25.79	33	-7.21
				1	14	22.77	25.77	33	-7.23
				8	4	21.85	24.85	33	-8.15
				15	0	21.81	24.81	33	-8.19
	18900	1880	QPSK	1	0	22.99	25.99	33	-7.01
				1	14	23.15	26.15	33	-6.85
				8	4	22.01	25.01	33	-7.99
				15	0	21.90	24.90	33	-8.1
	19185	1908.5	QPSK	1	0	22.96	25.96	33	-7.04
				1	14	23.03	26.03	33	-6.97
				8	4	22.06	25.06	33	-7.94
				15	0	21.94	24.94	33	-8.06
3	18615	1851.5	16QAM	1	0	21.25	24.25	33	-8.75
				1	14	21.36	24.36	33	-8.64
				8	4	20.65	23.65	33	-9.35
				15	0	20.71	23.71	33	-9.29
	18900	1880	16QAM	1	0	21.59	24.59	33	-8.41
				1	14	21.82	24.82	33	-8.18
				8	4	20.67	23.67	33	-9.33
				15	0	20.85	23.85	33	-9.15
	19185	1908.5	16QAM	1	0	21.65	24.65	33	-8.35
				1	14	21.91	24.91	33	-8.09
				8	4	20.80	23.80	33	-9.2
				15	0	20.84	23.84	33	-9.16

Unless otherwise stated the results shown in this test report refer only to the sample(s) tested and such sample(s) are retained for 90 days only.

除非另有說明，此報告結果僅對測試之樣品負責，同時此樣品僅保留90天。本報告未經本公司書面許可，不可部份複製。

This document is issued by the Company subject to its General Conditions of Service printed overleaf, available on request or accessible at <http://www.sgs.com.tw/Terms-and-Conditions> and for electronic format documents, subject to Terms and Conditions for Electronic Documents at <http://www.sgs.com.tw/Terms-and-Conditions>. Attention is drawn to the limitation of liability, indemnification and jurisdiction issues defined therein. Any holder of this document is advised that information contained hereon reflects the Company's findings at the time of its intervention only and within the limits of Client's instructions, if any. The Company's sole responsibility is to its Client and this document does not exonerate parties to a transaction from exercising all their rights and obligations under the transaction documents. This document cannot be reproduced except in full, without prior written approval of the Company. Any unauthorized alteration, forgery or falsification of the content or appearance of this document is unlawful and offenders may be prosecuted to the fullest extent of the law.

Antenna gain (dBi)	3
--------------------	---

LTE Band 2_Uplink frequency band : 1850 to 1910 MHz									
BW (MHz)	UL Channel	Frequency (MHz)	Modulation	RB Size	RB Offset	Conducted Average (dBm)	EIRP Average (dBm)	EIRP Limit (dBm)	Margin (dB)
5	18625	1852.5	QPSK	1	0	22.90	25.90	33	-7.1
				1	24	22.52	25.52	33	-7.48
				12	6	21.75	24.75	33	-8.25
				25	0	21.77	24.77	33	-8.23
	18900	1880	QPSK	1	0	22.84	25.84	33	-7.16
				1	24	22.87	25.87	33	-7.13
				12	6	21.95	24.95	33	-8.05
				25	0	21.92	24.92	33	-8.08
	19175	1907.5	QPSK	1	0	22.82	25.82	33	-7.18
				1	24	22.98	25.98	33	-7.02
				12	6	21.94	24.94	33	-8.06
				25	0	21.89	24.89	33	-8.11
5	18625	1852.5	16QAM	1	0	21.36	24.36	33	-8.64
				1	24	21.43	24.43	33	-8.57
				12	6	20.57	23.57	33	-9.43
				25	0	20.57	23.57	33	-9.43
	18900	1880	16QAM	1	0	21.56	24.56	33	-8.44
				1	24	21.64	24.64	33	-8.36
				12	6	20.62	23.62	33	-9.38
				25	0	20.82	23.82	33	-9.18
	19175	1907.5	16QAM	1	0	21.64	24.64	33	-8.36
				1	24	21.77	24.77	33	-8.23
				12	6	20.52	23.52	33	-9.48
				25	0	20.86	23.86	33	-9.14

Unless otherwise stated the results shown in this test report refer only to the sample(s) tested and such sample(s) are retained for 90 days only.

除非另有說明，此報告結果僅對測試之樣品負責，同時此樣品僅保留90天。本報告未經本公司書面許可，不可部份複製。

This document is issued by the Company subject to its General Conditions of Service printed overleaf, available on request or accessible at <http://www.sgs.com.tw/Terms-and-Conditions> and for electronic format documents, subject to Terms and Conditions for Electronic Documents at <http://www.sgs.com.tw/Terms-and-Conditions>. Attention is drawn to the limitation of liability, indemnification and jurisdiction issues defined therein. Any holder of this document is advised that information contained hereon reflects the Company's findings at the time of its intervention only and within the limits of Client's instructions, if any. The Company's sole responsibility is to its Client and this document does not exonerate parties to a transaction from exercising all their rights and obligations under the transaction documents. This document cannot be reproduced except in full, without prior written approval of the Company. Any unauthorized alteration, forgery or falsification of the content or appearance of this document is unlawful and offenders may be prosecuted to the fullest extent of the law.

Antenna gain (dBi)	3
--------------------	---

LTE Band 2_Uplink frequency band : 1850 to 1910 MHz									
BW (MHz)	UL Channel	Frequency (MHz)	Modulation	RB Size	RB Offset	Conducted Average (dBm)	EIRP Average (dBm)	EIRP Limit (dBm)	Margin (dB)
10	18650	1855	QPSK	1	0	23.06	26.06	33	-6.94
				1	49	22.84	25.84	33	-7.16
				25	12	21.73	24.73	33	-8.27
				50	0	21.77	24.77	33	-8.23
	18900	1880	QPSK	1	0	22.85	25.85	33	-7.15
				1	49	22.66	25.66	33	-7.34
				25	12	22.02	25.02	33	-7.98
				50	0	21.87	24.87	33	-8.13
	19150	1905	QPSK	1	0	22.94	25.94	33	-7.06
				1	49	23.07	26.07	33	-6.93
				25	12	21.97	24.97	33	-8.03
				50	0	21.85	24.85	33	-8.15
10	18650	1855	16QAM	1	0	21.62	24.62	33	-8.38
				1	49	21.33	24.33	33	-8.67
				25	12	20.64	23.64	33	-9.36
				50	0	20.72	23.72	33	-9.28
	18900	1880	16QAM	1	0	21.43	24.43	33	-8.57
				1	49	21.58	24.58	33	-8.42
				25	12	20.87	23.87	33	-9.13
				50	0	20.82	23.82	33	-9.18
	19150	1905	16QAM	1	0	21.73	24.73	33	-8.27
				1	49	21.56	24.56	33	-8.44
				25	12	20.89	23.89	33	-9.11
				50	0	20.77	23.77	33	-9.23

Unless otherwise stated the results shown in this test report refer only to the sample(s) tested and such sample(s) are retained for 90 days only.

除非另有說明，此報告結果僅對測試之樣品負責，同時此樣品僅保留90天。本報告未經本公司書面許可，不可部份複製。

This document is issued by the Company subject to its General Conditions of Service printed overleaf, available on request or accessible at <http://www.sgs.com.tw/Terms-and-Conditions> and for electronic format documents, subject to Terms and Conditions for Electronic Documents at <http://www.sgs.com.tw/Terms-and-Conditions>. Attention is drawn to the limitation of liability, indemnification and jurisdiction issues defined therein. Any holder of this document is advised that information contained hereon reflects the Company's findings at the time of its intervention only and within the limits of Client's instructions, if any. The Company's sole responsibility is to its Client and this document does not exonerate parties to a transaction from exercising all their rights and obligations under the transaction documents. This document cannot be reproduced except in full, without prior written approval of the Company. Any unauthorized alteration, forgery or falsification of the content or appearance of this document is unlawful and offenders may be prosecuted to the fullest extent of the law.

Antenna gain (dBi)	3
--------------------	---

LTE Band 2_Uplink frequency band : 1850 to 1910 MHz									
BW (MHz)	UL Channel	Frequency (MHz)	Modulation	RB Size	RB Offset	Conducted Average (dBm)	EIRP Average (dBm)	EIRP Limit (dBm)	Margin (dB)
15	18675	1857.5	QPSK	1	0	22.90	25.90	33	-7.1
				1	74	22.99	25.99	33	-7.01
				36	18	21.71	24.71	33	-8.29
				75	0	21.79	24.79	33	-8.21
	18900	1880	QPSK	1	0	22.84	25.84	33	-7.16
				1	74	22.95	25.95	33	-7.05
				36	18	22.00	25.00	33	-8
				75	0	21.91	24.91	33	-8.09
	19125	1902.5	QPSK	1	0	22.80	25.80	33	-7.2
				1	74	23.11	26.11	33	-6.89
				36	18	21.85	24.85	33	-8.15
				75	0	21.80	24.80	33	-8.2
15	18675	1857.5	16QAM	1	0	21.65	24.65	33	-8.35
				1	74	21.74	24.74	33	-8.26
				36	18	20.68	23.68	33	-9.32
				75	0	20.70	23.70	33	-9.3
	18900	1880	16QAM	1	0	21.72	24.72	33	-8.28
				1	74	21.91	24.91	33	-8.09
				36	18	20.90	23.90	33	-9.1
				75	0	20.71	23.71	33	-9.29
	19125	1902.5	16QAM	1	0	21.68	24.68	33	-8.32
				1	74	21.54	24.54	33	-8.46
				36	18	20.63	23.63	33	-9.37
				75	0	20.75	23.75	33	-9.25

Unless otherwise stated the results shown in this test report refer only to the sample(s) tested and such sample(s) are retained for 90 days only.

除非另有說明，此報告結果僅對測試之樣品負責，同時此樣品僅保留90天。本報告未經本公司書面許可，不可部份複製。

This document is issued by the Company subject to its General Conditions of Service printed overleaf, available on request or accessible at <http://www.sgs.com.tw/Terms-and-Conditions> and for electronic format documents, subject to Terms and Conditions for Electronic Documents at <http://www.sgs.com.tw/Terms-and-Conditions>. Attention is drawn to the limitation of liability, indemnification and jurisdiction issues defined therein. Any holder of this document is advised that information contained hereon reflects the Company's findings at the time of its intervention only and within the limits of Client's instructions, if any. The Company's sole responsibility is to its Client and this document does not exonerate parties to a transaction from exercising all their rights and obligations under the transaction documents. This document cannot be reproduced except in full, without prior written approval of the Company. Any unauthorized alteration, forgery or falsification of the content or appearance of this document is unlawful and offenders may be prosecuted to the fullest extent of the law.

Antenna gain (dBi)	3
--------------------	---

LTE Band 2_Uplink frequency band : 1850 to 1910 MHz									
BW (MHz)	UL Channel	Frequency (MHz)	Modulation	RB Size	RB Offset	Conducted Average (dBm)	EIRP Average (dBm)	EIRP Limit (dBm)	Margin (dB)
20	18700	1860	QPSK	1	0	22.90	25.90	33	-7.1
				1	99	22.70	25.70	33	-7.3
				50	25	21.75	24.75	33	-8.25
				100	0	21.77	24.77	33	-8.23
	18900	1880	QPSK	1	0	22.84	25.84	33	-7.16
				1	99	22.85	25.85	33	-7.15
				50	25	22.00	25.00	33	-8
				100	0	21.92	24.92	33	-8.08
	19100	1900	QPSK	1	0	22.88	25.88	33	-7.12
				1	99	23.02	26.02	33	-6.98
				50	25	21.79	24.79	33	-8.21
				100	0	21.73	24.73	33	-8.27
20	18700	1860	16QAM	1	0	21.48	24.48	33	-8.52
				1	99	21.38	24.38	33	-8.62
				50	25	20.56	23.56	33	-9.44
				100	0	20.57	23.57	33	-9.43
	18900	1880	16QAM	1	0	21.58	24.58	33	-8.42
				1	99	21.69	24.69	33	-8.31
				50	25	20.96	23.96	33	-9.04
				100	0	20.73	23.73	33	-9.27
	19100	1900	16QAM	1	0	21.95	24.95	33	-8.05
				1	99	21.84	24.84	33	-8.16
				50	25	20.89	23.89	33	-9.11
				100	0	20.80	23.80	33	-9.2

Unless otherwise stated the results shown in this test report refer only to the sample(s) tested and such sample(s) are retained for 90 days only.

除非另有說明，此報告結果僅對測試之樣品負責，同時此樣品僅保留90天。本報告未經本公司書面許可，不可部份複製。

This document is issued by the Company subject to its General Conditions of Service printed overleaf, available on request or accessible at <http://www.sgs.com.tw/Terms-and-Conditions> and for electronic format documents, subject to Terms and Conditions for Electronic Documents at <http://www.sgs.com.tw/Terms-and-Conditions>. Attention is drawn to the limitation of liability, indemnification and jurisdiction issues defined therein. Any holder of this document is advised that information contained hereon reflects the Company's findings at the time of its intervention only and within the limits of Client's instructions, if any. The Company's sole responsibility is to its Client and this document does not exonerate parties to a transaction from exercising all their rights and obligations under the transaction documents. This document cannot be reproduced except in full, without prior written approval of the Company. Any unauthorized alteration, forgery or falsification of the content or appearance of this document is unlawful and offenders may be prosecuted to the fullest extent of the law.

Antenna gain (dBi)	2.5
--------------------	-----

LTE Band 4_Uplink frequency band : 1710 to 1755 MHz									
BW (MHz)	UL Channel	Frequency (MHz)	Modulation	RB Size	RB Offset	Conducted Average (dBm)	EIRP Average (dBm)	EIRP Limit (dBm)	Margin (dB)
1.4	19957	1710.7	QPSK	1	0	23.17	25.67	30	-4.33
				1	5	23.13	25.63	30	-4.37
				3	2	23.23	25.73	30	-4.27
				6	0	22.36	24.86	30	-5.14
	20175	1732.5	QPSK	1	0	23.14	25.64	30	-4.36
				1	5	23.27	25.77	30	-4.23
				3	2	23.30	25.80	30	-4.2
				6	0	22.26	24.76	30	-5.24
	20393	1754.3	QPSK	1	0	23.21	25.71	30	-4.29
				1	5	23.49	25.99	30	-4.01
				3	2	23.41	25.91	30	-4.09
				6	0	22.51	25.01	30	-4.99
1.4	19957	1710.7	16QAM	1	0	21.96	24.46	30	-5.54
				1	5	22.12	24.62	30	-5.38
				3	2	22.29	24.79	30	-5.21
				6	0	21.05	23.55	30	-6.45
	20175	1732.5	16QAM	1	0	21.71	24.21	30	-5.79
				1	5	22.09	24.59	30	-5.41
				3	2	22.17	24.67	30	-5.33
				6	0	21.29	23.79	30	-6.21
	20393	1754.3	16QAM	1	0	22.21	24.71	30	-5.29
				1	5	22.28	24.78	30	-5.22
				3	2	22.34	24.84	30	-5.16
				6	0	21.14	23.64	30	-6.36

Unless otherwise stated the results shown in this test report refer only to the sample(s) tested and such sample(s) are retained for 90 days only.

除非另有說明，此報告結果僅對測試之樣品負責，同時此樣品僅保留90天。本報告未經本公司書面許可，不可部份複製。

This document is issued by the Company subject to its General Conditions of Service printed overleaf, available on request or accessible at <http://www.sgs.com.tw/Terms-and-Conditions> and for electronic format documents, subject to Terms and Conditions for Electronic Documents at <http://www.sgs.com.tw/Terms-and-Conditions>. Attention is drawn to the limitation of liability, indemnification and jurisdiction issues defined therein. Any holder of this document is advised that information contained hereon reflects the Company's findings at the time of its intervention only and within the limits of Client's instructions, if any. The Company's sole responsibility is to its Client and this document does not exonerate parties to a transaction from exercising all their rights and obligations under the transaction documents. This document cannot be reproduced except in full, without prior written approval of the Company. Any unauthorized alteration, forgery or falsification of the content or appearance of this document is unlawful and offenders may be prosecuted to the fullest extent of the law.

Antenna gain (dBi)	2.5
--------------------	-----

LTE Band 4_Uplink frequency band : 1710 to 1755 MHz									
BW (MHz)	UL Channel	Frequency (MHz)	Modulation	RB Size	RB Offset	Conducted Average (dBm)	EIRP Average (dBm)	EIRP Limit (dBm)	Margin (dB)
3	19965	1711.5	QPSK	1	0	23.20	25.70	30	-4.3
				1	14	23.26	25.76	30	-4.24
				8	4	22.48	24.98	30	-5.02
				15	0	22.28	24.78	30	-5.22
	20175	1732.5	QPSK	1	0	23.39	25.89	30	-4.11
				1	14	23.52	26.02	30	-3.98
				8	4	22.17	24.67	30	-5.33
				15	0	22.25	24.75	30	-5.25
	20385	1753.5	QPSK	1	0	23.24	25.74	30	-4.26
				1	14	23.32	25.82	30	-4.18
				8	4	22.30	24.80	30	-5.2
				15	0	22.28	24.78	30	-5.22
3	19965	1711.5	16QAM	1	0	22.33	24.83	30	-5.17
				1	14	22.22	24.72	30	-5.28
				8	4	21.40	23.90	30	-6.1
				15	0	21.13	23.63	30	-6.37
	20175	1732.5	16QAM	1	0	21.66	24.16	30	-5.84
				1	14	21.91	24.41	30	-5.59
				8	4	21.35	23.85	30	-6.15
				15	0	21.25	23.75	30	-6.25
	20385	1753.5	16QAM	1	0	22.45	24.95	30	-5.05
				1	14	22.41	24.91	30	-5.09
				8	4	21.31	23.81	30	-6.19
				15	0	21.34	23.84	30	-6.16

Unless otherwise stated the results shown in this test report refer only to the sample(s) tested and such sample(s) are retained for 90 days only.

除非另有說明，此報告結果僅對測試之樣品負責，同時此樣品僅保留90天。本報告未經本公司書面許可，不可部份複製。

This document is issued by the Company subject to its General Conditions of Service printed overleaf, available on request or accessible at <http://www.sgs.com.tw/Terms-and-Conditions> and for electronic format documents, subject to Terms and Conditions for Electronic Documents at <http://www.sgs.com.tw/Terms-and-Conditions>. Attention is drawn to the limitation of liability, indemnification and jurisdiction issues defined therein. Any holder of this document is advised that information contained hereon reflects the Company's findings at the time of its intervention only and within the limits of Client's instructions, if any. The Company's sole responsibility is to its Client and this document does not exonerate parties to a transaction from exercising all their rights and obligations under the transaction documents. This document cannot be reproduced except in full, without prior written approval of the Company. Any unauthorized alteration, forgery or falsification of the content or appearance of this document is unlawful and offenders may be prosecuted to the fullest extent of the law.

Antenna gain (dBi)		2.5							
LTE Band 4_Uplink frequency band : 1710 to 1755 MHz									
BW (MHz)	UL Channel	Frequency (MHz)	Modulation	RB Size	RB Offset	Conducted Average (dBm)	EIRP Average (dBm)	EIRP Limit (dBm)	Margin (dB)
5	19975	1712.5	QPSK	1	0	23.21	25.71	30	-4.29
				1	24	23.38	25.88	30	-4.12
				12	6	22.37	24.87	30	-5.13
				25	0	22.30	24.80	30	-5.2
	20175	1732.5	QPSK	1	0	23.31	25.81	30	-4.19
				1	24	23.22	25.72	30	-4.28
				12	6	22.12	24.62	30	-5.38
				25	0	22.18	24.68	30	-5.32
	20375	1752.5	QPSK	1	0	23.24	25.74	30	-4.26
				1	24	23.38	25.88	30	-4.12
				12	6	22.32	24.82	30	-5.18
				25	0	22.29	24.79	30	-5.21
5	19975	1712.5	16QAM	1	0	22.25	24.75	30	-5.25
				1	24	22.38	24.88	30	-5.12
				12	6	21.20	23.70	30	-6.3
				25	0	21.45	23.95	30	-6.05
	20175	1732.5	16QAM	1	0	21.86	24.36	30	-5.64
				1	24	21.84	24.34	30	-5.66
				12	6	21.07	23.57	30	-6.43
				25	0	21.27	23.77	30	-6.23
	20375	1752.5	16QAM	1	0	22.02	24.52	30	-5.48
				1	24	22.34	24.84	30	-5.16
				12	6	21.42	23.92	30	-6.08
				25	0	21.46	23.96	30	-6.04

Unless otherwise stated the results shown in this test report refer only to the sample(s) tested and such sample(s) are retained for 90 days only.

除非另有說明，此報告結果僅對測試之樣品負責，同時此樣品僅保留90天。本報告未經本公司書面許可，不可部份複製。

This document is issued by the Company subject to its General Conditions of Service printed overleaf, available on request or accessible at <http://www.sgs.com.tw/Terms-and-Conditions> and for electronic format documents, subject to Terms and Conditions for Electronic Documents at <http://www.sgs.com.tw/Terms-and-Conditions>. Attention is drawn to the limitation of liability, indemnification and jurisdiction issues defined therein. Any holder of this document is advised that information contained hereon reflects the Company's findings at the time of its intervention only and within the limits of Client's instructions, if any. The Company's sole responsibility is to its Client and this document does not exonerate parties to a transaction from exercising all their rights and obligations under the transaction documents. This document cannot be reproduced except in full, without prior written approval of the Company. Any unauthorized alteration, forgery or falsification of the content or appearance of this document is unlawful and offenders may be prosecuted to the fullest extent of the law.

Antenna gain (dBi)		2.5							
LTE Band 4_Uplink frequency band : 1710 to 1755 MHz									
BW (MHz)	UL Channel	Frequency (MHz)	Modulation	RB Size	RB Offset	Conducted Average (dBm)	EIRP Average (dBm)	EIRP Limit (dBm)	Margin (dB)
10	20000	1715	QPSK	1	0	23.15	25.65	30	-4.35
				1	49	23.26	25.76	30	-4.24
				25	12	22.38	24.88	30	-5.12
				50	0	22.30	24.80	30	-5.2
	20175	1732.5	QPSK	1	0	23.38	25.88	30	-4.12
				1	49	23.05	25.55	30	-4.45
				25	12	22.19	24.69	30	-5.31
				50	0	22.23	24.73	30	-5.27
	20350	1750	QPSK	1	0	23.19	25.69	30	-4.31
				1	49	23.40	25.90	30	-4.1
				25	12	22.40	24.90	30	-5.1
				50	0	22.29	24.79	30	-5.21
10	20000	1715	16QAM	1	0	22.11	24.61	30	-5.39
				1	49	22.00	24.50	30	-5.5
				25	12	21.36	23.86	30	-6.14
				50	0	21.31	23.81	30	-6.19
	20175	1732.5	16QAM	1	0	21.86	24.36	30	-5.64
				1	49	21.81	24.31	30	-5.69
				25	12	21.19	23.69	30	-6.31
				50	0	21.19	23.69	30	-6.31
	20350	1750	16QAM	1	0	22.28	24.78	30	-5.22
				1	49	22.37	24.87	30	-5.13
				25	12	21.52	24.02	30	-5.98
				50	0	21.39	23.89	30	-6.11

Unless otherwise stated the results shown in this test report refer only to the sample(s) tested and such sample(s) are retained for 90 days only.

除非另有說明，此報告結果僅對測試之樣品負責，同時此樣品僅保留90天。本報告未經本公司書面許可，不可部份複製。

This document is issued by the Company subject to its General Conditions of Service printed overleaf, available on request or accessible at <http://www.sgs.com.tw/Terms-and-Conditions> and for electronic format documents, subject to Terms and Conditions for Electronic Documents at <http://www.sgs.com.tw/Terms-and-Conditions>. Attention is drawn to the limitation of liability, indemnification and jurisdiction issues defined therein. Any holder of this document is advised that information contained hereon reflects the Company's findings at the time of its intervention only and within the limits of Client's instructions, if any. The Company's sole responsibility is to its Client and this document does not exonerate parties to a transaction from exercising all their rights and obligations under the transaction documents. This document cannot be reproduced except in full, without prior written approval of the Company. Any unauthorized alteration, forgery or falsification of the content or appearance of this document is unlawful and offenders may be prosecuted to the fullest extent of the law.

Antenna gain (dBi)	2.5
--------------------	-----

LTE Band 4_Uplink frequency band : 1710 to 1755 MHz									
BW (MHz)	UL Channel	Frequency (MHz)	Modulation	RB Size	RB Offset	Conducted Average (dBm)	EIRP Average (dBm)	EIRP Limit (dBm)	Margin (dB)
15	20025	1717.5	QPSK	1	0	23.56	26.06	30	-3.94
				1	74	23.21	25.71	30	-4.29
				36	18	22.30	24.80	30	-5.2
				75	0	22.23	24.73	30	-5.27
	20175	1732.5	QPSK	1	0	23.40	25.90	30	-4.1
				1	74	23.16	25.66	30	-4.34
				36	18	22.11	24.61	30	-5.39
				75	0	22.12	24.62	30	-5.38
	20325	1747.5	QPSK	1	0	23.26	25.76	30	-4.24
				1	74	23.37	25.87	30	-4.13
				36	18	22.23	24.73	30	-5.27
				75	0	22.20	24.70	30	-5.3
15	20025	1717.5	16QAM	1	0	22.35	24.85	30	-5.15
				1	74	22.01	24.51	30	-5.49
				36	18	21.34	23.84	30	-6.16
				75	0	21.24	23.74	30	-6.26
	20175	1732.5	16QAM	1	0	22.19	24.69	30	-5.31
				1	74	21.90	24.40	30	-5.6
				36	18	21.13	23.63	30	-6.37
				75	0	21.22	23.72	30	-6.28
	20325	1747.5	16QAM	1	0	22.11	24.61	30	-5.39
				1	74	22.04	24.54	30	-5.46
				36	18	21.23	23.73	30	-6.27
				75	0	21.27	23.77	30	-6.23

Unless otherwise stated the results shown in this test report refer only to the sample(s) tested and such sample(s) are retained for 90 days only.

除非另有說明，此報告結果僅對測試之樣品負責，同時此樣品僅保留90天。本報告未經本公司書面許可，不可部份複製。

This document is issued by the Company subject to its General Conditions of Service printed overleaf, available on request or accessible at <http://www.sgs.com.tw/Terms-and-Conditions> and for electronic format documents, subject to Terms and Conditions for Electronic Documents at <http://www.sgs.com.tw/Terms-and-Conditions>. Attention is drawn to the limitation of liability, indemnification and jurisdiction issues defined therein. Any holder of this document is advised that information contained hereon reflects the Company's findings at the time of its intervention only and within the limits of Client's instructions, if any. The Company's sole responsibility is to its Client and this document does not exonerate parties to a transaction from exercising all their rights and obligations under the transaction documents. This document cannot be reproduced except in full, without prior written approval of the Company. Any unauthorized alteration, forgery or falsification of the content or appearance of this document is unlawful and offenders may be prosecuted to the fullest extent of the law.

Antenna gain (dBi)	2.5
--------------------	-----

LTE Band 4_Uplink frequency band : 1710 to 1755 MHz									
BW (MHz)	UL Channel	Frequency (MHz)	Modulation	RB Size	RB Offset	Conducted Average (dBm)	EIRP Average (dBm)	EIRP Limit (dBm)	Margin (dB)
20	20050	1720	QPSK	1	0	23.50	26.00	30	-4
				1	99	23.46	25.96	30	-4.04
				50	25	22.24	24.74	30	-5.26
				100	0	22.32	24.82	30	-5.18
	20175	1732.5	QPSK	1	0	23.27	25.77	30	-4.23
				1	99	23.18	25.68	30	-4.32
				50	25	22.16	24.66	30	-5.34
				100	0	22.19	24.69	30	-5.31
	20300	1745	QPSK	1	0	23.42	25.92	30	-4.08
				1	99	23.35	25.85	30	-4.15
				50	25	22.26	24.76	30	-5.24
				100	0	22.25	24.75	30	-5.25
20	20050	1720	16QAM	1	0	22.19	24.69	30	-5.31
				1	99	22.03	24.53	30	-5.47
				50	25	21.29	23.79	30	-6.21
				100	0	21.23	23.73	30	-6.27
	20175	1732.5	16QAM	1	0	22.10	24.60	30	-5.4
				1	99	21.96	24.46	30	-5.54
				50	25	21.18	23.68	30	-6.32
				100	0	21.09	23.59	30	-6.41
	20300	1745	16QAM	1	0	21.56	24.06	30	-5.94
				1	99	22.05	24.55	30	-5.45
				50	25	21.35	23.85	30	-6.15
				100	0	21.14	23.64	30	-6.36

Unless otherwise stated the results shown in this test report refer only to the sample(s) tested and such sample(s) are retained for 90 days only.

除非另有說明，此報告結果僅對測試之樣品負責，同時此樣品僅保留90天。本報告未經本公司書面許可，不可部份複製。

This document is issued by the Company subject to its General Conditions of Service printed overleaf, available on request or accessible at <http://www.sgs.com.tw/Terms-and-Conditions> and for electronic format documents, subject to Terms and Conditions for Electronic Documents at <http://www.sgs.com.tw/Terms-and-Conditions>. Attention is drawn to the limitation of liability, indemnification and jurisdiction issues defined therein. Any holder of this document is advised that information contained hereon reflects the Company's findings at the time of its intervention only and within the limits of Client's instructions, if any. The Company's sole responsibility is to its Client and this document does not exonerate parties to a transaction from exercising all their rights and obligations under the transaction documents. This document cannot be reproduced except in full, without prior written approval of the Company. Any unauthorized alteration, forgery or falsification of the content or appearance of this document is unlawful and offenders may be prosecuted to the fullest extent of the law.

Antenna gain (dBi)		0.3								
LTE Band 5_Uplink frequency band : 824 to 849 MHz										
BW (MHz)	UL Channel	Frequency (MHz)	Modulation	RB Size	RB Offset	Conducted Average (dBm)	ERP Average (dBm)	EIRP Average (dBm)	ERP Limit (dBm)	Margin (dB)
1.4	20407	824.7	QPSK	1	0	23.00	21.15	23.30	38.45	-17.30
				1	5	23.08	21.23	23.38	38.45	-17.22
				3	2	23.10	21.25	23.40	38.45	-17.20
				6	0	22.06	20.21	22.36	38.45	-18.24
	20525	836.5	QPSK	1	0	23.24	21.39	23.54	38.45	-17.06
				1	5	23.29	21.44	23.59	38.45	-17.01
				3	2	23.28	21.43	23.58	38.45	-17.02
				6	0	22.18	20.33	22.48	38.45	-18.12
	20643	848.3	QPSK	1	0	22.92	21.07	23.22	38.45	-17.38
				1	5	23.08	21.23	23.38	38.45	-17.22
				3	2	23.19	21.34	23.49	38.45	-17.11
				6	0	22.03	20.18	22.33	38.45	-18.27
1.4	20407	824.7	16QAM	1	0	21.88	20.03	22.18	38.45	-18.42
				1	5	21.95	20.10	22.25	38.45	-18.35
				3	2	21.91	20.06	22.21	38.45	-18.39
				6	0	20.91	19.06	21.21	38.45	-19.39
	20525	836.5	16QAM	1	0	22.19	20.34	22.49	38.45	-18.11
				1	5	21.84	19.99	22.14	38.45	-18.46
				3	2	21.94	20.09	22.24	38.45	-18.36
				6	0	21.03	19.18	21.33	38.45	-19.27
	20643	848.3	16QAM	1	0	21.69	19.84	21.99	38.45	-18.61
				1	5	21.90	20.05	22.20	38.45	-18.40
				3	2	21.93	20.08	22.23	38.45	-18.37
				6	0	20.76	18.91	21.06	38.45	-19.54

Unless otherwise stated the results shown in this test report refer only to the sample(s) tested and such sample(s) are retained for 90 days only.

除非另有說明，此報告結果僅對測試之樣品負責，同時此樣品僅保留90天。本報告未經本公司書面許可，不可部份複製。

This document is issued by the Company subject to its General Conditions of Service printed overleaf, available on request or accessible at <http://www.sgs.com.tw/Terms-and-Conditions> and for electronic format documents, subject to Terms and Conditions for Electronic Documents at <http://www.sgs.com.tw/Terms-and-Conditions>. Attention is drawn to the limitation of liability, indemnification and jurisdiction issues defined therein. Any holder of this document is advised that information contained hereon reflects the Company's findings at the time of its intervention only and within the limits of Client's instructions, if any. The Company's sole responsibility is to its Client and this document does not exonerate parties to a transaction from exercising all their rights and obligations under the transaction documents. This document cannot be reproduced except in full, without prior written approval of the Company. Any unauthorized alteration, forgery or falsification of the content or appearance of this document is unlawful and offenders may be prosecuted to the fullest extent of the law.

Antenna gain (dBi)		0.3								
LTE Band 5_Uplink frequency band : 824 to 849 MHz										
BW (MHz)	UL Channel	Frequency (MHz)	Modulation	RB Size	RB Offset	Conducted Average (dBm)	ERP Average (dBm)	EIRP Average (dBm)	ERP Limit (dBm)	Margin (dB)
3	20415	825.5	QPSK	1	0	23.00	21.15	23.30	38.45	-17.30
				1	14	23.23	21.38	23.53	38.45	-17.07
				8	4	22.18	20.33	22.48	38.45	-18.12
				15	0	22.05	20.20	22.35	38.45	-18.25
	20525	836.5	QPSK	1	0	23.12	21.27	23.42	38.45	-17.18
				1	14	23.19	21.34	23.49	38.45	-17.11
				8	4	22.29	20.44	22.59	38.45	-18.01
				15	0	22.12	20.27	22.42	38.45	-18.18
	20635	847.5	QPSK	1	0	22.83	20.98	23.13	38.45	-17.47
				1	14	23.14	21.29	23.44	38.45	-17.16
				8	4	22.01	20.16	22.31	38.45	-18.29
				15	0	22.06	20.21	22.36	38.45	-18.24
3	20415	825.5	16QAM	1	0	21.85	20.00	22.15	38.45	-18.45
				1	14	21.78	19.93	22.08	38.45	-18.52
				8	4	20.99	19.14	21.29	38.45	-19.31
				15	0	20.87	19.02	21.17	38.45	-19.43
	20525	836.5	16QAM	1	0	22.05	20.20	22.35	38.45	-18.25
				1	14	22.23	20.38	22.53	38.45	-18.07
				8	4	21.14	19.29	21.44	38.45	-19.16
				15	0	21.07	19.22	21.37	38.45	-19.23
	20635	847.5	16QAM	1	0	21.96	20.11	22.26	38.45	-18.34
				1	14	22.19	20.34	22.49	38.45	-18.11
				8	4	21.24	19.39	21.54	38.45	-19.06
				15	0	21.03	19.18	21.33	38.45	-19.27

Unless otherwise stated the results shown in this test report refer only to the sample(s) tested and such sample(s) are retained for 90 days only.

除非另有說明，此報告結果僅對測試之樣品負責，同時此樣品僅保留90天。本報告未經本公司書面許可，不可部份複製。

This document is issued by the Company subject to its General Conditions of Service printed overleaf, available on request or accessible at <http://www.sgs.com.tw/Terms-and-Conditions> and for electronic format documents, subject to Terms and Conditions for Electronic Documents at <http://www.sgs.com.tw/Terms-and-Conditions>. Attention is drawn to the limitation of liability, indemnification and jurisdiction issues defined therein. Any holder of this document is advised that information contained hereon reflects the Company's findings at the time of its intervention only and within the limits of Client's instructions, if any. The Company's sole responsibility is to its Client and this document does not exonerate parties to a transaction from exercising all their rights and obligations under the transaction documents. This document cannot be reproduced except in full, without prior written approval of the Company. Any unauthorized alteration, forgery or falsification of the content or appearance of this document is unlawful and offenders may be prosecuted to the fullest extent of the law.

Antenna gain (dBi)		0.3								
LTE Band 5_Uplink frequency band : 824 to 849 MHz										
BW (MHz)	UL Channel	Frequency (MHz)	Modulation	RB Size	RB Offset	Conducted Average (dBm)	ERP Average (dBm)	EIRP Average (dBm)	ERP Limit (dBm)	Margin (dB)
5	20425	826.5	QPSK	1	0	23.01	21.16	23.31	38.45	-17.29
				1	24	23.05	21.20	23.35	38.45	-17.25
				12	6	22.14	20.29	22.44	38.45	-18.16
				25	0	22.11	20.26	22.41	38.45	-18.19
	20525	836.5	QPSK	1	0	23.03	21.18	23.33	38.45	-17.27
				1	24	23.23	21.38	23.53	38.45	-17.07
				12	6	22.24	20.39	22.54	38.45	-18.06
				25	0	22.24	20.39	22.54	38.45	-18.06
	20625	846.5	QPSK	1	0	22.83	20.98	23.13	38.45	-17.47
				1	24	23.19	21.34	23.49	38.45	-17.11
				12	6	22.11	20.26	22.41	38.45	-18.19
				25	0	22.05	20.20	22.35	38.45	-18.25
5	20425	826.5	16QAM	1	0	21.62	19.77	21.92	38.45	-18.68
				1	24	21.55	19.70	21.85	38.45	-18.75
				12	6	20.95	19.10	21.25	38.45	-19.35
				25	0	21.02	19.17	21.32	38.45	-19.28
	20525	836.5	16QAM	1	0	21.78	19.93	22.08	38.45	-18.52
				1	24	21.91	20.06	22.21	38.45	-18.39
				12	6	21.10	19.25	21.40	38.45	-19.20
				25	0	21.02	19.17	21.32	38.45	-19.28
	20625	846.5	16QAM	1	0	21.90	20.05	22.20	38.45	-18.40
				1	24	22.08	20.23	22.38	38.45	-18.22
				12	6	20.84	18.99	21.14	38.45	-19.46
				25	0	21.03	19.18	21.33	38.45	-19.27

Unless otherwise stated the results shown in this test report refer only to the sample(s) tested and such sample(s) are retained for 90 days only.

除非另有說明，此報告結果僅對測試之樣品負責，同時此樣品僅保留90天。本報告未經本公司書面許可，不可部份複製。

This document is issued by the Company subject to its General Conditions of Service printed overleaf, available on request or accessible at <http://www.sgs.com.tw/Terms-and-Conditions> and for electronic format documents, subject to Terms and Conditions for Electronic Documents at <http://www.sgs.com.tw/Terms-and-Conditions>. Attention is drawn to the limitation of liability, indemnification and jurisdiction issues defined therein. Any holder of this document is advised that information contained hereon reflects the Company's findings at the time of its intervention only and within the limits of Client's instructions, if any. The Company's sole responsibility is to its Client and this document does not exonerate parties to a transaction from exercising all their rights and obligations under the transaction documents. This document cannot be reproduced except in full, without prior written approval of the Company. Any unauthorized alteration, forgery or falsification of the content or appearance of this document is unlawful and offenders may be prosecuted to the fullest extent of the law.

Antenna gain (dBi)		0.3								
LTE Band 5_Uplink frequency band : 824 to 849 MHz										
BW (MHz)	UL Channel	Frequency (MHz)	Modulation	RB Size	RB Offset	Conducted Average (dBm)	ERP Average (dBm)	EIRP Average (dBm)	ERP Limit (dBm)	Margin (dB)
10	20450	829	QPSK	1	0	23.09	21.24	23.39	38.45	-17.21
				1	49	23.20	21.35	23.50	38.45	-17.10
				25	12	22.26	20.41	22.56	38.45	-18.04
				50	0	22.16	20.31	22.46	38.45	-18.14
	20525	836.5	QPSK	1	0	23.14	21.29	23.44	38.45	-17.16
				1	49	23.29	21.44	23.59	38.45	-17.01
				25	12	22.26	20.41	22.56	38.45	-18.04
				50	0	22.19	20.34	22.49	38.45	-18.11
	20600	844	QPSK	1	0	23.25	21.40	23.55	38.45	-17.05
				1	49	23.31	21.46	23.61	38.45	-16.99
				25	12	22.15	20.30	22.45	38.45	-18.15
				50	0	22.14	20.29	22.44	38.45	-18.16
10	20450	829	16QAM	1	0	21.69	19.84	21.99	38.45	-18.61
				1	49	22.11	20.26	22.41	38.45	-18.19
				25	12	21.25	19.40	21.55	38.45	-19.05
				50	0	21.14	19.29	21.44	38.45	-19.16
	20525	836.5	16QAM	1	0	21.79	19.94	22.09	38.45	-18.51
				1	49	21.47	19.62	21.77	38.45	-18.83
				25	12	21.09	19.24	21.39	38.45	-19.21
				50	0	21.01	19.16	21.31	38.45	-19.29
	20600	844	16QAM	1	0	21.78	19.93	22.08	38.45	-18.52
				1	49	21.72	19.87	22.02	38.45	-18.58
				25	12	21.17	19.32	21.47	38.45	-19.13
				50	0	21.07	19.22	21.37	38.45	-19.23

Unless otherwise stated the results shown in this test report refer only to the sample(s) tested and such sample(s) are retained for 90 days only.

除非另有說明，此報告結果僅對測試之樣品負責，同時此樣品僅保留90天。本報告未經本公司書面許可，不可部份複製。

This document is issued by the Company subject to its General Conditions of Service printed overleaf, available on request or accessible at <http://www.sgs.com.tw/Terms-and-Conditions> and for electronic format documents, subject to Terms and Conditions for Electronic Documents at <http://www.sgs.com.tw/Terms-and-Conditions>. Attention is drawn to the limitation of liability, indemnification and jurisdiction issues defined therein. Any holder of this document is advised that information contained hereon reflects the Company's findings at the time of its intervention only and within the limits of Client's instructions, if any. The Company's sole responsibility is to its Client and this document does not exonerate parties to a transaction from exercising all their rights and obligations under the transaction documents. This document cannot be reproduced except in full, without prior written approval of the Company. Any unauthorized alteration, forgery or falsification of the content or appearance of this document is unlawful and offenders may be prosecuted to the fullest extent of the law.

Antenna gain (dBi)		0								
LTE Band 12_Uplink frequency band : 699 to 716 MHz										
BW (MHz)	UL Channel	Frequency (MHz)	Modulation	RB Size	RB Offset	Conducted Average (dBm)	ERP Average (dBm)	EIRP Average (dBm)	ERP Limit (dBm)	Margin (dB)
1.4	23017	699.7	QPSK	1	0	23.27	21.12	23.27	44.77	-23.65
				1	5	23.44	21.29	23.44	44.77	-23.48
				3	2	23.34	21.19	23.34	44.77	-23.58
				6	0	22.24	20.09	22.24	44.77	-24.68
	23095	707.5	QPSK	1	0	23.16	21.01	23.16	44.77	-23.76
				1	5	23.36	21.21	23.36	44.77	-23.56
				3	2	23.33	21.18	23.33	44.77	-23.59
				6	0	22.25	20.10	22.25	44.77	-24.67
	23173	715.5	QPSK	1	0	23.40	21.25	23.40	44.77	-23.52
				1	5	23.30	21.15	23.30	44.77	-23.62
				3	2	23.32	21.17	23.32	44.77	-23.60
				6	0	22.33	20.18	22.33	44.77	-24.59
1.4	23017	699.7	16QAM	1	0	22.34	20.19	22.34	44.77	-24.58
				1	5	22.37	20.22	22.37	44.77	-24.55
				3	2	22.29	20.14	22.29	44.77	-24.63
				6	0	21.12	18.97	21.12	44.77	-25.80
	23095	707.5	16QAM	1	0	22.13	19.98	22.13	44.77	-24.79
				1	5	22.18	20.03	22.18	44.77	-24.74
				3	2	22.36	20.21	22.36	44.77	-24.56
				6	0	21.16	19.01	21.16	44.77	-25.76
	23173	715.5	16QAM	1	0	22.21	20.06	22.21	44.77	-24.71
				1	5	22.07	19.92	22.07	44.77	-24.85
				3	2	22.40	20.25	22.40	44.77	-24.52
				6	0	21.24	19.09	21.24	44.77	-25.68

Unless otherwise stated the results shown in this test report refer only to the sample(s) tested and such sample(s) are retained for 90 days only.

除非另有說明，此報告結果僅對測試之樣品負責，同時此樣品僅保留90天。本報告未經本公司書面許可，不可部份複製。

This document is issued by the Company subject to its General Conditions of Service printed overleaf, available on request or accessible at <http://www.sgs.com.tw/Terms-and-Conditions> and for electronic format documents, subject to Terms and Conditions for Electronic Documents at <http://www.sgs.com.tw/Terms-and-Conditions>. Attention is drawn to the limitation of liability, indemnification and jurisdiction issues defined therein. Any holder of this document is advised that information contained hereon reflects the Company's findings at the time of its intervention only and within the limits of Client's instructions, if any. The Company's sole responsibility is to its Client and this document does not exonerate parties to a transaction from exercising all their rights and obligations under the transaction documents. This document cannot be reproduced except in full, without prior written approval of the Company. Any unauthorized alteration, forgery or falsification of the content or appearance of this document is unlawful and offenders may be prosecuted to the fullest extent of the law.

Antenna gain (dBi)		0								
LTE Band 12_Uplink frequency band : 699 to 716 MHz										
BW (MHz)	UL Channel	Frequency (MHz)	Modulation	RB Size	RB Offset	Conducted Average (dBm)	ERP Average (dBm)	EIRP Average (dBm)	ERP Limit (dBm)	Margin (dB)
3	23025	700.5	QPSK	1	0	23.29	21.14	23.29	44.77	-23.63
				1	14	23.46	21.31	23.46	44.77	-23.46
				8	4	22.48	20.33	22.48	44.77	-24.44
				15	0	22.38	20.23	22.38	44.77	-24.54
	23095	707.5	QPSK	1	0	23.51	21.36	23.51	44.77	-23.41
				1	14	23.43	21.28	23.43	44.77	-23.49
				8	4	22.46	20.31	22.46	44.77	-24.46
				15	0	22.33	20.18	22.33	44.77	-24.59
	23165	714.5	QPSK	1	0	23.35	21.20	23.35	44.77	-23.57
				1	14	23.32	21.17	23.32	44.77	-23.60
				8	4	22.41	20.26	22.41	44.77	-24.51
				15	0	22.34	20.19	22.34	44.77	-24.58
3	23025	700.5	16QAM	1	0	22.07	19.92	22.07	44.77	-24.85
				1	14	22.36	20.21	22.36	44.77	-24.56
				8	4	21.38	19.23	21.38	44.77	-25.54
				15	0	21.45	19.30	21.45	44.77	-25.47
	23095	707.5	16QAM	1	0	22.30	20.15	22.30	44.77	-24.62
				1	14	22.11	19.96	22.11	44.77	-24.81
				8	4	21.52	19.37	21.52	44.77	-25.40
				15	0	21.42	19.27	21.42	44.77	-25.50
	23165	714.5	16QAM	1	0	21.99	19.84	21.99	44.77	-24.93
				1	14	21.77	19.62	21.77	44.77	-25.15
				8	4	21.41	19.26	21.41	44.77	-25.51
				15	0	21.27	19.12	21.27	44.77	-25.65

Unless otherwise stated the results shown in this test report refer only to the sample(s) tested and such sample(s) are retained for 90 days only.

除非另有說明，此報告結果僅對測試之樣品負責，同時此樣品僅保留90天。本報告未經本公司書面許可，不可部份複製。

This document is issued by the Company subject to its General Conditions of Service printed overleaf, available on request or accessible at <http://www.sgs.com.tw/Terms-and-Conditions> and for electronic format documents, subject to Terms and Conditions for Electronic Documents at <http://www.sgs.com.tw/Terms-and-Conditions>. Attention is drawn to the limitation of liability, indemnification and jurisdiction issues defined therein. Any holder of this document is advised that information contained hereon reflects the Company's findings at the time of its intervention only and within the limits of Client's instructions, if any. The Company's sole responsibility is to its Client and this document does not exonerate parties to a transaction from exercising all their rights and obligations under the transaction documents. This document cannot be reproduced except in full, without prior written approval of the Company. Any unauthorized alteration, forgery or falsification of the content or appearance of this document is unlawful and offenders may be prosecuted to the fullest extent of the law.

Antenna gain (dBi)		0								
LTE Band 12_Uplink frequency band : 699 to 716 MHz										
BW (MHz)	UL Channel	Frequency (MHz)	Modulation	RB Size	RB Offset	Conducted Average (dBm)	ERP Average (dBm)	EIRP Average (dBm)	ERP Limit (dBm)	Margin (dB)
5	23035	701.5	QPSK	1	0	23.12	20.97	23.12	44.77	-23.80
				1	24	23.36	21.21	23.36	44.77	-23.56
				12	6	22.31	20.16	22.31	44.77	-24.61
				25	0	22.24	20.09	22.24	44.77	-24.68
	23095	707.5	QPSK	1	0	23.30	21.15	23.30	44.77	-23.62
				1	24	23.18	21.03	23.18	44.77	-23.74
				12	6	22.36	20.21	22.36	44.77	-24.56
				25	0	22.33	20.18	22.33	44.77	-24.59
	23155	713.5	QPSK	1	0	22.95	20.80	22.95	44.77	-23.97
				1	24	23.07	20.92	23.07	44.77	-23.85
				12	6	22.29	20.14	22.29	44.77	-24.63
				25	0	22.25	20.10	22.25	44.77	-24.67
5	23035	701.5	16QAM	1	0	22.08	19.93	22.08	44.77	-24.84
				1	24	22.15	20.00	22.15	44.77	-24.77
				12	6	21.29	19.14	21.29	44.77	-25.63
				25	0	21.31	19.16	21.31	44.77	-25.61
	23095	707.5	16QAM	1	0	21.96	19.81	21.96	44.77	-24.96
				1	24	21.87	19.72	21.87	44.77	-25.05
				12	6	21.05	18.90	21.05	44.77	-25.87
				25	0	21.27	19.12	21.27	44.77	-25.65
	23155	713.5	16QAM	1	0	21.92	19.77	21.92	44.77	-25.00
				1	24	22.02	19.87	22.02	44.77	-24.90
				12	6	21.32	19.17	21.32	44.77	-25.60
				25	0	21.37	19.22	21.37	44.77	-25.55

Unless otherwise stated the results shown in this test report refer only to the sample(s) tested and such sample(s) are retained for 90 days only.

除非另有說明，此報告結果僅對測試之樣品負責，同時此樣品僅保留90天。本報告未經本公司書面許可，不可部份複製。

This document is issued by the Company subject to its General Conditions of Service printed overleaf, available on request or accessible at <http://www.sgs.com.tw/Terms-and-Conditions> and for electronic format documents, subject to Terms and Conditions for Electronic Documents at <http://www.sgs.com.tw/Terms-and-Conditions>. Attention is drawn to the limitation of liability, indemnification and jurisdiction issues defined therein. Any holder of this document is advised that information contained hereon reflects the Company's findings at the time of its intervention only and within the limits of Client's instructions, if any. The Company's sole responsibility is to its Client and this document does not exonerate parties to a transaction from exercising all their rights and obligations under the transaction documents. This document cannot be reproduced except in full, without prior written approval of the Company. Any unauthorized alteration, forgery or falsification of the content or appearance of this document is unlawful and offenders may be prosecuted to the fullest extent of the law.

Antenna gain (dBi)		0								
LTE Band 12_Uplink frequency band : 699 to 716 MHz										
BW (MHz)	UL Channel	Frequency (MHz)	Modulation	RB Size	RB Offset	Conducted Average (dBm)	ERP Average (dBm)	EIRP Average (dBm)	ERP Limit (dBm)	Margin (dB)
10	23060	704	QPSK	1	0	23.17	21.02	23.17	44.77	-23.75
				1	49	23.40	21.25	23.40	44.77	-23.52
				25	12	22.30	20.15	22.30	44.77	-24.62
				50	0	22.10	19.95	22.10	44.77	-24.82
	23095	707.5	QPSK	1	0	23.21	21.06	23.21	44.77	-23.71
				1	49	23.42	21.27	23.42	44.77	-23.50
				25	12	22.23	20.08	22.23	44.77	-24.69
				50	0	22.16	20.01	22.16	44.77	-24.76
	23130	711	QPSK	1	0	23.21	21.06	23.21	44.77	-23.71
				1	49	23.23	21.08	23.23	44.77	-23.69
				25	12	22.31	20.16	22.31	44.77	-24.61
				50	0	22.23	20.08	22.23	44.77	-24.69
10	23060	704	16QAM	1	0	21.80	19.65	21.80	44.77	-25.12
				1	49	21.96	19.81	21.96	44.77	-24.96
				25	12	21.31	19.16	21.31	44.77	-25.61
				50	0	21.25	19.10	21.25	44.77	-25.67
	23095	707.5	16QAM	1	0	21.69	19.54	21.69	44.77	-25.23
				1	49	21.94	19.79	21.94	44.77	-24.98
				25	12	21.15	19.00	21.15	44.77	-25.77
				50	0	21.10	18.95	21.10	44.77	-25.82
	23130	711	16QAM	1	0	22.02	19.87	22.02	44.77	-24.90
				1	49	22.13	19.98	22.13	44.77	-24.79
				25	12	21.34	19.19	21.34	44.77	-25.58
				50	0	21.12	18.97	21.12	44.77	-25.80

Unless otherwise stated the results shown in this test report refer only to the sample(s) tested and such sample(s) are retained for 90 days only.

除非另有說明，此報告結果僅對測試之樣品負責，同時此樣品僅保留90天。本報告未經本公司書面許可，不可部份複製。

This document is issued by the Company subject to its General Conditions of Service printed overleaf, available on request or accessible at <http://www.sgs.com.tw/Terms-and-Conditions> and for electronic format documents, subject to Terms and Conditions for Electronic Documents at <http://www.sgs.com.tw/Terms-and-Conditions>. Attention is drawn to the limitation of liability, indemnification and jurisdiction issues defined therein. Any holder of this document is advised that information contained hereon reflects the Company's findings at the time of its intervention only and within the limits of Client's instructions, if any. The Company's sole responsibility is to its Client and this document does not exonerate parties to a transaction from exercising all their rights and obligations under the transaction documents. This document cannot be reproduced except in full, without prior written approval of the Company. Any unauthorized alteration, forgery or falsification of the content or appearance of this document is unlawful and offenders may be prosecuted to the fullest extent of the law.

Antenna gain (dBi)		-0.8								
LTE Band 13_Uplink frequency band : 777 to 787 MHz										
BW (MHz)	UL Channel	Frequency (MHz)	Modulation	RB Size	RB Offset	Conducted Average (dBm)	ERP Average (dBm)	EIRP Average (dBm)	ERP Limit (dBm)	Margin (dB)
5	23205	779.5	QPSK	1	0	23.55	20.60	22.75	44.77	-24.17
				1	24	23.46	20.51	22.66	44.77	-24.26
				12	6	22.41	19.46	21.61	44.77	-25.31
				25	0	22.46	19.51	21.66	44.77	-25.26
	23230	782	QPSK	1	0	23.54	20.59	22.74	44.77	-24.18
				1	24	23.49	20.54	22.69	44.77	-24.23
				12	6	22.49	19.54	21.69	44.77	-25.23
				25	0	22.41	19.46	21.61	44.77	-25.31
	23255	784.5	QPSK	1	0	23.34	20.39	22.54	44.77	-24.38
				1	24	23.67	20.72	22.87	44.77	-24.05
				12	6	22.40	19.45	21.60	44.77	-25.32
				25	0	22.44	19.49	21.64	44.77	-25.28
5	23205	779.5	16QAM	1	0	21.78	18.83	20.98	44.77	-25.94
				1	24	22.20	19.25	21.40	44.77	-25.52
				12	6	21.45	18.50	20.65	44.77	-26.27
				25	0	21.45	18.50	20.65	44.77	-26.27
	23230	782	16QAM	1	0	22.06	19.11	21.26	44.77	-25.66
				1	24	22.11	19.16	21.31	44.77	-25.61
				12	6	21.39	18.44	20.59	44.77	-26.33
				25	0	21.28	18.33	20.48	44.77	-26.44
	23255	784.5	16QAM	1	0	21.98	19.03	21.18	44.77	-25.74
				1	24	22.19	19.24	21.39	44.77	-25.53
				12	6	21.39	18.44	20.59	44.77	-26.33
				25	0	21.47	18.52	20.67	44.77	-26.25
Antenna gain (dBi)		-0.8								
LTE Band 13_Uplink frequency band : 777 to 787 MHz										
BW (MHz)	UL Channel	Frequency (MHz)	Modulation	RB Size	RB Offset	Conducted Average (dBm)	ERP Average (dBm)	EIRP Average (dBm)	ERP Limit (dBm)	Margin (dB)
10	23230	782	QPSK	1	0	23.41	20.46	22.61	44.77	-24.31
				1	49	23.58	20.63	22.78	44.77	-24.14
				25	12	22.42	19.47	21.62	44.77	-25.30
				50	0	22.34	19.39	21.54	44.77	-25.38
10	23230	782	16QAM	1	0	22.13	19.18	21.33	44.77	-25.59
				1	49	22.18	19.23	21.38	44.77	-25.54
				25	12	21.37	18.42	20.57	44.77	-26.35
				50	0	21.24	18.29	20.44	44.77	-26.48

Unless otherwise stated the results shown in this test report refer only to the sample(s) tested and such sample(s) are retained for 90 days only.

除非另有說明，此報告結果僅對測試之樣品負責，同時此樣品僅保留90天。本報告未經本公司書面許可，不可部份複製。

This document is issued by the Company subject to its General Conditions of Service printed overleaf, available on request or accessible at <http://www.sgs.com.tw/Terms-and-Conditions> and for electronic format documents, subject to Terms and Conditions for Electronic Documents at <http://www.sgs.com.tw/Terms-and-Conditions>. Attention is drawn to the limitation of liability, indemnification and jurisdiction issues defined therein. Any holder of this document is advised that information contained hereon reflects the Company's findings at the time of its intervention only and within the limits of Client's instructions, if any. The Company's sole responsibility is to its Client and this document does not exonerate parties to a transaction from exercising all their rights and obligations under the transaction documents. This document cannot be reproduced except in full, without prior written approval of the Company. Any unauthorized alteration, forgery or falsification of the content or appearance of this document is unlawful and offenders may be prosecuted to the fullest extent of the law.

Antenna gain (dBi)		-1.1								
LTE Band 14_Uplink frequency band : 788 to 798 MHz										
BW (MHz)	UL Channel	Frequency (MHz)	Modulation	RB Size	RB Offset	Conducted Average (dBm)	ERP Average (dBm)	EIRP Average (dBm)	ERP Limit (dBm)	Margin (dB)
5	23305	790.5	QPSK	1	0	23.21	20.26	22.41	44.77	-24.51
				1	24	23.36	20.41	22.56	44.77	-24.36
				12	6	22.38	19.43	21.58	44.77	-25.34
				25	0	22.29	19.34	21.49	44.77	-25.43
	23330	793	QPSK	1	0	23.26	20.31	22.46	44.77	-24.46
				1	24	23.26	20.31	22.46	44.77	-24.46
				12	6	22.28	19.33	21.48	44.77	-25.44
				25	0	22.30	19.35	21.50	44.77	-25.42
	23355	795.5	QPSK	1	0	23.15	20.20	22.35	44.77	-24.57
				1	24	23.25	20.30	22.45	44.77	-24.47
				12	6	22.30	19.35	21.50	44.77	-25.42
				25	0	22.26	19.31	21.46	44.77	-25.46
5	23305	790.5	16QAM	1	0	21.96	19.01	21.16	44.77	-25.76
				1	24	21.99	19.04	21.19	44.77	-25.73
				12	6	21.06	18.11	20.26	44.77	-26.66
				25	0	21.26	18.31	20.46	44.77	-26.46
	23330	793	16QAM	1	0	21.94	18.99	21.14	44.77	-25.78
				1	24	21.90	18.95	21.10	44.77	-25.82
				12	6	21.08	18.13	20.28	44.77	-26.64
				25	0	21.23	18.28	20.43	44.77	-26.49
	23355	795.5	16QAM	1	0	21.89	18.94	21.09	44.77	-25.83
				1	24	22.09	19.14	21.29	44.77	-25.63
				12	6	21.24	18.29	20.44	44.77	-26.48
				25	0	21.31	18.36	20.51	44.77	-26.41
Antenna gain (dBi)		-1.1								
LTE Band 14_Uplink frequency band : 788 to 798 MHz										
BW (MHz)	UL Channel	Frequency (MHz)	Modulation	RB Size	RB Offset	Conducted Average (dBm)	ERP Average (dBm)	EIRP Average (dBm)	ERP Limit (dBm)	Margin (dB)
10	23330	793	QPSK	1	0	23.18	20.23	22.38	44.77	-24.54
				1	49	23.25	20.30	22.45	44.77	-24.47
				25	12	22.34	19.39	21.54	44.77	-25.38
				50	0	22.19	19.24	21.39	44.77	-25.53
10	23330	793	16QAM	1	0	21.85	18.90	21.05	44.77	-25.87
				1	49	21.94	18.99	21.14	44.77	-25.78
				25	12	21.23	18.28	20.43	44.77	-26.49
				50	0	21.32	18.37	20.52	44.77	-26.40

Unless otherwise stated the results shown in this test report refer only to the sample(s) tested and such sample(s) are retained for 90 days only.

除非另有說明，此報告結果僅對測試之樣品負責，同時此樣品僅保留90天。本報告未經本公司書面許可，不可部份複製。

This document is issued by the Company subject to its General Conditions of Service printed overleaf, available on request or accessible at <http://www.sgs.com.tw/Terms-and-Conditions> and for electronic format documents, subject to Terms and Conditions for Electronic Documents at <http://www.sgs.com.tw/Terms-and-Conditions>. Attention is drawn to the limitation of liability, indemnification and jurisdiction issues defined therein. Any holder of this document is advised that information contained hereon reflects the Company's findings at the time of its intervention only and within the limits of Client's instructions, if any. The Company's sole responsibility is to its Client and this document does not exonerate parties to a transaction from exercising all their rights and obligations under the transaction documents. This document cannot be reproduced except in full, without prior written approval of the Company. Any unauthorized alteration, forgery or falsification of the content or appearance of this document is unlawful and offenders may be prosecuted to the fullest extent of the law.

Antenna gain (dBi)		2.5							
LTE Band 66_Uplink frequency band : 1710 to 1780 MHz									
BW (MHz)	UL Channel	Frequency (MHz)	Modulation	RB Size	RB Offset	Conducted Average (dBm)	EIRP Average (dBm)	EIRP Limit (dBm)	Margin (dB)
1.4	131979	1710.7	QPSK	1	0	23.16	25.66	30	-4.34
				1	5	23.19	25.69	30	-4.31
				3	2	23.22	25.72	30	-4.28
				6	0	22.26	24.76	30	-5.24
	132322	1745	QPSK	1	0	23.37	25.87	30	-4.13
				1	5	23.38	25.88	30	-4.12
				3	2	23.31	25.81	30	-4.19
				6	0	22.29	24.79	30	-5.21
	132665	1779.3	QPSK	1	0	23.02	25.52	30	-4.48
				1	5	23.02	25.52	30	-4.48
				3	2	23.20	25.70	30	-4.3
				6	0	22.13	24.63	30	-5.37
1.4	131979	1710.7	16QAM	1	0	21.92	24.42	30	-5.58
				1	5	21.83	24.33	30	-5.67
				3	2	22.17	24.67	30	-5.33
				6	0	21.22	23.72	30	-6.28
	132322	1745	16QAM	1	0	22.04	24.54	30	-5.46
				1	5	22.07	24.57	30	-5.43
				3	2	22.04	24.54	30	-5.46
				6	0	21.19	23.69	30	-6.31
	132665	1779.3	16QAM	1	0	22.03	24.53	30	-5.47
				1	5	22.00	24.50	30	-5.5
				3	2	22.12	24.62	30	-5.38
				6	0	20.98	23.48	30	-6.52

Unless otherwise stated the results shown in this test report refer only to the sample(s) tested and such sample(s) are retained for 90 days only.

除非另有說明，此報告結果僅對測試之樣品負責，同時此樣品僅保留90天。本報告未經本公司書面許可，不可部份複製。

This document is issued by the Company subject to its General Conditions of Service printed overleaf, available on request or accessible at <http://www.sgs.com.tw/Terms-and-Conditions> and for electronic format documents, subject to Terms and Conditions for Electronic Documents at <http://www.sgs.com.tw/Terms-and-Conditions>. Attention is drawn to the limitation of liability, indemnification and jurisdiction issues defined therein. Any holder of this document is advised that information contained hereon reflects the Company's findings at the time of its intervention only and within the limits of Client's instructions, if any. The Company's sole responsibility is to its Client and this document does not exonerate parties to a transaction from exercising all their rights and obligations under the transaction documents. This document cannot be reproduced except in full, without prior written approval of the Company. Any unauthorized alteration, forgery or falsification of the content or appearance of this document is unlawful and offenders may be prosecuted to the fullest extent of the law.

Antenna gain (dBi)		2.5							
LTE Band 66_Uplink frequency band : 1710 to 1780 MHz									
BW (MHz)	UL Channel	Frequency (MHz)	Modulation	RB Size	RB Offset	Conducted Average (dBm)	EIRP Average (dBm)	EIRP Limit (dBm)	Margin (dB)
3	131987	1711.5	QPSK	1	0	23.18	25.68	30	-4.32
				1	14	23.23	25.73	30	-4.27
				8	4	22.22	24.72	30	-5.28
				15	0	22.15	24.65	30	-5.35
	132322	1745	QPSK	1	0	23.32	25.82	30	-4.18
				1	14	23.29	25.79	30	-4.21
				8	4	22.25	24.75	30	-5.25
				15	0	22.19	24.69	30	-5.31
	132657	1778.5	QPSK	1	0	23.02	25.52	30	-4.48
				1	14	23.10	25.60	30	-4.4
				8	4	22.20	24.70	30	-5.3
				15	0	22.12	24.62	30	-5.38
3	131987	1711.5	16QAM	1	0	22.16	24.66	30	-5.34
				1	14	22.10	24.60	30	-5.4
				8	4	21.08	23.58	30	-6.42
				15	0	21.02	23.52	30	-6.48
	132322	1745	16QAM	1	0	22.39	24.89	30	-5.11
				1	14	22.22	24.72	30	-5.28
				8	4	21.17	23.67	30	-6.33
				15	0	21.21	23.71	30	-6.29
	132657	1778.5	16QAM	1	0	22.06	24.56	30	-5.44
				1	14	21.90	24.40	30	-5.6
				8	4	21.27	23.77	30	-6.23
				15	0	21.19	23.69	30	-6.31

Unless otherwise stated the results shown in this test report refer only to the sample(s) tested and such sample(s) are retained for 90 days only.

除非另有說明，此報告結果僅對測試之樣品負責，同時此樣品僅保留90天。本報告未經本公司書面許可，不可部份複製。

This document is issued by the Company subject to its General Conditions of Service printed overleaf, available on request or accessible at <http://www.sgs.com.tw/Terms-and-Conditions> and for electronic format documents, subject to Terms and Conditions for Electronic Documents at <http://www.sgs.com.tw/Terms-and-Conditions>. Attention is drawn to the limitation of liability, indemnification and jurisdiction issues defined therein. Any holder of this document is advised that information contained hereon reflects the Company's findings at the time of its intervention only and within the limits of Client's instructions, if any. The Company's sole responsibility is to its Client and this document does not exonerate parties to a transaction from exercising all their rights and obligations under the transaction documents. This document cannot be reproduced except in full, without prior written approval of the Company. Any unauthorized alteration, forgery or falsification of the content or appearance of this document is unlawful and offenders may be prosecuted to the fullest extent of the law.

Antenna gain (dBi)		2.5							
LTE Band 66_Uplink frequency band : 1710 to 1780 MHz									
BW (MHz)	UL Channel	Frequency (MHz)	Modulation	RB Size	RB Offset	Conducted Average (dBm)	EIRP Average (dBm)	EIRP Limit (dBm)	Margin (dB)
5	131997	1712.5	QPSK	1	0	23.14	25.64	30	-4.36
				1	24	23.25	25.75	30	-4.25
				12	6	22.25	24.75	30	-5.25
				25	0	22.19	24.69	30	-5.31
	132322	1745	QPSK	1	0	23.26	25.76	30	-4.24
				1	24	23.32	25.82	30	-4.18
				12	6	22.22	24.72	30	-5.28
				25	0	22.28	24.78	30	-5.22
	132647	1777.5	QPSK	1	0	22.89	25.39	30	-4.61
				1	24	23.02	25.52	30	-4.48
				12	6	22.08	24.58	30	-5.42
				25	0	21.99	24.49	30	-5.51
5	131997	1712.5	16QAM	1	0	21.99	24.49	30	-5.51
				1	24	21.99	24.49	30	-5.51
				12	6	21.29	23.79	30	-6.21
				25	0	21.20	23.70	30	-6.3
	132322	1745	16QAM	1	0	22.71	25.21	30	-4.79
				1	24	22.17	24.67	30	-5.33
				12	6	21.02	23.52	30	-6.48
				25	0	21.17	23.67	30	-6.33
	132647	1777.5	16QAM	1	0	22.18	24.68	30	-5.32
				1	24	21.96	24.46	30	-5.54
				12	6	21.09	23.59	30	-6.41
				25	0	21.10	23.60	30	-6.4

Unless otherwise stated the results shown in this test report refer only to the sample(s) tested and such sample(s) are retained for 90 days only.

除非另有說明，此報告結果僅對測試之樣品負責，同時此樣品僅保留90天。本報告未經本公司書面許可，不可部份複製。

This document is issued by the Company subject to its General Conditions of Service printed overleaf, available on request or accessible at <http://www.sgs.com.tw/Terms-and-Conditions> and for electronic format documents, subject to Terms and Conditions for Electronic Documents at <http://www.sgs.com.tw/Terms-and-Conditions>. Attention is drawn to the limitation of liability, indemnification and jurisdiction issues defined therein. Any holder of this document is advised that information contained hereon reflects the Company's findings at the time of its intervention only and within the limits of Client's instructions, if any. The Company's sole responsibility is to its Client and this document does not exonerate parties to a transaction from exercising all their rights and obligations under the transaction documents. This document cannot be reproduced except in full, without prior written approval of the Company. Any unauthorized alteration, forgery or falsification of the content or appearance of this document is unlawful and offenders may be prosecuted to the fullest extent of the law.

Antenna gain (dBi)	2.5
--------------------	-----

LTE Band 66_Uplink frequency band : 1710 to 1780 MHz									
BW (MHz)	UL Channel	Frequency (MHz)	Modulation	RB Size	RB Offset	Conducted Average (dBm)	EIRP Average (dBm)	EIRP Limit (dBm)	Margin (dB)
10	132022	1715	QPSK	1	0	23.09	25.59	30	-4.41
				1	49	23.34	25.84	30	-4.16
				25	12	22.30	24.80	30	-5.2
				50	0	22.28	24.78	30	-5.22
	132322	1745	QPSK	1	0	23.45	25.95	30	-4.05
				1	49	23.58	26.08	30	-3.92
				25	12	22.39	24.89	30	-5.11
				50	0	22.34	24.84	30	-5.16
	132622	1775	QPSK	1	0	23.25	25.75	30	-4.25
				1	49	23.06	25.56	30	-4.44
				25	12	22.04	24.54	30	-5.46
				50	0	22.00	24.50	30	-5.5
10	132022	1715	16QAM	1	0	22.23	24.73	30	-5.27
				1	49	22.12	24.62	30	-5.38
				25	12	21.32	23.82	30	-6.18
				50	0	21.15	23.65	30	-6.35
	132322	1745	16QAM	1	0	22.24	24.74	30	-5.26
				1	49	22.36	24.86	30	-5.14
				25	12	21.34	23.84	30	-6.16
				50	0	21.42	23.92	30	-6.08
	132622	1775	16QAM	1	0	21.74	24.24	30	-5.76
				1	49	21.77	24.27	30	-5.73
				25	12	20.95	23.45	30	-6.55
				50	0	21.02	23.52	30	-6.48

Unless otherwise stated the results shown in this test report refer only to the sample(s) tested and such sample(s) are retained for 90 days only.

除非另有說明，此報告結果僅對測試之樣品負責，同時此樣品僅保留90天。本報告未經本公司書面許可，不可部份複製。

This document is issued by the Company subject to its General Conditions of Service printed overleaf, available on request or accessible at <http://www.sgs.com.tw/Terms-and-Conditions> and for electronic format documents, subject to Terms and Conditions for Electronic Documents at <http://www.sgs.com.tw/Terms-and-Conditions>. Attention is drawn to the limitation of liability, indemnification and jurisdiction issues defined therein. Any holder of this document is advised that information contained hereon reflects the Company's findings at the time of its intervention only and within the limits of Client's instructions, if any. The Company's sole responsibility is to its Client and this document does not exonerate parties to a transaction from exercising all their rights and obligations under the transaction documents. This document cannot be reproduced except in full, without prior written approval of the Company. Any unauthorized alteration, forgery or falsification of the content or appearance of this document is unlawful and offenders may be prosecuted to the fullest extent of the law.

Antenna gain (dBi)		2.5							
LTE Band 66_Uplink frequency band : 1710 to 1780 MHz									
BW (MHz)	UL Channel	Frequency (MHz)	Modulation	RB Size	RB Offset	Conducted Average (dBm)	EIRP Average (dBm)	EIRP Limit (dBm)	Margin (dB)
15	132047	1717.5	QPSK	1	0	23.40	25.90	30	-4.1
				1	74	23.28	25.78	30	-4.22
				36	18	22.48	24.98	30	-5.02
				75	0	22.31	24.81	30	-5.19
	132322	1745	QPSK	1	0	23.46	25.96	30	-4.04
				1	74	23.44	25.94	30	-4.06
				36	18	22.38	24.88	30	-5.12
				75	0	22.21	24.71	30	-5.29
	132597	1772.5	QPSK	1	0	23.24	25.74	30	-4.26
				1	74	23.10	25.60	30	-4.4
				36	18	22.15	24.65	30	-5.35
				75	0	22.06	24.56	30	-5.44
15	132047	1717.5	16QAM	1	0	22.48	24.98	30	-5.02
				1	74	22.25	24.75	30	-5.25
				36	18	21.37	23.87	30	-6.13
				75	0	21.25	23.75	30	-6.25
	132322	1745	16QAM	1	0	21.82	24.32	30	-5.68
				1	74	22.06	24.56	30	-5.44
				36	18	21.31	23.81	30	-6.19
				75	0	21.30	23.80	30	-6.2
	132597	1772.5	16QAM	1	0	22.04	24.54	30	-5.46
				1	74	22.03	24.53	30	-5.47
				36	18	21.01	23.51	30	-6.49
				75	0	21.15	23.65	30	-6.35

Unless otherwise stated the results shown in this test report refer only to the sample(s) tested and such sample(s) are retained for 90 days only.

除非另有說明，此報告結果僅對測試之樣品負責，同時此樣品僅保留90天。本報告未經本公司書面許可，不可部份複製。

This document is issued by the Company subject to its General Conditions of Service printed overleaf, available on request or accessible at <http://www.sgs.com.tw/Terms-and-Conditions> and for electronic format documents, subject to Terms and Conditions for Electronic Documents at <http://www.sgs.com.tw/Terms-and-Conditions>. Attention is drawn to the limitation of liability, indemnification and jurisdiction issues defined therein. Any holder of this document is advised that information contained hereon reflects the Company's findings at the time of its intervention only and within the limits of Client's instructions, if any. The Company's sole responsibility is to its Client and this document does not exonerate parties to a transaction from exercising all their rights and obligations under the transaction documents. This document cannot be reproduced except in full, without prior written approval of the Company. Any unauthorized alteration, forgery or falsification of the content or appearance of this document is unlawful and offenders may be prosecuted to the fullest extent of the law.

Antenna gain (dBi)		2.5							
LTE Band 66_Uplink frequency band : 1710 to 1780 MHz									
BW (MHz)	UL Channel	Frequency (MHz)	Modulation	RB Size	RB Offset	Conducted Average (dBm)	EIRP Average (dBm)	EIRP Limit (dBm)	Margin (dB)
20	132072	1720	QPSK	1	0	23.39	25.89	30	-4.11
				1	99	23.13	25.63	30	-4.37
				50	25	22.36	24.86	30	-5.14
				100	0	22.15	24.65	30	-5.35
	132322	1745	QPSK	1	0	23.31	25.81	30	-4.19
				1	99	23.40	25.90	30	-4.1
				50	25	22.42	24.92	30	-5.08
				100	0	22.24	24.74	30	-5.26
	132572	1770	QPSK	1	0	23.29	25.79	30	-4.21
				1	99	23.28	25.78	30	-4.22
				50	25	22.16	24.66	30	-5.34
				100	0	22.13	24.63	30	-5.37
20	132072	1720	16QAM	1	0	22.23	24.73	30	-5.27
				1	99	21.72	24.22	30	-5.78
				50	25	21.20	23.70	30	-6.3
				100	0	21.16	23.66	30	-6.34
	132322	1745	16QAM	1	0	21.31	23.81	30	-6.19
				1	99	22.17	24.67	30	-5.33
				50	25	21.37	23.87	30	-6.13
				100	0	21.21	23.71	30	-6.29
	132572	1770	16QAM	1	0	22.32	24.82	30	-5.18
				1	99	22.01	24.51	30	-5.49
				50	25	21.25	23.75	30	-6.25
				100	0	20.86	23.36	30	-6.64

Unless otherwise stated the results shown in this test report refer only to the sample(s) tested and such sample(s) are retained for 90 days only.

除非另有說明，此報告結果僅對測試之樣品負責，同時此樣品僅保留90天。本報告未經本公司書面許可，不可部份複製。

This document is issued by the Company subject to its General Conditions of Service printed overleaf, available on request or accessible at <http://www.sgs.com.tw/Terms-and-Conditions> and for electronic format documents, subject to Terms and Conditions for Electronic Documents at <http://www.sgs.com.tw/Terms-and-Conditions>. Attention is drawn to the limitation of liability, indemnification and jurisdiction issues defined therein. Any holder of this document is advised that information contained hereon reflects the Company's findings at the time of its intervention only and within the limits of Client's instructions, if any. The Company's sole responsibility is to its Client and this document does not exonerate parties to a transaction from exercising all their rights and obligations under the transaction documents. This document cannot be reproduced except in full, without prior written approval of the Company. Any unauthorized alteration, forgery or falsification of the content or appearance of this document is unlawful and offenders may be prosecuted to the fullest extent of the law.

Antenna gain (dBi)		-1.1							
LTE Band 71_Uplink frequency band : 663 to 698 MHz									
BW (MHz)	UL Channel	Frequency (MHz)	Modulation	RB Size	RB Offset	Conducted Average (dBm)	ERP Average (dBm)	ERP Limit (dBm)	Margin (dB)
5	133147	665.5	QPSK	1	0	23.13	23.13	44.77	-21.6412
				1	24	23.22	23.22	44.77	-21.5512
				12	6	22.17	22.17	44.77	-22.6012
				25	0	22.15	22.15	44.77	-22.6212
	133297	680.5	QPSK	1	0	23.07	23.07	44.77	-21.7012
				1	24	23.03	23.03	44.77	-21.7412
				12	6	22.10	22.10	44.77	-22.6712
				25	0	22.10	22.10	44.77	-22.6712
	133447	695.5	QPSK	1	0	22.94	22.94	44.77	-21.8312
				1	24	23.06	23.06	44.77	-21.7112
				12	6	22.10	22.10	44.77	-22.6712
				25	0	22.10	22.10	44.77	-22.6712
5	133147	665.5	16QAM	1	0	21.85	21.85	44.77	-22.9212
				1	24	21.76	21.76	44.77	-23.0112
				12	6	21.04	21.04	44.77	-23.7312
				25	0	21.05	21.05	44.77	-23.7212
	133297	680.5	16QAM	1	0	22.05	22.05	44.77	-22.7212
				1	24	22.03	22.03	44.77	-22.7412
				12	6	20.80	20.80	44.77	-23.9712
				25	0	21.23	21.23	44.77	-23.5412
	133447	695.5	16QAM	1	0	22.05	22.05	44.77	-22.7212
				1	24	22.03	22.03	44.77	-22.7412
				12	6	20.80	20.80	44.77	-23.9712
				25	0	21.23	21.23	44.77	-23.5412

Unless otherwise stated the results shown in this test report refer only to the sample(s) tested and such sample(s) are retained for 90 days only.

除非另有說明，此報告結果僅對測試之樣品負責，同時此樣品僅保留90天。本報告未經本公司書面許可，不可部份複製。

This document is issued by the Company subject to its General Conditions of Service printed overleaf, available on request or accessible at <http://www.sgs.com.tw/Terms-and-Conditions> and for electronic format documents, subject to Terms and Conditions for Electronic Documents at <http://www.sgs.com.tw/Terms-and-Conditions>. Attention is drawn to the limitation of liability, indemnification and jurisdiction issues defined therein. Any holder of this document is advised that information contained hereon reflects the Company's findings at the time of its intervention only and within the limits of Client's instructions, if any. The Company's sole responsibility is to its Client and this document does not exonerate parties to a transaction from exercising all their rights and obligations under the transaction documents. This document cannot be reproduced except in full, without prior written approval of the Company. Any unauthorized alteration, forgery or falsification of the content or appearance of this document is unlawful and offenders may be prosecuted to the fullest extent of the law.

Antenna gain (dBi)		-1.1							
LTE Band 71_Uplink frequency band : 663 to 698 MHz									
BW (MHz)	UL Channel	Frequency (MHz)	Modulation	RB Size	RB Offset	Conducted Average (dBm)	ERP Average (dBm)	ERP Limit (dBm)	Margin (dB)
10	133172	668	QPSK	1	0	23.15	23.15	44.77	-21.6212
				1	49	23.28	23.28	44.77	-21.4912
				25	12	22.21	22.21	44.77	-22.5612
				50	0	22.20	22.20	44.77	-22.5712
	133297	680.5	QPSK	1	0	23.21	23.21	44.77	-21.5612
				1	49	23.07	23.07	44.77	-21.7012
				25	12	22.22	22.22	44.77	-22.5512
				50	0	22.23	22.23	44.77	-22.5412
	133422	693	QPSK	1	0	22.98	22.98	44.77	-21.7912
				1	49	23.07	23.07	44.77	-21.7012
				25	12	22.24	22.24	44.77	-22.5312
				50	0	22.20	22.20	44.77	-22.5712
10	133172	668	16QAM	1	0	22.07	22.07	44.77	-22.7012
				1	49	22.07	22.07	44.77	-22.7012
				25	12	21.12	21.12	44.77	-23.6512
				50	0	21.21	21.21	44.77	-23.5612
	133297	680.5	16QAM	1	0	21.70	21.70	44.77	-23.0712
				1	49	22.35	22.35	44.77	-22.4212
				25	12	21.13	21.13	44.77	-23.6412
				50	0	21.24	21.24	44.77	-23.5312
	133422	693	16QAM	1	0	22.08	22.08	44.77	-22.6912
				1	49	21.74	21.74	44.77	-23.0312
				25	12	21.16	21.16	44.77	-23.6112
				50	0	21.12	21.12	44.77	-23.6512

Unless otherwise stated the results shown in this test report refer only to the sample(s) tested and such sample(s) are retained for 90 days only.

除非另有說明，此報告結果僅對測試之樣品負責，同時此樣品僅保留90天。本報告未經本公司書面許可，不可部份複製。

This document is issued by the Company subject to its General Conditions of Service printed overleaf, available on request or accessible at <http://www.sgs.com.tw/Terms-and-Conditions> and for electronic format documents, subject to Terms and Conditions for Electronic Documents at <http://www.sgs.com.tw/Terms-and-Conditions>. Attention is drawn to the limitation of liability, indemnification and jurisdiction issues defined therein. Any holder of this document is advised that information contained hereon reflects the Company's findings at the time of its intervention only and within the limits of Client's instructions, if any. The Company's sole responsibility is to its Client and this document does not exonerate parties to a transaction from exercising all their rights and obligations under the transaction documents. This document cannot be reproduced except in full, without prior written approval of the Company. Any unauthorized alteration, forgery or falsification of the content or appearance of this document is unlawful and offenders may be prosecuted to the fullest extent of the law.

Antenna gain (dBi)		-1.1							
LTE Band 71_Uplink frequency band : 663 to 698 MHz									
BW (MHz)	UL Channel	Frequency (MHz)	Modulation	RB Size	RB Offset	Conducted Average (dBm)	ERP Average (dBm)	ERP Limit (dBm)	Margin (dB)
15	133197	670.5	QPSK	1	0	23.15	23.15	44.77	-21.6212
				1	74	23.22	23.22	44.77	-21.5512
				36	18	22.18	22.18	44.77	-22.5912
				75	0	22.19	22.19	44.77	-22.5812
	133297	680.5	QPSK	1	0	22.98	22.98	44.77	-21.7912
				1	74	23.07	23.07	44.77	-21.7012
				36	18	22.06	22.06	44.77	-22.7112
				75	0	22.09	22.09	44.77	-22.6812
	133397	690.5	QPSK	1	0	22.95	22.95	44.77	-21.8212
				1	74	23.04	23.04	44.77	-21.7312
				36	18	22.19	22.19	44.77	-22.5812
				75	0	22.17	22.17	44.77	-22.6012
15	133197	670.5	16QAM	1	0	22.03	22.03	44.77	-22.7412
				1	74	21.85	21.85	44.77	-22.9212
				36	18	21.07	21.07	44.77	-23.7012
				75	0	21.28	21.28	44.77	-23.4912
	133297	680.5	16QAM	1	0	22.05	22.05	44.77	-22.7212
				1	74	22.20	22.20	44.77	-22.5712
				36	18	21.00	21.00	44.77	-23.7712
				75	0	21.08	21.08	44.77	-23.6912
	133397	690.5	16QAM	1	0	22.64	22.64	44.77	-22.1312
				1	74	22.33	22.33	44.77	-22.4412
				36	18	21.12	21.12	44.77	-23.6512
				75	0	21.25	21.25	44.77	-23.5212

Unless otherwise stated the results shown in this test report refer only to the sample(s) tested and such sample(s) are retained for 90 days only.

除非另有說明，此報告結果僅對測試之樣品負責，同時此樣品僅保留90天。本報告未經本公司書面許可，不可部份複製。

This document is issued by the Company subject to its General Conditions of Service printed overleaf, available on request or accessible at <http://www.sgs.com.tw/Terms-and-Conditions> and for electronic format documents, subject to Terms and Conditions for Electronic Documents at <http://www.sgs.com.tw/Terms-and-Conditions>. Attention is drawn to the limitation of liability, indemnification and jurisdiction issues defined therein. Any holder of this document is advised that information contained hereon reflects the Company's findings at the time of its intervention only and within the limits of Client's instructions, if any. The Company's sole responsibility is to its Client and this document does not exonerate parties to a transaction from exercising all their rights and obligations under the transaction documents. This document cannot be reproduced except in full, without prior written approval of the Company. Any unauthorized alteration, forgery or falsification of the content or appearance of this document is unlawful and offenders may be prosecuted to the fullest extent of the law.

Antenna gain (dBi)		-1.1							
LTE Band 71_Uplink frequency band : 663 to 698 MHz									
BW (MHz)	UL Channel	Frequency (MHz)	Modulation	RB Size	RB Offset	Conducted Average (dBm)	ERP Average (dBm)	ERP Limit (dBm)	Margin (dB)
20	133222	673	QPSK	1	0	23.11	23.11	44.77	-21.6612
				1	99	23.20	23.20	44.77	-21.5712
				50	25	22.15	22.15	44.77	-22.6212
				100	0	21.97	21.97	44.77	-22.8012
	133297	680.5	QPSK	1	0	23.14	23.14	44.77	-21.6312
				1	99	23.02	23.02	44.77	-21.7512
				50	25	22.13	22.13	44.77	-22.6412
				100	0	22.20	22.20	44.77	-22.5712
	133372	688	QPSK	1	0	22.92	22.92	44.77	-21.8512
				1	99	23.01	23.01	44.77	-21.7612
				50	25	22.16	22.16	44.77	-22.6112
				100	0	22.13	22.13	44.77	-22.6412
20	133222	673	16QAM	1	0	21.70	21.70	44.77	-23.0712
				1	99	21.82	21.82	44.77	-22.9512
				50	25	21.20	21.20	44.77	-23.5712
				100	0	20.92	20.92	44.77	-23.8512
	133297	680.5	16QAM	1	0	22.21	22.21	44.77	-22.5612
				1	99	21.74	21.74	44.77	-23.0312
				50	25	21.11	21.11	44.77	-23.6612
				100	0	21.11	21.11	44.77	-23.6612
	133372	688	16QAM	1	0	21.78	21.78	44.77	-22.9912
				1	99	21.65	21.65	44.77	-23.1212
				50	25	21.20	21.20	44.77	-23.5712
				100	0	21.07	21.07	44.77	-23.7012

Unless otherwise stated the results shown in this test report refer only to the sample(s) tested and such sample(s) are retained for 90 days only.

除非另有說明，此報告結果僅對測試之樣品負責，同時此樣品僅保留90天。本報告未經本公司書面許可，不可部份複製。

This document is issued by the Company subject to its General Conditions of Service printed overleaf, available on request or accessible at <http://www.sgs.com.tw/Terms-and-Conditions> and for electronic format documents, subject to Terms and Conditions for Electronic Documents at <http://www.sgs.com.tw/Terms-and-Conditions>. Attention is drawn to the limitation of liability, indemnification and jurisdiction issues defined therein. Any holder of this document is advised that information contained hereon reflects the Company's findings at the time of its intervention only and within the limits of Client's instructions, if any. The Company's sole responsibility is to its Client and this document does not exonerate parties to a transaction from exercising all their rights and obligations under the transaction documents. This document cannot be reproduced except in full, without prior written approval of the Company. Any unauthorized alteration, forgery or falsification of the content or appearance of this document is unlawful and offenders may be prosecuted to the fullest extent of the law.

7 FIELD STRENGTH OF SPURIOUS RADIATION MEASUREMENT

7.1 Standard Applicable

According to FCC §2.1053,

FCC §22.917(a), §24.238(a), §27.53(h)

RSS-130 §4.7, RSS-132 §5.5, RSS-133 §6.5.1, RSS-139 §6.6, RSS-140 §4.4

Out of band emissions. The power of any emission outside of the authorized operating frequency ranges must be attenuated below the transmitting power (P) by a factor of at least $43 + 10 \log(P)$ dB.

FCC §27.53(g) for LTE B12, 71

Compliance for operations in the 600 MHz, 698-746 MHz, 746-758 MHz and the 776-788 MHz band with this provision is based on the use of measurement instrumentation employing a resolution bandwidth of 100 kilohertz or greater. However, in the 100 kilohertz bands immediately outside and adjacent to a licensee's frequency block, a resolution bandwidth of at least 30 kHz may be employed.

- (2) On any frequency outside the 776-788 MHz band, the power of any emission shall be attenuated outside the band below the transmitter power (P) by at least $43 + 10 \log(P)$ dB;
- (3) On all frequencies between 763-775 MHz and 793-805 MHz, by a factor not less than $76 + 10 \log(P)$ dB in a 6.25 kHz band segment, for base and fixed stations;
- (4) On all frequencies between 763-775 MHz and 793-805 MHz, by a factor not less than $65 + 10 \log(P)$ dB in a 6.25 kHz band segment, for mobile and portable stations;

FCC §90.543 (f) for LTE B14

For operations in the 758-775 MHz and 788-805 MHz bands, all emissions including harmonics in the band 1559-1610 MHz shall be limited to -70 dBW/MHz equivalent isotropically radiated power (EIRP) for wideband signals, and -80 dBW EIRP for discrete emissions of less than 700 Hz bandwidth. For the purpose of equipment authorization, a transmitter shall be tested with an antenna that is representative of the type that will be used with the equipment in normal operation.

RSS-130 §4.7.1 for LTE B12, 13, 71

Compliance for operations in the 617-652 MHz, 663-698 MHz, 698-756 MHz and the 777-787 MHz band, the unwanted emissions in any 100 kHz bandwidth on any frequency outside the low frequency edge and the high frequency edge of each frequency block range(s), shall be attenuated below the transmitter power, P (dBW), by at least $43 + 10 \log_{10} p$ (watts), dB. However, in the 100 kHz band immediately outside of the equipment's frequency block range, a resolution bandwidth of 30 kHz may be employed.

RSS-130 §4.7.2 for LTE B13

In addition to the limit outlined in section 4.7.1 above, equipment operating in the frequency bands 746-756 MHz and 777-787 MHz shall also comply with the following restrictions:

the power of any unwanted emissions in any 6.25 kHz bandwidth for all frequencies between 763-775 MHz and 793-806 MHz shall be attenuated below the transmitter power, P (dBW), by at least:

$76 + 10 \log_{10} p$ (watts), dB, for base and fixed equipment and

$65 + 10 \log_{10} p$ (watts), dB, for mobile and portable equipment

the e.i.r.p. in the band 1559-1610 MHz shall not exceed -70 dBW/MHz for wideband signal and -80 dBW for discrete emission with bandwidth less than 700 Hz.

Unless otherwise stated the results shown in this test report refer only to the sample(s) tested and such sample(s) are retained for 90 days only.

除非另有說明，此報告結果僅對測試之樣品負責，同時此樣品僅保留90天。本報告未經本公司書面許可，不可部份複製。

This document is issued by the Company subject to its General Conditions of Service printed overleaf, available on request or accessible at <http://www.sgs.com.tw/Terms-and-Conditions> and for electronic format documents, subject to Terms and Conditions for Electronic Documents at <http://www.sgs.com.tw/Terms-and-Conditions>. Attention is drawn to the limitation of liability, indemnification and jurisdiction issues defined therein. Any holder of this document is advised that information contained hereon reflects the Company's findings at the time of its intervention only and within the limits of Client's instructions, if any. The Company's sole responsibility is to its Client and this document does not exonerate parties to a transaction from exercising all their rights and obligations under the transaction documents. This document cannot be reproduced except in full, without prior written approval of the Company. Any unauthorized alteration, forgery or falsification of the content or appearance of this document is unlawful and offenders may be prosecuted to the fullest extent of the law.

FCC §27.53(h)(1) for LTE B4, 66

(h) *AWS emission limits*—(1) *General protection levels*. Except as otherwise specified below, for operations in the 1695-1710 MHz, 1710-1755 MHz, 1755-1780 MHz, 1915-1920 MHz, 1995-2000 MHz, 2000-2020 MHz, 2110-2155 MHz, 2155-2180 MHz, and 2180-2200 bands, the power of any emission outside a licensee's frequency block shall be attenuated below the transmitter power (P) in watts by at least $43 + 10 \log_{10} (P)$ dB.

ISED RSS-132 §5.5 for LTE B5

Mobile and base station equipment shall comply with the limits in (i) and (ii) below.

- i. In the first 1.0 MHz band immediately outside and adjacent to each of the sub-bands specified in Section 5.1, the power of emissions per any 1% of the occupied bandwidth shall be attenuated (in dB) below the transmitter output power P (dBW) by at least $43 + 10 \log_{10} p$ (watts).
- ii. After the first 1.0 MHz immediately outside and adjacent to each of the sub-bands, the power of emissions in any 100 kHz bandwidth shall be attenuated (in dB) below the transmitter output power P (dBW) by at least $43 + 10 \log_{10} p$ (watts). If the measurement is performed using 1% of the occupied bandwidth, power integration over 100 kHz is required.

ISED RSS-133 §6.5.1 for LTE B2

Equipment shall comply with the limits in (i) and (ii) below.

- i. In the 1.0 MHz bands immediately outside and adjacent to the equipment's operating frequency block, the emission power per any 1% of the emission bandwidth shall be attenuated (in dB) below the transmitter output power P (dBW) by at least $43 + 10 \log_{10} p$ (watts).
- ii. After the first 1.0 MHz, the emission power in any 1 MHz bandwidth shall be attenuated (in dB) below the transmitter output power P (dBW) by at least $43 + 10 \log_{10} p$ (watts). If the measurement is performed using 1% of the emission bandwidth, power integration over 1.0 MHz is required.

RSS-139 §6.6 for LTE B4, 66

In the first 1.0 MHz bands immediately outside and adjacent to the equipment's smallest operating frequency block, Footnote 2 which can contain the equipment's occupied bandwidth, the emission power per any 1% of the emission bandwidth shall be attenuated below the transmitter output power P (in dBW) by at least $43 + 10 \log_{10} p$ (watts) dB.

After the first 1.0 MHz outside the equipment's smallest operating frequency block, which can contain the equipment's occupied bandwidth, the emission power in any 1 MHz bandwidth shall be attenuated below the transmitter output power P (in dBW) by at least $43 + 10 \log_{10} p$ (watts) dB.

Unless otherwise stated the results shown in this test report refer only to the sample(s) tested and such sample(s) are retained for 90 days only.

除非另有說明，此報告結果僅對測試之樣品負責，同時此樣品僅保留90天。本報告未經本公司書面許可，不可部份複製。

This document is issued by the Company subject to its General Conditions of Service printed overleaf, available on request or accessible at <http://www.sgs.com.tw/Terms-and-Conditions> and for electronic format documents, subject to Terms and Conditions for Electronic Documents at <http://www.sgs.com.tw/Terms-and-Conditions>. Attention is drawn to the limitation of liability, indemnification and jurisdiction issues defined therein. Any holder of this document is advised that information contained hereon reflects the Company's findings at the time of its intervention only and within the limits of Client's instructions, if any. The Company's sole responsibility is to its Client and this document does not exonerate parties to a transaction from exercising all their rights and obligations under the transaction documents. This document cannot be reproduced except in full, without prior written approval of the Company. Any unauthorized alteration, forgery or falsification of the content or appearance of this document is unlawful and offenders may be prosecuted to the fullest extent of the law.

ISED RSS-140 §4.4 for LTE B14

- a. For any frequency between 769-775 MHz and 799-806 MHz:
 - i. $76 + 10 \log (p)$, dB in a 6.25 kHz band for fixed and base station equipment
 - ii. $65 + 10 \log (p)$, dB in a 6.25 kHz band for mobile and portable/hand-held equipment
- b. For any frequency between 775-788 MHz, above 806 MHz, and below 758 MHz:
 $43 + 10 \log (p)$, dB in a bandwidth of 100 kHz or greater. However, in the 100 kHz bands immediately outside and adjacent to the frequency bands 758-768 MHz and 788-798 MHz, a resolution bandwidth of 30 kHz may be employed.

Unless otherwise stated the results shown in this test report refer only to the sample(s) tested and such sample(s) are retained for 90 days only.

除非另有說明，此報告結果僅對測試之樣品負責，同時此樣品僅保留90天。本報告未經本公司書面許可，不可部份複製。

This document is issued by the Company subject to its General Conditions of Service printed overleaf, available on request or accessible at <http://www.sgs.com.tw/Terms-and-Conditions> and for electronic format documents, subject to Terms and Conditions for Electronic Documents at <http://www.sgs.com.tw/Terms-and-Conditions>. Attention is drawn to the limitation of liability, indemnification and jurisdiction issues defined therein. Any holder of this document is advised that information contained hereon reflects the Company's findings at the time of its intervention only and within the limits of Client's instructions, if any. The Company's sole responsibility is to its Client and this document does not exonerate parties to a transaction from exercising all their rights and obligations under the transaction documents. This document cannot be reproduced except in full, without prior written approval of the Company. Any unauthorized alteration, forgery or falsification of the content or appearance of this document is unlawful and offenders may be prosecuted to the fullest extent of the law.

7.2 EUT Setup

Radiated Emission Test Set-Up, Frequency Below 1000MHz

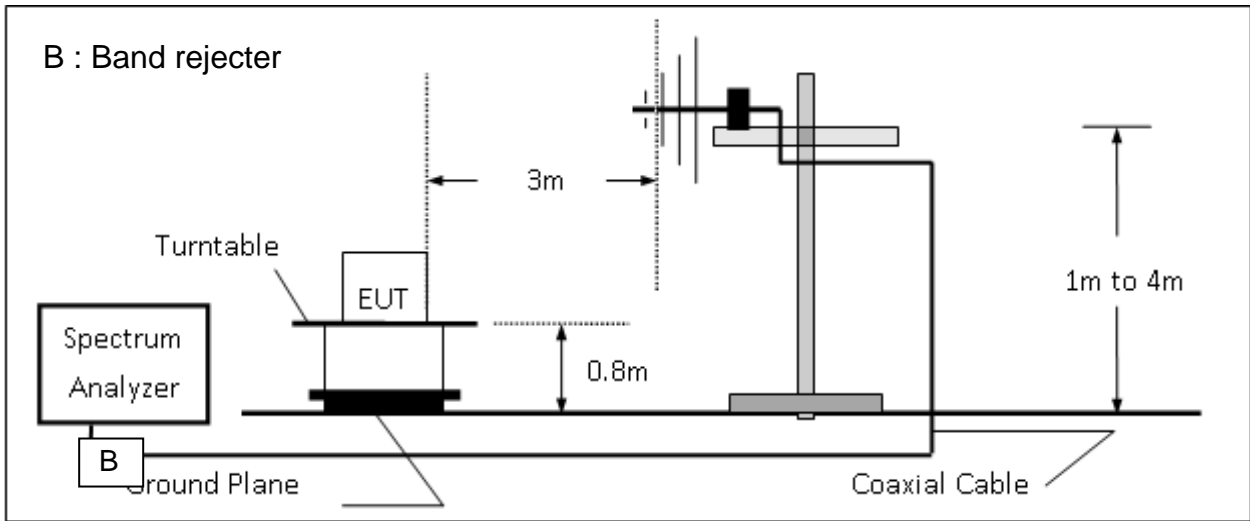

Radiated Emission Test Set-UP Frequency Over 1 GHz

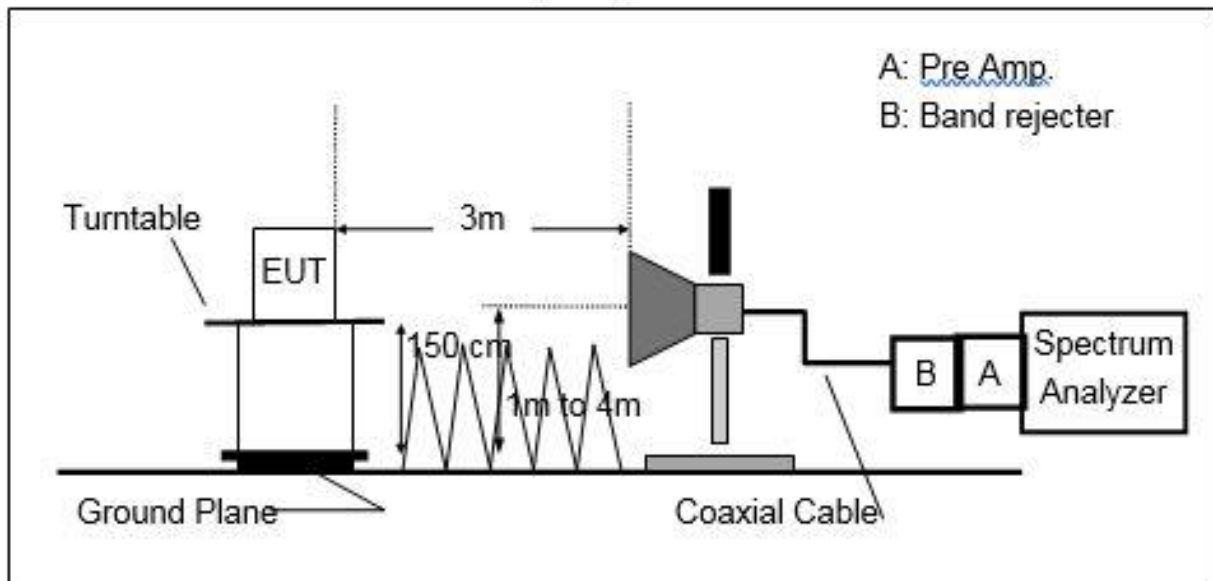

Unless otherwise stated the results shown in this test report refer only to the sample(s) tested and such sample(s) are retained for 90 days only.

除非另有說明，此報告結果僅對測試之樣品負責，同時此樣品僅保留90天。本報告未經本公司書面許可，不可部份複製。

This document is issued by the Company subject to its General Conditions of Service printed overleaf, available on request or accessible at <http://www.sgs.com.tw/Terms-and-Conditions> and for electronic format documents, subject to Terms and Conditions for Electronic Documents at <http://www.sgs.com.tw/Terms-and-Conditions>. Attention is drawn to the limitation of liability, indemnification and jurisdiction issues defined therein. Any holder of this document is advised that information contained hereon reflects the Company's findings at the time of its intervention only and within the limits of Client's instructions, if any. The Company's sole responsibility is to its Client and this document does not exonerate parties to a transaction from exercising all their rights and obligations under the transaction documents. This document cannot be reproduced except in full, without prior written approval of the Company. Any unauthorized alteration, forgery or falsification of the content or appearance of this document is unlawful and offenders may be prosecuted to the fullest extent of the law.

7.3 Measurement Procedure:

The EUT was placed on a non-conductive; the measurement antenna was placed at a distance of 3 meters from the EUT. During the tests, the antenna height and the EUT azimuth were varied in order to identify the maximum level of emissions from the EUT. This maximization process was repeated with the EUT positioned in each of its three orthogonal orientations.

The frequency range up to tenth harmonic was investigated for each of three fundamental frequencies (low, middle and high channels). Once spurious emission was identified, the power of the emission was determined using the substitution method.

The spurious emissions attenuation was calculated as the difference between radiated power at the fundamental frequency and the spurious emissions frequency.

ERP (dBm) = SG Level(dBm) + Antenna Gain(dBd) + Cable Loss(dB)

EIRP (dBm) = SG Level(dBm) + Antenna Gain(dBi) + Cable Loss(dB)

Unless otherwise stated the results shown in this test report refer only to the sample(s) tested and such sample(s) are retained for 90 days only.

除非另有說明，此報告結果僅對測試之樣品負責，同時此樣品僅保留90天。本報告未經本公司書面許可，不可部份複製。

This document is issued by the Company subject to its General Conditions of Service printed overleaf, available on request or accessible at <http://www.sgs.com.tw/Terms-and-Conditions> and for electronic format documents, subject to Terms and Conditions for Electronic Documents at <http://www.sgs.com.tw/Terms-and-Conditions>. Attention is drawn to the limitation of liability, indemnification and jurisdiction issues defined therein. Any holder of this document is advised that information contained hereon reflects the Company's findings at the time of its intervention only and within the limits of Client's instructions, if any. The Company's sole responsibility is to its Client and this document does not exonerate parties to a transaction from exercising all their rights and obligations under the transaction documents. This document cannot be reproduced except in full, without prior written approval of the Company. Any unauthorized alteration, forgery or falsification of the content or appearance of this document is unlawful and offenders may be prosecuted to the fullest extent of the law.

7.4 Measurement Equipment Used:

Radiated Emission Test Site: SAC 3					
EQUIPMENT TYPE	MFR	MODEL NUMBER	SERIAL NUMBER	LAST CAL.	CAL DUE.
Bi-log Antenna	SCHWARZBECK	VULB9168	443	01/19/2021	01/18/2022
Horn Antenna	SCHWARZBECK	BBHA9120D	1441	10/16/2020	10/15/2021
Horn Antenna	SCHWARZBECK	BBHA9170	184	12/11/2020	12/10/2021
Bi-log Antenna	SCHWARZBECK	VULB9168	300	11/18/2020	11/17/2021
Horn Antenna	SCHWARZBECK	BBHA9120D	603	05/18/2021	05/17/2022
Horn Antenna	SCHWARZBECK	BBHA9170	185	08/02/2021	08/01/2022
PXA Spectrum Analyzer	Agilent	N9030A	MY53120760	04/27/2021	04/26/2022
Signal Generator	Agilent	N5183A	MY50140591	12/27/2020	12/26/2021
Pre-Amplifier	HP	8449B	3008A00578	12/16/2020	12/15/2021
Pre-Amplifier	HP	8447D	2944A07676	12/16/2020	12/15/2021
Pre-Amplifier	EMC Instruments	EMC184045B	980135	10/27/2020	10/26/2021
Filter 635-920	Micro-Tronics	WI	4	12/16/2020	12/15/2021
Filter 800-1000	Micro-Tronics	EWT	M1	12/16/2020	12/15/2021
Filter 1700-2000	Micro-Tronics	EWT	M3	12/16/2020	12/15/2021
1GHz High Pass Filter	Micro-Tronics	HPM50108	32	12/16/2020	12/15/2021
2GHz High Pass Filter	Micro-Tronics	HPM50110	36	12/16/2020	12/15/2021
Coaxial Cable	Huber Suhner	SUCOFLEX 102	MY2636/2	12/16/2020	12/15/2021
Coaxial Cable	Huber Suhner	SUCOFLEX 104	340057/4	12/16/2020	12/15/2021
Coaxial Cable	Huber Suhner	SUCOFLEX 104PEA	800052/2	12/16/2020	12/15/2021
Coaxial Cable	Huber Suhner	SUCOFLEX 102	MY2621/2	12/16/2020	12/15/2021
Coaxial Cable	Huber Suhner	SUCOFLEX 102	MY2617/2	12/16/2020	12/15/2021
Coaxial Cable	Huber Suhner	SUCOFLEX 104	160125	12/16/2020	12/15/2021
Coaxial Cable	Huber Suhner	SUCOFLEX 106	76096/6	12/16/2020	12/15/2021
Coaxial Cable	Huber Suhner	SUCOFLEX 102	MY2630/2	12/16/2020	12/15/2021
Coaxial Cable	Huber Suhner	SUCOFLEX 102	MY22962/2	12/16/2020	12/15/2021
Coaxial Cable	Huber Suhner	SUCOFLEX 102	SN 520430/2	12/16/2020	12/15/2021
Radio Communication Analyser	Anritsu	MT8820C	6201465317	02/24/2021	02/23/2022
Radio Communication Analyser	Anritsu	MT8821C	6261786084	01/20/2021	01/19/2022
Site Cal	SGS	SAC 3	N/A	01/01/2021	12/31/2021
Test Software	audix	e3	Ver. 6.11812c	N.C.R	N.C.R

Note: N.C.R refers to Not Calibrated Required.

Unless otherwise stated the results shown in this test report refer only to the sample(s) tested and such sample(s) are retained for 90 days only.

除非另有說明，此報告結果僅對測試之樣品負責，同時此樣品僅保留90天。本報告未經本公司書面許可，不可部份複製。

This document is issued by the Company subject to its General Conditions of Service printed overleaf, available on request or accessible at <http://www.sgs.com.tw/Terms-and-Conditions> and for electronic format documents, subject to Terms and Conditions for Electronic Documents at <http://www.sgs.com.tw/Terms-and-Conditions>. Attention is drawn to the limitation of liability, indemnification and jurisdiction issues defined therein. Any holder of this document is advised that information contained hereon reflects the Company's findings at the time of its intervention only and within the limits of Client's instructions, if any. The Company's sole responsibility is to its Client and this document does not exonerate parties to a transaction from exercising all their rights and obligations under the transaction documents. This document cannot be reproduced except in full, without prior written approval of the Company. Any unauthorized alteration, forgery or falsification of the content or appearance of this document is unlawful and offenders may be prosecuted to the fullest extent of the law.

7.5 Measurement Result:

Report Number :ER-2021-70075
 Operation Mode :WCDMA B2
 Test Mode :Tx CH High
 EUT Pol :H Plane
 Test Frequency :1907.6 MHz

Test Site :SAC 3
 Test Date :2021-08-12
 Temp./Humi. :27.4/51
 Antenna Pol. :VERTICAL
 Engineer :Nick Lin

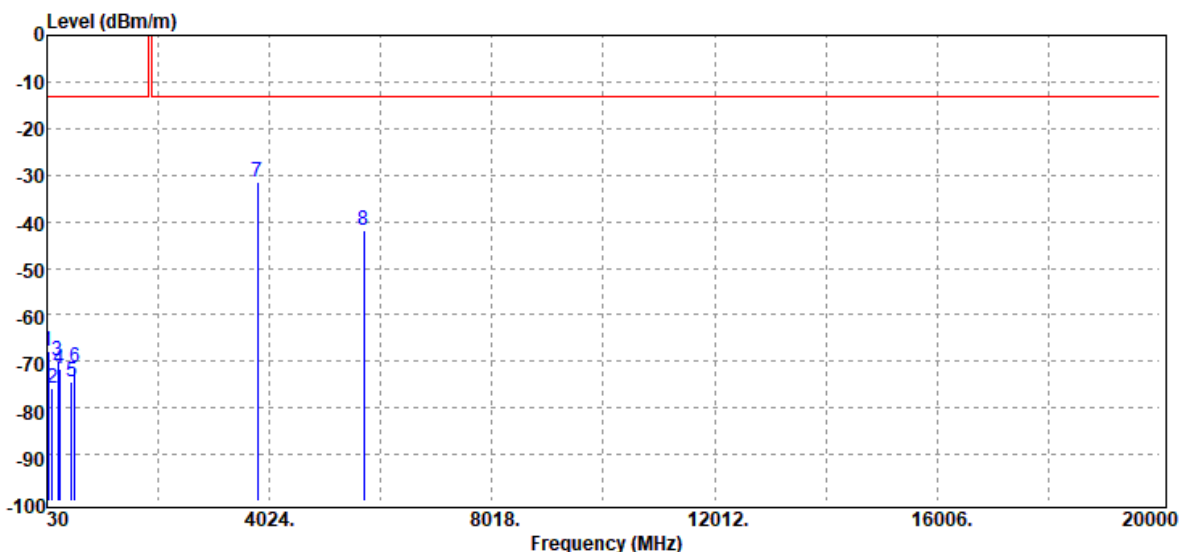

Freq. MHz	EIRP/ERP dBm	SG Output Level dBm	Antenna Gain dBi/dBd	Cable Loss dB	Limit dBm	Margin dB
57.16	-67.80	-56.91	-10.16	-0.73	-13.00	-54.80
124.09	-75.68	-72.68	-1.85	-1.15	-13.00	-62.68
225.94	-70.01	-73.45	4.98	-1.54	-13.00	-57.01
255.04	-71.79	-74.48	4.31	-1.62	-13.00	-58.79
471.35	-74.28	-76.14	4.15	-2.29	-13.00	-61.28
526.64	-71.15	-73.28	4.18	-2.05	-13.00	-58.15
3815.20	-31.57	-36.28	12.37	-7.66	-13.00	-18.57
5722.80	-41.77	-45.52	12.80	-9.05	-13.00	-28.77

Unless otherwise stated the results shown in this test report refer only to the sample(s) tested and such sample(s) are retained for 90 days only.

除非另有說明，此報告結果僅對測試之樣品負責，同時此樣品僅保留90天。本報告未經本公司書面許可，不可部份複製。

This document is issued by the Company subject to its General Conditions of Service printed overleaf, available on request or accessible at <http://www.sgs.com.tw/Terms-and-Conditions> and for electronic format documents, subject to Terms and Conditions for Electronic Documents at <http://www.sgs.com.tw/Terms-and-Conditions>. Attention is drawn to the limitation of liability, indemnification and jurisdiction issues defined therein. Any holder of this document is advised that information contained hereon reflects the Company's findings at the time of its intervention only and within the limits of Client's instructions, if any. The Company's sole responsibility is to its Client and this document does not exonerate parties to a transaction from exercising all their rights and obligations under the transaction documents. This document cannot be reproduced except in full, without prior written approval of the Company. Any unauthorized alteration, forgery or falsification of the content or appearance of this document is unlawful and offenders may be prosecuted to the fullest extent of the law.

Report Number :ER-2021-70075
 Operation Mode :WCDMA B2
 Test Mode :Tx CH High
 EUT Pol :H Plane
 Test Frequency :1907.6 MHz

Test Site :SAC 3
 Test Date :2021-08-12
 Temp./Humi. :27.4/51
 Antenna Pol. :HORIZONTAL
 Engineer :Nick Lin

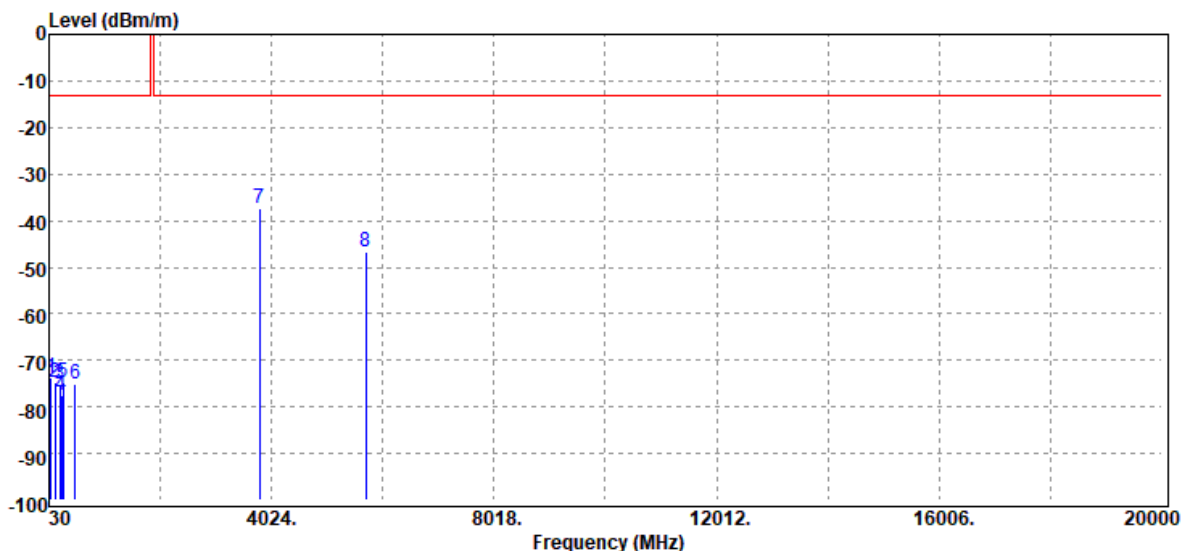

Freq. MHz	EIRP/ERP dBm	SG Output Level dBm	Antenna Gain dBi/dBd	Cable Loss dB	Limit dBm	Margin dB
62.01	-73.57	-63.94	-8.87	-0.76	-13.00	-60.57
144.46	-74.64	-71.47	-1.93	-1.24	-13.00	-61.64
221.09	-75.12	-78.66	5.03	-1.49	-13.00	-62.12
253.10	-77.34	-80.06	4.32	-1.60	-13.00	-64.34
287.05	-74.81	-77.15	4.06	-1.72	-13.00	-61.81
492.69	-74.94	-76.87	4.22	-2.29	-13.00	-61.94
3815.20	-37.36	-42.07	12.37	-7.66	-13.00	-24.36
5722.80	-46.81	-50.56	12.80	-9.05	-13.00	-33.81

Unless otherwise stated the results shown in this test report refer only to the sample(s) tested and such sample(s) are retained for 90 days only.

除非另有說明，此報告結果僅對測試之樣品負責，同時此樣品僅保留90天。本報告未經本公司書面許可，不可部份複製。

This document is issued by the Company subject to its General Conditions of Service printed overleaf, available on request or accessible at <http://www.sgs.com.tw/Terms-and-Conditions> and for electronic format documents, subject to Terms and Conditions for Electronic Documents at <http://www.sgs.com.tw/Terms-and-Conditions>. Attention is drawn to the limitation of liability, indemnification and jurisdiction issues defined therein. Any holder of this document is advised that information contained hereon reflects the Company's findings at the time of its intervention only and within the limits of Client's instructions, if any. The Company's sole responsibility is to its Client and this document does not exonerate parties to a transaction from exercising all their rights and obligations under the transaction documents. This document cannot be reproduced except in full, without prior written approval of the Company. Any unauthorized alteration, forgery or falsification of the content or appearance of this document is unlawful and offenders may be prosecuted to the fullest extent of the law.

Report Number :ER-2021-70075
 Operation Mode :WCDMA B4
 Test Mode :Tx CH Low
 EUT Pol :H Plane
 Test Frequency :1712.4 MHz

Test Site :SAC 3
 Test Date :2021-08-12
 Temp./Humi. :27.4/51
 Antenna Pol. :VERTICAL
 Engineer :Nick Lin

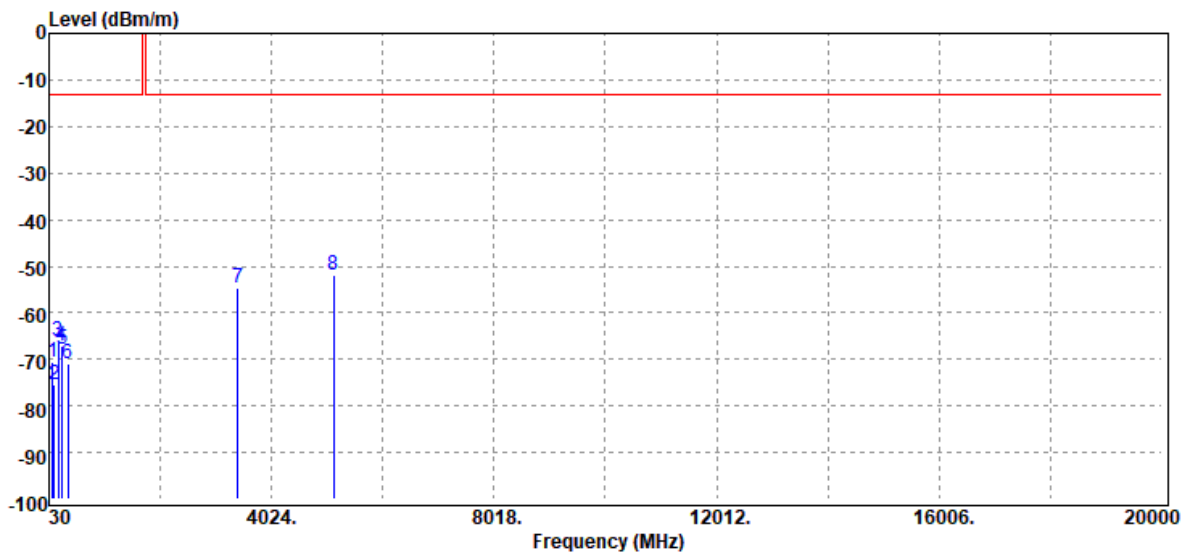

Freq. MHz	EIRP/ERP dBm	SG Output Level dBm	Antenna Gain dBi/dBd	Cable Loss dB	Limit dBm	Margin dB
94.99	-70.75	-69.38	-0.37	-1.00	-13.00	-57.75
124.09	-75.57	-72.57	-1.85	-1.15	-13.00	-62.57
194.90	-66.02	-68.47	3.88	-1.43	-13.00	-53.02
253.10	-66.98	-69.70	4.32	-1.60	-13.00	-53.98
270.56	-67.89	-70.33	4.09	-1.65	-13.00	-54.89
362.71	-71.09	-73.60	4.46	-1.95	-13.00	-58.09
3424.80	-54.75	-61.45	12.55	-5.85	-13.00	-41.75
5137.20	-51.86	-56.01	12.10	-7.95	-13.00	-38.86

Unless otherwise stated the results shown in this test report refer only to the sample(s) tested and such sample(s) are retained for 90 days only.

除非另有說明，此報告結果僅對測試之樣品負責，同時此樣品僅保留90天。本報告未經本公司書面許可，不可部份複製。

This document is issued by the Company subject to its General Conditions of Service printed overleaf, available on request or accessible at <http://www.sgs.com.tw/Terms-and-Conditions> and for electronic format documents, subject to Terms and Conditions for Electronic Documents at <http://www.sgs.com.tw/Terms-and-Conditions>. Attention is drawn to the limitation of liability, indemnification and jurisdiction issues defined therein. Any holder of this document is advised that information contained hereon reflects the Company's findings at the time of its intervention only and within the limits of Client's instructions, if any. The Company's sole responsibility is to its Client and this document does not exonerate parties to a transaction from exercising all their rights and obligations under the transaction documents. This document cannot be reproduced except in full, without prior written approval of the Company. Any unauthorized alteration, forgery or falsification of the content or appearance of this document is unlawful and offenders may be prosecuted to the fullest extent of the law.

Report Number :ER-2021-70075
 Operation Mode :WCDMA B4
 Test Mode :Tx CH Low
 EUT Pol :H Plane
 Test Frequency :1712.4 MHz

Test Site :SAC 3
 Test Date :2021-08-12
 Temp./Humi. :27.4/51
 Antenna Pol. :HORIZONTAL
 Engineer :Nick Lin

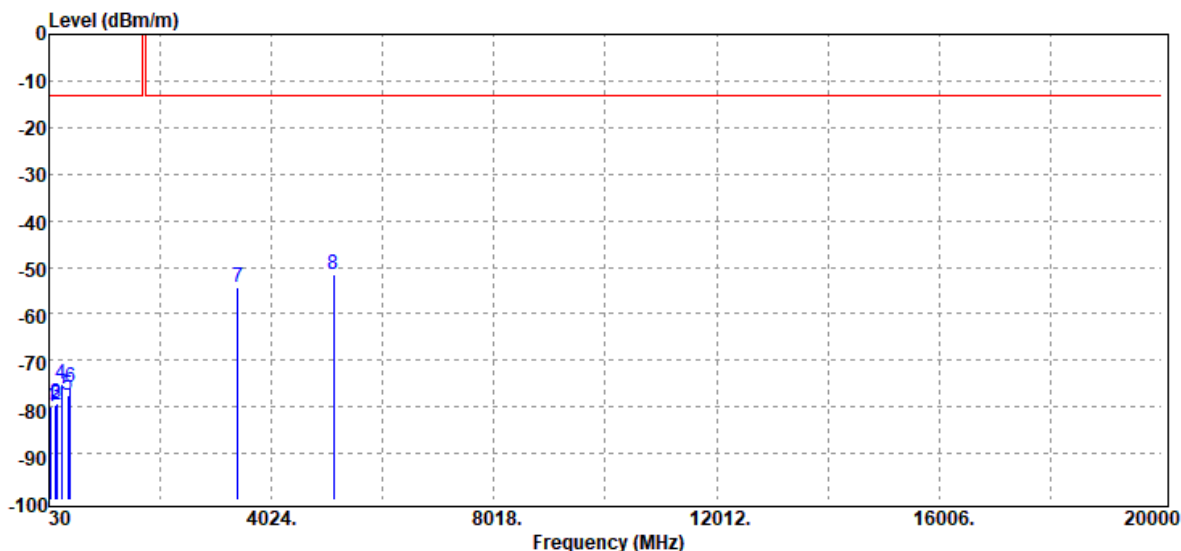

Freq. MHz	EIRP/ERP dBm	SG Output Level dBm	Antenna Gain dBi/dBd	Cable Loss dB	Limit dBm	Margin dB
65.89	-79.80	-71.21	-7.79	-0.80	-13.00	-66.80
148.34	-79.62	-76.69	-1.76	-1.17	-13.00	-66.62
173.56	-79.30	-78.17	0.18	-1.31	-13.00	-66.30
255.04	-74.92	-77.61	4.31	-1.62	-13.00	-61.92
367.56	-77.61	-80.01	4.38	-1.98	-13.00	-64.61
406.36	-75.65	-78.06	4.36	-1.95	-13.00	-62.65
3424.80	-54.45	-61.15	12.55	-5.85	-13.00	-41.45
5137.20	-51.56	-55.71	12.10	-7.95	-13.00	-38.56

Unless otherwise stated the results shown in this test report refer only to the sample(s) tested and such sample(s) are retained for 90 days only.

除非另有說明，此報告結果僅對測試之樣品負責，同時此樣品僅保留90天。本報告未經本公司書面許可，不可部份複製。

This document is issued by the Company subject to its General Conditions of Service printed overleaf, available on request or accessible at <http://www.sgs.com.tw/Terms-and-Conditions> and for electronic format documents, subject to Terms and Conditions for Electronic Documents at <http://www.sgs.com.tw/Terms-and-Conditions>. Attention is drawn to the limitation of liability, indemnification and jurisdiction issues defined therein. Any holder of this document is advised that information contained hereon reflects the Company's findings at the time of its intervention only and within the limits of Client's instructions, if any. The Company's sole responsibility is to its Client and this document does not exonerate parties to a transaction from exercising all their rights and obligations under the transaction documents. This document cannot be reproduced except in full, without prior written approval of the Company. Any unauthorized alteration, forgery or falsification of the content or appearance of this document is unlawful and offenders may be prosecuted to the fullest extent of the law.

Report Number :ER-2021-70075
 Operation Mode :WCDMA B5
 Test Mode :Tx CH Low
 EUT Pol :H Plane
 Test Frequency :826.4 MHz

Test Site :SAC 3
 Test Date :2021-08-12
 Temp./Humi. :27.4/51
 Antenna Pol. :VERTICAL
 Engineer :Nick Lin

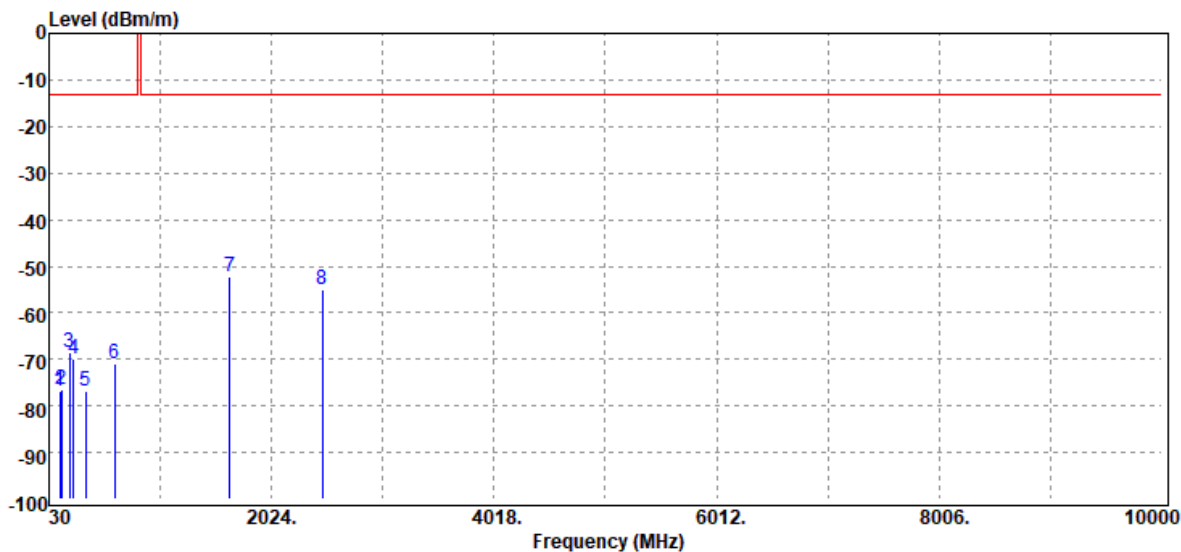

Freq. MHz	EIRP/ERP dBm	SG Output Level dBm	Antenna Gain dBi/dBd	Cable Loss dB	Limit dBm	Margin dB
124.09	-76.96	-73.96	-1.85	-1.15	-13.00	-63.96
139.61	-76.31	-72.97	-2.02	-1.32	-13.00	-63.31
216.24	-68.45	-71.93	4.95	-1.47	-13.00	-55.45
253.10	-69.85	-72.57	4.32	-1.60	-13.00	-56.85
359.80	-76.69	-79.26	4.51	-1.94	-13.00	-63.69
619.76	-70.89	-72.03	3.43	-2.29	-13.00	-57.89
1652.80	-52.09	-57.34	9.51	-4.26	-13.00	-39.09
2479.20	-55.05	-60.44	10.56	-5.17	-13.00	-42.05

Unless otherwise stated the results shown in this test report refer only to the sample(s) tested and such sample(s) are retained for 90 days only.

除非另有說明，此報告結果僅對測試之樣品負責，同時此樣品僅保留90天。本報告未經本公司書面許可，不可部份複製。

This document is issued by the Company subject to its General Conditions of Service printed overleaf, available on request or accessible at <http://www.sgs.com.tw/Terms-and-Conditions> and for electronic format documents, subject to Terms and Conditions for Electronic Documents at <http://www.sgs.com.tw/Terms-and-Conditions>. Attention is drawn to the limitation of liability, indemnification and jurisdiction issues defined therein. Any holder of this document is advised that information contained hereon reflects the Company's findings at the time of its intervention only and within the limits of Client's instructions, if any. The Company's sole responsibility is to its Client and this document does not exonerate parties to a transaction from exercising all their rights and obligations under the transaction documents. This document cannot be reproduced except in full, without prior written approval of the Company. Any unauthorized alteration, forgery or falsification of the content or appearance of this document is unlawful and offenders may be prosecuted to the fullest extent of the law.

Report Number :ER-2021-70075
 Operation Mode :WCDMA B5
 Test Mode :Tx CH Low
 EUT Pol :H Plane
 Test Frequency :826.4 MHz

Test Site :SAC 3
 Test Date :2021-08-12
 Temp./Humi. :27.4/51
 Antenna Pol. :HORIZONTAL
 Engineer :Nick Lin

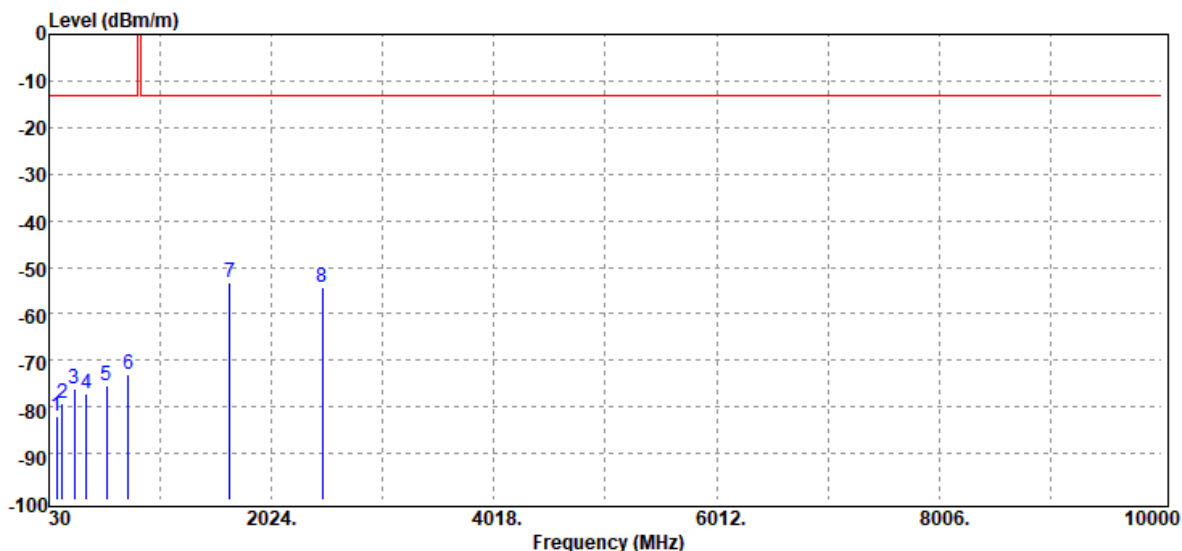

Freq. MHz	EIRP/ERP dBm	SG Output Level dBm	Antenna Gain dBi/dBd	Cable Loss dB	Limit dBm	Margin dB
94.99	-82.12	-80.75	-0.37	-1.00	-13.00	-69.12
148.34	-79.26	-76.33	-1.76	-1.17	-13.00	-66.26
255.04	-76.26	-78.95	4.31	-1.62	-13.00	-63.26
366.59	-77.16	-79.59	4.40	-1.97	-13.00	-64.16
547.01	-75.31	-77.21	4.20	-2.30	-13.00	-62.31
742.95	-73.02	-73.43	2.84	-2.43	-13.00	-60.02
1652.80	-53.30	-58.55	9.51	-4.26	-13.00	-40.30
2479.20	-54.45	-59.84	10.56	-5.17	-13.00	-41.45

Unless otherwise stated the results shown in this test report refer only to the sample(s) tested and such sample(s) are retained for 90 days only.

除非另有說明，此報告結果僅對測試之樣品負責，同時此樣品僅保留90天。本報告未經本公司書面許可，不可部份複製。

This document is issued by the Company subject to its General Conditions of Service printed overleaf, available on request or accessible at <http://www.sgs.com.tw/Terms-and-Conditions> and for electronic format documents, subject to Terms and Conditions for Electronic Documents at <http://www.sgs.com.tw/Terms-and-Conditions>. Attention is drawn to the limitation of liability, indemnification and jurisdiction issues defined therein. Any holder of this document is advised that information contained hereon reflects the Company's findings at the time of its intervention only and within the limits of Client's instructions, if any. The Company's sole responsibility is to its Client and this document does not exonerate parties to a transaction from exercising all their rights and obligations under the transaction documents. This document cannot be reproduced except in full, without prior written approval of the Company. Any unauthorized alteration, forgery or falsification of the content or appearance of this document is unlawful and offenders may be prosecuted to the fullest extent of the law.

Report Number :ER-2021-70075
 Operation Mode :LTE B2
 Test Mode :Tx CH Mid
 EUT Pol :H Plane
 Test Frequency :1880 MHz

Test Site :SAC 3
 Test Date :2021-08-12
 Temp./Humi. :27.4/51
 Antenna Pol. :VERTICAL
 Engineer :Nick Lin

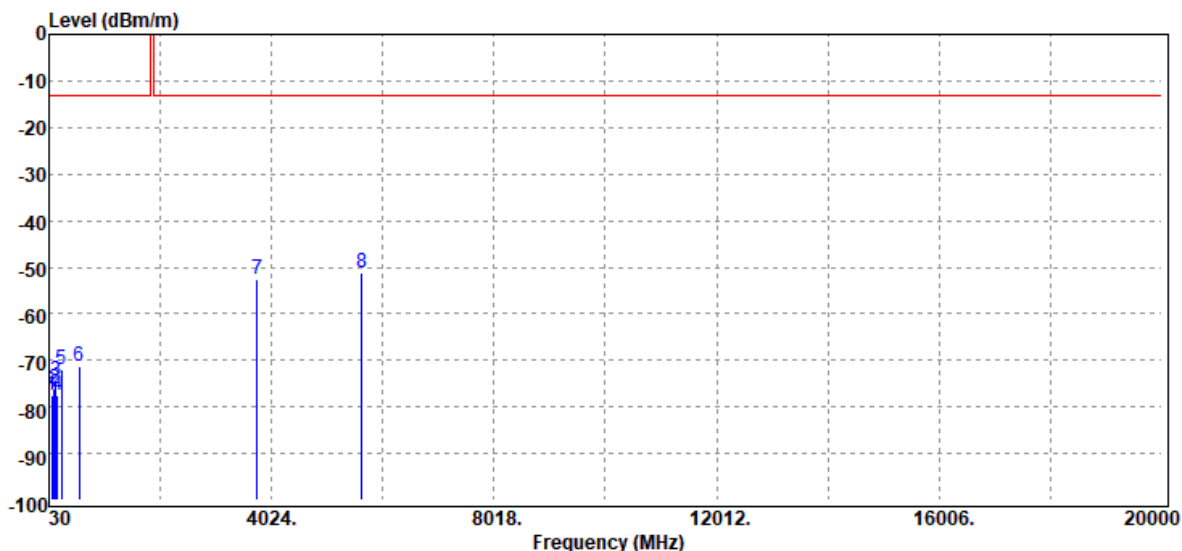

Freq. MHz	EIRP/ERP dBm	SG Output Level dBm	Antenna Gain dBi/dBd	Cable Loss dB	Limit dBm	Margin dB
81.41	-77.64	-74.26	-2.47	-0.91	-13.00	-64.64
124.09	-76.03	-73.03	-1.85	-1.15	-13.00	-63.03
146.40	-74.26	-71.32	-1.73	-1.21	-13.00	-61.26
180.35	-77.46	-77.55	1.47	-1.38	-13.00	-64.46
253.10	-72.12	-74.84	4.32	-1.60	-13.00	-59.12
573.20	-71.32	-72.69	4.02	-2.65	-13.00	-58.32
3760.00	-52.69	-57.46	12.40	-7.63	-13.00	-39.69
5640.00	-51.21	-54.98	13.00	-9.23	-13.00	-38.21

Unless otherwise stated the results shown in this test report refer only to the sample(s) tested and such sample(s) are retained for 90 days only.

除非另有說明，此報告結果僅對測試之樣品負責，同時此樣品僅保留90天。本報告未經本公司書面許可，不可部份複製。

This document is issued by the Company subject to its General Conditions of Service printed overleaf, available on request or accessible at <http://www.sgs.com.tw/Terms-and-Conditions> and for electronic format documents, subject to Terms and Conditions for Electronic Documents at <http://www.sgs.com.tw/Terms-and-Conditions>. Attention is drawn to the limitation of liability, indemnification and jurisdiction issues defined therein. Any holder of this document is advised that information contained hereon reflects the Company's findings at the time of its intervention only and within the limits of Client's instructions, if any. The Company's sole responsibility is to its Client and this document does not exonerate parties to a transaction from exercising all their rights and obligations under the transaction documents. This document cannot be reproduced except in full, without prior written approval of the Company. Any unauthorized alteration, forgery or falsification of the content or appearance of this document is unlawful and offenders may be prosecuted to the fullest extent of the law.

Report Number :ER-2021-70075
 Operation Mode :LTE B2
 Test Mode :Tx CH Mid
 EUT Pol :H Plane
 Test Frequency :1880 MHz

Test Site :SAC 3
 Test Date :2021-08-12
 Temp./Humi. :27.4/51
 Antenna Pol. :HORIZONTAL
 Engineer :Nick Lin

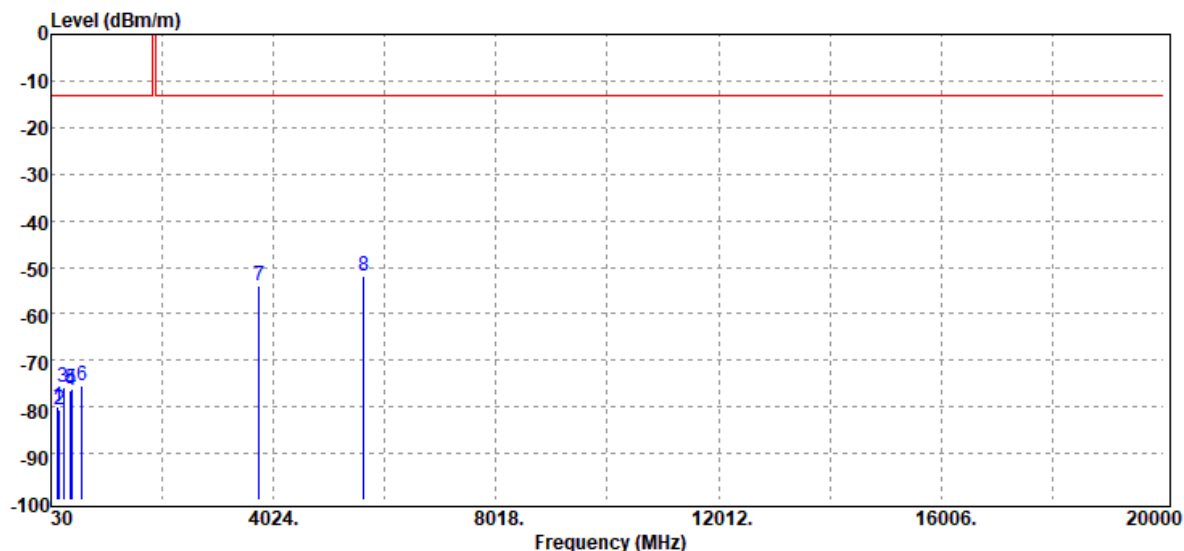

Freq. MHz	EIRP/ERP dBm	SG Output Level dBm	Antenna Gain dBi/dBd	Cable Loss dB	Limit dBm	Margin dB
146.40	-80.08	-77.14	-1.73	-1.21	-13.00	-67.08
178.41	-80.67	-80.40	1.09	-1.36	-13.00	-67.67
256.01	-75.63	-78.33	4.32	-1.62	-13.00	-62.63
379.20	-76.32	-78.68	4.37	-2.01	-13.00	-63.32
398.60	-76.16	-78.36	4.32	-2.12	-13.00	-63.16
580.96	-75.39	-76.60	3.92	-2.71	-13.00	-62.39
3760.00	-53.84	-58.61	12.40	-7.63	-13.00	-40.84
5640.00	-52.06	-55.83	13.00	-9.23	-13.00	-39.06

Unless otherwise stated the results shown in this test report refer only to the sample(s) tested and such sample(s) are retained for 90 days only.

除非另有說明，此報告結果僅對測試之樣品負責，同時此樣品僅保留90天。本報告未經本公司書面許可，不可部份複製。

This document is issued by the Company subject to its General Conditions of Service printed overleaf, available on request or accessible at <http://www.sgs.com.tw/Terms-and-Conditions> and for electronic format documents, subject to Terms and Conditions for Electronic Documents at <http://www.sgs.com.tw/Terms-and-Conditions>. Attention is drawn to the limitation of liability, indemnification and jurisdiction issues defined therein. Any holder of this document is advised that information contained hereon reflects the Company's findings at the time of its intervention only and within the limits of Client's instructions, if any. The Company's sole responsibility is to its Client and this document does not exonerate parties to a transaction from exercising all their rights and obligations under the transaction documents. This document cannot be reproduced except in full, without prior written approval of the Company. Any unauthorized alteration, forgery or falsification of the content or appearance of this document is unlawful and offenders may be prosecuted to the fullest extent of the law.

Report Number :ER-2021-70075
 Operation Mode :LTE B4
 Test Mode :Tx CH Low
 EUT Pol :H Plane
 Test Frequency :1717.5 MHz

Test Site :SAC 3
 Test Date :2021-08-12
 Temp./Humi. :27.4/51
 Antenna Pol. :VERTICAL
 Engineer :Nick Lin

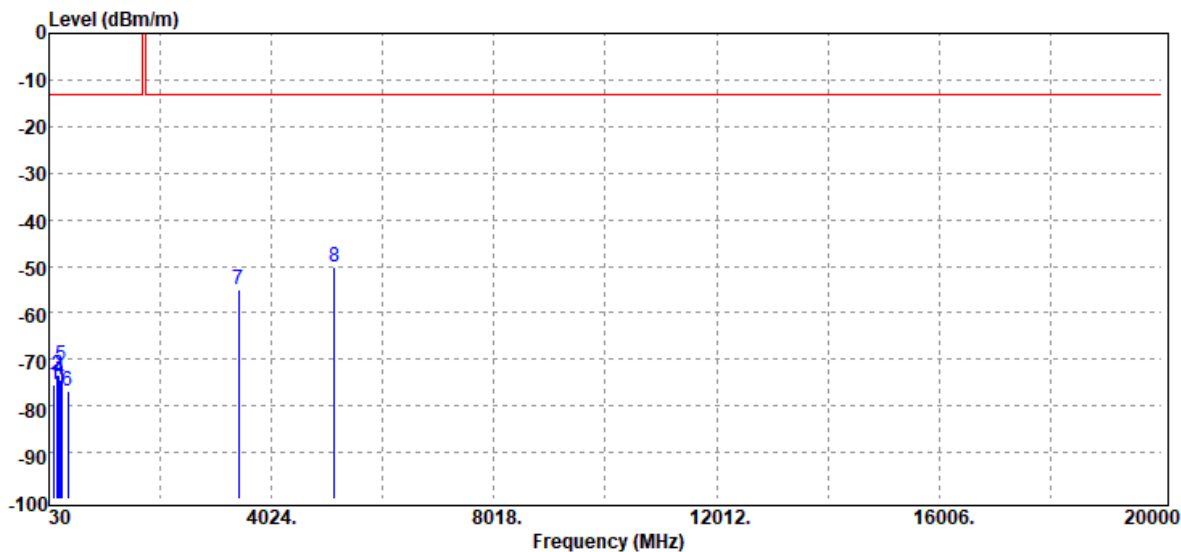

Freq. MHz	EIRP/ERP dBm	SG Output Level dBm	Antenna Gain dBi/dBd	Cable Loss dB	Limit dBm	Margin dB
124.09	-75.27	-72.27	-1.85	-1.15	-13.00	-62.27
183.26	-73.52	-74.20	2.07	-1.39	-13.00	-60.52
194.90	-73.51	-75.96	3.88	-1.43	-13.00	-60.51
228.85	-74.52	-77.80	4.86	-1.58	-13.00	-61.52
255.04	-71.26	-73.95	4.31	-1.62	-13.00	-58.26
362.71	-76.64	-79.15	4.46	-1.95	-13.00	-63.64
3435.00	-54.97	-61.59	12.53	-5.91	-13.00	-41.97
5152.50	-50.25	-54.43	12.12	-7.94	-13.00	-37.25

Unless otherwise stated the results shown in this test report refer only to the sample(s) tested and such sample(s) are retained for 90 days only.

除非另有說明，此報告結果僅對測試之樣品負責，同時此樣品僅保留90天。本報告未經本公司書面許可，不可部份複製。

This document is issued by the Company subject to its General Conditions of Service printed overleaf, available on request or accessible at <http://www.sgs.com.tw/Terms-and-Conditions> and for electronic format documents, subject to Terms and Conditions for Electronic Documents at <http://www.sgs.com.tw/Terms-and-Conditions>. Attention is drawn to the limitation of liability, indemnification and jurisdiction issues defined therein. Any holder of this document is advised that information contained hereon reflects the Company's findings at the time of its intervention only and within the limits of Client's instructions, if any. The Company's sole responsibility is to its Client and this document does not exonerate parties to a transaction from exercising all their rights and obligations under the transaction documents. This document cannot be reproduced except in full, without prior written approval of the Company. Any unauthorized alteration, forgery or falsification of the content or appearance of this document is unlawful and offenders may be prosecuted to the fullest extent of the law.

Report Number :ER-2021-70075
 Operation Mode :LTE B4
 Test Mode :Tx CH Low
 EUT Pol :H Plane
 Test Frequency :1717.5 MHz

Test Site :SAC 3
 Test Date :2021-08-12
 Temp./Humi. :27.4/51
 Antenna Pol. :HORIZONTAL
 Engineer :Nick Lin

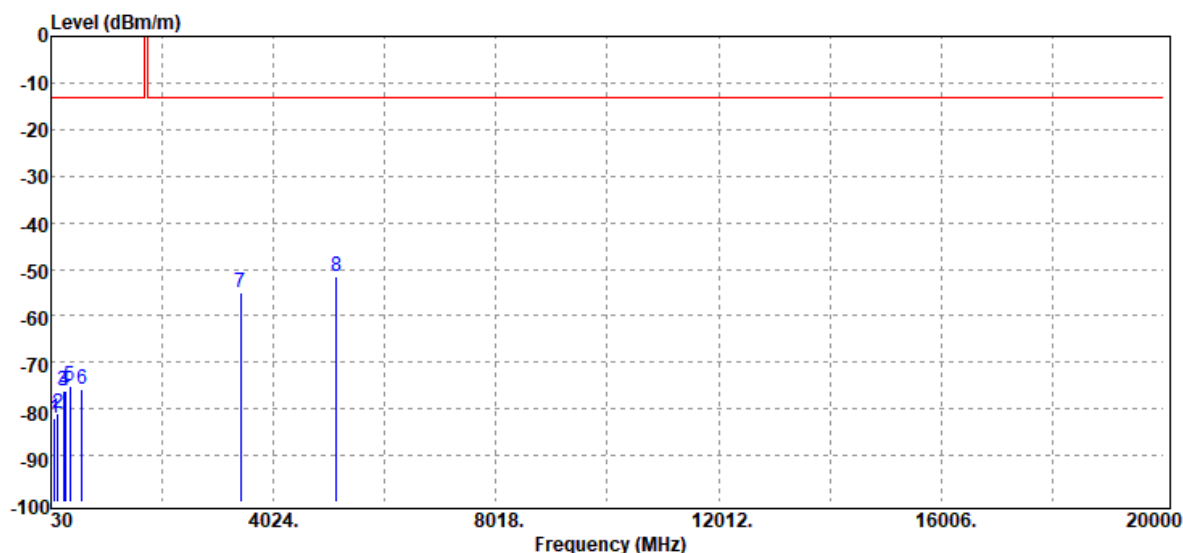

Freq. MHz	EIRP/ERP dBm	SG Output Level dBm	Antenna Gain dBi/dBd	Cable Loss dB	Limit dBm	Margin dB
91.11	-81.83	-80.60	-0.25	-0.98	-13.00	-68.83
149.31	-80.80	-78.01	-1.64	-1.15	-13.00	-67.80
251.16	-76.05	-78.79	4.33	-1.59	-13.00	-63.05
277.35	-75.99	-78.30	3.99	-1.68	-13.00	-62.99
376.29	-74.98	-77.34	4.36	-2.00	-13.00	-61.98
580.96	-75.80	-77.01	3.92	-2.71	-13.00	-62.80
3435.00	-55.10	-61.72	12.53	-5.91	-13.00	-42.10
5152.50	-51.71	-55.89	12.12	-7.94	-13.00	-38.71

Unless otherwise stated the results shown in this test report refer only to the sample(s) tested and such sample(s) are retained for 90 days only.

除非另有說明，此報告結果僅對測試之樣品負責，同時此樣品僅保留90天。本報告未經本公司書面許可，不可部份複製。

This document is issued by the Company subject to its General Conditions of Service printed overleaf, available on request or accessible at <http://www.sgs.com.tw/Terms-and-Conditions> and for electronic format documents, subject to Terms and Conditions for Electronic Documents at <http://www.sgs.com.tw/Terms-and-Conditions>. Attention is drawn to the limitation of liability, indemnification and jurisdiction issues defined therein. Any holder of this document is advised that information contained hereon reflects the Company's findings at the time of its intervention only and within the limits of Client's instructions, if any. The Company's sole responsibility is to its Client and this document does not exonerate parties to a transaction from exercising all their rights and obligations under the transaction documents. This document cannot be reproduced except in full, without prior written approval of the Company. Any unauthorized alteration, forgery or falsification of the content or appearance of this document is unlawful and offenders may be prosecuted to the fullest extent of the law.

Report Number :ER-2021-70075
 Operation Mode :LTE B5
 Test Mode :Tx CH High
 EUT Pol :H Plane
 Test Frequency :844 MHz

Test Site :SAC 3
 Test Date :2021-08-12
 Temp./Humi. :27.4/51
 Antenna Pol. :VERTICAL
 Engineer :Nick Lin

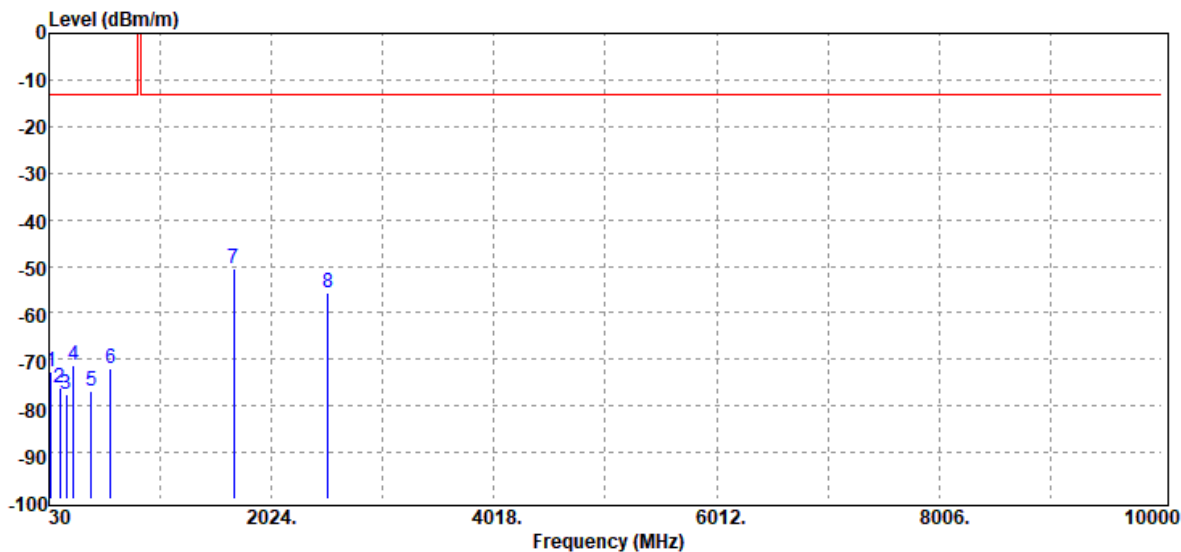

Freq. MHz	EIRP/ERP dBm	SG Output Level dBm	Antenna Gain dBi/dBd	Cable Loss dB	Limit dBm	Margin dB
51.34	-72.65	-60.46	-11.48	-0.71	-13.00	-59.65
124.09	-76.04	-73.04	-1.85	-1.15	-13.00	-63.04
185.20	-77.61	-78.57	2.37	-1.41	-13.00	-64.61
253.10	-71.34	-74.06	4.32	-1.60	-13.00	-58.34
406.36	-76.90	-79.31	4.36	-1.95	-13.00	-63.90
579.99	-71.93	-73.17	3.95	-2.71	-13.00	-58.93
1688.00	-50.41	-55.68	9.58	-4.31	-13.00	-37.41
2532.00	-55.80	-61.24	10.66	-5.22	-13.00	-42.80

Unless otherwise stated the results shown in this test report refer only to the sample(s) tested and such sample(s) are retained for 90 days only.

除非另有說明，此報告結果僅對測試之樣品負責，同時此樣品僅保留90天。本報告未經本公司書面許可，不可部份複製。

This document is issued by the Company subject to its General Conditions of Service printed overleaf, available on request or accessible at <http://www.sgs.com.tw/Terms-and-Conditions> and for electronic format documents, subject to Terms and Conditions for Electronic Documents at <http://www.sgs.com.tw/Terms-and-Conditions>. Attention is drawn to the limitation of liability, indemnification and jurisdiction issues defined therein. Any holder of this document is advised that information contained hereon reflects the Company's findings at the time of its intervention only and within the limits of Client's instructions, if any. The Company's sole responsibility is to its Client and this document does not exonerate parties to a transaction from exercising all their rights and obligations under the transaction documents. This document cannot be reproduced except in full, without prior written approval of the Company. Any unauthorized alteration, forgery or falsification of the content or appearance of this document is unlawful and offenders may be prosecuted to the fullest extent of the law.

Report Number :ER-2021-70075
 Operation Mode :LTE B5
 Test Mode :Tx CH High
 EUT Pol :H Plane
 Test Frequency :844 MHz

Test Site :SAC 3
 Test Date :2021-08-12
 Temp./Humi. :27.4/51
 Antenna Pol. :HORIZONTAL
 Engineer :Nick Lin

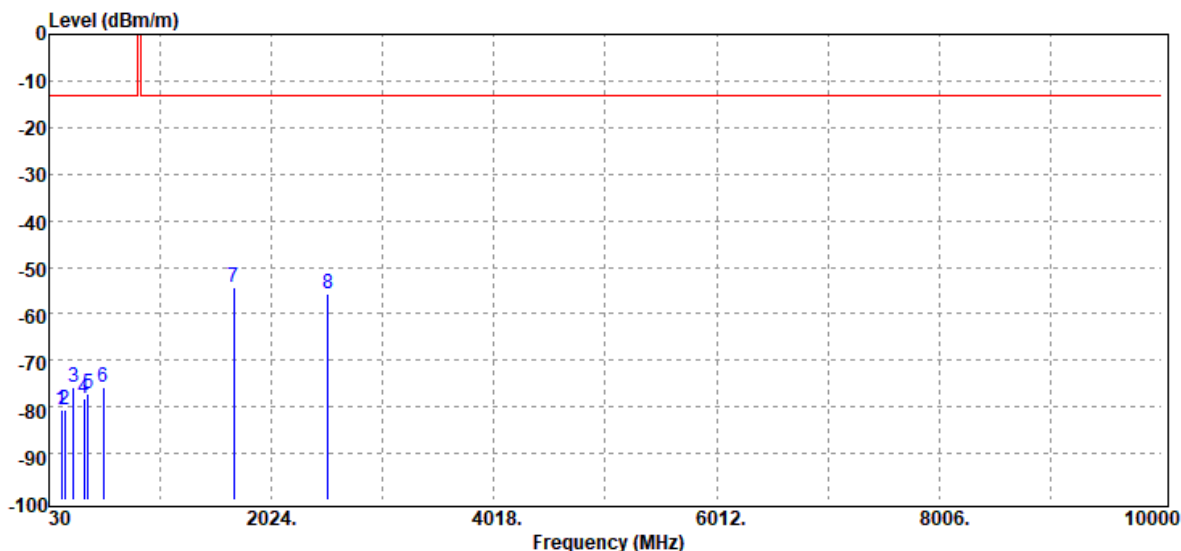

Freq. MHz	EIRP/ERP dBm	SG Output Level dBm	Antenna Gain dBi/dBd	Cable Loss dB	Limit dBm	Margin dB
139.61	-80.67	-77.33	-2.02	-1.32	-13.00	-67.67
168.71	-80.67	-79.00	-0.41	-1.26	-13.00	-67.67
253.10	-75.65	-78.37	4.32	-1.60	-13.00	-62.65
345.25	-78.16	-80.63	4.44	-1.97	-13.00	-65.16
379.20	-77.21	-79.57	4.37	-2.01	-13.00	-64.21
516.94	-75.80	-77.76	4.11	-2.15	-13.00	-62.80
1688.00	-54.33	-59.60	9.58	-4.31	-13.00	-41.33
2532.00	-55.61	-61.05	10.66	-5.22	-13.00	-42.61

Unless otherwise stated the results shown in this test report refer only to the sample(s) tested and such sample(s) are retained for 90 days only.

除非另有說明，此報告結果僅對測試之樣品負責，同時此樣品僅保留90天。本報告未經本公司書面許可，不可部份複製。

This document is issued by the Company subject to its General Conditions of Service printed overleaf, available on request or accessible at <http://www.sgs.com.tw/Terms-and-Conditions> and for electronic format documents, subject to Terms and Conditions for Electronic Documents at <http://www.sgs.com.tw/Terms-and-Conditions>. Attention is drawn to the limitation of liability, indemnification and jurisdiction issues defined therein. Any holder of this document is advised that information contained hereon reflects the Company's findings at the time of its intervention only and within the limits of Client's instructions, if any. The Company's sole responsibility is to its Client and this document does not exonerate parties to a transaction from exercising all their rights and obligations under the transaction documents. This document cannot be reproduced except in full, without prior written approval of the Company. Any unauthorized alteration, forgery or falsification of the content or appearance of this document is unlawful and offenders may be prosecuted to the fullest extent of the law.

Report Number :ER-2021-70075
 Operation Mode :LTE B12
 Test Mode :Tx CH Mid
 EUT Pol :H Plane
 Test Frequency :707.5 MHz

Test Site :SAC 3
 Test Date :2021-08-12
 Temp./Humi. :27.4/51
 Antenna Pol. :VERTICAL
 Engineer :Nick Lin

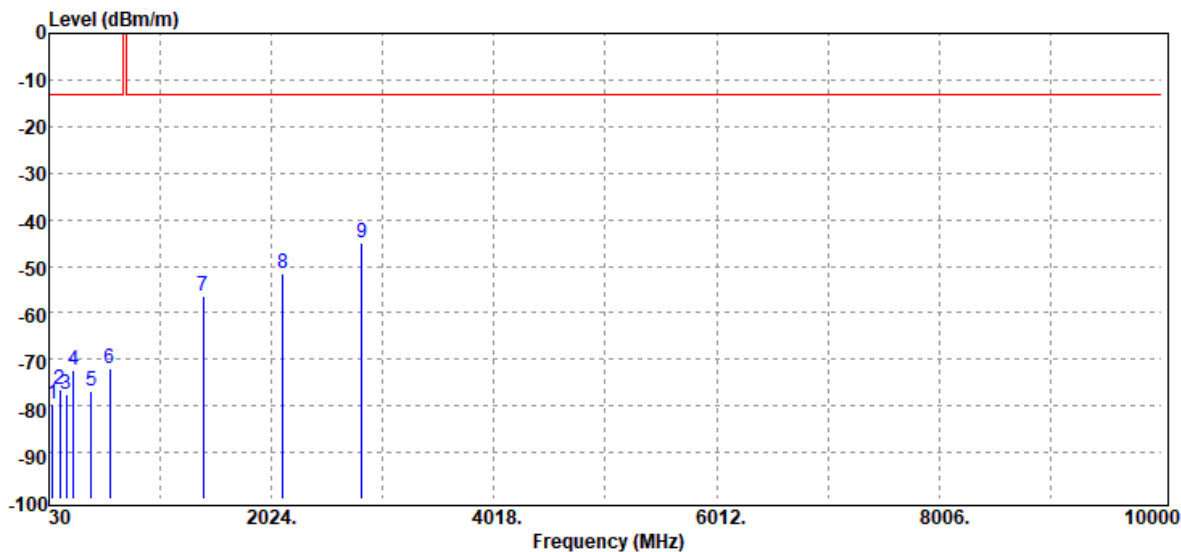

Freq. MHz	EIRP/ERP dBm	SG Output Level dBm	Antenna Gain dBi/dBd	Cable Loss dB	Limit dBm	Margin dB
62.01	-79.45	-69.82	-8.87	-0.76	-13.00	-66.45
124.09	-76.60	-73.60	-1.85	-1.15	-13.00	-63.60
182.29	-77.53	-78.06	1.92	-1.39	-13.00	-64.53
251.16	-72.30	-75.04	4.33	-1.59	-13.00	-59.30
406.36	-76.96	-79.37	4.36	-1.95	-13.00	-63.96
578.05	-71.96	-73.23	3.96	-2.69	-13.00	-58.96
1415.00	-56.54	-60.40	7.72	-3.86	-13.00	-43.54
2122.50	-51.60	-56.43	9.63	-4.80	-13.00	-38.60
2830.00	-44.95	-50.18	10.82	-5.59	-13.00	-31.95

Unless otherwise stated the results shown in this test report refer only to the sample(s) tested and such sample(s) are retained for 90 days only.

除非另有說明，此報告結果僅對測試之樣品負責，同時此樣品僅保留90天。本報告未經本公司書面許可，不可部份複製。

This document is issued by the Company subject to its General Conditions of Service printed overleaf, available on request or accessible at <http://www.sgs.com.tw/Terms-and-Conditions> and for electronic format documents, subject to Terms and Conditions for Electronic Documents at <http://www.sgs.com.tw/Terms-and-Conditions>. Attention is drawn to the limitation of liability, indemnification and jurisdiction issues defined therein. Any holder of this document is advised that information contained hereon reflects the Company's findings at the time of its intervention only and within the limits of Client's instructions, if any. The Company's sole responsibility is to its Client and this document does not exonerate parties to a transaction from exercising all their rights and obligations under the transaction documents. This document cannot be reproduced except in full, without prior written approval of the Company. Any unauthorized alteration, forgery or falsification of the content or appearance of this document is unlawful and offenders may be prosecuted to the fullest extent of the law.

Report Number :ER-2021-70075
 Operation Mode :LTE B12
 Test Mode :Tx CH Mid
 EUT Pol :H Plane
 Test Frequency :707.5 MHz

Test Site :SAC 3
 Test Date :2021-08-12
 Temp./Humi. :27.4/51
 Antenna Pol. :HORIZONTAL
 Engineer :Nick Lin

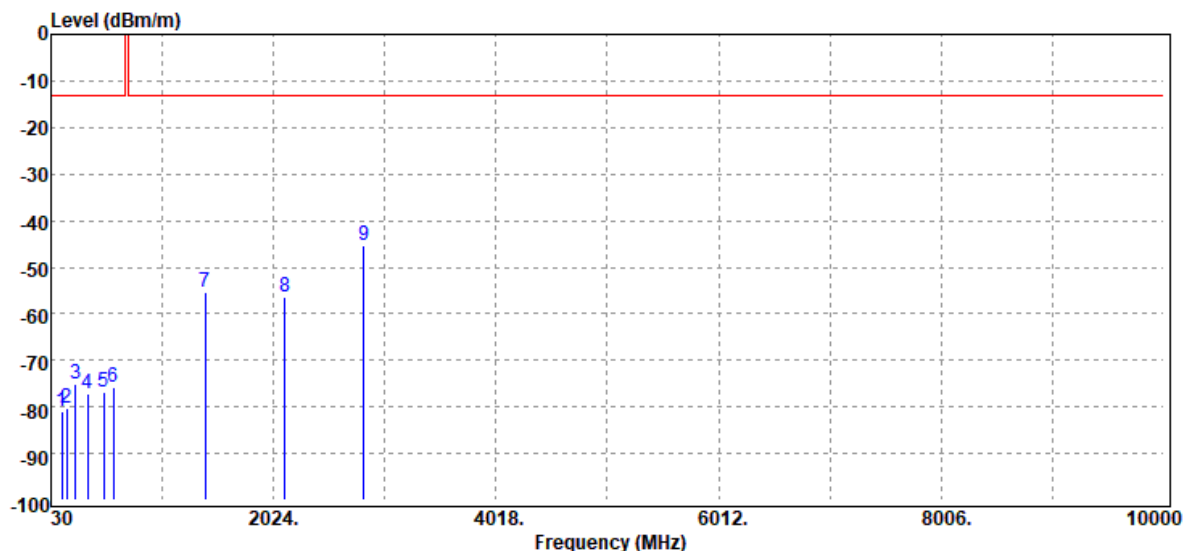

Freq. MHz	EIRP/ERP dBm	SG Output Level dBm	Antenna Gain dBi/dBd	Cable Loss dB	Limit dBm	Margin dB
128.94	-81.00	-77.83	-2.00	-1.17	-13.00	-68.00
170.65	-80.40	-78.92	-0.21	-1.27	-13.00	-67.40
251.16	-75.03	-77.77	4.33	-1.59	-13.00	-62.03
361.74	-77.07	-79.60	4.48	-1.95	-13.00	-64.07
500.45	-76.69	-78.53	4.25	-2.41	-13.00	-63.69
587.75	-75.64	-76.79	3.81	-2.66	-13.00	-62.64
1415.00	-55.52	-59.38	7.72	-3.86	-13.00	-42.52
2122.50	-56.41	-61.24	9.63	-4.80	-13.00	-43.41
2830.00	-45.33	-50.56	10.82	-5.59	-13.00	-32.33

Unless otherwise stated the results shown in this test report refer only to the sample(s) tested and such sample(s) are retained for 90 days only.

除非另有說明，此報告結果僅對測試之樣品負責，同時此樣品僅保留90天。本報告未經本公司書面許可，不可部份複製。

This document is issued by the Company subject to its General Conditions of Service printed overleaf, available on request or accessible at <http://www.sgs.com.tw/Terms-and-Conditions> and for electronic format documents, subject to Terms and Conditions for Electronic Documents at <http://www.sgs.com.tw/Terms-and-Conditions>. Attention is drawn to the limitation of liability, indemnification and jurisdiction issues defined therein. Any holder of this document is advised that information contained hereon reflects the Company's findings at the time of its intervention only and within the limits of Client's instructions, if any. The Company's sole responsibility is to its Client and this document does not exonerate parties to a transaction from exercising all their rights and obligations under the transaction documents. This document cannot be reproduced except in full, without prior written approval of the Company. Any unauthorized alteration, forgery or falsification of the content or appearance of this document is unlawful and offenders may be prosecuted to the fullest extent of the law.

Report Number :ER-2021-70075
 Operation Mode :LTE B13
 Test Mode :Tx CH High
 EUT Pol :H Plane
 Test Frequency :784.5 MHz

Test Site :SAC 3
 Test Date :2021-08-12
 Temp./Humi. :27.4/51
 Antenna Pol. :VERTICAL
 Engineer :Nick Lin

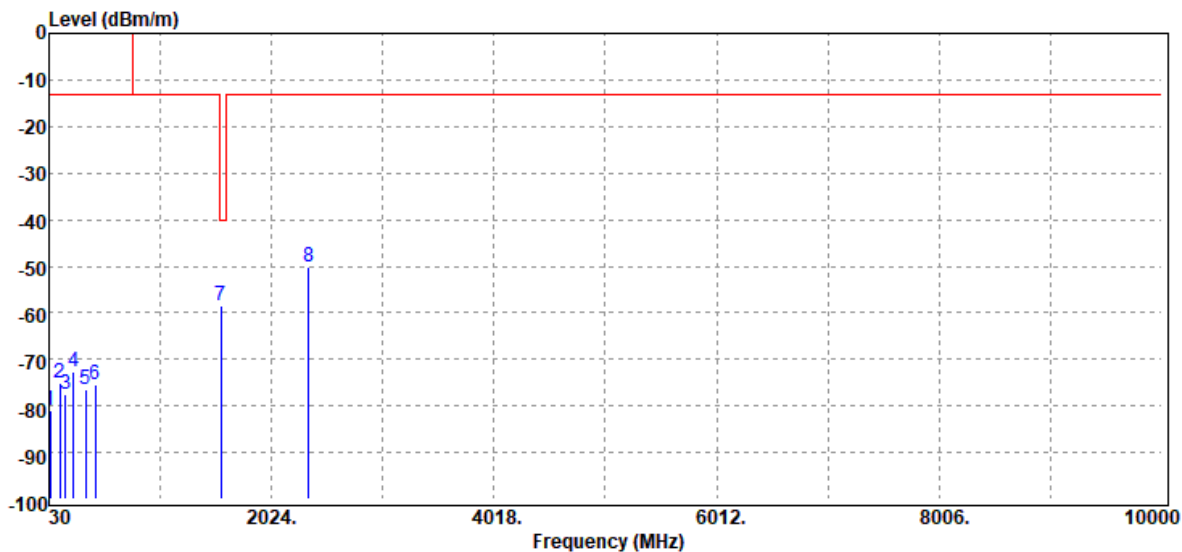

Freq. MHz	EIRP/ERP dBm	SG Output Level dBm	Antenna Gain dBi/dBd	Cable Loss dB	Limit dBm	Margin dB
41.64	-80.97	-66.99	-13.29	-0.69	-13.00	-67.97
124.09	-75.06	-72.06	-1.85	-1.15	-13.00	-62.06
180.35	-77.66	-77.75	1.47	-1.38	-13.00	-64.66
253.10	-72.64	-75.36	4.32	-1.60	-13.00	-59.64
359.80	-76.36	-78.93	4.51	-1.94	-13.00	-63.36
447.10	-75.52	-77.48	4.15	-2.19	-13.00	-62.52
1569.00	-58.35	-63.45	9.22	-4.12	-40.00	-18.35
2353.50	-50.17	-54.79	9.64	-5.02	-13.00	-37.17

Unless otherwise stated the results shown in this test report refer only to the sample(s) tested and such sample(s) are retained for 90 days only.

除非另有說明，此報告結果僅對測試之樣品負責，同時此樣品僅保留90天。本報告未經本公司書面許可，不可部份複製。

This document is issued by the Company subject to its General Conditions of Service printed overleaf, available on request or accessible at <http://www.sgs.com.tw/Terms-and-Conditions> and for electronic format documents, subject to Terms and Conditions for Electronic Documents at <http://www.sgs.com.tw/Terms-and-Conditions>. Attention is drawn to the limitation of liability, indemnification and jurisdiction issues defined therein. Any holder of this document is advised that information contained hereon reflects the Company's findings at the time of its intervention only and within the limits of Client's instructions, if any. The Company's sole responsibility is to its Client and this document does not exonerate parties to a transaction from exercising all their rights and obligations under the transaction documents. This document cannot be reproduced except in full, without prior written approval of the Company. Any unauthorized alteration, forgery or falsification of the content or appearance of this document is unlawful and offenders may be prosecuted to the fullest extent of the law.

Report Number :ER-2021-70075
 Operation Mode :LTE B13
 Test Mode :Tx CH High
 EUT Pol :H Plane
 Test Frequency :784.5 MHz

Test Site :SAC 3
 Test Date :2021-08-12
 Temp./Humi. :27.4/51
 Antenna Pol. :HORIZONTAL
 Engineer :Nick Lin

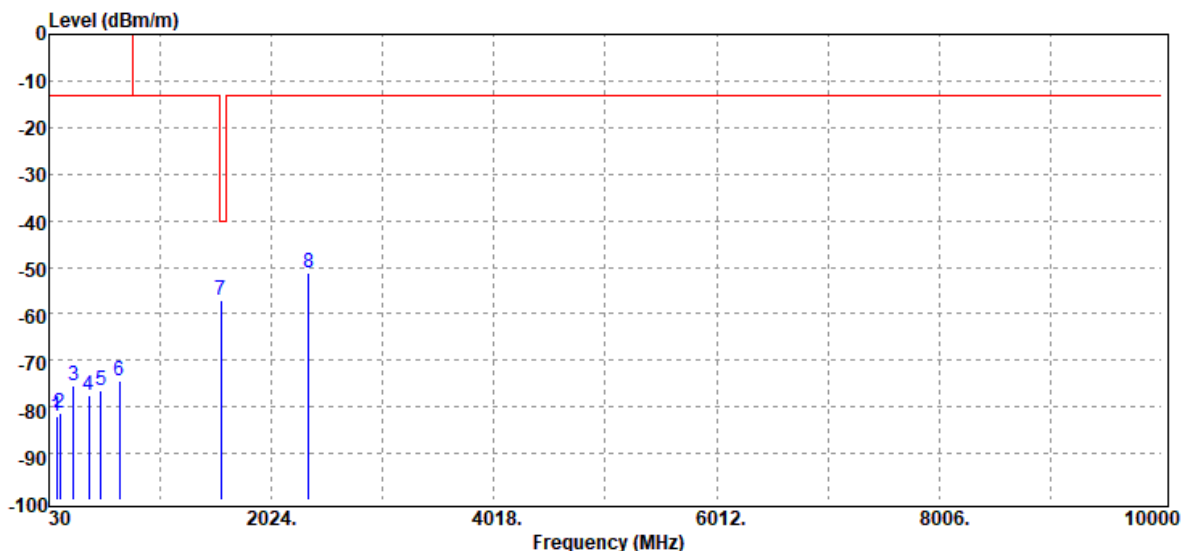

Freq. MHz	EIRP/ERP dBm	SG Output Level dBm	Antenna Gain dBi/dBd	Cable Loss dB	Limit dBm	Margin dB
94.99	-82.12	-80.75	-0.37	-1.00	-13.00	-69.12
127.00	-81.36	-78.16	-2.04	-1.16	-13.00	-68.36
251.16	-75.47	-78.21	4.33	-1.59	-13.00	-62.47
384.05	-77.41	-79.78	4.39	-2.02	-13.00	-64.41
493.66	-76.44	-78.33	4.20	-2.31	-13.00	-63.44
658.56	-74.51	-75.78	3.65	-2.38	-13.00	-61.51
1569.00	-57.03	-62.13	9.22	-4.12	-40.00	-17.03
2353.50	-51.16	-55.78	9.64	-5.02	-13.00	-38.16

Unless otherwise stated the results shown in this test report refer only to the sample(s) tested and such sample(s) are retained for 90 days only.

除非另有說明，此報告結果僅對測試之樣品負責，同時此樣品僅保留90天。本報告未經本公司書面許可，不可部份複製。

This document is issued by the Company subject to its General Conditions of Service printed overleaf, available on request or accessible at <http://www.sgs.com.tw/Terms-and-Conditions> and for electronic format documents, subject to Terms and Conditions for Electronic Documents at <http://www.sgs.com.tw/Terms-and-Conditions>. Attention is drawn to the limitation of liability, indemnification and jurisdiction issues defined therein. Any holder of this document is advised that information contained hereon reflects the Company's findings at the time of its intervention only and within the limits of Client's instructions, if any. The Company's sole responsibility is to its Client and this document does not exonerate parties to a transaction from exercising all their rights and obligations under the transaction documents. This document cannot be reproduced except in full, without prior written approval of the Company. Any unauthorized alteration, forgery or falsification of the content or appearance of this document is unlawful and offenders may be prosecuted to the fullest extent of the law.

Report Number :ER-2021-70075
 Operation Mode :LTE B14
 Test Mode :Tx CH Low
 EUT Pol :H Plane
 Test Frequency :790.5 MHz

Test Site :SAC 3
 Test Date :2021-08-12
 Temp./Humi. :27.4/51
 Antenna Pol. :VERTICAL
 Engineer :Nick Lin

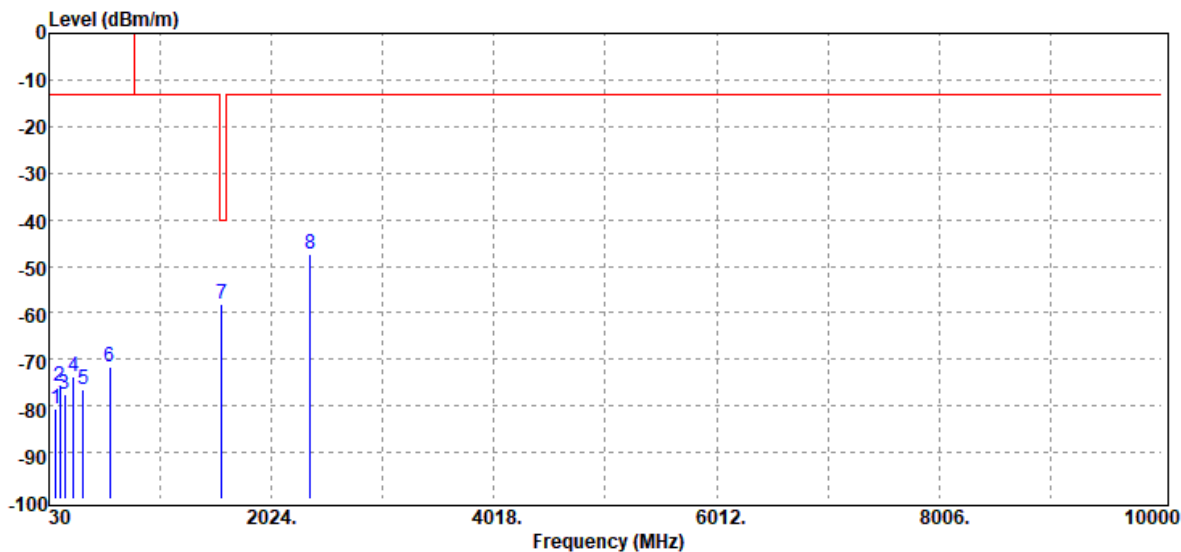

Freq. MHz	EIRP/ERP dBm	SG Output Level dBm	Antenna Gain dBi/dBd	Cable Loss dB	Limit dBm	Margin dB
93.05	-80.72	-79.47	-0.26	-0.99	-13.00	-67.72
124.09	-75.82	-72.82	-1.85	-1.15	-13.00	-62.82
167.74	-77.38	-75.57	-0.55	-1.26	-13.00	-64.38
251.16	-73.76	-76.50	4.33	-1.59	-13.00	-60.76
337.49	-76.33	-78.74	4.30	-1.89	-13.00	-63.33
576.11	-71.76	-73.06	3.97	-2.67	-13.00	-58.76
1581.00	-58.14	-63.29	9.29	-4.14	-40.00	-18.14
2371.50	-47.35	-52.11	9.82	-5.06	-13.00	-34.35

Unless otherwise stated the results shown in this test report refer only to the sample(s) tested and such sample(s) are retained for 90 days only.

除非另有說明，此報告結果僅對測試之樣品負責，同時此樣品僅保留90天。本報告未經本公司書面許可，不可部份複製。

This document is issued by the Company subject to its General Conditions of Service printed overleaf, available on request or accessible at <http://www.sgs.com.tw/Terms-and-Conditions> and for electronic format documents, subject to Terms and Conditions for Electronic Documents at <http://www.sgs.com.tw/Terms-and-Conditions>. Attention is drawn to the limitation of liability, indemnification and jurisdiction issues defined therein. Any holder of this document is advised that information contained hereon reflects the Company's findings at the time of its intervention only and within the limits of Client's instructions, if any. The Company's sole responsibility is to its Client and this document does not exonerate parties to a transaction from exercising all their rights and obligations under the transaction documents. This document cannot be reproduced except in full, without prior written approval of the Company. Any unauthorized alteration, forgery or falsification of the content or appearance of this document is unlawful and offenders may be prosecuted to the fullest extent of the law.

Report Number :ER-2021-70075
 Operation Mode :LTE B14
 Test Mode :Tx CH Low
 EUT Pol :H Plane
 Test Frequency :790.5 MHz

Test Site :SAC 3
 Test Date :2021-08-12
 Temp./Humi. :27.4/51
 Antenna Pol. :HORIZONTAL
 Engineer :Nick Lin

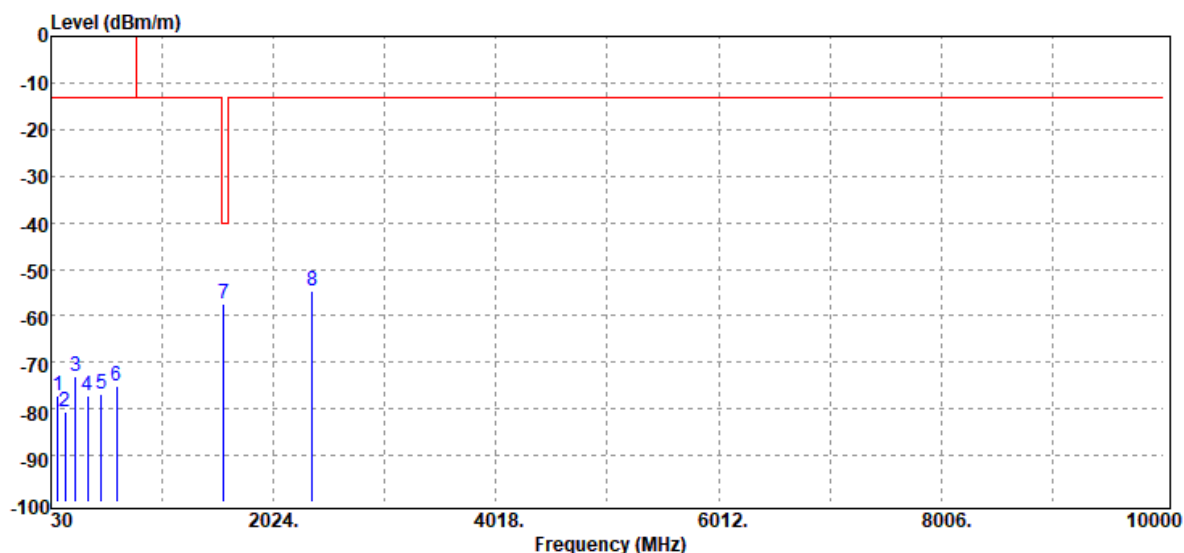

Freq. MHz	EIRP/ERP dBm	SG Output Level dBm	Antenna Gain dBi/dBd	Cable Loss dB	Limit dBm	Margin dB
91.11	-77.04	-75.81	-0.25	-0.98	-13.00	-64.04
156.10	-80.52	-77.95	-1.36	-1.21	-13.00	-67.52
253.10	-73.16	-75.88	4.32	-1.60	-13.00	-60.16
359.80	-77.16	-79.73	4.51	-1.94	-13.00	-64.16
478.14	-76.95	-78.75	4.21	-2.41	-13.00	-63.95
618.79	-75.20	-76.32	3.43	-2.31	-13.00	-62.20
1581.00	-57.52	-62.67	9.29	-4.14	-40.00	-17.52
2371.50	-54.60	-59.36	9.82	-5.06	-13.00	-41.60

Unless otherwise stated the results shown in this test report refer only to the sample(s) tested and such sample(s) are retained for 90 days only.

除非另有說明，此報告結果僅對測試之樣品負責，同時此樣品僅保留90天。本報告未經本公司書面許可，不可部份複製。

This document is issued by the Company subject to its General Conditions of Service printed overleaf, available on request or accessible at <http://www.sgs.com.tw/Terms-and-Conditions> and for electronic format documents, subject to Terms and Conditions for Electronic Documents at <http://www.sgs.com.tw/Terms-and-Conditions>. Attention is drawn to the limitation of liability, indemnification and jurisdiction issues defined therein. Any holder of this document is advised that information contained hereon reflects the Company's findings at the time of its intervention only and within the limits of Client's instructions, if any. The Company's sole responsibility is to its Client and this document does not exonerate parties to a transaction from exercising all their rights and obligations under the transaction documents. This document cannot be reproduced except in full, without prior written approval of the Company. Any unauthorized alteration, forgery or falsification of the content or appearance of this document is unlawful and offenders may be prosecuted to the fullest extent of the law.

Report Number :ER-2021-70075
 Operation Mode :LTE B66
 Test Mode :Tx CH Mid
 EUT Pol :H Plane
 Test Frequency :1745 MHz

Test Site :SAC 3
 Test Date :2021-08-12
 Temp./Humi. :27.4/51
 Antenna Pol. :VERTICAL
 Engineer :Nick Lin

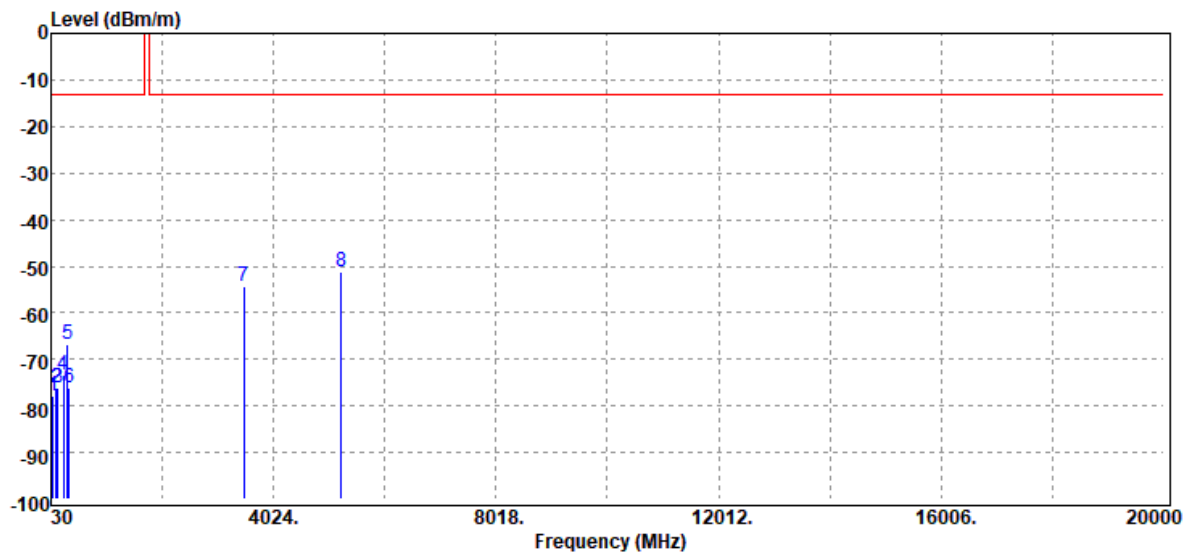

Freq. MHz	EIRP/ERP dBm	SG Output Level dBm	Antenna Gain dBi/dBd	Cable Loss dB	Limit dBm	Margin dB
61.04	-77.87	-67.82	-9.30	-0.75	-13.00	-64.87
125.06	-76.22	-73.19	-1.88	-1.15	-13.00	-63.22
154.16	-76.24	-73.66	-1.39	-1.19	-13.00	-63.24
253.10	-73.49	-76.21	4.32	-1.60	-13.00	-60.49
321.00	-66.75	-69.26	4.19	-1.68	-13.00	-53.75
361.74	-76.14	-78.67	4.48	-1.95	-13.00	-63.14
3490.00	-54.18	-60.34	12.42	-6.26	-13.00	-41.18
5235.00	-51.17	-55.86	12.68	-7.99	-13.00	-38.17

Unless otherwise stated the results shown in this test report refer only to the sample(s) tested and such sample(s) are retained for 90 days only.

除非另有說明，此報告結果僅對測試之樣品負責，同時此樣品僅保留90天。本報告未經本公司書面許可，不可部份複製。

This document is issued by the Company subject to its General Conditions of Service printed overleaf, available on request or accessible at <http://www.sgs.com.tw/Terms-and-Conditions> and for electronic format documents, subject to Terms and Conditions for Electronic Documents at <http://www.sgs.com.tw/Terms-and-Conditions>. Attention is drawn to the limitation of liability, indemnification and jurisdiction issues defined therein. Any holder of this document is advised that information contained hereon reflects the Company's findings at the time of its intervention only and within the limits of Client's instructions, if any. The Company's sole responsibility is to its Client and this document does not exonerate parties to a transaction from exercising all their rights and obligations under the transaction documents. This document cannot be reproduced except in full, without prior written approval of the Company. Any unauthorized alteration, forgery or falsification of the content or appearance of this document is unlawful and offenders may be prosecuted to the fullest extent of the law.

Report Number :ER-2021-70075
 Operation Mode :LTE B66
 Test Mode :Tx CH Mid
 EUT Pol :H Plane
 Test Frequency :1745 MHz

Test Site :SAC 3
 Test Date :2021-08-12
 Temp./Humi. :27.4/51
 Antenna Pol. :HORIZONTAL
 Engineer :Nick Lin

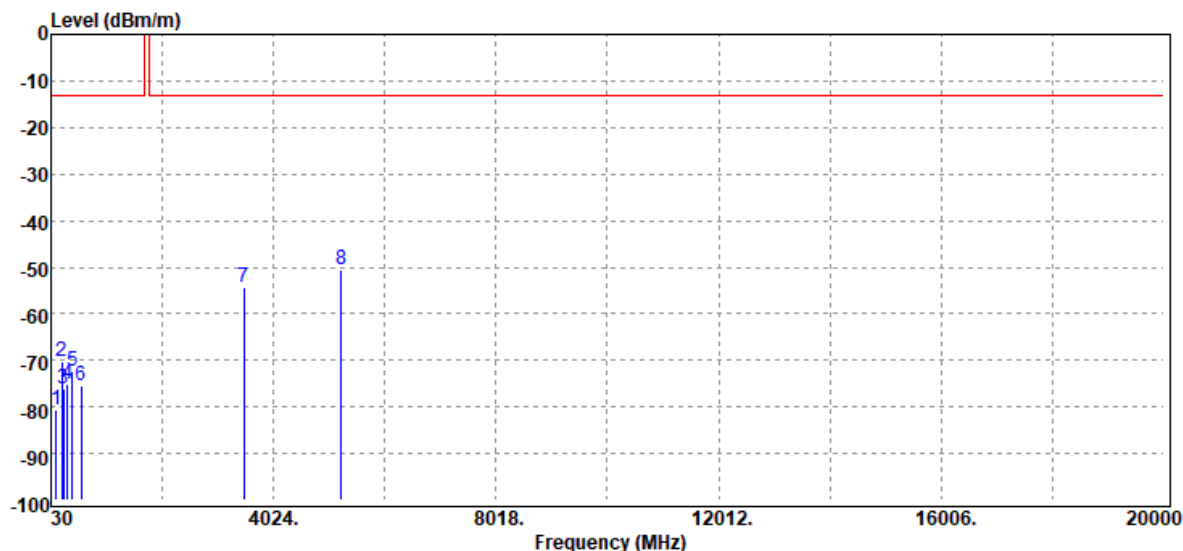

Freq. MHz	EIRP/ERP dBm	SG Output Level dBm	Antenna Gain dBi/dBd	Cable Loss dB	Limit dBm	Margin dB
124.09	-80.58	-77.58	-1.85	-1.15	-13.00	-67.58
228.85	-70.36	-73.64	4.86	-1.58	-13.00	-57.36
255.04	-76.07	-78.76	4.31	-1.62	-13.00	-63.07
319.06	-74.93	-77.45	4.18	-1.66	-13.00	-61.93
408.30	-72.37	-74.88	4.40	-1.89	-13.00	-59.37
571.26	-75.37	-76.81	4.07	-2.63	-13.00	-62.37
3490.00	-54.17	-60.33	12.42	-6.26	-13.00	-41.17
5235.00	-50.65	-55.34	12.68	-7.99	-13.00	-37.65

Unless otherwise stated the results shown in this test report refer only to the sample(s) tested and such sample(s) are retained for 90 days only.

除非另有說明，此報告結果僅對測試之樣品負責，同時此樣品僅保留90天。本報告未經本公司書面許可，不可部份複製。

This document is issued by the Company subject to its General Conditions of Service printed overleaf, available on request or accessible at <http://www.sgs.com.tw/Terms-and-Conditions> and for electronic format documents, subject to Terms and Conditions for Electronic Documents at <http://www.sgs.com.tw/Terms-and-Conditions>. Attention is drawn to the limitation of liability, indemnification and jurisdiction issues defined therein. Any holder of this document is advised that information contained hereon reflects the Company's findings at the time of its intervention only and within the limits of Client's instructions, if any. The Company's sole responsibility is to its Client and this document does not exonerate parties to a transaction from exercising all their rights and obligations under the transaction documents. This document cannot be reproduced except in full, without prior written approval of the Company. Any unauthorized alteration, forgery or falsification of the content or appearance of this document is unlawful and offenders may be prosecuted to the fullest extent of the law.

Report Number :ER-2021-70075
 Operation Mode :LTE B71
 Test Mode :Tx CH Low
 EUT Pol :H Plane
 Test Frequency :668 MHz

Test Site :SAC 3
 Test Date :2021-08-12
 Temp./Humi. :27.4/51
 Antenna Pol. :VERTICAL
 Engineer :Nick Lin

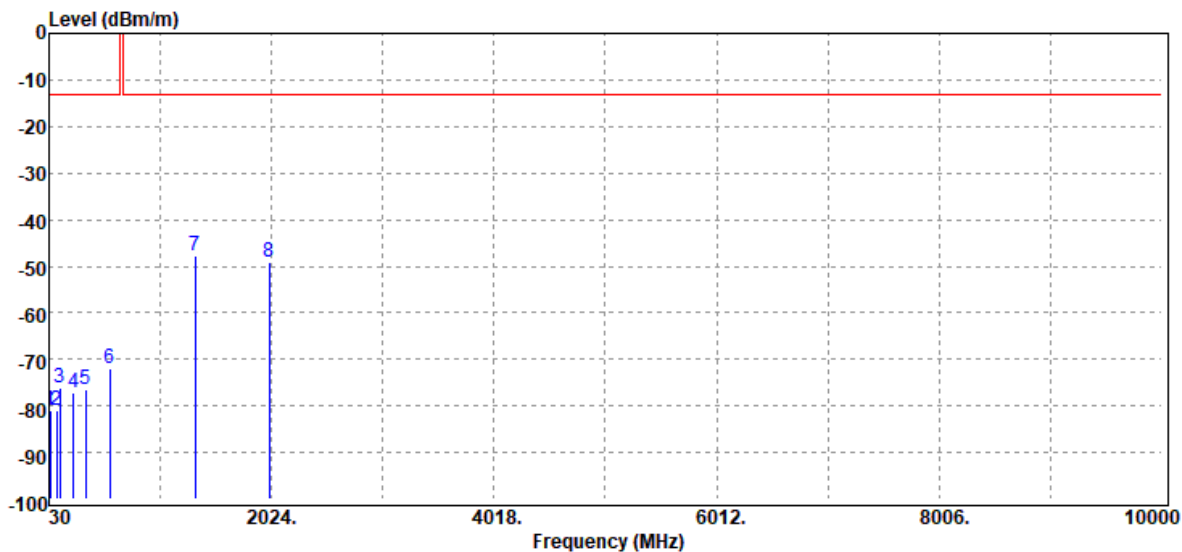

Freq. MHz	EIRP/ERP dBm	SG Output Level dBm	Antenna Gain dBi/dBd	Cable Loss dB	Limit dBm	Margin dB
42.61	-80.97	-66.99	-13.29	-0.69	-13.00	-67.97
97.90	-80.91	-79.30	-0.60	-1.01	-13.00	-67.91
125.06	-76.13	-73.10	-1.88	-1.15	-13.00	-63.13
253.10	-77.23	-79.95	4.32	-1.60	-13.00	-64.23
354.95	-76.62	-79.12	4.49	-1.99	-13.00	-63.62
578.05	-71.98	-73.25	3.96	-2.69	-13.00	-58.98
1336.00	-47.58	-50.95	7.13	-3.76	-13.00	-34.58
2004.00	-49.15	-54.65	10.19	-4.69	-13.00	-36.15

Unless otherwise stated the results shown in this test report refer only to the sample(s) tested and such sample(s) are retained for 90 days only.

除非另有說明，此報告結果僅對測試之樣品負責，同時此樣品僅保留90天。本報告未經本公司書面許可，不可部份複製。

This document is issued by the Company subject to its General Conditions of Service printed overleaf, available on request or accessible at <http://www.sgs.com.tw/Terms-and-Conditions> and for electronic format documents, subject to Terms and Conditions for Electronic Documents at <http://www.sgs.com.tw/Terms-and-Conditions>. Attention is drawn to the limitation of liability, indemnification and jurisdiction issues defined therein. Any holder of this document is advised that information contained hereon reflects the Company's findings at the time of its intervention only and within the limits of Client's instructions, if any. The Company's sole responsibility is to its Client and this document does not exonerate parties to a transaction from exercising all their rights and obligations under the transaction documents. This document cannot be reproduced except in full, without prior written approval of the Company. Any unauthorized alteration, forgery or falsification of the content or appearance of this document is unlawful and offenders may be prosecuted to the fullest extent of the law.

Report Number :ER-2021-70075
 Operation Mode :LTE B71
 Test Mode :Tx CH Low
 EUT Pol :H Plane
 Test Frequency :668 MHz

Test Site :SAC 3
 Test Date :2021-08-12
 Temp./Humi. :27.4/51
 Antenna Pol. :HORIZONTAL
 Engineer :Nick Lin

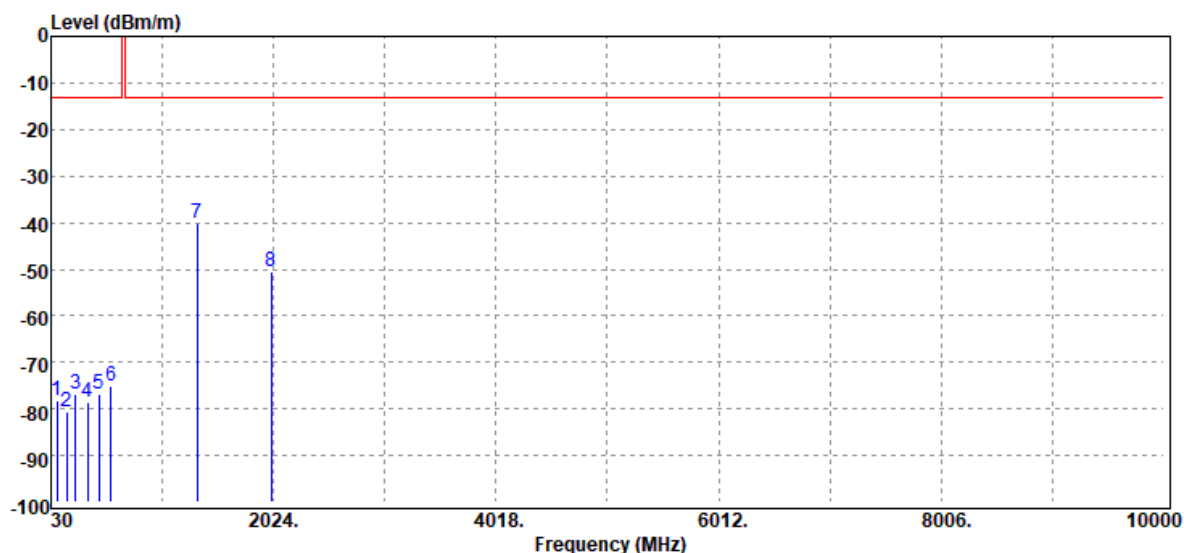

Freq. MHz	EIRP/ERP dBm	SG Output Level dBm	Antenna Gain dBi/dBd	Cable Loss dB	Limit dBm	Margin dB
86.26	-78.35	-76.42	-0.98	-0.95	-13.00	-65.35
170.65	-80.67	-79.19	-0.21	-1.27	-13.00	-67.67
253.10	-76.73	-79.45	4.32	-1.60	-13.00	-63.73
361.74	-78.41	-80.94	4.48	-1.95	-13.00	-65.41
456.80	-76.66	-78.49	4.14	-2.31	-13.00	-63.66
570.29	-75.07	-76.54	4.09	-2.62	-13.00	-62.07
1336.00	-40.28	-43.65	7.13	-3.76	-13.00	-27.28
2004.00	-50.49	-55.99	10.19	-4.69	-13.00	-37.49

~ End of Report ~

Unless otherwise stated the results shown in this test report refer only to the sample(s) tested and such sample(s) are retained for 90 days only.

除非另有說明，此報告結果僅對測試之樣品負責，同時此樣品僅保留90天。本報告未經本公司書面許可，不可部份複製。

This document is issued by the Company subject to its General Conditions of Service printed overleaf, available on request or accessible at <http://www.sgs.com.tw/Terms-and-Conditions> and for electronic format documents, subject to Terms and Conditions for Electronic Documents at <http://www.sgs.com.tw/Terms-and-Conditions>. Attention is drawn to the limitation of liability, indemnification and jurisdiction issues defined therein. Any holder of this document is advised that information contained hereon reflects the Company's findings at the time of its intervention only and within the limits of Client's instructions, if any. The Company's sole responsibility is to its Client and this document does not exonerate parties to a transaction from exercising all their rights and obligations under the transaction documents. This document cannot be reproduced except in full, without prior written approval of the Company. Any unauthorized alteration, forgery or falsification of the content or appearance of this document is unlawful and offenders may be prosecuted to the fullest extent of the law.