

FCC Test Report

Report No.: RF180830E03-1

FCC ID: 2APLE18300394

Test Model: VMB5000

Received Date: Sep. 04, 2018

Test Date: Sep. 08 to Oct. 13, 2018

Issued Date: Nov. 01, 2018

Applicant: Arlo Technologies, Inc.

Address: 2200 Faraday Ave. Suite 150, Carlsbad, CA 92008, United States

Issued By: Bureau Veritas Consumer Products Services (H.K.) Ltd., Taoyuan Branch
Hsin Chu Laboratory

Lab Address: E-2, No.1, Li Hsin 1st Road, Hsinchu Science Park, Hsinchu City 300,
Taiwan R.O.C.

Test Location: E-2, No.1, Li Hsin 1st Road, Hsinchu Science Park, Hsinchu City 300,
Taiwan R.O.C.

**FCC Registration /
Designation Number:** 723255 / TW2022



This report is for your exclusive use. Any copying or replication of this report to or for any other person or entity, or use of our name or trademark, is permitted only with our prior written permission. This report sets forth our findings solely with respect to the test samples identified herein. The results set forth in this report are not indicative or representative of the quality or characteristics of the lot from which a test sample was taken or any similar or identical product unless specifically and expressly noted. Our report includes all of the tests requested by you and the results thereof based upon the information that you provided to us. You have 60 days from date of issuance of this report to notify us of any material error or omission caused by our negligence, provided, however, that such notice shall be in writing and shall specifically address the issue you wish to raise. A failure to raise such issue within the prescribed time shall constitute your unqualified acceptance of the completeness of this report, the tests conducted and the correctness of the report contents. Unless specific mention, the uncertainty of measurement has been explicitly taken into account to declare the compliance or non-compliance to the specification. The report must not be used by the client to claim product certification, approval, or endorsement by TAF or any government agencies.

Table of Contents

| | |
|--|-----------|
| Release Control Record | 4 |
| 1 Certificate of Conformity | 5 |
| 2 Summary of Test Results | 6 |
| 2.1 Measurement Uncertainty | 6 |
| 2.2 Modification Record | 6 |
| 3 General Information | 7 |
| 3.1 General Description of EUT (WLAN) | 7 |
| 3.2 Description of Test Modes | 10 |
| 3.2.1 Test Mode Applicability and Tested Channel Detail | 11 |
| 3.3 Duty Cycle of Test Signal | 13 |
| 3.4 Description of Support Units | 14 |
| 3.4.1 Configuration of System under Test | 15 |
| 3.5 General Description of Applied Standard | 16 |
| 4 Test Types and Results | 17 |
| 4.1 Radiated Emission and Bandedge Measurement | 17 |
| 4.1.1 Limits of Radiated Emission and Bandedge Measurement | 17 |
| 4.1.2 Test Instruments | 18 |
| 4.1.3 Test Procedure | 20 |
| 4.1.4 Deviation from Test Standard | 20 |
| 4.1.5 Test Setup | 21 |
| 4.1.6 EUT Operating Condition | 22 |
| 4.1.7 Test Results | 23 |
| 4.2 Conducted Emission Measurement | 43 |
| 4.2.1 Limits of Conducted Emission Measurement | 43 |
| 4.2.2 Test Instruments | 43 |
| 4.2.3 Test Procedure | 44 |
| 4.2.4 Deviation from Test Standard | 44 |
| 4.2.5 Test Setup | 44 |
| 4.2.6 EUT Operating Condition | 44 |
| 4.2.7 Test Results | 45 |
| 4.3 Transmit Power Measurement | 47 |
| 4.3.1 Limits of Transmit Power Measurement | 47 |
| 4.3.2 Test Setup | 47 |
| 4.3.3 Test Instruments | 47 |
| 4.3.4 Test Procedure | 47 |
| 4.3.5 Deviation from Test Standard | 47 |
| 4.3.6 EUT Operating Condition | 47 |
| 4.3.7 Test Results | 48 |
| 4.4 Occupied Bandwidth Measurement | 49 |
| 4.4.1 Test Setup | 49 |
| 4.4.2 Test Instruments | 49 |
| 4.4.3 Test Procedure | 49 |
| 4.4.4 Test Results | 50 |
| 4.5 Peak Power Spectral Density Measurement | 54 |
| 4.5.1 Limits of Peak Power Spectral Density Measurement | 54 |
| 4.5.2 Test Setup | 54 |
| 4.5.3 Test Instruments | 54 |
| 4.5.4 Test Procedure | 55 |
| 4.5.5 Deviation from Test Standard | 55 |
| 4.5.6 EUT Operating Condition | 55 |
| 4.5.7 Test Results | 56 |
| 4.6 Frequency Stability Measurement | 62 |
| 4.6.1 Limits of Frequency Stability Measurement | 62 |

| | | |
|----------|---|-----------|
| 4.6.2 | Test Setup..... | 62 |
| 4.6.3 | Test Instruments | 62 |
| 4.6.4 | Test Procedure | 62 |
| 4.6.5 | Deviation from Test Standard | 62 |
| 4.6.6 | EUT Operating Condition | 62 |
| 4.6.7 | Test Results | 63 |
| 4.7 | 6dB Bandwidth Measurement | 64 |
| 4.7.1 | Limits of 6dB Bandwidth Measurement..... | 64 |
| 4.7.2 | Test Setup..... | 64 |
| 4.7.3 | Test Instruments | 64 |
| 4.7.4 | Test Procedure | 64 |
| 4.7.5 | Deviation from Test Standard | 64 |
| 4.7.6 | EUT Operating Condition | 64 |
| 4.7.7 | Test Results | 65 |
| 5 | Pictures of Test Arrangements..... | 67 |
| | Annex A- Radiated Out of Band Emission (OOBE) Measurement (For U-NII-3 band) | 68 |
| | Appendix – Information on the Testing Laboratories | 71 |

Release Control Record

| Issue No. | Description | Date Issued |
|---------------|-------------------|---------------|
| RF180830E03-1 | Original release. | Nov. 01, 2018 |

1 Certificate of Conformity

Product: Alro Gen5 Entry Hub

Brand: Arlo

Test Model: VMB5000

Sample Status: ENGINEERING SAMPLE

Applicant: Arlo Technologies, Inc.

Test Date: Sep. 08 to Oct. 13, 2018

Standard: 47 CFR FCC Part 15, Subpart E (Section 15.407)
ANSI C63.10: 2013

The above equipment has been tested by **Bureau Veritas Consumer Products Services (H.K.) Ltd., Taoyuan Branch**, and found compliance with the requirement of the above standards. The test record, data evaluation & Equipment Under Test (EUT) configurations represented herein are true and accurate accounts of the measurements of the sample's EMC characteristics under the conditions specified in this report.

Prepared by :

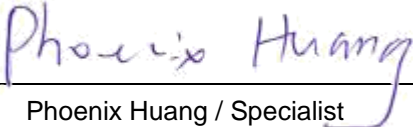
Phoenix Huang / Specialist

Date:

Nov. 01, 2018

Approved by :

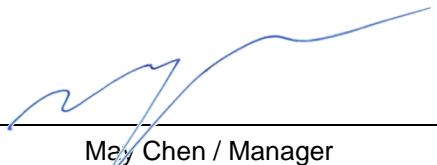
May Chen / Manager

Date:

Nov. 01, 2018

2 Summary of Test Results

| 47 CFR FCC Part 15, Subpart E (Section 15.407) | | | |
|--|---|--------|--|
| FCC Clause | Test Item | Result | Remarks |
| 15.407(b)(6) | AC Power Conducted Emissions | Pass | Meet the requirement of limit. Minimum passing margin is -13.19dB at 0.15000MHz. |
| 15.407(b) (1/2/3/4(i/ii)/6) | Radiated Emissions & Band Edge Measurement* | Pass | Meet the requirement of limit. Minimum passing margin is -0.1dB at 5150.00MHz and 5136.00MHz. |
| 15.407(a)(1/2/3) | Max Average Transmit Power | Pass | Meet the requirement of limit. |
| --- | Occupied Bandwidth Measurement | - | Reference only. |
| 15.407(a)(1/2/3) | Peak Power Spectral Density | Pass | Meet the requirement of limit. |
| 15.407(e) | 6dB bandwidth | Pass | Meet the requirement of limit. (U-NII-3 Band only) |
| 15.407(g) | Frequency Stability | Pass | Meet the requirement of limit. |
| 15.203 | Antenna Requirement | Pass | Antenna connector is i-pex not a standard connector. |

*For U-NII-3 band compliance with rule part 15.407(b)(4)(i), the OOB test plots were recorded in Annex A.

2.1 Measurement Uncertainty

Where relevant, the following measurement uncertainty levels have been estimated for tests performed on the EUT as specified in CISPR 16-4-2:

| Measurement | Frequency | Expanded Uncertainty (k=2) (±) |
|------------------------------------|----------------|--------------------------------|
| Conducted Emissions at mains ports | 150kHz ~ 30MHz | 1.84 dB |
| Radiated Emissions up to 1 GHz | 30MHz ~ 1GHz | 5.53 dB |
| Radiated Emissions above 1 GHz | 1GHz ~ 6GHz | 5.08 dB |
| | 6GHz ~ 18GHz | 4.98 dB |
| | 18GHz ~ 40GHz | 5.19 dB |

2.2 Modification Record

There were no modifications required for compliance.

3 General Information

3.1 General Description of EUT (WLAN)

| | |
|-----------------------|---|
| Product | Alro Gen5 Entry Hub |
| Brand | Arlo |
| Test Model | VMB5000 |
| Status of EUT | ENGINEERING SAMPLE |
| Power Supply Rating | 12Vdc from power adapter |
| Modulation Type | CCK, DQPSK, DBPSK for DSSS 64QAM, 16QAM, QPSK, BPSK for OFDM 256QAM for OFDM in 11ac mode only |
| Modulation Technology | DSSS, OFDM |
| Transfer Rate | 802.11b: up to 11Mbps 802.11a/g: up to 54Mbps 802.11n: up to 300Mbps 802.11ac: up to 866.7Mbps |
| Operating Frequency | 2.4GHz: 2.412 ~ 2.462GHz 5GHz: 5.18~ 5.24GHz, 5.745 ~ 5.825GHz |
| Number of Channel | 2.4GHz: 802.11b, 802.11g, 802.11n (HT20): 11 802.11n (HT40): 7 5GHz: 802.11a, 802.11n (HT20), 802.11ac (VHT20): 9 802.11n (HT40), 802.11ac (VHT40): 4 802.11ac (VHT80): 2 |
| Output Power | 2.412 ~ 2.462GHz: 508.821mW 5.18 ~ 5.24GHz: 571.179mW 5.745 ~ 5.825GHz: 490.624mW |
| Antenna Type | Refer to Note |
| Antenna Connector | Refer to Note |
| Accessory Device | Adapter x1 |
| Data Cable Supplied | NA |

Note:

- There are WLAN, Z-Wave, Zigbee and Sub-GHz technology used for the EUT. The EUT has below radios as following table:

| Radio 1 | Radio 2 | Radio 3 | Radio 4 |
|-------------------------|---------|---------|---------|
| WLAN (2.4GHz+5GHz band) | Z-Wave | Zigbee | Sub-GHz |

- Simultaneously transmission condition.

| Condition | Technology | | | | |
|-----------|-------------|-----------|--------|--------|---------|
| 1 | WLAN 2.4GHz | WLAN 5GHz | Z-Wave | Zigbee | Sub-GHz |

Note: The emission of the simultaneous operation has been evaluated and no non-compliance was found.

3. The EUT must be supplied with a power adapter and following different models could be chosen as following table:

| No. | Brand | Model No. | P/N No. | Spec. |
|-----|---------|---------------|--------------|--|
| 1 | NETGEAR | AD2076F10 | 332-10993-01 | Input: 100-120Vac, 0.56A, 50/60Hz Output: 12Vdc, 1.5A DC output cable (Unshielded, 1.8m) |
| 2 | NETGEAR | AD2067M20 | 332-11074-01 | Input: 100-240Vac, 1.0A, 50/60Hz Output: 12Vdc, 2.5A DC output cable (Unshielded, 1.8m) |
| 3 | NETGEAR | 2ABB018F 1 NJ | 332-10927-01 | Input: 100-120Vac, 0.6A, 50/60Hz Output: 12Vdc, 1.5A DC output cable (Unshielded, 1.8m) |
| 4 | NETGEAR | P030WM120B | 332-10345-02 | Input: 100-240Vac, 1.0A, 50/60Hz Output: 12Vdc, 2.5A DC output cable (Unshielded, 1.8m) |

Note: From the above models, the worst radiated emission and AC power conducted emission test was found in **Adapter 2**. Therefore only the test data of the modes were recorded in this report.

4. The antennas provided to the EUT, please refer to the following table:

| Sub-GHz | | | | | | | |
|---------|----------------------------|------------------|------------------------|----------------------|--------------|----------------|-------------------|
| Ant No. | Brand | Model | Antenna Gain (dBi) | Frequency rang (MHz) | Antenna type | Connector type | |
| 1 | NA | 902P00214N0 | 1.5 | 860~930 | PIFA | NA | |
| Z-Wave | | | | | | | |
| Ant No. | Brand | Model | Antenna Gain (dBi) | Frequency rang (MHz) | Antenna type | Connector type | |
| 1 | NA | 902P00213N0 | 2.5 | 860~930 | PIFA | NA | |
| Zigbee | | | | | | | |
| Ant No. | Brand | Model | Antenna Gain (dBi) | Frequency rang (GHz) | Antenna type | Connector type | |
| 1 | INPAQ TECHNOLOGY CO., LTD. | ACA-5036-A2-CC-S | 3.5 | 2.4~2.4835 | CHIP | NA | |
| WLAN | | | | | | | |
| Ant No. | Brand | Model | Antenna Net Gain (dBi) | Frequency rang (GHz) | Antenna type | Connector type | Cable Length (mm) |
| 1 | NA | 9 07X01052X0 | 2.5 | 2.4~2.4835 | Dipole | i-pex | 75 |
| | | | 1.8 | 5.15~5.25 | | | |
| | | | 2 | 5.25~5.35 | | | |
| | | | 2.2 | 5.47~5.725 | | | |
| | | | 1.6 | 5.725~5.85 | | | |
| 2 | NA | 9 07X00747X19 | 2.5 | 2.4~2.4835 | Dipole | i-pex | 90 |
| | | | 2.2 | 5.15~5.25 | | | |
| | | | 1.2 | 5.25~5.35 | | | |
| | | | 3.2 | 5.47~5.725 | | | |
| | | | 3.5 | 5.725~5.85 | | | |

5. The EUT incorporates a MIMO function.

| 2.4GHz Band | | | |
|------------------|-----------------|-----------------------|-----|
| MODULATION MODE | DATA RATE (MCS) | TX & RX CONFIGURATION | |
| 802.11b | 1 ~ 11Mbps | 2TX | 2RX |
| 802.11g | 6 ~ 54Mbps | 2TX | 2RX |
| 802.11n (HT20) | MCS 0~7 | 2TX | 2RX |
| | MCS 8~15 | 2TX | 2RX |
| 802.11n (HT40) | MCS 0~7 | 2TX | 2RX |
| | MCS 8~15 | 2TX | 2RX |
| 5GHz Band | | | |
| MODULATION MODE | DATA RATE (MCS) | TX & RX CONFIGURATION | |
| 802.11a | 6 ~ 54Mbps | 2TX | 2RX |
| 802.11n (HT20) | MCS 0~7 | 2TX | 2RX |
| | MCS 8~15 | 2TX | 2RX |
| 802.11n (HT40) | MCS 0~7 | 2TX | 2RX |
| | MCS 8~15 | 2TX | 2RX |
| 802.11ac (VHT20) | MCS0~8 Nss=1 | 2TX | 2RX |
| | MCS0~8 Nss=2 | 2TX | 2RX |
| 802.11ac (VHT40) | MCS0~9 Nss=1 | 2TX | 2RX |
| | MCS0~9 Nss=2 | 2TX | 2RX |
| 802.11ac (VHT80) | MCS0~9 Nss=1 | 2TX | 2RX |
| | MCS0~9 Nss=2 | 2TX | 2RX |

Note:

- The modulation and bandwidth are similar for 802.11n mode for 20MHz (40MHz) and 802.11ac mode for 20MHz (40MHz), therefore investigated worst case to representative mode in test report. (Final test mode refer section 3.2.1)

6. The above EUT information is declared by manufacturer and for more detailed features description, please refers to the manufacturer's specifications or user's manual.

3.2 Description of Test Modes

FOR 5180 ~ 5240MHz

4 channels are provided for 802.11a, 802.11n (HT20), 802.11ac (VHT20):

| Channel | Frequency | Channel | Frequency |
|---------|-----------|---------|-----------|
| 36 | 5180 MHz | 44 | 5220 MHz |
| 40 | 5200 MHz | 48 | 5240 MHz |

2 channels are provided for 802.11n (HT40), 802.11ac (VHT40):

| Channel | Frequency | Channel | Frequency |
|---------|-----------|---------|-----------|
| 38 | 5190 MHz | 46 | 5230 MHz |

1 channel is provided for 802.11ac (VHT80):

| Channel | Frequency |
|---------|-----------|
| 42 | 5210 MHz |

FOR 5745 ~ 5825MHz:

5 channels are provided for 802.11a, 802.11n (HT20), 802.11ac (VHT20):

| Channel | Frequency | Channel | Frequency |
|---------|-----------|---------|-----------|
| 149 | 5745 MHz | 161 | 5805 MHz |
| 153 | 5765 MHz | 165 | 5825 MHz |
| 157 | 5785 MHz | | |

2 channels are provided for 802.11n (HT40), 802.11ac (VHT40):

| Channel | Frequency | Channel | Frequency |
|---------|-----------|---------|-----------|
| 151 | 5755 MHz | 159 | 5795 MHz |

1 channel is provided for 802.11ac (VHT80):

| Channel | Frequency |
|---------|-----------|
| 155 | 5775 MHz |

3.2.1 Test Mode Applicability and Tested Channel Detail

| EUT Configure Mode | Applicable To | | | | Description |
|--------------------|---------------|-----------|-----|------|-------------|
| | RE \geq 1G | RE $<$ 1G | PLC | APCM | |
| 1 | √ | √ | √ | √ | - |

Where **RE \geq 1G**: Radiated Emission above 1GHz
RE $<$ 1G: Radiated Emission below 1GHz
PLC: Power Line Conducted Emission
APCM: Antenna Port Conducted Measurement

Radiated Emission Test (Above 1GHz):

- Pre-Scan has been conducted to determine the worst-case mode from all possible combinations between available modulations, data rates and antenna ports (if EUT with antenna diversity architecture).
- Following channel(s) was (were) selected for the final test as listed below.

| Mode | FREQ. Band (MHz) | Available Channel | Tested Channel | Modulation Technology | Modulation Type | Data Rate (Mbps) |
|------------------|------------------|-------------------|----------------|-----------------------|-----------------|------------------|
| 802.11a | 5180-5240 | 36 to 48 | 36, 40, 48 | OFDM | BPSK | 6 |
| 802.11ac (VHT20) | | 36 to 48 | 36, 40, 48 | OFDM | BPSK | 6.5 |
| 802.11ac (VHT40) | | 38 to 46 | 38, 46 | OFDM | BPSK | 13.5 |
| 802.11ac (VHT80) | | 42 | 42 | OFDM | BPSK | 29.3 |
| 802.11a | 5745-5825 | 149 to 165 | 149, 157, 165 | OFDM | BPSK | 6 |
| 802.11ac (VHT20) | | 149 to 165 | 149, 157, 165 | OFDM | BPSK | 6.5 |
| 802.11ac (VHT40) | | 151 to 159 | 151, 159 | OFDM | BPSK | 13.5 |
| 802.11ac (VHT80) | | 155 | 155 | OFDM | BPSK | 29.3 |

Radiated Emission Test (Below 1GHz):

- Pre-Scan has been conducted to determine the worst-case mode from all possible combinations between available modulations, data rates and antenna ports (if EUT with antenna diversity architecture).
- Following channel(s) was (were) selected for the final test as listed below.

| Mode | FREQ. Band (MHz) | Available Channel | Tested Channel | Modulation Technology | Modulation Type | Data Rate (Mbps) |
|------------------|-------------------------|-------------------------|----------------|-----------------------|-----------------|------------------|
| 802.11ac (VHT20) | 5180-5240, 5745-5825 | 36 to 48, 149 to 165 | 40 | OFDM | BPSK | 6.5 |

Power Line Conducted Emission Test:

- Pre-Scan has been conducted to determine the worst-case mode from all possible combinations between available modulations, data rates and antenna ports (if EUT with antenna diversity architecture).
- Following channel(s) was (were) selected for the final test as listed below.

| Mode | FREQ. Band (MHz) | Available Channel | Tested Channel | Modulation Technology | Modulation Type | Data Rate (Mbps) |
|------------------|-------------------------|-------------------------|----------------|-----------------------|-----------------|------------------|
| 802.11ac (VHT20) | 5180-5240, 5745-5825 | 36 to 48, 149 to 165 | 40 | OFDM | BPSK | 6.5 |

Antenna Port Conducted Measurement:

- This item includes all test value of each mode, but only includes spectrum plot of worst value of each mode.
- Pre-Scan has been conducted to determine the worst-case mode from all possible combinations between available modulations, data rates and antenna ports (if EUT with antenna diversity architecture).
- Following channel(s) was (were) selected for the final test as listed below.

| Mode | FREQ. Band (MHz) | Available Channel | Tested Channel | Modulation Technology | Modulation Type | Data Rate (Mbps) |
|------------------|------------------|-------------------|----------------|-----------------------|-----------------|------------------|
| 802.11a | 5180-5240 | 36 to 48 | 36, 40, 48 | OFDM | BPSK | 6 |
| 802.11ac (VHT20) | | 36 to 48 | 36, 40, 48 | OFDM | BPSK | 6.5 |
| 802.11ac (VHT40) | | 38 to 46 | 38, 46 | OFDM | BPSK | 13.5 |
| 802.11ac (VHT80) | | 42 | 42 | OFDM | BPSK | 29.3 |
| 802.11a | 5745-5825 | 149 to 165 | 149, 157, 165 | OFDM | BPSK | 6 |
| 802.11ac (VHT20) | | 149 to 165 | 149, 157, 165 | OFDM | BPSK | 6.5 |
| 802.11ac (VHT40) | | 151 to 159 | 151, 159 | OFDM | BPSK | 13.5 |
| 802.11ac (VHT80) | | 155 | 155 | OFDM | BPSK | 29.3 |

Test Condition:

| Applicable To | Environmental Conditions | Input Power | Tested By |
|---------------|--------------------------|--------------|---------------|
| RE \geq 1G | 24deg. C, 63%RH | 120Vac, 60Hz | Andy Ho |
| | 21deg. C, 66%RH | 120Vac, 60Hz | Andy Ho |
| RE<1G | 23deg. C, 68%RH | 120Vac, 60Hz | Andy Ho |
| PLC | 25deg. C, 75%RH | 120Vac, 60Hz | Andy Ho |
| APCM | 25deg. C, 60%RH | 120Vac, 60Hz | Anderson Chen |

3.3 Duty Cycle of Test Signal

If duty cycle of test signal is $\geq 98\%$, duty factor is not required.

If duty cycle of test signal is $< 98\%$, duty factor shall be considered.

802.11a: Duty cycle = Duty cycle = $2.025 \text{ ms} / 2.102 \text{ ms} = 0.963$, Duty factor = $10 * \log (1/\text{Duty cycle}) = 0.16$

802.11ac (VHT20): Duty cycle = $4.965 \text{ ms} / 5.055 \text{ ms} = 0.982$

802.11ac (VHT40): Duty cycle = $2.415 \text{ ms} / 2.502 \text{ ms} = 0.965$, Duty factor = $10 * \log (1/\text{Duty cycle}) = 0.15$

802.11ac (VHT80): Duty cycle = $1.135 \text{ ms} / 1.215 \text{ ms} = 0.934$, Duty factor = $10 * \log (1/\text{Duty cycle}) = 0.3$

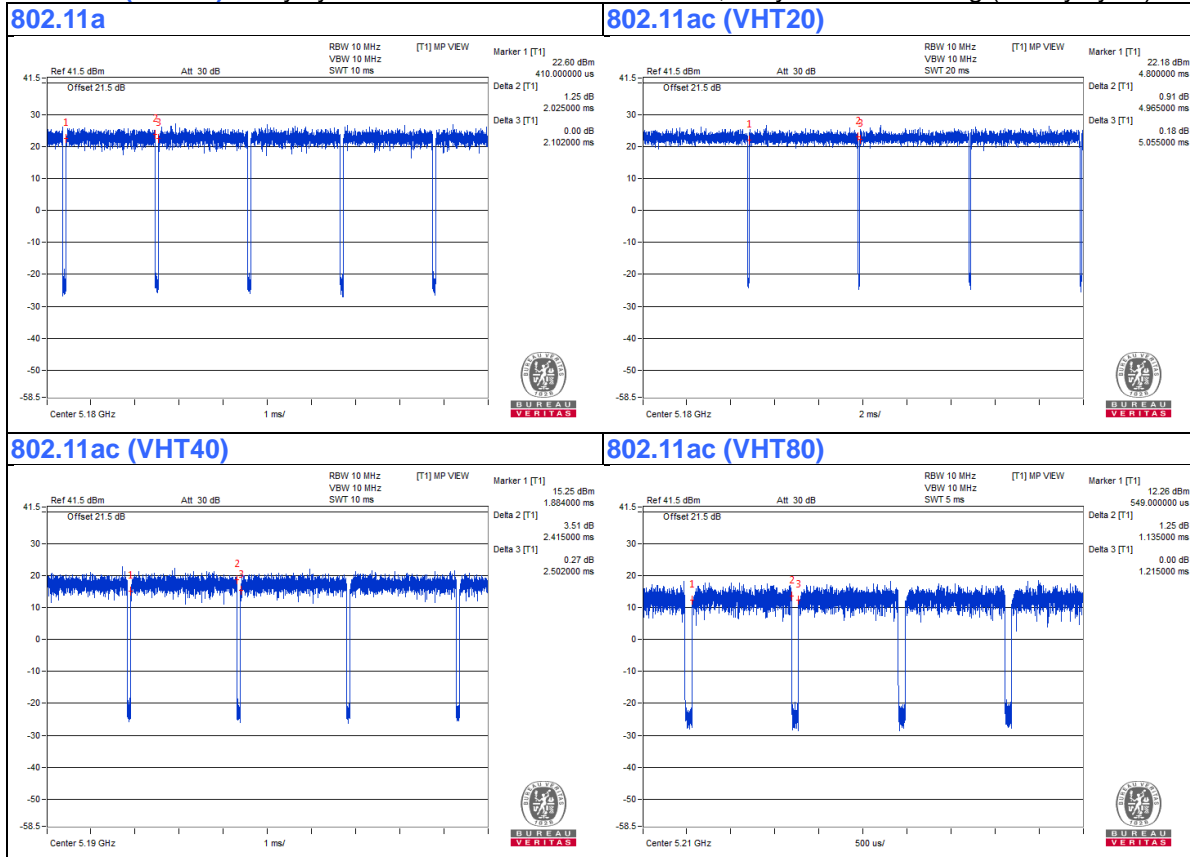

3.4 Description of Support Units

The EUT has been tested as an independent unit together with other necessary accessories or support units. The following support units or accessories were used to form a representative test configuration during the tests.

| ID | Product | Brand | Model No. | Serial No. | FCC ID | Remarks |
|----|--------------|---------|-----------|------------|---------|-----------------|
| A. | MicroSD Card | SanDisk | 8GB | NA | NA | Provided by Lab |
| B. | Laptop | DELL | E6420 | B92T3R1 | FCC DoC | Provided by Lab |

Note:

1. All power cords of the above support units are non-shielded (1.8m).

| ID | Descriptions | Qty. | Length (m) | Shielding (Yes/No) | Cores (Qty.) | Remarks |
|----|--------------|------|------------|--------------------|--------------|--------------------|
| 1. | DC Cable | 1 | 1.8 | No | 0 | Supplied by client |
| 2. | RJ-45 Cable | 1 | 10 | No | 0 | Provided by Lab |

3.4.1 Configuration of System under Test

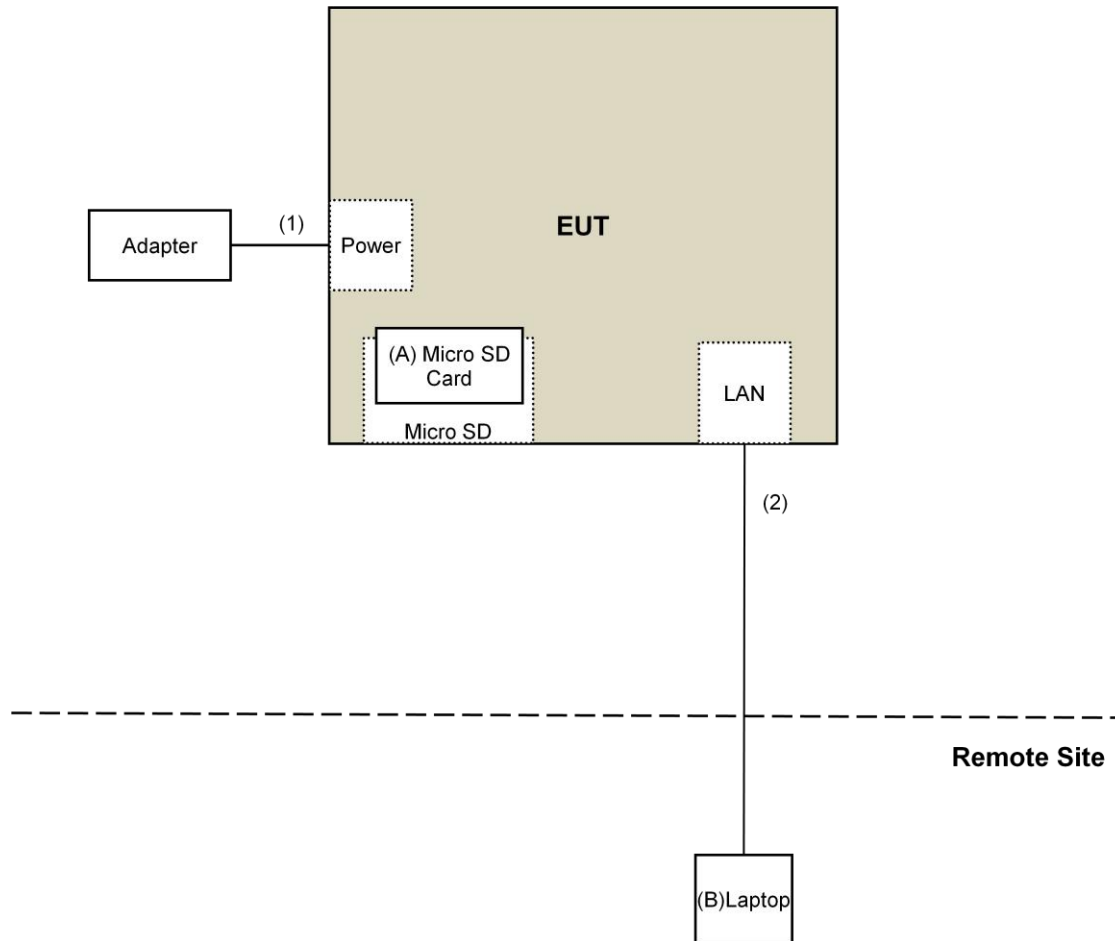

3.5 General Description of Applied Standard

The EUT is a RF Product. According to the specifications of the manufacturer, it must comply with the requirements of the following standards:

FCC Part 15, Subpart E (15.407)

KDB 789033 D02 General UNII Test Procedure New Rules v02r01

KDB 662911 D01 Multiple Transmitter Output v02r01

ANSI C63.10-2013

All test items have been performed and recorded as per the above standards.

4 Test Types and Results

4.1 Radiated Emission and Bandedge Measurement

4.1.1 Limits of Radiated Emission and Bandedge Measurement

Radiated emissions which fall in the restricted bands must comply with the radiated emission limits specified as below table.

| Frequencies (MHz) | Field Strength (microvolts/meter) | Measurement Distance (meters) |
|-------------------|-----------------------------------|-------------------------------|
| 0.009 ~ 0.490 | 2400/F(kHz) | 300 |
| 0.490 ~ 1.705 | 24000/F(kHz) | 30 |
| 1.705 ~ 30.0 | 30 | 30 |
| 30 ~ 88 | 100 | 3 |
| 88 ~ 216 | 150 | 3 |
| 216 ~ 960 | 200 | 3 |
| Above 960 | 500 | 3 |

NOTE:

1. The lower limit shall apply at the transition frequencies.
2. Emission level (dBuV/m) = 20 log Emission level (uV/m).
3. For frequencies above 1000MHz, the field strength limits are based on average detector, however, the peak field strength of any emission shall not exceed the maximum permitted average limits, specified above by more than 20dB under any condition of modulation.

Limits of unwanted emission out of the restricted bands

| Applicable To | | Limit | |
|--|---|---|---|
| 789033 D02 General UNII Test Procedure New Rules v02r01 | | Field Strength at 3m | |
| | | PK:74 (dBuV/m) | AV:54 (dBuV/m) |
| Frequency Band | Applicable To | EIRP Limit | Equivalent Field Strength at 3m |
| 5150~5250 MHz | 15.407(b)(1) | PK:-27 (dBm/MHz) | PK:68.2(dBuV/m) |
| 5250~5350 MHz | 15.407(b)(2) | | |
| 5470~5725 MHz | 15.407(b)(3) | | |
| 5725~5850 MHz | <input checked="" type="checkbox"/> 15.407(b)(4)(i) | PK:-27 (dBm/MHz) ^{*1} PK:10 (dBm/MHz) ^{*2} PK:15.6 (dBm/MHz) ^{*3} PK:27 (dBm/MHz) ^{*4} | PK: 68.2(dBuV/m) ^{*1} PK:105.2 (dBuV/m) ^{*2} PK: 110.8(dBuV/m) ^{*3} PK:122.2 (dBuV/m) ^{*4} |
| | <input type="checkbox"/> 15.407(b)(4)(ii) | Emission limits in section 15.247(d) | |
| ^{*1} beyond 75 MHz or more above of the band edge. | | ^{*2} below the band edge increasing linearly to 10 dBm/MHz at 25 MHz above. | |
| ^{*3} below the band edge increasing linearly to a level of 15.6 dBm/MHz at 5 MHz above. | | ^{*4} from 5 MHz above or below the band edge increasing linearly to a level of 27 dBm/MHz at the band edge. | |

Note:

The following formula is used to convert the equipment isotropic radiated power (eirp) to field strength:

$$E = \frac{1000000\sqrt{30P}}{3} \mu\text{V/m, where P is the eirp (Watts).}$$

4.1.2 Test Instruments

For OOB test:

| DESCRIPTION & MANUFACTURER | MODEL NO. | SERIAL NO. | CALIBRATED DATE | CALIBRATED UNTIL |
|--|----------------------|-------------|-----------------|------------------|
| Test Receiver Agilent | N9038A | MY50010156 | July 12, 2018 | July 11, 2019 |
| Horn_Antenna SCHWARZBECK | BBHA9120-D | 9120D-406 | Dec. 12, 2017 | Dec. 11, 2018 |
| Pre-Amplifier EMCI | EMC12630SE | 980384 | Jan. 29, 2018 | Jan. 28, 2019 |
| RF Cable | EMC104-SM-SM-1200 | 160922 | Jan. 29, 2018 | Jan. 28, 2019 |
| RF Cable | EMC104-SM-SM-2000 | 150317 | Jan. 29, 2018 | Jan. 28, 2019 |
| RF Cable | EMC104-SM-SM-5000 | 150322 | Jan. 29, 2018 | Jan. 28, 2019 |
| Spectrum Analyzer Keysight | N9030A | MY54490679 | July 23, 2018 | July 22, 2019 |
| Pre-Amplifier EMCI | EMC184045SE | 980386 | Jan. 29, 2018 | Jan. 28, 2019 |
| Horn_Antenna SCHWARZBECK | BBHA 9170 | BBHA9170608 | Dec. 14, 2017 | Dec. 13, 2018 |
| RF Cable | EMC102-KM-KM-1200 | 160924 | Jan. 29, 2018 | Jan. 28, 2019 |
| Software | ADT_Radiated_V8.7.08 | NA | NA | NA |
| Antenna Tower & Turn Table Max-Full | MF-7802 | MF780208406 | NA | NA |
| Boresight Antenna Fixture | FBA-01 | FBA-SIP01 | NA | NA |

Note:

1. The calibration interval of the above test instruments is 12 months and the calibrations are traceable to NML/ROC and NIST/USA.
2. The test was performed in 966 Chamber No. 3.
3. The CANADA Site Registration No. is 20331-1
4. Tested Date: Sep. 08, 2018

For other test items:

| DESCRIPTION & MANUFACTURER | MODEL NO. | SERIAL NO. | CALIBRATED DATE | CALIBRATED UNTIL |
|--|----------------------|-------------|-----------------|------------------|
| Test Receiver Agilent | N9038A | MY50010156 | July 12, 2018 | July 11, 2019 |
| Pre-Amplifier EMCI | EMC001340 | 980142 | Feb. 09, 2018 | Feb. 08, 2019 |
| Loop Antenna(*) Electro-Metrics | EM-6879 | 264 | Dec. 16, 2016 | Dec. 15, 2018 |
| RF Cable | NA | LOOPCAB-001 | Jan. 15, 2018 | Jan. 14, 2019 |
| RF Cable | NA | LOOPCAB-002 | Jan. 15, 2018 | Jan. 14, 2019 |
| Pre-Amplifier Mini-Circuits | ZFL-1000VH2B | AMP-ZFL-05 | May 05, 2018 | May 04, 2019 |
| Trilog Broadband Antenna SCHWARZBECK | VULB 9168 | 9168-361 | Nov. 29, 2017 | Nov. 28, 2018 |
| RF Cable | 8D | 966-3-1 | Mar. 20, 2018 | Mar. 19, 2019 |
| RF Cable | 8D | 966-3-2 | Mar. 20, 2018 | Mar. 19, 2019 |
| RF Cable | 8D | 966-3-3 | Mar. 20, 2018 | Mar. 19, 2019 |
| Fixed attenuator Mini-Circuits | UNAT-5+ | PAD-3m-3-01 | Sep. 27, 2018 | Sep. 26, 2019 |
| Horn_Antenna SCHWARZBECK | BBHA9120-D | 9120D-406 | Dec. 12, 2017 | Dec. 11, 2018 |
| Pre-Amplifier EMCI | EMC12630SE | 980384 | Jan. 29, 2018 | Jan. 28, 2019 |
| RF Cable | EMC104-SM-SM-1200 | 160922 | Jan. 29, 2018 | Jan. 28, 2019 |
| RF Cable | EMC104-SM-SM-2000 | 150317 | Jan. 29, 2018 | Jan. 28, 2019 |
| RF Cable | EMC104-SM-SM-5000 | 150322 | Jan. 29, 2018 | Jan. 28, 2019 |
| Spectrum Analyzer Keysight | N9030A | MY54490679 | July 23, 2018 | July 22, 2019 |
| Pre-Amplifier EMCI | EMC184045SE | 980386 | Jan. 29, 2018 | Jan. 28, 2019 |
| Horn_Antenna SCHWARZBECK | BBHA 9170 | BBHA9170608 | Dec. 14, 2017 | Dec. 13, 2018 |
| RF Cable | EMC102-KM-KM-1200 | 160924 | Jan. 29, 2018 | Jan. 28, 2019 |
| Software | ADT_Radiated_V8.7.08 | NA | NA | NA |
| Antenna Tower & Turn Table Max-Full | MF-7802 | MF780208406 | NA | NA |
| Boresight Antenna Fixture | FBA-01 | FBA-SIP01 | NA | NA |
| Spectrum Analyzer R&S | FSV40 | 100964 | June 20, 2018 | June 19, 2019 |
| Power meter Anritsu | ML2495A | 1014008 | May 09, 2018 | May 08, 2019 |
| Power sensor Anritsu | MA2411B | 0917122 | May 09, 2018 | May 08, 2019 |
| AC Power Source Extech Electronics | 6205 | 1440452 | NA | NA |
| Temperature & Humidity Chamber Giant Force | GTH-150-40-SP-AR | MAA0812-008 | Jan. 10, 2018 | Jan. 09, 2019 |
| True RMS Clamp Meter FLUKE | 325 | 31130711WS | May 22, 2018 | May 21, 2019 |

Note:

1. The calibration interval of the above test instruments is 12 months and the calibrations are traceable to NML/ROC and NIST/USA.
2. *The calibration interval of the above test instruments is 24 months and the calibrations are traceable to NML/ROC and NIST/USA.
3. The test was performed in 966 Chamber No. 3.
4. The CANADA Site Registration No. is 20331-1
5. Loop antenna was used for all emissions below 30 MHz.
6. Tested Date: Sep. 27 to Oct. 13, 2018

4.1.3 Test Procedure

For Radiated emission below 30MHz

- a. The EUT was placed on the top of a rotating table 0.8 meters above the ground at a 3 meter chamber room. The table was rotated 360 degrees to determine the position of the highest radiation.
- b. The EUT was set 3 meters away from the interference-receiving antenna, which was mounted on the top of a variable-height antenna tower.
- c. Parallel, perpendicular, and ground-parallel orientations of the antenna are set to make the measurement.
- d. For each suspected emission, the EUT was arranged to its worst case and the rotatable table was turned from 0 degrees to 360 degrees to find the maximum reading.
- e. The test-receiver system was set to Quasi-Peak Detect Function and Specified Bandwidth with Maximum Hold Mode.

Note:

1. The resolution bandwidth and video bandwidth of test receiver/spectrum analyzer is 9kHz at frequency below 30MHz.

For Radiated emission above 30MHz

- a. The EUT was placed on the top of a rotating table 0.8 meters (for 30MHz ~ 1GHz) / 1.5 meters (for above 1GHz) above the ground at 3 meter chamber room for test. The table was rotated 360 degrees to determine the position of the highest radiation.
- b. The EUT was set 3 meters away from the interference-receiving antenna, which was mounted on the top of a variable-height antenna tower.
- c. The height of antenna is varied from one meter to four meters above the ground to determine the maximum value of the field strength. Both horizontal and vertical polarizations of the antenna are set to make the measurement.
- d. For each suspected emission, the EUT was arranged to its worst case and then the antenna was tuned to heights from 1 meter to 4 meters and the rotatable table was turned from 0 degrees to 360 degrees to find the maximum reading.
- e. The test-receiver system was set to quasi-peak detect function and specified bandwidth with maximum hold mode when the test frequency is below 1 GHz.
- f. The test-receiver system was set to peak and average detects function and specified bandwidth with maximum hold mode when the test frequency is above 1 GHz. If the peak reading value also meets average limit, measurement with the average detector is unnecessary.

Note:

1. The resolution bandwidth and video bandwidth of test receiver/spectrum analyzer is 120kHz for Quasi-peak detection (QP) at frequency below 1GHz.
2. The resolution bandwidth of test receiver/spectrum analyzer is 1 MHz and the video bandwidth is 3 MHz for Peak detection (PK) at frequency above 1GHz.
3. The resolution bandwidth of test receiver/spectrum analyzer is 1MHz and the video bandwidth is $\geq 1/T$ (Duty cycle $< 98\%$) or 10Hz (Duty cycle $\geq 98\%$) for Average detection (AV) at frequency above 1GHz.
4. All modes of operation were investigated and the worst-case emissions are reported.

4.1.4 Deviation from Test Standard

No deviation.

4.1.5 Test Setup

For Radiated emission below 30MHz

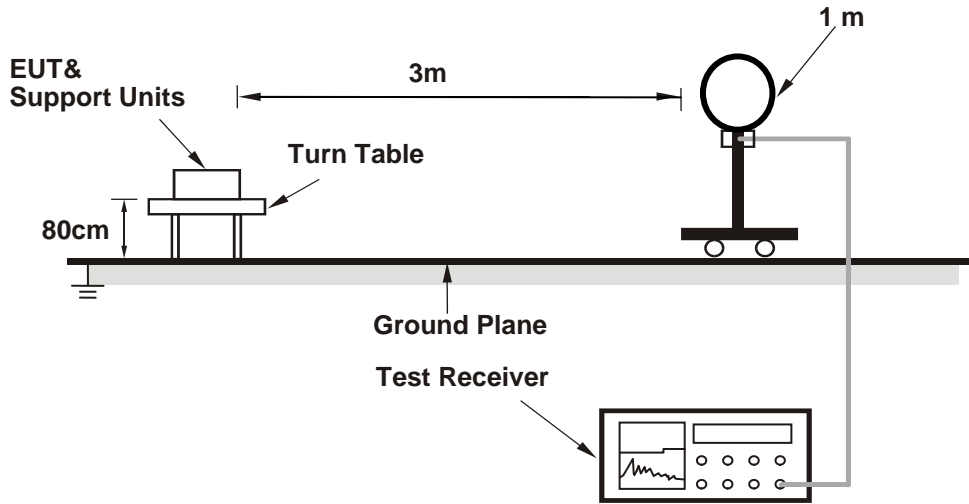

For Radiated emission 30MHz to 1GHz

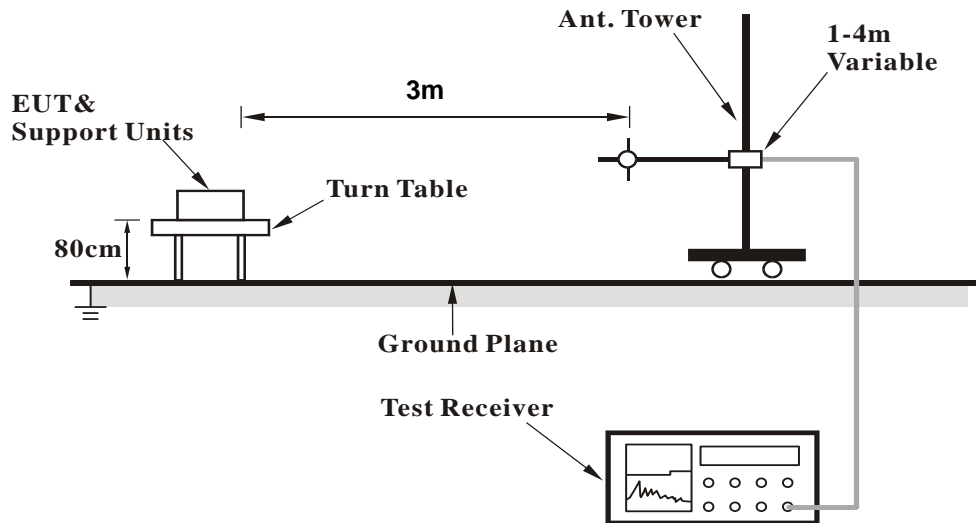

For Radiated emission above 1GHz

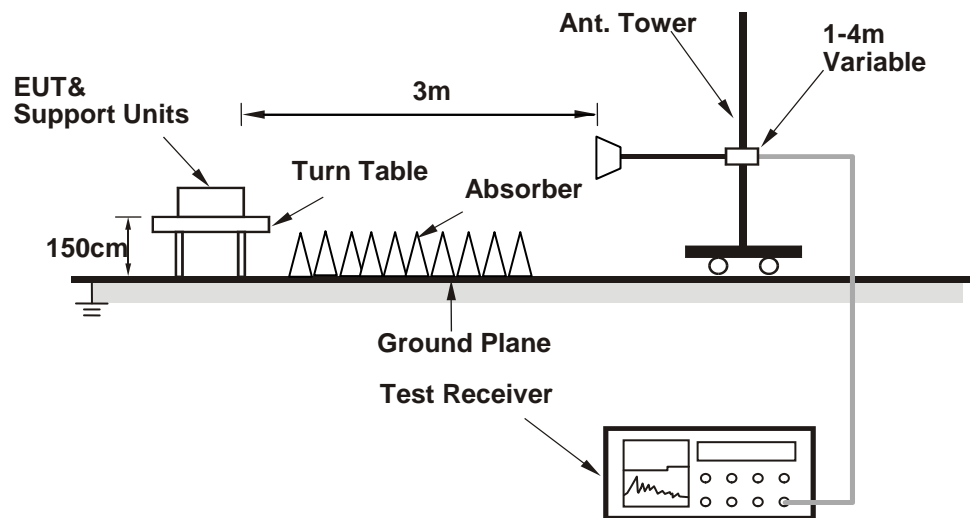

For the actual test configuration, please refer to the attached file (Test Setup Photo).

4.1.6 EUT Operating Condition

- a. Connected the EUT with the Laptop which is placed on remote site.
- b. Controlling software (QDART-Connectivity100040.exe) has been activated to set the EUT on specific status.

4.1.7 Test Results

Above 1GHz Data:

802.11a

| | | | |
|------------------------|---------------|------------------------------|--------------|
| CHANNEL | TX Channel 36 | DETECTOR FUNCTION | Peak (PK) |
| FREQUENCY RANGE | 1GHz ~ 40GHz | | Average (AV) |

| ANTENNA POLARITY & TEST DISTANCE: HORIZONTAL AT 3 M | | | | | | | | |
|---|----------------|-------------------------------|-------------------|----------------|--------------------------|----------------------------|------------------------|--------------------------------|
| NO. | FREQ. (MHz) | EMISSION LEVEL (dBuV/m) | LIMIT (dBuV/m) | MARGIN (dB) | ANTENNA HEIGHT (m) | TABLE ANGLE (Degree) | RAW VALUE (dBuV) | CORRECTION FACTOR (dB/m) |
| 1 | 5148.30 | 70.4 PK | 74.0 | -3.6 | 1.06 H | 312 | 67.8 | 2.6 |
| 2 | 5148.30 | 51.5 AV | 54.0 | -2.5 | 1.06 H | 312 | 48.9 | 2.6 |
| 3 | 5150.00 | 67.9 PK | 74.0 | -6.1 | 1.06 H | 312 | 65.3 | 2.6 |
| 4 | 5150.00 | 52.2 AV | 54.0 | -1.8 | 1.06 H | 312 | 49.6 | 2.6 |
| 5 | *5180.00 | 111.6 PK | | | 1.06 H | 312 | 109.1 | 2.5 |
| 6 | *5180.00 | 100.8 AV | | | 1.06 H | 312 | 98.3 | 2.5 |
| 7 | #10360.00 | 53.9 PK | 68.2 | -14.3 | 1.51 H | 297 | 42.0 | 11.9 |
| 8 | 15540.00 | 53.5 PK | 74.0 | -20.5 | 1.63 H | 304 | 41.1 | 12.4 |
| 9 | 15540.00 | 41.4 AV | 54.0 | -12.6 | 1.63 H | 304 | 29.0 | 12.4 |

| ANTENNA POLARITY & TEST DISTANCE: VERTICAL AT 3 M | | | | | | | | |
|---|----------------|-------------------------------|-------------------|----------------|--------------------------|----------------------------|------------------------|--------------------------------|
| NO. | FREQ. (MHz) | EMISSION LEVEL (dBuV/m) | LIMIT (dBuV/m) | MARGIN (dB) | ANTENNA HEIGHT (m) | TABLE ANGLE (Degree) | RAW VALUE (dBuV) | CORRECTION FACTOR (dB/m) |
| 1 | 5148.30 | 73.1 PK | 74.0 | -0.9 | 2.74 V | 22 | 70.5 | 2.6 |
| 2 | 5148.30 | 53.7 AV | 54.0 | -0.3 | 2.74 V | 22 | 51.1 | 2.6 |
| 3 | 5150.00 | 63.2 PK | 74.0 | -10.8 | 2.74 V | 22 | 60.6 | 2.6 |
| 4 | 5150.00 | 52.0 AV | 54.0 | -2.0 | 2.74 V | 22 | 49.4 | 2.6 |
| 5 | *5180.00 | 117.8 PK | | | 2.74 V | 22 | 115.3 | 2.5 |
| 6 | *5180.00 | 107.8 AV | | | 2.74 V | 22 | 105.3 | 2.5 |
| 7 | #10360.00 | 49.7 PK | 68.2 | -18.5 | 1.99 V | 103 | 37.8 | 11.9 |
| 8 | 15540.00 | 56.0 PK | 74.0 | -18.0 | 1.41 V | 232 | 43.6 | 12.4 |
| 9 | 15540.00 | 42.6 AV | 54.0 | -11.4 | 1.41 V | 232 | 30.2 | 12.4 |

REMARKS:

1. Emission Level(dBuV/m) = Raw Value(dBuV) + Correction Factor(dB/m)
2. Correction Factor(dB/m) = Antenna Factor(dB/m) + Cable Factor(dB) – Pre-Amplifier Factor(dB)
3. The other emission levels were very low against the limit.
4. Margin value = Emission Level – Limit value
5. " * ": Fundamental frequency.
6. " # ": The radiated frequency is out of the restricted band.

| | | | |
|------------------------|---------------|------------------------------|--------------|
| CHANNEL | TX Channel 40 | DETECTOR FUNCTION | Peak (PK) |
| FREQUENCY RANGE | 1GHz ~ 40GHz | | Average (AV) |

ANTENNA POLARITY & TEST DISTANCE: HORIZONTAL AT 3 M

| NO. | FREQ. (MHz) | EMISSION LEVEL (dBuV/m) | LIMIT (dBuV/m) | MARGIN (dB) | ANTENNA HEIGHT (m) | TABLE ANGLE (Degree) | RAW VALUE (dBuV) | CORRECTION FACTOR (dB/m) |
|-----|----------------|-------------------------------|-------------------|----------------|--------------------------|----------------------------|------------------------|--------------------------------|
| 1 | 5150.00 | 64.7 PK | 74.0 | -9.3 | 1.10 H | 308 | 62.1 | 2.6 |
| 2 | 5150.00 | 48.1 AV | 54.0 | -5.9 | 1.10 H | 308 | 45.5 | 2.6 |
| 3 | *5200.00 | 113.9 PK | | | 1.10 H | 308 | 111.5 | 2.4 |
| 4 | *5200.00 | 103.0 AV | | | 1.10 H | 308 | 100.6 | 2.4 |
| 5 | #6933.33 | 60.1 PK | 68.2 | -8.1 | 1.10 H | 308 | 53.5 | 6.6 |
| 6 | #10400.00 | 53.7 PK | 68.2 | -14.5 | 1.56 H | 291 | 41.5 | 12.2 |
| 7 | 15600.00 | 53.9 PK | 74.0 | -20.1 | 1.63 H | 311 | 41.0 | 12.9 |
| 8 | 15600.00 | 41.7 AV | 54.0 | -12.3 | 1.63 H | 311 | 28.8 | 12.9 |

ANTENNA POLARITY & TEST DISTANCE: VERTICAL AT 3 M

| NO. | FREQ. (MHz) | EMISSION LEVEL (dBuV/m) | LIMIT (dBuV/m) | MARGIN (dB) | ANTENNA HEIGHT (m) | TABLE ANGLE (Degree) | RAW VALUE (dBuV) | CORRECTION FACTOR (dB/m) |
|-----|----------------|-------------------------------|-------------------|----------------|--------------------------|----------------------------|------------------------|--------------------------------|
| 1 | 5150.00 | 67.4 PK | 74.0 | -6.6 | 2.65 V | 16 | 64.8 | 2.6 |
| 2 | 5150.00 | 50.3 AV | 54.0 | -3.7 | 2.65 V | 16 | 47.7 | 2.6 |
| 3 | *5200.00 | 120.1 PK | | | 2.65 V | 16 | 117.7 | 2.4 |
| 4 | *5200.00 | 110.0 AV | | | 2.65 V | 16 | 107.6 | 2.4 |
| 5 | #6933.33 | 62.7 PK | 68.2 | -5.5 | 2.51 V | 165 | 56.1 | 6.6 |
| 6 | #10400.00 | 49.9 PK | 68.2 | -18.3 | 2.01 V | 116 | 37.7 | 12.2 |
| 7 | 15600.00 | 55.9 PK | 74.0 | -18.1 | 1.43 V | 234 | 43.0 | 12.9 |
| 8 | 15600.00 | 42.2 AV | 54.0 | -11.8 | 1.43 V | 234 | 29.3 | 12.9 |

REMARKS:

1. Emission Level(dBuV/m) = Raw Value(dBuV) + Correction Factor(dB/m)
2. Correction Factor(dB/m) = Antenna Factor(dB/m) + Cable Factor(dB) – Pre-Amplifier Factor(dB)
3. The other emission levels were very low against the limit.
4. Margin value = Emission Level – Limit value
5. " * ": Fundamental frequency.
6. " # ": The radiated frequency is out of the restricted band.

| | | | |
|------------------------|---------------|------------------------------|--------------|
| CHANNEL | TX Channel 48 | DETECTOR FUNCTION | Peak (PK) |
| FREQUENCY RANGE | 1GHz ~ 40GHz | | Average (AV) |

ANTENNA POLARITY & TEST DISTANCE: HORIZONTAL AT 3 M

| NO. | FREQ. (MHz) | EMISSION LEVEL (dBuV/m) | LIMIT (dBuV/m) | MARGIN (dB) | ANTENNA HEIGHT (m) | TABLE ANGLE (Degree) | RAW VALUE (dBuV) | CORRECTION FACTOR (dB/m) |
|-----|----------------|-------------------------------|-------------------|----------------|--------------------------|----------------------------|------------------------|--------------------------------|
| 1 | *5240.00 | 112.8 PK | | | 1.02 H | 313 | 110.6 | 2.2 |
| 2 | *5240.00 | 101.7 AV | | | 1.02 H | 313 | 99.5 | 2.2 |
| 3 | 5350.00 | 49.1 PK | 74.0 | -24.9 | 1.02 H | 313 | 46.8 | 2.3 |
| 4 | 5350.00 | 38.2 AV | 54.0 | -15.8 | 1.02 H | 313 | 35.9 | 2.3 |
| 5 | #10480.00 | 53.9 PK | 68.2 | -14.3 | 1.54 H | 277 | 41.5 | 12.4 |
| 6 | 15720.00 | 53.9 PK | 74.0 | -20.1 | 1.59 H | 324 | 41.9 | 12.0 |
| 7 | 15720.00 | 41.6 AV | 54.0 | -12.4 | 1.59 H | 324 | 29.6 | 12.0 |

ANTENNA POLARITY & TEST DISTANCE: VERTICAL AT 3 M

| NO. | FREQ. (MHz) | EMISSION LEVEL (dBuV/m) | LIMIT (dBuV/m) | MARGIN (dB) | ANTENNA HEIGHT (m) | TABLE ANGLE (Degree) | RAW VALUE (dBuV) | CORRECTION FACTOR (dB/m) |
|-----|----------------|-------------------------------|-------------------|----------------|--------------------------|----------------------------|------------------------|--------------------------------|
| 1 | *5240.00 | 119.0 PK | | | 2.36 V | 248 | 116.8 | 2.2 |
| 2 | *5240.00 | 108.7 AV | | | 2.36 V | 248 | 106.5 | 2.2 |
| 3 | 5350.00 | 51.8 PK | 74.0 | -22.2 | 2.36 V | 248 | 49.5 | 2.3 |
| 4 | 5350.00 | 40.4 AV | 54.0 | -13.6 | 2.36 V | 248 | 38.1 | 2.3 |
| 5 | #10480.00 | 50.4 PK | 68.2 | -17.8 | 1.96 V | 118 | 38.0 | 12.4 |
| 6 | 15720.00 | 56.0 PK | 74.0 | -18.0 | 1.42 V | 245 | 44.0 | 12.0 |
| 7 | 15720.00 | 42.3 AV | 54.0 | -11.7 | 1.42 V | 245 | 30.3 | 12.0 |

REMARKS:

1. Emission Level(dBuV/m) = Raw Value(dBuV) + Correction Factor(dB/m)
2. Correction Factor(dB/m) = Antenna Factor(dB/m) + Cable Factor(dB) – Pre-Amplifier Factor(dB)
3. The other emission levels were very low against the limit.
4. Margin value = Emission Level – Limit value
5. " * ": Fundamental frequency.
6. " # ": The radiated frequency is out of the restricted band.

| | | | |
|------------------------|----------------|------------------------------|--------------|
| CHANNEL | TX Channel 149 | DETECTOR FUNCTION | Peak (PK) |
| FREQUENCY RANGE | 1GHz ~ 40GHz | | Average (AV) |

ANTENNA POLARITY & TEST DISTANCE: HORIZONTAL AT 3 M

| NO. | FREQ. (MHz) | EMISSION LEVEL (dBuV/m) | LIMIT (dBuV/m) | MARGIN (dB) | ANTENNA HEIGHT (m) | TABLE ANGLE (Degree) | RAW VALUE (dBuV) | CORRECTION FACTOR (dB/m) |
|-----|----------------|-------------------------------|-------------------|----------------|--------------------------|----------------------------|------------------------|--------------------------------|
| 1 | #5585.61 | 56.5 PK | 68.2 | -11.7 | 1.14 H | 28 | 53.7 | 2.8 |
| 2 | *5745.00 | 106.4 PK | | | 1.14 H | 28 | 103.5 | 2.9 |
| 3 | *5745.00 | 96.5 AV | | | 1.14 H | 28 | 93.6 | 2.9 |
| 4 | #5966.06 | 56.1 PK | 68.2 | -12.1 | 1.14 H | 28 | 52.8 | 3.3 |
| 5 | 7660.00 | 53.6 PK | 74.0 | -20.4 | 1.14 H | 28 | 45.8 | 7.8 |
| 6 | 7660.00 | 43.9 AV | 54.0 | -10.1 | 1.14 H | 28 | 36.1 | 7.8 |
| 7 | 11490.00 | 51.1 PK | 74.0 | -22.9 | 1.53 H | 61 | 38.8 | 12.3 |
| 8 | 11490.00 | 38.3 AV | 54.0 | -15.7 | 1.53 H | 61 | 26.0 | 12.3 |
| 9 | #17235.00 | 62.1 PK | 68.2 | -6.1 | 1.60 H | 221 | 46.8 | 15.3 |

ANTENNA POLARITY & TEST DISTANCE: VERTICAL AT 3 M

| NO. | FREQ. (MHz) | EMISSION LEVEL (dBuV/m) | LIMIT (dBuV/m) | MARGIN (dB) | ANTENNA HEIGHT (m) | TABLE ANGLE (Degree) | RAW VALUE (dBuV) | CORRECTION FACTOR (dB/m) |
|-----|----------------|-------------------------------|-------------------|----------------|--------------------------|----------------------------|------------------------|--------------------------------|
| 1 | #5602.65 | 57.9 PK | 68.2 | -10.3 | 2.06 V | 175 | 55.1 | 2.8 |
| 2 | *5745.00 | 119.6 PK | | | 2.06 V | 175 | 116.7 | 2.9 |
| 3 | *5745.00 | 109.7 AV | | | 2.06 V | 175 | 106.8 | 2.9 |
| 4 | #5975.62 | 57.2 PK | 68.2 | -11.0 | 2.06 V | 175 | 54.0 | 3.2 |
| 5 | 7660.00 | 56.3 PK | 74.0 | -17.7 | 2.69 V | 245 | 48.5 | 7.8 |
| 6 | 7660.00 | 46.1 AV | 54.0 | -7.9 | 2.69 V | 245 | 38.3 | 7.8 |
| 7 | 11490.00 | 51.7 PK | 74.0 | -22.3 | 1.63 V | 232 | 39.4 | 12.3 |
| 8 | 11490.00 | 38.6 AV | 54.0 | -15.4 | 1.63 V | 232 | 26.3 | 12.3 |
| 9 | #17235.00 | 64.3 PK | 68.2 | -3.9 | 1.50 V | 232 | 49.0 | 15.3 |

REMARKS:

1. Emission Level(dBuV/m) = Raw Value(dBuV) + Correction Factor(dB/m)
2. Correction Factor(dB/m) = Antenna Factor(dB/m) + Cable Factor(dB) – Pre-Amplifier Factor(dB)
3. The other emission levels were very low against the limit.
4. Margin value = Emission Level – Limit value
5. " * ": Fundamental frequency.
6. " # ": The radiated frequency is out of the restricted band.

| | | | |
|------------------------|----------------|--------------------------|--------------|
| CHANNEL | TX Channel 157 | DETECTOR FUNCTION | Peak (PK) |
| FREQUENCY RANGE | 1GHz ~ 40GHz | | Average (AV) |

ANTENNA POLARITY & TEST DISTANCE: HORIZONTAL AT 3 M

| NO. | FREQ. (MHz) | EMISSION LEVEL (dBuV/m) | LIMIT (dBuV/m) | MARGIN (dB) | ANTENNA HEIGHT (m) | TABLE ANGLE (Degree) | RAW VALUE (dBuV) | CORRECTION FACTOR (dB/m) |
|-----|-------------|-------------------------|----------------|-------------|--------------------|----------------------|------------------|--------------------------|
| 1 | #5622.65 | 56.5 PK | 68.2 | -11.7 | 1.02 H | 28 | 53.7 | 2.8 |
| 2 | *5785.00 | 107.5 PK | | | 1.02 H | 26 | 104.4 | 3.1 |
| 3 | *5785.00 | 96.6 AV | | | 1.02 H | 26 | 93.5 | 3.1 |
| 4 | #5951.84 | 56.6 PK | 68.2 | -11.6 | 1.02 H | 28 | 53.4 | 3.2 |
| 5 | 11570.00 | 53.7 PK | 74.0 | -20.3 | 1.56 H | 302 | 41.3 | 12.4 |
| 6 | 11570.00 | 41.7 AV | 54.0 | -12.3 | 1.56 H | 302 | 29.3 | 12.4 |
| 7 | #17355.00 | 53.7 PK | 68.2 | -14.5 | 1.62 H | 307 | 37.7 | 16.0 |

ANTENNA POLARITY & TEST DISTANCE: VERTICAL AT 3 M

| NO. | FREQ. (MHz) | EMISSION LEVEL (dBuV/m) | LIMIT (dBuV/m) | MARGIN (dB) | ANTENNA HEIGHT (m) | TABLE ANGLE (Degree) | RAW VALUE (dBuV) | CORRECTION FACTOR (dB/m) |
|-----|-------------|-------------------------|----------------|-------------|--------------------|----------------------|------------------|--------------------------|
| 1 | #5613.32 | 57.3 PK | 68.2 | -10.9 | 2.39 V | 177 | 54.5 | 2.8 |
| 2 | *5785.00 | 119.7 PK | | | 2.39 V | 177 | 116.6 | 3.1 |
| 3 | *5785.00 | 110.1 AV | | | 2.39 V | 177 | 107.0 | 3.1 |
| 4 | #6000.15 | 57.4 PK | 68.2 | -10.8 | 2.39 V | 177 | 54.2 | 3.2 |
| 5 | 11570.00 | 49.7 PK | 74.0 | -24.3 | 2.03 V | 103 | 37.3 | 12.4 |
| 6 | 11570.00 | 37.5 AV | 54.0 | -16.5 | 2.03 V | 103 | 25.1 | 12.4 |
| 7 | #17355.00 | 56.2 PK | 68.2 | -12.0 | 1.48 V | 247 | 40.2 | 16.0 |

REMARKS:

1. Emission Level(dBuV/m) = Raw Value(dBuV) + Correction Factor(dB/m)
2. Correction Factor(dB/m) = Antenna Factor(dB/m) + Cable Factor(dB) – Pre-Amplifier Factor(dB)
3. The other emission levels were very low against the limit.
4. Margin value = Emission Level – Limit value
5. " * ": Fundamental frequency.
6. " # ": The radiated frequency is out of the restricted band.

| | | | |
|------------------------|----------------|------------------------------|--------------|
| CHANNEL | TX Channel 165 | DETECTOR FUNCTION | Peak (PK) |
| FREQUENCY RANGE | 1GHz ~ 40GHz | | Average (AV) |

ANTENNA POLARITY & TEST DISTANCE: HORIZONTAL AT 3 M

| NO. | FREQ. (MHz) | EMISSION LEVEL (dBuV/m) | LIMIT (dBuV/m) | MARGIN (dB) | ANTENNA HEIGHT (m) | TABLE ANGLE (Degree) | RAW VALUE (dBuV) | CORRECTION FACTOR (dB/m) |
|-----|----------------|-------------------------------|-------------------|----------------|--------------------------|----------------------------|------------------------|--------------------------------|
| 1 | #5609.61 | 57.8 PK | 68.2 | -10.4 | 1.10 H | 26 | 55.0 | 2.8 |
| 2 | *5825.00 | 107.8 PK | | | 1.10 H | 26 | 104.6 | 3.2 |
| 3 | *5825.00 | 96.7 AV | | | 1.10 H | 26 | 93.5 | 3.2 |
| 4 | #5982.94 | 56.7 PK | 68.2 | -11.5 | 1.10 H | 26 | 53.5 | 3.2 |
| 5 | 11650.00 | 53.5 PK | 74.0 | -20.5 | 1.52 H | 297 | 41.1 | 12.4 |
| 6 | 11650.00 | 41.4 AV | 54.0 | -12.6 | 1.52 H | 297 | 29.0 | 12.4 |
| 7 | #17475.00 | 53.1 PK | 68.2 | -15.1 | 1.59 H | 308 | 35.7 | 17.4 |

ANTENNA POLARITY & TEST DISTANCE: VERTICAL AT 3 M

| NO. | FREQ. (MHz) | EMISSION LEVEL (dBuV/m) | LIMIT (dBuV/m) | MARGIN (dB) | ANTENNA HEIGHT (m) | TABLE ANGLE (Degree) | RAW VALUE (dBuV) | CORRECTION FACTOR (dB/m) |
|-----|----------------|-------------------------------|-------------------|----------------|--------------------------|----------------------------|------------------------|--------------------------------|
| 1 | #5609.79 | 57.4 PK | 68.2 | -10.8 | 2.60 V | 176 | 54.6 | 2.8 |
| 2 | *5825.00 | 120.5 PK | | | 2.60 V | 176 | 117.3 | 3.2 |
| 3 | *5825.00 | 110.5 AV | | | 2.60 V | 176 | 107.3 | 3.2 |
| 4 | #5934.83 | 57.0 PK | 68.2 | -11.2 | 2.60 V | 176 | 53.6 | 3.4 |
| 5 | 11650.00 | 50.0 PK | 74.0 | -24.0 | 2.01 V | 125 | 37.6 | 12.4 |
| 6 | 11650.00 | 37.5 AV | 54.0 | -16.5 | 2.01 V | 125 | 25.1 | 12.4 |
| 7 | #17475.00 | 56.1 PK | 68.2 | -12.1 | 1.39 V | 238 | 38.7 | 17.4 |

REMARKS:

1. Emission Level(dBuV/m) = Raw Value(dBuV) + Correction Factor(dB/m)
2. Correction Factor(dB/m) = Antenna Factor(dB/m) + Cable Factor(dB) – Pre-Amplifier Factor(dB)
3. The other emission levels were very low against the limit.
4. Margin value = Emission Level – Limit value
5. " * ": Fundamental frequency.
6. " # ": The radiated frequency is out of the restricted band.

802.11ac (VHT20)

| | | | |
|------------------------|---------------|------------------------------|--------------|
| CHANNEL | TX Channel 36 | DETECTOR FUNCTION | Peak (PK) |
| FREQUENCY RANGE | 1GHz ~ 40GHz | | Average (AV) |

ANTENNA POLARITY & TEST DISTANCE: HORIZONTAL AT 3 M

| NO. | FREQ. (MHz) | EMISSION LEVEL (dBuV/m) | LIMIT (dBuV/m) | MARGIN (dB) | ANTENNA HEIGHT (m) | TABLE ANGLE (Degree) | RAW VALUE (dBuV) | CORRECTION FACTOR (dB/m) |
|-----|----------------|-------------------------------|-------------------|----------------|--------------------------|----------------------------|------------------------|--------------------------------|
| 1 | 5150.00 | 68.9 PK | 74.0 | -5.1 | 1.03 H | 308 | 66.3 | 2.6 |
| 2 | 5150.00 | 51.7 AV | 54.0 | -2.3 | 1.03 H | 308 | 49.1 | 2.6 |
| 3 | *5180.00 | 110.7 PK | | | 1.03 H | 308 | 108.2 | 2.5 |
| 4 | *5180.00 | 99.6 AV | | | 1.03 H | 308 | 97.1 | 2.5 |
| 5 | #10360.00 | 53.6 PK | 68.2 | -14.6 | 1.47 H | 296 | 41.7 | 11.9 |
| 6 | 15540.00 | 53.7 PK | 74.0 | -20.3 | 1.58 H | 304 | 41.3 | 12.4 |
| 7 | 15540.00 | 41.9 AV | 54.0 | -12.1 | 1.58 H | 304 | 29.5 | 12.4 |

ANTENNA POLARITY & TEST DISTANCE: VERTICAL AT 3 M

| NO. | FREQ. (MHz) | EMISSION LEVEL (dBuV/m) | LIMIT (dBuV/m) | MARGIN (dB) | ANTENNA HEIGHT (m) | TABLE ANGLE (Degree) | RAW VALUE (dBuV) | CORRECTION FACTOR (dB/m) |
|-----|----------------|-------------------------------|-------------------|----------------|--------------------------|----------------------------|------------------------|--------------------------------|
| 1 | 5150.00 | 71.6 PK | 74.0 | -2.4 | 2.12 V | 349 | 69.0 | 2.6 |
| 2 | 5150.00 | 53.9 AV | 54.0 | -0.1 | 2.12 V | 349 | 51.3 | 2.6 |
| 3 | *5180.00 | 116.9 PK | | | 2.12 V | 349 | 114.4 | 2.5 |
| 4 | *5180.00 | 106.6 AV | | | 2.12 V | 349 | 104.1 | 2.5 |
| 5 | #10360.00 | 50.0 PK | 68.2 | -18.2 | 1.94 V | 96 | 38.1 | 11.9 |
| 6 | 15540.00 | 56.5 PK | 74.0 | -17.5 | 1.36 V | 222 | 44.1 | 12.4 |
| 7 | 15540.00 | 42.8 AV | 54.0 | -11.2 | 1.36 V | 222 | 30.4 | 12.4 |

REMARKS:

- Emission Level(dBuV/m) = Raw Value(dBuV) + Correction Factor(dB/m)
- Correction Factor(dB/m) = Antenna Factor(dB/m) + Cable Factor(dB) – Pre-Amplifier Factor(dB)
- The other emission levels were very low against the limit.
- Margin value = Emission Level – Limit value
- " * ": Fundamental frequency.
- " # ": The radiated frequency is out of the restricted band.

| | | | |
|------------------------|---------------|------------------------------|--------------|
| CHANNEL | TX Channel 40 | DETECTOR FUNCTION | Peak (PK) |
| FREQUENCY RANGE | 1GHz ~ 40GHz | | Average (AV) |

ANTENNA POLARITY & TEST DISTANCE: HORIZONTAL AT 3 M

| NO. | FREQ. (MHz) | EMISSION LEVEL (dBuV/m) | LIMIT (dBuV/m) | MARGIN (dB) | ANTENNA HEIGHT (m) | TABLE ANGLE (Degree) | RAW VALUE (dBuV) | CORRECTION FACTOR (dB/m) |
|-----|----------------|-------------------------------|-------------------|----------------|--------------------------|----------------------------|------------------------|--------------------------------|
| 1 | 5150.00 | 66.2 PK | 74.0 | -7.8 | 1.43 H | 305 | 63.6 | 2.6 |
| 2 | 5150.00 | 48.0 AV | 54.0 | -6.0 | 1.43 H | 305 | 45.4 | 2.6 |
| 3 | *5200.00 | 113.0 PK | | | 1.43 H | 305 | 110.6 | 2.4 |
| 4 | *5200.00 | 102.1 AV | | | 1.43 H | 305 | 99.7 | 2.4 |
| 5 | #10400.00 | 53.7 PK | 68.2 | -14.5 | 1.60 H | 282 | 41.5 | 12.2 |
| 6 | 15600.00 | 53.6 PK | 74.0 | -20.4 | 1.66 H | 309 | 40.7 | 12.9 |
| 7 | 15600.00 | 41.4 AV | 54.0 | -12.6 | 1.66 H | 309 | 28.5 | 12.9 |

ANTENNA POLARITY & TEST DISTANCE: VERTICAL AT 3 M

| NO. | FREQ. (MHz) | EMISSION LEVEL (dBuV/m) | LIMIT (dBuV/m) | MARGIN (dB) | ANTENNA HEIGHT (m) | TABLE ANGLE (Degree) | RAW VALUE (dBuV) | CORRECTION FACTOR (dB/m) |
|-----|----------------|-------------------------------|-------------------|----------------|--------------------------|----------------------------|------------------------|--------------------------------|
| 1 | 5150.00 | 68.9 PK | 74.0 | -5.1 | 2.53 V | 201 | 66.3 | 2.6 |
| 2 | 5150.00 | 50.2 AV | 54.0 | -3.8 | 2.53 V | 201 | 47.6 | 2.6 |
| 3 | *5200.00 | 119.2 PK | | | 2.53 V | 201 | 116.8 | 2.4 |
| 4 | *5200.00 | 109.1 AV | | | 2.53 V | 201 | 106.7 | 2.4 |
| 5 | #10400.00 | 49.9 PK | 68.2 | -18.3 | 1.99 V | 115 | 37.7 | 12.2 |
| 6 | 15600.00 | 55.7 PK | 74.0 | -18.3 | 1.44 V | 247 | 42.8 | 12.9 |
| 7 | 15600.00 | 41.8 AV | 54.0 | -12.2 | 1.44 V | 247 | 28.9 | 12.9 |

REMARKS:

1. Emission Level(dBuV/m) = Raw Value(dBuV) + Correction Factor(dB/m)
2. Correction Factor(dB/m) = Antenna Factor(dB/m) + Cable Factor(dB) – Pre-Amplifier Factor(dB)
3. The other emission levels were very low against the limit.
4. Margin value = Emission Level – Limit value
5. " * ": Fundamental frequency.
6. " # ": The radiated frequency is out of the restricted band.

| | | | |
|------------------------|---------------|------------------------------|--------------|
| CHANNEL | TX Channel 48 | DETECTOR FUNCTION | Peak (PK) |
| FREQUENCY RANGE | 1GHz ~ 40GHz | | Average (AV) |

ANTENNA POLARITY & TEST DISTANCE: HORIZONTAL AT 3 M

| NO. | FREQ. (MHz) | EMISSION LEVEL (dBuV/m) | LIMIT (dBuV/m) | MARGIN (dB) | ANTENNA HEIGHT (m) | TABLE ANGLE (Degree) | RAW VALUE (dBuV) | CORRECTION FACTOR (dB/m) |
|-----|----------------|-------------------------------|-------------------|----------------|--------------------------|----------------------------|------------------------|--------------------------------|
| 1 | *5240.00 | 113.9 PK | | | 1.49 H | 320 | 111.7 | 2.2 |
| 2 | *5240.00 | 101.5 AV | | | 1.49 H | 320 | 99.3 | 2.2 |
| 3 | 5350.00 | 47.9 PK | 74.0 | -26.1 | 1.49 H | 320 | 45.6 | 2.3 |
| 4 | 5350.00 | 35.9 AV | 54.0 | -18.1 | 1.49 H | 320 | 33.6 | 2.3 |
| 5 | #10480.00 | 54.2 PK | 68.2 | -14.0 | 1.57 H | 268 | 41.8 | 12.4 |
| 6 | 15720.00 | 53.4 PK | 74.0 | -20.6 | 1.55 H | 316 | 41.4 | 12.0 |
| 7 | 15720.00 | 41.2 AV | 54.0 | -12.8 | 1.55 H | 316 | 29.2 | 12.0 |

ANTENNA POLARITY & TEST DISTANCE: VERTICAL AT 3 M

| NO. | FREQ. (MHz) | EMISSION LEVEL (dBuV/m) | LIMIT (dBuV/m) | MARGIN (dB) | ANTENNA HEIGHT (m) | TABLE ANGLE (Degree) | RAW VALUE (dBuV) | CORRECTION FACTOR (dB/m) |
|-----|----------------|-------------------------------|-------------------|----------------|--------------------------|----------------------------|------------------------|--------------------------------|
| 1 | *5240.00 | 120.1 PK | | | 2.16 V | 351 | 117.9 | 2.2 |
| 2 | *5240.00 | 108.5 AV | | | 2.16 V | 351 | 106.3 | 2.2 |
| 3 | 5350.00 | 50.6 PK | 74.0 | -23.4 | 2.16 V | 351 | 48.3 | 2.3 |
| 4 | 5350.00 | 38.1 AV | 54.0 | -15.9 | 2.16 V | 351 | 35.8 | 2.3 |
| 5 | #10480.00 | 50.7 PK | 68.2 | -17.5 | 1.93 V | 120 | 38.3 | 12.4 |
| 6 | 15720.00 | 55.8 PK | 74.0 | -18.2 | 1.46 V | 252 | 43.8 | 12.0 |
| 7 | 15720.00 | 42.0 AV | 54.0 | -12.0 | 1.46 V | 252 | 30.0 | 12.0 |

REMARKS:

1. Emission Level(dBuV/m) = Raw Value(dBuV) + Correction Factor(dB/m)
2. Correction Factor(dB/m) = Antenna Factor(dB/m) + Cable Factor(dB) – Pre-Amplifier Factor(dB)
3. The other emission levels were very low against the limit.
4. Margin value = Emission Level – Limit value
5. " * ": Fundamental frequency.
6. " # ": The radiated frequency is out of the restricted band.

| | | | |
|------------------------|----------------|------------------------------|--------------|
| CHANNEL | TX Channel 149 | DETECTOR FUNCTION | Peak (PK) |
| FREQUENCY RANGE | 1GHz ~ 40GHz | | Average (AV) |

ANTENNA POLARITY & TEST DISTANCE: HORIZONTAL AT 3 M

| NO. | FREQ. (MHz) | EMISSION LEVEL (dBuV/m) | LIMIT (dBuV/m) | MARGIN (dB) | ANTENNA HEIGHT (m) | TABLE ANGLE (Degree) | RAW VALUE (dBuV) | CORRECTION FACTOR (dB/m) |
|-----|----------------|-------------------------------|-------------------|----------------|--------------------------|----------------------------|------------------------|--------------------------------|
| 1 | #5560.07 | 56.5 PK | 68.2 | -11.7 | 1.42 H | 138 | 53.7 | 2.8 |
| 2 | *5745.00 | 106.6 PK | | | 1.42 H | 138 | 103.7 | 2.9 |
| 3 | *5745.00 | 96.4 AV | | | 1.42 H | 138 | 93.5 | 2.9 |
| 4 | #5989.59 | 56.7 PK | 68.2 | -11.5 | 1.42 H | 138 | 53.5 | 3.2 |
| 5 | 11490.00 | 53.8 PK | 74.0 | -20.2 | 1.57 H | 288 | 41.5 | 12.3 |
| 6 | 11490.00 | 41.8 AV | 54.0 | -12.2 | 1.57 H | 288 | 29.5 | 12.3 |
| 7 | #17235.00 | 53.4 PK | 68.2 | -14.8 | 1.64 H | 314 | 38.1 | 15.3 |

ANTENNA POLARITY & TEST DISTANCE: VERTICAL AT 3 M

| NO. | FREQ. (MHz) | EMISSION LEVEL (dBuV/m) | LIMIT (dBuV/m) | MARGIN (dB) | ANTENNA HEIGHT (m) | TABLE ANGLE (Degree) | RAW VALUE (dBuV) | CORRECTION FACTOR (dB/m) |
|-----|----------------|-------------------------------|-------------------|----------------|--------------------------|----------------------------|------------------------|--------------------------------|
| 1 | #5598.43 | 56.3 PK | 68.2 | -11.9 | 2.69 V | 178 | 53.5 | 2.8 |
| 2 | *5745.00 | 121.4 PK | | | 2.69 V | 178 | 118.5 | 2.9 |
| 3 | *5745.00 | 110.2 AV | | | 2.69 V | 178 | 107.3 | 2.9 |
| 4 | #5957.10 | 56.3 PK | 68.2 | -11.9 | 2.69 V | 178 | 53.1 | 3.2 |
| 5 | 11490.00 | 50.3 PK | 74.0 | -23.7 | 2.01 V | 119 | 38.0 | 12.3 |
| 6 | 11490.00 | 37.5 AV | 54.0 | -16.5 | 2.01 V | 119 | 25.2 | 12.3 |
| 7 | #17235.00 | 55.4 PK | 68.2 | -12.8 | 1.47 V | 237 | 40.1 | 15.3 |

REMARKS:

1. Emission Level(dBuV/m) = Raw Value(dBuV) + Correction Factor(dB/m)
2. Correction Factor(dB/m) = Antenna Factor(dB/m) + Cable Factor(dB) – Pre-Amplifier Factor(dB)
3. The other emission levels were very low against the limit.
4. Margin value = Emission Level – Limit value
5. " * ": Fundamental frequency.
6. " # ": The radiated frequency is out of the restricted band.

| | | | |
|------------------------|----------------|------------------------------|--------------|
| CHANNEL | TX Channel 157 | DETECTOR FUNCTION | Peak (PK) |
| FREQUENCY RANGE | 1GHz ~ 40GHz | | Average (AV) |

ANTENNA POLARITY & TEST DISTANCE: HORIZONTAL AT 3 M

| NO. | FREQ. (MHz) | EMISSION LEVEL (dBuV/m) | LIMIT (dBuV/m) | MARGIN (dB) | ANTENNA HEIGHT (m) | TABLE ANGLE (Degree) | RAW VALUE (dBuV) | CORRECTION FACTOR (dB/m) |
|-----|----------------|-------------------------------|-------------------|----------------|--------------------------|----------------------------|------------------------|--------------------------------|
| 1 | #5644.69 | 56.7 PK | 68.2 | -11.5 | 1.28 H | 146 | 54.0 | 2.7 |
| 2 | *5785.00 | 106.5 PK | | | 1.28 H | 146 | 103.4 | 3.1 |
| 3 | *5785.00 | 96.3 AV | | | 1.28 H | 146 | 93.2 | 3.1 |
| 4 | #5951.76 | 56.1 PK | 68.2 | -12.1 | 1.28 H | 146 | 52.9 | 3.2 |
| 5 | 11570.00 | 53.4 PK | 74.0 | -20.6 | 1.65 H | 283 | 41.0 | 12.4 |
| 6 | 11570.00 | 42.0 AV | 54.0 | -12.0 | 1.65 H | 283 | 29.6 | 12.4 |
| 7 | #17355.00 | 53.8 PK | 68.2 | -14.4 | 1.65 H | 322 | 37.8 | 16.0 |

ANTENNA POLARITY & TEST DISTANCE: VERTICAL AT 3 M

| NO. | FREQ. (MHz) | EMISSION LEVEL (dBuV/m) | LIMIT (dBuV/m) | MARGIN (dB) | ANTENNA HEIGHT (m) | TABLE ANGLE (Degree) | RAW VALUE (dBuV) | CORRECTION FACTOR (dB/m) |
|-----|----------------|-------------------------------|-------------------|----------------|--------------------------|----------------------------|------------------------|--------------------------------|
| 1 | #5579.62 | 57.6 PK | 68.2 | -10.6 | 2.59 V | 181 | 54.8 | 2.8 |
| 2 | *5785.00 | 120.8 PK | | | 2.59 V | 181 | 117.7 | 3.1 |
| 3 | *5785.00 | 110.2 AV | | | 2.59 V | 181 | 107.1 | 3.1 |
| 4 | #5992.94 | 58.7 PK | 68.2 | -9.5 | 2.59 V | 181 | 55.5 | 3.2 |
| 5 | 11570.00 | 50.2 PK | 74.0 | -23.8 | 1.94 V | 131 | 37.8 | 12.4 |
| 6 | 11570.00 | 37.6 AV | 54.0 | -16.4 | 1.94 V | 131 | 25.2 | 12.4 |
| 7 | #17355.00 | 55.7 PK | 68.2 | -12.5 | 1.42 V | 258 | 39.7 | 16.0 |

REMARKS:

1. Emission Level(dBuV/m) = Raw Value(dBuV) + Correction Factor(dB/m)
2. Correction Factor(dB/m) = Antenna Factor(dB/m) + Cable Factor(dB) – Pre-Amplifier Factor(dB)
3. The other emission levels were very low against the limit.
4. Margin value = Emission Level – Limit value
5. " * ": Fundamental frequency.
6. " # ": The radiated frequency is out of the restricted band.

| | | | |
|------------------------|----------------|------------------------------|--------------|
| CHANNEL | TX Channel 165 | DETECTOR FUNCTION | Peak (PK) |
| FREQUENCY RANGE | 1GHz ~ 40GHz | | Average (AV) |

ANTENNA POLARITY & TEST DISTANCE: HORIZONTAL AT 3 M

| NO. | FREQ. (MHz) | EMISSION LEVEL (dBuV/m) | LIMIT (dBuV/m) | MARGIN (dB) | ANTENNA HEIGHT (m) | TABLE ANGLE (Degree) | RAW VALUE (dBuV) | CORRECTION FACTOR (dB/m) |
|-----|----------------|-------------------------------|-------------------|----------------|--------------------------|----------------------------|------------------------|--------------------------------|
| 1 | #5572.42 | 58.5 PK | 68.2 | -9.7 | 1.28 H | 144 | 55.7 | 2.8 |
| 2 | *5825.00 | 107.2 PK | | | 1.29 H | 144 | 104.0 | 3.2 |
| 3 | *5825.00 | 96.7 AV | | | 1.29 H | 144 | 93.5 | 3.2 |
| 4 | #5982.21 | 57.3 PK | 68.2 | -10.9 | 1.28 H | 144 | 54.1 | 3.2 |
| 5 | 11650.00 | 53.2 PK | 74.0 | -20.8 | 1.60 H | 278 | 40.8 | 12.4 |
| 6 | 11650.00 | 41.6 AV | 54.0 | -12.4 | 1.60 H | 278 | 29.2 | 12.4 |
| 7 | #17475.00 | 53.8 PK | 68.2 | -14.4 | 1.68 H | 321 | 36.4 | 17.4 |

ANTENNA POLARITY & TEST DISTANCE: VERTICAL AT 3 M

| NO. | FREQ. (MHz) | EMISSION LEVEL (dBuV/m) | LIMIT (dBuV/m) | MARGIN (dB) | ANTENNA HEIGHT (m) | TABLE ANGLE (Degree) | RAW VALUE (dBuV) | CORRECTION FACTOR (dB/m) |
|-----|----------------|-------------------------------|-------------------|----------------|--------------------------|----------------------------|------------------------|--------------------------------|
| 1 | #5621.93 | 57.3 PK | 68.2 | -10.9 | 2.42 V | 175 | 54.5 | 2.8 |
| 2 | *5825.00 | 121.1 PK | | | 2.42 V | 175 | 117.9 | 3.2 |
| 3 | *5825.00 | 110.4 AV | | | 2.42 V | 175 | 107.2 | 3.2 |
| 4 | #5958.43 | 57.4 PK | 68.2 | -10.8 | 2.42 V | 175 | 54.2 | 3.2 |
| 5 | 11650.00 | 50.2 PK | 74.0 | -23.8 | 2.04 V | 114 | 37.8 | 12.4 |
| 6 | 11650.00 | 37.3 AV | 54.0 | -16.7 | 2.04 V | 114 | 24.9 | 12.4 |
| 7 | #17475.00 | 56.4 PK | 68.2 | -11.8 | 1.41 V | 251 | 39.0 | 17.4 |

REMARKS:

1. Emission Level(dBuV/m) = Raw Value(dBuV) + Correction Factor(dB/m)
2. Correction Factor(dB/m) = Antenna Factor(dB/m) + Cable Factor(dB) – Pre-Amplifier Factor(dB)
3. The other emission levels were very low against the limit.
4. Margin value = Emission Level – Limit value
5. " * ": Fundamental frequency.
6. " # ": The radiated frequency is out of the restricted band.

802.11ac (VHT40)

| | | | |
|------------------------|---------------|------------------------------|--------------|
| CHANNEL | TX Channel 38 | DETECTOR FUNCTION | Peak (PK) |
| FREQUENCY RANGE | 1GHz ~ 40GHz | | Average (AV) |

ANTENNA POLARITY & TEST DISTANCE: HORIZONTAL AT 3 M

| NO. | FREQ. (MHz) | EMISSION LEVEL (dBuV/m) | LIMIT (dBuV/m) | MARGIN (dB) | ANTENNA HEIGHT (m) | TABLE ANGLE (Degree) | RAW VALUE (dBuV) | CORRECTION FACTOR (dB/m) |
|-----|----------------|-------------------------------|-------------------|----------------|--------------------------|----------------------------|------------------------|--------------------------------|
| 1 | 5150.00 | 67.6 PK | 74.0 | -6.4 | 1.41 H | 291 | 65.0 | 2.6 |
| 2 | 5150.00 | 51.6 AV | 54.0 | -2.4 | 1.41 H | 291 | 49.0 | 2.6 |
| 3 | *5190.00 | 106.3 PK | | | 1.41 H | 291 | 103.8 | 2.5 |
| 4 | *5190.00 | 94.2 AV | | | 1.41 H | 291 | 91.7 | 2.5 |
| 5 | 5350.00 | 47.2 PK | 74.0 | -26.8 | 1.41 H | 291 | 44.9 | 2.3 |
| 6 | 5350.00 | 36.0 AV | 54.0 | -18.0 | 1.41 H | 291 | 33.7 | 2.3 |
| 7 | #10380.00 | 53.6 PK | 68.2 | -14.6 | 1.50 H | 288 | 41.6 | 12.0 |
| 8 | 15570.00 | 54.1 PK | 74.0 | -19.9 | 1.53 H | 306 | 41.5 | 12.6 |
| 9 | 15570.00 | 42.3 AV | 54.0 | -11.7 | 1.53 H | 306 | 29.7 | 12.6 |

ANTENNA POLARITY & TEST DISTANCE: VERTICAL AT 3 M

| NO. | FREQ. (MHz) | EMISSION LEVEL (dBuV/m) | LIMIT (dBuV/m) | MARGIN (dB) | ANTENNA HEIGHT (m) | TABLE ANGLE (Degree) | RAW VALUE (dBuV) | CORRECTION FACTOR (dB/m) |
|-----|----------------|-------------------------------|-------------------|----------------|--------------------------|----------------------------|------------------------|--------------------------------|
| 1 | 5150.00 | 70.3 PK | 74.0 | -3.7 | 1.96 V | 265 | 67.7 | 2.6 |
| 2 | 5150.00 | 53.8 AV | 54.0 | -0.2 | 1.96 V | 265 | 51.2 | 2.6 |
| 3 | *5190.00 | 112.5 PK | | | 1.96 V | 265 | 110.0 | 2.5 |
| 4 | *5190.00 | 101.2 AV | | | 1.96 V | 265 | 98.7 | 2.5 |
| 5 | 5350.00 | 49.9 PK | 74.0 | -24.1 | 1.96 V | 265 | 47.6 | 2.3 |
| 6 | 5350.00 | 38.2 AV | 54.0 | -15.8 | 1.96 V | 265 | 35.9 | 2.3 |
| 7 | #10380.00 | 50.3 PK | 68.2 | -17.9 | 1.91 V | 105 | 38.3 | 12.0 |
| 8 | 15570.00 | 55.8 PK | 74.0 | -18.2 | 1.34 V | 235 | 43.2 | 12.6 |
| 9 | 15570.00 | 42.3 AV | 54.0 | -11.7 | 1.34 V | 235 | 29.7 | 12.6 |

REMARKS:

- Emission Level(dBuV/m) = Raw Value(dBuV) + Correction Factor(dB/m)
- Correction Factor(dB/m) = Antenna Factor(dB/m) + Cable Factor(dB) – Pre-Amplifier Factor(dB)
- The other emission levels were very low against the limit.
- Margin value = Emission Level – Limit value
- " * ": Fundamental frequency.
- " # ": The radiated frequency is out of the restricted band.

| | | | |
|------------------------|---------------|------------------------------|--------------|
| CHANNEL | TX Channel 46 | DETECTOR FUNCTION | Peak (PK) |
| FREQUENCY RANGE | 1GHz ~ 40GHz | | Average (AV) |

ANTENNA POLARITY & TEST DISTANCE: HORIZONTAL AT 3 M

| NO. | FREQ. (MHz) | EMISSION LEVEL (dBuV/m) | LIMIT (dBuV/m) | MARGIN (dB) | ANTENNA HEIGHT (m) | TABLE ANGLE (Degree) | RAW VALUE (dBuV) | CORRECTION FACTOR (dB/m) |
|-----|----------------|-------------------------------|-------------------|----------------|--------------------------|----------------------------|------------------------|--------------------------------|
| 1 | 5146.40 | 67.6 PK | 74.0 | -6.4 | 1.37 H | 298 | 65.0 | 2.6 |
| 2 | 5146.40 | 50.9 AV | 54.0 | -3.1 | 1.37 H | 298 | 48.3 | 2.6 |
| 3 | 5150.00 | 59.5 PK | 74.0 | -14.5 | 1.37 H | 298 | 56.9 | 2.6 |
| 4 | 5150.00 | 47.2 AV | 54.0 | -6.8 | 1.37 H | 298 | 44.6 | 2.6 |
| 5 | *5230.00 | 110.2 PK | | | 1.37 H | 298 | 108.0 | 2.2 |
| 6 | *5230.00 | 99.3 AV | | | 1.37 H | 298 | 97.1 | 2.2 |
| 7 | 5350.00 | 55.9 PK | 74.0 | -18.1 | 1.37 H | 298 | 53.6 | 2.3 |
| 8 | 5350.00 | 42.0 AV | 54.0 | -12.0 | 1.37 H | 298 | 39.7 | 2.3 |
| 9 | #6973.33 | 57.9 PK | 68.2 | -10.3 | 1.37 H | 298 | 51.0 | 6.9 |
| 10 | #10460.00 | 54.1 PK | 68.2 | -14.1 | 1.59 H | 281 | 41.7 | 12.4 |
| 11 | 15690.00 | 53.8 PK | 74.0 | -20.2 | 1.57 H | 319 | 41.6 | 12.2 |
| 12 | 15690.00 | 41.4 AV | 54.0 | -12.6 | 1.57 H | 319 | 29.2 | 12.2 |

ANTENNA POLARITY & TEST DISTANCE: VERTICAL AT 3 M

| NO. | FREQ. (MHz) | EMISSION LEVEL (dBuV/m) | LIMIT (dBuV/m) | MARGIN (dB) | ANTENNA HEIGHT (m) | TABLE ANGLE (Degree) | RAW VALUE (dBuV) | CORRECTION FACTOR (dB/m) |
|-----|----------------|-------------------------------|-------------------|----------------|--------------------------|----------------------------|------------------------|--------------------------------|
| 1 | 5146.40 | 70.3 PK | 74.0 | -3.7 | 2.12 V | 347 | 67.7 | 2.6 |
| 2 | 5146.40 | 53.1 AV | 54.0 | -0.9 | 2.12 V | 347 | 50.5 | 2.6 |
| 3 | 5150.00 | 62.2 PK | 74.0 | -11.8 | 2.12 V | 347 | 59.6 | 2.6 |
| 4 | 5150.00 | 49.4 AV | 54.0 | -4.6 | 2.12 V | 347 | 46.8 | 2.6 |
| 5 | *5230.00 | 116.4 PK | | | 2.12 V | 347 | 114.2 | 2.2 |
| 6 | *5230.00 | 106.3 AV | | | 2.12 V | 347 | 104.1 | 2.2 |
| 7 | 5350.00 | 58.6 PK | 74.0 | -15.4 | 2.12 V | 347 | 56.3 | 2.3 |
| 8 | 5350.00 | 44.2 AV | 54.0 | -9.8 | 2.12 V | 347 | 41.9 | 2.3 |
| 9 | #6973.33 | 60.6 PK | 68.2 | -7.6 | 2.63 V | 360 | 53.7 | 6.9 |
| 10 | #10460.00 | 50.8 PK | 68.2 | -17.4 | 1.88 V | 117 | 38.4 | 12.4 |
| 11 | 15690.00 | 56.2 PK | 74.0 | -17.8 | 1.42 V | 264 | 44.0 | 12.2 |
| 12 | 15690.00 | 42.1 AV | 54.0 | -11.9 | 1.42 V | 264 | 29.9 | 12.2 |

REMARKS:

1. Emission Level(dBuV/m) = Raw Value(dBuV) + Correction Factor(dB/m)
2. Correction Factor(dB/m) = Antenna Factor(dB/m) + Cable Factor(dB) – Pre-Amplifier Factor(dB)
3. The other emission levels were very low against the limit.
4. Margin value = Emission Level – Limit value
5. " * ": Fundamental frequency.
6. " # ": The radiated frequency is out of the restricted band.

| | | | |
|------------------------|----------------|------------------------------|--------------|
| CHANNEL | TX Channel 151 | DETECTOR FUNCTION | Peak (PK) |
| FREQUENCY RANGE | 1GHz ~ 40GHz | | Average (AV) |

ANTENNA POLARITY & TEST DISTANCE: HORIZONTAL AT 3 M

| NO. | FREQ. (MHz) | EMISSION LEVEL (dBuV/m) | LIMIT (dBuV/m) | MARGIN (dB) | ANTENNA HEIGHT (m) | TABLE ANGLE (Degree) | RAW VALUE (dBuV) | CORRECTION FACTOR (dB/m) |
|-----|----------------|-------------------------------|-------------------|----------------|--------------------------|----------------------------|------------------------|--------------------------------|
| 1 | #5614.66 | 56.6 PK | 68.2 | -11.6 | 1.50 H | 144 | 53.8 | 2.8 |
| 2 | *5755.00 | 105.6 PK | | | 1.50 H | 144 | 102.6 | 3.0 |
| 3 | *5755.00 | 94.6 AV | | | 1.50 H | 144 | 91.6 | 3.0 |
| 4 | #5971.98 | 56.6 PK | 68.2 | -11.6 | 1.50 H | 144 | 53.4 | 3.2 |
| 5 | 11510.00 | 52.9 PK | 74.0 | -21.1 | 1.60 H | 262 | 40.6 | 12.3 |
| 6 | 11510.00 | 41.3 AV | 54.0 | -12.7 | 1.60 H | 262 | 29.0 | 12.3 |
| 7 | #17265.00 | 54.4 PK | 68.2 | -13.8 | 1.71 H | 307 | 39.0 | 15.4 |

ANTENNA POLARITY & TEST DISTANCE: VERTICAL AT 3 M

| NO. | FREQ. (MHz) | EMISSION LEVEL (dBuV/m) | LIMIT (dBuV/m) | MARGIN (dB) | ANTENNA HEIGHT (m) | TABLE ANGLE (Degree) | RAW VALUE (dBuV) | CORRECTION FACTOR (dB/m) |
|-----|----------------|-------------------------------|-------------------|----------------|--------------------------|----------------------------|------------------------|--------------------------------|
| 1 | #5592.77 | 58.3 PK | 68.2 | -9.9 | 2.58 V | 171 | 55.5 | 2.8 |
| 2 | *5755.00 | 117.8 PK | | | 2.58 V | 171 | 114.8 | 3.0 |
| 3 | *5755.00 | 107.0 AV | | | 2.58 V | 171 | 104.0 | 3.0 |
| 4 | #5943.05 | 58.3 PK | 68.2 | -9.9 | 2.58 V | 171 | 55.0 | 3.3 |
| 5 | 11510.00 | 49.9 PK | 74.0 | -24.1 | 2.01 V | 125 | 37.6 | 12.3 |
| 6 | 11510.00 | 37.2 AV | 54.0 | -16.8 | 2.01 V | 125 | 24.9 | 12.3 |
| 7 | #17265.00 | 56.0 PK | 68.2 | -12.2 | 1.39 V | 253 | 40.6 | 15.4 |

REMARKS:

1. Emission Level(dBuV/m) = Raw Value(dBuV) + Correction Factor(dB/m)
2. Correction Factor(dB/m) = Antenna Factor(dB/m) + Cable Factor(dB) – Pre-Amplifier Factor(dB)
3. The other emission levels were very low against the limit.
4. Margin value = Emission Level – Limit value
5. " * ": Fundamental frequency.
6. " # ": The radiated frequency is out of the restricted band.

| | | | |
|------------------------|----------------|------------------------------|--------------|
| CHANNEL | TX Channel 159 | DETECTOR FUNCTION | Peak (PK) |
| FREQUENCY RANGE | 1GHz ~ 40GHz | | Average (AV) |

ANTENNA POLARITY & TEST DISTANCE: HORIZONTAL AT 3 M

| NO. | FREQ. (MHz) | EMISSION LEVEL (dBuV/m) | LIMIT (dBuV/m) | MARGIN (dB) | ANTENNA HEIGHT (m) | TABLE ANGLE (Degree) | RAW VALUE (dBuV) | CORRECTION FACTOR (dB/m) |
|-----|----------------|-------------------------------|-------------------|----------------|--------------------------|----------------------------|------------------------|--------------------------------|
| 1 | #5564.30 | 57.1 PK | 68.2 | -11.1 | 1.30 H | 138 | 54.3 | 2.8 |
| 2 | *5795.00 | 103.5 PK | | | 1.30 H | 138 | 100.5 | 3.0 |
| 3 | *5795.00 | 94.2 AV | | | 1.30 H | 138 | 91.2 | 3.0 |
| 4 | #5982.12 | 56.5 PK | 68.2 | -11.7 | 1.30 H | 138 | 53.3 | 3.2 |
| 5 | 11590.00 | 53.6 PK | 74.0 | -20.4 | 1.65 H | 268 | 41.2 | 12.4 |
| 6 | 11590.00 | 41.8 AV | 54.0 | -12.2 | 1.65 H | 268 | 29.4 | 12.4 |
| 7 | #17385.00 | 54.0 PK | 68.2 | -14.2 | 1.65 H | 303 | 37.8 | 16.2 |

ANTENNA POLARITY & TEST DISTANCE: VERTICAL AT 3 M

| NO. | FREQ. (MHz) | EMISSION LEVEL (dBuV/m) | LIMIT (dBuV/m) | MARGIN (dB) | ANTENNA HEIGHT (m) | TABLE ANGLE (Degree) | RAW VALUE (dBuV) | CORRECTION FACTOR (dB/m) |
|-----|----------------|-------------------------------|-------------------|----------------|--------------------------|----------------------------|------------------------|--------------------------------|
| 1 | #5617.55 | 57.2 PK | 68.2 | -11.0 | 1.90 V | 2 | 54.4 | 2.8 |
| 2 | *5795.00 | 117.3 PK | | | 1.90 V | 2 | 114.3 | 3.0 |
| 3 | *5795.00 | 106.8 AV | | | 1.90 V | 2 | 103.8 | 3.0 |
| 4 | #5968.61 | 57.6 PK | 68.2 | -10.6 | 1.90 V | 2 | 54.4 | 3.2 |
| 5 | 11590.00 | 49.7 PK | 74.0 | -24.3 | 1.95 V | 104 | 37.3 | 12.4 |
| 6 | 11590.00 | 37.2 AV | 54.0 | -16.8 | 1.95 V | 104 | 24.8 | 12.4 |
| 7 | #17385.00 | 56.1 PK | 68.2 | -12.1 | 1.43 V | 259 | 39.9 | 16.2 |

REMARKS:

1. Emission Level(dBuV/m) = Raw Value(dBuV) + Correction Factor(dB/m)
2. Correction Factor(dB/m) = Antenna Factor(dB/m) + Cable Factor(dB) – Pre-Amplifier Factor(dB)
3. The other emission levels were very low against the limit.
4. Margin value = Emission Level – Limit value
5. " * ": Fundamental frequency.
6. " # ": The radiated frequency is out of the restricted band.

802.11ac (VHT80)

| | | | |
|------------------------|---------------|------------------------------|--------------|
| CHANNEL | TX Channel 42 | DETECTOR FUNCTION | Peak (PK) |
| FREQUENCY RANGE | 1GHz ~ 40GHz | | Average (AV) |

ANTENNA POLARITY & TEST DISTANCE: HORIZONTAL AT 3 M

| NO. | FREQ. (MHz) | EMISSION LEVEL (dBuV/m) | LIMIT (dBuV/m) | MARGIN (dB) | ANTENNA HEIGHT (m) | TABLE ANGLE (Degree) | RAW VALUE (dBuV) | CORRECTION FACTOR (dB/m) |
|-----|----------------|-------------------------------|-------------------|----------------|--------------------------|----------------------------|------------------------|--------------------------------|
| 1 | 5136.00 | 64.7 PK | 74.0 | -9.3 | 1.50 H | 139 | 62.1 | 2.6 |
| 2 | 5136.00 | 51.7 AV | 54.0 | -2.3 | 1.50 H | 139 | 49.1 | 2.6 |
| 3 | 5150.00 | 64.1 PK | 74.0 | -9.9 | 1.50 H | 139 | 61.5 | 2.6 |
| 4 | 5150.00 | 50.9 AV | 54.0 | -3.1 | 1.50 H | 139 | 48.3 | 2.6 |
| 5 | *5210.00 | 102.9 PK | | | 1.50 H | 139 | 100.5 | 2.4 |
| 6 | *5210.00 | 91.2 AV | | | 1.50 H | 139 | 88.8 | 2.4 |
| 7 | 5350.00 | 52.7 PK | 74.0 | -21.3 | 1.50 H | 139 | 50.4 | 2.3 |
| 8 | 5350.00 | 41.1 AV | 54.0 | -12.9 | 1.50 H | 139 | 38.8 | 2.3 |
| 9 | #10420.00 | 54.2 PK | 68.2 | -14.0 | 1.43 H | 301 | 42.0 | 12.2 |
| 10 | 15630.00 | 53.8 PK | 74.0 | -20.2 | 1.58 H | 310 | 41.1 | 12.7 |
| 11 | 15630.00 | 41.7 AV | 54.0 | -12.3 | 1.58 H | 310 | 29.0 | 12.7 |

ANTENNA POLARITY & TEST DISTANCE: VERTICAL AT 3 M

| NO. | FREQ. (MHz) | EMISSION LEVEL (dBuV/m) | LIMIT (dBuV/m) | MARGIN (dB) | ANTENNA HEIGHT (m) | TABLE ANGLE (Degree) | RAW VALUE (dBuV) | CORRECTION FACTOR (dB/m) |
|-----|----------------|-------------------------------|-------------------|----------------|--------------------------|----------------------------|------------------------|--------------------------------|
| 1 | 5136.00 | 67.4 PK | 74.0 | -6.6 | 2.63 V | 200 | 64.8 | 2.6 |
| 2 | 5136.00 | 53.9 AV | 54.0 | -0.1 | 2.63 V | 200 | 51.3 | 2.6 |
| 3 | 5150.00 | 66.8 PK | 74.0 | -7.2 | 2.63 V | 200 | 64.2 | 2.6 |
| 4 | 5150.00 | 53.1 AV | 54.0 | -0.9 | 2.63 V | 200 | 50.5 | 2.6 |
| 5 | *5210.00 | 109.1 PK | | | 2.63 V | 200 | 106.7 | 2.4 |
| 6 | *5210.00 | 98.2 AV | | | 2.63 V | 200 | 95.8 | 2.4 |
| 7 | 5350.00 | 55.4 PK | 74.0 | -18.6 | 2.63 V | 200 | 53.1 | 2.3 |
| 8 | 5350.00 | 43.3 AV | 54.0 | -10.7 | 2.63 V | 200 | 41.0 | 2.3 |
| 9 | #10420.00 | 49.6 PK | 68.2 | -18.6 | 1.90 V | 88 | 37.4 | 12.2 |
| 10 | 15630.00 | 56.4 PK | 74.0 | -17.6 | 1.31 V | 206 | 43.7 | 12.7 |
| 11 | 15630.00 | 42.6 AV | 54.0 | -11.4 | 1.31 V | 206 | 29.9 | 12.7 |

REMARKS:

- Emission Level(dBuV/m) = Raw Value(dBuV) + Correction Factor(dB/m)
- Correction Factor(dB/m) = Antenna Factor(dB/m) + Cable Factor(dB) – Pre-Amplifier Factor(dB)
- The other emission levels were very low against the limit.
- Margin value = Emission Level – Limit value
- " * ": Fundamental frequency.
- " # ": The radiated frequency is out of the restricted band.

| | | | |
|------------------------|----------------|------------------------------|--------------|
| CHANNEL | TX Channel 155 | DETECTOR FUNCTION | Peak (PK) |
| FREQUENCY RANGE | 1GHz ~ 40GHz | | Average (AV) |

ANTENNA POLARITY & TEST DISTANCE: HORIZONTAL AT 3 M

| NO. | FREQ. (MHz) | EMISSION LEVEL (dBuV/m) | LIMIT (dBuV/m) | MARGIN (dB) | ANTENNA HEIGHT (m) | TABLE ANGLE (Degree) | RAW VALUE (dBuV) | CORRECTION FACTOR (dB/m) |
|-----|----------------|-------------------------------|-------------------|----------------|--------------------------|----------------------------|------------------------|--------------------------------|
| 1 | #5641.19 | 58.1 PK | 68.2 | -10.1 | 1.50 H | 135 | 55.4 | 2.7 |
| 2 | *5775.00 | 99.5 PK | | | 1.50 H | 135 | 96.5 | 3.0 |
| 3 | *5775.00 | 88.6 AV | | | 1.50 H | 135 | 85.6 | 3.0 |
| 4 | #5942.18 | 57.7 PK | 68.2 | -10.5 | 1.50 H | 135 | 54.4 | 3.3 |
| 5 | 11550.00 | 53.2 PK | 74.0 | -20.8 | 1.63 H | 293 | 40.8 | 12.4 |
| 6 | 11550.00 | 41.7 AV | 54.0 | -12.3 | 1.63 H | 293 | 29.3 | 12.4 |
| 7 | #17325.00 | 53.8 PK | 68.2 | -14.4 | 1.70 H | 307 | 38.1 | 15.7 |

ANTENNA POLARITY & TEST DISTANCE: VERTICAL AT 3 M

| NO. | FREQ. (MHz) | EMISSION LEVEL (dBuV/m) | LIMIT (dBuV/m) | MARGIN (dB) | ANTENNA HEIGHT (m) | TABLE ANGLE (Degree) | RAW VALUE (dBuV) | CORRECTION FACTOR (dB/m) |
|-----|----------------|-------------------------------|-------------------|----------------|--------------------------|----------------------------|------------------------|--------------------------------|
| 1 | #5617.08 | 66.3 PK | 68.2 | -1.9 | 2.37 V | 178 | 63.5 | 2.8 |
| 2 | #5641.02 | 67.8 PK | 68.2 | -0.4 | 2.37 V | 178 | 65.1 | 2.7 |
| 3 | *5775.00 | 113.4 PK | | | 2.37 V | 178 | 110.4 | 3.0 |
| 4 | *5775.00 | 102.3 AV | | | 2.37 V | 178 | 99.3 | 3.0 |
| 5 | #5959.13 | 63.2 PK | 68.2 | -5.0 | 2.37 V | 178 | 60.0 | 3.2 |
| 6 | 11550.00 | 49.8 PK | 74.0 | -24.2 | 1.96 V | 114 | 37.4 | 12.4 |
| 7 | 11550.00 | 37.2 AV | 54.0 | -16.8 | 1.96 V | 114 | 24.8 | 12.4 |
| 8 | #17325.00 | 56.1 PK | 68.2 | -12.1 | 1.47 V | 259 | 40.4 | 15.7 |

REMARKS:

- Emission Level(dBuV/m) = Raw Value(dBuV) + Correction Factor(dB/m)
- Correction Factor(dB/m) = Antenna Factor(dB/m) + Cable Factor(dB) – Pre-Amplifier Factor(dB)
- The other emission levels were very low against the limit.
- Margin value = Emission Level – Limit value
- " * ": Fundamental frequency.
- " # ": The radiated frequency is out of the restricted band.

Below 1GHz Data:
802.11ac (VHT20)

| | | | |
|------------------------|---------------|--------------------------|-----------------|
| CHANNEL | TX Channel 40 | DETECTOR FUNCTION | Quasi-Peak (QP) |
| FREQUENCY RANGE | 9kHz ~ 1GHz | | |

ANTENNA POLARITY & TEST DISTANCE: HORIZONTAL AT 3 M

| NO. | FREQ. (MHz) | EMISSION LEVEL (dBuV/m) | LIMIT (dBuV/m) | MARGIN (dB) | ANTENNA HEIGHT (m) | TABLE ANGLE (Degree) | RAW VALUE (dBuV) | CORRECTION FACTOR (dB/m) |
|-----|-------------|-------------------------|----------------|-------------|--------------------|----------------------|------------------|--------------------------|
| 1 | 64.53 | 29.3 QP | 40.0 | -10.7 | 2.50 H | 113 | 38.5 | -9.2 |
| 2 | 125.01 | 35.4 QP | 43.5 | -8.1 | 2.50 H | 302 | 44.7 | -9.3 |
| 3 | 217.89 | 33.2 QP | 46.0 | -12.8 | 1.50 H | 112 | 44.0 | -10.8 |
| 4 | 250.00 | 36.2 QP | 46.0 | -9.8 | 1.00 H | 301 | 45.1 | -8.9 |
| 5 | 347.84 | 28.6 QP | 46.0 | -17.4 | 1.50 H | 314 | 34.3 | -5.7 |
| 6 | 574.78 | 33.1 QP | 46.0 | -12.9 | 1.50 H | 331 | 33.6 | -0.5 |

REMARKS:

1. Emission Level(dBuV/m) = Raw Value(dBuV) + Correction Factor(dB/m)
2. Correction Factor(dB/m) = Antenna Factor(dB/m) + Cable Factor(dB) – Pre-Amplifier Factor(dB)
3. Margin value = Emission Level – Limit value
4. The emission levels were very low against the limit of frequency range 9kHz~30MHz: the amplitude of spurious emissions attenuated more than 20 dB below the permissible value to be report.

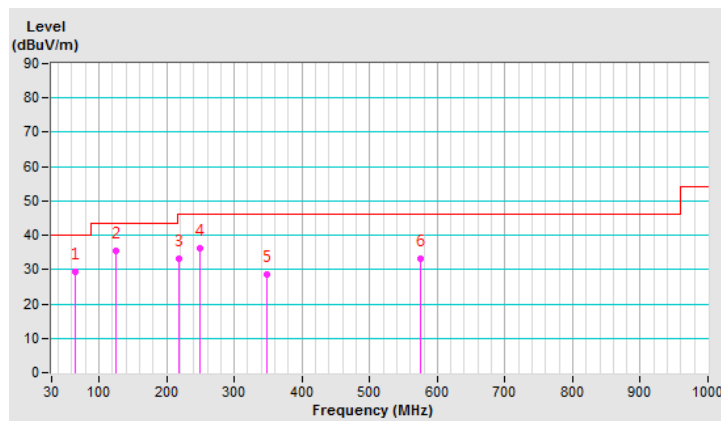

| | | | |
|------------------------|---------------|--------------------------|-----------------|
| CHANNEL | TX Channel 40 | DETECTOR FUNCTION | Quasi-Peak (QP) |
| FREQUENCY RANGE | 9kHz ~ 1GHz | | |

ANTENNA POLARITY & TEST DISTANCE: VERTICAL AT 3 M

| NO. | FREQ. (MHz) | EMISSION LEVEL (dBuV/m) | LIMIT (dBuV/m) | MARGIN (dB) | ANTENNA HEIGHT (m) | TABLE ANGLE (Degree) | RAW VALUE (dBuV) | CORRECTION FACTOR (dB/m) |
|-----|-------------|-------------------------|----------------|-------------|--------------------|----------------------|------------------|--------------------------|
| 1 | 41.70 | 34.2 QP | 40.0 | -5.8 | 1.00 V | 203 | 42.3 | -8.1 |
| 2 | 65.57 | 34.4 QP | 40.0 | -5.6 | 1.00 V | 241 | 43.8 | -9.4 |
| 3 | 124.99 | 37.9 QP | 43.5 | -5.6 | 1.00 V | 223 | 47.2 | -9.3 |
| 4 | 250.00 | 34.2 QP | 46.0 | -11.8 | 1.00 V | 206 | 43.1 | -8.9 |
| 5 | 302.30 | 28.6 QP | 46.0 | -17.4 | 1.00 V | 94 | 35.4 | -6.8 |
| 6 | 644.33 | 33.2 QP | 46.0 | -12.8 | 1.50 V | 296 | 32.0 | 1.2 |

REMARKS:

1. Emission Level(dBuV/m) = Raw Value(dBuV) + Correction Factor(dB/m)
2. Correction Factor(dB/m) = Antenna Factor(dB/m) + Cable Factor(dB) – Pre-Amplifier Factor(dB)
3. Margin value = Emission Level – Limit value
4. The emission levels were very low against the limit of frequency range 9kHz~30MHz: the amplitude of spurious emissions attenuated more than 20 dB below the permissible value to be report.

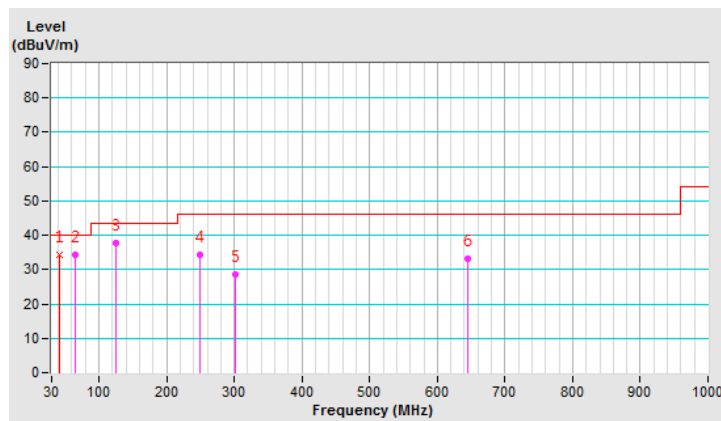

4.2 Conducted Emission Measurement

4.2.1 Limits of Conducted Emission Measurement

| Frequency (MHz) | Conducted Limit (dBuV) | |
|-----------------|------------------------|---------|
| | Quasi-peak | Average |
| 0.15 - 0.5 | 66 - 56 | 56 - 46 |
| 0.50 - 5.0 | 56 | 46 |
| 5.0 - 30.0 | 60 | 50 |

Note: 1. The lower limit shall apply at the transition frequencies.

2. The limit decreases in line with the logarithm of the frequency in the range of 0.15 to 0.50MHz.

4.2.2 Test Instruments

| DESCRIPTION & MANUFACTURER | MODEL NO. | SERIAL NO. | CALIBRATED DATE | CALIBRATED UNTIL |
|--|-------------------------|------------|-----------------|------------------|
| Test Receiver R&S | ESCS 30 | 847124/029 | Nov. 01, 2017 | Oct. 31, 2018 |
| Line-Impedance Stabilization Network (for EUT) R&S | ESH3-Z5 | 848773/004 | Nov. 15, 2017 | Nov. 14, 2018 |
| Line-Impedance Stabilization Network (for Peripheral) R&S | ENV216 | 100072 | June 04, 2018 | June 03, 2019 |
| 50 ohms Terminator | N/A | EMC-04 | Nov. 01, 2017 | Oct. 31, 2018 |
| RF Cable | 5D-FB | COCCAB-001 | Sep. 28, 2018 | Sep. 27, 2019 |
| Fixed attenuator EMCI | STI02-2200-10 | 003 | Mar. 16, 2018 | Mar. 15, 2019 |
| Software BVADT | BVADT_Cond_ V7.3.7.4 | NA | NA | NA |

Note:

1. The calibration interval of the above test instruments are 12 months and the calibrations are traceable to NML/ROC and NIST/USA.
2. The test was performed in Conduction 1.
- 3 Tested Date: Oct. 10, 2018

4.2.3 Test Procedure

- The EUT was placed 0.4 meters from the conducting wall of the shielded room with EUT being connected to the power mains through a line impedance stabilization network (LISN). Other support units were connected to the power mains through another LISN. The two LISNs provide 50 ohm/ 50uH of coupling impedance for the measuring instrument.
- Both lines of the power mains connected to the EUT were checked for maximum conducted interference.
- The frequency range from 150kHz to 30MHz was searched. Emission levels under (Limit - 20dB) was not recorded.

Note: All modes of operation were investigated and the worst-case emissions are reported.

4.2.4 Deviation from Test Standard

No deviation.

4.2.5 Test Setup

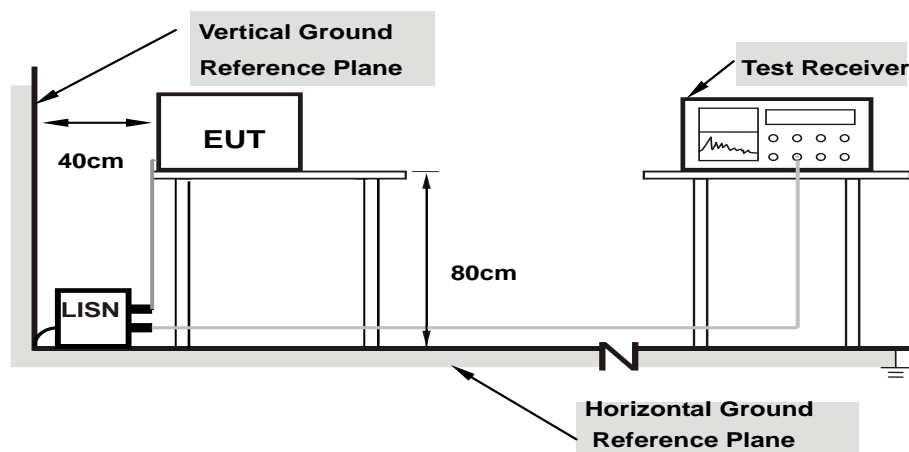

Note: 1.Support units were connected to second LISN.

For the actual test configuration, please refer to the attached file (Test Setup Photo).

4.2.6 EUT Operating Condition

Same as 4.1.6.

4.2.7 Test Results

| Phase | Line (L) | Detector Function | Quasi-Peak (QP) / Average (AV) |
|-------|----------|-------------------|--------------------------------|
|-------|----------|-------------------|--------------------------------|

| No | Freq. [MHz] | Corr. | Reading Value | | Emission Level | | Limit | | Margin | |
|----------|----------------|----------------|---------------|--------------|----------------|--------------|--------------|--------------|---------------|---------------|
| | | Factor (dB) | [dB (uV)] | | [dB (uV)] | | [dB (uV)] | | (dB) | |
| | | | Q.P. | AV. | Q.P. | AV. | Q.P. | AV. | Q.P. | AV. |
| 1 | 0.15000 | 10.05 | 42.76 | 26.18 | 52.81 | 36.23 | 66.00 | 56.00 | -13.19 | -19.77 |
| 2 | 0.18125 | 10.06 | 37.74 | 23.79 | 47.80 | 33.85 | 64.43 | 54.43 | -16.63 | -20.58 |
| 3 | 0.47422 | 10.13 | 28.04 | 20.94 | 38.17 | 31.07 | 56.44 | 46.44 | -18.27 | -15.37 |
| 4 | 0.90391 | 10.16 | 15.25 | 7.54 | 25.41 | 17.70 | 56.00 | 46.00 | -30.59 | -28.30 |
| 5 | 7.08594 | 10.53 | 24.02 | 19.02 | 34.55 | 29.55 | 60.00 | 50.00 | -25.45 | -20.45 |
| 6 | 13.06641 | 10.92 | 15.75 | 10.01 | 26.67 | 20.93 | 60.00 | 50.00 | -33.33 | -29.07 |

Remarks:

1. Q.P. and AV. are abbreviations of quasi-peak and average individually.
2. The emission levels of other frequencies were very low against the limit.
3. Margin value = Emission level – Limit value
4. Correction factor = Insertion loss + Cable loss
5. Emission Level = Correction Factor + Reading Value

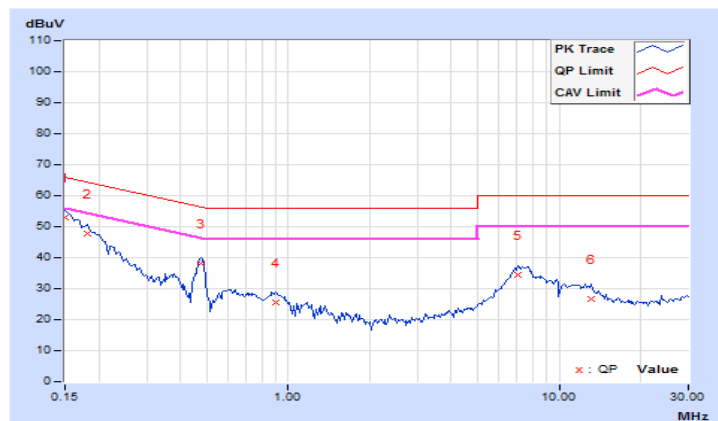

| | | | |
|-------|-------------|-------------------|--------------------------------|
| Phase | Neutral (N) | Detector Function | Quasi-Peak (QP) / Average (AV) |
|-------|-------------|-------------------|--------------------------------|

| No | Freq. | Corr. | Reading Value | | Emission Level | | Limit | | Margin | |
|----|---------|--------|---------------|-------|----------------|-------|-----------|-------|--------|--------|
| | [MHz] | Factor | [dB (uV)] | | [dB (uV)] | | [dB (uV)] | | (dB) | |
| | | (dB) | Q.P. | AV. | Q.P. | AV. | Q.P. | AV. | Q.P. | AV. |
| 1 | 0.15000 | 9.95 | 42.72 | 25.49 | 52.67 | 35.44 | 66.00 | 56.00 | -13.33 | -20.56 |
| 2 | 0.18516 | 9.97 | 36.61 | 19.48 | 46.58 | 29.45 | 64.25 | 54.25 | -17.67 | -24.80 |
| 3 | 0.37656 | 10.01 | 21.81 | 14.00 | 31.82 | 24.01 | 58.35 | 48.35 | -26.53 | -24.34 |
| 4 | 0.47422 | 10.02 | 28.98 | 21.94 | 39.00 | 31.96 | 56.44 | 46.44 | -17.44 | -14.48 |
| 5 | 3.99219 | 10.19 | 12.25 | 2.90 | 22.44 | 13.09 | 56.00 | 46.00 | -33.56 | -32.91 |
| 6 | 7.09375 | 10.37 | 20.42 | 15.51 | 30.79 | 25.88 | 60.00 | 50.00 | -29.21 | -24.12 |

Remarks:

1. Q.P. and AV. are abbreviations of quasi-peak and average individually.
2. The emission levels of other frequencies were very low against the limit.
3. Margin value = Emission level – Limit value
4. Correction factor = Insertion loss + Cable loss
5. Emission Level = Correction Factor + Reading Value

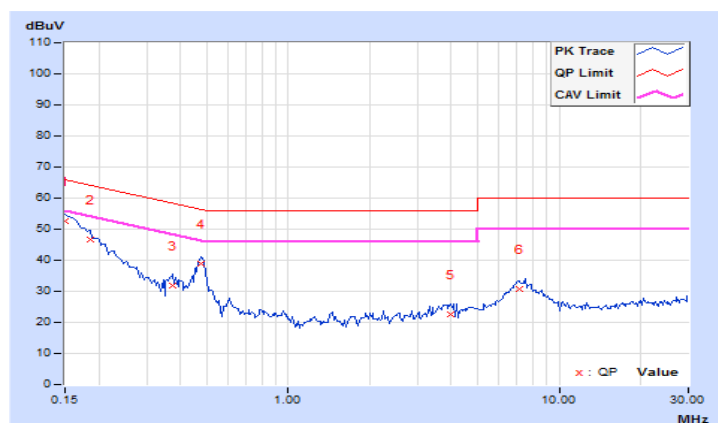

4.3 Transmit Power Measurement

4.3.1 Limits of Transmit Power Measurement

| Operation Band | EUT Category | | Limit |
|----------------|--------------|-----------------------------------|---|
| U-NII-1 | | Outdoor Access Point | 1 Watt (30 dBm) (Max. e.i.r.p \leq 125mW(21 dBm) at any elevation angle above 30 degrees as measured from the horizon) |
| | | Fixed point-to-point Access Point | 1 Watt (30 dBm) |
| | √ | Indoor Access Point | 1 Watt (30 dBm) |
| | | Client device | 250mW (24 dBm) |
| U-NII-2A | | | 250mW (24 dBm) or 11 dBm+10 log B* |
| U-NII-2C | | | 250mW (24 dBm) or 11 dBm+10 log B* |
| U-NII-3 | | √ | 1 Watt (30 dBm) |

*B is the 26 dB emission bandwidth in megahertz

Per KDB 662911 Method of conducted output power measurement on IEEE 802.11 devices,

Array Gain = 0 dB (i.e., no array gain) for $N_{ANT} \leq 4$;

Array Gain = 0 dB (i.e., no array gain) for channel widths ≥ 40 MHz for any N_{ANT} ;

Array Gain = $5 \log(N_{ANT}/N_{SS})$ dB or 3 dB, whichever is less for 20-MHz channel widths with $N_{ANT} \geq 5$.

For power measurements on all other devices: Array Gain = $10 \log(N_{ANT}/N_{SS})$ dB.

4.3.2 Test Setup

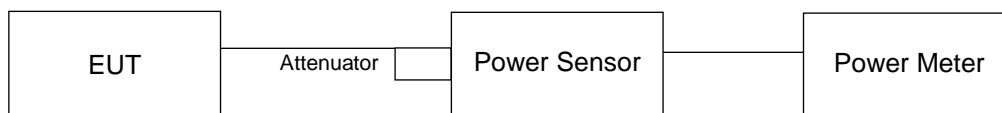

4.3.3 Test Instruments

Refer to section 4.1.2 to get information of above instrument.

4.3.4 Test Procedure

Method PM is used to perform output power measurement, trigger and gating function of wide band power meter is enabled to measure max output power of TX on burst. Duty factor is not added to measured value.

4.3.5 Deviation from Test Standard

No deviation.

4.3.6 EUT Operating Condition

The software provided by client to enable the EUT under transmission condition continuously at lowest, middle and highest channel frequencies individually.

4.3.7 Test Results

802.11a

| Chan. | Chan. Freq. (MHz) | Maximum Conducted (dBm) | | Total Power (mW) | Total Power (dBm) | Limit (dBm) | Pass / Fail |
|-------|-------------------|-------------------------|---------|------------------|-------------------|-------------|-------------|
| | | Chain 0 | Chain 1 | | | | |
| 36 | 5180 | 21.76 | 21.44 | 289.284 | 24.61 | 30 | Pass |
| 40 | 5200 | 24.58 | 24.49 | 568.268 | 27.55 | 30 | Pass |
| 48 | 5240 | 23.07 | 22.78 | 392.439 | 25.94 | 30 | Pass |
| 149 | 5745 | 24.18 | 23.38 | 479.589 | 26.81 | 30 | Pass |
| 157 | 5785 | 23.74 | 23.15 | 443.13 | 26.47 | 30 | Pass |
| 165 | 5825 | 24.13 | 22.92 | 454.705 | 26.58 | 30 | Pass |

802.11ac (VHT20)

| Chan. | Chan. Freq. (MHz) | Maximum Conducted (dBm) | | Total Power (mW) | Total Power (dBm) | Limit (dBm) | Pass / Fail |
|-------|-------------------|-------------------------|---------|------------------|-------------------|-------------|-------------|
| | | Chain 0 | Chain 1 | | | | |
| 36 | 5180 | 20.66 | 20.23 | 221.852 | 23.46 | 30 | Pass |
| 40 | 5200 | 24.70 | 24.41 | 571.179 | 27.57 | 30 | Pass |
| 48 | 5240 | 23.05 | 22.66 | 386.339 | 25.87 | 30 | Pass |
| 149 | 5745 | 24.14 | 23.64 | 490.624 | 26.91 | 30 | Pass |
| 157 | 5785 | 23.84 | 23.22 | 451.997 | 26.55 | 30 | Pass |
| 165 | 5825 | 24.22 | 23.09 | 467.945 | 26.70 | 30 | Pass |

802.11ac (VHT40)

| Chan. | Chan. Freq. (MHz) | Maximum Conducted (dBm) | | Total Power (mW) | Total Power (dBm) | Limit (dBm) | Pass / Fail |
|-------|-------------------|-------------------------|---------|------------------|-------------------|-------------|-------------|
| | | Chain 0 | Chain 1 | | | | |
| 38 | 5190 | 18.95 | 18.58 | 150.635 | 21.78 | 30 | Pass |
| 46 | 5230 | 23.45 | 23.38 | 439.08 | 26.43 | 30 | Pass |
| 151 | 5755 | 24.18 | 23.31 | 476.107 | 26.78 | 30 | Pass |
| 159 | 5795 | 24.25 | 23.02 | 466.52 | 26.69 | 30 | Pass |

802.11ac (VHT80)

| Chan. | Chan. Freq. (MHz) | Maximum Conducted (dBm) | | Total Power (mW) | Total Power (dBm) | Limit (dBm) | Pass / Fail |
|-------|-------------------|-------------------------|---------|------------------|-------------------|-------------|-------------|
| | | Chain 0 | Chain 1 | | | | |
| 42 | 5210 | 18.68 | 18.43 | 143.453 | 21.57 | 30 | Pass |
| 155 | 5775 | 21.54 | 21.48 | 283.166 | 24.52 | 30 | Pass |

4.4 Occupied Bandwidth Measurement

4.4.1 Test Setup

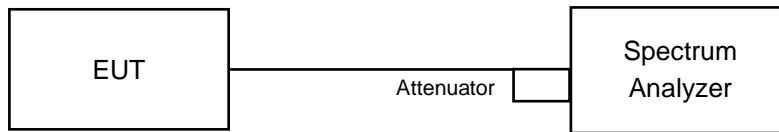

4.4.2 Test Instruments

Refer to section 4.1.2 to get information of above instrument.

4.4.3 Test Procedure

The transmitter output was connected to the spectrum analyzer through an attenuator. The bandwidth of the fundamental frequency was measured by spectrum analyzer with resolution bandwidth in the range of 1% to 5% of the anticipated emission bandwidth, and a video bandwidth at least 3x the resolution bandwidth and set the detector to SAMPLE. The width of a frequency band such that, below the lower and above the upper frequency limits, the mean powers emitted are each equal to a specified percentage 0.5 %of the total mean power of a given emission.

4.4.4 Test Results

802.11a

| Channel | Channel Frequency (MHz) | Occupied Bandwidth (MHz) | |
|---------|-------------------------|--------------------------|---------|
| | | Chain 0 | Chain 1 |
| 36 | 5180 | 16.56 | 16.68 |
| 40 | 5200 | 20.40 | 26.16 |
| 48 | 5240 | 16.68 | 17.28 |
| 149 | 5745 | 19.56 | 25.44 |
| 157 | 5785 | 19.20 | 26.52 |
| 165 | 5825 | 24.48 | 27.72 |

802.11ac (VHT20)

| Channel | Channel Frequency (MHz) | Occupied Bandwidth (MHz) | |
|---------|-------------------------|--------------------------|---------|
| | | Chain 0 | Chain 1 |
| 36 | 5180 | 17.64 | 17.88 |
| 40 | 5200 | 22.20 | 26.76 |
| 48 | 5240 | 18.00 | 18.24 |
| 149 | 5745 | 20.52 | 27.24 |
| 157 | 5785 | 19.32 | 27.12 |
| 165 | 5825 | 24.72 | 28.32 |

802.11ac (VHT40)

| Channel | Channel Frequency (MHz) | Occupied Bandwidth (MHz) | |
|---------|-------------------------|--------------------------|---------|
| | | Chain 0 | Chain 1 |
| 38 | 5190 | 36.24 | 36.24 |
| 46 | 5230 | 36.72 | 38.64 |
| 151 | 5755 | 38.16 | 50.40 |
| 159 | 5795 | 40.08 | 48.00 |

802.11ac (VHT80)

| Channel | Channel Frequency (MHz) | Occupied Bandwidth (MHz) | |
|---------|-------------------------|--------------------------|---------|
| | | Chain 0 | Chain 1 |
| 42 | 5210 | 76.32 | 76.32 |
| 155 | 5775 | 75.84 | 77.28 |

Spectrum Plot of Max. Value

802.11a_Chain 1 / CH165

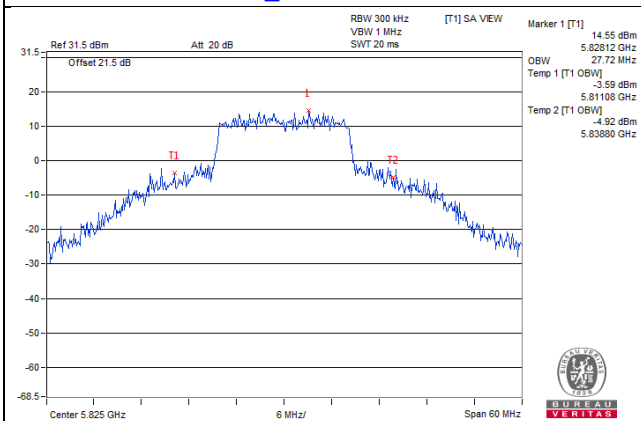

802.11ac (VHT20)_Chain 1 / CH165

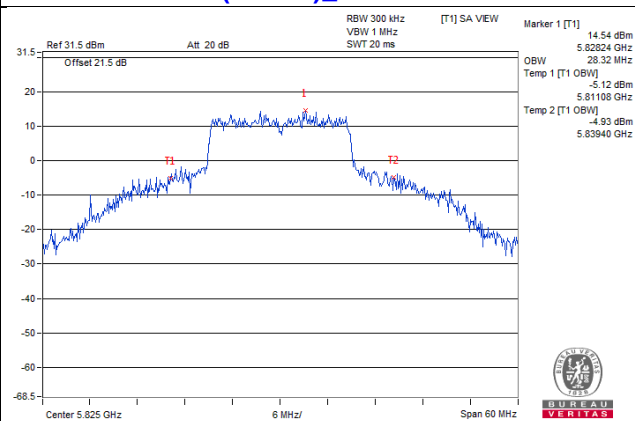

802.11ac (VHT40)_Chain 1 / CH151

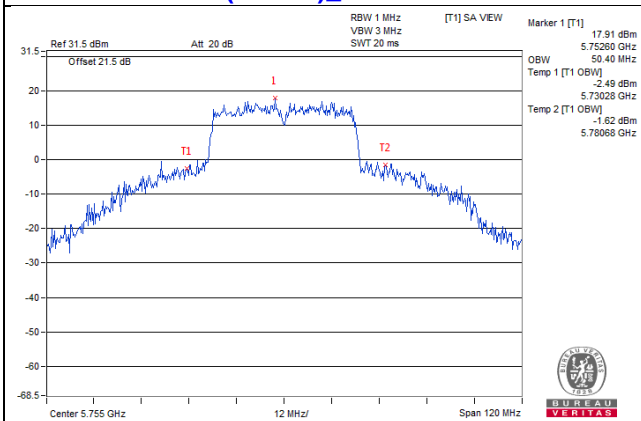

802.11ac (VHT80)_Chain 1 / CH155

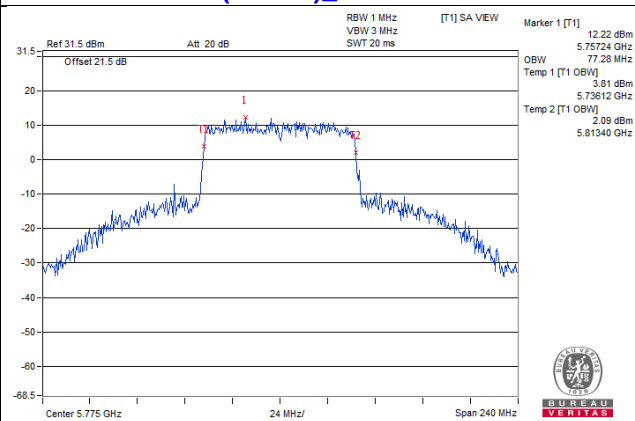

Spectrum Plot for near by DFS band
(DFS is required, if 99% OCP straddle into U-NII-2A band)

802.11a_Chain0 / CH48

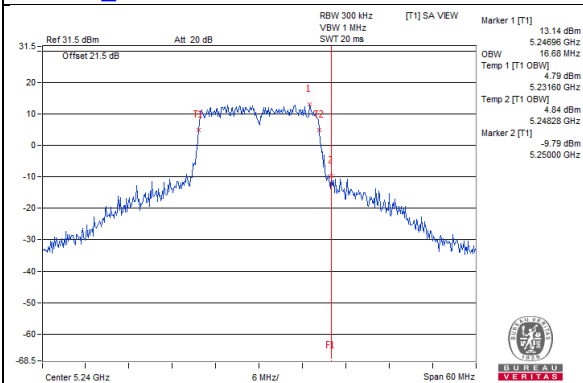

802.11a_Chain1 / CH48

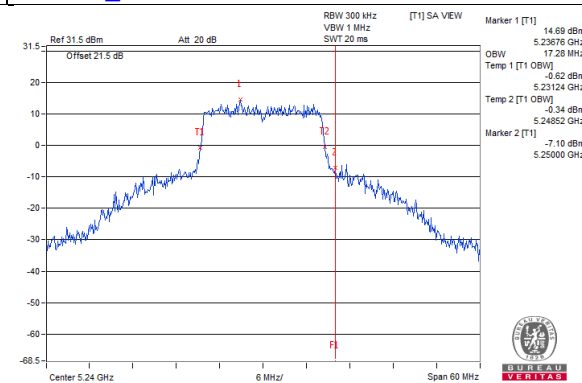

802.11ac (VHT20)_Chain0 / CH48

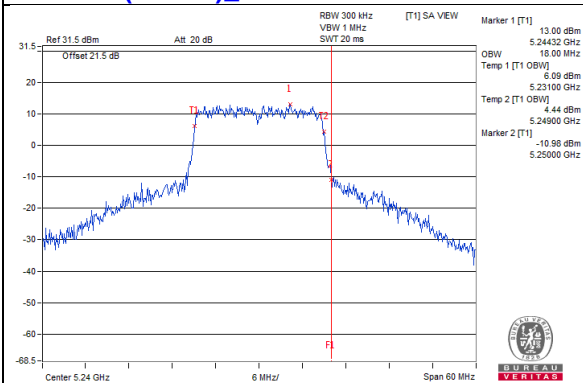

802.11ac (VHT20)_Chain1 / CH48

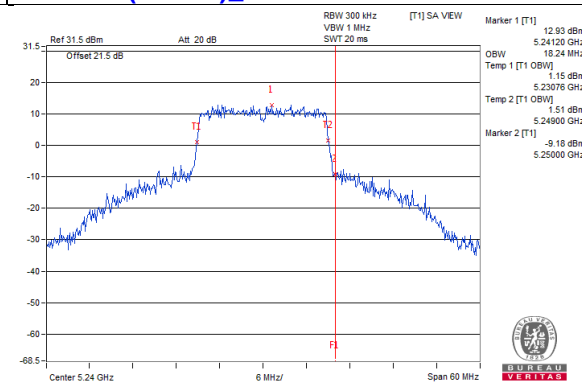

802.11ac (VHT40)_Chain0 / CH46

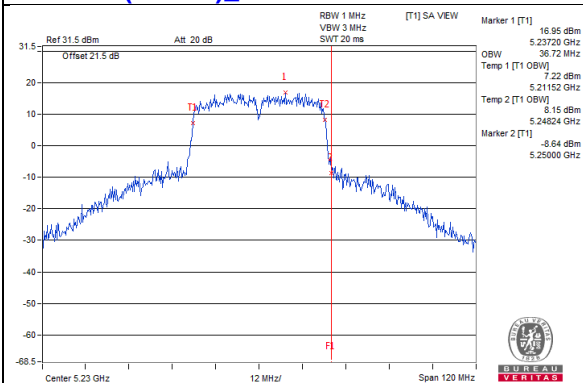

802.11ac (VHT40)_Chain1 / CH46

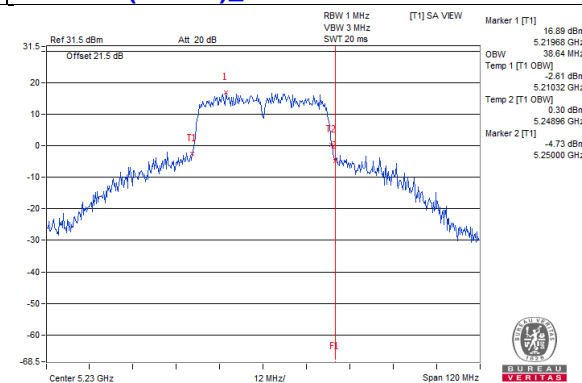

802.11ac (VHT80)_Chain0 / CH42

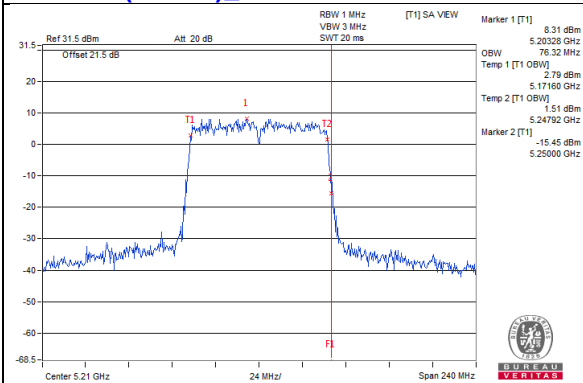

802.11ac (VHT80)_Chain1 / CH42

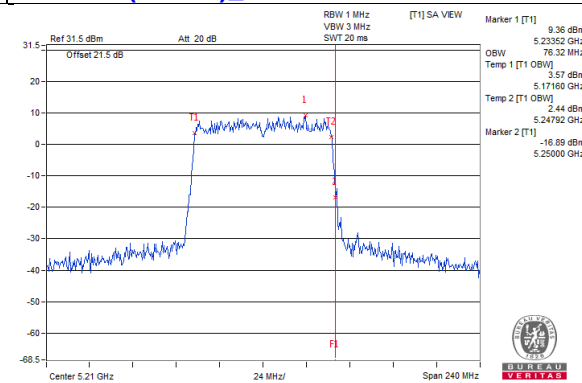

Spectrum Plot for near by DFS band
(DFS is required, if 99% OCP straddle into U-NII-2C band)

802.11a_Chain0 / CH149

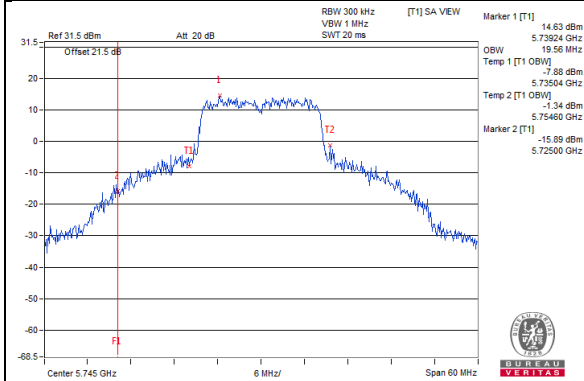

802.11a_Chain1 / CH149

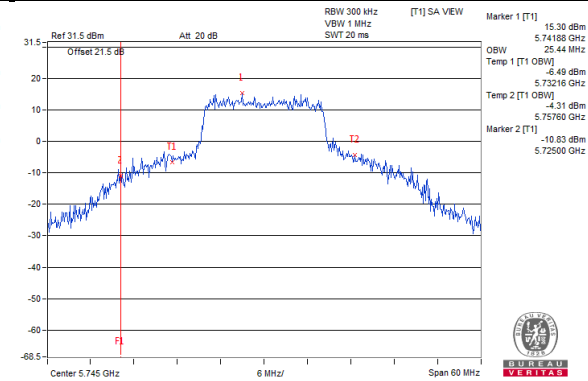

802.11ac (VHT20)_Chain0 / CH149

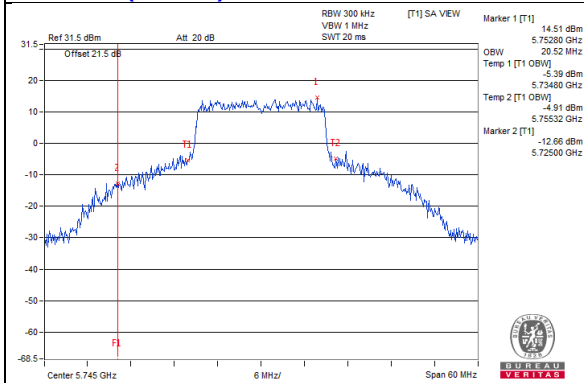

802.11ac (VHT20)_Chain1 / CH149

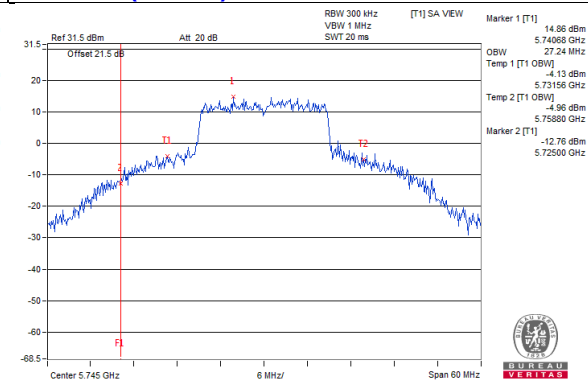

802.11ac (VHT40)_Chain0 / CH151

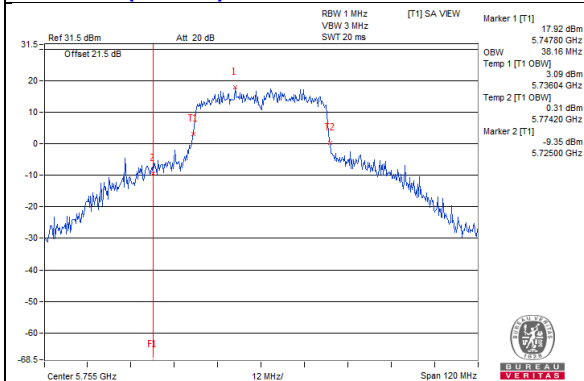

802.11ac (VHT40)_Chain1 / CH151

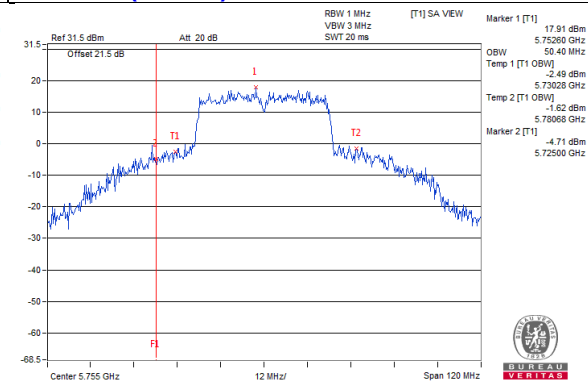

802.11ac (VHT80)_Chain0 / CH155

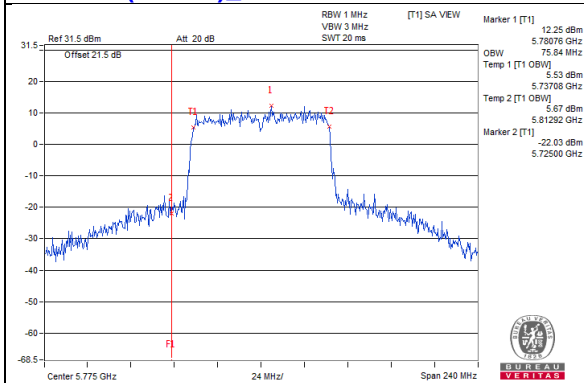

802.11ac (VHT80)_Chain1 / CH155

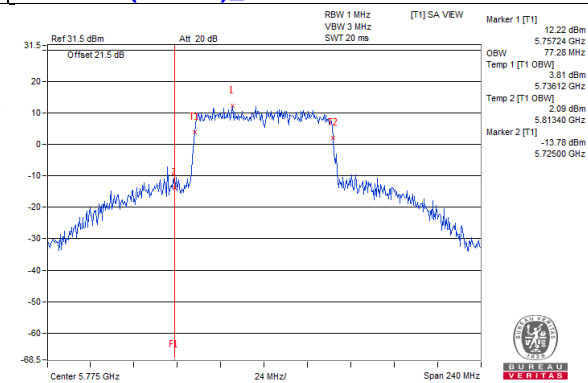

4.5 Peak Power Spectral Density Measurement

4.5.1 Limits of Peak Power Spectral Density Measurement

| Operation Band | EUT Category | | Limit |
|----------------|--------------|-----------------------------------|---------------|
| U-NII-1 | | Outdoor Access Point | 17dBm/ MHz |
| | | Fixed point-to-point Access Point | |
| | √ | Indoor Access Point | |
| | | Client device | 11dBm/ MHz |
| U-NII-2A | | | 11dBm/ MHz |
| U-NII-2C | | | 11dBm/ MHz |
| U-NII-3 | √ | | 30dBm/ 500kHz |

4.5.2 Test Setup

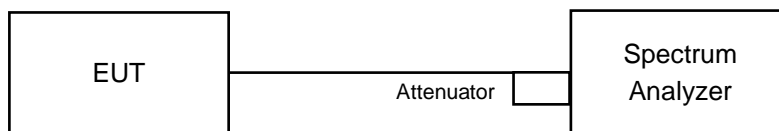

4.5.3 Test Instruments

Refer to section 4.1.2 to get information of above instrument.

4.5.4 Test Procedure

For U-NII-1 band:

For 802.11ac (VHT20)

Using method SA-1

1. Set span to encompass the entire emission bandwidth (EBW) of the signal.
2. Set RBW = 1 MHz, Set VBW \geq 3 MHz, Detector = RMS
3. Sweep time = auto, trigger set to "free run".
4. Trace average at least 100 traces in power averaging mode.
5. Record the max value

For 802.11a, 802.11ac (VHT40) & 802.11ac (VHT80)

Using method SA-2

1. Set span to encompass the entire emission bandwidth (EBW) of the signal.
2. Set RBW = 1 MHz, Set VBW \geq 3 MHz, Detector = RMS
3. Sweep time = auto, trigger set to "free run".
4. Trace average at least 100 traces in power averaging mode.
5. Record the max value and add $10 \log (1/\text{duty cycle})$

For U-NII-3:

For 802.11ac (VHT20)

1. Set span to encompass the entire emission bandwidth (EBW) of the signal.
2. Set RBW = 300 kHz, Set VBW \geq 1 MHz, Detector = RMS
3. Use the peak marker function to determine the maximum power level in any 300 kHz band segment within the fundamental EBW.
4. Scale the observed power level to an equivalent value in 500 kHz by adjusting (reducing) the measured power by a bandwidth correction factor (BWCF) where $\text{BWCF} = 10 \log (500 \text{ kHz} / 300 \text{ kHz})$
5. Sweep time = auto, trigger set to "free run".
6. Trace average at least 100 traces in power averaging mode.
7. Record the max value

For 802.11a, 802.11ac (VHT40) & 802.11ac (VHT80)

1. Set span to encompass the entire emission bandwidth (EBW) of the signal.
2. Set RBW = 300 kHz, Set VBW \geq 1 MHz, Detector = RMS
3. Use the peak marker function to determine the maximum power level in any 300 kHz band segment within the fundamental EBW.
4. Scale the observed power level to an equivalent value in 500 kHz by adjusting (reducing) the measured power by a bandwidth correction factor (BWCF) where $\text{BWCF} = 10 \log (500 \text{ kHz} / 300 \text{ kHz})$
5. Sweep time = auto, trigger set to "free run".
6. Trace average at least 100 traces in power averaging mode.
7. Record the max value and add $10 \log (1/\text{duty cycle})$

4.5.5 Deviation from Test Standard

No deviation.

4.5.6 EUT Operating Condition

Same as Item 4.3.6.

4.5.7 Test Results

For U-NII-1:

802.11a

| Chan. | Chan. Freq. (MHz) | PSD W/O Duty Factor (dBm/MHz) | | Duty Factor (dB) | Total PSD With Duty Factor (dBm/MHz) | Max. Limit (dBm/MHz) | Pass / Fail |
|-------|-------------------|-------------------------------|---------|------------------|--------------------------------------|----------------------|-------------|
| | | Chain 0 | Chain 1 | | | | |
| 36 | 5180 | 7.43 | 7.48 | 0.16 | 10.63 | 17 | Pass |
| 40 | 5200 | 10.05 | 10.28 | 0.16 | 13.34 | 17 | Pass |
| 48 | 5240 | 9.26 | 9.13 | 0.16 | 12.37 | 17 | Pass |

- Note: 1. Method a) of power density measurement of KDB 662911 is using for calculating total power density. Total power density is summing entire spectra across corresponding frequency bins on the various outputs by computer.
2. The directional gain = $10 \log[(10^{\text{Chain1}/20} + 10^{\text{Chain2}/20})^2 / 2] = 5.01\text{dBi} < 6\text{dBi}$, so the power density limit shall not be reduced.
3. Refer to section 3.3 for duty cycle spectrum plot.

802.11ac (VHT20)

| Chan. | Chan. Freq. (MHz) | PSD (dBm/MHz) | | Total Power Density (dBm/MHz) | Max. Limit (dBm/MHz) | Pass / Fail |
|-------|-------------------|---------------|---------|-------------------------------|----------------------|-------------|
| | | Chain 0 | Chain 1 | | | |
| 36 | 5180 | 6.80 | 6.87 | 9.85 | 17 | Pass |
| 40 | 5200 | 10.00 | 10.28 | 13.15 | 17 | Pass |
| 48 | 5240 | 9.11 | 9.06 | 12.10 | 17 | Pass |

- Note: 1. Method a) of power density measurement of KDB 662911 is using for calculating total power density. Total power density is summing entire spectra across corresponding frequency bins on the various outputs by computer.
2. The directional gain = $10 \log[(10^{\text{Chain1}/20} + 10^{\text{Chain2}/20})^2 / 2] = 5.01\text{dBi} < 6\text{dBi}$, so the power density limit shall not be reduced.

802.11ac (VHT40)

| Chan. | Chan. Freq. (MHz) | PSD W/O Duty Factor (dBm/MHz) | | Duty Factor (dB) | Total PSD With Duty Factor (dBm/MHz) | Max. Limit (dBm/MHz) | Pass / Fail |
|-------|-------------------|-------------------------------|---------|------------------|--------------------------------------|----------------------|-------------|
| | | Chain 0 | Chain 1 | | | | |
| 38 | 5190 | 1.62 | 2.00 | 0.15 | 4.97 | 17 | Pass |
| 46 | 5230 | 6.72 | 6.49 | 0.15 | 9.77 | 17 | Pass |

- Note: 1. Method a) of power density measurement of KDB 662911 is using for calculating total power density. Total power density is summing entire spectra across corresponding frequency bins on the various outputs by computer.
2. The directional gain = $10 \log[(10^{\text{Chain1}/20} + 10^{\text{Chain2}/20})^2 / 2] = 5.01\text{dBi} < 6\text{dBi}$, so the power density limit shall not be reduced.
3. Refer to section 3.3 for duty cycle spectrum plot.

802.11ac (VHT80)

| Chan. | Chan. Freq. (MHz) | PSD W/O Duty Factor (dBm/MHz) | | Duty Factor (dB) | Total PSD With Duty Factor (dBm/MHz) | Max. Limit (dBm/MHz) | Pass / Fail |
|-------|-------------------|-------------------------------|---------|------------------|--------------------------------------|----------------------|-------------|
| | | Chain 0 | Chain 1 | | | | |
| 42 | 5210 | -2.16 | -1.70 | 0.30 | 1.39 | 17 | Pass |

Note: 1. Method a) of power density measurement of KDB 662911 is using for calculating total power density. Total power density is summing entire spectra across corresponding frequency bins on the various outputs by computer.

2. The directional gain = $10 \log[(10^{\text{Chain1}/20} + 10^{\text{Chain2}/20})^2 / 2] = 5.01\text{dBi} < 6\text{dBi}$, so the power density limit shall not be reduced.

3. Refer to section 3.3 for duty cycle spectrum plot.

Spectrum Plot of Worst Value

802.11a_Chain 1 / CH40

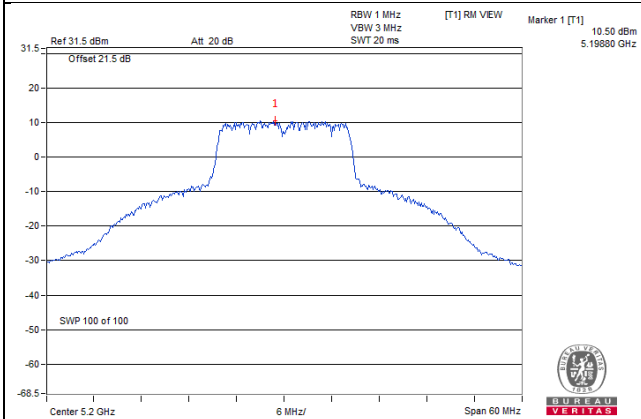

802.11ac (VHT20)_Chain 1 / CH40

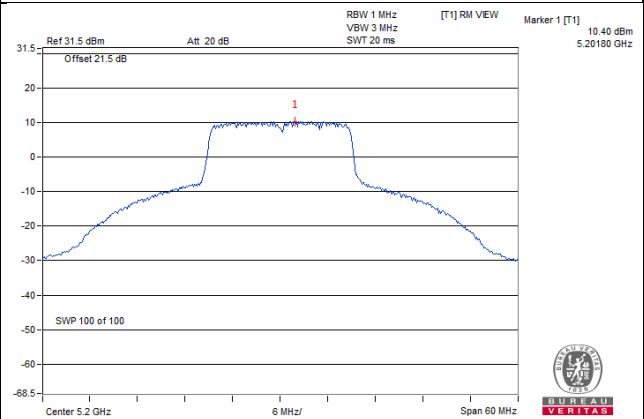

802.11ac (VHT40)_Chain 0 / CH46

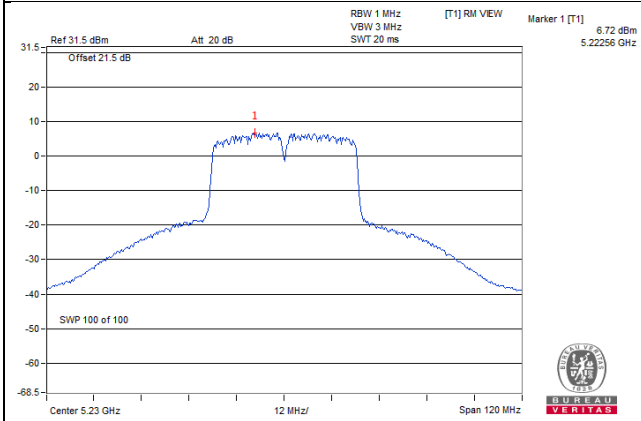

802.11ac (VHT80)_Chain 1 / CH42

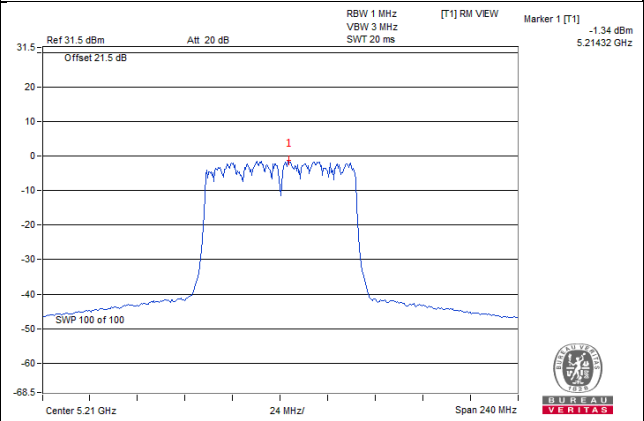

For U-NII-3:
802.11a

| TX chain | Chan. | Chan. Freq. (MHz) | PSD W/O Duty Factor | | 10 log (N=2) dB | Duty Factor (dB) | Total PSD With Duty Factor (dBm/500kHz) | Limit (dBm/500kHz) | Pass /Fail |
|----------|-------|-------------------|---------------------|--------------|-----------------|------------------|---|--------------------|------------|
| | | | (dBm/300kHz) | (dBm/500kHz) | | | | | |
| 0 | 149 | 5745 | 1.91 | 4.13 | 3.01 | 0.16 | 7.30 | 30 | Pass |
| | 157 | 5785 | 1.44 | 3.66 | 3.01 | 0.16 | 6.83 | 30 | Pass |
| | 165 | 5825 | 2.14 | 4.36 | 3.01 | 0.16 | 7.53 | 30 | Pass |
| 1 | 149 | 5745 | 1.75 | 3.97 | 3.01 | 0.16 | 7.14 | 30 | Pass |
| | 157 | 5785 | 1.22 | 3.44 | 3.01 | 0.16 | 6.61 | 30 | Pass |
| | 165 | 5825 | 1.37 | 3.59 | 3.01 | 0.16 | 6.76 | 30 | Pass |

Note: 1. The directional gain = $10 \log[(10^{\text{Chain1}/20} + 10^{\text{Chain2}/20})^2 / 2] = 5.61\text{dBi} < 6\text{dBi}$, so the power density limit shall not be reduced.

2. Refer to section 3.3 for duty cycle spectrum plot.

802.11ac (VHT20)

| TX chain | Chan. | Chan. Freq. (MHz) | PSD | | 10 log (N=2) dB | Total PSD (dBm/500kHz) | Limit (dBm/500kHz) | Pass /Fail |
|----------|-------|-------------------|--------------|--------------|-----------------|------------------------|--------------------|------------|
| | | | (dBm/300kHz) | (dBm/500kHz) | | | | |
| 0 | 149 | 5745 | 1.99 | 4.21 | 3.01 | 7.22 | 30 | Pass |
| | 157 | 5785 | 1.56 | 3.78 | 3.01 | 6.79 | 30 | Pass |
| | 165 | 5825 | 1.84 | 4.06 | 3.01 | 7.07 | 30 | Pass |
| 1 | 149 | 5745 | 2.08 | 4.30 | 3.01 | 7.31 | 30 | Pass |
| | 157 | 5785 | 1.33 | 3.55 | 3.01 | 6.56 | 30 | Pass |
| | 165 | 5825 | 1.32 | 3.54 | 3.01 | 6.55 | 30 | Pass |

Note: 1. The directional gain = $10 \log[(10^{\text{Chain1}/20} + 10^{\text{Chain2}/20})^2 / 2] = 5.61\text{dBi} < 6\text{dBi}$, so the power density limit shall not be reduced.

802.11ac (VHT40)

| TX chain | Chan. | Chan. Freq. (MHz) | PSD W/O Duty Factor | | 10 log (N=2) dB | Duty Factor (dB) | Total PSD With Duty Factor (dBm/500kHz) | Limit (dBm/500kHz) | Pass /Fail |
|----------|-------|-------------------|---------------------|--------------|-----------------|------------------|---|--------------------|------------|
| | | | (dBm/300kHz) | (dBm/500kHz) | | | | | |
| 0 | 151 | 5755 | -1.57 | 0.65 | 3.01 | 0.15 | 3.81 | 30 | Pass |
| | 159 | 5795 | -1.45 | 0.77 | 3.01 | 0.15 | 3.93 | 30 | Pass |
| 1 | 151 | 5755 | -1.34 | 0.88 | 3.01 | 0.15 | 4.04 | 30 | Pass |
| | 159 | 5795 | -1.98 | 0.24 | 3.01 | 0.15 | 3.40 | 30 | Pass |

Note: 1. The directional gain = $10 \log[(10^{\text{Chain1}/20} + 10^{\text{Chain2}/20})^2 / 2] = 5.61\text{dBi} < 6\text{dBi}$, so the power density limit shall not be reduced.

2. Refer to section 3.3 for duty cycle spectrum plot.

802.11ac (VHT80)

| TX chain | Chan. | Chan. Freq. (MHz) | PSD W/O Duty Factor | | 10 log (N=2) dB | Duty Factor (dB) | Total PSD With Duty Factor (dBm/500kHz) | Limit (dBm/500kHz) | Pass /Fail |
|----------|-------|-------------------|---------------------|--------------|-----------------|------------------|---|--------------------|------------|
| | | | (dBm/300kHz) | (dBm/500kHz) | | | | | |
| 0 | 155 | 5775 | -7.35 | -5.13 | 3.01 | 0.30 | -1.82 | 30 | Pass |
| 1 | 155 | 5775 | -6.61 | -4.39 | 3.01 | 0.30 | -1.08 | 30 | Pass |

Note: 1. The directional gain = $10 \log[(10^{\text{Chain1}/20} + 10^{\text{Chain2}/20})^2 / 2] = 5.61\text{dBi} < 6\text{dBi}$, so the power density limit shall not be reduced.

2. Refer to section 3.3 for duty cycle spectrum plot.

Spectrum Plot of Worst Value

802.11a_Chain 0 / CH165

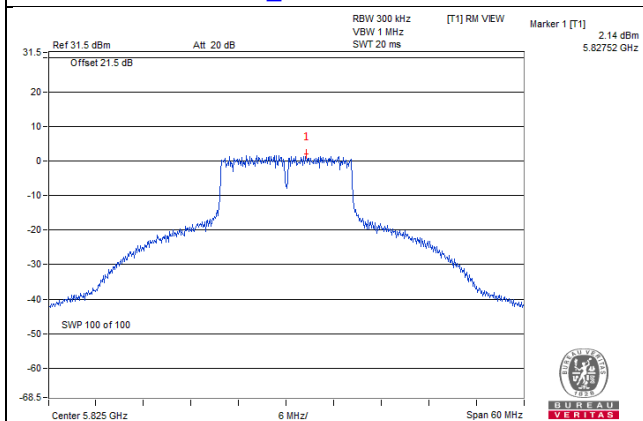

802.11ac (VHT20)_Chain 1 / CH149

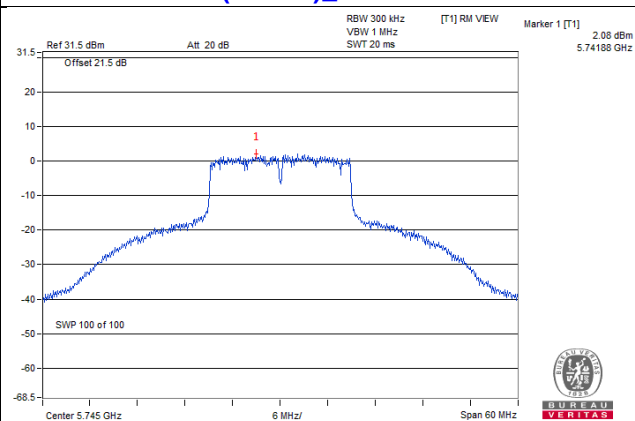

802.11ac (VHT40)_Chain 1 / CH151

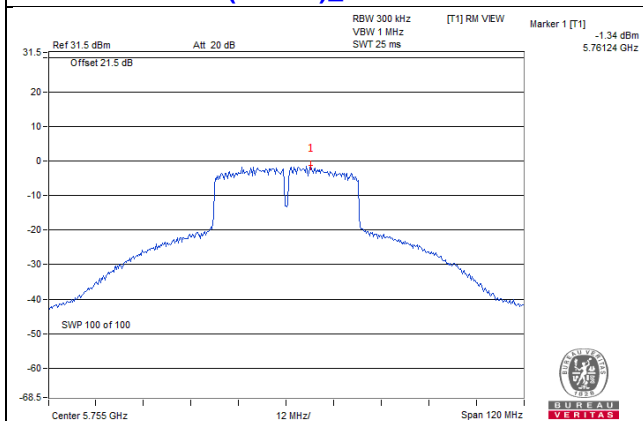

802.11ac (VHT80)_Chain 1 / CH155

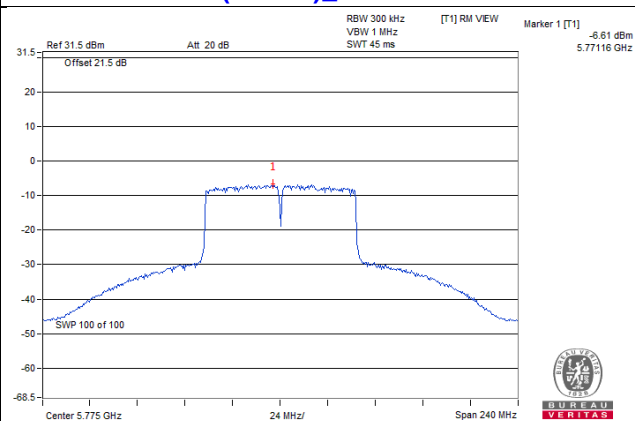

4.6 Frequency Stability Measurement

4.6.1 Limits of Frequency Stability Measurement

The frequency of the carrier signal shall be maintained within band of operation

4.6.2 Test Setup

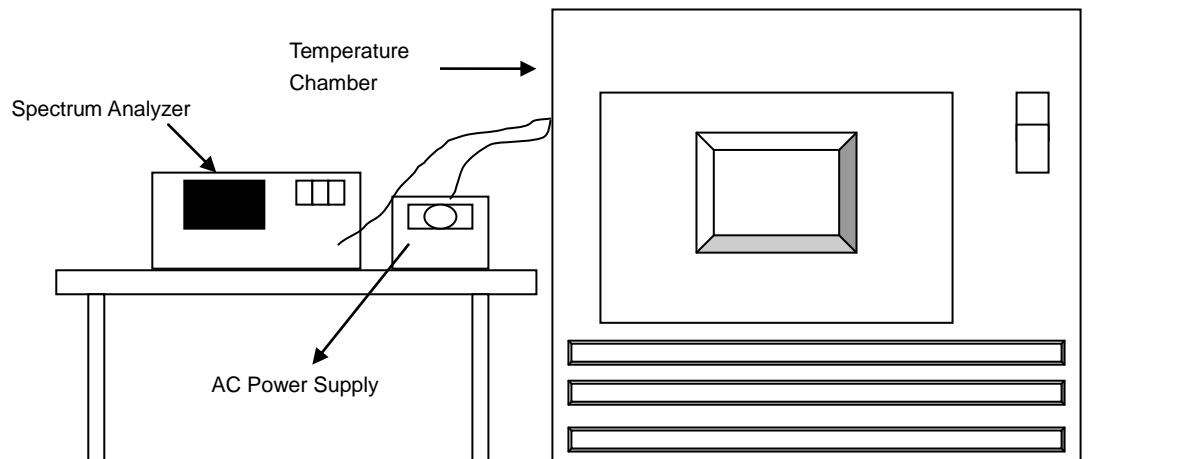

4.6.3 Test Instruments

Refer to section 4.1.2 to get information of above instrument.

4.6.4 Test Procedure

- The EUT was placed inside the environmental test chamber and powered by nominal AC voltage.
- Turn the EUT on and couple its output to a spectrum analyzer.
- Turn the EUT off and set the chamber to the highest temperature specified.
- Allow sufficient time (approximately 30 min) for the temperature of the chamber to stabilize, turn the EUT on and measure the operating frequency after 2, 5, and 10 Minutes.
- Repeat step 2 and 3 with the temperature chamber set to the lowest temperature.
- The test chamber was allowed to stabilize at +20 degree C for a minimum of 30 Minutes. The supply voltage was then adjusted on the EUT from 85% to 115% and the frequency record.

4.6.5 Deviation from Test Standard

No deviation.

4.6.6 EUT Operating Condition

Set the EUT transmit at un-modulation mode to test frequency stability.

4.6.7 Test Results

| Frequency Stability Versus Temp. | | | | | | | | | |
|----------------------------------|--------------------------|--------------------------------|-----------|--------------------------------|-----------|--------------------------------|-----------|--------------------------------|-----------|
| Operating Frequency: 5180 MHz | | | | | | | | | |
| TEMP. (°C) | Power Supply (Vac) | 0 Minute | | 2 Minutes | | 5 Minutes | | 10 Minutes | |
| | | Measured Frequency (MHz) | Pass/Fail | Measured Frequency (MHz) | Pass/Fail | Measured Frequency (MHz) | Pass/Fail | Measured Frequency (MHz) | Pass/Fail |
| 50 | 120 | 5180.0203 | Pass | 5180.0197 | Pass | 5180.0187 | Pass | 5180.018 | Pass |
| 40 | 120 | 5180.0161 | Pass | 5180.0173 | Pass | 5180.016 | Pass | 5180.018 | Pass |
| 30 | 120 | 5180.0002 | Pass | 5179.9985 | Pass | 5179.998 | Pass | 5180.002 | Pass |
| 20 | 120 | 5179.9999 | Pass | 5180.0009 | Pass | 5180.0008 | Pass | 5179.9994 | Pass |
| 10 | 120 | 5180.0052 | Pass | 5180.0012 | Pass | 5180.003 | Pass | 5180.0058 | Pass |
| 0 | 120 | 5180.0007 | Pass | 5179.9962 | Pass | 5179.9983 | Pass | 5179.9998 | Pass |
| -10 | 120 | 5180.0069 | Pass | 5180.0061 | Pass | 5180.0103 | Pass | 5180.0092 | Pass |
| -20 | 120 | 5179.981 | Pass | 5179.9804 | Pass | 5179.9783 | Pass | 5179.9781 | Pass |
| -30 | 120 | 5180.0129 | Pass | 5180.0121 | Pass | 5180.0091 | Pass | 5180.0113 | Pass |

| Frequency Stability Versus Voltage | | | | | | | | | |
|------------------------------------|--------------------------|--------------------------------|-----------|--------------------------------|-----------|--------------------------------|-----------|--------------------------------|-----------|
| Operating Frequency: 5180 MHz | | | | | | | | | |
| TEMP. (°C) | Power Supply (Vac) | 0 Minute | | 2 Minutes | | 5 Minutes | | 10 Minutes | |
| | | Measured Frequency (MHz) | Pass/Fail | Measured Frequency (MHz) | Pass/Fail | Measured Frequency (MHz) | Pass/Fail | Measured Frequency (MHz) | Pass/Fail |
| 20 | 138 | 5179.9993 | Pass | 5180.0012 | Pass | 5180.0018 | Pass | 5179.9998 | Pass |
| | 120 | 5179.9999 | Pass | 5180.0009 | Pass | 5180.0008 | Pass | 5179.9994 | Pass |
| | 102 | 5179.9992 | Pass | 5180.0017 | Pass | 5180.0005 | Pass | 5180.0003 | Pass |

4.7 6dB Bandwidth Measurement

4.7.1 Limits of 6dB Bandwidth Measurement

The minimum of 6dB Bandwidth Measurement is 0.5MHz.

4.7.2 Test Setup

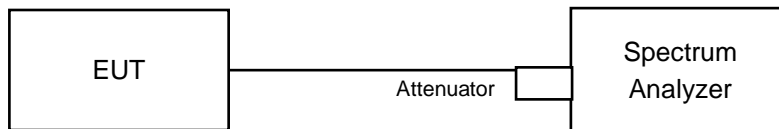

4.7.3 Test Instruments

Refer to section 4.1.2 to get information of above instrument.

4.7.4 Test Procedure

MEASUREMENT PROCEDURE REF

- Set resolution bandwidth (RBW) = 100kHz
- Set the video bandwidth (VBW) $\geq 3 \times$ RBW, Detector = Peak.
- Trace mode = max hold.
- Sweep = auto couple.
- Measure the maximum width of the emission that is constrained by the frequencies associated with the two amplitude points (upper and lower) that are attenuated by 6 dB relative to the maximum level measured in the fundamental emission

4.7.5 Deviation from Test Standard

No deviation.

4.7.6 EUT Operating Condition

The software provided by client to enable the EUT under transmission condition continuously at lowest, middle and highest channel frequencies individually.

4.7.7 Test Results

802.11a

| Channel | Frequency (MHz) | 6dB Bandwidth (MHz) | | Minimum Limit (MHz) | Pass / Fail |
|---------|-----------------|---------------------|---------|---------------------|-------------|
| | | Chain 0 | Chain 1 | | |
| 149 | 5745 | 16.38 | 16.36 | 0.5 | Pass |
| 157 | 5785 | 16.38 | 16.38 | 0.5 | Pass |
| 165 | 5825 | 16.39 | 16.39 | 0.5 | Pass |

802.11ac (VHT20)

| Channel | Frequency (MHz) | 6dB Bandwidth (MHz) | | Minimum Limit (MHz) | Pass / Fail |
|---------|-----------------|---------------------|---------|---------------------|-------------|
| | | Chain 0 | Chain 1 | | |
| 149 | 5745 | 17.66 | 17.61 | 0.5 | Pass |
| 157 | 5785 | 17.65 | 17.65 | 0.5 | Pass |
| 165 | 5825 | 17.63 | 17.58 | 0.5 | Pass |

802.11ac (VHT40)

| Channel | Frequency (MHz) | 6dB Bandwidth (MHz) | | Minimum Limit (MHz) | Pass / Fail |
|---------|-----------------|---------------------|---------|---------------------|-------------|
| | | Chain 0 | Chain 1 | | |
| 151 | 5755 | 35.56 | 35.09 | 0.5 | Pass |
| 159 | 5795 | 36.12 | 35.21 | 0.5 | Pass |

802.11ac (VHT80)

| Channel | Frequency (MHz) | 6dB Bandwidth (MHz) | | Minimum Limit (MHz) | Pass / Fail |
|---------|-----------------|---------------------|---------|---------------------|-------------|
| | | Chain 0 | Chain 1 | | |
| 155 | 5775 | 75.99 | 75.61 | 0.5 | Pass |

Spectrum Plot of Worst Value

802.11a_Chain 1 / CH149

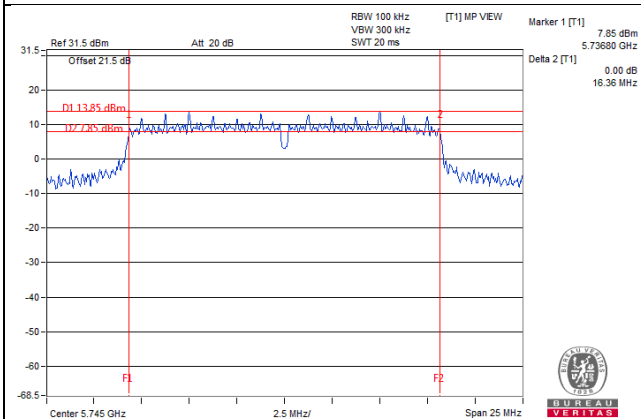

802.11ac (VHT20)_Chain 1 / CH165

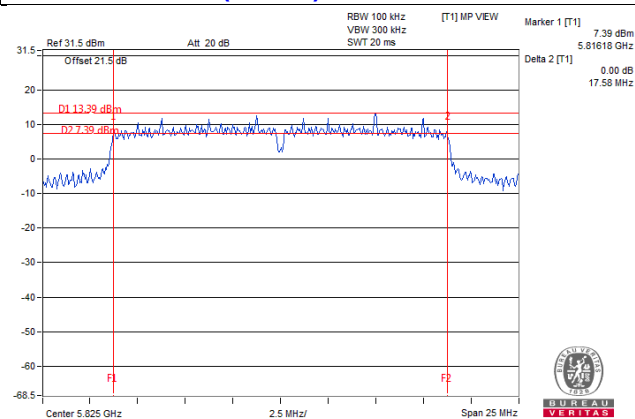

802.11ac (VHT40)_Chain 1 / CH151

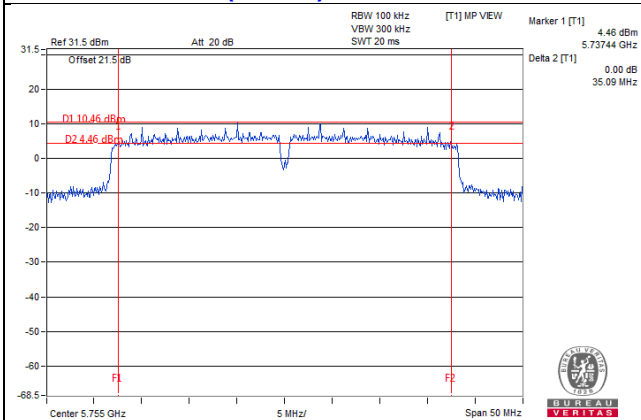

802.11ac (VHT80)_Chain 1 / CH155

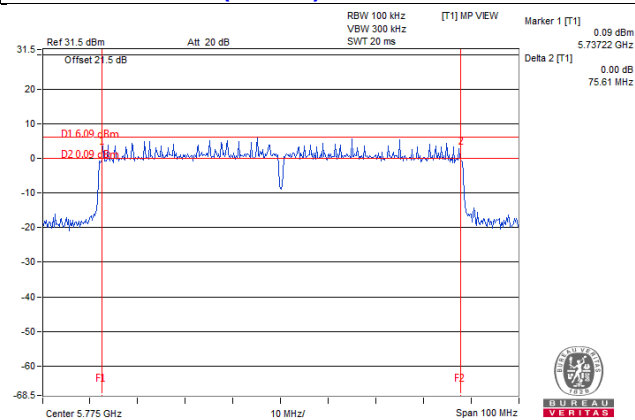

5 Pictures of Test Arrangements

Please refer to the attached file (Test Setup Photo).

Annex A- Radiated Out of Band Emission (OOBE) Measurement (For U-NII-3 band)

802.11a

CH 149 5745 MHz

Horizontal

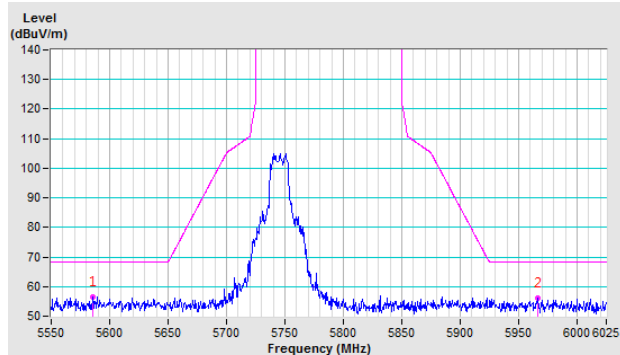

Vertical

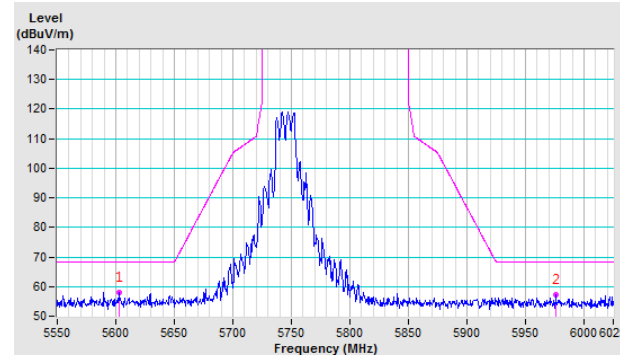

CH 157 5785 MHz

Horizontal

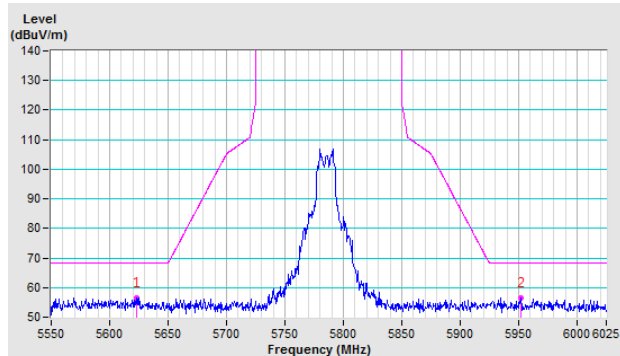

Vertical

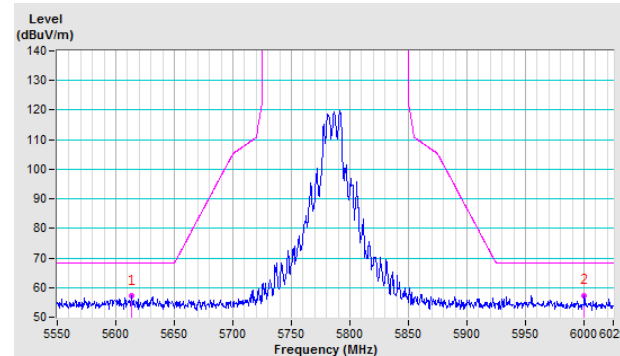

CH 165 5825 MHz

Horizontal

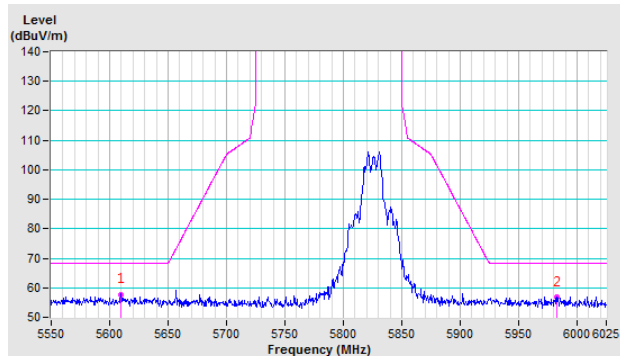

Vertical

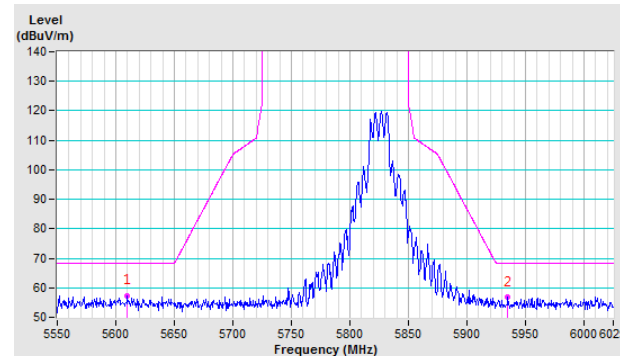

802.11ac (VHT20)

CH 149 5745 MHz

Horizontal

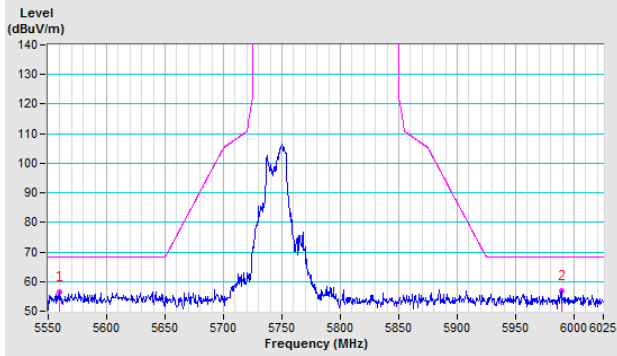

Vertical

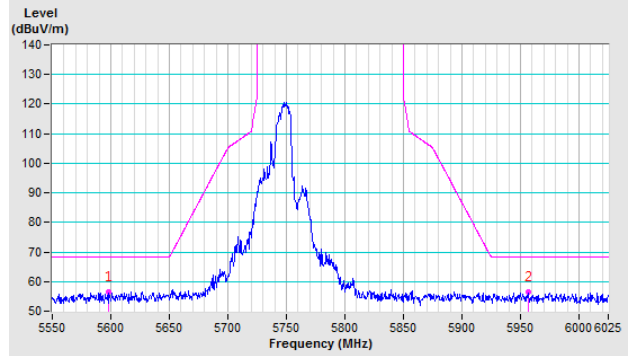

CH 157 5785 MHz

Horizontal

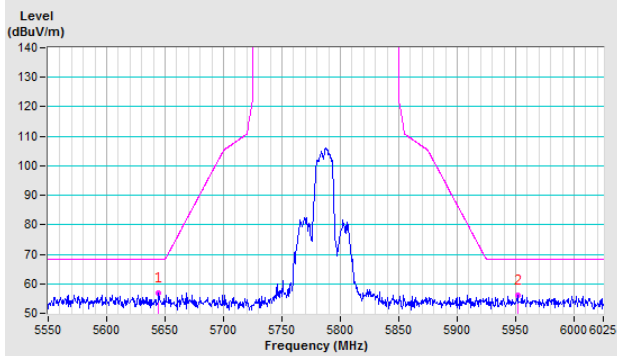

Vertical

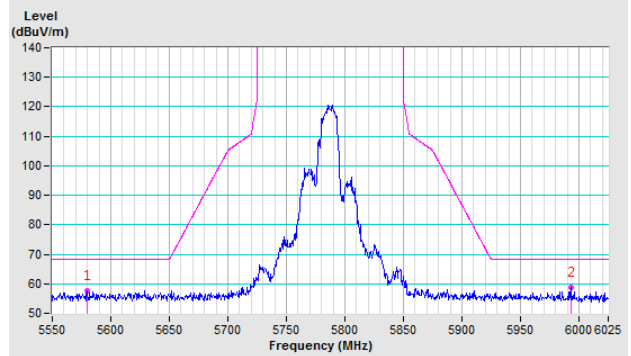

CH 165 5825 MHz

Horizontal

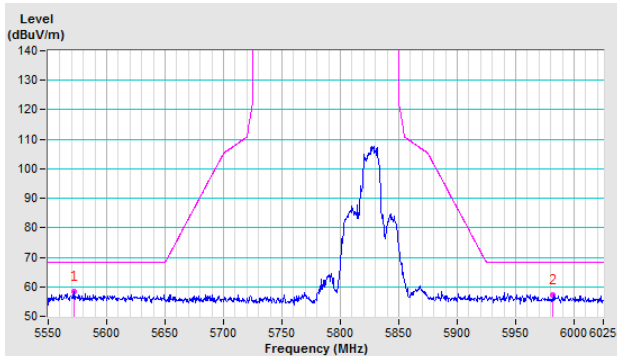

Vertical

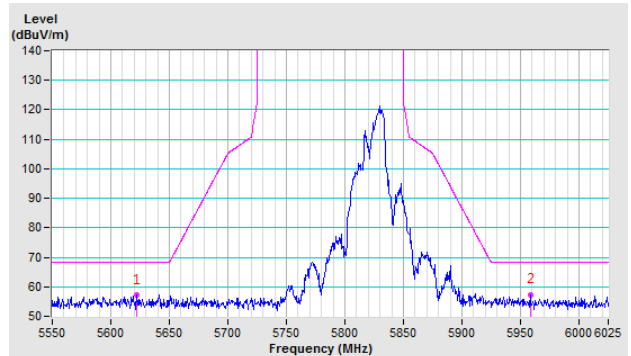

802.11ac (VHT40)

CH 151 5755 MHz

Horizontal

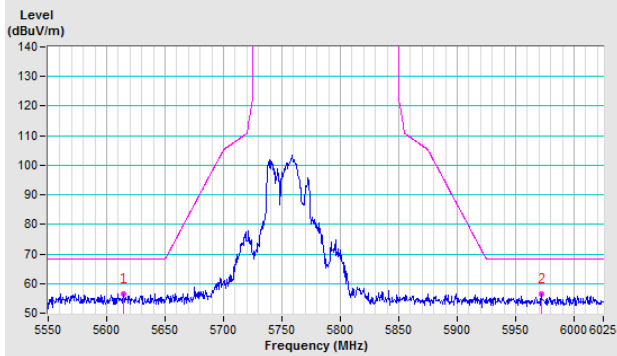

Vertical

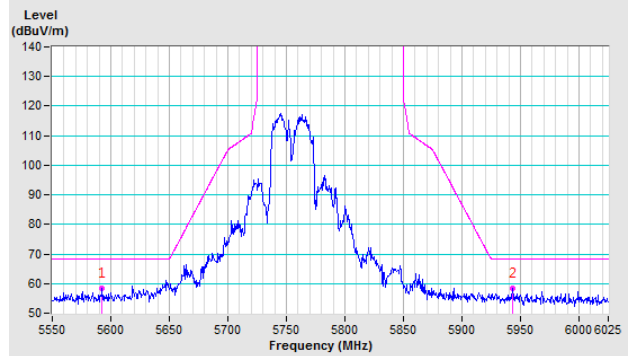

CH 159 5795 MHz

Horizontal

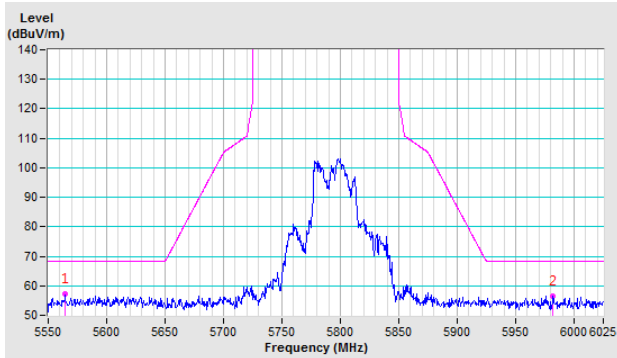

Vertical

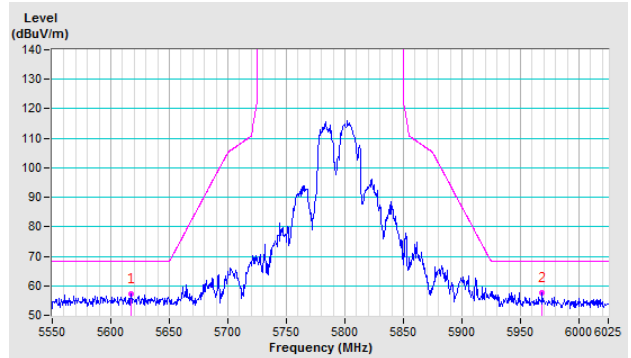

802.11ac (VHT80)

CH 155 5775 MHz

Horizontal

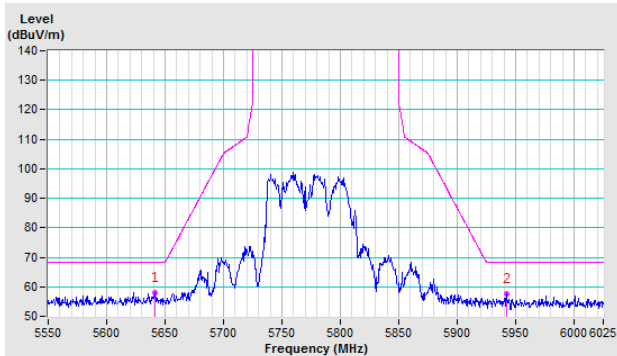

Vertical

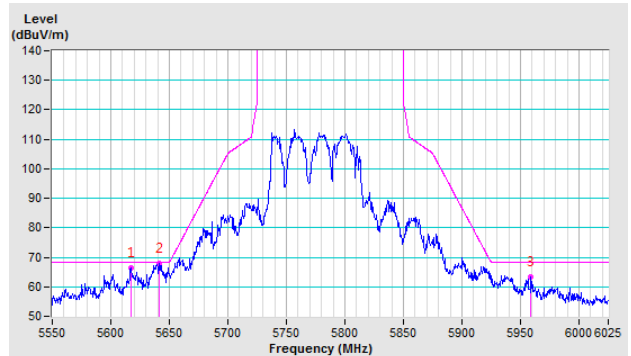

Appendix – Information on the Testing Laboratories

We, Bureau Veritas Consumer Products Services (H.K.) Ltd., Taoyuan Branch, were founded in 1988 to provide our best service in EMC, Radio, Telecom and Safety consultation. Our laboratories are FCC recognized accredited test firms and accredited according to ISO/IEC 17025.

If you have any comments, please feel free to contact us at the following:

Linkou EMC/RF Lab

Tel: 886-2-26052180

Fax: 886-2-26051924

Hsin Chu EMC/RF/Telecom Lab

Tel: 886-3-6668565

Fax: 886-3-6668323

Hwa Ya EMC/RF/Safety Lab

Tel: 886-3-3183232

Fax: 886-3-3270892

Email: service.adt@tw.bureauveritas.com

Web Site: www.bureauveritas-adt.com

The address and road map of all our labs can be found in our web site also.

--- END ---