





FCC CERTIFICATION TEST REPORT

Applicant:	Sahara Presentation Systems Ltd
Address:	Europa House, Littlebrook DC1, Shield Road, Dartford, Kent DA1 5UR, United Kingdom
Manufacturer:	Sahara Presentation Systems Ltd
Address:	Europa House, Littlebrook DC1, Shield Road, Dartford, Kent DA1 5UR, United Kingdom
Product Description:	Clevershare Hub, CleverHub
Brand Name:	CLEVERTOUCH
Tested Model:	CleverHub
FCC ID:	2APKO-WB05
Report No.:	JCF230411201-006
Received Date:	Apr. 11, 2023
Tested Date:	Apr. 11, 2023 ~ Sep. 11, 2023
Issued Date:	Sep. 11, 2023
Test Standards:	FCC Rules and Regulations Part 15 Subpart E
Test Procedure:	ANSI C63.10:2013, 789033 D02 General U-NII Test Procedures New Rules v02r01, 662911 D01 Multiple Transmitter Output v02r01
Test Result:	Pass
Prepared By:	
 <u>Kennys Zhang/Engineer</u>	
Date: Sep. 11, 2023 	
Reviewed By:	
 <u>Roger Li/Engineer</u>	
Date: Sep. 11, 2023	
Approved By:	
 <u>Talent Zhang/Engineer</u>	
Date: Sep. 11, 2023	

Note: The test results in this report apply exclusively to the tested model / sample. Without written approval of Guangzhou Jingce Testing Technology Co., Ltd. the test report shall not be reproduced except in full.

Report Revise Record

Report Version	Revise Time	Issued Date	Valid Version	Notes
V1.0	/	Sep. 11, 2023	Original Report	/

Table of Contents

1. Test Report Declare	5
2. Summary of test results	6
3. Test Laboratory	6
4. Equipment Under Test	7
4.1. Description of EUT	7
4.2. Channel List	7
4.3. Test Channel Configuration	9
4.4. Test Environment Conditions	9
4.5. The Worse Case Power Setting Parameter	9
4.6. Description of Available Antennas	11
5. Description of Test Setup	11
5.1. Accessory	11
5.2. Support Equipment	11
5.3. Test Setup	11
5.4. Setup Diagram for Tests	11
6. Measurement uncertainty	11
7. Measuring Instrument and Software Used	12
8. Duty Cycle	14
8.1. Block Diagram of Test Setup	14
8.2. Limits	14
8.3. Procedure	14
8.4. Results	14
8.5. Original Test Data	错误! 未定义书签。
9. 26dB Bandwidth, 6dB Bandwidth and 99% Bandwidth	15
9.1. Block Diagram of Test Setup	15
9.2. Limits	15
9.3. Test Procedure	15
9.4. Test Result	16
10. Maximum Output Power	17
10.1. Block Diagram of Test Setup	17
10.2. Limits	17
10.3. Test Procedure	17
10.4. Test Result	18
11. Power Spectral Density	19
11.1. Block Diagram of Test Setup	19
11.2. Limits	19
11.3. Test Procedure	20
11.4. Test Result	21
12. Frequency Stability Measurement	22
12.1. Block Diagram of Test Setup	22
12.2. Limit of Frequency Stability	22
12.3. Test Procedures	22
12.4. Test Result	22
13. Radiated Emission	23
13.1. Block Diagram of Test Setup	23
13.2. Limit	24
13.3. Test Procedure	26
13.4. Test Result	28
13.5. Original Test Data	28
14. AC Power Line Conducted Emissions	29
14.1. Block Diagram of Test Setup	29
14.2. Limits	29

14.3. Test Procedure	29
14.4. Test Result	30
15. Antenna Requirements	31
15.1. Applicable Requirements	31
15.2. Result	31
APPENDIX A - Radiated Emission Below 1GHz Test Data	32
APPENDIX B - Radiated Emission Above 1GHz Test Data	34

1. Test Report Declare

Applicant:	Sahara Presentation Systems Ltd
Address:	Europa House, Littlebrook DC1, Shield Road, Dartford, Kent DA1 5UR, United Kingdom
Manufacturer:	Sahara Presentation Systems Ltd
Address:	Europa House, Littlebrook DC1, Shield Road, Dartford, Kent DA1 5UR, United Kingdom
Product Name:	Clevershare Hub, CleverHub
Brand Name:	CLEVERTOUCH
Model Name:	Clevershare Hub, CleverHub
Difference Description:	The products with all the models covered in this report are the same as each other, except for different model name.

We Declare:

The equipment described above is tested by Guangzhou Jingce Testing Technology Co., Ltd. and in the configuration tested the equipment complied with the standards specified above. The test results are contained in this test report and Guangzhou Jingce Testing Technology Co., Ltd. is assumed of full responsibility for the accuracy and completeness of these tests.

2. Summary of test results

The EUT have been tested according to the applicable standards as referenced below.			
Clause	Description of Test Item	Standard	Verdict
1	6/26dB Bandwidth	FCC 15.407 (a)&(e)	Pass
2	99% Occupied Bandwidth	--	Pass
3	Maximum Conducted Output Power	FCC 15.407 (a)	Pass
4	Power Spectral Density	FCC 15.407 (a)	Pass
5	Frequency Stability Measurement	FCC 15.407 (g)	Pass
6	Radiated Band edge and Spurious Emission	FCC 15.407 (b) FCC 15.209 FCC 15.205	Pass
7	Power Line Conducted Emission	FCC 15.207	Pass
8	Antenna requirement	FCC 15.203	Pass
9	Dynamic Frequency Selection	FCC 15.407 (h)	NA

Note: This report only changes the antenna and the antenna type is the same on the basis of report DDT-R22112825-1E06 Because the antenna gain is larger, so only verify the worst case of Clause 6 from report DDT-R22112825-1E06.

3. Test Laboratory

Guangzhou Jingce Testing Technology Co., Ltd.

Add.: No.192, Kezhu Road, Huangpu District, Guangzhou, Guangdong, China

Association for Laboratory Accreditation(A2LA). Certificate Number: 6594.01

FCC Designation Number: CN1331. Test Firm Registration Number: 360543

IC Test Firm Registration Number: 28796

Conformity Assessment Body identifier: CN0138

4. Equipment Under Test

4.1. Description of EUT

EUT Name:	Clevershare Hub, CleverHub
Model Number:	CleverHub
EUT Function Description:	Please refer the user's manual.
Power Supply:	Input: 100-240V ~ 50/60Hz 1.0A Max
Radio Specification:	IEEE 802.11a/n/ac
Operation Frequency:	IEEE 802.11a: 5180MHz—5240MHz, 5745MHz—5825MHz IEEE 802.11n HT20: 5180MHz—5240MHz, 5745MHz—5825MHz IEEE 802.11n HT40: 5190MHz—5230MHz, 5755MHz—5795MHz IEEE 802.11ac VHT20: 5180MHz—5240MHz, 5745MHz—5825MHz IEEE 802.11ac VHT40: 5190MHz—5230MHz, 5755MHz—5795MHz IEEE 802.11ac VHT80: 5210MHz, 5775MHz
Modulation:	IEEE 802.11a: OFDM (64QAM, 16QAM, QPSK, BPSK) IEEE 802.11n HT20, HT40: OFDM (64QAM, 16QAM, QPSK, BPSK) IEEE 802.11ac (VHT20/40/80): OFDM (256QAM, 64QAM, 16QAM, QPSK, BPSK)
Data Rate:	IEEE 802.11a: 6, 9, 12, 18, 24, 36, 48, 54Mbps IEEE 802.11n HT20: 14.4, 28.9, 43.3, 57.8, 86.7, 115.6, 130, 144.4 Mbps IEEE 802.11n HT40: 30, 60, 90, 120, 180, 240, 270, 300 Mbps IEEE 802.11ac VHT20: 14.4, 28.9, 43.3, 57.8, 86.7, 115.6, 130, 144.4, 173.3 Mbps IEEE 802.11ac VHT40: 30, 60, 90, 120, 180, 240, 270, 300, 360, 400 Mbps IEEE 802.11ac VHT80: 65, 130, 195, 260, 390, 520, 585, 650, 780, 866.7 Mbps
Antenna Type:	FPC Antenna, MAX. Gain: 4.77 dBi

Note 1: EUT is the ab. of equipment under test.

Note 2: The antenna gain is declared by the customer and the laboratory is not responsible for the accuracy of the antenna gain.

4.2. Channel List

UNII-1 (For Bandwidth = 20 MHz)		UNII-1 (For Bandwidth = 40 MHz)	
Channel	Frequency (MHz)	Channel	Frequency (MHz)
36	5180	38	5190
40	5200	46	5230
44	5220	/	/
48	5240	/	/
UNII-1 (For Bandwidth = 80 MHz)			
Channel		Frequency (MHz)	
42		5210	
UNII-3 (For Bandwidth = 20 MHz)		UNII-3 (For Bandwidth = 40 MHz)	
Channel	Frequency (MHz)	Channel	Frequency (MHz)

149	5745	151	5755
153	5765	159	5795
157	5785	/	/
161	5805	/	/
165	5825	/	/
UNII-3 (For Bandwidth = 80 MHz)			
Channel		Frequency (MHz)	
155		5775	

4.3. Test Channel Configuration

Mode	Data rate (Mbps) (see Note)	Test Channel and Frequency
802.11a TX Mode	6	CH36, 5180
	6	CH44, 5220
	6	CH48, 5240
	6	CH149, 5745
	6	CH157, 5785
	6	CH165, 5825
802.11n HT20 TX Mode	MCS 0	CH36, 5180
	MCS 0	CH44, 5220
	MCS 0	CH48, 5240
	MCS 0	CH149, 5745
	MCS 0	CH157, 5785
	MCS 0	CH165, 5825
802.11n HT40 TX Mode	MCS 0	CH38, 5190
	MCS 0	CH46, 5230
	MCS 0	CH151, 5755
	MCS 0	CH159, 5795
802.11ac VHT20 TX Mode	MCS 0	CH36, 5180
	MCS 0	CH44, 5220
	MCS 0	CH48, 5240
	MCS 0	CH149, 5745
	MCS 0	CH157, 5785
	MCS 0	CH165, 5825
802.11ac VHT40 TX Mode	MCS 0	CH38, 5190
	MCS 0	CH46, 5230
	MCS 0	CH54, 5270
	MCS 0	CH151, 5755
	MCS 0	CH159, 5795
802.11ac VHT80 TX Mode	MCS 0	CH42, 5210
	MCS 0	CH155, 5775
RX Mode	MCS 0	/

4.4. Test Environment Conditions

During the measurement the environmental conditions were within the listed ranges:

Temperature range:	21-25 °C
Humidity range:	40-75%
Pressure range:	86-106 kPa

4.5. The Worst Case Power Setting Parameter

The Worst Case Power Setting Parameter				
Test Software	N/A			
Mode	Rate	Channel	Soft set value	
			Ant1	Ant2
802.11a	6 MHz	36	/	/
		44	/	/
		48	/	/
		149	/	/
		157	/	/
		165	/	/
802.11n HT20	MCS 0	36	/	/
		44	/	/
		48	/	/
		149	/	/
		157	/	/

		165	/	/
802.11n HT40	MCS 0	38	/	/
		46	/	/
		151	/	/
		159	/	/
		36	/	/
802.11ac VHT20	MCS 0	44	/	/
		48	/	/
		149	/	/
		157	/	/
		165	/	/
		38	/	/
802.11ac VHT40	MCS 0	46	/	/
		151	/	/
		159	/	/
		42	/	/
802.11ac VHT80	MCS 0	155	/	/

4.6. Description of Available Antennas

Test Mode	Transmit and Receive Mode	Description
802.11a	☒ 2TX, 2RX	ANT 1 and ANT2 can be used as transmitting/receiving antenna.
802.11n HT20	☒ 2TX, 2RX	ANT 1 and ANT2 can be used as transmitting/receiving antenna.
802.11n HT40	☒ 2TX, 2RX	ANT 1 and ANT2 can be used as transmitting/receiving antenna.
802.11ac VHT20	☒ 2TX, 2RX	ANT 1 and ANT2 can be used as transmitting/receiving antenna.
802.11ac VHT40	☒ 2TX, 2RX	ANT 1 and ANT2 can be used as transmitting/receiving antenna.
802.11ac VHT80	☒ 2TX, 2RX	ANT 1 and ANT2 can be used as transmitting/receiving antenna.

5. Description of Test Setup

5.1. Accessory

Description of Accessories	Manufacturer	Model Number	Description	Remark
Switching adapter	GangQi	GQ36-120300-Ax	Input: 100-240V 50/60Hz 1.0A Max Output: DC 12V3A 36.0W	/

5.2. Support Equipment

Equipment	Brand Name	Model Name	P/N
PC	Lenovo	T480	/

5.3. Test Setup

The EUT can work in Fixed Frequency mode.

5.4. Setup Diagram for Tests

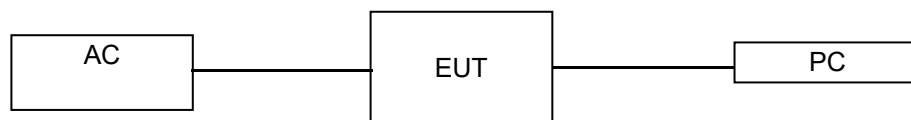

6. Measurement uncertainty

Test Item	Uncertainty
AC Power Conduction emission	1.37 dB
All Radiated emissions	5.4dB
Conducted emissions	3.09 dB
Occupied Channel Bandwidth	1.1%
Conducted Output power	0.82dB
Power Spectral Density	0.82dB

Note: This uncertainty represents an expanded uncertainty expressed at approximately the 95 % confidence level using a coverage factor of $k = 2$.

7. Measuring Instrument and Software Used

TS Test System						
Used	Equipment	Manufacturer	Model No.	Serial No.	Last Cal.	Due. Date
<input checked="" type="checkbox"/>	Spectrum Analyzer	Keysight	N9030B	MY563205 12	Jul. 10, 2023	Jul. 09, 2024
<input checked="" type="checkbox"/>	Vector Signal Generator	Keysight	N5182B	MY573003 34	Nov. 24, 2022	Nov. 23, 2023
<input checked="" type="checkbox"/>	Signal Generator	Keysight	N5171B	MY572806 39	Nov. 24, 2022	Nov. 23, 2023
<input checked="" type="checkbox"/>	DC POWER	Keysight	E342A	MY590203 56	Jul. 14, 2023	Jul. 13, 2024
<input checked="" type="checkbox"/>	Incubator thermometer	GWS	EL-02JA	21107288	Nov. 03, 2022	Nov. 02, 2023
<input checked="" type="checkbox"/>	Control unit(Power sensor)	Tonscend	JS0806-2	/	Jul. 10, 2023	Jul. 09, 2024
<input checked="" type="checkbox"/>	Wideband radio communication tester	R&S	CMW500	163478	Jul. 11, 2023	Jul. 10, 2024
<input checked="" type="checkbox"/>	Spectrum Analyzer	Keysight	N9020B	MY601122 06	Nov. 24, 2022	Nov. 23, 2023
<input checked="" type="checkbox"/>	Control unit(Power sensor)	Tonscend	JS0806-2	21H806046 5	Nov. 25, 2022	Nov. 24, 2023
Software						
Used	Description	Manufacturer	Name		Version	
<input checked="" type="checkbox"/>	Test software	TS+	JS1120-3		V3.3.10	
RSE Test System						
Used	Equipment	Manufacturer	Model No.	Serial No.	Last Cal.	Due. Date
<input checked="" type="checkbox"/>	EMI Receiver	R&S	ESW	101685	Jul. 12, 2023	Jul. 11, 2024
<input checked="" type="checkbox"/>	Bilog Antenna	Schwarzbeck	VULB 9163	01416	Mar. 21, 2023	Mar. 20, 2024
<input checked="" type="checkbox"/>	Horn Antenna 1	Schwarzbeck	BBHA 9120 D	01673	Nov. 23, 2022	Nov. 22, 2023
<input checked="" type="checkbox"/>	Horn Antenna 2	ETS	3116C	00217677	Sep. 19, 2022	Sep. 18, 2023
<input checked="" type="checkbox"/>	Signal Pre-Amplifier	Tonscend	TAP01018050	AP21C806 122	Jul. 10, 2023	Jul. 09, 2024
<input checked="" type="checkbox"/>	Signal Pre-Amplifier	Tonscend	TAP9K3G32	AP20K8061 04	Jul. 10, 2023	Jul. 09, 2024
<input checked="" type="checkbox"/>	Signal Pre-Amplifier	ETS	3116C-PA	00217677	Aug. 21, 2023	Aug. 20, 2023
<input checked="" type="checkbox"/>	3m Fully-anechoic Chamber	ETS	RFD-100	/	Apr. 24, 2021	Apr. 23, 2024
Software						
Used	Description	Manufacturer	Name		Version	
<input checked="" type="checkbox"/>	Test software	TS+	TS+		V3.0.0.4	
Conducted Emission Test For AC Power Port						
Used	Equipment	Manufacturer	Model No.	Serial No.	Last Cal.	Due. Date
<input checked="" type="checkbox"/>	LISN	R&S	ENV216	102154	Jul. 10, 2023	Jul. 09, 2024
<input checked="" type="checkbox"/>	EMI Receiver	R&S	ESR3	102509	Jul. 12, 2023	Jul. 11, 2024
Software						

Used	Description	Manufacturer	Name		Version	
<input checked="" type="checkbox"/>	Test software	EZ	EZ-EMC		EMEC-3A1	
Other Instrument						
Used	Equipment	Manufacturer	Model No.	Serial No.	Last Cal.	Due. Date
<input checked="" type="checkbox"/>	Temperature & Humidity	Temperature	HTC-1	/	Nov. 25, 2022	Nov. 24, 2023

8. Duty Cycle

8.1. Block Diagram of Test Setup

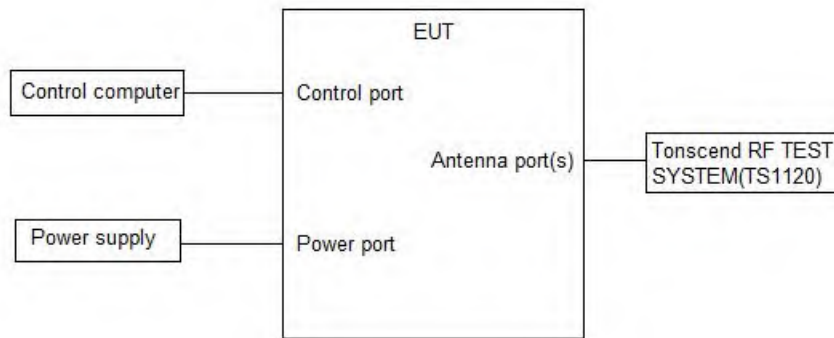

8.2. Limits

None; for reporting purposes only.

8.3. Procedure

Refer to KdB 789033 D02 General U-NII Test Procedures New Rules v02r01 section II.B.

The zero-span mode on a spectrum analyzer or EMI receiver, if the response time and spacing between bins on the sweep are sufficient to permit accurate measurements of the on and off times of the transmitted signal.

Set the center frequency of the instrument to the center frequency of the transmission.

Set $RBW \geq EBW$ if possible; otherwise,

set RBW to the largest available value. Set $VBW \geq RBW$.

Set detector = peak or average. The zero-span measurement method shall not be used unless both RBW and VBW are $> 50/T$, where T is defined in II.B.1.a), and the number of sweep points across duration T exceeds 100. (For example, if VBW and/or RBW are limited to 3 MHz, then the zero-span method of measuring duty cycle shall not be used if $T \leq 16.7$ microseconds.)

8.4. Results

Reference report DDT-R2212825-1E06

9. 26dB Bandwidth, 6dB Bandwidth and 99% Bandwidth

9.1. Block Diagram of Test Setup

Same as section 8.1

9.2. Limits

FCC Part15, Subpart E		
Test Item	Limit	Frequency Range (MHz)
Bandwidth	26 dB Bandwidth	5150 - 5250
	26 dB Bandwidth	5250 - 5350
	26 dB Bandwidth	For FCC: 5470 - 5725 For IC: 5470 - 5600 5650 - 5725
	Minimum 500 kHz 6 dB Bandwidth	5725 - 5850
	For reporting purposes only.	For IC: 5150 ~ 5825

9.3. Test Procedure

(1) Connect EUT's antenna output to spectrum analyzer by RF cable.

Center Frequency	The centre frequency of the channel under test
Detector	Peak
RBW	For 6 dB Bandwidth: RBW=100 kHz For 26 dB Bandwidth: approximately 1% of the emission bandwidth. For 99 % Occupied Bandwidth: approximately 1 % ~ 5 % of the OBW.
VBW	For 6 dB Bandwidth: VBW=300 kHz For 26 dB Bandwidth: >3*RBW For 99 % Bandwidth: >3*RBW
Trace	Max hold
Sweep	Auto couple

(2) Allow the trace to stabilize, measure the maximum width of the emission that is constrained by the frequencies associated with the two outermost amplitude points (upper and lower frequencies) that are attenuated by 26 dB and 6 dB relative to the maximum level measured in the fundamental emission.

(3) Use the 99 % power bandwidth function of the instrument, allow the trace to stabilize and report the measured bandwidth.

9.4. Test Result

Reference report DDT-R2212825-1E06

10. Maximum Output Power

10.1. Block Diagram of Test Setup

Same as section 8.1

10.2. Limits

FCC Part15, Subpart E		
Test Item	Limit	Frequency Range (MHz)
Conducted Output Power	<input type="checkbox"/> Outdoor Access Point: 1 W (30 dBm)	5150-5250
	<input type="checkbox"/> Indoor Access Point: 1 W (30 dBm)	
	<input type="checkbox"/> Fixed Point-To-Point Access Points: 1 W (30 dBm)	
	<input checked="" type="checkbox"/> Client Devices: 250 mW (24 dBm)	
	Shall not exceed the lesser of 250 mW (24dBm) or 11 dBm + 10 log B, where B is the 26 dB emission bandwidth in megahertz.	5250-5350 5470-5725
	Shall not exceed 1 Watt (30 dBm).	5725-5850
Note: For 802.11n and 802.11ac, the EUT incorporates a MIMO function. The Antenna directional gain is 4.77 dBi.		

Note: The above limits are based upon the maximum antenna gain does not exceed 6 dBi. If transmitting antennas of directional gain greater than 6 dBi are used, the maximum conducted output power shall be reduced by the amount in dB that the directional gain of the antenna exceeds 6 dBi.

10.3. Test Procedure

- (1) Connect each EUT's antenna output to power meter by RF cable and attenuator
- (2) Add each antenna port's results to get the total output power of EUT.

10.4. Test Result

Reference report DDT-R2212825-1E06

11. Power Spectral Density

11.1. Block Diagram of Test Setup

Same as section 8.1

11.2. Limits

CFR 47 FCC Part15, Subpart E		
Test Item	Limit	Frequency Range (MHz)
Power Spectral Density	<input type="checkbox"/> Outdoor Access Point: 17 dBm/MHz <input type="checkbox"/> Indoor Access Point: 17 dBm/MHz <input type="checkbox"/> Fixed Point-To-Point Access Points: 17 dBm/MHz <input type="checkbox"/> Client Devices: 11 dBm/MHz	5150-5250
	11 dBm/MHz	5250-5350 5470-5725
	30 dBm/500 kHz	5725-5850
Note: For 802.11n and 802.11ac, the EUT incorporates a MIMO function. The Antenna directional gain is 4.77 dBi.		

Note: The above limits are based upon the maximum antenna gain does not exceed 6 dBi. If transmitting antennas of directional gain greater than 6 dBi are used, the maximum conducted output power shall be reduced by the amount in dB that the directional gain of the antenna exceeds 6 dBi.

11.3. Test Procedure

The transmitter output was connected to a spectrum analyzer. Power density was measured by spectrum analyzer with 1MHz RBW and 3MHz VBW.

Connect the UUT to the spectrum analyzer and use the following settings:

5150 MHz~5250 MHz, 5250 MHz~5350 MHz, 5470 MHz~5725 MHz

Center Frequency	The centre frequency of the channel under test
Detector	RMS
RBW	1MHz
VBW	$\geq 3 \times \text{RBW}$
Span	Encompass the entire emissions bandwidth (EBW) of the signal
Trace	Max hold
Sweep time	Auto

5725 MHz-5850 MHz

Center Frequency	The centre frequency of the channel under test
Detector	RMS
RBW	500 kHz
VBW	$\geq 3 \times \text{RBW}$
Span	Encompass the entire emissions bandwidth (EBW) of the signal
Trace	Max hold
Sweep time	Auto

Note:

1. For UNII-3, according to KdB publication 789033 D02 General U-NII Test Procedures New Rules v02r01, section II.F.5., it is acceptable to set RBW at 1 MHz and VBW at 3 MHz if the spectrum analyzer does not have 500 kHz RBW.

2. The value measured with RBW=1MHz is to be added with $10\log(500\text{kHz}/1\text{MHz})$ which is - 3dB. For example, if the measured value is +30 dBm using RBW=500kHz (that is +30 dBm/500kHz), then the converted value will be +33 dBm/1MHz.

3. Allow trace to fully stabilize and use the peak marker function to determine the maximum amplitude level within the RBW.

11.4. Test Result

Reference report DDT-R2212825-1E06

12. Frequency Stability Measurement

12.1. Block Diagram of Test Setup

Same as section 8.1

12.2. Limit of Frequency Stability

Manufacturers of U-NII devices are responsible for ensuring frequency stability such that an emission is maintained within the band of operation under all conditions of normal operation as specified in the user's manual.

12.3. Test Procedures

(1) To ensure emission at the band edge is maintained within the authorized band, those values shall be measured by radiation emissions at upper and lower frequency points, and finally compensated by frequency deviation as procedures below.

(2) The EUT was operated at the maximum output power, and connected to the spectrum analyzer, which is set to maximum hold function and peak detector. The peak value of the power envelope was measured and noted. The upper and lower frequency points were respectively measured relatively 10 dB lower than the measured peak value.

(3) The frequency deviation was calculated by adding the upper frequency point and the lower frequency point divided by two. Those detailed values of frequency deviation are provided in table below.

12.4. Test Result

Reference report DDT-R2212825-1E06

13. Radiated Emission

13.1. Block Diagram of Test Setup

In 3 m Anechoic Chamber, test setup diagram for 9 kHz - 30 MHz:

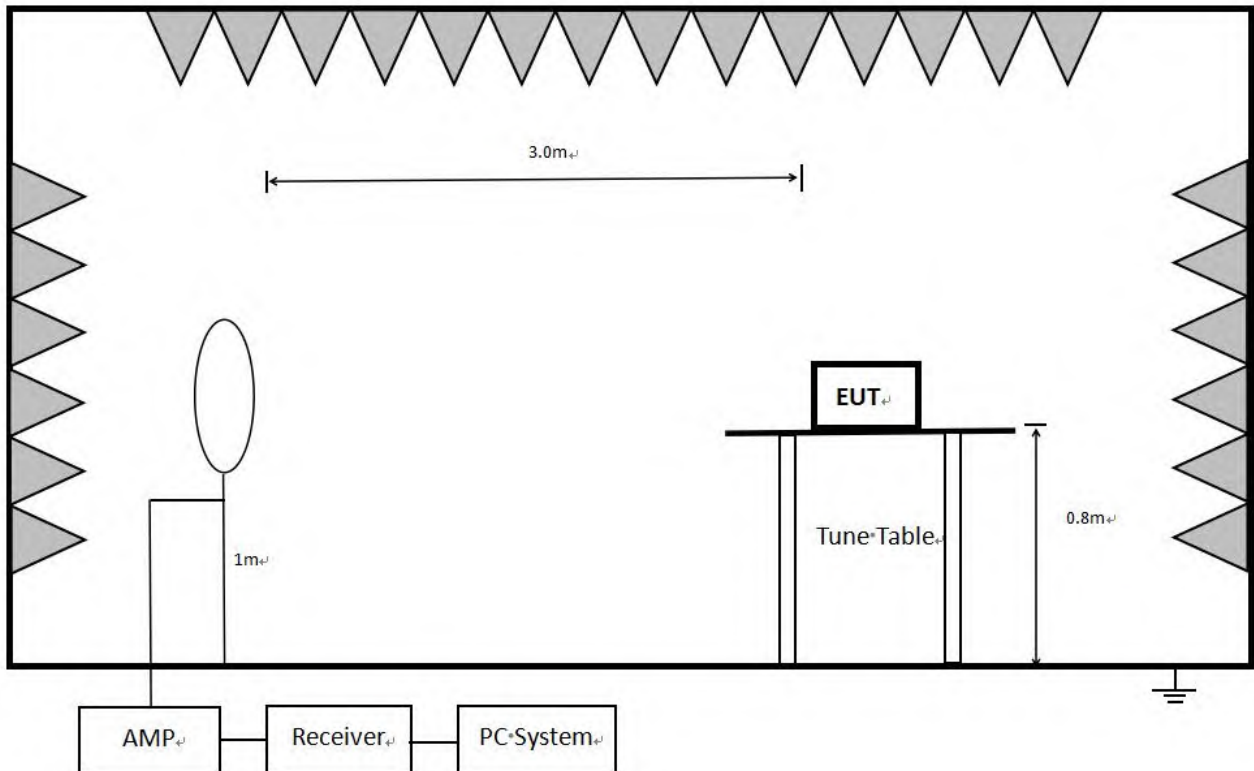

In 3 m Anechoic Chamber, test setup diagram for 30 MHz - 1 GHz:

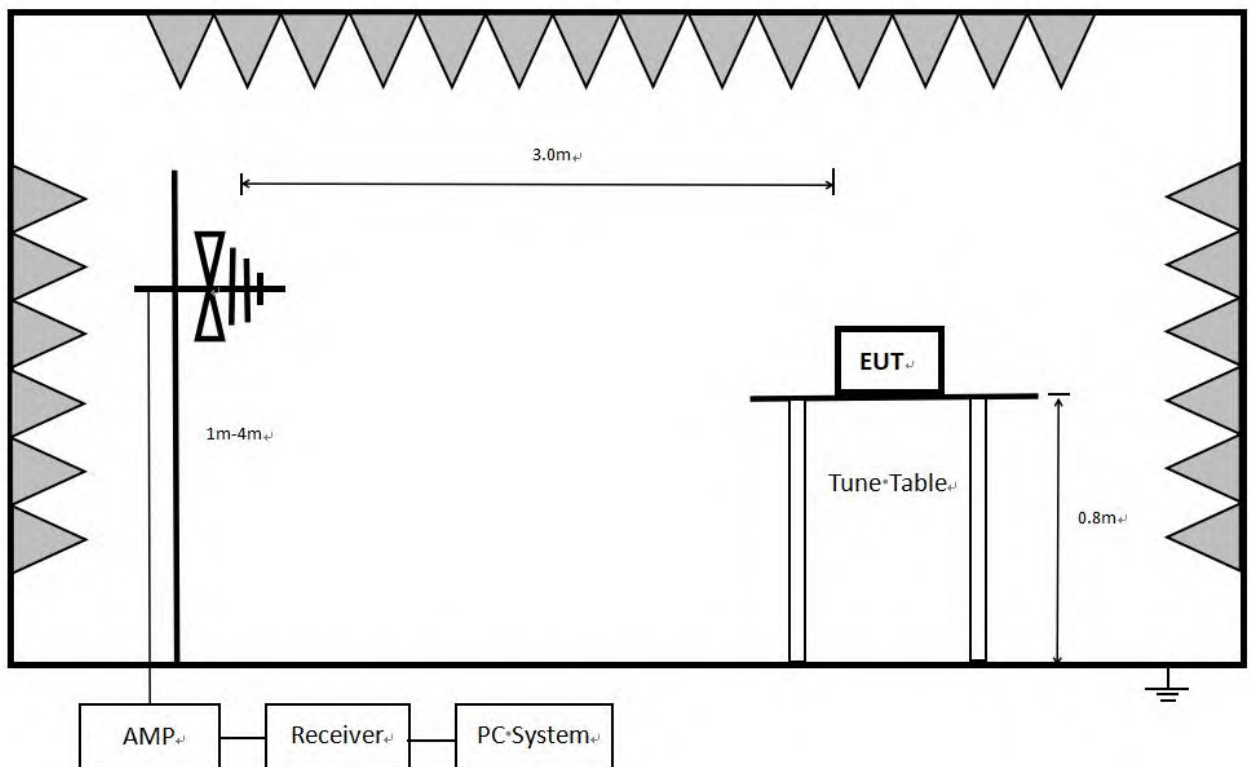

In 3 m Anechoic Chamber, test setup diagram for frequency above 1 GHz:

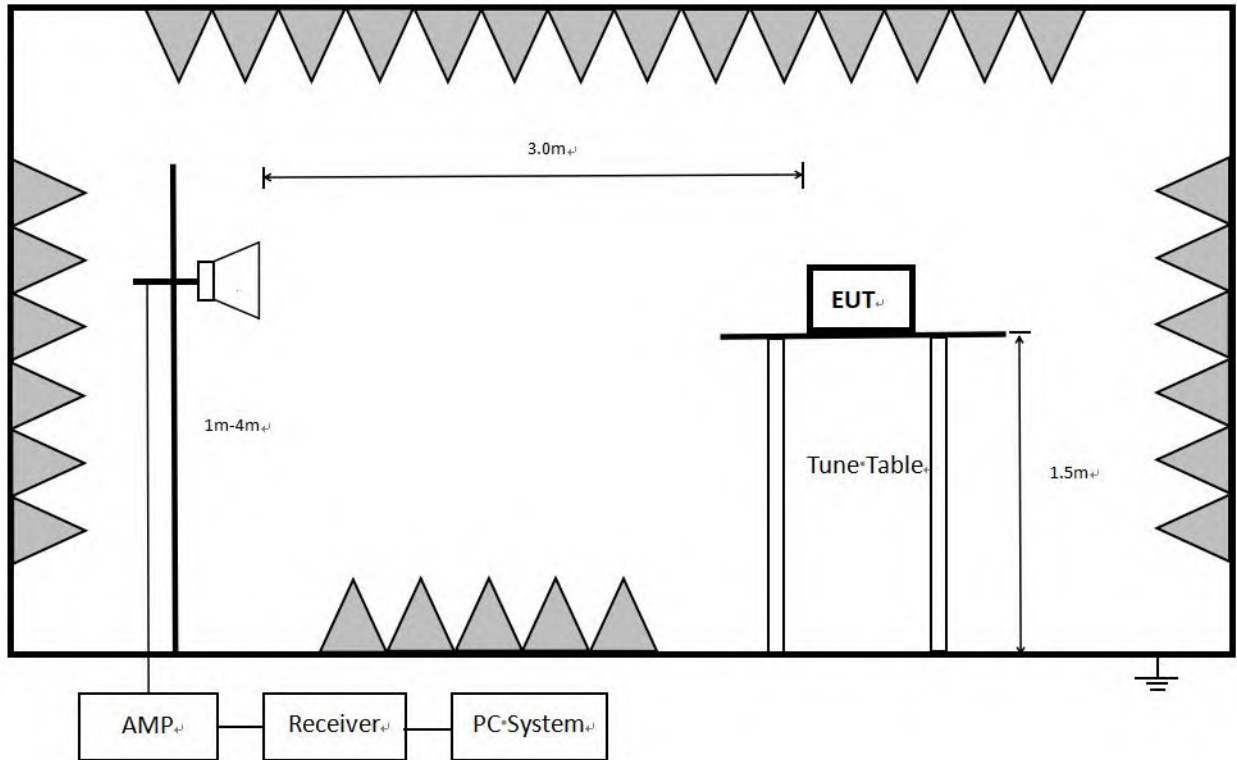

Note: For harmonic emissions test an appropriate high pass filter was inserted in the input port of AMP.

13.2. Limit

(1) FCC 15.205 Restricted frequency band

MHz	MHz	MHz	GHz
0.090-0.110	16.42-16.423	399.9-410	4.5-5.15
¹ 0.495-0.505	16.69475-16.69525	608-614	5.35-5.46
2.1735-2.1905	16.80425-16.80475	960-1240	7.25-7.75
4.125-4.128	25.5-25.67	1300-1427	8.025-8.5
4.1772&4.17775	37.5-38.25	1435-1626.5	9.0-9.2
4.2072&4.20775	73-74.6	1645.5-1646.5	9.3-9.5
6.215-6.218	74.8-75.2	1660-1710	10.6-12.7
6.26775-6.26825	108-121.94	1718.8-1722.2	13.25-13.4
6.31175-6.31225	123-138	2200-2300	14.47-14.5
8.291-8.294	149.9-150.05	2310-2390	15.35-16.2
8.362-8.366	156.52475-156.52525	2483.5-2500	17.7-21.4
8.37625-8.38675	156.7-156.9	2690-2900	22.01-23.12
8.41425-8.41475	162.0125-167.17	3260-3267	23.6-24.0
12.29-12.293	167.72-173.2	3332-3339	31.2-31.8
12.51975-12.52025	240-285	3345.8-3358	36.43-36.5
12.57675-12.57725	322-335.4	3600-4400	(²)
13.36-13.41			

¹Until February 1, 1999, this restricted band shall be 0.490-0.510 MHz.

²Above 38.6

(2) FCC 15.209 Limit.

Frequency MHz	Distance Meters	Field strengths limit	
		$\mu\text{V}/\text{m}$	$\text{dB}(\mu\text{V})/\text{m}$
0.009 ~ 0.490	300	$2400/F(\text{kHz})$	$67.6-20\log(F)$
0.490 ~ 1.705	30	$24000/F(\text{kHz})$	$87.6-20\log(F)$
1.705 ~ 30.0	30	30	29.54
30 ~ 88	3	100	40.0
88 ~ 216	3	150	43.5
216 ~ 960	3	200	46.0
960 ~ 1000	3	500	54.0
Above 1000	3	74.0 $\text{dB}(\mu\text{V})/\text{m}$ (Peak) 54.0 $\text{dB}(\mu\text{V})/\text{m}$ (Average)	

(1) For transmitters operating in the 5.15-5.25 GHz band: All emissions outside of the 5.15-5.35 GHz band shall not exceed an e.i.r.p. of -27 dBm / MHz.

(2) For transmitters operating in the 5.25-5.35 GHz band: All emissions outside of the 5.15-5.35 GHz band shall not exceed an e.i.r.p. of -27 dBm / MHz.

(3) For transmitters operating in the 5.47-5.725 GHz band: All emissions outside of the 5.47-5.725 GHz band shall not exceed an e.i.r.p. of -27 dBm / MHz.

(4) For transmitters operating in the 5.725-5.85 GHz band: All emissions within the frequency range from the band edge to 10 MHz above or below the band edge shall not exceed an e.i.r.p. of -17 dBm/MHz; for frequencies 10 MHz or greater above or below the band edge, emissions shall not exceed an e.i.r.p. of -27 dBm / MHz.

(5) Unwanted emissions below 1 GHz must comply with the general field strength limits set forth in §15.209. Further, any U-NII devices using an AC power line are required to comply also with the conducted limits set forth in §15.207.

(6) The provisions of §15.205 apply to intentional radiators operating under this section.

-27 dBm/MHz Limit= $95.2+\text{EIRP (dBm)}=95.2-27=68.2$ dB $\mu\text{V}/\text{m}$

Note:

(1) The emission limits shown in the above table are based on measurements employing a CISPR QP detector except for the frequency bands 9-90kHz, 110-490kHz and above 1000MHz. Radiated emissions limits in these three bands are based on measurements employing an average detector.

(2) At frequencies below 30MHz, measurement may be performed at a distance closer than that specified, and the limit at closer measurement distance can be extrapolated by below formula:

$$\text{Limit}_{3\text{m}}(\text{dBuV}/\text{m}) = \text{Limit}_{30\text{m}}(\text{dBuV}/\text{m}) + 40\text{Log}(30\text{m}/3\text{m})$$

(3) Limit for this EUT

All the emissions appearing within 15.205 restricted frequency bands shall not exceed the limits shown in 15.209, all the other emissions shall be at least 20dB below the fundamental emissions or comply with 15.209 limits.

13.3. Test Procedure

Below 30 MHz:

The setting of the spectrum Analyzer

RBW	200 Hz (From 9 kHz to 0.15 MHz)/ 9 kHz (From 0.15 MHz to 30 MHz)
VBW	200 Hz (From 9 kHz to 0.15 MHz)/ 9 kHz (From 0.15 MHz to 30 MHz)
Sweep	Auto
Trace	Max hold

1. The testing follows the guidelines in ANSI C63.10-2013
2. The EUT was arranged to its worst case and then turntable (from 0 degree to 360 degrees) to find the maximum reading. A pre-amp and a high pass filter are used for the test in order to get better signal level. Both Horizontal, Face-on and Face-off polarizations of the antenna are set to make the measurement.
3. The EUT was placed on a turntable with 80 cm meter above ground.
4. The EUT was set 3 meters from the interference receiving antenna, which was mounted on the top of 1 meter height antenna tower.
5. The radiated emission limits are based on measurements employing a CISPR quasi-peak detector except for the frequency bands 9-90 kHz, 110-490 kHz and above 1000 MHz. Radiated emission limits in these three bands are based on measurements employing an average detector.
6. For measurement below 1 GHz, the initial step in collecting conducted emission data is a spectrum analyzer peak detector mode pre-scanning the measurement frequency range. Significant peaks are then marked and then Quasi Peak detector mode re-measured. If the emission level of the EUT measured by the peak detector is 3 dB lower than the applicable limit, the peak emission level will be reported. Otherwise, the emission measurement will be repeated using the quasi-peak detector and reported.
7. Although these tests were performed other than open field site, adequate comparison measurements were confirmed against 30m open field site. Therefore, sufficient tests were made to demonstrate that the alternative site produces results that correlate with the ones of tests made in an open field site based on KdB 414788.

Below 1 GHz and above 30 MHz:

The setting of the spectrum Analyzer

RBW	120 kHz
VBW	300 kHz
Sweep	Auto
Trace	Max hold

1. The testing follows the guidelines in ANSI C63.10-2013.

2. The EUT was arranged to its worst case and then tune the antenna tower (from 1 m to 4 m) and turntable (from 0 degree to 360 degrees) to find the maximum reading. A pre-amp and a high pass filter are used for the test in order to get better signal level. Both horizontal and vertical polarizations of the antenna are set to make the measurement.

3. The EUT was placed on a turntable with 80 cm above ground.

4. The EUT was set 3 meters from the interference receiving antenna, which was mounted on the top of a variable height antenna tower.

5. For measurement below 1GHz, the initial step in collecting conducted emission data is a spectrum analyzer peak detector mode pre-scanning the measurement frequency range. Significant peaks are then marked and then Quasi Peak detector mode re-measured. If the emission level of the EUT measured by the peak detector is 3 dB lower than the applicable limit, the peak emission level will be reported. Otherwise, the emission measurement will be repeated using the quasi-peak detector and reported.

Above 1 GHz:

RBW	1 MHz
VBW	PEAK: 3 MHz AVG: see note 6
Sweep	Auto
Detector	Peak
Trace	Max hold

1. The testing follows the guidelines in ANSI C63.10-2013.

2. The EUT was arranged to its worst case and then tune the antenna tower (from 1 m to 4 m) and turntable (from 0 degree to 360 degrees) to find the maximum reading. A pre-amp and a high pass filter are used for the test in order to get better signal level. Both horizontal and vertical polarizations of the antenna are set to make the measurement.

3. The EUT was placed on a turntable with 1.5m above ground.

4. The EUT was set 3 meters from the interference receiving antenna, which was mounted on the top of a variable height antenna tower.

5. For measurement above 1GHz, the emission measurement will be measured by the peak detector. This peak level, once corrected, must comply with the limit specified in Section 15.209.

6. For measurements above 1 GHz the resolution bandwidth is set to 1 MHz, then the video bandwidth is set to 3 MHz for peak measurements and 1 MHz resolution bandwidth with 1/T video bandwidth with peak detector for AVG measurements. For the Duty Cycle please refer to clause 8.1.ON TIME AND DUTY CYCLE.

7. Restriction band: Investigated frequency range from 5.15-5.25 GHz, 5250-5350 GHz, 5470-5725 GHz, 5.725-5.85 GHz.

All restriction band should comply with 15.209, other emission should be at least 20 dB below the fundamental.

Note 1: For all radiated test, EUT in each of three orthogonal axis emissions had been tested, but only the worst case (X axis) data recorded in the report.

Note 2: The EUT does not support simultaneous transmission.

Note 3: The EUT was fully exercised with external accessories during the test. In the case of multiple accessory external ports, an external accessory shall be connected to one of each type of port.

13.4. Test Result

PASS. (Only test the worst case from DDT-R2212825-1E06)

13.5. Original Test Data

Below 1 GHz and above 30 MHz test data Refer to appendix A

Above 1 GHz test data Refer to appendix B

14. AC Power Line Conducted Emissions

14.1. Block Diagram of Test Setup

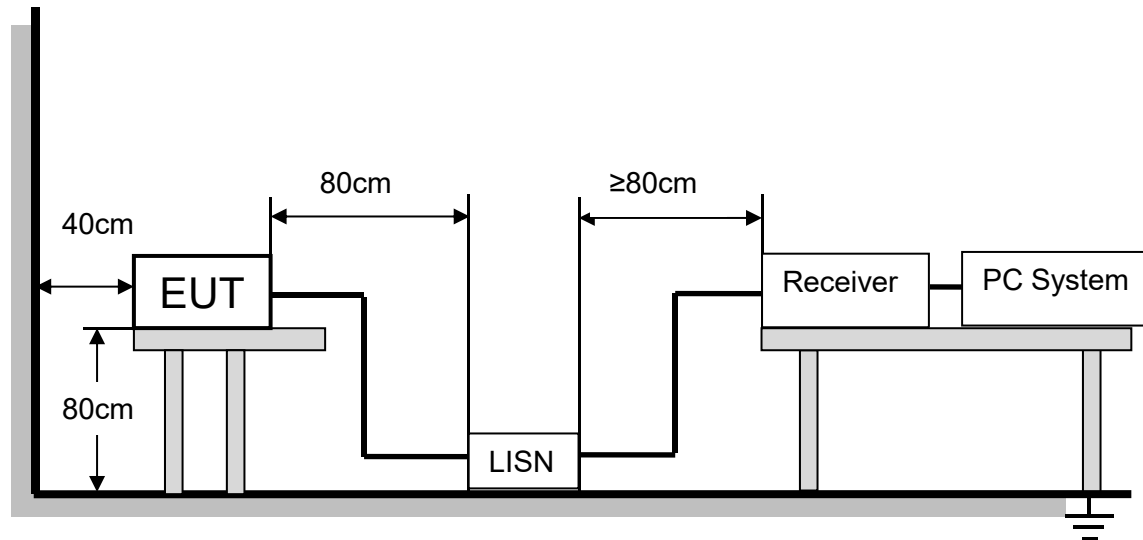

The EUT is put on a table of non-conducting material that is 80 cm high. The vertical conducting wall of shielding is located 40 cm to the rear of the EUT. The power line of the EUT is connected to the AC mains through an Artificial Mains Network (A.M.N.). A EMI Measurement Receiver (R&S Test Receiver ESR3) is used to test the emissions from both sides of AC line. According to the requirements in Section 6.2 of ANSI C63.10-2013. Conducted emissions from the EUT measured in the frequency range between 0.15 MHz and 30 MHz using CISPR Quasi-Peak and average detector mode. The bandwidth of EMI test receiver is set at 9 kHz.

The arrangement of the equipment is installed to meet the standards and operating in a manner, which tends to maximize its emission characteristics in a normal application.

14.2. Limits

Please refer to CFR 47 FCC §15.207 (a).

Frequency (MHz)	Quasi-peak	Average
0.15 - 0.5	66 - 56 *	56 - 46 *
0.50 - 5.0	56.00	46.00
5.0 - 30.0	60.00	50.00

Note 1: * Decreasing linearly with logarithm of frequency.

Note 2: The lower limit shall apply at the transition frequencies.

14.3. Test Procedure

The EUT and Support equipment, if needed, were put placed on a non-metallic table, 80cm above the ground plane.

Configuration EUT to simulate typical usage as described in clause 2.4 and test equipment as described in clause 10.2 of this report.

All I/O cables were positioned to simulate typical actual usage as per ANSI C63.10.

All support equipment power received from a second LISN.

Emissions were measured on each current carrying line of the EUT using an EMI Test Receiver connected to the LISN powering the EUT.

The Receiver scanned from 150 kHz to 30 MHz for emissions in each of the test modes.

During the above scans, the emissions were maximized by cable manipulation.

The test mode(s) described in clause 2.4 were scanned during the preliminary test.

After the preliminary scan, we found the test mode producing the highest emission level.

The EUT configuration and worse cable configuration of the above highest emission levels were recorded for reference of the final test.

EUT and support equipment were set up on the test bench as per the configuration with highest emission level in the preliminary test.

A scan was taken on both power lines, Neutral and Line, recording at least the six highest emissions.

Emission frequency and amplitude were recorded into a computer in which correction factors were used to calculate the emission level and compare reading to the applicable limit.

The test data of the worst-case condition(s) was recorded.

The bandwidth of test receiver is set at 9 kHz.

14.4. Test Result

Reference report DDT-R2212825-1E06

15. Antenna Requirements

15.1. Applicable Requirements

Please refer to FCC §15.203

An intentional radiator shall be designed to ensure that no antenna other than that furnished by the responsible party shall be used with the device. The use of a permanently attached antenna or of an antenna that uses a unique coupling to the intentional radiator shall be considered sufficient to comply with the provisions of this section. The manufacturer may design the unit so that a broken antenna can be replaced by the user, but the use of a standard antenna jack or electrical connector is prohibited.

Please refer to FCC §15.247(b)(4)

The conducted output power limit specified in paragraph (b) of this section is based on the use of antennas with directional gains that do not exceed 6 dBi. Except as shown in paragraph (c) of this section, if transmitting antennas of directional gain greater than 6 dBi are used, the conducted output power from the intentional radiator shall be reduced below the stated values in paragraphs (b)(1), (b)(2), and (b)(3) of this section, as appropriate, by the amount in dB that the directional gain of the antenna exceeds 6 dBi.

15.2. Result

The device support 2T2R MIMO, the antennas both used for this product are dedicated FPC antennas and other than that furnished by the responsible party shall be used with the device, maximum antenna gain is 4.77 dBi.

APPENDIX A - Radiated Emission Below 1GHz Test Data Test Report

Project Information			
EUT:	Clevershare Hub Clever Hub	Environment:	24.1°C/46%
Model:	CleverHub	SN:	
Mode:	11AC20_5200	Voltage:	120V 60Hz
Customer:		Engineer:	Roger
Remark:			
Test Standard:			

Start of Test: 2023-05-07 16:45:29

Test Graph

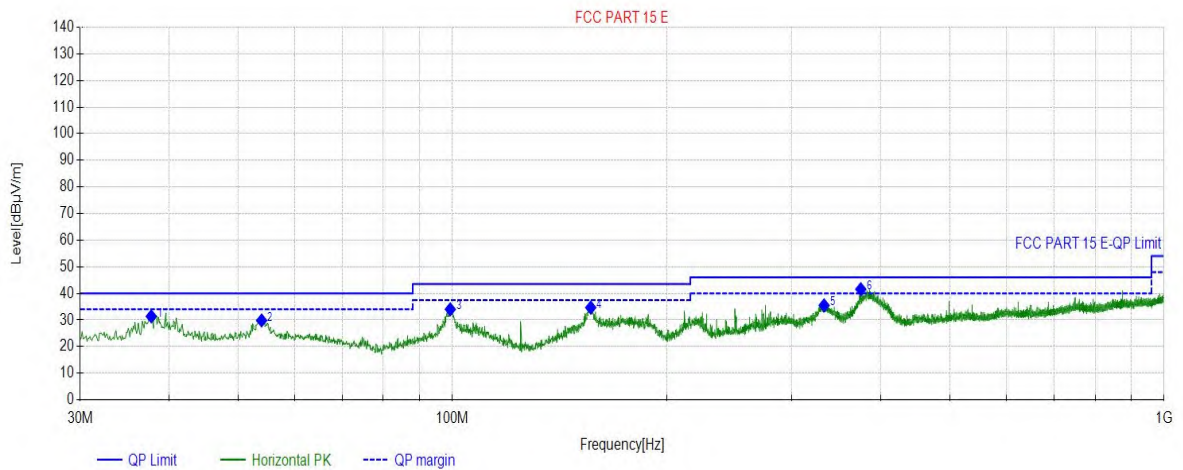

Final Data List								
NO.	Freq. (MHz)	Factor (dB)	QP Value (dBµV/m)	QP Limit (dBµV/m)	QP Margin (dB)	Height (cm)	Angle (°)	Polarity
1	37.7608	20.35	31.39	40.00	8.61	100	358	Horizontal
2	53.9614	22.01	29.85	40.00	10.15	100	75	Horizontal
3	99.3619	20.64	34.03	43.50	9.47	100	42	Horizontal
4	156.500	17.53	34.67	43.50	8.83	100	172	Horizontal
5	332.961	23.55	35.50	46.00	10.50	100	353	Horizontal
6	374.966	25.02	41.56	46.00	4.44	100	0	Horizontal

Test Report

Project Information			
EUT:	Clevershare Hub Clever Hub	Environment:	24.1°C/46%
Model:	CleverHub	SN:	
Mode:	11AC20_5200	Voltage:	120V 60Hz
Customer:		Engineer:	Roger
Remark:			
Test Standard:			

Start of Test: 2023-05-07 16:55:48

Test Graph

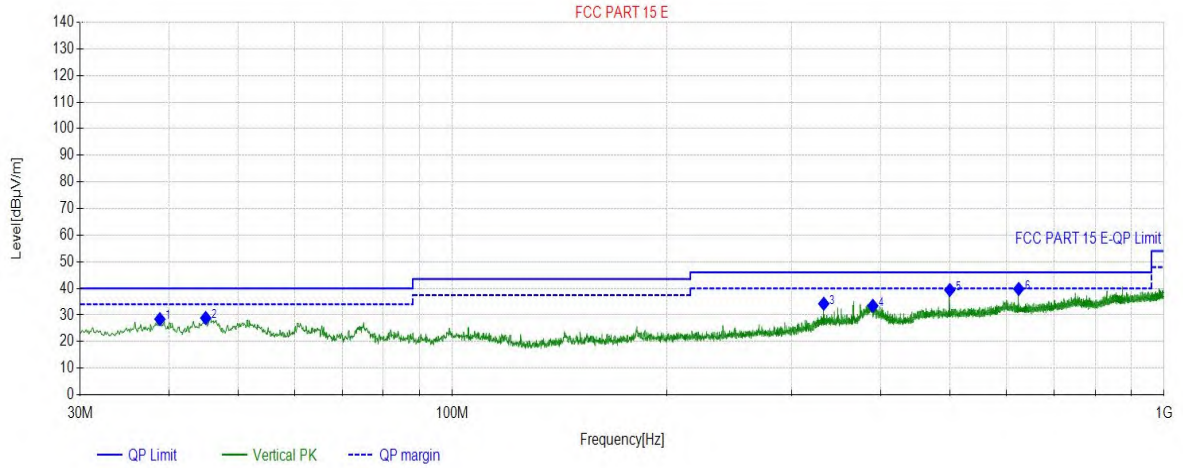

Final Data List								
NO.	Freq. (MHz)	Factor (dB)	QP Value (dBµV/m)	QP Limit (dBµV/m)	QP Margin (dB)	Height (cm)	Angle (°)	Polarity
1	38.8279	20.53	28.45	40.00	11.55	100	307	Vertical
2	45.0365	21.61	28.87	40.00	11.13	100	264	Vertical
3	332.573	23.53	34.25	46.00	11.75	100	43	Vertical
4	389.809	25.38	33.47	46.00	12.53	100	11	Vertical
5	500.012	27.60	39.41	46.00	6.59	100	357	Vertical
6	624.960	30.29	39.81	46.00	6.19	100	34	Vertical

APPENDIX B - Radiated Emission Above 1GHz Test Data Test Report

Project Information			
EUT:	Clevershare Hub Clever Hub	Environment:	24.1°C/46%
Model:	CleverHub	SN:	
Mode:	11AC20_5200	Voltage:	120V 60Hz
Customer:		Engineer:	Roger
Remark:			

Start of Test: 2023-05-07 15:43:21

Test Graph

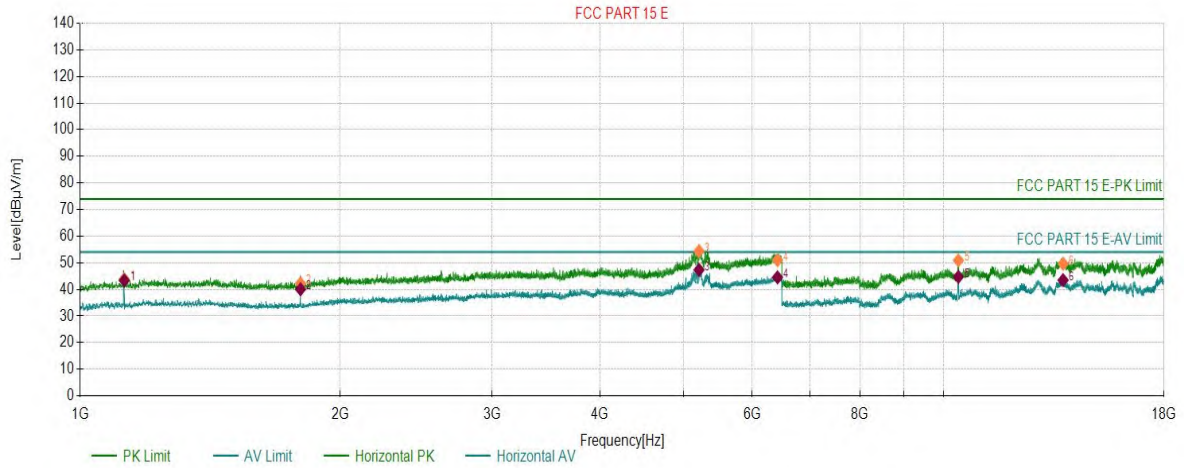

PK Final Data List								
NO.	Freq. (MHz)	Factor (dB)	PK Value (dBµV/m)	PK Limit (dBµV/m)	PK Margin (dB)	Height (cm)	Angle (°)	Polarity
1	1124.8625	1.58	43.84	74.00	30.16	150	99	Horizontal
2	1799.7800	3.42	42.24	74.00	31.76	150	317	Horizontal
3	5207.9208	20.77	54.40	74.00	19.60	150	93	Horizontal
4	6420.7921	21.83	50.99	74.00	23.01	150	135	Horizontal
5	10401.1901	4.01	50.92	74.00	23.08	150	154	Horizontal
6	13752.6253	11.32	49.63	74.00	24.37	150	4	Horizontal

AV Final Data List								
NO.	Freq. (MHz)	Factor (dB)	AV Value (dBµV/m)	AV Limit (dBµV/m)	AV Margin (dB)	Height (cm)	Angle (°)	Polarity
1	1124.8625	1.58	43.36	54.00	10.64	150	99	Horizontal
2	1799.7800	3.42	40.06	54.00	13.94	150	317	Horizontal
3	5207.9208	20.77	47.33	54.00	6.67	150	93	Horizontal
4	6420.7921	21.83	44.53	54.00	9.47	150	135	Horizontal
5	10401.1901	4.01	44.73	54.00	9.27	150	154	Horizontal
6	13752.6253	11.32	43.47	54.00	10.53	150	4	Horizontal

Test Report

Project Information			
EUT:	Clevershare Hub Clever Hub	Environment:	24.1°C/46%
Model:	CleverHub	SN:	
Mode:	11AC20_5200	Voltage:	120V 60Hz
Customer:		Engineer:	Roger
Remark:			

Start of Test: 2023-05-07 15:44:57

Test Graph

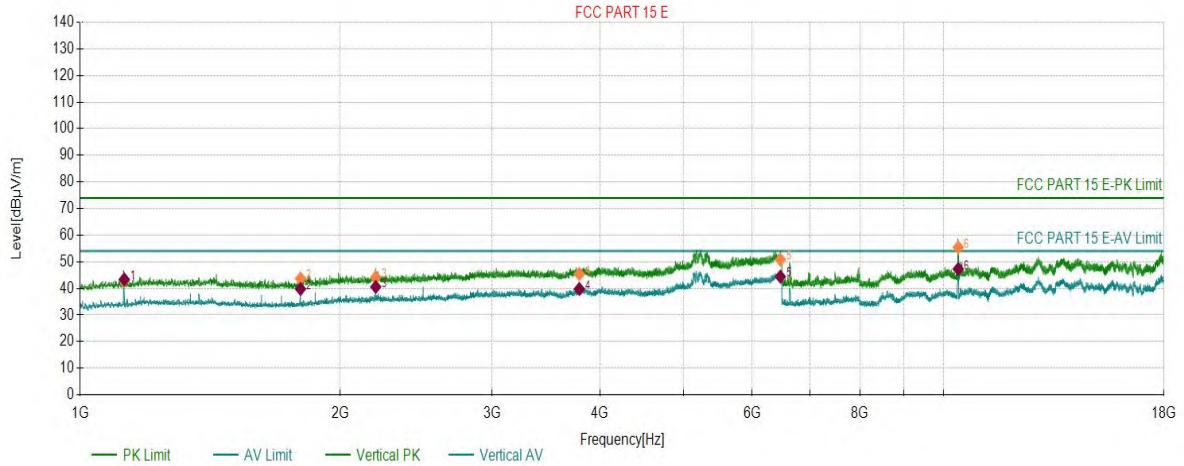

PK Final Data List

NO.	Freq. (MHz)	Factor (dB)	PK Value (dBµV/m)	PK Limit (dBµV/m)	PK Margin (dB)	Height (cm)	Angle (°)	Polarity
1	1124.8625	1.58	42.97	74.00	31.03	150	152	Vertical
2	1799.7800	3.42	43.70	74.00	30.30	150	80	Vertical
3	2199.6700	6.23	44.19	74.00	29.81	150	231	Vertical
4	3785.4785	11.78	45.39	74.00	28.61	150	248	Vertical
5	6470.2970	21.78	50.79	74.00	23.21	150	171	Vertical
6	10396.5897	4.01	55.42	74.00	18.58	150	60	Vertical

AV Final Data List

NO.	Freq. (MHz)	Factor (dB)	AV Value (dBµV/m)	AV Limit (dBµV/m)	AV Margin (dB)	Height (cm)	Angle (°)	Polarity
1	1124.8625	1.58	43.37	54.00	10.63	150	152	Vertical
2	1799.7800	3.42	39.79	54.00	14.21	150	80	Vertical
3	2199.6700	6.23	40.57	54.00	13.43	150	231	Vertical
4	3785.4785	11.78	39.81	54.00	14.19	150	248	Vertical
5	6470.2970	21.78	44.44	54.00	9.56	150	171	Vertical
6	10396.5897	4.01	47.29	54.00	6.71	150	60	Vertical

Test Report

Project Information			
EUT:	Clevershare Hub Clever Hub	Environment:	24.1°C/46%
Model:	CleverHub	SN:	
Mode:	11AC20_5825	Voltage:	120V 60Hz
Customer:		Engineer:	Roger
Remark:			

Start of Test: 2023-05-07 16:10:49

Test Graph

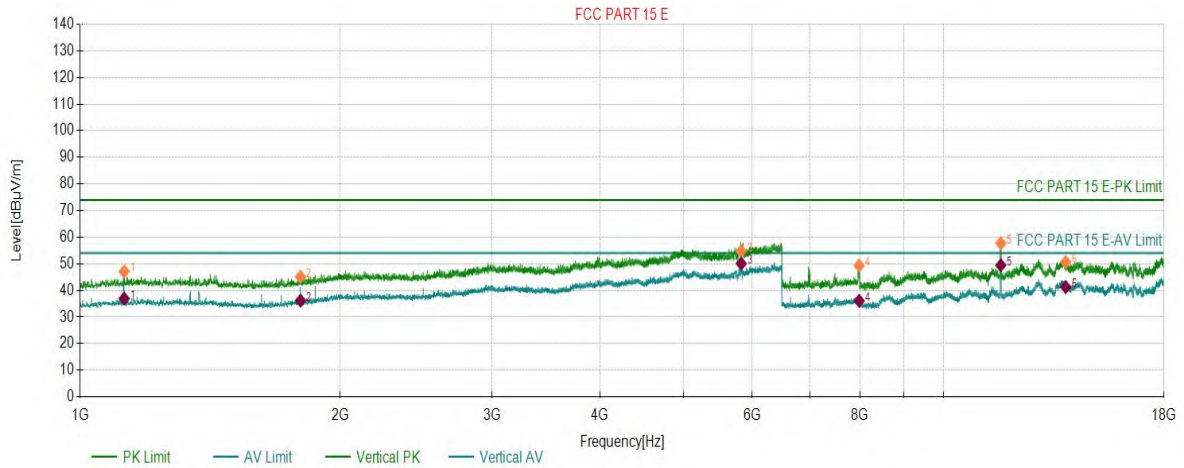

PK Final Data List								
NO.	Freq. (MHz)	Factor (dB)	PK Value (dBµV/m)	PK Limit (dBµV/m)	PK Margin (dB)	Height (cm)	Angle (°)	Polarity
1	1124.8625	2.86	47.09	74.00	26.91	150	132	Vertical
2	1799.7800	4.96	45.10	74.00	28.90	150	91	Vertical
3	5828.9329	23.79	54.69	74.00	19.31	150	156	Vertical
4	7982.4983	-0.24	49.31	74.00	24.69	150	280	Vertical
5	11646.7647	4.93	57.76	74.00	16.24	150	202	Vertical
6	13849.2349	10.93	50.62	74.00	23.38	150	153	Vertical

AV Final Data List								
NO.	Freq. (MHz)	Factor (dB)	AV Value (dBµV/m)	AV Limit (dBµV/m)	AV Margin (dB)	Height (cm)	Angle (°)	Polarity
1	1124.8625	2.86	36.93	54.00	17.07	150	132	Vertical
2	1799.7800	4.96	36.18	54.00	17.82	150	91	Vertical
3	5828.9329	23.79	50.06	54.00	3.94	150	156	Vertical
4	7982.4983	-0.24	36.06	54.00	17.94	150	280	Vertical
5	11646.7647	4.93	49.46	54.00	4.54	150	202	Vertical
6	13849.2349	10.93	41.24	54.00	12.76	150	153	Vertical

Test Report

Project Information			
EUT:	Clevershare Hub Clever Hub	Environment:	24.1°C/46%
Model:	CleverHub	SN:	
Mode:	11AC20_5825	Voltage:	120V 60Hz
Customer:		Engineer:	Roger
Remark:			

Start of Test: 2023-05-07 16:13:21

Test Graph

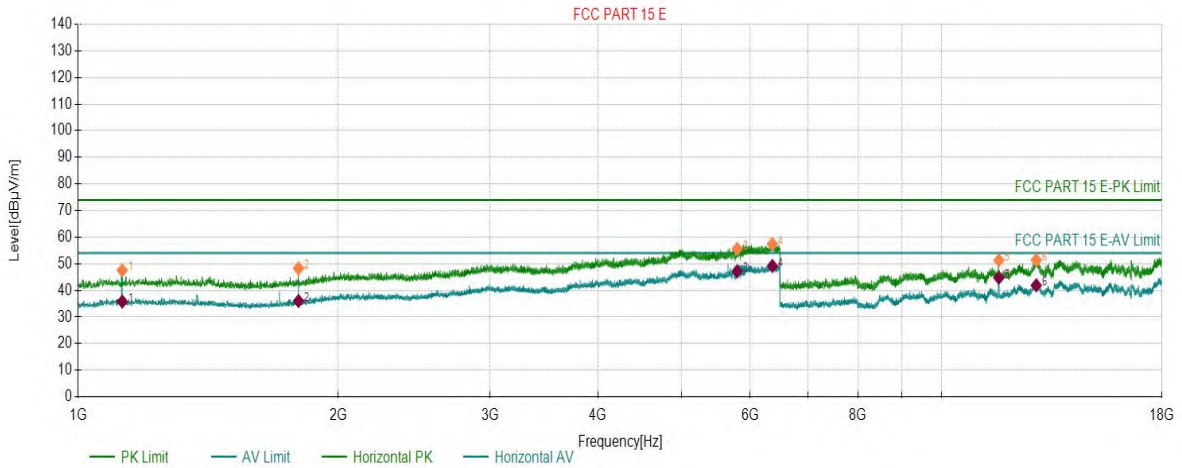

PK Final Data List

NO.	Freq. (MHz)	Factor (dB)	PK Value (dBµV/m)	PK Limit (dBµV/m)	PK Margin (dB)	Height (cm)	Angle (°)	Polarity
1	1124.8625	2.86	47.54	74.00	26.46	150	172	Horizontal
2	1799.7800	4.96	48.29	74.00	25.71	150	316	Horizontal
3	5798.1298	23.74	55.60	74.00	18.40	150	3	Horizontal
4	6367.9868	25.82	57.41	74.00	16.59	150	27	Horizontal
5	11649.0649	4.93	51.35	74.00	22.65	150	233	Horizontal
6	12872.7873	10.34	51.40	74.00	22.60	150	359	Horizontal

AV Final Data List

NO.	Freq. (MHz)	Factor (dB)	AV Value (dBµV/m)	AV Limit (dBµV/m)	AV Margin (dB)	Height (cm)	Angle (°)	Polarity
1	1124.8625	2.86	35.81	54.00	18.19	150	172	Horizontal
2	1799.7800	4.96	36.04	54.00	17.96	150	316	Horizontal
3	5798.1298	23.74	47.19	54.00	6.81	150	3	Horizontal
4	6367.9868	25.82	49.17	54.00	4.83	150	27	Horizontal
5	11649.0649	4.93	44.77	54.00	9.23	150	233	Horizontal
6	12872.7873	10.34	41.91	54.00	12.09	150	359	Horizontal

END OF REPORT