



RADIO TEST REPORT

Applicant : Sahara Presentation Systems PLC
Address : Europa House, Littlebrook DC1, Shield Road,
Dartford, Kent DA1 5UR
Equipment : IFPD Pen Tray Accessory
Model No. : Clevertouch Pen Tray & NFC
Trade Name : **CLEVERTOUCH**
FCC ID : 2APKO-PT01

I HEREBY CERTIFY THAT :

The sample was received on Apr. 04, 2018 and the testing was carried out on Apr. 18, 2018 at CerpPASS Technology Corp. The test result refers exclusively to the test presented test model / sample. Without written approval of CerpPASS Technology Corp., the test report shall not be reproduced except in full.

Approved by:

Tested by:

Mark Liao / Assistant Manager

Amos / Engineer

Laboratory Accreditation:

CerpPASS Technology Corporation Test Laboratory





Contents

1. Summary of Test Procedure and Test Results.....	4
1.1. Applicable Standards	4
2. Test Configuration of Equipment under Test.....	5
2.1. Feature of Equipment under Test.....	5
2.2. Carrier Frequency of Channels.....	5
2.3. Test Mode and Test Software.....	5
2.4. Description of Test System.....	5
2.5. General Information of Test.....	6
2.6. Measurement Uncertainty	6
3. Test Equipment and Ancillaries Used for Tests	7
4. Antenna Requirements.....	8
4.1. Standard Applicable	8
4.2. Result	8
5. Test of AC Power Line Conducted Emission	9
5.1. Test Limit	9
5.2. Test Procedures	9
5.3. Typical Test Setup	10
5.4. Test Result and Data.....	11
6. Test of Radiated Emission	12
6.1. Test Limit	12
6.2. Test Procedures	13
6.3. Typical Test Setup Layout of Radiated Emission	14
6.4. Test Result and Data.....	15
6.5. 20dB Bandwidth BW	21
6.6. Test Photographs (9KHz ~ 30MHz)	22
6.7. Test Photographs (30MHz ~ 1GHz).....	23
7. Frequency Stability	24
7.1. Test Procedure	24
7.2. Test Setup Layout	24
7.3. Test Result and Data.....	25



1. Summary of Test Procedure and Test Results

1.1. Applicable Standards

ANSI C63.4:2014

FCC Rules and Regulations Part 15 Subpart C §15.225

FCC Rule	Description of Test	Result
15.203	Antenna Requirement	PASS
15.207	Conducted Emission	N/A
15.209 15.225	Radiated Emission	Pass
15.225	20dB Bandwidth BW	Pass
15.225(e)	Frequency Stability	Pass



2. Test Configuration of Equipment under Test

2.1. Feature of Equipment under Test

Frequency Range	13.562MHz;
Modulation Type	ASK
Antenna Type/gain	PCB Antenna

2.2. Carrier Frequency of Channels

Channel	Frequency(MHz)
*1	13.562

Note: Channel remarked “*” is selected to perform test.

2.3. Test Mode and Test Software

- a. During testing, the interface cables and equipment positions were varied according to ANSI C63.4.
- b. The complete test system included EUT for RF test.
- d. The test mode of RF test as follow:
Test Mode 1. RFID (ASK), 13.562MHz

2.4. Description of Test System

Device	Manufacturer	Model No.	Description
DC POWER	LONG WEI	PS-305D	N/A



2.5. General Information of Test

Test Site	Cerpass Technology Corporation Test Laboratory Address: No.10, Ln. 2, Lianfu St., Luzhu Dist., Taoyuan City 33848, Taiwan (R.O.C.) Tel:+886-3-3226-888 Fax:+886-3-3226-881 Address: No.68-1, Shihbachongsi, Shihding Township, New Taipei City 223, Taiwan, R.O.C. Tel: +886-2-2663-8582	
	FCC	TW1079, TW1061, TW1439
	IC	4934E-1, 4934E-2
	VCCI	T-2205 for Telecommunication Test C-4663 for Conducted emission test R-4399, R-4218 for Radiated emission test G-10812, G-10813 for radiated disturbance above 1GHz
Frequency Range Investigated:	Conducted: from 150kHz to 30 MHz Radiation: from 30 MHz to 10,000MHz	
Test Distance:	The test distance of radiated emission from antenna to EUT is 3 M.	

2.6. Measurement Uncertainty

Measurement Item	Uncertainty
Radiated Spurious Emission(9KHz~30MHz)	±5.007dB
Radiated Spurious Emission(30MHz~1GHz)	±5.157dB
Radiated Spurious Emission(1GHz~18GHz)	±6.383dB
Radiated Spurious Emission(18GHz~40GHz)	±6.648dB
Conducted Spurious Emission	±1.253dB
6dB Bandwidth	±6.89%
Power Spectral Density	±0.630dB
26 dB Occupied Bandwidth	±6.10%
Frequency Stability	±375KHz
Channel Frequencies Separation	±6.10%
20dB Bandwidth	±6.12%
Dwell Time	±1.34%
Peak Output Power(Conducted Power Meter)	±0.86dB
Temperature	±1.2oC
Humidity	±2.7%
Channel Move Time	±4.53%
Channel Closing Transmission Time	±6.61%
Threshold	±0.631dB
Non occupancy period	±1.17%



3. Test Equipment and Ancillaries Used for Tests

Instrument	Manufacturer	Model No	Serial No	Calibration Date	Valid Date
EMI Receiver	R&S	ESCI3	100821	2017/09/08	2018/09/07
LISN	Schwarzbeck	NSLK 8127	8127-568	2018/02/26	2019/02/25
Pulse Limiter	R&S	ESH3-Z2	101934	2018/02/22	2019/02/21
Bilog Antenna	Schwarzbeck	VULB9168	275	2017/08/31	2018/08/30
Active Loop Antenna	EMCO	6507	40855	2017/05/15	2018/05/14
Horn Antenna	EMCO	3115	31601	2017/09/11	2018/09/10
Horn Antenna	EMCO	3116	31970	2018/03/23	2019/03/22
Preamplifier	EM	EM330	60658	2017/09/08	2018/09/07
Preamplifier	EMC INSTRUMENTS	EMC051845SE	980333	2017/09/20	2018/09/19
Preamplifier	EMC INSTRUMENTS	EMC184045	980065	2017/11/10	2018/11/09
MXG MW Analog Signal Generator	KEYSIGHT	N5183A	MY50142931	2018/03/23	2019/03/22
Spectrum Analyzer	R&S	FSP40	100219	2017/07/01	2018/06/30
BLUETOOTH TESTER	R&S	CBT	101133	2018/04/02	2019/04/01
Attenuator	KEYSIGHT	8491B	MY39250705	2017/09/04	2018/09/03
Rotary Attenuator	Agilent	8495B	MY42146680	2018/03/29	2019/03/28
Temp & Humi chamber	T-MACHINE	TMJ-9712	T-12-040111	2017/09/04	2018/09/03
Series Power Meter	Anritsu	ML2495A	1224005	2018/03/23	2019/03/22
Power Sensor	Anritsu	MA2411B	1207295	2018/03/23	2019/03/22
Software	Farad	Ez-EMC	ver.ct3a1	N/A	N/A
Software	AUDIX	E3	V8.2014-8-6	N/A	N/A
Software	Keysight	N7607B Signal Studio	V3.0.0.0	N/A	N/A
Software	Keysight	Inservice MonitorUtility	N/A	N/A	N/A



4. Antenna Requirements

4.1. Standard Applicable

According to FCC 47 CFR Section 15.203, an intentional radiator antenna shall be designed to ensure that no antenna other than that furnished by the responsible party can be used with the device. The use of a permanently attached antenna or of an antenna that uses a unique coupling to the intentional radiator shall be considered sufficient to comply with the provisions of this section.

4.2. Result

The EUT has a permanently and irreplaceable attached antenna. Please refer to the EUT internal photos.



5. Test of AC Power Line Conducted Emission

5.1. Test Limit

Conducted Emissions were measured from 150 kHz to 30 MHz with a bandwidth of 9 KHz, according to the methods defined in ANSI C63.4-2014. The EUT was placed on a nonmetallic stand in a shielded room 0.8 meters above the ground plane. The interface cables and equipment positioning were varied within limits of reasonable applications to determine the position produced maximum conducted emissions.

Frequency (MHz)	Quasi Peak (dB μ V)	Average (dB μ V)
0.15 – 0.5	66-56*	56-46*
0.5 – 5.0	56	46
5.0 – 30.0	60	50

*Decreases with the logarithm of the frequency.

5.2. Test Procedures

- a. The EUT was placed 0.4 meter from the conducting wall of the shielding room was kept at least 80 centimeters from any other grounded conducting surface.
- b. Connect EUT to the power mains through a line impedance stabilization network (LISN).
- c. All the support units are connecting to the other LISN.
- d. The LISN provides 50 ohm coupling impedance for the measuring instrument.
- e. The FCC states that a 50 ohm, 50 micro-Henry LISN should be used.
- f. Both sides of AC line were checked for maximum conducted interference.
- g. The frequency range from 150 kHz to 30 MHz was searched.
- h. Set the test-receiver system to Peak Detect Function and Specified Bandwidth with Maximum Hold Mode.



5.3. Typical Test Setup

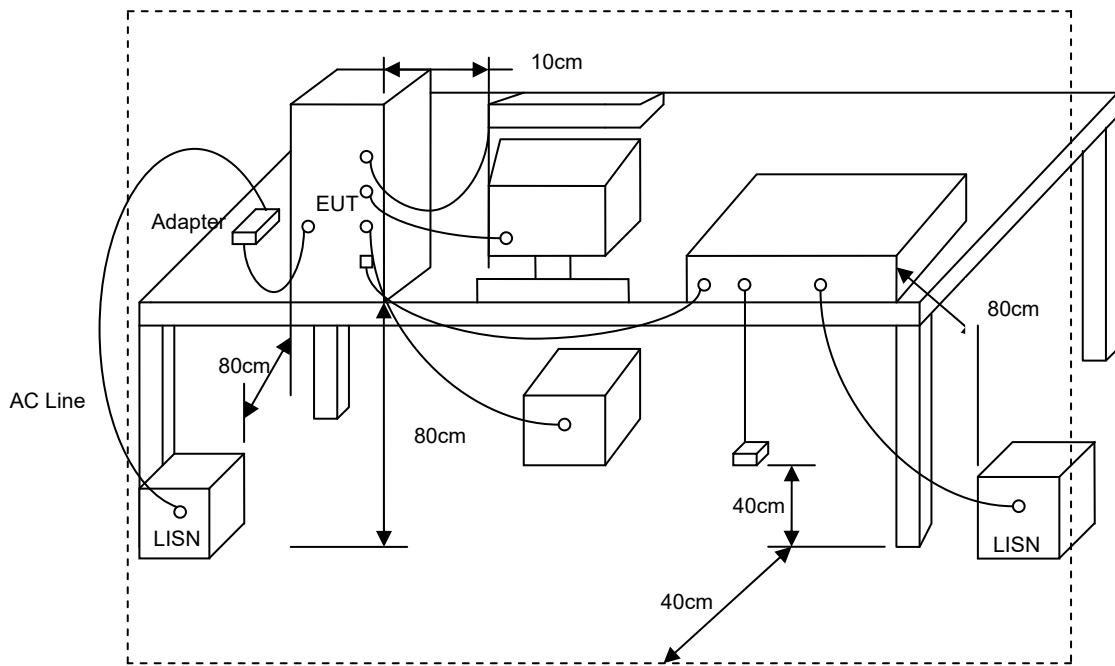



5.4. Test Result and Data

Not applicable since the EUT supplied by DC power.



6. Test of Radiated Emission

6.1. Test Limit

- (a) The field strength of any emissions within the band 13.553-13.567 MHz shall not exceed 15,848 microvolts/meter at 30 meters.
- (b) Within the bands 13.410-13.553 MHz and 13.567-13.710 MHz, the field strength of any emissions shall not exceed 334 microvolts/meter at 30 meters.
- (c) Within the bands 13.110-13.410 MHz and 13.710-14.010 MHz the field strength of any emissions shall not exceed 106 microvolts/meter at 30 meters.
- (d) The field strength of any emissions appearing outside of the 13.110-14.010 MHz band shall not exceed the general radiated emission limits in §15.209.

Frequency (MHz)	Distance	Limit ($\mu\text{V}/\text{m}$)
0.09 ~ 0.490	300m	2400/F(kHz)
0.490 ~ 1.705	30m	24000/ F(kHz)
1.705 ~ 30	30m	30
30 ~ 88	3m	100
88 ~ 216	3m	150
216 ~ 960	3m	200
Above 960	3m	500

15.215 Additional provisions to the general radiated emission limitations.:

- (c) Intentional radiators operating under the alternative provisions to the general emission limits, as contained in §§15.217 through 15.257 and in subpart E of this part, must be designed to ensure that the 20 dB bandwidth of the emission, or whatever bandwidth may otherwise be specified in the specific rule section under which the equipment operates, is contained within the frequency band designated in the rule section under which the equipment is operated.



6.2. Test Procedures

- a. The EUT was placed on a rotatable table top 0.8 meter above ground.
- b. The EUT was set 3 meters from the interference receiving antenna which was mounted on the top of a variable height antenna tower.
- c. The table was rotated 360 degrees to determine the position of the highest radiation.
- d. The antenna is a broadband antenna and its height is varied between one meter and four meters above ground to find the maximum value of the field strength both horizontal polarization and vertical polarization of the antenna are set to make the measurement.
- e. For each suspected emission the EUT was arranged to its worst case and then tune the antenna tower (from 1 M to 4 M) and turn table (from 0 degree to 360 degrees) to find the maximum reading.
- f. Set the test-receiver system to Peak or CISPR quasi-peak Detect Function and specified bandwidth with Maximum Hold Mode.
- g. If the emission level of the EUT in peak mode was 3 dB lower than the limit specified, then testing will be stopped and peak values of EUT will be reported, otherwise, the emissions which do not have 3 dB margin will be repeated one by one using the quasi-peak method and reported.
- h. "Cone of radiation" has been considered to be 3dB beamwidth of the measurement antenna.

NOTE:

1. The resolution bandwidth of test receiver/spectrum analyzer is 300Hz or CISPS 200Hz(QP detector) at frequency Below 150 kHz.
2. The resolution bandwidth of test receiver/spectrum analyzer is 10KHz or CISPS 9KHz(QP detector) at frequency 150 kHz to 30 MHz.
3. The resolution bandwidth and video bandwidth of test receiver/spectrum analyzer is 120kHz for Peak detection (PK) and Quasi-peak detection (QP) at frequency below 1GHz.



6.3. Typical Test Setup Layout of Radiated Emission

Below 30MHz test setup

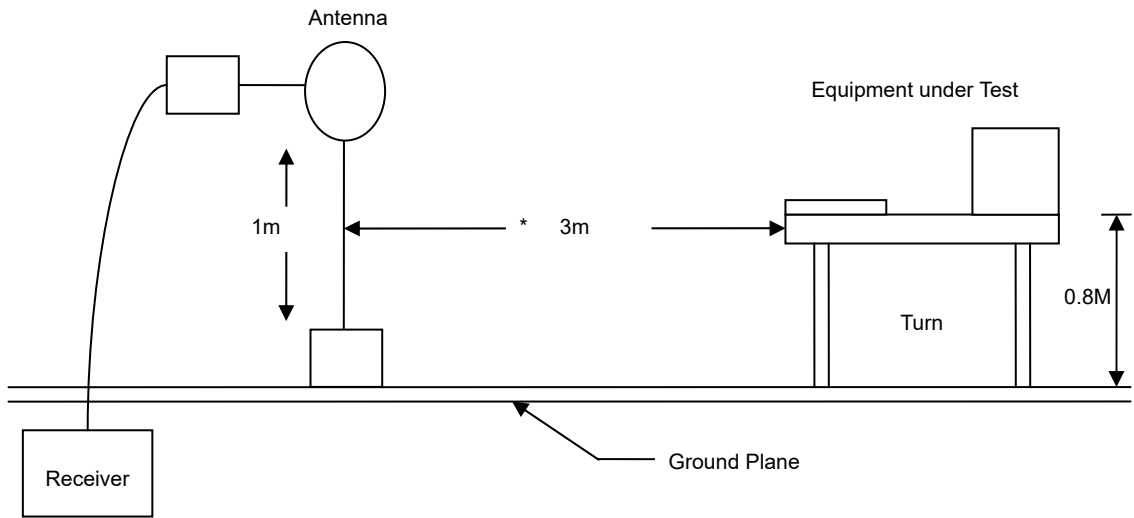

Below 1GHz Test Setup

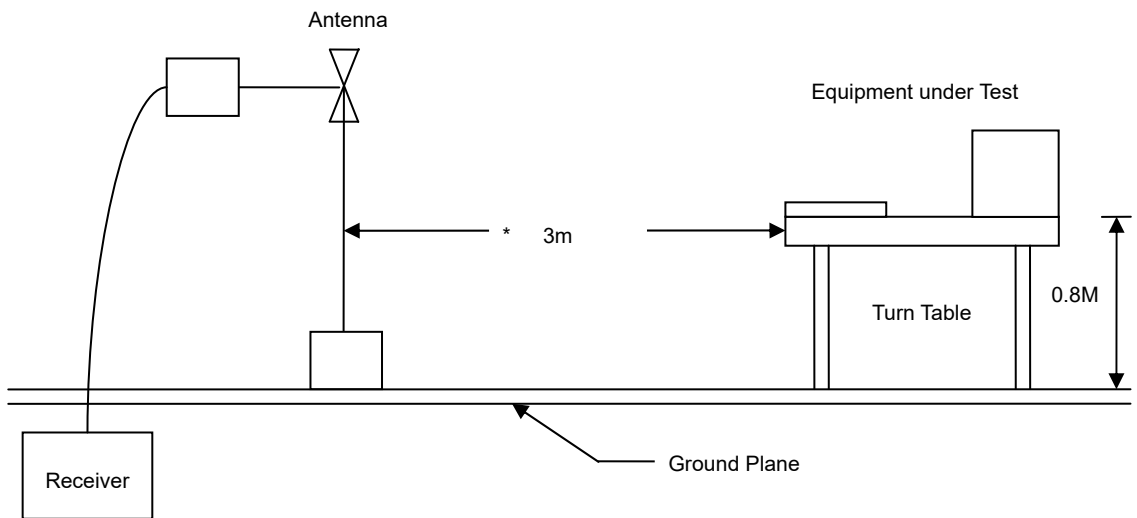

1.5M



6.4. Test Result and Data

6.4.1. Test Result of Fundamental Emission

Power	: DC 5V	Loop	: Open
Test Mode	: Mode 1	Temperature	: 24°C
Test Date	: Apr. 15, 2018	Humidity	: 63%

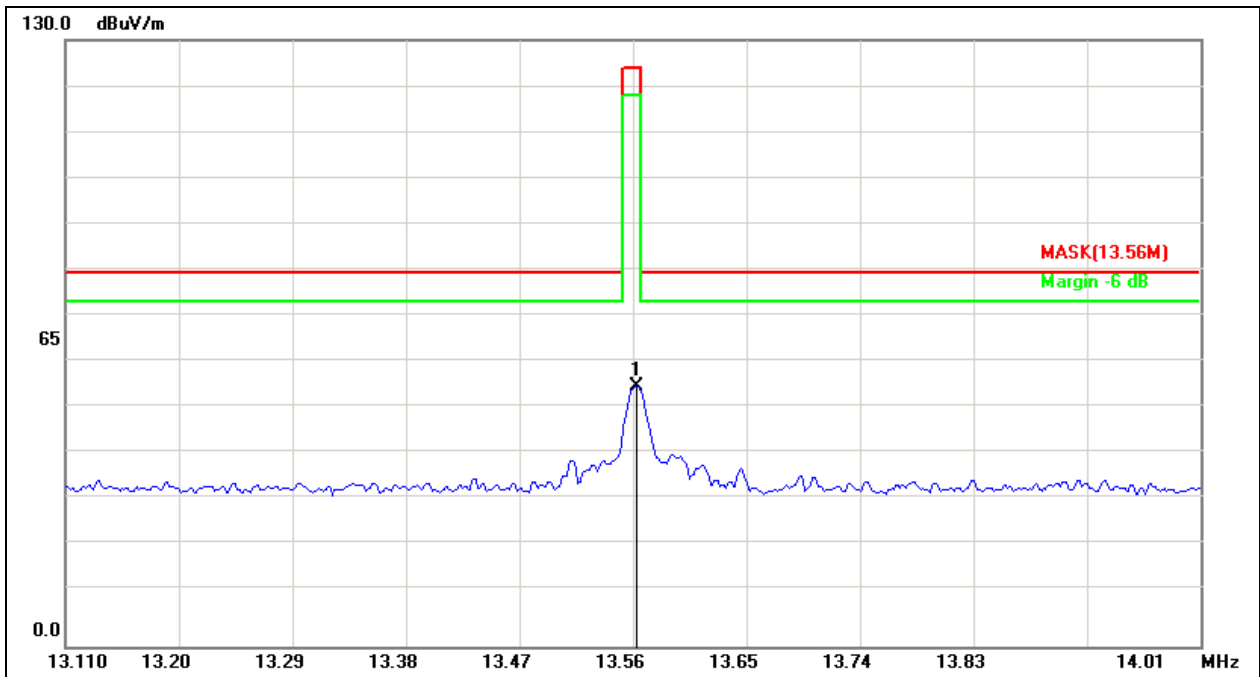

No.	Frequency (MHz)	Factor (dB/m)	Reading (dBuV)	Level (dBuV/m)	Limit (dBuV/m)	Margin (dB)	Det.
1	13.5630	21.50	34.30	55.80	124.00	-68.20	peak

Note: Level = Reading +Factor
Margin =Level –Limit
Factor=Antenna Factor +Cable loss –Amplifier Factor



Power	: DC 5V	Loop	: Close
Test Mode	: Mode 1	Temperature	: 24°C
Test Date	: Apr. 15, 2018	Humidity	: 63%

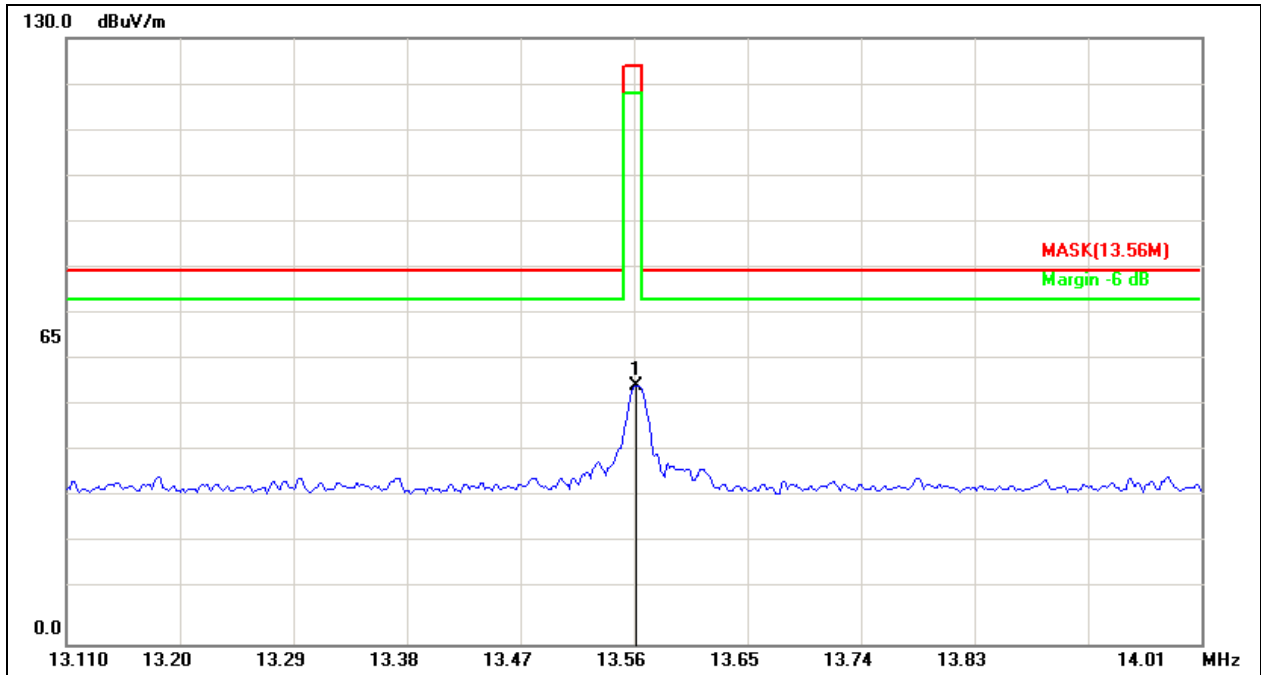

No.	Frequency (MHz)	Factor (dB/m)	Reading (dBuV)	Level (dBuV/m)	Limit (dBuV/m)	Margin (dB)	Det.
1	13.5615	21.50	34.05	55.55	124.00	-68.45	peak

Note: Level = Reading +Factor
Margin =Level –Limit
Factor=Antenna Factor +Cable loss –Amplifier Factor



6.4.2. Test Result of Unwanted Spurious emission (9KHz ~ 30MHz)

Power	: DC 5V	Loop	: Open
Test Mode	: Mode 1	Temperature	: 24°C
Test Date	: Apr. 15, 2018	Humidity	: 63%

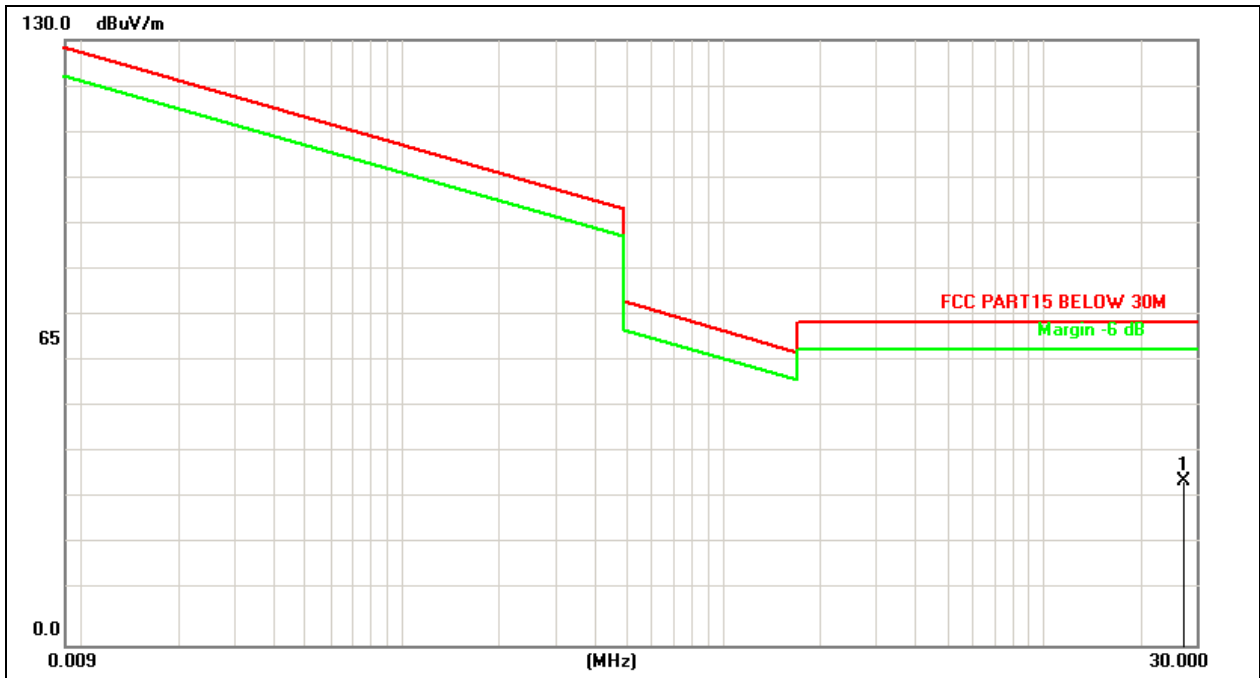

No.	Frequency (MHz)	Factor (dB/m)	Reading (dBuV)	Level (dBuV/m)	Limit (dBuV/m)	Margin (dB)	Det.
1	27.1240	21.64	13.54	35.18	69.54	-34.36	peak

Note: Level = Reading +Factor
 Margin =Level –Limit
 Factor=Antenna Factor +Cable loss –Amplifier Factor



Power	: DC 5V	Loop	: Close
Test Mode	: Mode 1	Temperature	: 24°C
Test Date	: Apr. 15, 2018	Humidity	: 63%



No.	Frequency (MHz)	Factor (dB/m)	Reading (dBuV)	Level (dBuV/m)	Limit (dBuV/m)	Margin (dB)	Det.
1	27.1240	21.64	13.15	34.79	69.54	-34.75	peak

Note: Level = Reading +Factor
Margin =Level –Limit
Factor=Antenna Factor +Cable loss –Amplifier Factor



6.4.3. Test Result of Unwanted Spurious emission (30GHz ~ 1GHz)

Power	: DC 5V	Pol/Phase	: VERTICAL
Test Mode	: Mode 1	Temperature	: 24°C
Test Date	: Apr. 15, 2018	Humidity	: 63%

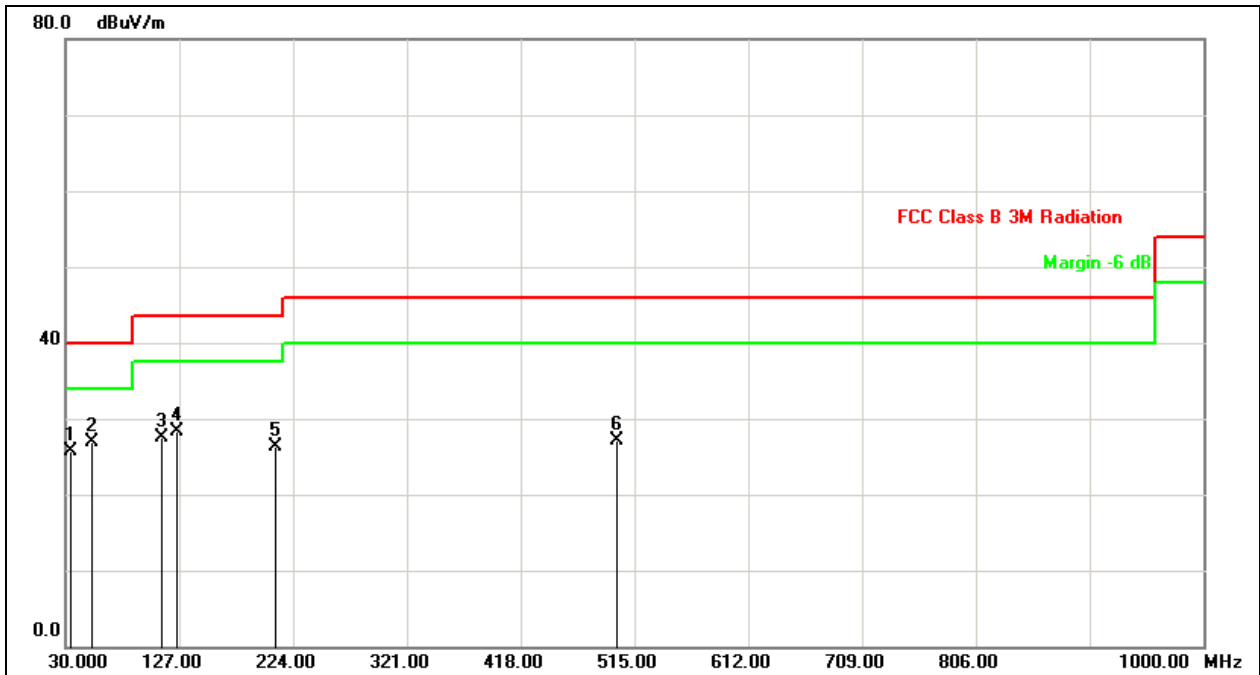

No.	Frequency (MHz)	Factor (dB/m)	Reading (dBuV)	Level (dBuV/m)	Limit (dBuV/m)	Margin (dB)	Det.	Height (cm)	Azimuth ()
1	33.8800	-5.41	31.04	25.63	40.00	-14.37	peak	100	13
2	52.3100	-14.60	41.46	26.86	40.00	-13.14	peak	100	191
3	112.4500	-8.37	35.87	27.50	43.50	-16.00	peak	100	154
4	125.0600	-8.36	36.59	28.23	43.50	-15.27	peak	100	67
5	209.4500	-9.50	35.76	26.26	43.50	-17.24	peak	100	165
6	499.4800	-2.16	29.28	27.12	46.00	-18.88	peak	100	179

Note: Level = Reading +Factor

Margin =Level –Limit

Factor=Antenna Factor +Cable loss –Amplifier Factor



Power	: DC 5V	Pol/Phase	: HORIZONTAL
Test Mode	: Mode 1	Temperature	: 24°C
Test Date	: Apr. 15, 2018	Humidity	: 63%

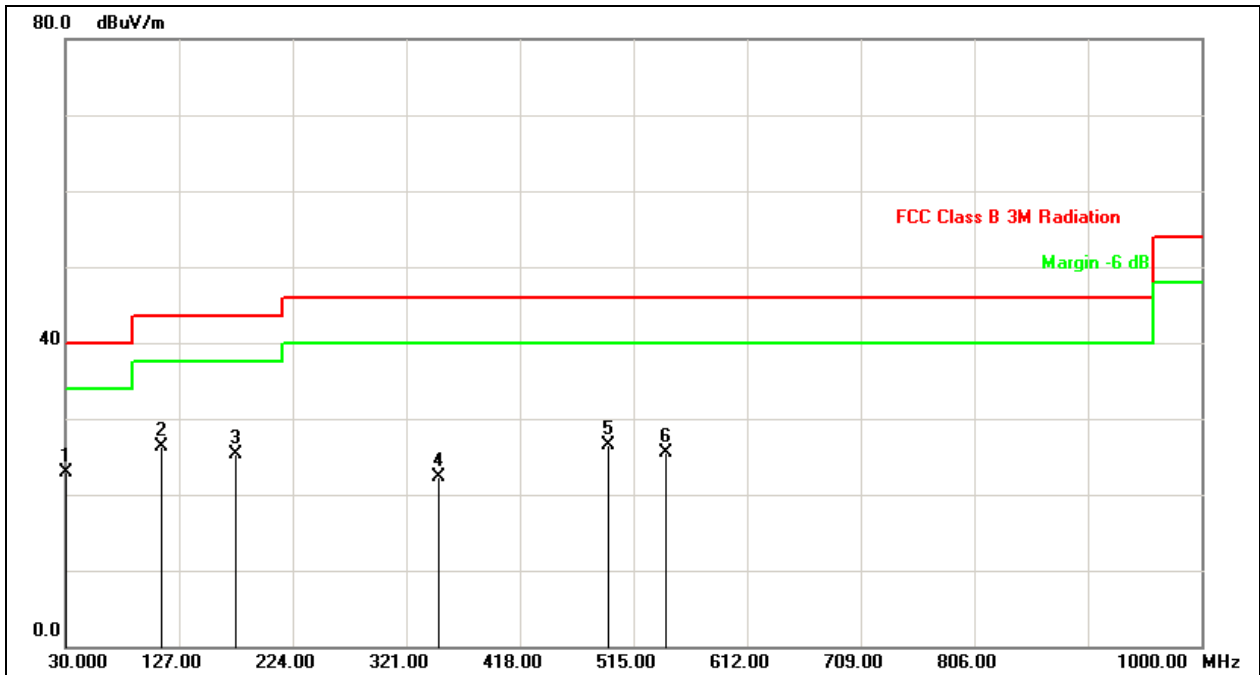

No.	Frequency (MHz)	Factor (dB/m)	Reading (dBuV)	Level (dBuV/m)	Limit (dBuV/m)	Margin (dB)	Det.	Height (cm)	Azimuth ()
1	30.0000	-3.01	25.92	22.91	40.00	-17.09	peak	100	194
2	112.4500	-8.37	34.68	26.31	43.50	-17.19	peak	100	187
3	175.5000	-11.84	37.19	25.35	43.50	-18.15	peak	100	162
4	348.1600	-4.24	26.55	22.31	46.00	-23.69	peak	100	143
5	493.6600	-1.90	28.33	26.43	46.00	-19.57	peak	200	185
6	543.1300	-2.79	28.37	25.58	46.00	-20.42	peak	100	180

Note: Level = Reading +Factor

Margin =Level -Limit

Factor=Antenna Factor +Cable loss -Amplifier Factor



6.5. 20dB Bandwidth BW

Frequency (MHz)	20dB Bandwidth (KHz)	Frequency range MHz (20dB Down) fL > 13.553 MHz	Frequency range MHz (20dB Down) fH < 13.567 MHz
13.562	2.850	13.5610	13.5638

20dB Bandwidth
13.562MHz

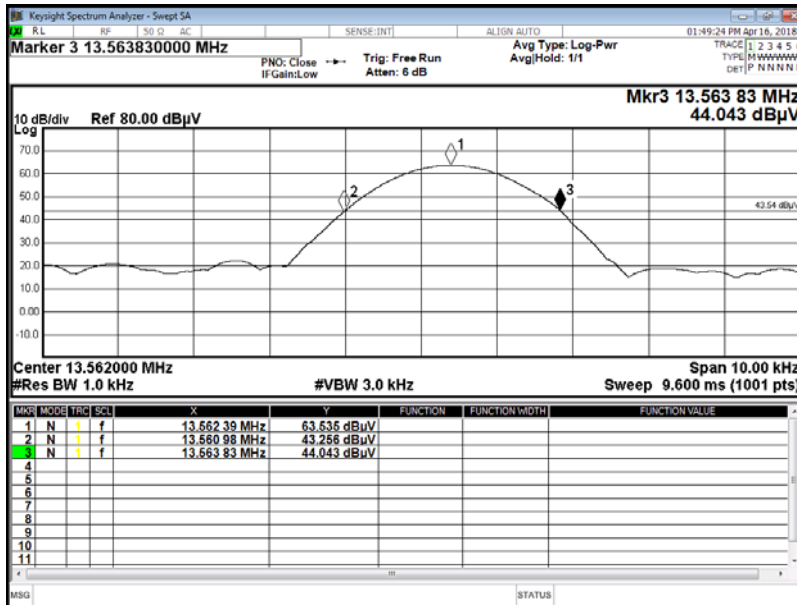



6.6. Test Photographs (9KHz ~ 30MHz)





6.7. Test Photographs (30MHz ~ 1GHz)





7. Frequency Stability

7.1. Test Procedure

1. The EUT was placed inside the Temperature and Humidity chamber.
2. The transmitter output was connected to spectrum analyzer.
3. Turn the EUT on and couple its output to a spectrum analyzer.
4. Turn the EUT off and set the chamber to the highest temperature specified.
5. Allow sufficient time (approximately 30 min) for the temperature of the chamber to stabilize, turn the EUT on and measure the operating frequency after 2, 5, and 10 minutes.
6. Repeat step 2 and 3 with the temperature chamber set to the lowest temperature.
7. The test chamber was allowed to stabilize at +20 degree C for a minimum of 30 minutes. The supply voltage was then adjusted on the EUT from 85% to 115% and the frequency record.

7.2. Test Setup Layout

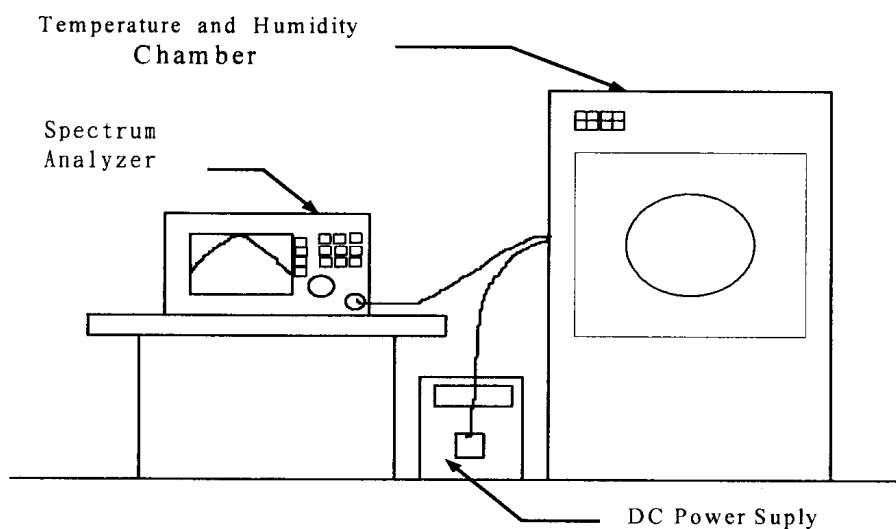



7.3. Test Result and Data

Operating frequency: 13.562 MHz									
Temperature (°C)	Power supply (V)	0 minute		2 minute		5 minute		10 minute	
		(MHz)	(%)	(MHz)	(%)	(MHz)	(%)	(MHz)	(%)
50	5	13.56238	0.002802	13.56238	0.002802	13.56239	0.002876	13.56240	0.002949
40	5	13.56239	0.002876	13.56239	0.002876	13.56239	0.002876	13.56240	0.002949
30	5	13.56239	0.002876	13.56239	0.002876	13.56239	0.002876	13.56239	0.002876
20	5.75	13.56240	0.002949	13.56240	0.002949	13.56240	0.002949	13.56239	0.002876
	5	13.56239	0.002876	13.56239	0.002876	13.56239	0.002876	13.56239	0.002876
	4.25	13.56239	0.002876	13.56239	0.002876	13.56240	0.002949	13.56240	0.002949
10	5	13.56238	0.002802	13.56238	0.002802	13.56239	0.002876	13.56239	0.002876
0	5	13.56238	0.002802	13.56238	0.002802	13.56239	0.002876	13.56239	0.002876
-10	5	13.56238	0.002802	13.56238	0.002802	13.56238	0.002802	13.56238	0.002802
-20	5	13.56240	0.002949	13.56240	0.002949	13.56238	0.002802	13.56238	0.002802
-30	5	13.56239	0.002876	13.56239	0.002876	13.56238	0.002802	13.56239	0.002876