



HEADQUARTERS: 914 WEST PATAPSCO AVENUE • BALTIMORE, MARYLAND 21230 • PHONE (410) 354-3300 • FAX (410) 354-3313

May 21, 2019

Openpath Security Inc.
5839 Green Valley Cir.
Culver City, CA 90230

Dear Michael Biggs,

Enclosed is the EMC Wireless test report for compliance testing of the Openpath Security Inc., Mullion Smart Reader (LF) with Taiyo Yuden Model EYSGJN as tested to the requirements of Title 47 of the CFR, Ch. 1 (10-1-06 ed.), Part 15 Subpart C for Intentional Radiators.

Thank you for using the services of Eurofins MET Labs. If you have any questions regarding these results or if MET can be of further service to you, please feel free to contact me.

Sincerely yours,
EUROFINS MET LABS

A handwritten signature in black ink that reads "Jennifer Warnell". The signature is written in a cursive, flowing style.

Jennifer Warnell
Documentation Department

Reference: (\Openpath Security Inc.\EMCS101883C-FCC247 DTS Rev. 4 (LF))

Certificates and reports shall not be reproduced except in full, without the written permission of Eurofins MET Labs

Electromagnetic Compatibility Criteria Test Report

for the

Openpath Security Inc.
Mullion Smart Reader (LF) with Taiyo Yuden Model EYSGJN

Tested under
the FCC Certification Rules
contained in
15.247 Subpart C for Intentional Radiators

MET Report: EMCS101883C-FCC247 DTS Rev. 4 (LF)

May 21, 2019

Prepared For:

Openpath Security Inc.
5839 Green Valley Cir.
Culver City, CA 90230

Prepared By:
Eurofins MET Labs
914 W. Patapsco Ave.
Baltimore, MD 21230

Electromagnetic Compatibility Criteria Test Report

for the

Openpath Security Inc.
Mullion Smart Reader (LF) with Taiyo Yuden Model EYSGJN

Tested under
the FCC Certification Rules
contained in
15.247 Subpart C for Intentional Radiators



James Borrott, Project Engineer
Electromagnetic Compatibility Lab



Jennifer Warnell
Documentation Department

Engineering Statement: The measurements shown in this report were made in accordance with the procedures indicated, and the emissions from this equipment were found to be within the limits applicable. I assume full responsibility for the accuracy and completeness of these measurements, and for the qualifications of all persons taking them. It is further stated that upon the basis of the measurements made, the equipment tested is capable of operation in accordance with the requirements of the FCC Rules Part 15.247 under normal use and maintenance.



John Mason,
Director, Electromagnetic Compatibility Lab

Report Status Sheet

Revision	Report Date	Reason for Revision
∅	January 24, 2019	Initial Issue.
1	March 15, 2019	Created to separate HF from LF.
2	April 23, 2019	Editorial corrections.
3	May 9, 2019	Editorial corrections.
4	May 21, 2019	TCB Corrections.

Table of Contents

I.	Executive Summary	1
	A. Purpose of Test	2
	B. Executive Summary	2
II.	Equipment Configuration	3
	A. Overview	4
	B. References	5
	C. Test Site	5
	D. Description of Test Sample	5
	E. Equipment Configuration	7
	F. Support Equipment	7
	G. Ports and Cabling Information	8
	H. Mode of Operation	8
	I. Method of Monitoring EUT Operation	8
	J. Modifications	9
	a) Modifications to EUT	9
	b) Modifications to Test Standard	9
	K. Disposition of EUT	9
III.	Electromagnetic Compatibility Criteria for Intentional Radiators	10
	§ 15.203 Antenna Requirement	11
	§ 15.207(a) Conducted Emissions Limits	12
	§ 15.247(d) Radiated Spurious Emissions Requirements and Band Edge	15
IV.	Test Equipment	32
V.	Certification & User’s Manual Information	34
	A. Certification Information	35
	B. Label and User’s Manual Information	39

List of Tables

Table 1. Executive Summary of EMC Part 15.247 Compliance Testing	2
Table 2. EUT Summary Table.....	4
Table 3. References	5
Table 4. Equipment Configuration, Standard Smart Reader (LF).....	7
Table 5. Equipment Configuration, Mullion Smart Reader (LF).....	7
Table 6. Support Equipment, Standard Smart Reader (LF).....	7
Table 7. Support Equipment, Mullion Smart Reader (LF).....	7
Table 8. Ports and Cabling Information, Standard Smart Reader (LF).....	8
Table 9. Ports and Cabling Information, Mullion Smart Reader (LF).....	8
Table 10. Conducted Limits for Intentional Radiators from FCC Part 15 § 15.207(a)	12
Table 11. Conducted Emissions, Line, Test Results	13
Table 12. Conducted Emissions, Neutral, Test Results.....	14
Table 13. Test Equipment List	33

List of Plots

Plot 1. Conducted Emissions, Line.....	13
Plot 2. Conducted Emissions, Neutral	14
Plot 3. Radiated Spurious Emissions, Low Channel, 30 MHz – 1 GHz.....	17
Plot 4. Radiated Spurious Emissions, Mid Channel, 30 MHz – 1 GHz	17
Plot 5. Radiated Spurious Emissions, High Channel, 30 MHz – 1 GHz	17
Plot 6. Radiated Spurious Emissions, Low Channel, 1 GHz – 9 GHz, Average.....	18
Plot 7. Radiated Spurious Emissions, Low Channel, 1 GHz – 9 GHz, Peak.....	18
Plot 8. Radiated Spurious Emissions, Mid Channel, 1 GHz – 9 GHz, Average.....	18
Plot 9. Radiated Spurious Emissions, Mid Channel, 1 GHz – 9 GHz, Peak	19
Plot 10. Radiated Spurious Emissions, High Channel, 1 GHz – 9 GHz, Average	19
Plot 11. Radiated Spurious Emissions, High Channel, 1 GHz – 9 GHz, Peak	19
Plot 12. Radiated Spurious Emissions, Low Channel, 9 GHz – 18 GHz, Average	20
Plot 13. Radiated Spurious Emissions, Low Channel, 9 GHz – 18 GHz, Peak.....	20
Plot 14. Radiated Spurious Emissions, Mid Channel, 9 GHz – 18 GHz, Average.....	20
Plot 15. Radiated Spurious Emissions, Mid Channel, 9 GHz – 18 GHz, Peak	21
Plot 16. Radiated Spurious Emissions, High Channel, 9 GHz – 18 GHz, Average	21
Plot 17. Radiated Spurious Emissions, High Channel, 9 GHz – 18 GHz, Peak	21
Plot 18. Radiated Spurious Emissions, Low Channel, 359.996 MHz QP	22
Plot 19. Radiated Spurious Emissions, Mid Channel, 359.9995 MHz QP.....	22
Plot 20. Radiated Spurious Emissions, High Channel, 360.0021 MHz QP.....	22
Plot 21. Radiated Spurious Emissions, Low Channel, 440.001 MHz QP	23
Plot 22. Radiated Spurious Emissions, Mid Channel, 439.9993 MHz QP.....	23
Plot 23. Radiated Spurious Emissions, High Channel, 439.9998 MHz QP.....	23
Plot 24. Radiated Spurious Emissions, All Tx Active, 30-1000MHz	24
Plot 25. Radiated Spurious Emissions, All Tx Active, 1-9GHz Average.....	24
Plot 26. Radiated Spurious Emissions, All Tx Active, 1-9GHz Peak	25
Plot 28. Radiated Spurious Emissions, All Tx Active, 9-18GHz Average.....	25
Plot 30. Radiated Spurious Emissions, All Tx Active, 1-9GHz Peak	26
Plot 31. Radiated Spurious Emissions, All Tx Active, 440 MHz QP.....	26
Plot 32. Radiated Spurious Emissions, All Tx Active, 11.98 GHz Average	27
Plot 33. Radiated Restricted Band Edge, Low Channel, 20 dBc, 2400 MHz.....	28
Plot 34. Radiated Restricted Band Edge, High Channel, 20 dBc, 2483.5 MHz	28
Plot 35. Radiated Restricted Band Edge, Low Channel, 2390 MHz, Average.....	29
Plot 36. Radiated Restricted Band Edge, Low Channel, 2390 MHz, Peak	29

Plot 37. Radiated Restricted Band Edge, High Channel, 2483.5 MHz, Average 30
Plot 38. Radiated Restricted Band Edge, High Channel, 2483.5 MHz, Peak..... 30

List of Figures

Figure 1. Block Diagram of Test Configuration, Standard Smart Reader (LF)..... 6
Figure 2. Block Diagram of Test Configuration, Mullion Smart Reader (LF)..... 7

List of Photographs

Photograph 1. Openpath Security Inc. Smart Reader & Mullion Smart Reader (LF) with Taiyo Yuden Model EYSGJN ... 6
Photograph 2. Radiated Spurious Emissions, Test Setup, 30 MHz – 1 GHz..... 31
Photograph 3. Radiated Spurious Emissions, Test Setup, 1 GHz – 18 GHz 31

List of Terms and Abbreviations

AC	Alternating Current
ACF	Antenna Correction Factor
Cal	Calibration
<i>d</i>	Measurement Distance
dB	Decibels
dB μ A	Decibels above one microamp
dB μ V	Decibels above one microvolt
dB μ A/m	Decibels above one microamp per meter
dB μ V/m	Decibels above one microvolt per meter
DC	Direct Current
E	Electric Field
DSL	Digital Subscriber Line
ESD	Electrostatic Discharge
EUT	Equipment Under Test
<i>f</i>	Frequency
FCC	Federal Communications Commission
GRP	Ground Reference Plane
H	Magnetic Field
HCP	Horizontal Coupling Plane
Hz	Hertz
IEC	International Electrotechnical Commission
kHz	kilohertz
kPa	kilopascal
kV	kilovolt
LISN	Line Impedance Stabilization Network
MHz	Megahertz
μ H	microhenry
μ	microfarad
μ s	microseconds
NEBS	Network Equipment-Building System
PRF	Pulse Repetition Frequency
RF	Radio Frequency
RMS	Root-Mean-Square
TWT	Traveling Wave Tube
V/m	Volts per meter
VCP	Vertical Coupling Plane

I. Executive Summary

A. Purpose of Test

An EMC evaluation was performed to determine compliance of the Openpath Security Inc. Smart Reader & Mullion Smart Reader (LF) with Taiyo Yuden Model EYSGJN, with the requirements of Part 15, §15.247. All references are to the most current version of Title 47 of the Code of Federal Regulations in effect. In accordance with §2.1033, the following data is presented in support of the Certification of the Smart Reader & Mullion Smart Reader (LF) with Taiyo Yuden Model EYSGJN. Openpath Security Inc. should retain a copy of this document which should be kept on file for at least two years after the manufacturing of the Smart Reader & Mullion Smart Reader (LF) with Taiyo Yuden Model EYSGJN, has been **permanently** discontinued.

B. Executive Summary

The following tests were conducted on a sample of the equipment for the purpose of demonstrating compliance with Part 15, §15.247, in accordance with Openpath Security Inc., purchase order number PO-2004. All tests were conducted using measurement procedure ANSI C63.10-2013.

FCC Reference 47 CFR Part 15.247:2005	Description	Compliance
Title 47 of the CFR, Part 15 §15.203	Antenna Requirement	Compliant
Title 47 of the CFR, Part 15 §15.207(a)	Conducted Emission Limits	Compliant
Title 47 of the CFR, Part 15 §15.247(d); §15.209; §15.205	Radiated Spurious Emissions Requirements	Compliant

Table 1. Executive Summary of EMC Part 15.247 Compliance Testing

II. Equipment Configuration

A. Overview

Eurofins MET Labs was contracted by Openpath Security Inc. to perform testing on the Smart Reader & Mullion Smart Reader (LF) with Taiyo Yuden Model EYSGJN, under Openpath Security Inc.’s purchase order number PO-2004.

This document describes the test setups, test methods, required test equipment, and the test limit criteria used to perform compliance testing of the Openpath Security Inc., Smart Reader & Mullion Smart Reader (LF) with Taiyo Yuden Model EYSGJN.

The results obtained relate only to the item(s) tested.

Model(s) Tested:	Mullion Smart Reader (LF) with Taiyo Yuden Model EYSGJN	
Model(s) Covered:	Mullion Smart Reader (LF) with Taiyo Yuden Model EYSGJN	
EUT Specifications:	Primary Power: 12VDC	
	FCC ID: 2APJVOPRLF	
	Type of Modulations:	GFSK
	Equipment Code:	DTS
	Peak RF Output Power:	2.5 mW
	EUT Frequency Ranges:	2402-2480MHz
Analysis:	The results obtained relate only to the item(s) tested.	
Environmental Test Conditions:	Temperature: 15-35° C	
	Relative Humidity: 30-60%	
	Barometric Pressure: 860-1060 mbar	
Evaluated by:	James Borrott	
Report Date(s):	April 23, 2019	

Table 2. EUT Summary Table

B. References

CFR 47, Part 15, Subpart C	Federal Communication Commission, Code of Federal Regulations, Title 47, Part 15: General Rules and Regulations, Allocation, Assignment, and Use of Radio Frequencies
ANSI C63.4:2014	Methods and Measurements of Radio-Noise Emissions from Low-Voltage Electrical And Electronic Equipment in the Range of 9 kHz to 40 GHz
ISO/IEC 17025:2017	General Requirements for the Competence of Testing and Calibration Laboratories
ANSI C63.10-2013	American National Standard for Testing Unlicensed Wireless Devices

Table 3. References

C. Test Site

All testing was performed at Eurofins MET Labs, 3162 Belick Street, Santa Clara, CA 95054. All equipment used in making physical determinations is accurate and bears recent traceability to the National Institute of Standards and Technology.

Radiated Emissions measurements were performed in a 10 meter semi-anechoic chamber (equivalent to an Open Area Test Site). In accordance with §2.948(a)(3), a complete site description is contained at MET Laboratories.

D. Description of Test Sample

The Openpath Security Inc. Smart Reader & Mullion Smart Reader (LF) with Taiyo Yuden Model EYSGJN, Equipment Under Test (EUT), is a contactless smart card and mobile-enabled access control reader. It is an RFID card reader, BLE beacon and interface for BLE-enabled smartphones, and a touch sensor in order to allow entry to the secure location. It communicates over RS-485 to the Openpath Smart Hub in order to authenticate users, and receives 12V power from the Smart Hub. It is intended to be used by anyone that accesses the secured location's entrance/exit.



Photograph 1. Openpath Security Inc. Smart Reader & Mullion Smart Reader (LF) with Taiyo Yuden Model EYSGJN

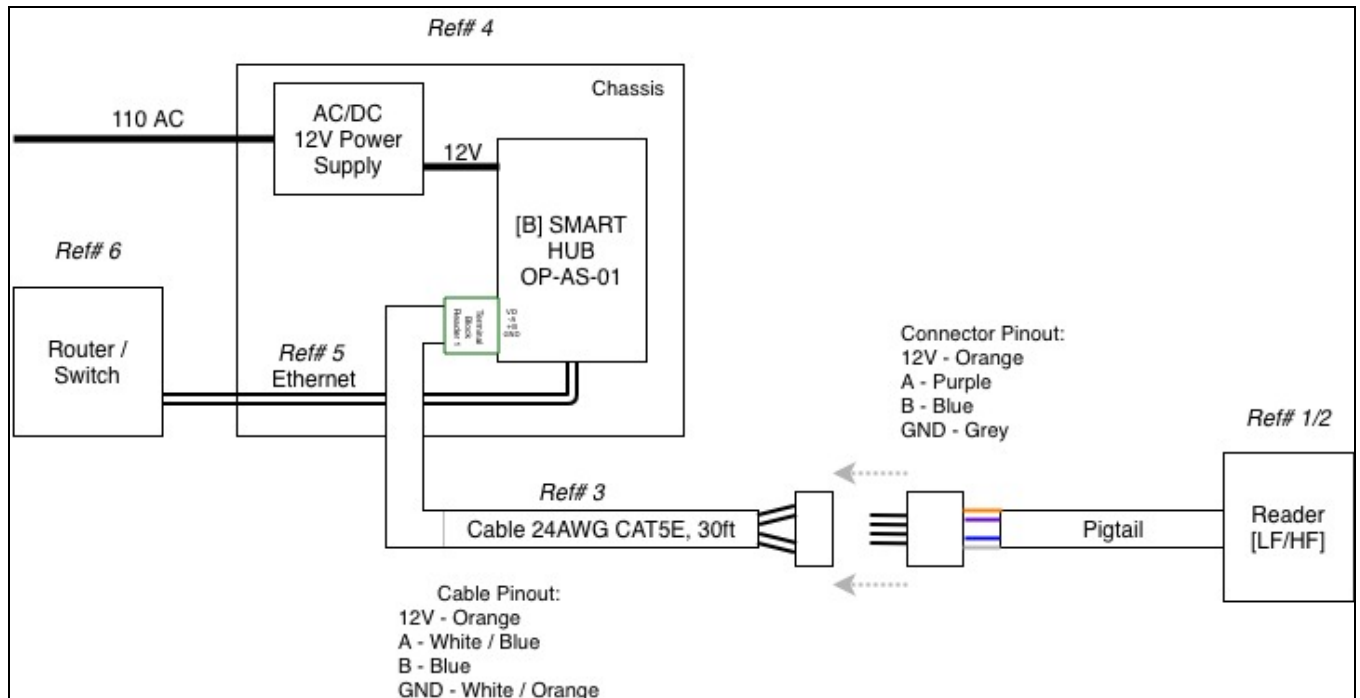

Figure 1. Block Diagram of Test Configuration, Standard Smart Reader (LF)

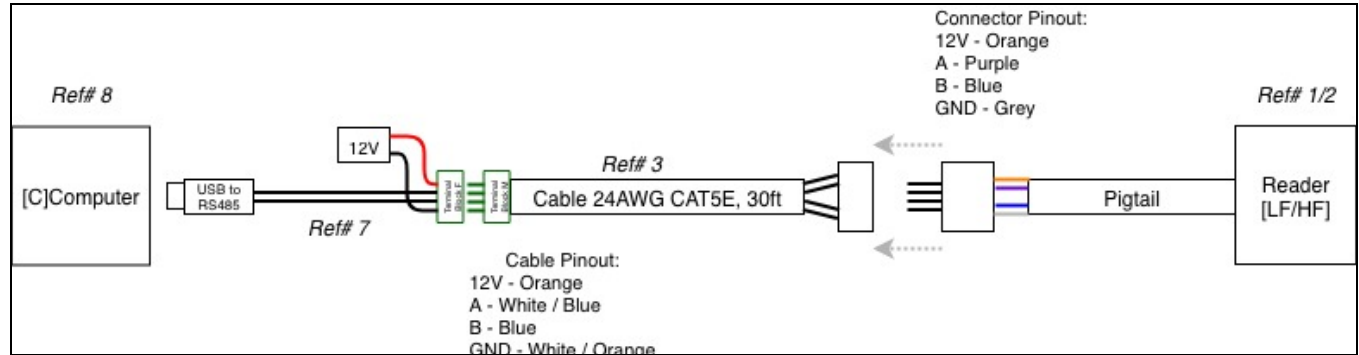

Figure 2. Block Diagram of Test Configuration, Mullion Smart Reader (LF)

E. Equipment Configuration

The EUT was set up as outlined in **Error! Reference source not found.**, Block Diagram of Test Setup. All cards, racks, etc., incorporated as part of the EUT is included in the following list.

Ref. ID	Name / Description	Part Number	Serial Number
1	Smart Reader LF	OP-ASSY-RDRL-001	ENG 4 -LF

Table 4. Equipment Configuration, Standard Smart Reader (LF)

Ref. ID	Name / Description	Part Number	Serial Number
2	Mullion Smart Reader LF	OP-ASSY-RDRL-002	ENG 5 -LF

Table 5. Equipment Configuration, Mullion Smart Reader (LF)

F. Support Equipment

Support equipment necessary for the operation and testing of the EUT is included in the following list.

Ref. ID	Name / Description	Manufacturer	Model Number
4	Smart Hub	Openpath	OP-AS-01
--	Prox Card (LF)	--	--
--	Phone	--	--
6	Router / Switch	--	--

Table 6. Support Equipment, Standard Smart Reader (LF)

Ref. ID	Name / Description	Manufacturer	Model Number
8	Computer	--	--
--	Prox Card (LF)	--	--
--	Phone	--	--

Table 7. Support Equipment, Mullion Smart Reader (LF)

G. Ports and Cabling Information

Ref. ID	Cable Description or reason for no cable	Qty	Length as tested (m)	Shielded? (Y/N)	Termination Box ID & Port Name
3	CAT5E Cable 24awg	1	9.14m	Yes	B. Reader 1
5	Ethernet cable	1	--	Yes	B. Ethernet
--	110V AC	1	--	--	4. AC/DC 12V PS

Table 8. Ports and Cabling Information, Standard Smart Reader (LF)

Ref. ID	Cable Description or reason for no cable	Qty	Length as tested (m)	Shielded? (Y/N)	Termination Box ID & Port Name
3	CAT5E Cable 24awg	1	9.14m	Yes	B. Reader 1
7	USB to Reader test cable	1	--	Yes	C. Computer
--	12V 1A Power supply	1	--	--	Terminal Block, CAT5E Cable

Table 9. Ports and Cabling Information, Mullion Smart Reader (LF)

H. Mode of Operation

The Openpath Smart Reader can be tested in either production mode or test mode depending on which unit is tested.

The production mode unit will need to be wired to the Openpath Smart Hub in order to operate normally. It will allow the operator to scan RFID cards: one Reader will be configured to read 13.56MHz cards and another will be configured to read 125kHz cards. The Readers will also broadcast a BLE beacon and attempt to pair with nearby smartphones running Openpath software.

The test mode Smart Reader will have a test suite giving the operator full control of the BLE radios through a serial interface. The test mode will allow the operator to configure the two BLE radios independently to: fixed channels at maximum duty cycle, power control, and turn them on or off.

I. Method of Monitoring EUT Operation

Production mode:

If the center dot quickly switches between multiple colors and outer ring quickly spins once, the reader has just received power

If all lights are off, the reader is not connected to power (check to see if the power wires are swapped)

If the center dot is flashing red, the reader is connected to power but cannot communicate with the Smart Hub (check to see if the +B and -A lines are swapped)

If the center dot is solid blue, the reader is connected to power and can communicate with the Smart Hub, but has not been configured as an entry in the online portal

If the center dot is solid white, then the door is locked

If the outer ring is solid white, then the door is unlocked

Test mode:

The center dot will remain white and the status can be monitored in the serial console that is used to control the Smart Reader.

J. Modifications

a) Modifications to EUT

No modifications were made to the EUT.

b) Modifications to Test Standard

No modifications were made to the test standard.

K. Disposition of EUT

The test sample including all support equipment submitted to the Electro-Magnetic Compatibility Lab for testing was returned to Openpath Security Inc. upon completion of testing.

III. Electromagnetic Compatibility Criteria for Intentional Radiators

Electromagnetic Compatibility Criteria for Intentional Radiators

§ 15.203 Antenna Requirement

Test Requirement: § 15.203: An intentional radiator shall be designed to ensure that no antenna other than that furnished by the responsible party shall be used with the device. The use of a permanently attached antenna or of an antenna that uses a unique coupling to the intentional radiator shall be considered sufficient to comply with the provisions of this section. The manufacturer may design the unit so that a broken antenna can be replaced by the user, but the use of a standard antenna jack or electrical connector is prohibited.

The structure and application of the EUT were analyzed to determine compliance with Section 15.203 of the Rules. Section 15.203 states that the subject device must meet at least one of the following criteria:

- a.) Antenna must be permanently attached to the unit.
- b.) Antenna must use a unique type of connector to attach to the EUT.
- c.) Unit must be professionally installed. Installer shall be responsible for verifying that the correct antenna is employed with the unit.

Results: The EUT as tested is compliant the criteria of §15.203. The EUT antenna is integrated into the unit and cannot be modified by the user. PCB antenna with a gain of -1.5 dBi.

Test Engineer(s): James Borrott

Test Date(s): 12/19/18

Electromagnetic Compatibility Criteria for Intentional Radiators

§ 15.207(a) Conducted Emissions Limits

Test Requirement(s): § 15.207 (a): For an intentional radiator that is designed to be connected to the public utility (AC) power line, the radio frequency voltage that is conducted back onto the AC power line on any frequency or frequencies, within the band 150 kHz to 30MHz, shall not exceed the limits in the following table, as measured using a 50 μ H/50 Σ line impedance stabilization network (LISN). Compliance with the provisions of this paragraph shall be based on the measurement of the radio frequency voltage between each power line and ground at the power terminal. The lower limit applies at the boundary between the frequency ranges.

Frequency range (MHz)	§ 15.207(a), Conducted Limit (dB μ V)	
	Quasi-Peak	Average
* 0.15- 0.5	66 - 56	56 - 46
0-5.5	56	46
5- 30	60	50

Table 10. Conducted Limits for Intentional Radiators from FCC Part 15 § 15.207(a)

Test Procedure: The EUT was placed on a non-metallic table located 80 cm from a horizontal ground plane and 40cm away from a vertical ground plane. The method of testing, test conditions, and test procedures of *EN 55032* were used. The EMC receiver scanned the frequency range from 150 kHz to 30 MHz. The measurements were performed over the frequency range of 0.15 MHz to 30 MHz using a 50 Ω / 50 μ H as the input transducer to an EMC field intensity meter. Unless otherwise specified, measurements were made using a quasi-peak and average detector.

Test Results: The EUT as tested is compliant with the requirements of this section. Measured emissions were within applicable limits.

Test Engineer: James Borrott

Test Date: 05/09/2019

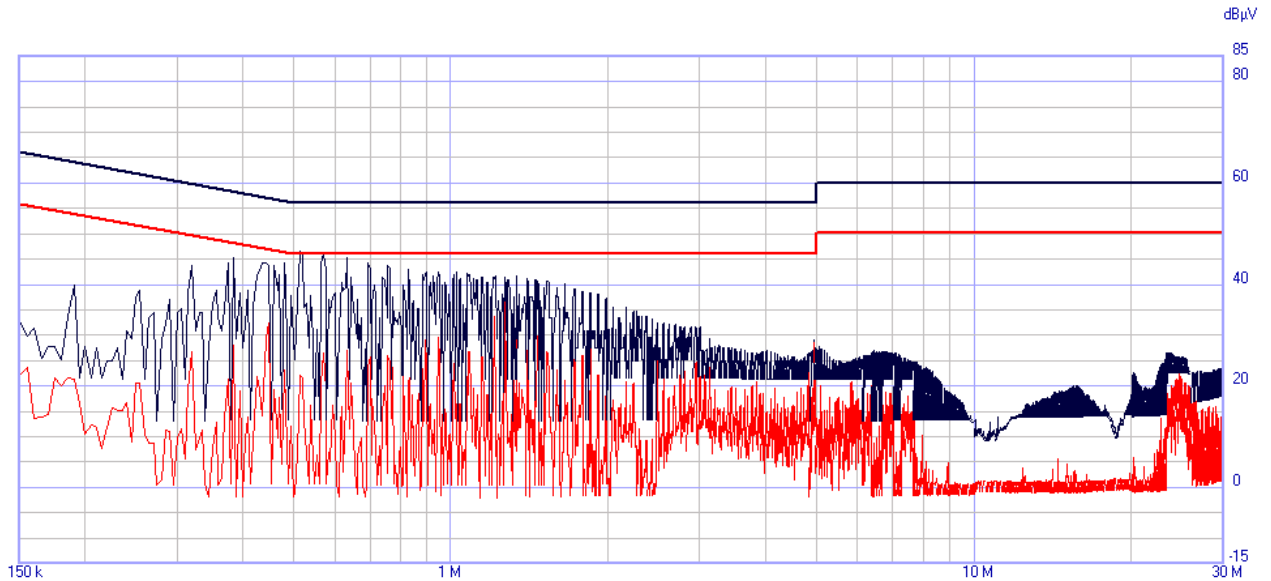

Plot 1. Conducted Emissions, Line

Line	Freq (MHz)	QP Amplitude	QP Limit	Delta	Pass	Average Amplitude	Average Limit	Delta	Pass	Notes
Line	.515	50.52	56	-5.48	Pass	33.68	46	-12.32	Pass	
Line	.57	50.41	56	-5.59	Pass	32.75	46	-13.25	Pass	
Line	.635	50.34	56	-5.66	Pass	33.81	46	-12.19	Pass	
Line	.48	50.38	56.349	-5.969	Pass	31.64	46.349	-14.709	Pass	
Line	.385	50.14	58.192	-8.052	Pass	32.65	48.192	-15.542	Pass	
Line	.375	50.14	58.41	-8.27	Pass	31.89	48.41	-16.52	Pass	

Table 11. Conducted Emissions, Line, Test Results

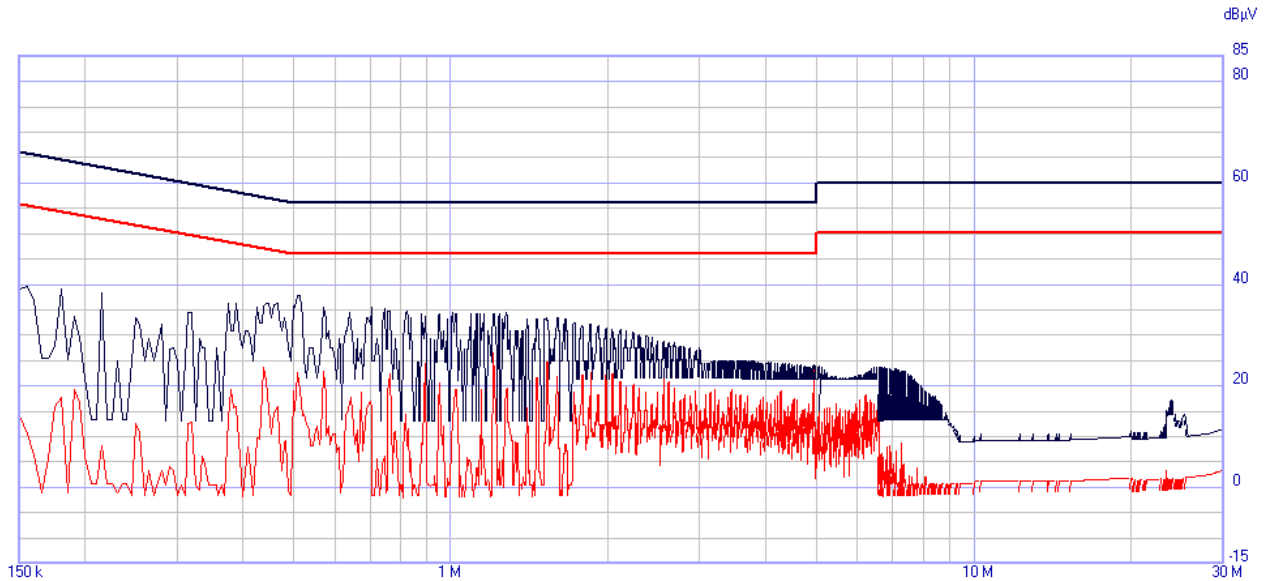

Plot 2. Conducted Emissions, Neutral

Line	Freq (MHz)	QP Amplitude	QP Limit	Delta	Pass	Average Amplitude	Average Limit	Delta	Pass	Notes
Neutral	.515	38.98	56	-17.02	Pass	30.79	46	-15.21	Pass	
Neutral	.445	38.72	56.993	-18.273	Pass	30.62	46.993	-16.373	Pass	
Neutral	.39	38.71	58.085	-19.375	Pass	30.61	48.085	-17.475	Pass	
Neutral	.215	38.87	63.018	-24.148	Pass	30.77	53.018	-22.248	Pass	
Neutral	.18	39.07	64.49	-25.42	Pass	30.97	54.49	-23.52	Pass	
Neutral	.155	39.22	65.728	-26.508	Pass	31.12	55.728	-24.608	Pass	

Table 12. Conducted Emissions, Neutral, Test Results

Electromagnetic Compatibility Criteria for Intentional Radiators

§ 15.247(d) Radiated Spurious Emissions Requirements and Band Edge

Test Requirements: §15.247(d); §15.205: Emissions outside the frequency band.

§15.247(d): In any 100 kHz bandwidth outside the frequency band in which the spread spectrum or digitally modulated intentional radiator is operating, the radio frequency power that is produced by the intentional radiator shall be at least 20 dB below that in the 100 kHz bandwidth within the band that contains the highest level of the desired power, based on either an RF conducted or a radiated measurement. Attenuation below the general limits specified in § 15.209(a) is not required. In addition, radiated emissions which fall in the restricted bands, as defined in § 15.205(a), must also comply with the radiated emission limits specified in § 15.209(a).

§15.205(a): Except as shown in paragraph (d) of this section, only spurious emissions are permitted in any of the frequency bands listed below:

MHz	MHz	MHz	GHz
0.090–0.110-----	16.42–16.423	399.9–410	4.5–5.15
¹ 0.495–0.505-----	16.69475–16.69525	608–614	5.35–5.46
2.1735–2.1905-----	16.80425–16.80475	960–1240	7.25–7.75
4.125–4.128-----	25.5–25.67	1300–1427	8.025–8.5
4.17725–4.17775-----	37.5–38.25	1435–1626.5	9.0–9.2
4.20725–4.20775-----	73–74.6	1645.5–1646.5	9.3–9.5
6.215–6.218-----	74.8–75.2	1660–1710	10.6–12.7
6.26775–6.26825-----	108–121.94	1718.8–1722.2	13.25–13.4
6.31175–6.31225-----	123–138	2200–2300	14.47–14.5
8.291–8.294-----	149.9–150.05	2310–2390	15.35–16.2
8.362–8.366-----	156.52475–156.52525	2483.5–2500	17.7–21.4
8.37625–8.38675-----	156.7–156.9	2655–2900	22.01–23.12
8.41425–8.41475-----	162.0125–167.17	3260–3267	23.6–24.0
12.29–12.293-----	167.72–173.2	3332–3339	31.2–31.8
12.51975–12.52025-----	240–285	3345.8–3358.36	43–36.5
12.57675–12.57725-----	322–335.4	3600–4400	(²)

Table 11. Restricted Bands of Operation

¹ Until February 1, 1999, this restricted band shall be 0.490 – 0.510 MHz.

² Above 38.6

Test Requirement(s): § 15.209 (a): Except as provided elsewhere in this subpart, the emissions from an intentional radiator shall not exceed the field strength levels specified in Table .

Frequency (MHz)	§ 15.209(a), Radiated Emission Limits (dBµV) @ 3m
30 - 88	40.00
88 - 216	43.50
216 - 960	46.00
Above 960	54.00

Table 12. Radiated Emissions Limits Calculated from FCC Part 15, § 15.209 (a)

Test Procedures: The transmitter was setup in a semi-anechoic chamber 3m from the measurement antenna. Below 1GHz, the EUT was placed at a height of 80cm; Above 1GHz, the EUT was placed at a height of 150cm on an RF transparent table. The transmitter was turned on. Measurements were performed of the low, mid and high Channels. The EUT was rotated orthogonally through all three axes and measurement antenna polarized both vertically and horizontally. Plots shown are corrected and compared to a 3 m limit line. Only noise floor was measured above 18 GHz.

Pre-scans were performed using a peak detector to identify frequencies of note. Emissions less than 6dB below the limit were investigated further. Emissions below 1 GHz were investigated using a Quasi-Peak detector.

Scans were also performed with all intentional transmitters active at their highest power as to satisfy ANSI C63.10-2013 Section 5.10.6 on composite devices.

Test Results: The EUT was compliant with the Radiated Spurious Emission limits of § 15.247(d). Measured emissions were within applicable limits.

Test Engineer(s): James Borrott

Test Date(s): 12/19/18

Radiated Spurious Emissions Test Results

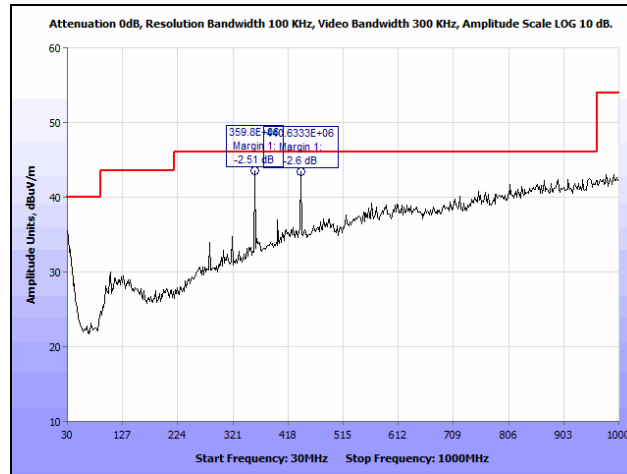

Plot 3. Radiated Spurious Emissions, Low Channel, 30 MHz – 1 GHz

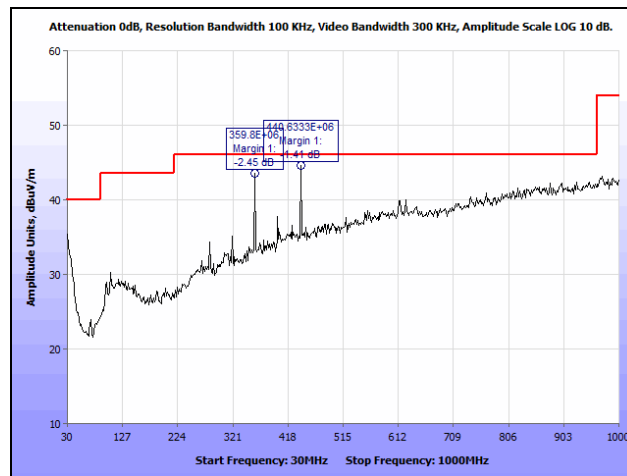

Plot 4. Radiated Spurious Emissions, Mid Channel, 30 MHz – 1 GHz

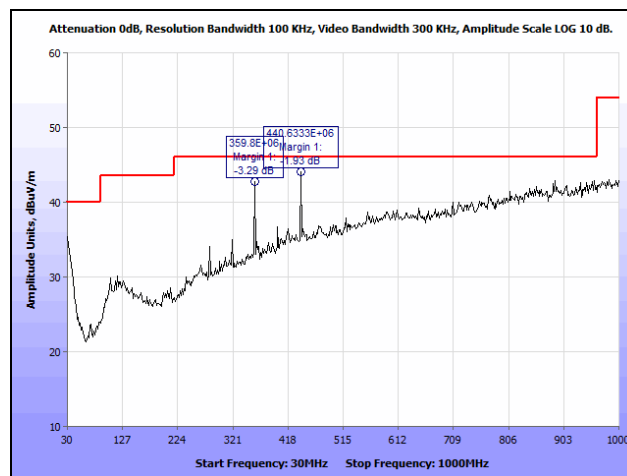

Plot 5. Radiated Spurious Emissions, High Channel, 30 MHz – 1 GHz

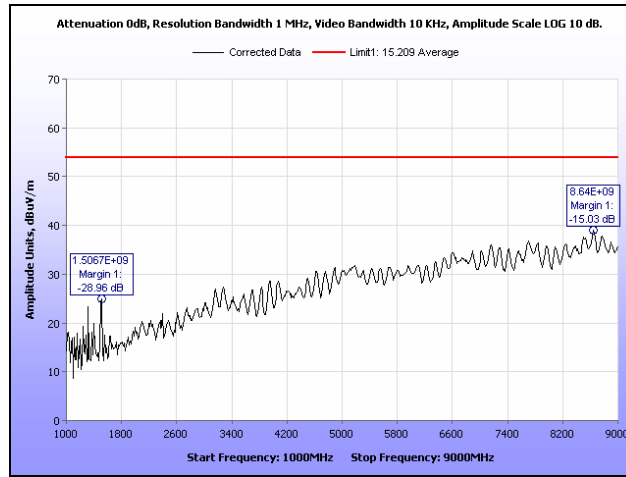

Plot 6. Radiated Spurious Emissions, Low Channel, 1 GHz – 9 GHz, Average

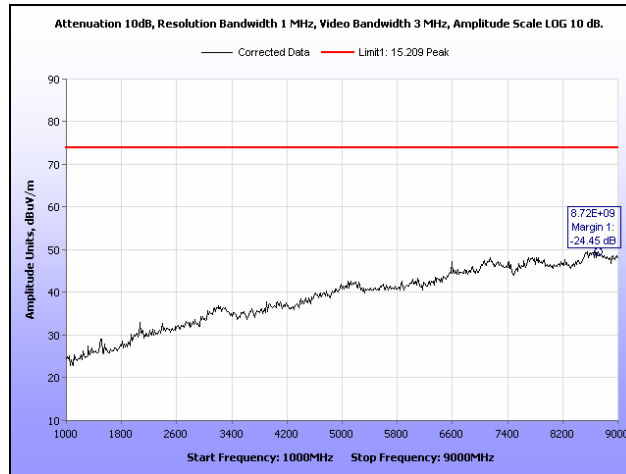

Plot 7. Radiated Spurious Emissions, Low Channel, 1 GHz – 9 GHz, Peak

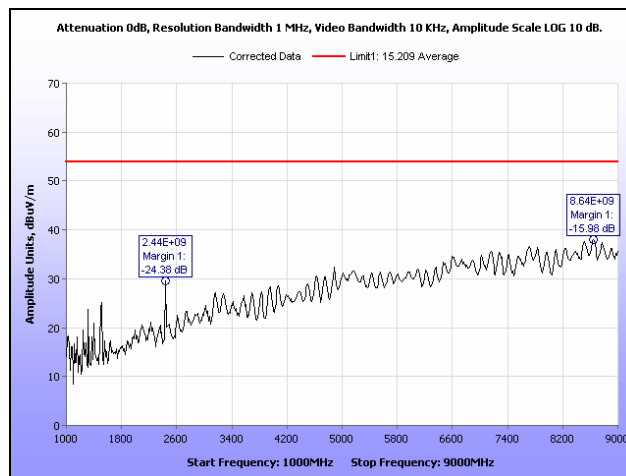

Plot 8. Radiated Spurious Emissions, Mid Channel, 1 GHz – 9 GHz, Average

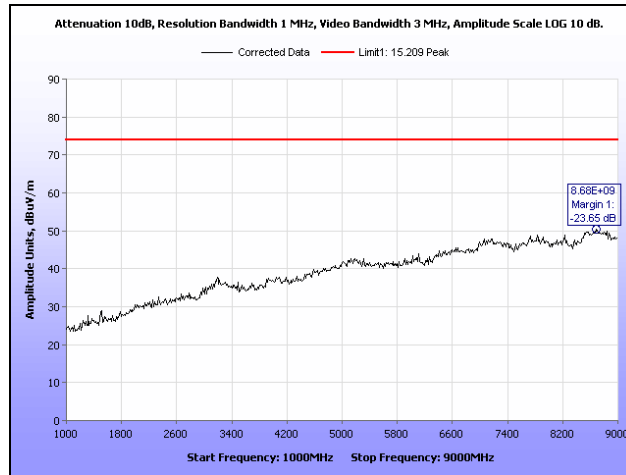

Plot 9. Radiated Spurious Emissions, Mid Channel, 1 GHz – 9 GHz, Peak

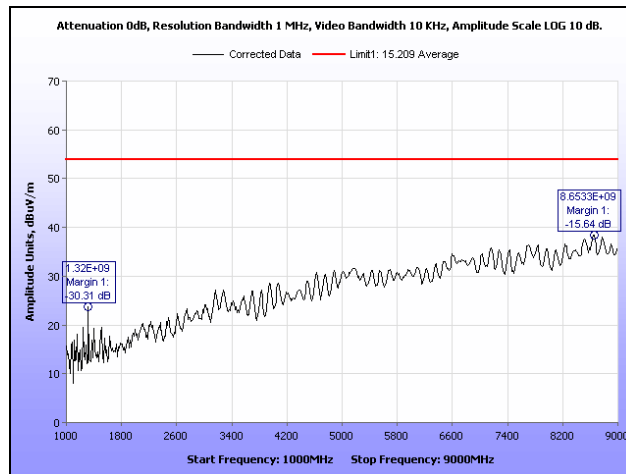

Plot 10. Radiated Spurious Emissions, High Channel, 1 GHz – 9 GHz, Average

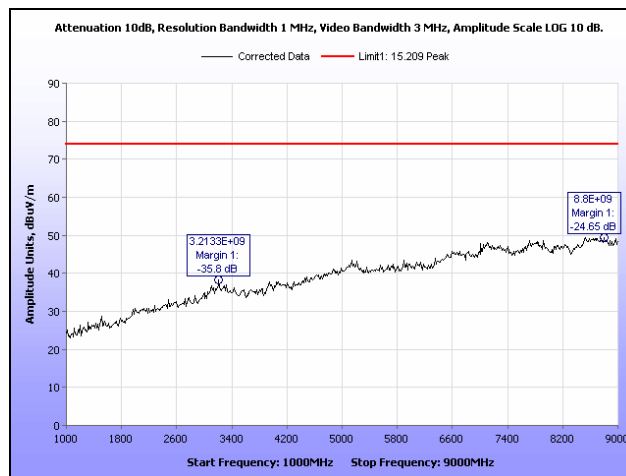

Plot 11. Radiated Spurious Emissions, High Channel, 1 GHz – 9 GHz, Peak

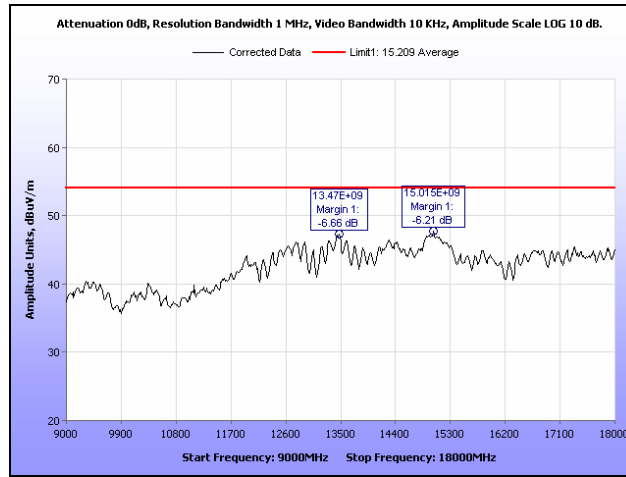

Plot 12. Radiated Spurious Emissions, Low Channel, 9 GHz – 18 GHz, Average

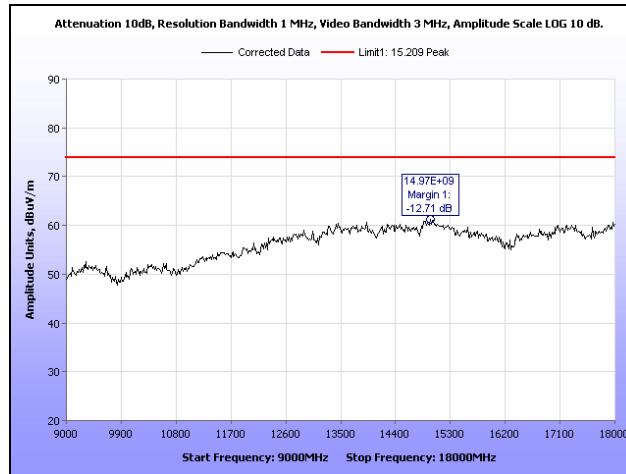

Plot 13. Radiated Spurious Emissions, Low Channel, 9 GHz – 18 GHz, Peak

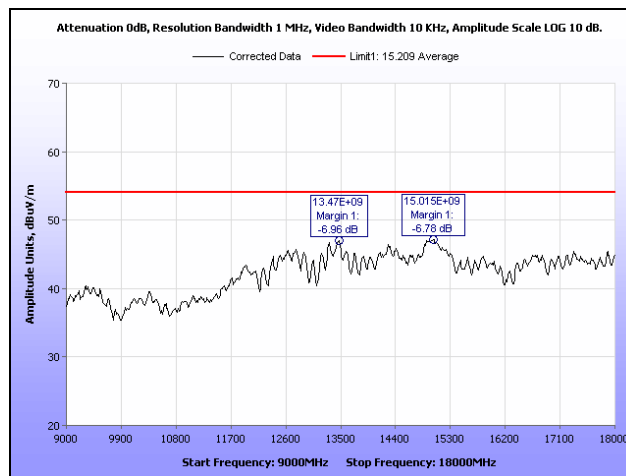

Plot 14. Radiated Spurious Emissions, Mid Channel, 9 GHz – 18 GHz, Average

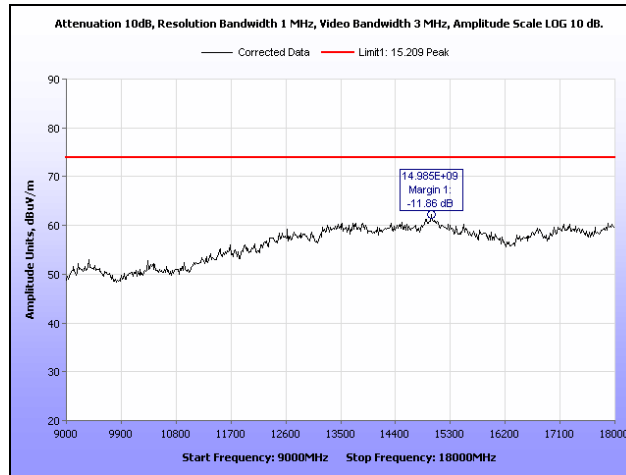

Plot 15. Radiated Spurious Emissions, Mid Channel, 9 GHz – 18 GHz, Peak

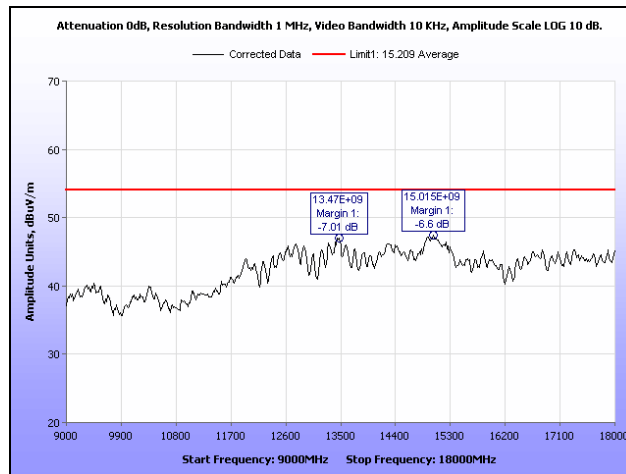

Plot 16. Radiated Spurious Emissions, High Channel, 9 GHz – 18 GHz, Average

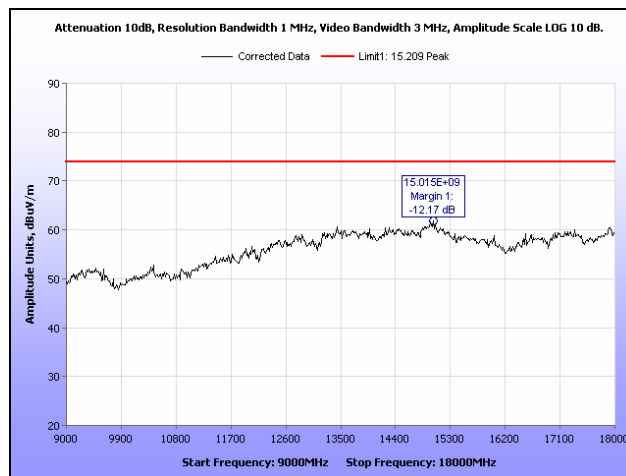

Plot 17. Radiated Spurious Emissions, High Channel, 9 GHz – 18 GHz, Peak

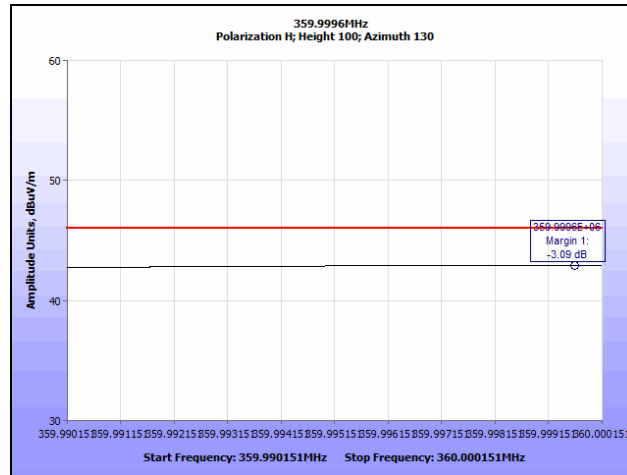

Plot 18. Radiated Spurious Emissions, Low Channel, 359.996 MHz QP

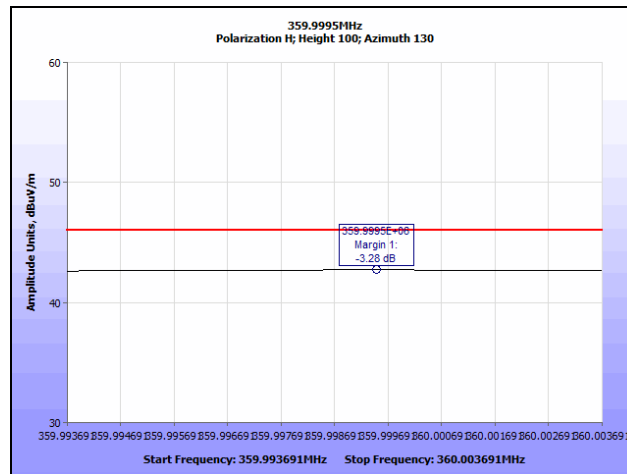

Plot 19. Radiated Spurious Emissions, Mid Channel, 359.9995 MHz QP

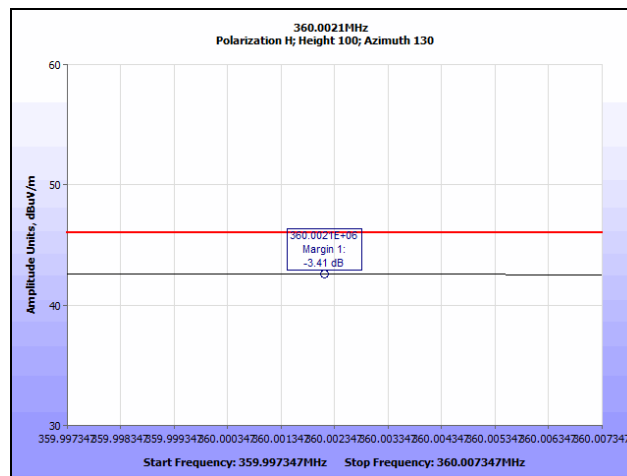

Plot 20. Radiated Spurious Emissions, High Channel, 360.0021 MHz QP

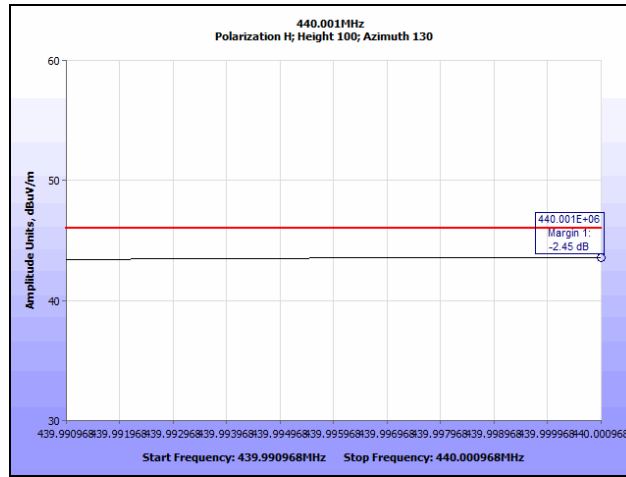

Plot 21. Radiated Spurious Emissions, Low Channel, 440.001 MHz QP

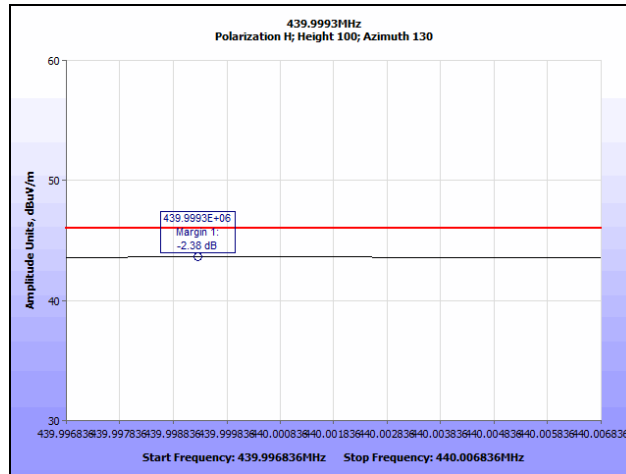

Plot 22. Radiated Spurious Emissions, Mid Channel, 439.9993 MHz QP

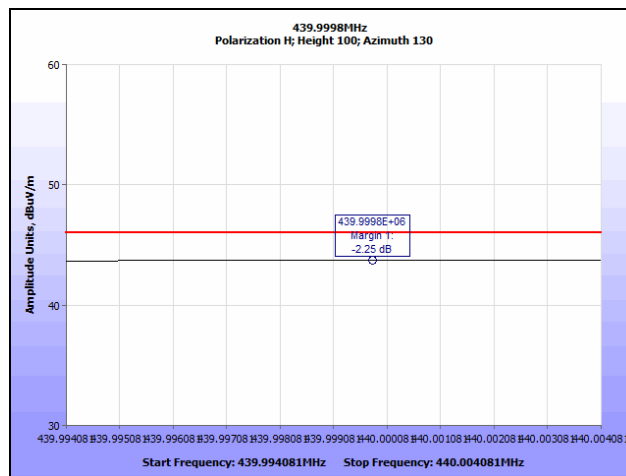

Plot 23. Radiated Spurious Emissions, High Channel, 439.9998 MHz QP

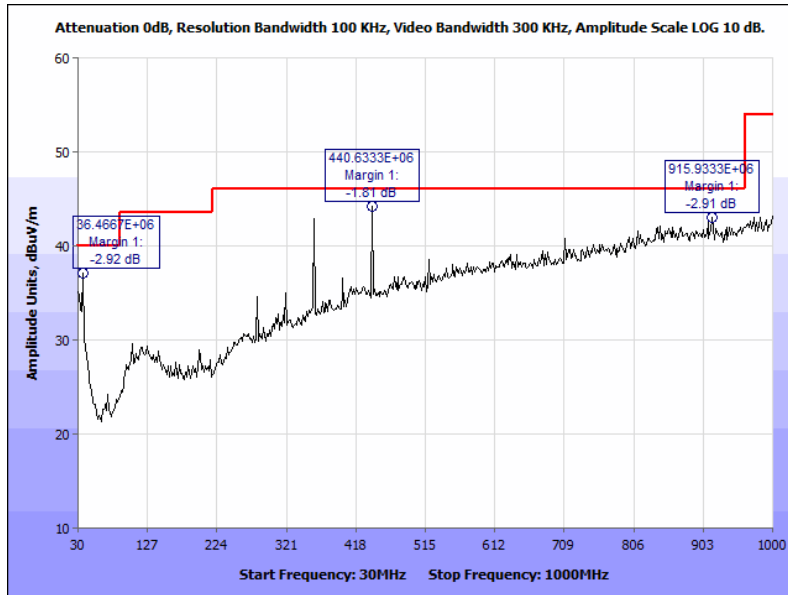

Plot 24. Radiated Spurious Emissions, All Tx Active, 30-1000MHz

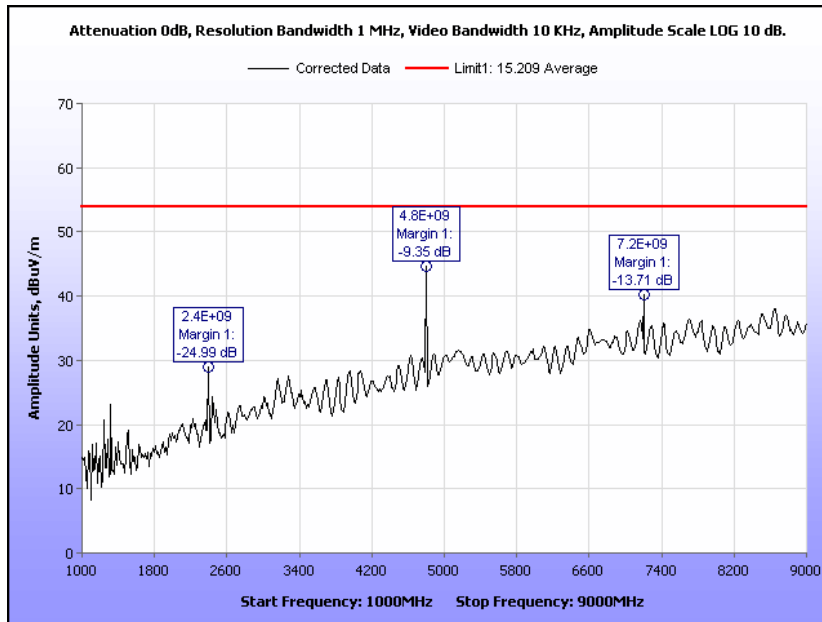

Plot 25. Radiated Spurious Emissions, All Tx Active, 1-9GHz Average

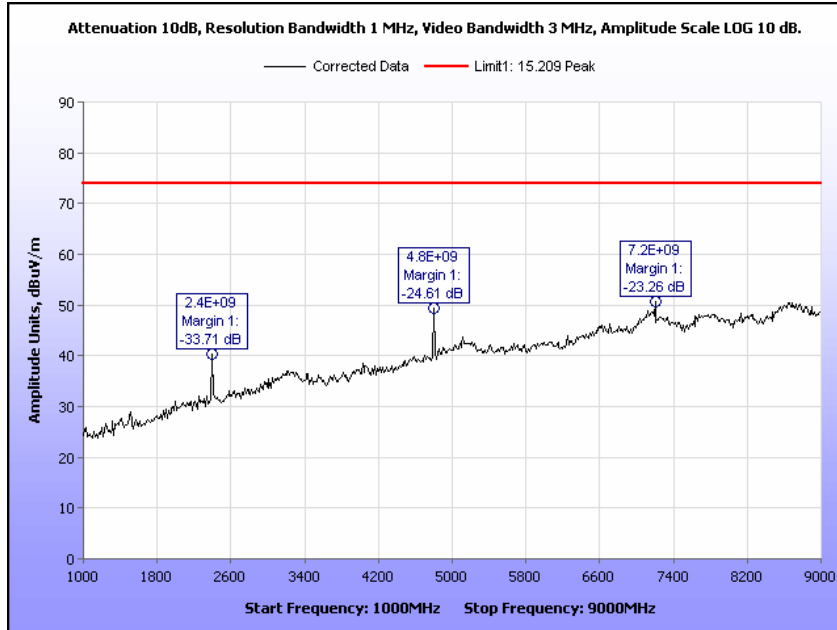

Plot 26. Radiated Spurious Emissions, All Tx Active, 1-9GHz Peak

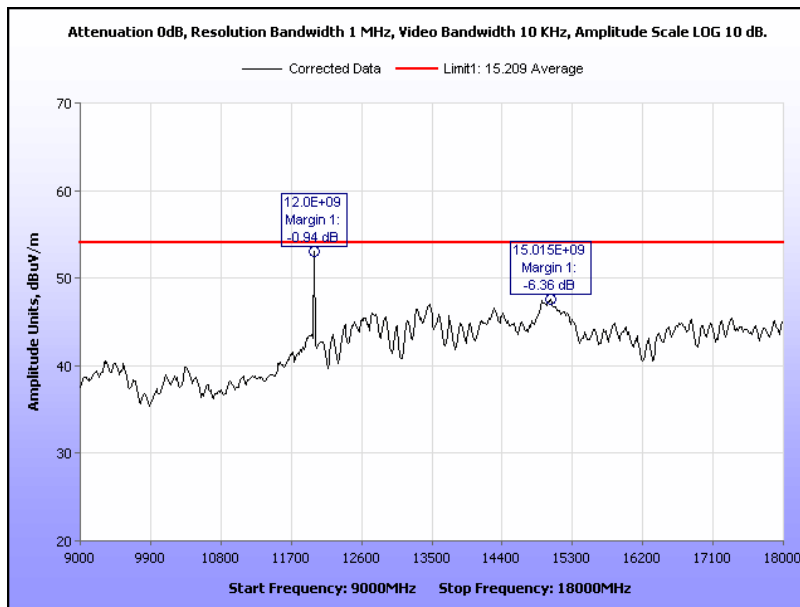

Plot 27. Radiated Spurious Emissions, All Tx Active, 9-18GHz Average

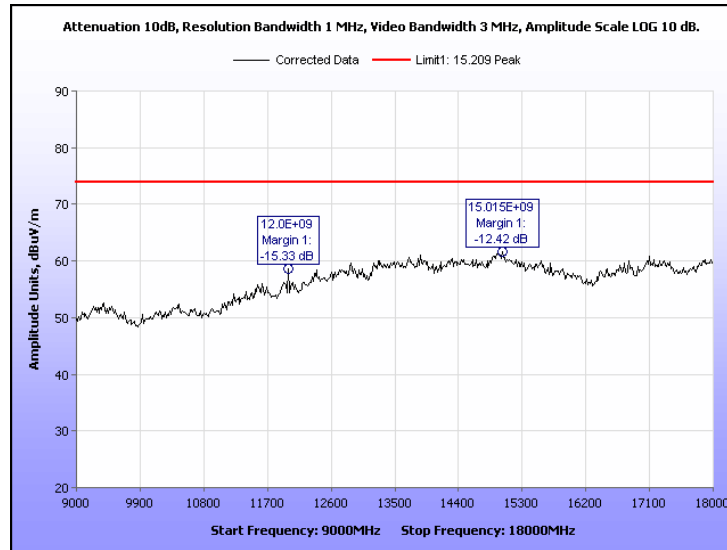

Plot 28. Radiated Spurious Emissions, All Tx Active, 1-9GHz Peak

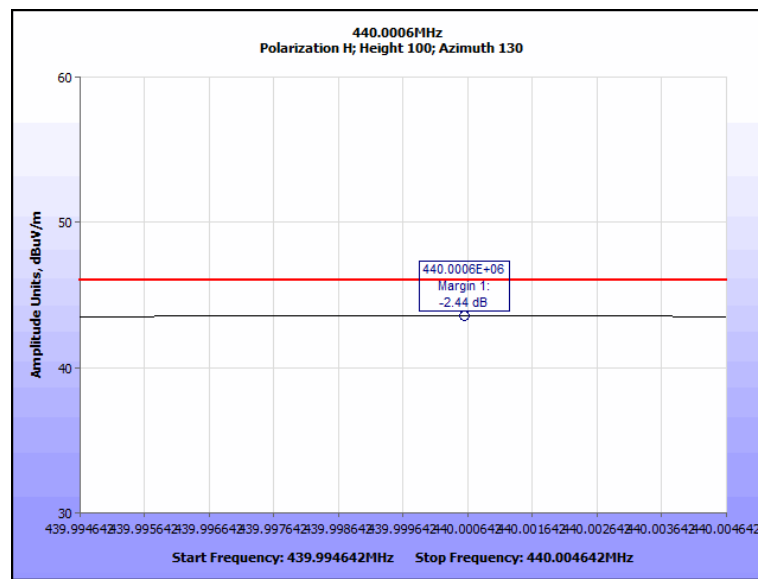

Plot 29. Radiated Spurious Emissions, All Tx Active, 440 MHz QP

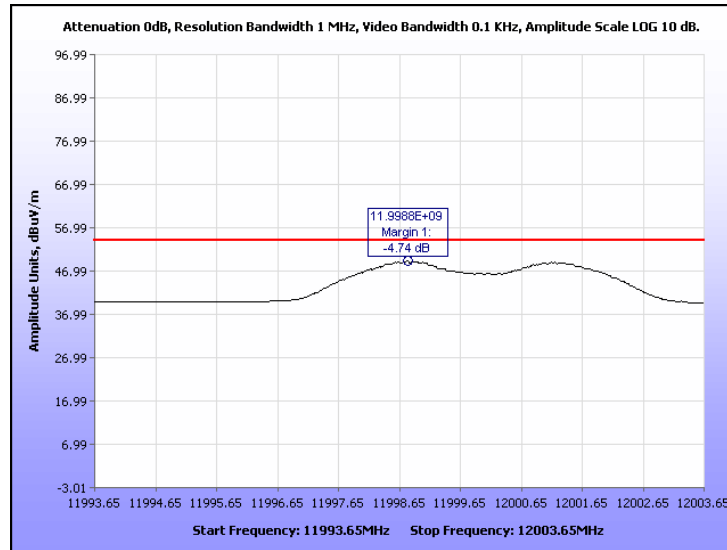

Plot 30. Radiated Spurious Emissions, All Tx Active, 11.98 GHz Average

Radiated Band Edge Measurements

Test Procedures: The transmitter was turned on. Measurements were performed of the low, mid and high Channels. The EUT was rotated orthogonally through all three axes. Plots shown are corrected for both antenna correction factor and distance and compared to a 3 m limit line.

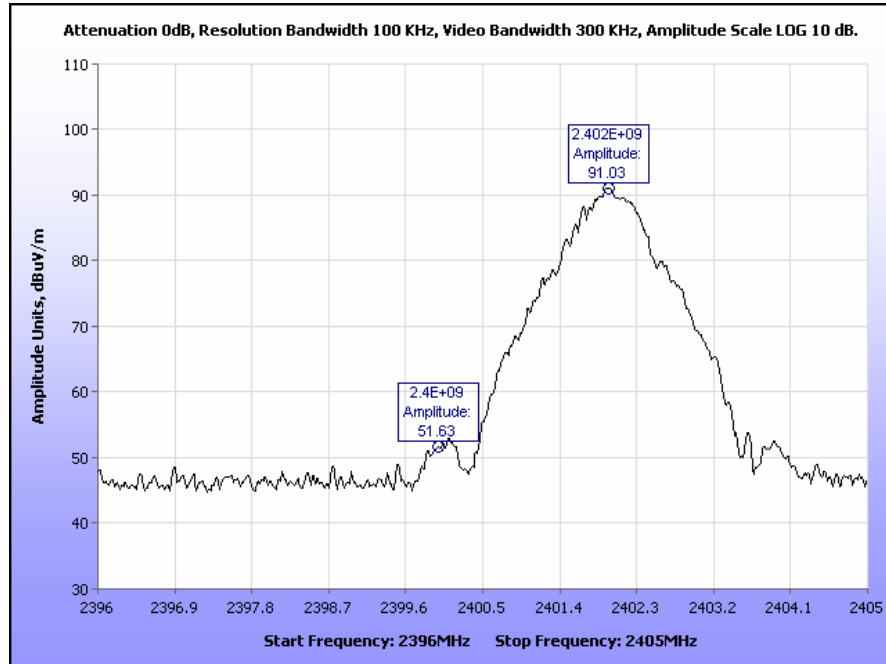

Plot 31. Radiated Restricted Band Edge, Low Channel, 20 dBc, 2400 MHz

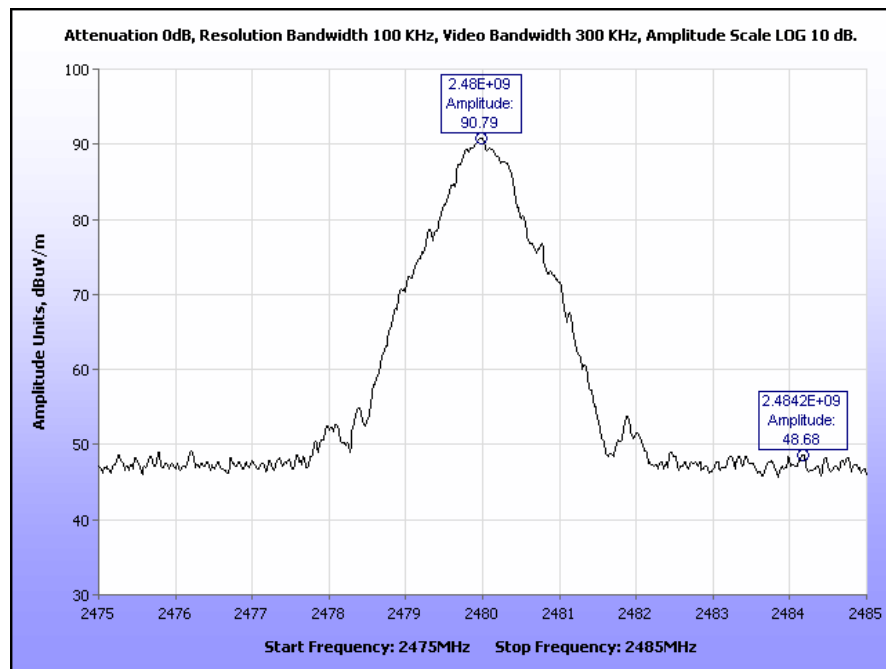

Plot 32. Radiated Restricted Band Edge, High Channel, 20 dBc, 2483.5 MHz

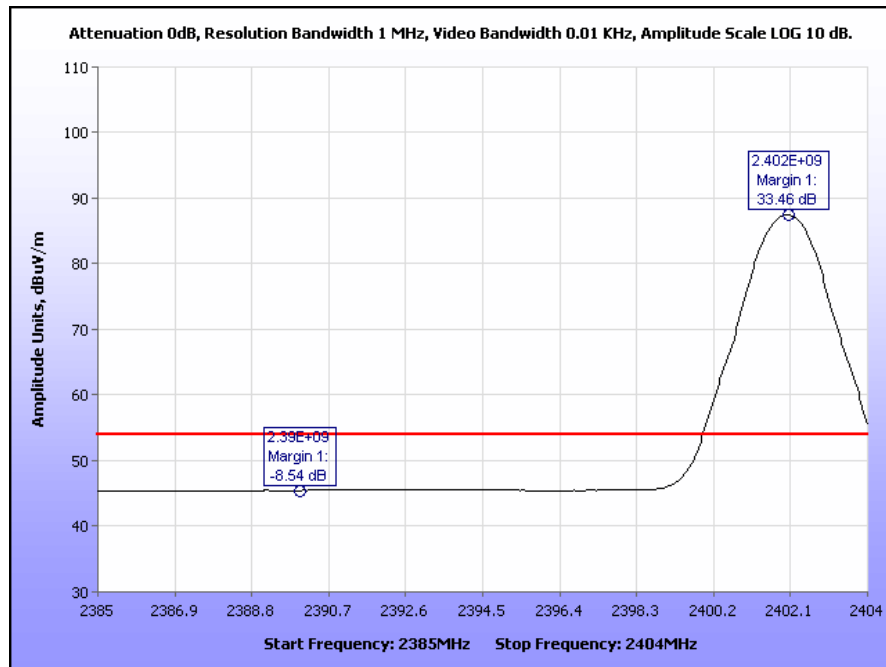

Plot 33. Radiated Restricted Band Edge, Low Channel, 2390 MHz, Average

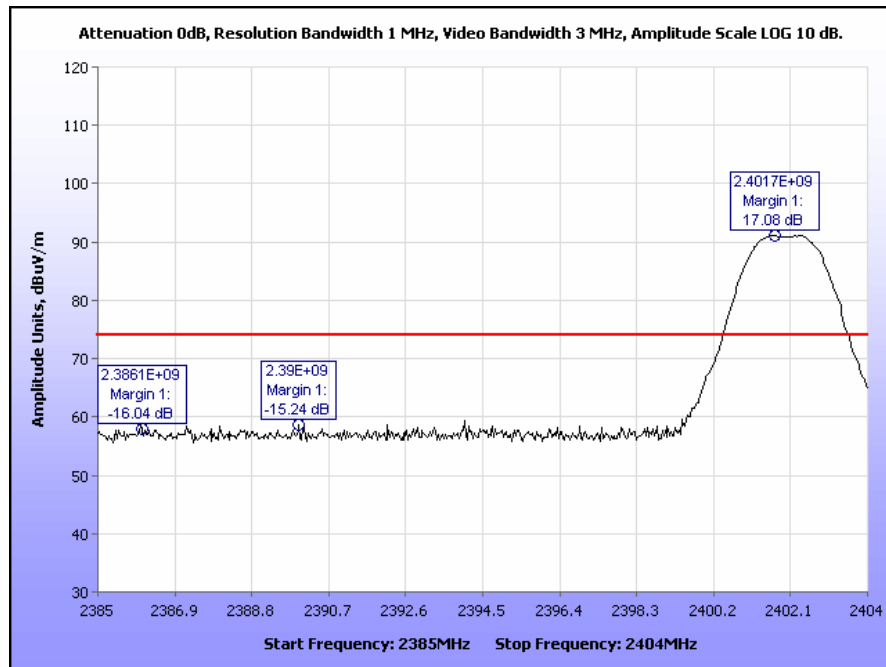

Plot 34. Radiated Restricted Band Edge, Low Channel, 2390 MHz, Peak

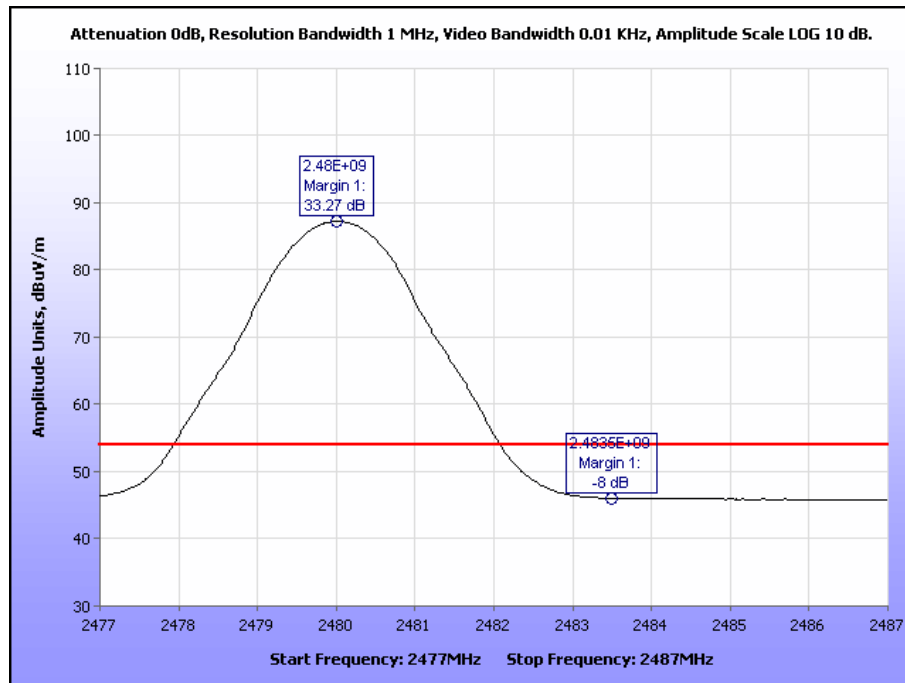

Plot 35. Radiated Restricted Band Edge, High Channel, 2483.5 MHz, Average

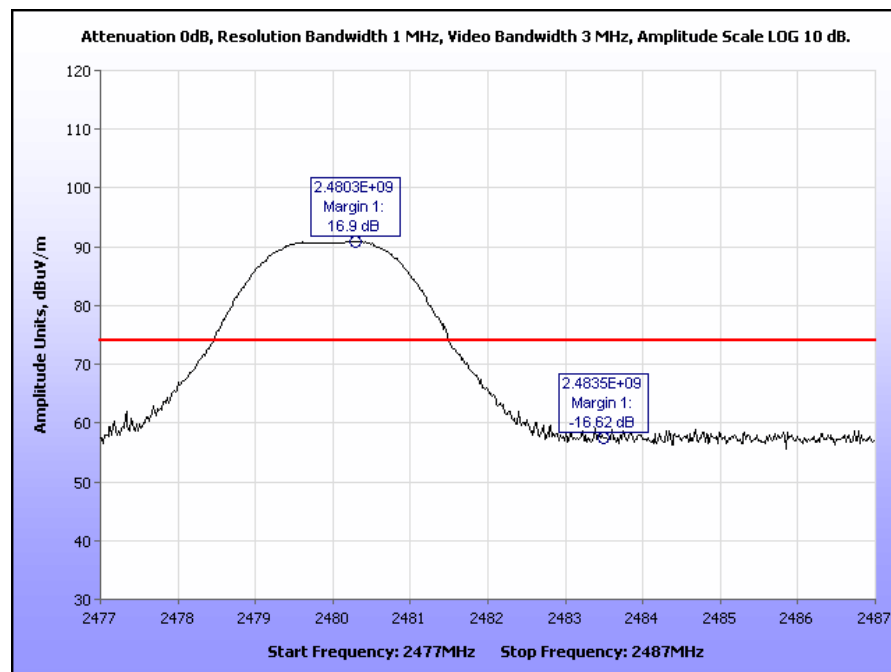

Plot 36. Radiated Restricted Band Edge, High Channel, 2483.5 MHz, Peak

Radiated Spurious Emissions Test Setup



Photograph 2. Radiated Spurious Emissions, Test Setup, 30 MHz – 1 GHz

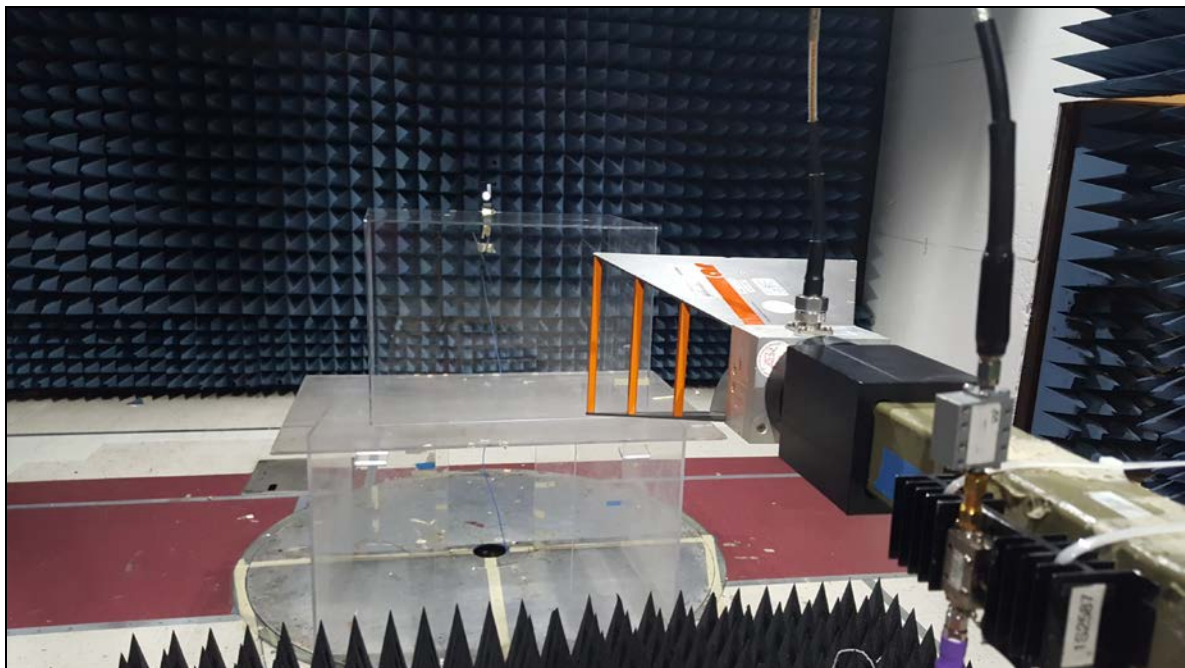

Photograph 3. Radiated Spurious Emissions, Test Setup, 1 GHz – 18 GHz

IV. Test Equipment

Test Equipment

Calibrated test equipment utilized during testing was maintained in a current state of calibration per the requirements of ISO/IEC 17025:2017.

MET Asset #	Equipment	Manufacturer	Model	Last Cal Date	Cal Due Date
1S2399	TURNTABLE CONTROLLER	SUNOL SCIENCE	SC99V	SEE NOTE	
1S2000	SPECTRUM ANALYZER	AGILENT	E4448A	10/17/2018	10/17/2019
1S2482	5 METER CHAMBER	PANASHIELD	5 METER SEMI-ANECHOIC CHAMBER	SEE NOTE	
1S2600	BILOG ANTENNA	TESEQ	CBL6112D	11/28/2016	01/28/2019
--	HORN ANTENNA	AR RF/MICROWAVE	ATH1G18A	4/20/22018	4/20/2020
1S4764	EMI Receiver	Narda	PMM 9010	03/14/2018	09/14/2019
1S2678	LISN, Dual-Line V-Network	Teseq	NNB 51	08/01/2018	08/01/2019
1S4070	Digital Barometer	Control Co	6530	06/22/2018	06/22/2020
1S2636	Micro-Ohmmeter	NDB Technologie	DRM-1A	02/05/2019	08/05/2020
1S2587	PREAMPLIFIER	AML COMMUNICATIONS	AML0126L3801	SEE NOTE	

Table 13. Test Equipment List

Note: Functionally tested equipment is verified using calibrated instrumentation at the time of testing.

V. Certification & User's Manual Information

Certification & User's Manual Information

A. Certification Information

The following is extracted from Title 47 of the Code of Federal Regulations, Part 2, Subpart I — Marketing of Radio frequency devices:

§ 2.801 Radio-frequency device defined.

As used in this part, a radio-frequency device is any device which in its operation is capable of Emitting radio-frequency energy by radiation, conduction, or other means. Radio- frequency devices include, but are not limited to:

- (a) The various types of radio communication transmitting devices described throughout this chapter.
- (b) *The incidental, unintentional and intentional radiators defined in Part 15 of this chapter.*
- (c) The industrial, scientific, and medical equipment described in Part 18 of this chapter.
- (d) Any part or component thereof which in use emits radio-frequency energy by radiation, conduction, or other means.

§ 2.803 Marketing of radio frequency devices prior to equipment authorization.

- (a) Except as provided elsewhere in this chapter, no person shall sell or lease, or offer for sale or lease (including advertising for sale or lease), or import, ship or distribute for the purpose of selling or leasing or offering for sale or lease, any radio frequency device unless:
 - (1) In the case of a device subject to certification, such device has been authorized by the Commission in accordance with the rules in this chapter and is properly identified and labeled as required by §2.925 and other relevant sections in this chapter; or
 - (2) In the case of a device that is not required to have a grant of equipment authorization issued by the Commission, but which must comply with the specified technical standards prior to use, such device also complies with all applicable administrative (including verification of the equipment or authorization under a Declaration of Conformity, where required), technical, labeling and identification requirements specified in this chapter.
- (d) Notwithstanding the provisions of paragraph (a) of this section, the offer for sale solely to business, commercial, industrial, scientific or medical users (but not an offer for sale to other parties or to end users located in a residential environment) of a radio frequency device that is in the conceptual, developmental, design or pre-production stage is permitted prior to equipment authorization or, for devices not subject to the equipment authorization requirements, prior to a determination of compliance with the applicable technical requirements *provided* that the prospective buyer is advised in writing at the time of the offer for sale that the equipment is subject to the FCC rules and that the equipment will comply with the appropriate rules before delivery to the buyer or to centers of distribution.

- (e)(1) Notwithstanding the provisions of paragraph (a) of this section, prior to equipment authorization or determination of compliance with the applicable technical requirements any radio frequency device may be operated, but not marketed, for the following purposes and under the following conditions:
- (i) *Compliance testing*;
 - (ii) Demonstrations at a trade show provided the notice contained in paragraph (c) of this section is displayed in a conspicuous location on, or immediately adjacent to, the device;
 - (iii) Demonstrations at an exhibition conducted at a business, commercial, industrial, scientific or medical location, but excluding locations in a residential environment, provided the notice contained in paragraphs (c) or (d) of this section, as appropriate, is displayed in a conspicuous location on, or immediately adjacent to, the device;
 - (iv) Evaluation of product performance and determination of customer acceptability, provided such operation takes place at the manufacturer's facilities during developmental, design or pre-production states; or
 - (v) Evaluation of product performance and determination of customer acceptability where customer acceptability of a radio frequency device cannot be determined at the manufacturer's facilities because of size or unique capability of the device, provided the device is operated at a business, commercial, industrial, scientific or medical user's site, but not at a residential site, during the development, design or pre-production stages.
- (e)(2) For the purpose of paragraphs (e)(1)(iv) and (e)(1)(v) of this section, the term *manufacturer's facilities* includes the facilities of the party responsible for compliance with the regulations and the manufacturer's premises, as well as the facilities of other entities working under the authorization of the responsible party in connection with the development and manufacture, but not the marketing, of the equipment.
- (f) For radio frequency devices subject to verification and sold solely to business, commercial, industrial, scientific and medical users (excluding products sold to other parties or for operation in a residential environment), parties responsible for verification of the devices shall have the option of ensuring compliance with the applicable technical specifications of this chapter at each end user's location after installation, provided that the purchase or lease agreement includes a proviso that such a determination of compliance be made and is the responsibility of the party responsible for verification of the equipment.

Certification & User's Manual Information

The following is extracted from Title 47 of the Code of Federal Regulations, Part 2, Subpart J — Equipment Authorization Procedures:

§ 2.901 Basis and Purpose

- (a) In order to carry out its responsibilities under the Communications Act and the various treaties and international regulations, and in order to promote efficient use of the radio spectrum, the Commission has developed technical standards for radio frequency equipment and parts or components thereof. The technical standards applicable to individual types of equipment are found in that part of the rules governing the service wherein the equipment is to be operated.¹ *In addition to the technical standards provided, the rules governing the service may require that such equipment be verified by the manufacturer or importer, be authorized under a Declaration of Conformity, or receive an equipment authorization from the Commission by one of the following procedures: certification or registration.*
- (b) The following sections describe the verification procedure, the procedure for a Declaration of Conformity, and the procedures to be followed in obtaining certification from the Commission and the conditions attendant to such a grant.

§ 2.907 Certification.

- (a) Certification is an equipment authorization issued by the Commission, based on representation and test data submitted by the applicant.
- (b) Certification attaches to all units subsequently marketed by the grantee which are identical (see Section 2.908) to the sample tested except for permissive changes or other variations authorized by the Commission pursuant to Section 2.1043.

¹ In this case, the equipment is subject to the rules of Part 15. More specifically, the equipment falls under Subpart B (of Part 15), which deals with unintentional radiators.

Certification & User's Manual Information

§ 2.948 Description of measurement facilities.

- (a) Each party making measurements of equipment that is subject to an equipment authorization under Part 15 or Part 18 of this chapter, regardless of whether the measurements are filed with the Commission or kept on file by the party responsible for compliance of equipment marketed within the U.S. or its possessions, shall compile a description of the measurement facilities employed.
- (1) If the measured equipment is subject to the verification procedure, the description of the measurement facilities shall be retained by the party responsible for verification of the equipment.
- (i) *If the equipment is verified through measurements performed by an independent laboratory, it is acceptable for the party responsible for verification of the equipment to rely upon the description of the measurement facilities retained by or placed on file with the Commission by that laboratory. In this situation, the party responsible for the verification of the equipment is not required to retain a duplicate copy of the description of the measurement facilities.*
- (ii) If the equipment is verified based on measurements performed at the installation site of the equipment, no specific site calibration data is required. It is acceptable to retain the description of the measurement facilities at the site at which the measurements were performed.
- (2) If the equipment is to be authorized by the Commission under the certification procedure, the description of the measurement facilities shall be filed with the Commission's Laboratory in Columbia, Maryland. The data describing the measurement facilities need only be filed once but must be updated as changes are made to the measurement facilities or as otherwise described in this section. At least every three years, the organization responsible for filing the data with the Commission shall certify that the data on file is current.

Certification & User's Manual Information

1. Label and User's Manual Information

The following is extracted from Title 47 of the Code of Federal Regulations, Part 15, Subpart A — General:

§ 15.19 Labeling requirements.

(a) *In addition to the requirements in Part 2 of this chapter, a device subject to certification or verification shall be labeled as follows:*

- (1) Receivers associated with the operation of a licensed radio service, e.g., FM broadcast under Part 73 of this chapter, land mobile operation under Part 90, etc., shall bear the following statement in a conspicuous location on the device:

This device complies with Part 15 of the FCC Rules. Operation is subject to the condition that this device does not cause harmful interference.

- (2) A stand-alone cable input selector switch, shall bear the following statement in a conspicuous location on the device:

This device is verified to comply with Part 15 of the FCC Rules for use with cable television service.

- (3) All other devices shall bear the following statement in a conspicuous location on the device:

This device complies with Part 15 of the FCC Rules. Operation is subject to the following two conditions: (1) This device may not cause harmful interference, and (2) this device must accept any interference received, including interference that may cause undesired operation.

- (4) Where a device is constructed in two or more sections connected by wires and marketed together, the statement specified under paragraph (a) of this section is required to be affixed only to the main control unit.

- (5) When the device is so small or for such use that it is not practicable to place the statement specified under paragraph (a) of this section on it, the information required by this paragraph shall be placed in a prominent location in the instruction manual or pamphlet supplied to the user or, alternatively, shall be placed on the container in which the device is marketed. However, the FCC identifier or the unique identifier, as appropriate, must be displayed on the device.

§ 15.21 Information to user.

The user's manual or instruction manual for an intentional or unintentional radiator shall caution the user that changes or modifications not expressly approved by the party responsible for compliance could void the user's authority to operate the equipment.

Verification & User's Manual Information

The following is extracted from Title 47 of the Code of Federal Regulations, Part 15, Subpart B — Unintentional Radiators:

§ 15.105 Information to the user.

- (a) For a Class A digital device or peripheral, the instructions furnished the user shall include the following or similar statement, placed in a prominent location in the text of the manual:

Note: This equipment has been tested and found to comply with the limits for a Class A digital device, pursuant to Part 15 of the FCC Rules. These limits are designed to provide reasonable protection against harmful interference when the equipment is operated in a commercial environment. This equipment generates, uses, and can radiate radio frequency energy and, if not installed and used in accordance with the instruction manual, may cause harmful interference to radio communications. Operation of this equipment in a residential area is likely to cause harmful interference in which case the user will be required to correct the interference at own expense.

- (b) For a Class B digital device or peripheral, the instructions furnished the user shall include the following or similar statement, placed in a prominent location in the text of the manual:

Note: This equipment has been tested and found to comply with the limits for a Class B digital device, pursuant to Part 15 of the FCC Rules. These limits are designed to provide reasonable protection against harmful interference when the equipment is operated in a residential environment. This equipment generates, uses, and can radiate radio frequency energy and, if not installed and used in accordance with the instruction manual, may cause harmful interference to radio communications. However, there is no guarantee that interference will not occur in a particular installation. If this equipment does cause harmful interference to radio or television reception, which can be determined by turning the equipment off and on, the user is encouraged to try to correct the interference by one or more of the following measures:

- Reorient or relocate the receiving antenna.
- Increase the separation between the equipment and receiver.
- Connect the equipment into an outlet on a circuit different from that to which the receiver is connected.
- Consult the dealer or an experienced radio/TV technician for help.

End of Report