



FCC PART 15.225 ISED C RSS-210, ISSUE 10, DECEMBER 2019



TEST REPORT

For

OpenPath Security, Inc.

13428 Maxella Ave, #866
Marina Del Rey, CA 90292, USA

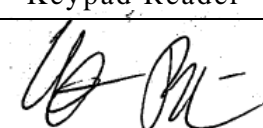
FCC ID: 2APJVOPRKP
IC: 25142-OPRKP

Report Type: Original Report	Product Type: Keypad Reader
Prepared By Arturo Reyes Test Engineer	
Report Number R2307255-01	
Report Date 2023-11-08	
Reviewed By Christian McCaig RF Lead Engineer	
Bay Area Compliance Laboratories Corp. 1274 Anvilwood Avenue, Sunnyvale, CA 94089, USA Tel: (408) 732-9162, Fax: (408) 732 9164	



Note: This test report is prepared for the customer shown above and for the device described herein. It may not be duplicated or used in part without prior written consent from Bay Area Compliance Laboratories Corp. This report **must not** be used by the customer to claim product certification, approval, or endorsement by A2LA*, NIST, or any agency of the Federal Government.

* This report may contain data that are not covered by the A2LA accreditation and are marked with an asterisk "*" (Rev.2)

TABLE OF CONTENTS

1	General Description.....	4
1.1	Product Description for Equipment Under Test (EUT)	4
1.2	Mechanical Description of EUT	4
1.3	Objective.....	4
1.4	Related Submittal(s)/Grant(s)	4
1.5	Test Methodology	4
1.6	Measurement Uncertainty	4
1.7	Test Facility Registrations	5
1.8	Test Facility Accreditations	5
2	System Test Configuration.....	8
2.1	Justification.....	8
2.2	EUT Exercise Software.....	8
2.3	Equipment Modifications.....	8
2.4	Local Support Equipment	8
2.5	Remote Support Equipment.....	8
2.6	Interface Ports and Cabling.....	8
3	Summary of Test Results	9
4	FCC §15.203, & ISEDC RSS-Gen §6.8 - Antenna Requirements	10
4.1	Applicable Standards	10
4.2	Antenna Description	10
5	FCC §2.1091 & ISEDC RSS-102 - RF Exposure	11
5.1	Applicable Standards	11
5.2	MPE Prediction.....	12
5.3	FCC MPE Results.....	12
5.4	IC Exemption.....	14
6	FCC §15.225(a)(b)(c)(d), §15.205(a), §15.209 & ISEDC RSS 210 Annex B.6(a)- Radiated Field Strength.....	15
6.1	Applicable Standards	15
6.2	Test Setup	18
6.3	Test Procedure	18
6.4	Corrected Amplitude & Margin Calculation.....	19
6.5	Test Setup Block Diagram	19
6.6	Test Equipment List and Details.....	21
6.7	Test Environmental Conditions	22
6.8	Summary of Test Results	22
6.9	Radiated Field Strength Test Data and Plots.....	22
7	FCC §15.225(e) & ISEDC RSS-210 Annex B.6(b) – Frequency Tolerance	29
7.1	Applicable Standards	29
7.2	Test Setup Block Diagram	29
7.3	Test Equipment List and Details.....	29
7.4	Test Environmental Conditions	30
7.5	Test Results.....	30
8	FCC §15.215(c) & ISEDC RSS-GEN §6.7 - Occupied Bandwidth.....	36
8.1	Applicable Standards	36
8.2	Test Setup	36
8.3	Test Setup Block Diagram.....	37
8.4	Test Equipment List and Details.....	37
8.5	Test Environmental Conditions	37
8.6	Test Results.....	38
9	Annex A (Normative) - Test Setup Photographs	39
10	Annex B (Normative) - EUT External Photographs.....	40
11	Annex C (Normative) - EUT Internal Photographs	41
12	Annex D (Normative) - A2LA Electrical Testing Certificate.....	42

DOCUMENT REVISION HISTORY

Revision Number	Report Number	Description of Revision	Date of Revision
0	R2307255-01	Original Report	2023-11-08

1 General Description

1.1 Product Description for Equipment Under Test (EUT)

This test and measurement report has been compiled on behalf of *OpenPath Security, Inc.*, and their product, *FCC ID: 2APJVOPRKP; IC: 25142-OPRKP*, model: OP-RKP-STND, which henceforth is referred to as the EUT (Equipment under Test.) The EUT is a Keypad Reader and contains a 2.4 GHz BLE radio (FCC ID: 2AA9B10, IC: 12208A-10), an HF RFID and a LF RFID radios.

1.2 Mechanical Description of EUT

OP-RKP-STND measures approximately 11 cm (Length) x 2.8 cm (Width_{Reader})/ 2.4 cm (Width_{Keypad}) x 11.8 cm (Height), and weighs approximately 0.2 kg.

The data gathered are from a typical production sample provided by the manufacturer with serial number: 31-2226-1101-63248, assigned by OpenPath Security, Inc.

For Frequency Tolerance measurements, the data gathered are from a typical production sample provided by the manufacturer with serial number: 31-2226-1120-36153, assigned by OpenPath Security, Inc. This sample employs the same radio but with different enclosure and thus not affecting such frequency related measurements.

1.3 Objective

This report was prepared on behalf of *OpenPath Security, Inc.*, in accordance with Part 2, Subpart J, and Part 15, Subparts B and C of the Federal Communication Commission's rules and ISEDC RSS-210 Annex B.6's rules. The objective was to determine compliance with FCC Part 15.225 and ISEDC RSS-210.

1.4 Related Submittal(s)/Grant(s)

N/A

1.5 Test Methodology

All measurements contained in this report were conducted in accordance with ANSI C63.10-2013, American National Standard of Procedures for Compliance Testing of Unlicensed Wireless Devices.

1.6 Measurement Uncertainty

All measurements involve certain levels of uncertainties, especially in the field of EMC. The factors contributing to uncertainties are spectrum analyzer, cable loss, antenna factor calibration, antenna directivity, antenna factor variation with height, antenna phase center variation, antenna factor frequency interpolation, measurement distance variation, site imperfections, mismatch (average), and system repeatability.

Based on CISPR16-4-2:2011, The Treatment of Uncertainty in EMC Measurements, the values ranging from ± 2.0 dB for Conducted Emissions tests and ± 4.0 dB for Radiated Emissions tests are the most accurate estimates pertaining to uncertainty of EMC measurements at BAACL Corp.

1.7 Test Facility Registrations

BACLs test facilities that are used to perform Radiated and Conducted Emissions tests are currently recognized by the Federal Communications Commission as Accredited with NIST Designation Number US1129.

BACL's test facilities that are used to perform Radiated and Conducted Emissions tests are currently registered with Industry Canada under Registration Numbers: 3062A-1, 3062A-2, and 3062A-3.

BACL is a Chinese Taipei Bureau of Standards Metrology and Inspection (BSMI) validated Conformity Assessment Body (CAB), under Appendix B, Phase I Procedures of the APEC Mutual Recognition Arrangement (MRA). BACL's BSMI Lab Code Number is: SL2-IN-E-1002R

BACL's test facilities that are used to perform AC Line Conducted Emissions, Telecommunications Line Conducted Emissions, Radiated Emissions from 30 MHz to 1 GHz, and Radiated Emissions from 1 GHz to 6 GHz are currently recognized as Accredited in accordance with the Voluntary Control Council for Interference [VCCI] Article 15 procedures under Registration Number A-0027.

1.8 Test Facility Accreditations

Bay Area Compliance Laboratories Corp. (BACL) is:

A- An independent, 3rd-Party, Commercial Test Laboratory accredited to ISO/IEC 17025:2017 by A2LA (Test Laboratory Accreditation Certificate Number 3297.02), in the fields of: Electromagnetic Compatibility and Telecommunications. Unless noted by an Asterisk (*) in the Compliance Matrix (See Section 3 of this Test Report), BACL's ISO/IEC 17025:2017 Scope of Accreditation includes all of the Test Method Standards and/or the Product Family Standards detailed in this Test Report.

BACL's ISO/IEC 17025:2017 Scope of Accreditation includes a comprehensive suite of EMC Emissions, EMC Immunity, Radio, RF Exposure, Safety and wireline Telecommunications test methods applicable to a wide range of product categories. These product categories include Central Office Telecommunications Equipment [including NEBS - Network Equipment Building Systems], Unlicensed and Licensed Wireless and RF devices, Information Technology Equipment (ITE); Telecommunications Terminal Equipment (TTE); Medical Electrical Equipment; Industrial, Scientific and Medical Test Equipment; Professional Audio and Video Equipment; Industrial and Scientific Instruments and Laboratory Apparatus; Cable Distribution Systems, and Energy Efficient Lighting.

B- A Product Certification Body accredited to ISO/IEC 17065:2012 by A2LA (Product Certification Body Accreditation Certificate Number 3297.03) to certify

- For the USA (Federal Communications Commission):

- 1- All Unlicensed radio frequency devices within FCC Scopes A1, A2, A3, and A4;
- 2- All Licensed radio frequency devices within FCC Scopes B1, B2, B3, and B4;
- 3- All Telephone Terminal Equipment within FCC Scope C.

- For the Canada (Industry Canada):

- 1- All Scope 1-Licence-Exempt Radio Frequency Devices;
- 2- All Scope 2-Licensed Personal Mobile Radio Services;
- 3- All Scope 3-Licensed General Mobile & Fixed Radio Services;
- 4- All Scope 4-Licensed Maritime & Aviation Radio Services;
- 5- All Scope 5-Licensed Fixed Microwave Radio Services
- 6- All Broadcasting Technical Standards (BETS) in the Category I Equipment Standards List.

- For Singapore (Info-Communications Development Authority (IDA)):

- 1- All Line Terminal Equipment: All Technical Specifications for Line Terminal Equipment – Table 1 of IDA MRA Recognition Scheme: 2011, Annex 2
- 2- All Radio-Communication Equipment: All Technical Specifications for Radio-Communication Equipment – Table 2 of IDA MRA Recognition Scheme: 2011, Annex 2

- For the Hong Kong Special Administrative Region:

- 1- All Radio Equipment, per KHCA 10XX-series Specifications;
 - 2- All GMDSS Marine Radio Equipment, per HKCA 12XX-series Specifications;
 - 3- All Fixed Network Equipment, per HKCA 20XX-series Specifications.
- For Japan:
- 1- MIC Telecommunication Business Law (Terminal Equipment):
 - All Scope A1 - Terminal Equipment for the Purpose of Calls;
 - All Scope A2 - Other Terminal Equipment
 - 2- Radio Law (Radio Equipment):
 - All Scope B1 - Specified Radio Equipment specified in Article 38-2-2, paragraph 1, item 1 of the Radio Law
 - All Scope B2 - Specified Radio Equipment specified in Article 38-2-2, paragraph 1, item 2 of the Radio Law
 - All Scope B3 - Specified Radio Equipment specified in Article 38-2-2, paragraph 1, item 3 of the Radio Law

C- A Product Certification Body accredited to ISO/IEC 17065:2012 by A2LA (Product Certification Body Accreditation Certificate Number 3297.01) to certify Products to USA's Environmental Protection Agency (EPA) ENERGY STAR Product Specifications for:

- 1 Electronics and Office Equipment:
 - for Telephony (ver. 3.0)
 - for Audio/Video (ver. 3.0)
 - for Battery Charging Systems (ver. 1.1)
 - for Set-top Boxes & Cable Boxes (ver. 4.1)
 - for Televisions (ver. 6.1)
 - for Computers (ver. 6.0)
 - for Displays (ver. 6.0)
 - for Imaging Equipment (ver. 2.0)
 - for Computer Servers (ver. 2.0)
- 2 Commercial Food Service Equipment
 - for Commercial Dishwashers (ver. 2.0)
 - for Commercial Ice Machines (ver. 2.0)
 - for Commercial Ovens (ver. 2.1)
 - for Commercial Refrigerators and Freezers
- 3 Lighting Products
 - For Decorative Light Strings (ver. 1.5)
 - For Luminaires (including sub-components) and Lamps (ver. 1.2)
 - For Compact Fluorescent Lamps (CFLs) (ver. 4.3)
 - For Integral LED Lamps (ver. 1.4)
- 4 Heating, Ventilation, and AC Products
 - for Residential Ceiling Fans (ver. 3.0)
 - for Residential Ventilating Fans (ver. 3.2)
- 5 Other
 - For Water Coolers (ver. 3.0)

D- A NIST Designated Phase-I and Phase-II Conformity Assessment Body (CAB) for the following economies and regulatory authorities under the terms of the stated MRAs/Treaties:

- Australia: ACMA (Australian Communication and Media Authority) – APEC Tel MRA -Phase I;
- Canada: (Innovation, Science and Economic development Canada - ISEDC) Foreign Certification Body – FCB – APEC Tel MRA -Phase I & Phase II;
- Chinese Taipei (Republic of China – Taiwan):
 - BSMI (Bureau of Standards, Metrology and Inspection) APEC Tel MRA -Phase I;
 - NCC (National Communications Commission) APEC Tel MRA -Phase I;

- European Union:
 - EMC Directive 2014/30/EU US-EU EMC & Telecom MRA CAB (NB)
 - Radio Equipment (RE) Directive 2014/53/EU US-EU EMC & Telecom MRA CAB (NB)
 - Low Voltage Directive (LVD) 2014/35/EU
- Hong Kong Special Administrative Region: (Office of the Telecommunications Authority – OFTA)
APEC Tel MRA -Phase I & Phase II
- Israel – US-Israel MRA Phase I
- Republic of Korea (Ministry of Communications - Radio Research Laboratory) APEC Tel MRA -Phase I
- Singapore: (Infocomm Media Development Authority - IMDA) APEC Tel MRA -Phase I & Phase II;
- Japan: VCCI - Voluntary Control Council for Interference US-Japan Telecom Treaty VCCI Side Letter-
- USA:
 - ENERGY STAR Recognized Test Laboratory – US EPA
 - Telecommunications Certification Body (TCB) – US FCC;
 - Nationally Recognized Test Laboratory (NRTL) – US OSHA
- Vietnam: APEC Tel MRA -Phase I;

2 System Test Configuration

2.1 Justification

The EUT was configured for testing according to ANSI C63.10-2013.

2.2 EUT Exercise Software

The test software used was *CoolTerm* in conjunction with firmware provided by *OpenPath Security, Inc.* and verified by *Christian McCaig* to comply with the standard requirements being tested against.

Radio	Frequency (MHz)	Power Setting
HF RFID	13.56	Default
LF RFID	0.125	Default
Bluetooth LE	2402	8

Data rates tested:

Bluetooth LE: 2 Mbps

2.3 Equipment Modifications

None

2.4 Local Support Equipment

Manufacturer	Description	Model No.	Serial No.
Volteq	DC Power Supply	HY5003D	160402343
Dell	Laptop	Latitude E74440	C71SYZ1

2.5 Remote Support Equipment

Manufacturer	Description	Model No.	Serial No.
OpenPath Security, Inc.	4 pin header to USB-A and Power adapter	N/A	N/A

2.6 Interface Ports and Cabling

Cable Descriptions	Length	From	To
4 pin header to USB-A and Power adapter	< 1 m	EUT	Laptop
4 pin header to USB-A and Power adapter	< 1 m	EUT	Power Supply

3 Summary of Test Results

Results reported relate only to the product tested.

FCC & ISED Rules	Description of Test	Results
FCC §15.203 ISED RSS-Gen §6.8	Antenna Requirements	Compliant
FCC §2.1091, §1.1310 & ISED RSS-102	RF Exposure	Compliant
FCC §15.225 (a) (b) (c) (d), §15.205, §15.209 & ISED RSS-210 Annex B.6(a)	Radiated Field Strength (9kHz – 30MHz, 30MHz-1GHz, 1GHz- 26.5GHz)	Compliant
FCC §15.225 (e) & ISED RSS-210 Annex B.6(b)	Frequency Tolerance	Compliant
FCC §15.215 (c) ISED RSS-Gen §6.7	Occupied Bandwidth	Compliant

BACL is responsible for all the information provided in this report, except when information is provided by the customer as identified in this report. Information provided by the customer, e.g., antenna gain, can affect the validity of results.

4 FCC §15.203, & ISEDC RSS-Gen §6.8 - Antenna Requirements

4.1 Applicable Standards

According to FCC §15.203:

An intentional radiator shall be designed to ensure that no antenna other than that furnished by the responsible party shall be used with the device. The use of a permanently attached antenna or of an antenna that uses a unique coupling to the intentional radiator shall be considered sufficient to comply with the provisions of this Section. The manufacturer may design the unit so that a broken antenna can be replaced by the user, but the use of a standard antenna jack or electrical connector is prohibited.

According to ISEDC RSS-Gen §6.8: Transmitter Antenna

The applicant for equipment certification shall provide a list of all antenna types that may be used with the transmitter, where applicable (i.e. for transmitters with detachable antenna), indicating the maximum permissible antenna gain (in dBi) and the required impedance for each antenna. The test report shall demonstrate the compliance of the transmitter with the limit for maximum equivalent isotropically radiated power (e.i.r.p.) specified in the applicable RSS, when the transmitter is equipped with any antenna type, selected from this list.

For expediting the testing, measurements may be performed using only the antenna with highest gain of each combination of transmitter and antenna type, with the transmitter output power set at the maximum level. However, the transmitter shall comply with the applicable requirements under all operational conditions and when in combination with any type of antenna from the list provided in the test report (and in the notice to be included in the user manual, provided below).

When measurements at the antenna port are used to determine the RF output power, the effective gain of the device's antenna shall be stated, based on a measurement or on data from the antenna's manufacturer.

The test report shall state the RF power, output power setting and spurious emission measurements with each antenna type that is used with the transmitter being tested.

For license-exempt equipment with detachable antennas, the user manual shall also contain the following notice in a conspicuous location:

This radio transmitter has been approved by Innovation, Science and Economic Development Canada to operate with the antenna types listed below, with the maximum permissible gain indicated. Antenna types not included in this list that have a gain greater than the maximum gain indicated for any type listed are strictly prohibited for use with this device.

Immediately following the above notice, the manufacturer shall provide a list of all antenna types which can be used with the transmitter, indicating the maximum permissible antenna gain (in dBi) and the required impedance for each antenna type.

4.2 Antenna Description

External/Internal/ Integral	Frequency Range (MHz)	Antenna Type	Maximum Antenna Gain (dBi)
Integral	13.56	PCB Loop Trace	N/A
Integral	0.125	PCB Loop Trace	N/A

5 FCC §2.1091 & ISEDC RSS-102 - RF Exposure

5.1 Applicable Standards

According to FCC §2.1091 and §1.1310(e)(1), systems operating under the provisions of this section shall be operated in a manner that ensures that the public is not exposed to radio frequency energy level in excess of the Commission's guidelines.

Limits for General Population/Uncontrolled Exposure

Frequency Range (MHz)	Electric Field Strength (V/m)	Magnetic Field Strength (A/m)	Power Density (mW/cm ²)	Averaging Time (minutes)
Limits for General Population/Uncontrolled Exposure				
0.3-1.34	614	1.63	* (100)	30
1.34-30	824/f	2.19/f	* (180/f ²)	30
30-300	27.5	0.073	0.2	30
300-1500	/	/	f/1500	30
1500-100,000	/	/	1.0	30

f = frequency in MHz

* = Plane-wave equivalent power density

According to ISED RSS-102 Issue 5:

2.5.2 Exemption Limits for Routine Evaluation – RF Exposure Evaluation

RF exposure evaluation is required if the separation distance between the user and/or bystander and the device's radiating element is greater than 20 cm, except when the device operates as follows:

- below 20 MHz⁶ and the source-based, time-averaged maximum e.i.r.p. of the device is equal to or less than 1 W (adjusted for tune-up tolerance);
- at or above 20 MHz and below 48 MHz and the source-based, time-averaged maximum e.i.r.p. of the device is equal to or less than $4.49/f^{0.5}$ W (adjusted for tune-up tolerance), where f is in MHz;
- at or above 48 MHz and below 300 MHz and the source-based, time-averaged maximum e.i.r.p. of the device is equal to or less than 0.6 W (adjusted for tune-up tolerance);
- at or above 300 MHz and below 6 GHz and the source-based, time-averaged maximum e.i.r.p. of the device is equal to or less than $1.31 \times 10^{-2} f^{0.6834}$ W (adjusted for tune-up tolerance), where f is in MHz;
- at or above 6 GHz and the source-based, time-averaged maximum e.i.r.p. of the device is equal to or less than 5 W (adjusted for tune-up tolerance).

In these cases, the information contained in the RF exposure technical brief may be limited to information that demonstrates how the e.i.r.p. was derived.

5.2 MPE Prediction

Predication of MPE limit at a given distance, Equation from OET Bulletin 65, Edition 97-01

$$S = PG/4\pi R^2$$

Where: S = power density

P = power input to antenna

G = power gain of the antenna in the direction of interest relative to an isotropic radiator

R = distance to the center of radiation of the antenna

5.3 FCC MPE Results

HF RFID Standalone

Maximum ERP (dBm): -21.8

Maximum ERP (mW): 0.0066

Prediction distance (cm): 20

Prediction frequency (MHz): 13.56

Power density of prediction frequency at 20 cm (mW/cm²): 0.0000013

FCC MPE limit for uncontrolled exposure at prediction frequency 0.979
(mW/cm²):

The device is compliant with the requirement MPE limit for uncontrolled exposure. The maximum power density at the distance of 20 cm is 0.0000013 mW/cm². Limit is 0.979 mW/cm².

BLE Standalone

Maximum EIRP (dBm): 4.579

Maximum EIRP (mW): 2.87

Prediction distance (cm): 20

Prediction frequency (MHz): 2402

Power density of prediction frequency at 20 cm (mW/cm²): 0.00057

FCC MPE limit for uncontrolled exposure at prediction frequency 1
(mW/cm²):

The device is compliant with the requirement MPE limit for uncontrolled exposure. The maximum power density at the distance of 20 cm is 0.00057 mW/cm². Limit is 1 mW/cm².

LF RFID

Maximum ERP (dBm): -2.05
Maximum ERP (mW): 0.62
Prediction distance (cm): 20
Prediction frequency (MHz): 0.125
Power density of prediction frequency at 20 cm (mW/cm²): 0.00012
FCC MPE limit for uncontrolled exposure at prediction frequency 100
(mW/cm²):

The device is compliant with the requirement MPE limit for uncontrolled exposure. The maximum power density at the distance of 20 cm is 0.00012 mW/cm². Limit is 100 mW/cm².

Worst Case Co-location MPE Calculation:

Radio	Max EIRP (dBm)	Evaluated Distance (cm)	Worst-Case Exposure Level	Limit	Worst-Case Ratios	Sum of Ratios	Limit
Worst Case							
HF RFID ¹	-21.8	20	0.000013 mW/cm ²	0.979 mW/cm ²	0.00013%	0.057%	100%
BLE ²	4.579	20	0.00057 mW/cm ²	1.0 mW/cm ²	0.057%		
LF RFID ¹	-2.05	20	0.00012 mW/cm ²	100 mW/cm ²	0.00012%		

¹ NFC is e.r.p

² BLE Max EIRP is based on test report "BMD-340 FCC OQPSK" by AGC issued on 2018-05-30.

5.4 IC Exemption**HF RFID**

Maximum e.r.p = -21.8 dBm (0.0066 mW) which is less than the exemption threshold, i.e., 1W

Therefore, the SAR evaluation is exempt

BLE

Maximum e.i.r.p = 4.579 dBm (2.87 mW) which is less than the exemption threshold, i.e., $1.31 \times 10^{-2} \times f^{0.6834} \text{ W} = 2.68 \text{ W}$.

Therefore, the SAR evaluation is exempt

LF RFID

Maximum LF RFID e.r.p = -2.14 dBm (0.61 mW) which is less than the exemption threshold, i.e., 1W.

Therefore, the SAR evaluation is exempt

Note: Per ANSI C63.10 Sections 10.3.9 and G.4, Max ERP for HF RFID was determined by the following calculation: $75.65 \text{ dBuV/m @ } 3\text{m} - 95.3 - 2.15 \text{ dB} = -21.8 \text{ dBm [e.r.p]}$

Note: Per ANSI C63.10 Sections 10.3.9 and G.4, Max ERP was determined by the following calculation: $95.31 \text{ dBuV/m @ } 3\text{m} - 95.39 - 2.15 \text{ dB} = -2.05 \text{ dBm [e.r.p]}$

6 FCC §15.225(a)(b)(c)(d), §15.205(a), §15.209 & ISEDC RSS 210 Annex B.6(a)- Radiated Field Strength

6.1 Applicable Standards

As per FCC §15.225 Operation within the band 13.110-14.010 MHz

(a) The field strength of any emissions within the band 13.553-13.567 MHz shall not exceed 15,848 microvolts/meter at 30 meters.

(b) Within the bands 13.410-13.553 MHz and 13.567-13.710 MHz, the field strength of any emissions shall not exceed 334 microvolts/meter at 30 meters.

(c) Within the bands 13.110-13.410 MHz and 13.710-14.010 MHz the field strength of any emissions shall not exceed 106 microvolts/meter at 30 meters.

(d) The field strength of any emissions appearing outside of the 13.110-14.010 MHz band shall not exceed the general radiated emission limits in §15.209.

As per FCC §15.209:

(a) Except as provided elsewhere in this Subpart, the emissions from an intentional radiator shall not exceed the field strength levels specified in the following table

Frequency (MHz)	Field Strength (micro volts/meter)	Measurement Distance (meters)
0.009 - 0.490	2400/F(kHz)	300
0.490 - 1.705	24000/F(kHz)	30
1.705 - 30.0	30	30
30 - 88	100**	3
88 - 216	150**	3
216 - 960	200**	3
Above 960	500	3

** Except as provided in paragraph (g), fundamental emissions from intentional radiators operating under this Section shall not be located in the frequency bands 54-72 MHz, 76-88 MHz, 174-216 MHz or 470-806 MHz. However, operation within these frequency bands is permitted under other sections of this Part, e.g., Sections 15.231 and 15.241.

(b) In the emission table above, the tighter limit applies at the band edges.

(c) The level of any unwanted emissions from an intentional radiator operating under these general provisions shall not exceed the level of the fundamental emission. For intentional radiators which operate under the provisions of other sections within this part and which are required to reduce their unwanted emissions to the limits specified in this table, the limits in this table are based on the frequency of the unwanted emission and not the fundamental frequency. However, the level of any unwanted emissions shall not exceed the level of the fundamental frequency.

(d) The emission limits shown in the above table are based on measurements employing a CISPR quasi-peak detector except for the frequency bands 9-90 kHz, 110-490 kHz and above 1000 MHz. Radiated emission limits in these three bands are based on measurements employing an average detector.

(e) The provisions in §§ 15.31, 15.33, and 15.35 for measuring emissions at distances other than the distances specified in the above table, determining the frequency range over which radiated emissions are to be measured, and limiting peak emissions apply to all devices operated under this part.

(f) In accordance with § 15.33(a), in some cases the emissions from an intentional radiator must be measured to beyond the tenth harmonic of the highest fundamental frequency designed to be emitted by the intentional radiator because of the incorporation of a digital device. If measurements above the tenth harmonic are so required, the radiated emissions above the tenth harmonic shall comply with the general radiated emission limits applicable to the incorporated digital device, as shown in § 15.109 and as based on the frequency of the emission being measured, or, except for emissions contained in the restricted frequency bands shown in § 15.205, the limit on spurious emissions specified for the intentional radiator, whichever is the higher limit. Emissions which must be measured above the tenth harmonic of the highest fundamental frequency designed to be emitted by the intentional radiator and which fall within the restricted bands shall comply with the general radiated emission limits in § 15.109 that are applicable to the incorporated digital device.

As per §15.205(a): Except as shown in paragraph (d) of this section, only spurious emissions are permitted in any of the frequency bands listed below:

MHz	MHz	MHz	GHz
0.090–0.110	16.42–16.423	399.9–410	4.5–5.15
¹ 0.495–0.505	16.69475–16.69525	608–614	5.35–5.46
2.1735–2.1905	16.80425–16.80475	960–1240	7.25–7.75
4.125–4.128	25.5–25.67	1300–1427	8.025–8.5
4.17725–4.17775	37.5–38.25	1435–1626.5	9.0–9.2
4.20725–4.20775	73–74.6	1645.5–1646.5	9.3–9.5
6.215–6.218	74.8–75.2	1660–1710	10.6–12.7
6.26775–6.26825	108–121.94	1718.8–1722.2	13.25–13.4
6.31175–6.31225	123–138	2200–2300	14.47–14.5
8.291–8.294	149.9–150.05	2310–2390	15.35–16.2
8.362–8.366	156.52475–156.52525	2483.5–2500	17.7–21.4
8.37625–8.38675	156.7–156.9	2690–2900	22.01–23.12
8.41425–8.41475	162.0125–167.17	3260–3267	23.6–24.0
12.29–12.293	167.72–173.2	3332–3339	31.2–31.8
12.51975–12.52025	240–285	3345.8–3358	36.43–36.5
12.57675–12.57725	322–335.4	3600–4400	(²)
13.36–13.41			

¹ Until February 1, 1999, this restricted band shall be 0.490–0.510 MHz.

² Above 38.6

As per ISED RSS-GEN §8.9:

Except where otherwise indicated in the applicable RSS, radiated emissions shall comply with the field strength limits shown in table 5 and table 6. Additionally, the level of any transmitter unwanted emission shall not exceed the level of the transmitter's fundamental emission.

Table 5 – General field strength limits at frequencies above 30 MHz	
Frequency (MHz)	Field strength ($\mu\text{V}/\text{m}$ at 3 m)
30 – 88	100
88 – 216	150
216 – 960	200
Above 960	500

Table 6 – General field strength limits at frequencies below 30 MHz		
Frequency	Magnetic field strength (H-Field) ($\mu\text{A}/\text{m}$)	Measurement distance (m)
9 - 490 kHz ^{Note 1}	$6.37/F$ (F in kHz)	300
490 - 1705 kHz	$63.7/F$ (F in kHz)	30
1.705 - 30 MHz	0.08	30

Note 1: The emission limits for the ranges 9-90 kHz and 110-490 kHz are based on measurements employing a linear average detector.

As per ISED RSS-GEN §8.10:

Restricted frequency bands, identified in table 7, are designated primarily for safety-of-life services (distress calling and certain aeronautical activities), certain satellite downlinks, radio astronomy and some government uses. Except where otherwise indicated, the following conditions related to the restricted frequency bands apply:

The transmit frequency, including fundamental components of modulation, of licence-exempt radio apparatus shall not fall within the restricted frequency bands listed in table 7 except for apparatus compliant with RSS-287, Emergency Position Indicating Radio Beacons (EPIRB), Emergency Locator Transmitters (ELT), Personal Locator Beacons (PLB), and Maritime Survivor Locator Devices (MSLD).

Unwanted emissions that fall into restricted frequency bands listed in table 7 shall comply with the limits specified in table 5 and table 6.

Unwanted emissions that do not fall within the restricted frequency bands listed in table 7 shall comply either with the limits specified in the applicable RSS or with those specified in table 5 and table 6.

As per ISED RSS-210 Annex B.6: Band 13.110-14.010 MHz

Devices shall comply with the following requirements:

- a. the field strength of any emission shall not exceed the following limits:
 - i. 15.848 mV/m (84 dB $\mu\text{V}/\text{m}$) at 30 m, within the band 13.553-13.567 MHz
 - ii. 334 $\mu\text{V}/\text{m}$ (50.5 dB $\mu\text{V}/\text{m}$) at 30 m, within the bands 13.410-13.553 MHz and 13.567-13.710 MHz
 - iii. 106 $\mu\text{V}/\text{m}$ (40.5 dB $\mu\text{V}/\text{m}$) at 30 m, within the bands 13.110-13.410 MHz and 13.710-14.010 MHz
 - iv. RSS-Gen general field strength limits for frequencies outside the band 13.110-14.010 MHz

6.2 Test Setup

The radiated emissions tests were performed in the 5-meter Chamber, using the setup in accordance with ANSI C63.10-2013. The specification utilized was the FCC §15.225, §15.209 and ISEDC RSS-210 limits.

The spacing between the peripherals was 10 centimeters.

External I/O cables were draped along the edge of the test table and bundle when necessary.

6.3 Test Procedure

For the radiated emissions test, the EUT host, and all support equipment power cords was connected to the DC floor outlet.

Maximizing procedure was performed on the highest emissions to ensure that the EUT complied with all installation combinations.

The EUT is set 3 meter away from the testing antenna for frequency below 30MHz and set 3 meters away from the testing antenna for frequency from 30 MHz to 1 GHz, which was fixed at around 1 meters, and the EUT is placed on a turntable, which is 0.8 meter above ground plane, the table shall be rotated for 360 degrees to find out the highest emission. The receiving antenna should be changed the polarization both of perpendicular and parallel.

The spectrum analyzer or receiver is set as:

Below 150 kHz:

RBW = 200 Hz / VBW = 600 Hz / Sweep = Auto / Average

From 150 kHz to 30 MHz:

RBW = 9 kHz / VBW = 27 kHz / Sweep = Auto / Average

From 30MHz to 1GHz:

RBW = 120 kHz / VBW = 300 kHz / Sweep = Auto / Average

From 1GHz to 26.5GHz:

RBW = 1MHz / VBW = 3 MHz / Sweep = Auto / Average

6.4 Corrected Amplitude & Margin Calculation

The Corrected Amplitude (CA) is calculated by adding the Antenna Factor (AF), the Cable Loss (CL), the Attenuator Factor (Atten) and subtracting the Amplifier Gain (Ga) to indicated Amplitude (Ai) reading. The basic equation is as follows:

$$CA = Ai + AF + CL + Atten - Ga$$

For example, a corrected amplitude of 40.3 dBuV/m = Indicated Reading (32.5 dBuV) + Antenna Factor (+23.5dB/m) + Cable Loss (3.7 dB) + Attenuator (10 dB) - Amplifier Gain (29.4 dB)

The “Margin” column of the following data tables indicates the degree of compliance within the applicable limit. For example, a margin of -7 dB means the emission is 7 dB below the maximum limit. The equation for margin calculation is as follows:

$$\text{Margin} = \text{Corrected Amplitude} - \text{Limit}$$

6.5 Test Setup Block Diagram

Below 9 kHz to 30 MHz:

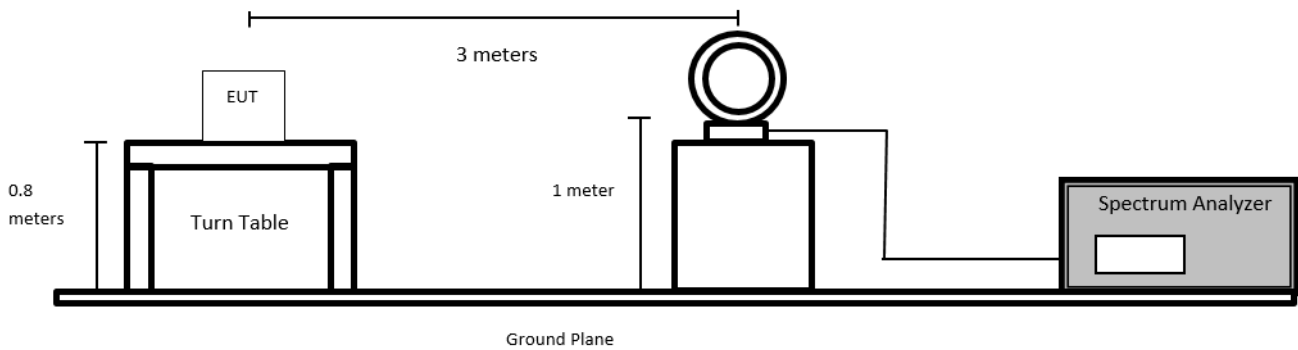

Below 30MHz to 1GHz:

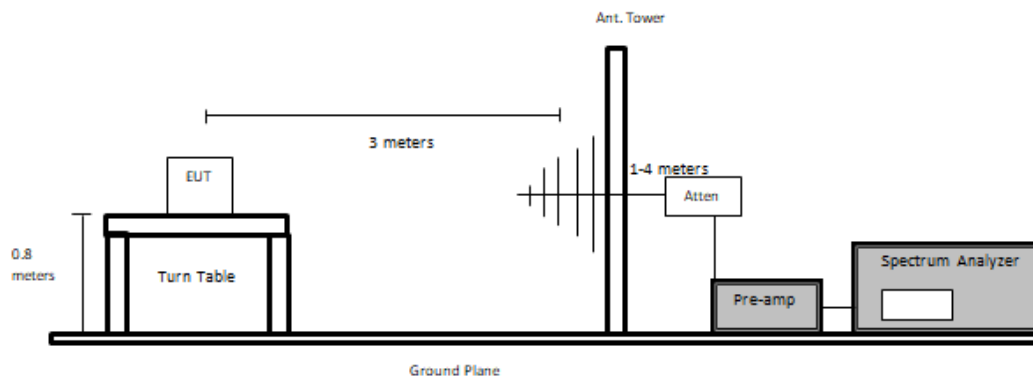

Above 1GHz:

Using Asset #1192

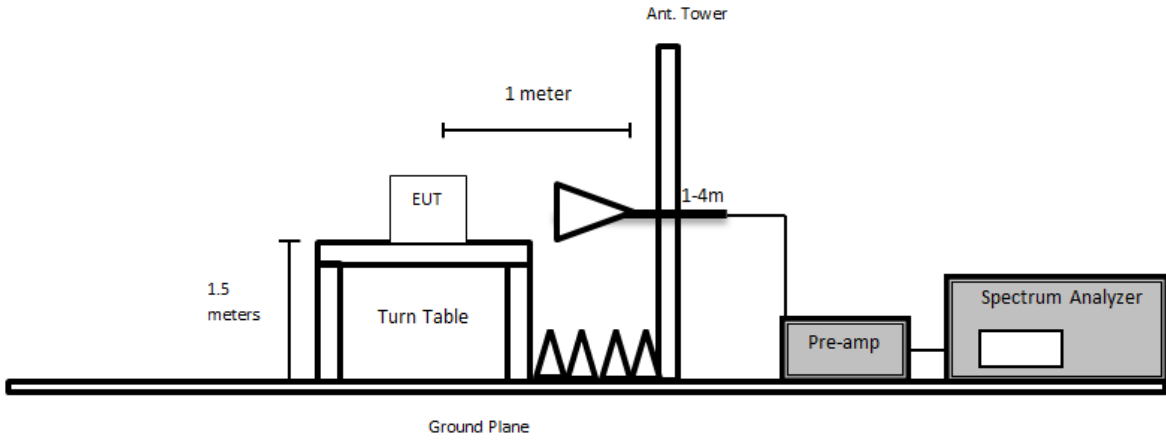

Using Asset #91

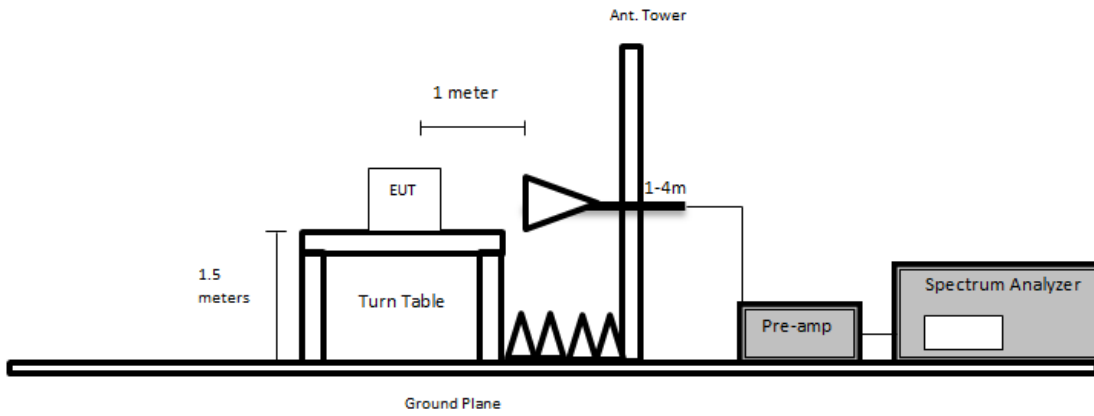

6.6 Test Equipment List and Details

Bacl No.	Manufacturer	Description	Model No.	Serial No.	Calibration Date	Calibration Interval
124	Rohde & Schwarz	EMI Test Receiver	ESCI	100044	2023-06-16	1 year
624	Agilent	Spectrum Analyzer	E4446A	MY48250238	2023-05-12	1 year
316	Sonoma Instruments	Preamplifier 10 kHz - 2.5 GHz	317	260406	2023-04-12	6 months
658	HP/ Agilent	Pre Amplifier	8449B OPT HO2	3008A01103	2023-06-13	1 year
827	AH Systems	Preamplifier	PAM 1840 VH	170	2023-05-17	1 year
91	Wisewave	Horn Antenna	ARH-4223-02	10555-02	2022-03-08	2 years
321	Sunol Sciences	Biconi-Log Antenna	JB3	A020106-2	2021-11-22	2 years
393	Com-Power	Active Loop Antenna	AL-130	17043	2023-05-26	2 years
1192	ETS Lindgren	Horn Antenna	3117	00218973	2022-09-29	2 years
672	Micro-Tronics	2.4-2.6 GHz Notch Filter	BRM50701	160	2023-03-09	1 year
1186	Pasternack	RG214 Coax Cable	PE3062-1050CM	N/A	2023-04-14	6 months
1245	-	6dB Attenuator	PE7390-6	01182018A	2021-11-22	2 years
1246	HP	RF Limiter	11867A	01734	2023-04-13	1 year
1247	Uti flex	Micro - Coax	N/A	N/A	2023-06-13	1 year
1248	Pasternack	RG214 Coax Cable	PE3062	N/A	2023-04-14	6 months
1249	Time Microwave	LMR-400 Cable Dc-3 GHz	AE13684	2k80612-56fts	2023-04-14	6 months
1295	Carlisle	10m Ultra Low Loss Coaxial Cable	UFB142A-1-3937-200200	64639890912-001	2023-05-04	6 months
327	Sunol Science Corp	System Controller	SC110V	122303-1	N/R	N/A
1075	Sunol Sciences	Boresight Tower	TLT3	050119-7	N/R	N/A
1388	Sunol Sciences	Flush Mount Turntable	FM	112005-2	N/R	N/A

Statement of Traceability: BACL Corp. attests that all of the calibrations on the equipment items listed above were traceable to NIST or to another internationally recognized National Metrology Institute (NMI), and were compliant with the latest version of A2LA policy P102 "A2LA Policy on Metrological Traceability".

6.7 Test Environmental Conditions

Temperature:	23 °C
Relative Humidity:	36-39 %
ATM Pressure:	101.6 kPa

The testing was performed by Deepak Mishra from 2023-08-10 to 2023-08-11 in 5 meter chamber 3.
The testing was performed by Arturo Reyes from 2023-09-21 to 2023-09-22 in 5 meter chamber 3.

6.8 Summary of Test Results

According to the data hereinafter, the EUT complied with the FCC Part 15C and ISEDC RSS-210 standard's radiated emissions limits, and had the worst margin of:

Mode: Transmitting			
Margin (dB)	Frequency (MHz)	Polarization	Range
-2.2	82.49875	Vertical	30 - 1000 MHz

Please refer to the following table and plots for specific test result details

6.9 Radiated Field Strength Test Data and Plots

9 kHz to 30 MHz Measured at 3 meters

Frequency (kHz)	S.A. Reading (dB μ V)	Turntable Azimuth (degrees)	Test Antenna		Cable Loss (dB)	Cord. Reading (dB μ V/m)	FCC/ISEDC		Comments
			Height (cm)	Factor (dB/m)			Limit (dB μ V/m)	Margin (dB)	
Loop Parallel									
125	85.35	5	100	10.03	0.0136	95.39	105.67	-10.28	QP

Frequency (kHz)	S.A. Reading (dB μ V)	Turntable Azimuth (degrees)	Test Antenna		Cable Loss (dB)	Cord. Reading (dB μ V/m)	FCC/ISEDC		Comments
			Height (cm)	Factor (dB/m)			Limit (dB μ V/m)	Margin (dB)	
Loop Perpendicular									
125	84.68	290	100	10.03	0.0136	94.72	105.67	-10.95	QP

Note: Limit conversion from 300m to 3m: dBuV/m for 0.009~30MHz = 105.67 = 20log (19.2) + 40log (300/3) dBuV/m.

9 kHz to 30 MHz Measured at 3 meters

Frequency (MHz)	S.A. Reading (dB μ V)	Turntable Azimuth (degrees)	Test Antenna		Cable Loss (dB)	Cord. Reading (dB μ V/m)	FCC/ISED		Comments
			Height (cm)	Factor (dB/m)			Limit (dB μ V/m)	Margin (dB)	
Loop Parallel									
13.56	65.07	5	100	10.36	0.2186	75.65	124	-48.35	PK
13.56	64.75	5	100	10.36	0.2186	75.33	124	-48.67	QP
13.56	65	5	100	10.36	0.2186	75.58	124	-48.42	AV
13.553	51.5	5	100	10.36	0.2186	62.08	90.47	-28.39	PK
13.553	49.97	5	100	10.36	0.2186	60.55	90.47	-29.92	QP
13.553	50.22	5	100	10.36	0.2186	60.80	90.47	-29.67	AV
13.567	51.62	5	100	10.36	0.2186	62.20	90.47	-28.27	PK
13.567	50.12	5	100	10.36	0.2186	60.70	90.47	-29.77	QP
13.567	50.37	5	100	10.36	0.2186	60.95	90.47	-29.52	AV
13.3488	48.9	4	100	10.36	0.2152	59.48	80.51	-21.03	PK
13.3488	31.94	4	100	10.36	0.2152	42.52	80.51	-37.99	QP
13.3488	13.68	4	100	10.36	0.2152	24.26	80.51	-56.25	AV
13.71	33.8	4	100	10.36	0.224	44.39	80.51	-36.12	PK
13.71	19.04	4	100	10.36	0.224	29.63	80.51	-50.88	QP
13.71	11.92	4	100	10.36	0.224	22.51	80.51	-58.00	AV

Frequency (MHz)	S.A. Reading (dB μ V)	Turntable Azimuth (degrees)	Test Antenna		Cable Loss (dB)	Cord. Reading (dB μ V/m)	FCC/ISED		Comments
			Height (cm)	Factor (dB/m)			Limit (dB μ V/m)	Margin (dB)	
Loop Perpendicular									
13.56	60.8	290	100	10.36	0.2186	71.38	124	-52.62	PK
13.56	60.45	290	100	10.36	0.2186	71.03	124	-52.97	QP
13.56	60.71	290	100	10.36	0.2186	71.29	124	-52.71	AV
13.553	47.23	290	100	10.36	0.2186	57.81	90.47	-32.66	PK
13.553	45.69	290	100	10.36	0.2186	56.27	90.47	-34.20	QP
13.553	45.94	290	100	10.36	0.2186	56.52	90.47	-33.95	AV
13.567	47.4	290	100	10.36	0.2186	57.98	90.47	-32.49	PK
13.567	45.83	290	100	10.36	0.2186	56.41	90.47	-34.06	QP
13.567	46.08	290	100	10.36	0.2186	56.66	90.47	-33.81	AV
13.3434	39.22	282	100	10.36	0.2152	49.80	80.51	-30.71	PK
13.3434	22.96	282	100	10.36	0.2152	33.54	80.51	-46.97	QP
13.3434	11.12	282	100	10.36	0.2152	21.70	80.51	-58.81	AV
13.7736	40.81	282	100	10.36	0.224	51.40	80.51	-29.11	PK
13.7736	23.72	282	100	10.36	0.224	34.31	80.51	-46.20	QP
13.7736	8.8	282	100	10.36	0.224	19.39	80.51	-61.12	AV

Note: the distance extrapolation factor (40 dB/decade) is used for below 30 MHz.

Below 30 MHz Radiated Field Strength (perpendicular):

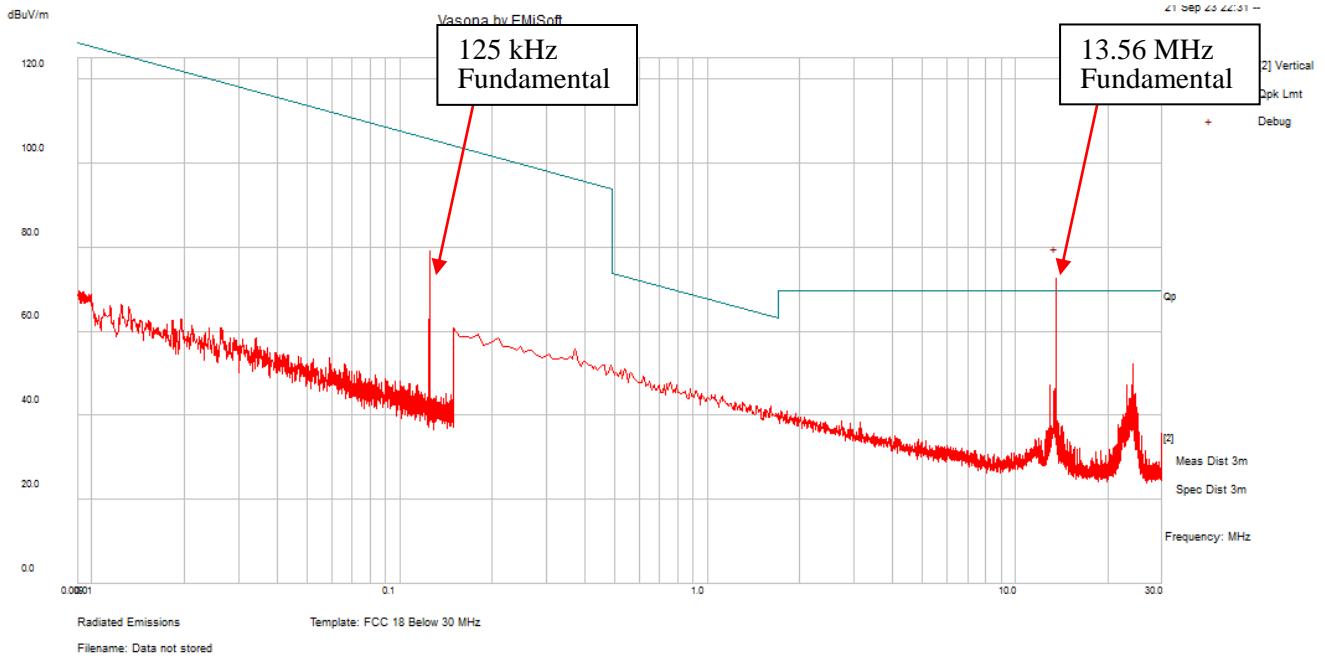

Below 30 MHz Radiated Field Strength (parallel):

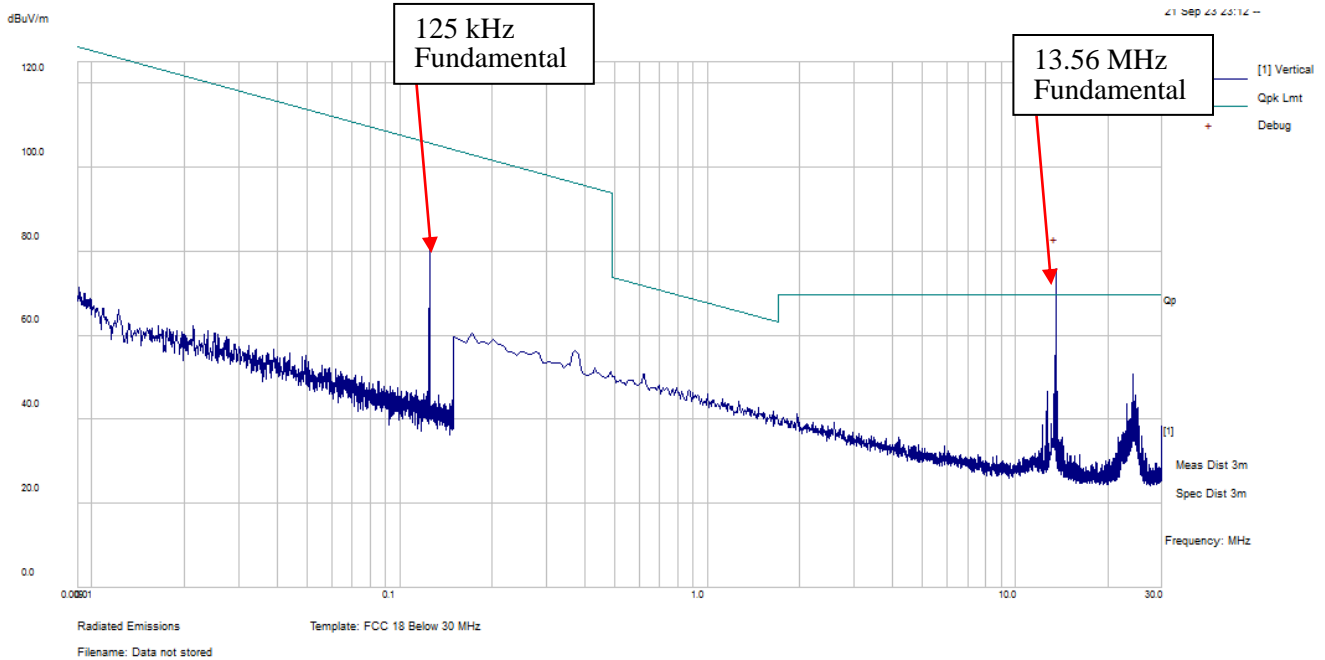

30 MHz – 1000 MHz Radiated Field Strength measured at 3 meters:

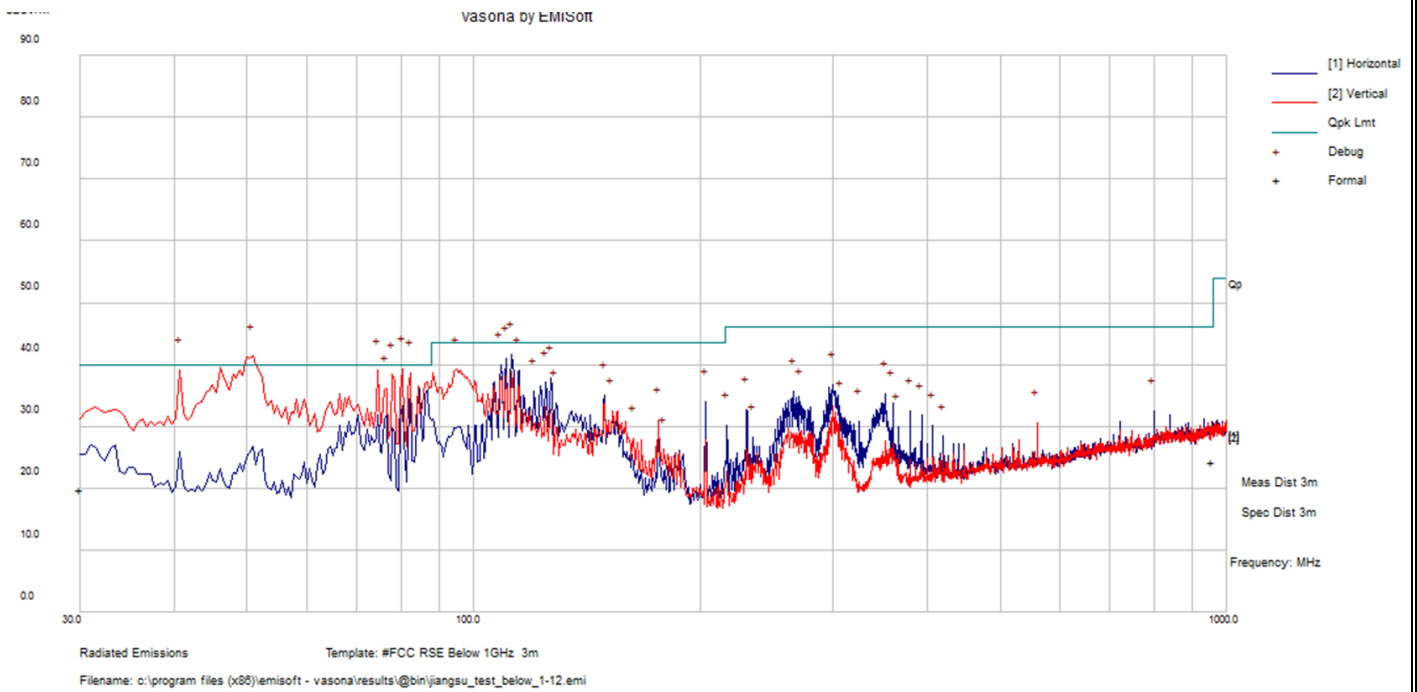

Frequency (MHz)	S.A. Reading (dBuV)	Correction Factor (dB/m)	Corrected Amplitude (dBuV/m)	Antenna Height (cm)	Antenna Polarity (H/V)	Turntable Azimuth (degrees)	Limit (dBuV/m)	Margin (dB)	Comment
51.022	58.17	-22.63	35.54	35.54	V	273	40	-4.46	Pass
80.4565	60.05	-22.77	37.28	37.28	V	188	40	-2.72	Pass
40.67275	51.15	-16.97	34.18	34.18	V	277	40	-5.82	Pass
74.533	53.34	-22.08	31.26	31.26	V	301	40	-8.74	Pass
82.49875	60.68	-22.88	37.8	37.8	V	252	40	-2.2	Pass
78.25675	52.95	-22.78	30.17	30.17	V	254	40	-9.83	Pass

1 GHz – 18 GHz Radiated Field Strength measured at 1 meter:

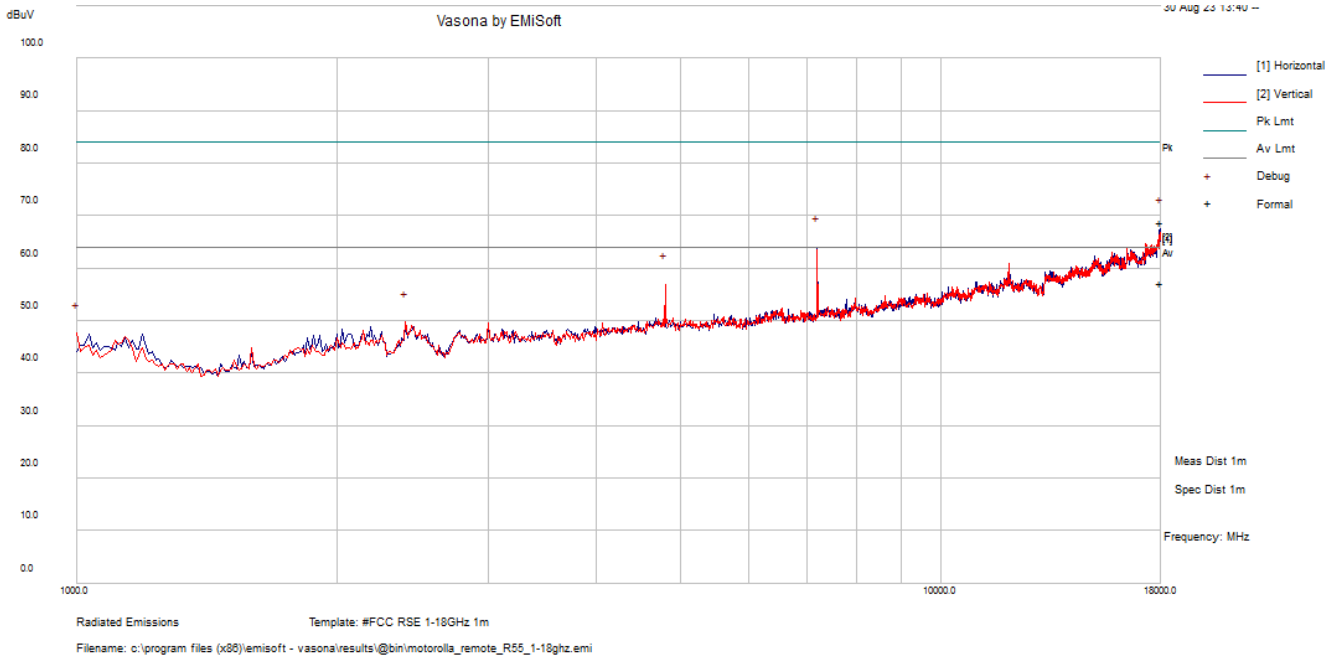

Frequency (MHz)	SA Reading (dBµV)	Correction Factor (dB/m)	Cord. Reading (dBµV/m)	Antenna Polarity	Antenna Height (cm)	Turntable Azimuth (degrees)	Limit (dBuV/m)	Margin (dB)	Comment
7205	57.74	6.3	64.04	H	200	0	84	-19.96	PK
7205	54.85	6.3	61.15	H	200	0	64	-2.85	Ave

16 GHz -18 GHz Noise Floor plot for average limit at 1 meter:

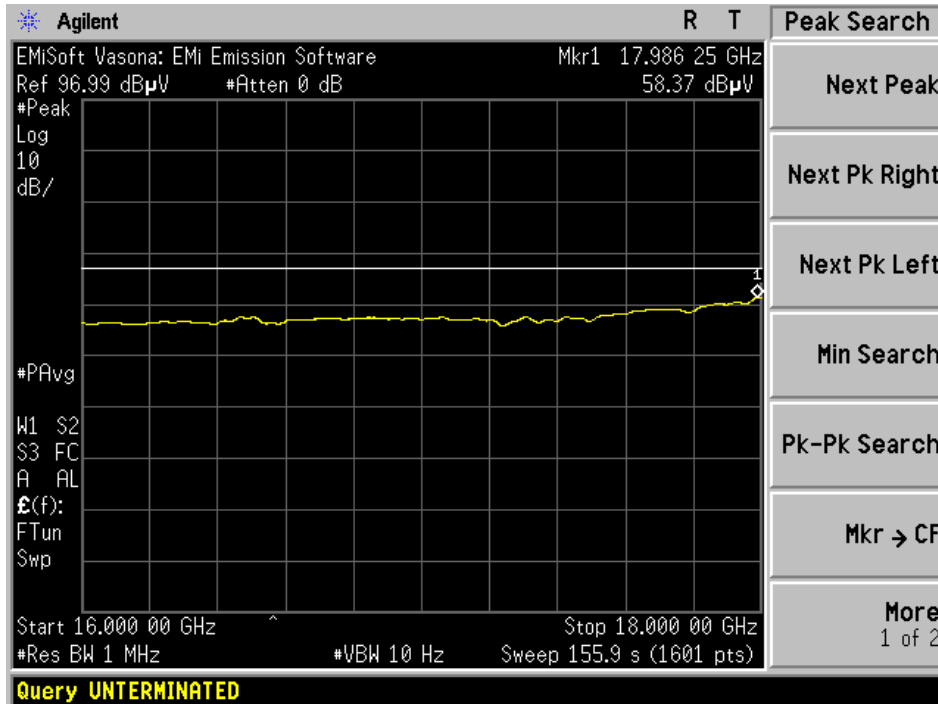

18 GHz – 26.5 GHz Radiated Field Strength measured at 1 meter:

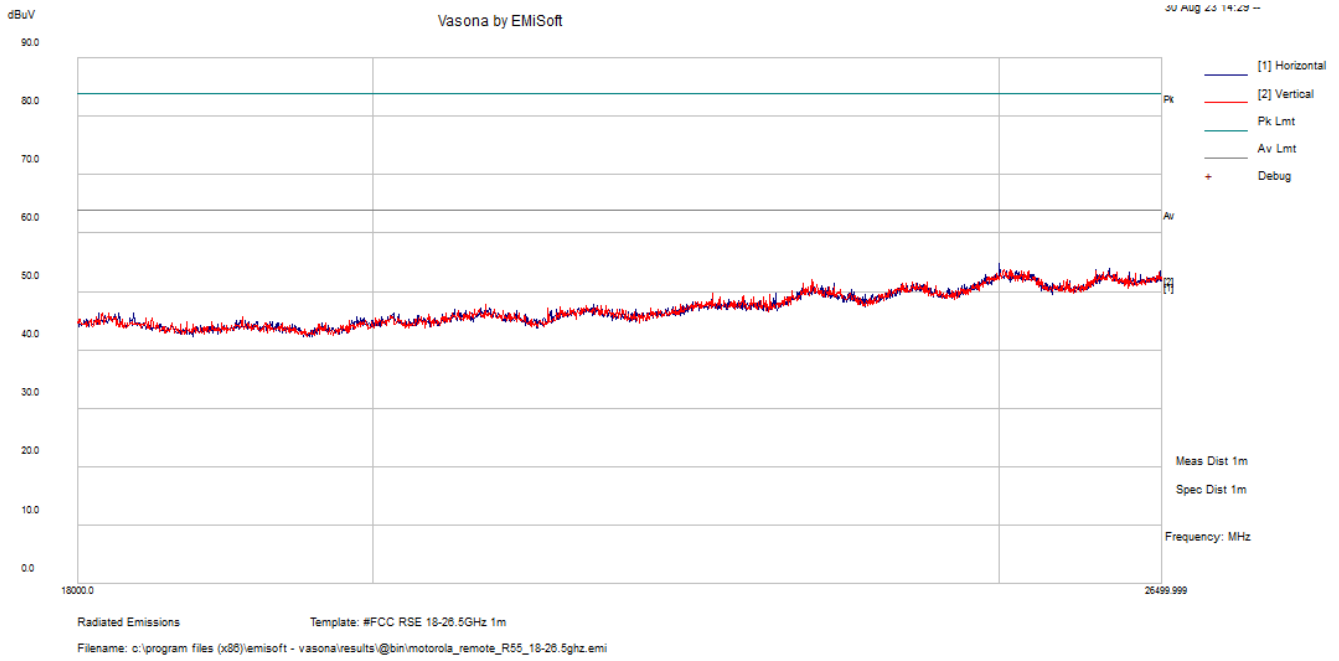

7 FCC §15.225(e) & ISEDC RSS-210 Annex B.6(b) – Frequency Tolerance

7.1 Applicable Standards

As per FCC §15.225(e): Operation within the band 13.110-14.010 MHz

(e) The frequency tolerance of the carrier signal shall be maintained within $\pm 0.01\%$ of the operating frequency over a temperature variation of -20 degrees to $+ 50$ degrees C at normal supply voltage, and for a variation in the primary supply voltage from 85% to 115% of the rated supply voltage at a temperature of 20 degrees C. For battery operated equipment, the equipment tests shall be performed using a new battery.

As per ISEDC RSS-210 Annex B.6 Band 13.110 – 14.010 MHz:

- b. the carrier frequency stability shall not exceed ± 100 ppm

7.2 Test Setup Block Diagram

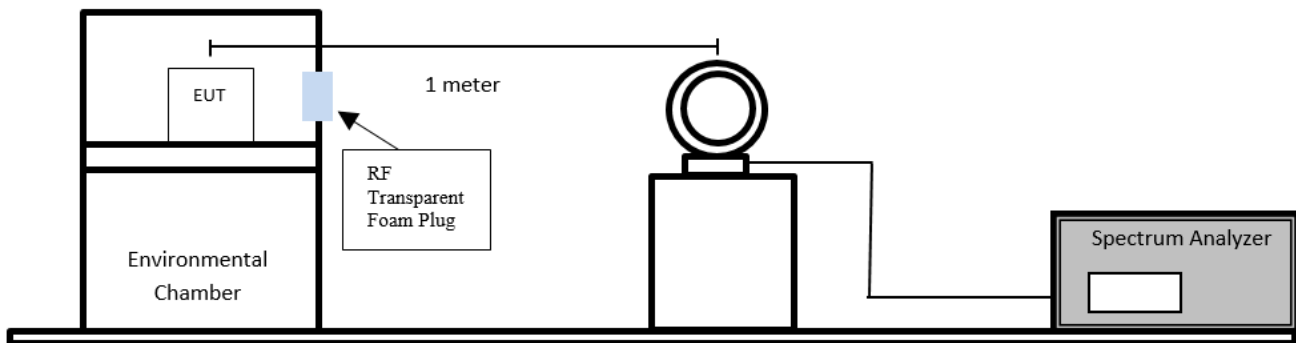

7.3 Test Equipment List and Details

Bacl No.	Manufacturer	Description	Model No.	Serial No.	Calibration Date	Calibration Interval
655	Rohde & Schwarz	Signal Analyzer	FSQ26	200749	2023-06-06	1 year
912	Rhode & Schwarz	Signal Analyzer	FSV40	1321.30 08k39- 101203 -UW	2023-06-02	1 year
471	Tenney	Environmental Chamber	TUJR	2744- 06	2022-09-23 ¹	1 year
471	Tenney	Environmental Chamber	TUJR	2744- 06	2023-08-22 ²	1 year
393	Com-Power	Active Loop Antenna	AL-130	17043	2023-05-26	2 years
-	-	RF Cable	-	-	Each Time ³	Each Time ³

¹ Calibration date for test performed on 2023-08-08.

² Calibration date for test performed on 2023-09-25.

Note³: cable included in the test set-up will be checked each time before testing.

Statement of Traceability: BACL Corp. attests that all of the calibrations on the equipment items listed above were traceable to NIST or to another internationally recognized National Metrology Institute (NMI), and were compliant with the latest version of A2LA policy P102 “A2LA Policy on Metrological Traceability”.

7.4 Test Environmental Conditions

Temperature:	23° C
Relative Humidity:	59 %
ATM Pressure:	101.4 kPa

The testing was performed by Deepak Mishra on 2023-08-08 at RF Site.

The testing was performed by Arturo Reyes on 2023-09-25 at RF Site.

7.5 Test Results

Normal Voltage 12V

Temperature °C	Operating Frequency (MHz)	Measured Frequency (MHz)	Frequency Tolerance (ppm)	Limit (ppm)	Result
-20	13.56	13.5600125	0.9218289	±100	Pass
-10	13.56	13.5600475	3.5029499	±100	Pass
0	13.56	13.5600825	6.0840708	±100	Pass
10	13.56	13.5600825	6.0840708	±100	Pass
20	13.56	13.5600725	5.3466077	±100	Pass
30	13.56	13.5600475	3.5029499	±100	Pass
40	13.56	13.5600475	3.5029499	±100	Pass
50	13.56	13.5600325	2.3967552	±100	Pass

Normal Temperature 20°C

Voltage (V)	Operating Frequency (MHz)	Measured Frequency (MHz)	Frequency Tolerance (ppm)	Limit (ppm)	Result
10.2	13.56	13.560075	5.5309735	±100	Pass
13.8	13.56	13.560075	5.5309735	±100	Pass

Note: Frequency Tolerance (ppm) = ((Measured Freq. – Operating Freq.) / Operating Freq.) x 1,000,000
Measured Freq. and Operating Freq. are in MHz.

Please refer to the following plots for detailed test data.

-20°C

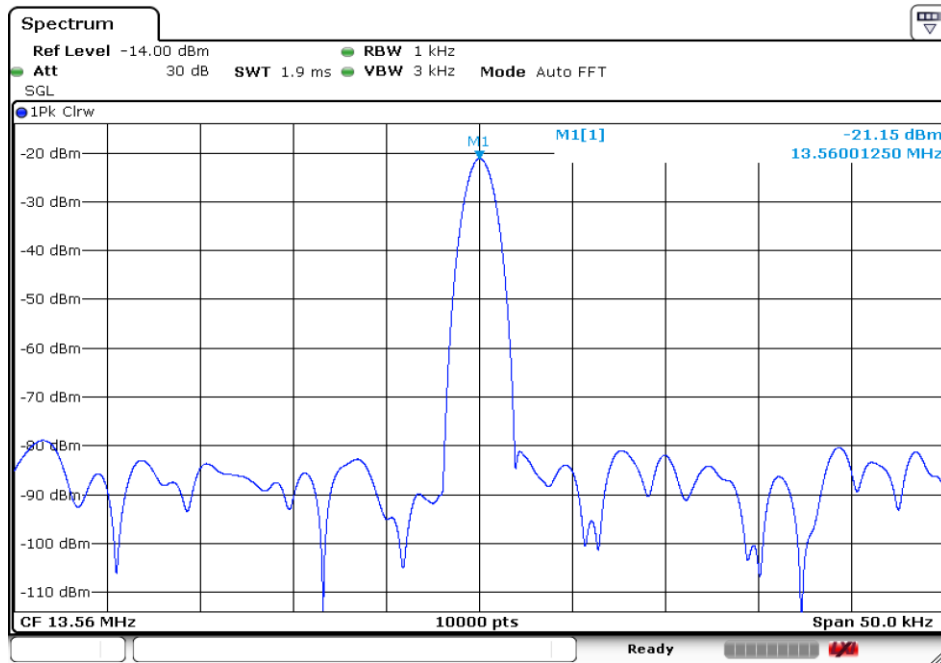

Date: 8.AUG.2023 18:12:02

-10°C

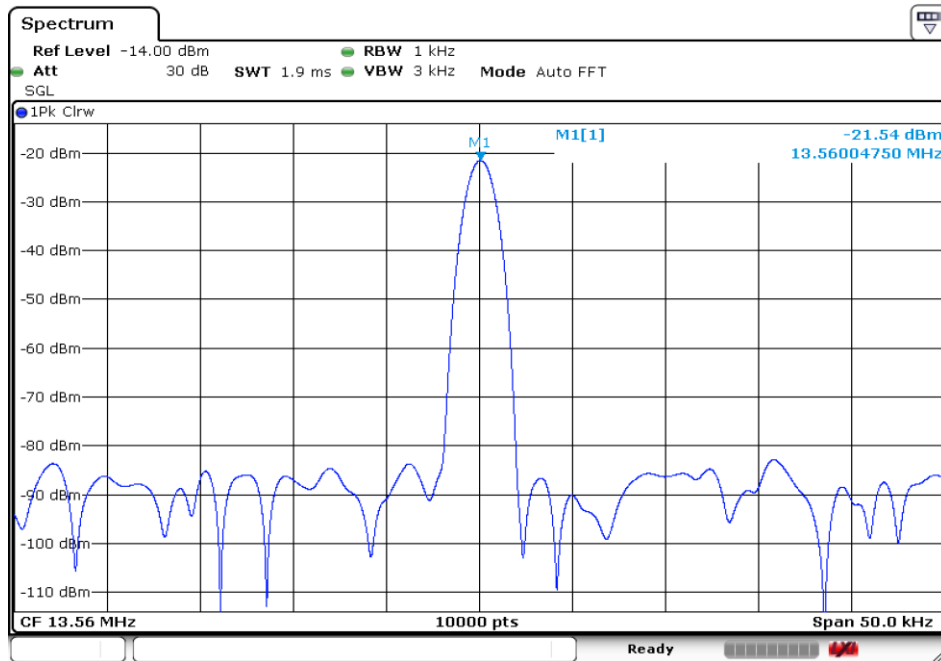

Date: 8.AUG.2023 18:26:18

0°C

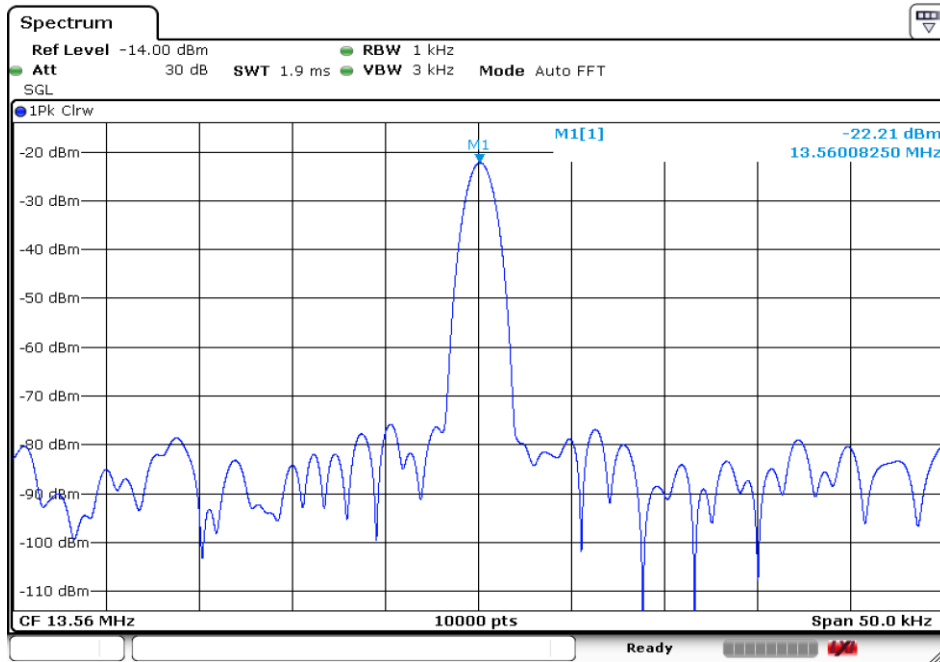

Date: 8.AUG.2023 19:14:45

10°C

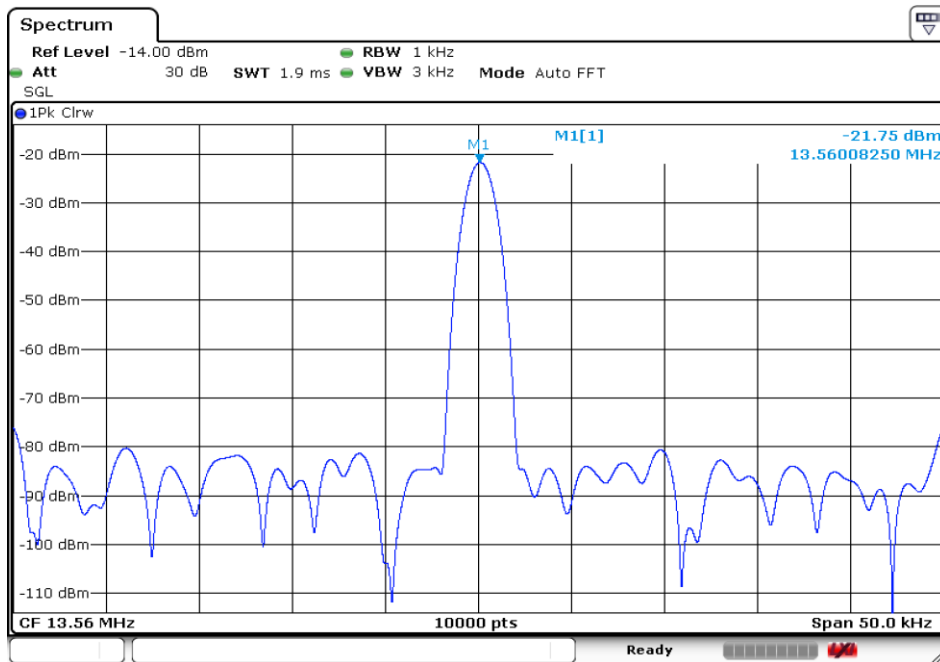

Date: 8.AUG.2023 19:24:12

20°C

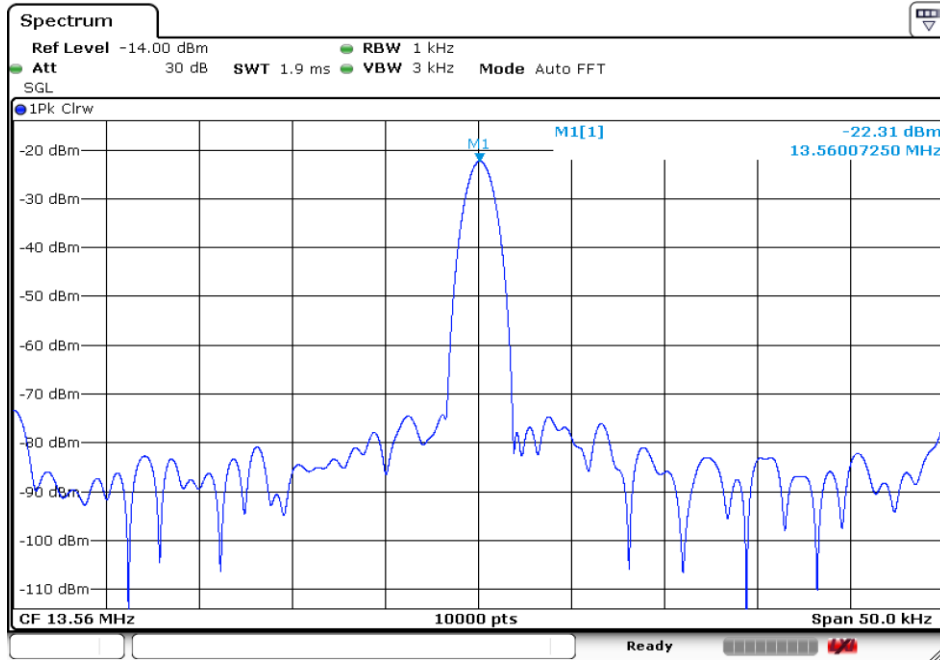

Date: 8.AUG.2023 19:36:37

30°C

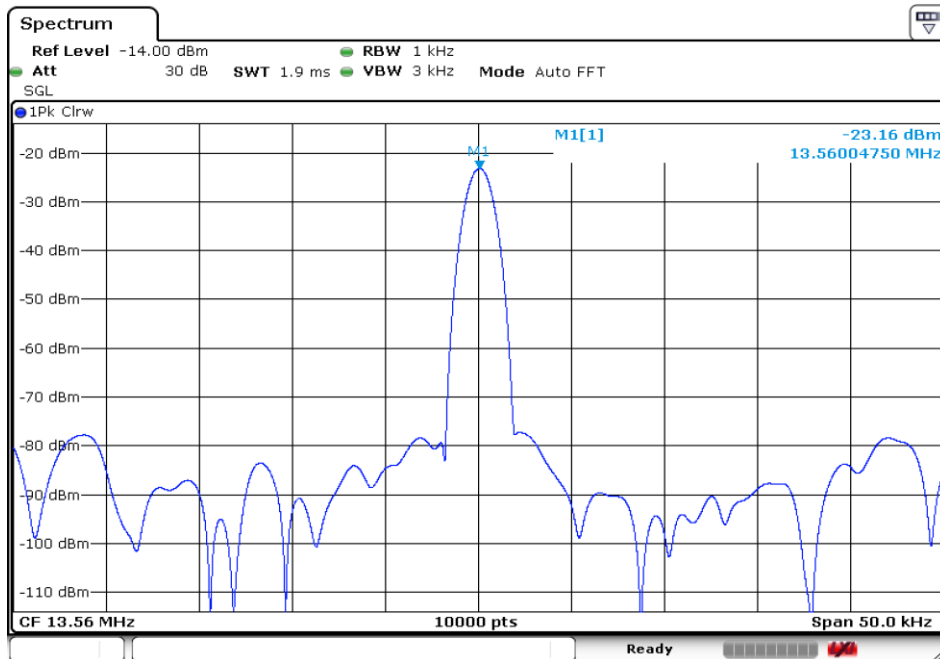

Date: 8.AUG.2023 19:54:45

40°C

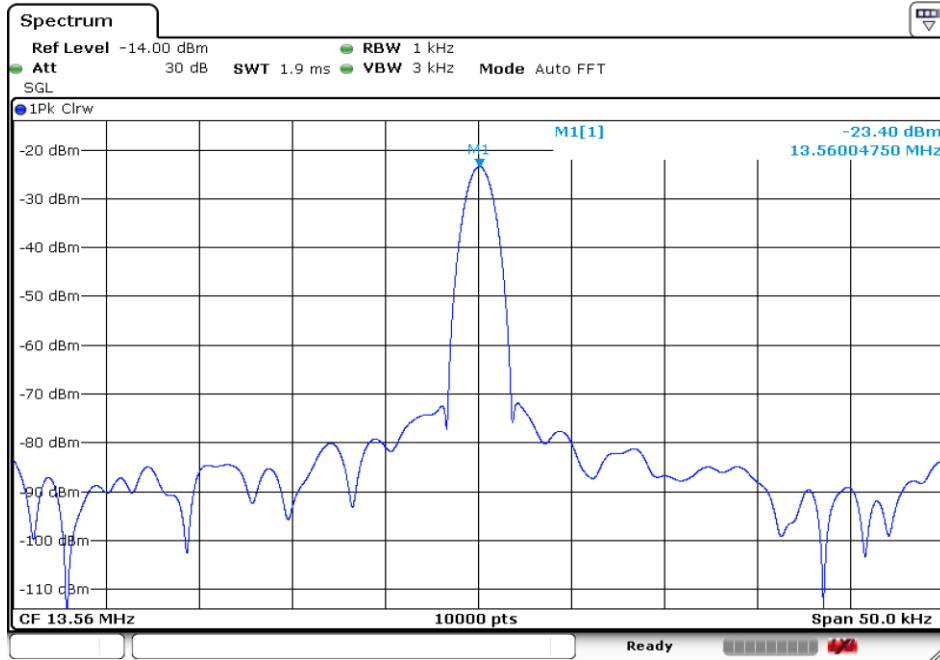

Date: 8.AUG.2023 20:02:44

50°C

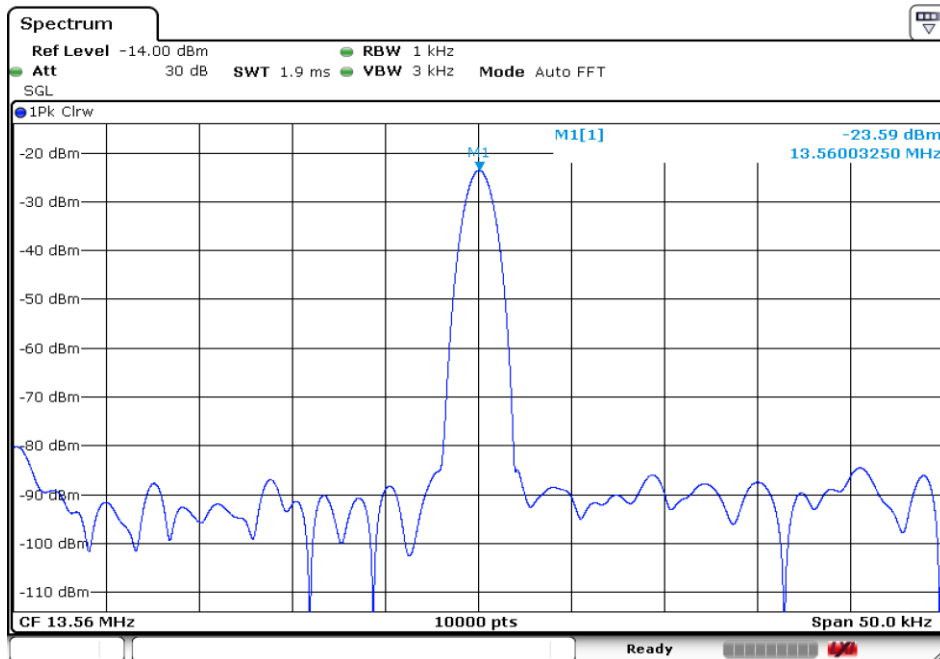

Date: 8.AUG.2023 20:13:06

10.2 Volts

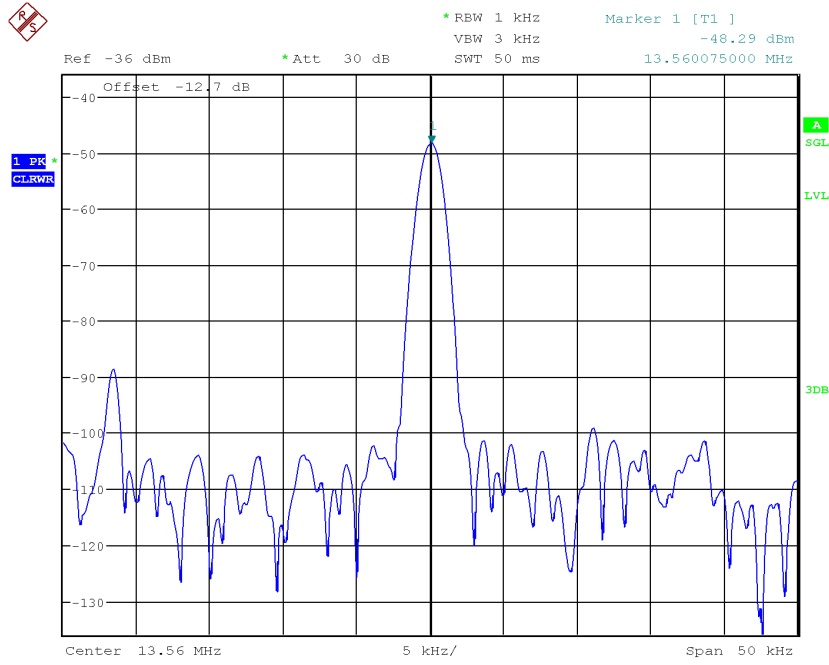

13.8 Volts

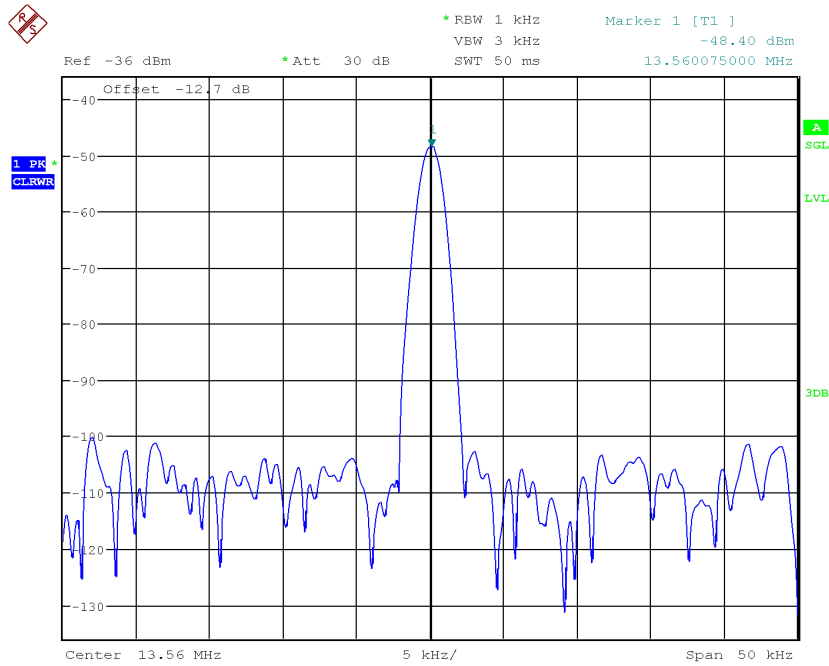

8 FCC §15.215(c) & ISEDC RSS-GEN §6.7 - Occupied Bandwidth

8.1 Applicable Standards

As per FCC §15.215(c):

Intentional radiators operating under the alternative provisions to the general emission limits, as contained in §§15.217 through 15.257 and in subpart E of this part, must be designed to ensure that the 20 dB bandwidth of the emission, or whatever bandwidth may otherwise be specified in the specific rule section under which the equipment operates, is contained within the frequency band designated in the rule section under which the equipment is operated. In the case of intentional radiators operating under the provisions of subpart E, the emission bandwidth may span across multiple contiguous frequency bands identified in that subpart. The requirement to contain the designated bandwidth of the emission within the specified frequency band includes the effects from frequency sweeping, frequency hopping and other modulation techniques that may be employed as well as the frequency stability of the transmitter over expected variations in temperature and supply voltage. If a frequency stability is not specified in the regulations, it is recommended that the fundamental emission be kept within at least the central 80% of the permitted band in order to minimize the possibility of out-of-band operation.

As per ISEDC RSS-GEN §6.7:

The occupied bandwidth or the “99% emission bandwidth” is defined as the frequency range between two points, one above and the other below the carrier frequency, within which 99% of the total transmitted power of the fundamental transmitted emission is contained. The occupied bandwidth shall be reported for all equipment in addition to the specified bandwidth required in the applicable RSSs.

In some cases, the “x dB bandwidth” is required, which is defined as the frequency range between two points, one at the lowest frequency below and one at the highest frequency above the carrier frequency, at which the maximum power level of the transmitted emission is attenuated x dB below the maximum in-band power level of the modulated signal, where the two points are on the outskirts of the in-band emission.

The following conditions shall be observed for measuring the occupied bandwidth and x dB bandwidth:

- The transmitter shall be operated at its maximum carrier power measured under normal test conditions.
- The span of the spectrum analyzer shall be set large enough to capture all products of the modulation process, including the emission skirts, around the carrier frequency, but small enough to avoid having other emissions (e.g. on adjacent channels) within the span.
- The detector of the spectrum analyzer shall be set to “Sample”. However, a peak, or peak hold, may be used in place of the sampling detector since this usually produces a wider bandwidth than the actual bandwidth (worst-case measurement). Use of a peak hold (or “Max Hold”) may be necessary to determine the occupied / x dB bandwidth if the device is not transmitting continuously.

The resolution bandwidth (RBW) shall be in the range of 1% to 5% of the actual occupied / x dB bandwidth and the video bandwidth (VBW) shall not be smaller than three times the RBW value. Video averaging is not permitted

8.2 Test Setup

The radiated emissions tests were performed in the 5-meter Chamber, using the setup in accordance with ANSI C63.10-2013. The specification utilized was the FCC §15.225, §15.209 limits.

The spacing between the peripherals was 10 centimeters.

External I/O cables were draped along the edge of the test table and bundle when necessary.

8.3 Test Setup Block Diagram

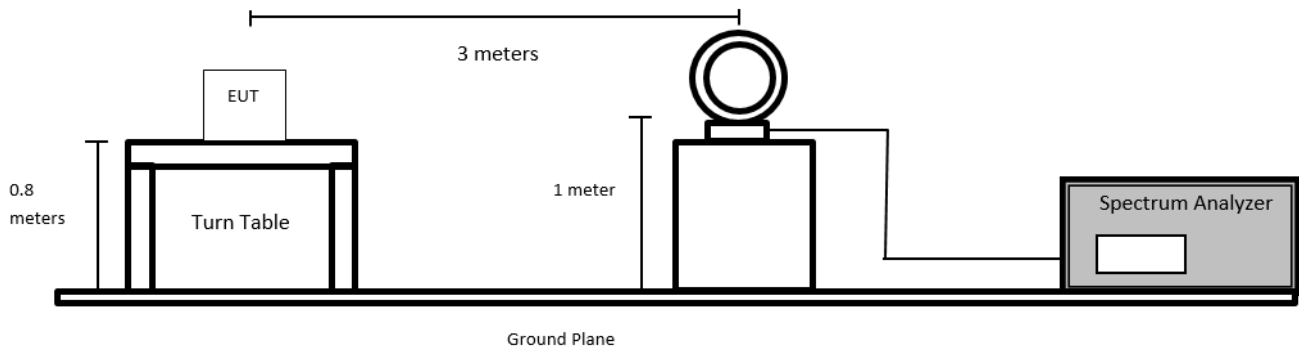

8.4 Test Equipment List and Details

Bacl No.	Manufacturer	Description	Model No.	Serial No.	Calibration Date	Calibration Interval
912	Rhode & Schwarz	Signal Analyzer	FSV40	1321.30 08k39- 101203 -UW	2023-06-02	1 year
393	Com-Power	Active Loop Antenna	AL-130	17043	2023-05-26	2 years
1186	Pasternack	Coaxial Cable, RG214	PE3062-1050CM	N/A	2023-04-14	6 months

Statement of Traceability: *BACL Corp.* attests that all of the calibrations on the equipment items listed above were traceable to NIST or to another internationally recognized National Metrology Institute (NMI), and were compliant with the latest version of A2LA policy P102 “A2LA Policy on Metrological Traceability”.

8.5 Test Environmental Conditions

Temperature:	23° C
Relative Humidity:	59 %
ATM Pressure:	101.4 kPa

The testing was performed by Arturo Reyes on 2023-09-22 at RF Site.

8.6 Test Results

13.56MHz

20 dB Bandwidth: 755 Hz

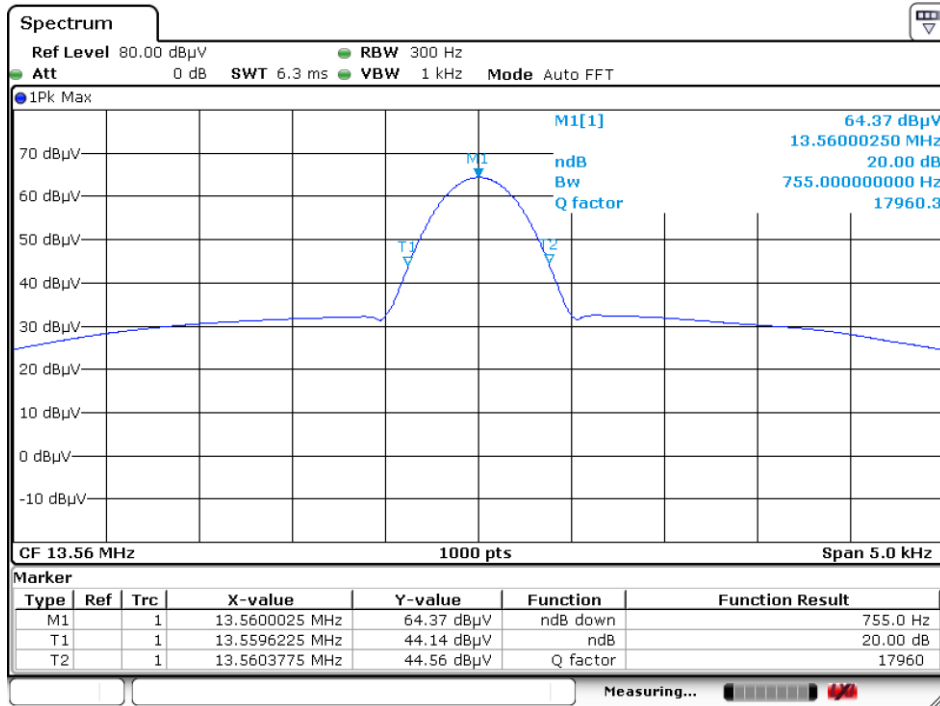

Date: 22.SEP.2023 22:31:56

125 kHz

20 dB Bandwidth: 520 Hz

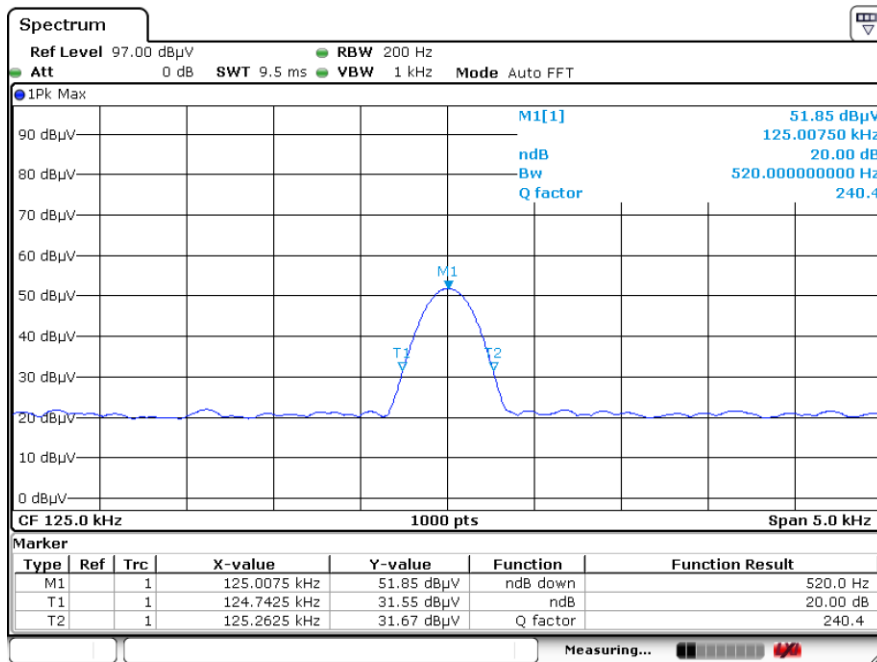

Date: 22.SEP.2023 22:48:54

9 Annex A (Normative) - Test Setup Photographs

Please refer to the attachment

10 Annex B (Normative) - EUT External Photographs

Please refer to the attachment

11 Annex C (Normative) - EUT Internal Photographs

Please refer to the attachment

12 Annex D (Normative) - A2LA Electrical Testing Certificate



Accredited Laboratory

A2LA has accredited

BAY AREA COMPLIACE LABORATORIES CORP.

Sunnyvale, CA

for technical competence in the field of

Electrical Testing

This laboratory is accredited in accordance with the recognized International Standard ISO/IEC 17025:2017 General requirements for the competence of testing and calibration laboratories. This laboratory also meets A2LA R222 - Specific Requirements EPA ENERGY STAR Accreditation Program. This accreditation demonstrates technical competence for a defined scope and the operation of a laboratory quality management system (refer to joint ISO-ILAC-IAF Communiqué dated April 2017).



Presented this 21st day of December 2022.

Mr. Trace McInturff, Vice President, Accreditation Services
For the Accreditation Council
Certificate Number 3297.02
Valid to September 30, 2024

For the tests to which this accreditation applies, please refer to the laboratory's Electrical Scope of Accreditation.

Please follow the web link below for a full ISO 17025 scope

--- END OF REPORT ---