

FCC Radio Test Report

FCC ID: 2APJB-NE1

Original Grant

Report No. : TB-FCC159521
Applicant : Netool llc
Equipment Under Test (EUT)
EUT Name : Battery operated Ethernet Packet analyzer and Wi-Fi router
Model No. : NE1
Series Model No. : NE2, NE3
Brand Name : Netool.io
Receipt Date : 2018-04-26
Test Date : 2018-04-27 to 2018-05-11
Issue Date : 2018-05-15
Standards : FCC Part 15, Subpart C (15.247:2017)
Test Method : ANSI C63.10: 2013
Conclusions : **PASS**

In the configuration tested, the EUT complied with the standards specified above,
The EUT technically complies with the FCC and IC requirements

Test/Witness Engineer : *Jason xu* Jason Xu
Engineer Supervisor : *IVAN SU* Ivan Su
Engineer Manager : *Ray Lai* Ray Lai

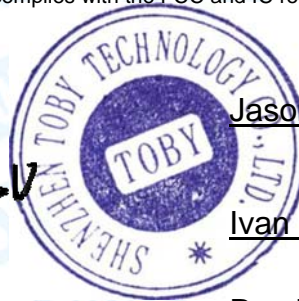

This report details the results of the testing carried out on one sample. The results contained in this test report do not relate to other samples of the same product. The manufacturer should ensure that all products in series production are in conformity with the product sample detailed in the report.

Contents

| | |
|---|-----------|
| CONTENTS | 2 |
| 1. GENERAL INFORMATION ABOUT EUT | 5 |
| 1.1 Client Information..... | 5 |
| 1.2 General Description of EUT (Equipment Under Test) | 5 |
| 1.3 Block Diagram Showing the Configuration of System Tested..... | 6 |
| 1.4 Description of Support Units | 6 |
| 1.5 Description of Test Mode..... | 7 |
| 1.6 Description of Test Software Setting | 8 |
| 1.7 Measurement Uncertainty | 8 |
| 1.8 Test Facility..... | 9 |
| 2. TEST SUMMARY | 10 |
| 3. TEST EQUIPMENT | 11 |
| 4. CONDUCTED EMISSION TEST | 12 |
| 4.1 Test Standard and Limit..... | 12 |
| 4.2 Test Setup..... | 12 |
| 4.3 Test Procedure..... | 12 |
| 4.4 EUT Operating Mode | 13 |
| 4.5 Test Data..... | 13 |
| 5. RADIATED EMISSION TEST | 14 |
| 5.1 Test Standard and Limit..... | 14 |
| 5.2 Test Setup..... | 15 |
| 5.3 Test Procedure..... | 16 |
| 5.4 EUT Operating Condition | 16 |
| 5.5 Test Data..... | 17 |
| 6. RESTRICTED BANDS REQUIREMENT | 18 |
| 6.1 Test Standard and Limit..... | 18 |
| 6.2 Test Setup..... | 18 |
| 6.3 Test Procedure..... | 18 |
| 6.4 EUT Operating Condition | 19 |
| 6.5 Test Data..... | 19 |
| 7. BANDWIDTH TEST | 20 |
| 7.1 Test Standard and Limit..... | 20 |
| 7.2 Test Setup..... | 20 |
| 7.3 Test Procedure..... | 20 |
| 7.4 EUT Operating Condition | 20 |
| 7.5 Test Data..... | 20 |
| 8. PEAK OUTPUT POWER TEST | 21 |
| 8.1 Test Standard and Limit..... | 21 |

| | |
|---|-----------|
| 8.2 Test Setup..... | 21 |
| 8.3 Test Procedure..... | 21 |
| 8.4 EUT Operating Condition | 21 |
| 8.5 Test Data..... | 21 |
| 9. POWER SPECTRAL DENSITY TEST | 22 |
| 9.1 Test Standard and Limit..... | 22 |
| 9.2 Test Setup..... | 22 |
| 9.3 Test Procedure..... | 22 |
| 9.4 EUT Operating Condition | 22 |
| 9.5 Test Data..... | 22 |
| 10. ANTENNA REQUIREMENT..... | 23 |
| 10.1 Standard Requirement..... | 23 |
| 10.2 Antenna Connected Construction..... | 23 |
| ATTACHMENT A-- CONDUCTED EMISSION TEST DATA | 24 |
| ATTACHMENT B-- RADIATED EMISSION TEST DATA | 28 |
| ATTACHMENT C-- RESTRICTED BANDS REQUIREMENT TEST DATA..... | 54 |
| ATTACHMENT D-- BANDWIDTH TEST DATA..... | 74 |
| ATTACHMENT E-- PEAK OUTPUT POWER TEST DATA..... | 82 |
| ATTACHMENT F-- POWER SPECTRAL DENSITY TEST DATA..... | 85 |

Revision History

| Report No. | Version | Description | Issued Date |
|--------------|---------|-------------------------|-------------|
| TB-FCC159521 | Rev.01 | Initial issue of report | 2018-05-15 |
| | | | |
| | | | |
| | | | |
| | | | |
| | | | |
| | | | |
| | | | |
| | | | |
| | | | |
| | | | |
| | | | |
| | | | |
| | | | |
| | | | |
| | | | |
| | | | |
| | | | |
| | | | |
| | | | |

1. General Information about EUT

1.1 Client Information

| | | |
|---------------------|---|---|
| Applicant | : | Netool llc |
| Address | : | P.O. box 2500, Minden Nv 89423, USA |
| Manufacturer | : | WUDOUMI ELECTRONICS TECHNOLOGY COMPANY |
| Address | : | 3F, 5th Building, Xinhui industrial zone, Bantian Street, Longgang Shenzhen |

1.2 General Description of EUT (Equipment Under Test)

| | | | |
|-------------------------------|---|---|--|
| EUT Name | : | Battery operated Ethernet Packet analyzer and Wi-Fi router | |
| Models No. | : | NE1, NE2, NE3 | |
| Model Difference | : | All these models are identical in the same PCB, layout and electrical circuit, the only difference is appearance color. | |
| Product Description | : | Operation Frequency: | 802.11b/g/n(HT20): 2412MHz~2462MHz 802.11n(HT40): 2422MHz~2452MHz |
| | | Number of Channel: | 802.11b/g/n(HT20):11 channels see note(3) 802.11b/g/n(HT40):9 channels see note(3) |
| | | RF Output Power: | 802.11b: 14.54dBm 802.11g: 13.88dBm 802.11n (HT20): 12.80dBm 802.11n (HT40): 13.16dBm |
| | | Antenna Gain: | 2dBi Ceramics Antenna |
| Power Supply | : | DC Voltage Supply from USB Port. DC Supply by the Battery. | |
| Power Rating | : | Input: DC 5.0 V/1A from the USB Cable. DC 3.7V 2600mAh by Li-ion Battery. Output: DC 5V/0.8A | |
| Software Version | : | N/A | |
| Hardware Version | : | N/A | |
| Connecting I/O Port(S) | : | Please refer to the User's Manual | |

Note:

- (1) This Test Report is FCC Part 15.247 for 802.11b/g/n, the test procedure follows the FCC KDB 558074 D01 DTS Meas Guidance v04.
- (2) For a more detailed features description, please refer to the manufacturer's specifications or the User's Manual.

(3) Channel List:

| Channel | Frequency (MHz) | Channel | Frequency (MHz) | Channel | Frequency (MHz) |
|---------|-----------------|---------|-----------------|---------|-----------------|
| 01 | 2412 | 05 | 2432 | 09 | 2452 |
| 02 | 2417 | 06 | 2437 | 10 | 2457 |
| 03 | 2422 | 07 | 2442 | 11 | 2462 |
| 04 | 2427 | 08 | 2447 | | |

Note: CH 01~CH 11 for 802.11b/g/n(HT20)
CH 03~CH 9 for 802.11n(HT40)

(4) The Antenna information about the equipment is provided by the applicant.

1.3 Block Diagram Showing the Configuration of System Tested

USB Charging Mode

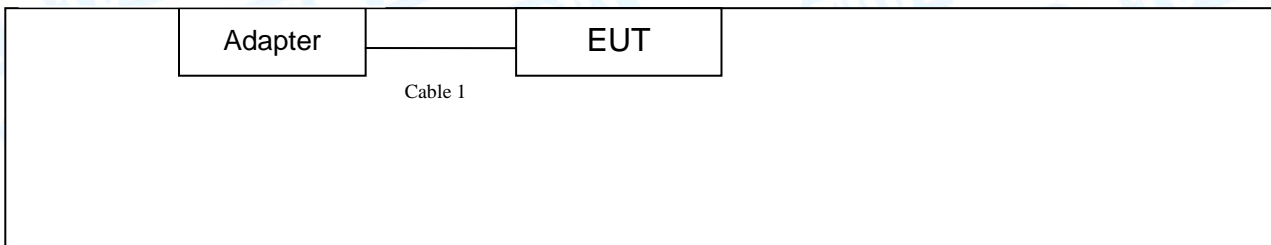

TX Mode

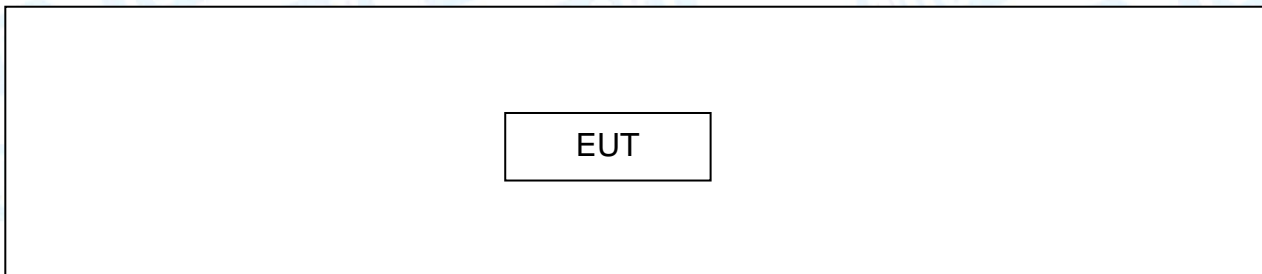

1.4 Description of Support Units

| Equipment Information | | | | |
|-----------------------|---------------|--------------|--------------|----------|
| Name | Model | FCC ID/VOC | Manufacturer | Used "√" |
| Adapter | K-E30502000U1 | ---- | | √ |
| Cable Information | | | | |
| Number | Shielded Type | Ferrite Core | Length | Note |
| Cable 1 | NO | NO | 0.8M | |

1.5 Description of Test Mode

To investigate the maximum EMI emission characteristics generates from EUT, the test system was pre-scanning tested base on the consideration of following EUT operation mode or test configuration mode which possible have effect on EMI emission level. Each of these EUT operation mode(s) or test configuration mode(s) mentioned follow was evaluated respectively.

| For Conducted Test | |
|--------------------|-----------------------------|
| Final Test Mode | Description |
| Mode 1 | USB Charging with TX B Mode |

| For Radiated Test | |
|-------------------|---------------------------------------|
| Final Test Mode | Description |
| Mode 2 | TX Mode B Mode Channel 01/06/11 |
| Mode 3 | TX Mode G Mode Channel 01/06/11 |
| Mode 4 | TX Mode N(HT20) Mode Channel 01/06/11 |
| Mode 5 | TX Mode N(HT40) Mode Channel 03/06/09 |

Note:

- (1) For all test, we have verified the construction and function in typical operation. And all the test modes were carried out with the EUT in transmitting operation in maximum power with all kinds of data rate.
According to ANSI C63.10 standards, the measurements are performed at the highest, Middle, lowest available channels, and the worst case data rate as follows:
 - 802.11b Mode: CCK (1 Mbps)
 - 802.11g Mode: OFDM (6 Mbps)
 - 802.11n (HT20) Mode: MCS 0 (6.5 Mbps)
 - 802.11n (HT40) Mode: MCS 0 (13 Mbps)
- (2) During the testing procedure, the continuously transmitting with the maximum power mode was programmed by the customer.
- (3) The EUT is considered a portable unit; in normal use it was positioned on X-plane. The worst case was found positioned on X-plane. Therefore only the test data of this X-plane was used for radiated emission measurement test.

1.6 Description of Test Software Setting

During testing channel&Power controlling software provided by the customer was used to control the operating channel as well as the output power level. The RF output power selection is for the setting of RF output power expected by the customer and is going to be fixed on the firmware of the final end product power parameters of WLAN.

| Test Software Version | RT5350QA.exe | | |
|-----------------------|--------------|-------|-------|
| Channel | CH 01 | CH 06 | CH 11 |
| IEEE 802.11b DSSS | 0F | 0F | 0F |
| IEEE 802.11g OFDM | 0F | 0F | 0F |
| IEEE 802.11n (HT20) | 0C | 0C | 0C |
| Test Software Version | RT5350QA.exe | | |
| Channel | CH 03 | CH 06 | CH 09 |
| IEEE 802.11n (HT40) | 0C | 0C | 0C |

1.7 Measurement Uncertainty

The reported uncertainty of measurement $y \pm U$, where expanded uncertainty U is based on a standard uncertainty multiplied by a coverage factor of $k=2$, providing a level of confidence of approximately 95 %.

| Test Item | Parameters | Expanded Uncertainty (U_{Lab}) |
|--------------------|--------------------------------------|------------------------------------|
| Conducted Emission | Level Accuracy: 9kHz~150kHz | ± 3.42 dB |
| | 150kHz to 30MHz | ± 3.42 dB |
| Radiated Emission | Level Accuracy: 9kHz to 30 MHz | ± 4.60 dB |
| Radiated Emission | Level Accuracy: 30MHz to 1000 MHz | ± 4.40 dB |
| Radiated Emission | Level Accuracy: Above 1000MHz | ± 4.20 dB |

1.8 Test Facility

The testing report were performed by the Shenzhen Toby Technology Co., Ltd., in their facilities located at 1A/F., Bldg.6, Yusheng Industrial Zone, The National Road No.107 Xixiang Section 467, Xixiang, Bao'an, Shenzhen, Guangdong, China. At the time of testing, the following bodies accredited the Laboratory:

CNAS (L5813)

The Laboratory has been accredited by CNAS to ISO/IEC 17025: 2005 General Requirements for the Competence of Testing and Calibration Laboratories for the competence in the field of testing. And the Registration No.: CNAS L5813.

A2LA Certificate No.: 4750.01

The laboratory has been accredited by American Association for Laboratory Accreditation(A2LA) to ISO/IEC 17025: 2005 General Requirements for the Competence of Testing and Calibration Laboratories for the technical competence in the field of Electrical Testing. And the A2LA Certificate No.: 4750.01.

IC Registration No.: (11950A-1)

The Laboratory has been registered by Certification and Engineering Bureau of Industry Canada for radio equipment testing. The site registration: Site# 11950A-1.

2. Test Summary

| FCC Part 15 Subpart C(15.247)/ RSS 247 Issue 2 | | | | |
|--|--------------------|---|----------|--------|
| Standard Section | | Test Item | Judgment | Remark |
| FCC | IC | | | |
| 15.203 | / | Antenna Requirement | PASS | N/A |
| 15.207 | RSS-GEN 7.2.4 | Conducted Emission | PASS | N/A |
| 15.205 | RSS-GEN 7.2.2 | Restricted Bands | PASS | N/A |
| 15.247(a)(2) | RSS 247 5.2 (1) | 6dB Bandwidth | PASS | N/A |
| 15.247(b) | RSS 247 5.4 (4) | Peak Output Power | PASS | N/A |
| 15.247(e) | RSS 247 5.2 (2) | Power Spectral Density | PASS | N/A |
| 15.247(d) | RSS 247 5.5 | Band Edge | PASS | N/A |
| 15.247(d)& 15.209 | RSS 247 5.5 | Transmitter Radiated Spurious Emission | PASS | N/A |

Note: “/” for no requirement for this test item.
N/A is an abbreviation for Not Applicable.

3. Test Equipment

| Conducted Emission Test | | | | | |
|----------------------------|----------------------------------|-------------------|---------------|---------------|---------------|
| Equipment | Manufacturer | Model No. | Serial No. | Last Cal. | Cal. Due Date |
| EMI Test Receiver | Rohde & Schwarz | ESCI | 100321 | Jul. 20, 2017 | Jul. 19, 2018 |
| RF Switching Unit | Compliance Direction Systems Inc | RSU-A4 | 34403 | Jul. 20, 2017 | Jul. 19, 2018 |
| AMN | SCHWARZBECK | NNBL 8226-2 | 8226-2/164 | Jul. 20, 2017 | Jul. 19, 2018 |
| LISN | Rohde & Schwarz | ENV216 | 101131 | Jul. 20, 2017 | Jul. 19, 2018 |
| Radiation Emission Test | | | | | |
| Equipment | Manufacturer | Model No. | Serial No. | Last Cal. | Cal. Due Date |
| Spectrum Analyzer | Agilent | E4407B | MY45106456 | Jul. 20, 2017 | Jul. 19, 2018 |
| EMI Test Receiver | Rohde & Schwarz | ESPI | 100010/007 | Jul. 20, 2017 | Jul. 19, 2018 |
| Bilog Antenna | ETS-LINDGREN | 3142E | 00117537 | Mar.25, 2017 | Mar. 24, 2018 |
| Bilog Antenna | ETS-LINDGREN | 3142E | 00117542 | Mar.25, 2017 | Mar. 24, 2018 |
| Horn Antenna | ETS-LINDGREN | 3117 | 00143207 | Mar.24, 2017 | Mar. 23, 2018 |
| Horn Antenna | ETS-LINDGREN | 3117 | 00143209 | Mar.24, 2017 | Mar. 23, 2018 |
| Loop Antenna | SCHWARZBECK | FMZB 1519 B | 1519B-059 | Jul. 03, 2017 | Jul. 02, 2018 |
| Pre-amplifier | Sonoma | 310N | 185903 | Mar.24, 2017 | Mar. 23, 2018 |
| Pre-amplifier | HP | 8449B | 3008A00849 | Mar.25, 2017 | Mar. 24, 2018 |
| Cable | HUBER+SUHNER | 100 | SUCOFLEX | Mar.24, 2017 | Mar. 23, 2018 |
| Positioning Controller | ETS-LINDGREN | 2090 | N/A | N/A | N/A |
| Antenna Conducted Emission | | | | | |
| Equipment | Manufacturer | Model No. | Serial No. | Last Cal. | Cal. Due Date |
| Spectrum Analyzer | Agilent | E4407B | MY45106456 | Jul. 20, 2017 | Jul. 19, 2018 |
| Spectrum Analyzer | Rohde & Schwarz | ESCI | 100010/007 | Jul. 20, 2017 | Jul. 19, 2018 |
| MXA Signal Analyzer | Agilent | N9020A | MY49100060 | Oct. 26, 2017 | Oct. 25, 2018 |
| Vector Signal Generator | Agilent | N5182A | MY50141294 | Oct. 26, 2017 | Oct. 25, 2018 |
| Analog Signal Generator | Agilent | N5181A | MY50141953 | Oct. 26, 2017 | Oct. 25, 2018 |
| RF Power Sensor | DARE!! Instruments | RadiPowerRPR3006W | 17I00015SNO26 | Oct. 26, 2017 | Oct. 25, 2018 |
| | DARE!! Instruments | RadiPowerRPR3006W | 17I00015SNO29 | Oct. 26, 2017 | Oct. 25, 2018 |
| | DARE!! Instruments | RadiPowerRPR3006W | 17I00015SNO31 | Oct. 26, 2017 | Oct. 25, 2018 |
| | DARE!! Instruments | RadiPowerRPR3006W | 17I00015SNO33 | Oct. 26, 2017 | Oct. 25, 2018 |

4. Conducted Emission Test

4.1 Test Standard and Limit

4.1.1 Test Standard

FCC Part 15.207

4.1.2 Test Limit

Conducted Emission Test Limit

| Frequency | Maximum RF Line Voltage (dB μ V) | |
|---------------|--------------------------------------|---------------|
| | Quasi-peak Level | Average Level |
| 150kHz~500kHz | 66 ~ 56 * | 56 ~ 46 * |
| 500kHz~5MHz | 56 | 46 |
| 5MHz~30MHz | 60 | 50 |

Notes:

(1) *Decreasing linearly with logarithm of the frequency.

(2) The lower limit shall apply at the transition frequencies.

(3) The limit decrease in line with the logarithm of the frequency in the range of 0.15 to 0.50MHz.

4.2 Test Setup

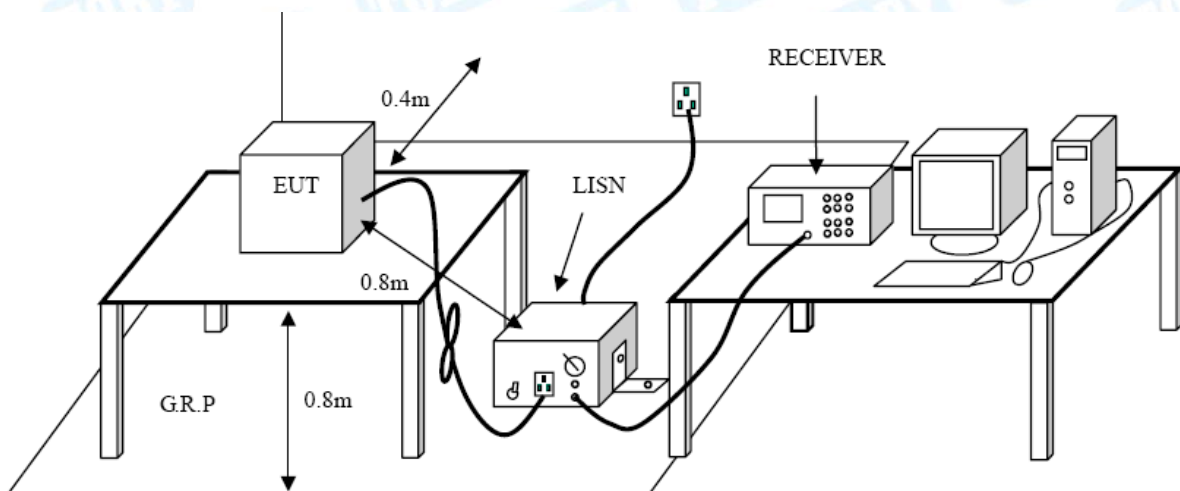

4.3 Test Procedure

The EUT was placed 0.8 meters from the horizontal ground plane with EUT being connected to the power mains through a line impedance stabilization network (LISN). All other support equipments powered from additional LISN(s). The LISN provide 50 Ohm/ 50uH of coupling impedance for the measuring instrument.

Interconnecting cables that hang closer than 40 cm to the ground plane shall be folded back and forth in the center forming a bundle 30 to 40 cm long.

I/O cables that are not connected to a peripheral shall be bundled in the center. The end of the cable may be terminated, if required, using the correct terminating impedance. The overall length shall not exceed 1 m.

LISN at least 80 cm from nearest part of EUT chassis.

The bandwidth of EMI test receiver is set at 9kHz, and the test frequency band is from 0.15MHz to 30MHz.

4.4 EUT Operating Mode

Please refer to the description of test mode.

4.5 Test Data

Please refer to the Attachment A.

5. Radiated Emission Test

5.1 Test Standard and Limit

5.1.1 Test Standard

FCC Part 15.209

5.1.2 Test Limit

Radiated Emission Limits (9 kHz~1000 MHz)

| Frequency (MHz) | Field Strength (microvolt/meter) | Measurement Distance (meters) |
|-----------------|----------------------------------|-------------------------------|
| 0.009~0.490 | 2400/F(KHz) | 300 |
| 0.490~1.705 | 24000/F(KHz) | 30 |
| 1.705~30.0 | 30 | 30 |
| 30~88 | 100 | 3 |
| 88~216 | 150 | 3 |
| 216~960 | 200 | 3 |
| Above 960 | 500 | 3 |

Radiated Emission Limit (Above 1000MHz)

| Frequency (MHz) | Distance of 3m (dBuV/m) | |
|-----------------|-------------------------|---------|
| | Peak | Average |
| Above 1000 | 74 | 54 |

Note:

- (1) The tighter limit applies at the band edges.
- (2) Emission Level(dBuV/m)=20log Emission Level(uV/m)

5.2 Test Setup

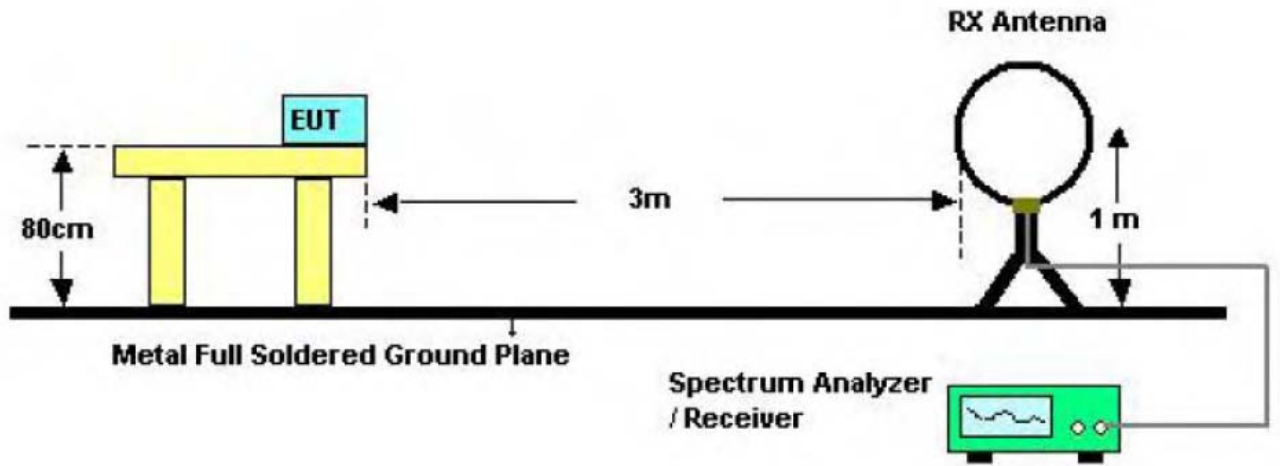

Below 30MHz Test Setup

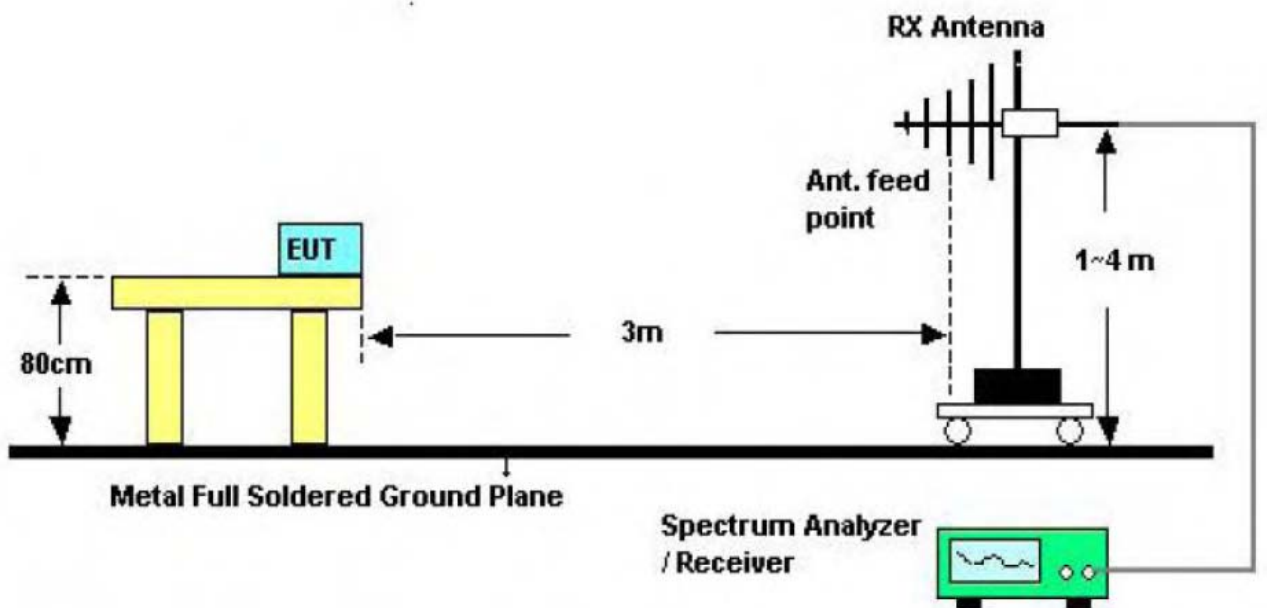

Below 1000MHz Test Setup



Above 1GHz Test Setup

5.3 Test Procedure

- (1) Measurements at frequency above 1GHz. The EUT was placed on a rotating 1.5m high above the ground. RF absorbers covered the ground plane with a minimum area of 3.0m by 3.0m between the EUT and measurement receiver antenna. The RF absorber shall not exceed 30cm in high above the conducting floor. The table was rotated 360 degrees to determine the position of the highest radiation.
- (2) The Test antenna shall vary between 1m and 4m, Both Horizontal and Vertical antenna are set to make measurement.
- (3) The initial step in collecting conducted emission data is a spectrum analyzer peak detector mode pre-scanning the measurement frequency range. Significant peaks are then marked and then Quasi Peak detector mode re-measured.
- (4) If the Peak Mode measured value compliance with and lower than Quasi Peak Mode Limit Bellow 1 GHz, the EUT shall be deemed to meet QP Limits and then no additional QP Mode measurement performed. But the Peak Value and average value both need to comply with applicable limit above 1 GHz.
- (5) Testing frequency range below 1GHz the measuring instrument use VBW=120 kHz with Quasi-peak detection.
- (6) Testing frequency range above 1GHz the measuring instrument use RBW=1 MHz and VBW=3 MHz with Peak Detector for Peak Values, and use RBW=1 MHz and VBW=10 Hz with Peak Detector for Average Values.
- (7) For the actual test configuration, please see the test setup photo.

5.4 EUT Operating Condition

The Equipment Under Test was set to Continual Transmitting in maximum power.

5.5 Test Data

Remark: During testing above 1GHz the measuring instrument use RBW=1 MHz and VBW=3 MHz with Peak Detector for Peak Values, and use RBW=1 MHz and VBW=10 Hz with Peak Detector for Average Values.

Please refer to the Attachment B.

6. Restricted Bands Requirement

6.1 Test Standard and Limit

6.1.1 Test Standard

FCC Part 15.247(d)

FCC Part 15.209

FCC Part 15.205

6.1.2 Test Limit

| Restricted Frequency Band (MHz) | Distance of 3m (dBuV/m) | |
|---------------------------------|-------------------------|---------|
| | Peak | Average |
| 2310 ~2390 | 74 | 54 |
| 2483.5 ~2500 | 74 | 54 |

6.2 Test Setup

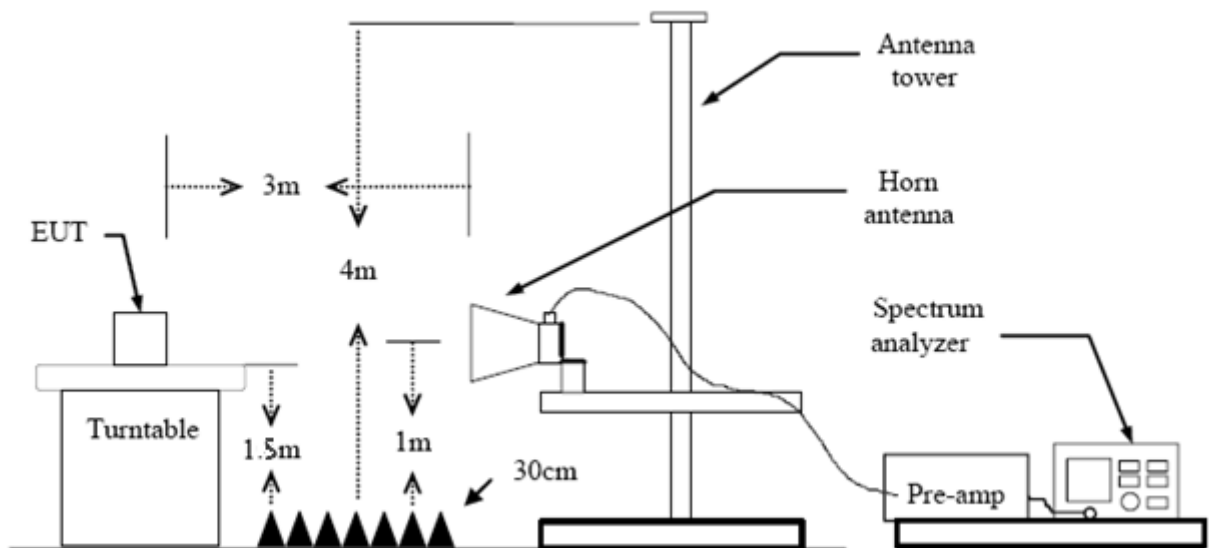

6.3 Test Procedure

- (1) The measuring distance of 3m shall be used for measurements at frequency below 1GHz and above 1 GHz. The EUT was placed on a rotating 0.8m high above ground, the table was rotated 360 degrees to determine the position of the highest radiation.
- (2) Measurements at frequency above 1GHz. The EUT was placed on a rotating 1.5m high above the ground. RF absorbers covered the ground plane with a minimum area of 3.0m by 3.0m between the EUT and measurement receiver antenna. The RF absorber shall not exceed 30cm in high above the conducting floor. The table was rotated 360 degrees to determine the position of the highest radiation.

- (3) The Test antenna shall vary between 1m and 4m, Both Horizontal and Vertical antenna are set to make measurement.
- (4) The initial step in collecting conducted emission data is a spectrum analyzer peak detector mode pre-scanning the measurement frequency range. Significant peaks are then marked and then Quasi Peak detector mode re-measured.
- (5) If the Peak Mode measured value compliance with and lower than Quasi Peak Mode Limit Bellow 1 GHz, the EUT shall be deemed to meet QP Limits and then no additional QP Mode measurement performed. But the Peak Value and average value both need to comply with applicable limit above 1 GHz.
- (6) Testing frequency range below 1GHz the measuring instrument use VBW=120 kHz with Quasi-peak detection.
- (7) Testing frequency range above 1GHz the measuring instrument use RBW=1 MHz and VBW=3 MHz with Peak Detector for Peak Values, and use RBW=1 MHz and VBW=10 Hz with Peak Detector for Average Values.
- (8) For the actual test configuration, please see the test setup photo.

6.4 EUT Operating Condition

The Equipment Under Test was set to Continual Transmitting in maximum power.

6.5 Test Data

Please refer to the Attachment C.

7. Bandwidth Test

7.1 Test Standard and Limit

7.1.1 Test Standard

FCC Part 15.247 (a)(2)

7.1.2 Test Limit

| FCC Part 15 Subpart C(15.247)/RSS-210 | | |
|---------------------------------------|-----------------------------------|----------------------|
| Test Item | Limit | Frequency Range(MHz) |
| Bandwidth | ≥ 500 KHz (6dB bandwidth) | 2400~2483.5 |

7.2 Test Setup

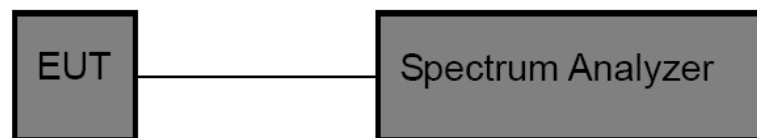

7.3 Test Procedure

- (1) The EUT was directly connected to the spectrum analyzer and antenna output port as show in the block diagram above.
- (2) The bandwidth is measured at an amplitude level reduced 6dB from the reference level. The reference level is the level of the highest amplitude signal observed from the transmitter at the fundamental frequency. Once the reference level is established, the equipment is conditioned with typical modulating signal to produce the worst -case (i.e the widest) bandwidth.
- (3) Measure the channel separation the spectrum analyzer was set to Resolution Bandwidth:100 kHz, and Video Bandwidth:300 kHz, Detector: Peak, Sweep Time set auto.

7.4 EUT Operating Condition

The EUT was set to continuously transmitting in each mode and low, Digital photo framesdle and high channel for the test.

7.5 Test Data

Please refer to the Attachment D.

8. Peak Output Power Test

8.1 Test Standard and Limit

8.1.1 Test Standard

FCC Part 15.247 (b)

8.1.2 Test Limit

| FCC Part 15 Subpart C(15.247)/RSS-210 | | |
|---------------------------------------|------------------|----------------------|
| Test Item | Limit | Frequency Range(MHz) |
| Peak Output Power | 1 Watt or 30 dBm | 2400~2483.5 |

8.2 Test Setup

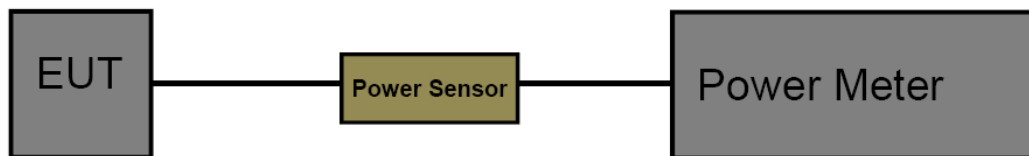

8.3 Test Procedure

The measurement is according to section 9.1.2 of KDB 558074 D01 DTS Meas Guidance v04. The EUT was connected to RF power meter via a broadband power sensor as show the block above. The power sensor video bandwidth is greater than or equal to the DTS bandwidth of the equipment.

8.4 EUT Operating Condition

The EUT was set to continuously transmitting in the max power during the test.

8.5 Test Data

Please refer to the Attachment E.

9. Power Spectral Density Test

9.1 Test Standard and Limit

9.1.1 Test Standard

FCC Part 15.247 (e)

9.1.2 Test Limit

| FCC Part 15 Subpart C(15.247) | | |
|-------------------------------|--------------------|----------------------|
| Test Item | Limit | Frequency Range(MHz) |
| Power Spectral Density | 8dBm(in any 3 kHz) | 2400~2483.5 |

9.2 Test Setup

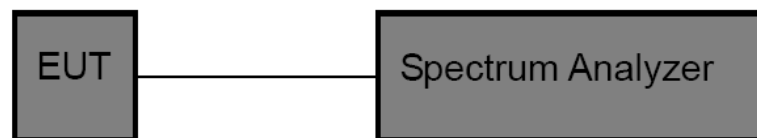

9.3 Test Procedure

The EUT was directly connected to the Spectrum Analyzer and antenna output port as show in the block diagram above. The measurement according to section 10.2 of KDB 558074 D01 DTS Meas Guidance v04.

- (1) The EUT was directly connected to the spectrum analyzer and antenna output port as show in the block diagram above.
- (2) Set analyser center frequency to DTS channel center frequency.
- (3) Set the span to 1.5 times the DTS bandwidth.
- (4) Set the RBW to: 3 kHz
- (5) Set the VBW to: 10 kHz
- (6) Detector: peak
- (7) Sweep time: auto
- (8) Allow trace to fully stabilize. Then use the peak marker function to determine the maximum amplitude level.

9.4 EUT Operating Condition

The EUT was set to continuously transmitting in each mode and low, Digital photo framesdle and high channel for the test.

9.5 Test Data

Please refer to the Attachment F.

10. Antenna Requirement

10.1 Standard Requirement

10.1.1 Standard

FCC Part 15.203

10.1.2 Requirement

An intentional radiator shall be designed to ensure that no antenna other than that furnished by the responsible party shall be used with the device. The use of a permanently attached antenna or of an antenna that uses a unique coupling to the intentional radiator shall be considered sufficient to comply with the provisions of this Section. The manufacturer may design the unit so that a broken antenna can be replaced by the user, but the use of a standard antenna jack or electrical connector is prohibited.

10.2 Antenna Connected Construction

The gains of the antenna used for transmitting is 2dBi, and the antenna de-signed with permanent attachment and no consideration of replacement. Please see the EUT photo for details.

Result

The EUT antenna is a Ceramics Antenna. It complies with the standard requirement.

| Antenna Type |
|--|
| <input checked="" type="checkbox"/> Permanent attached antenna |
| <input type="checkbox"/> Unique connector antenna |
| <input type="checkbox"/> Professional installation antenna |

Attachment A-- Conducted Emission Test Data

| | | | |
|---------------|-----------------------------|--------------------|-----|
| Temperature: | 25 °C | Relative Humidity: | 55% |
| Test Voltage: | AC 120V/60 Hz | | |
| Terminal: | Line | | |
| Test Mode: | Charging with TX B Mode | | |
| Remark: | Only worse case is reported | | |

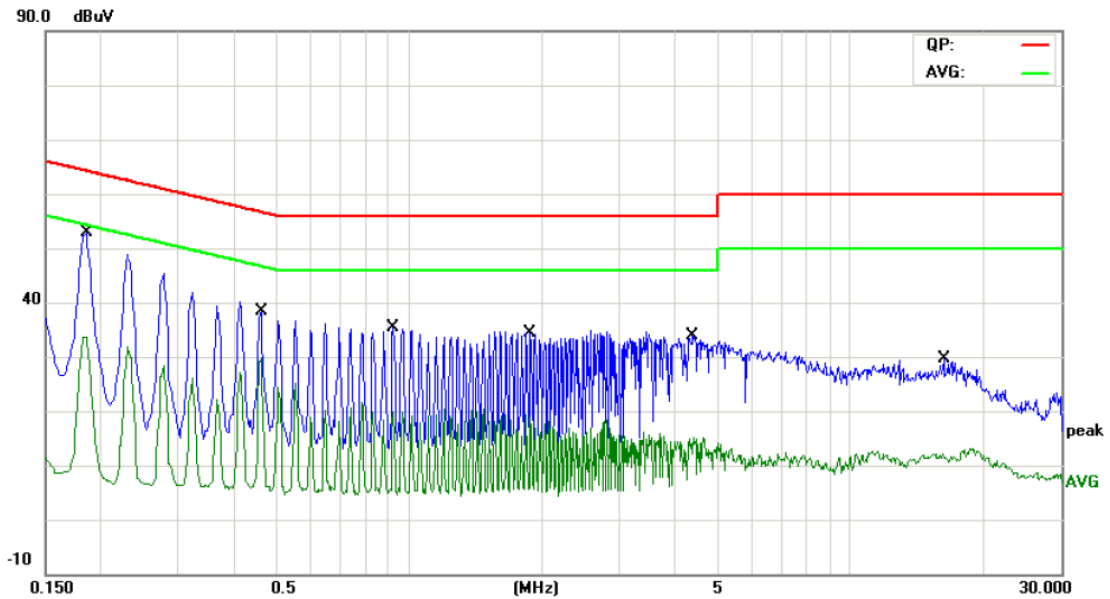

| No. | Mk. | Freq. MHz | Reading Level dBuV | Correct Factor dB | Measure- ment dBuV | Limit dBuV | Over dB | Detector |
|-----|-----|--------------|--------------------------|-------------------------|--------------------------|---------------|------------|----------|
| 1 | * | 0.1860 | 39.30 | 9.58 | 48.88 | 64.21 | -15.33 | QP |
| 2 | | 0.1860 | 22.71 | 9.58 | 32.29 | 54.21 | -21.92 | AVG |
| 3 | | 0.4620 | 23.72 | 9.60 | 33.32 | 56.66 | -23.34 | QP |
| 4 | | 0.4620 | 18.30 | 9.60 | 27.90 | 46.66 | -18.76 | AVG |
| 5 | | 0.9220 | 22.30 | 9.60 | 31.90 | 56.00 | -24.10 | QP |
| 6 | | 0.9220 | 6.55 | 9.60 | 16.15 | 46.00 | -29.85 | AVG |
| 7 | | 1.8860 | 19.60 | 9.61 | 29.21 | 56.00 | -26.79 | QP |
| 8 | | 1.8860 | 6.02 | 9.61 | 15.63 | 46.00 | -30.37 | AVG |
| 9 | | 4.4100 | 16.90 | 9.70 | 26.60 | 56.00 | -29.40 | QP |
| 10 | | 4.4100 | 3.07 | 9.70 | 12.77 | 46.00 | -33.23 | AVG |
| 11 | | 16.2540 | 13.14 | 10.48 | 23.62 | 60.00 | -36.38 | QP |
| 12 | | 16.2540 | 0.31 | 10.48 | 10.79 | 50.00 | -39.21 | AVG |

Emission Level= Read Level+ Correct Factor

| | | | |
|----------------------|-----------------------------|---------------------------|-----|
| Temperature: | 25 °C | Relative Humidity: | 55% |
| Test Voltage: | AC 120V/60 Hz | | |
| Terminal: | Neutral | | |
| Test Mode: | Charging with TX B Mode | | |
| Remark: | Only worse case is reported | | |

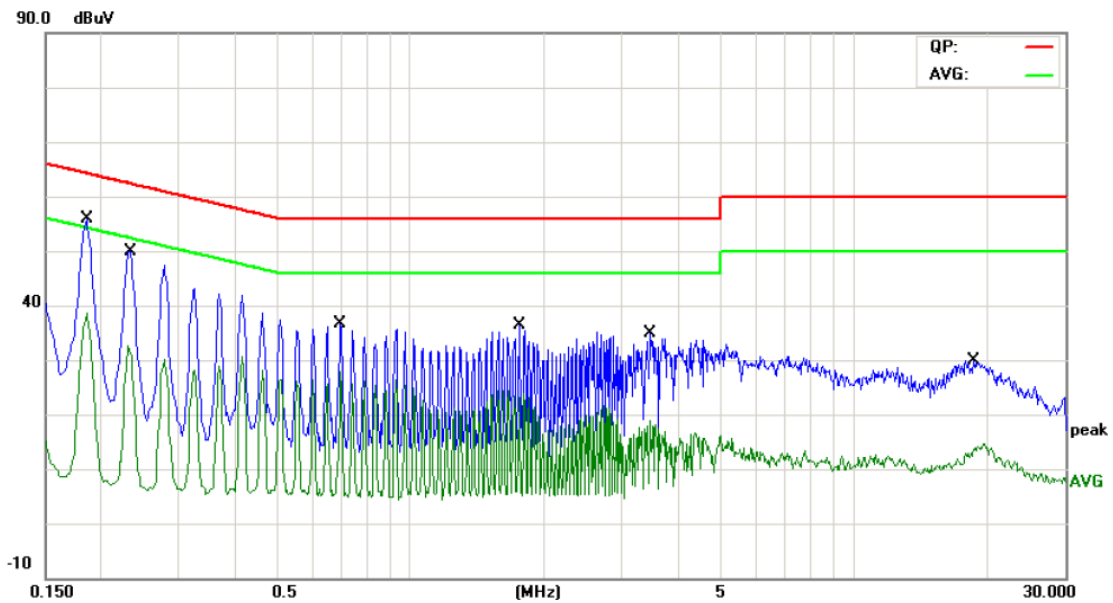

| No. | Mk. | Freq. MHz | Reading Level dBuV | Correct Factor dB | Measure- ment dBuV | Limit dBuV | Over dB | Detector |
|-----|-----|--------------|--------------------------|-------------------------|--------------------------|---------------|------------|----------|
| 1 | * | 0.1860 | 41.51 | 9.65 | 51.16 | 64.21 | -13.05 | QP |
| 2 | | 0.1860 | 25.78 | 9.65 | 35.43 | 54.21 | -18.78 | AVG |
| 3 | | 0.2340 | 33.97 | 9.62 | 43.59 | 62.30 | -18.71 | QP |
| 4 | | 0.2340 | 18.77 | 9.62 | 28.39 | 52.30 | -23.91 | AVG |
| 5 | | 0.6940 | 22.76 | 9.59 | 32.35 | 56.00 | -23.65 | QP |
| 6 | | 0.6940 | 14.79 | 9.59 | 24.38 | 46.00 | -21.62 | AVG |
| 7 | | 1.7580 | 18.68 | 9.61 | 28.29 | 56.00 | -27.71 | QP |
| 8 | | 1.7580 | 4.34 | 9.61 | 13.95 | 46.00 | -32.05 | AVG |
| 9 | | 3.4740 | 1.77 | 9.69 | 11.46 | 56.00 | -44.54 | QP |
| 10 | | 3.4740 | -4.61 | 9.69 | 5.08 | 46.00 | -40.92 | AVG |
| 11 | | 18.6980 | 13.98 | 10.64 | 24.62 | 60.00 | -35.38 | QP |
| 12 | | 18.6980 | 1.95 | 10.64 | 12.59 | 50.00 | -37.41 | AVG |

Emission Level= Read Level+ Correct Factor

| | | | |
|----------------------|-----------------------------|---------------------------|-----|
| Temperature: | 25 °C | Relative Humidity: | 55% |
| Test Voltage: | AC 240V/60 Hz | | |
| Terminal: | Line | | |
| Test Mode: | Charging with TX B Mode | | |
| Remark: | Only worse case is reported | | |

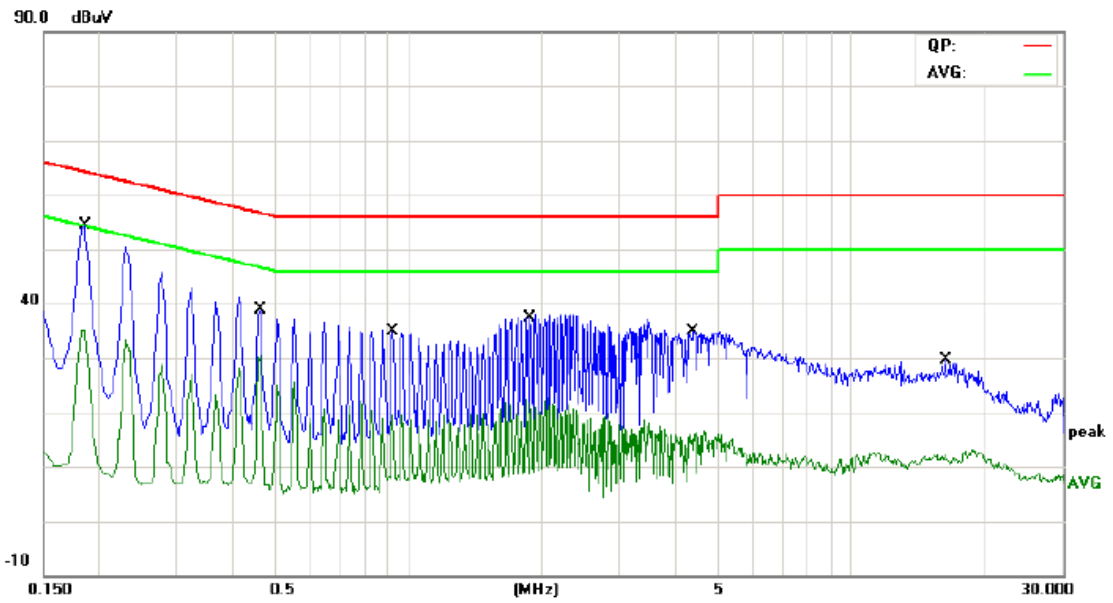

| No. | Mk. | Freq. MHz | Reading Level dBuV | Correct Factor dB | Measure- ment dBuV | Limit dBuV | Over dB | Detector |
|-----|-----|--------------|--------------------------|-------------------------|--------------------------|---------------|------------|----------|
| 1 | * | 0.1859 | 44.73 | 9.58 | 54.31 | 64.21 | -9.90 | QP |
| 2 | | 0.1860 | 22.71 | 9.58 | 32.29 | 54.21 | -21.92 | AVG |
| 3 | | 0.4620 | 29.28 | 9.60 | 38.88 | 56.66 | -17.78 | QP |
| 4 | | 0.4620 | 18.30 | 9.60 | 27.90 | 46.66 | -18.76 | AVG |
| 5 | | 0.9220 | 25.36 | 9.60 | 34.96 | 56.00 | -21.04 | QP |
| 6 | | 0.9220 | 6.55 | 9.60 | 16.15 | 46.00 | -29.85 | AVG |
| 7 | | 1.8858 | 27.71 | 9.61 | 37.32 | 56.00 | -18.68 | QP |
| 8 | | 1.8860 | 6.02 | 9.61 | 15.63 | 46.00 | -30.37 | AVG |
| 9 | | 4.4058 | 25.08 | 9.70 | 34.78 | 56.00 | -21.22 | QP |
| 10 | | 4.4100 | 3.07 | 9.70 | 12.77 | 46.00 | -33.23 | AVG |
| 11 | | 16.2539 | 19.14 | 10.48 | 29.62 | 60.00 | -30.38 | QP |
| 12 | | 16.2540 | 0.31 | 10.48 | 10.79 | 50.00 | -39.21 | AVG |

Emission Level= Read Level+ Correct Factor

| | | | |
|----------------------|-----------------------------|---------------------------|-----|
| Temperature: | 25 °C | Relative Humidity: | 55% |
| Test Voltage: | AC 240V/60 Hz | | |
| Terminal: | Neutral | | |
| Test Mode: | Charging with TX B Mode | | |
| Remark: | Only worse case is reported | | |

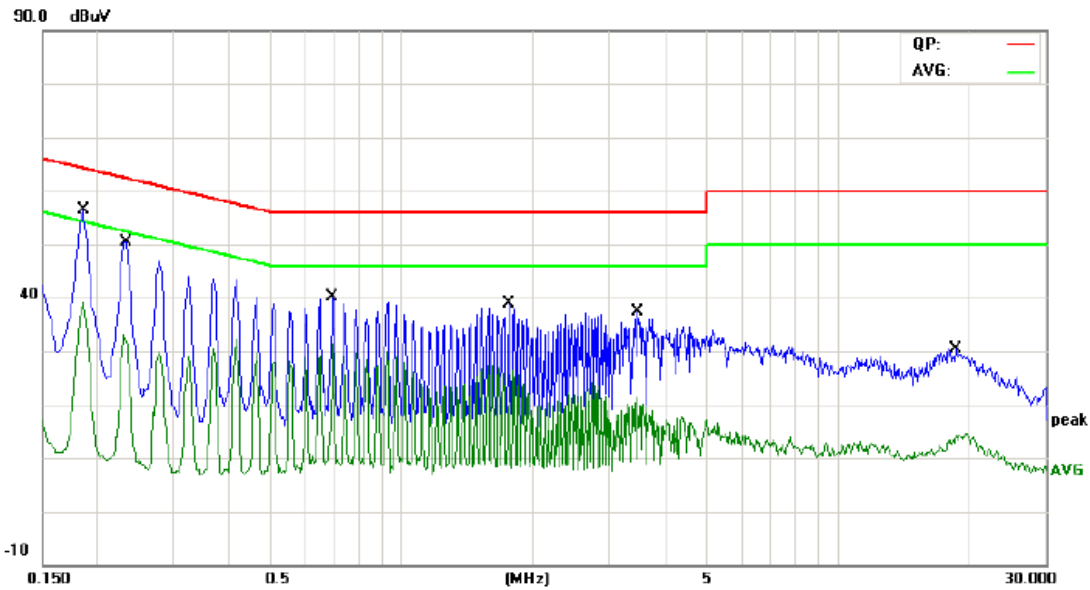

| No. | Mk. | Freq. MHz | Reading Level dBuV | Correct Factor dB | Measure- ment dBuV | Limit dBuV | Over dB | Detector |
|-----|-----|--------------|--------------------------|-------------------------|--------------------------|---------------|------------|----------|
| 1 | * | 0.1859 | 46.70 | 9.65 | 56.35 | 64.21 | -7.86 | QP |
| 2 | | 0.1860 | 25.78 | 9.65 | 35.43 | 54.21 | -18.78 | AVG |
| 3 | | 0.2340 | 40.79 | 9.62 | 50.41 | 62.30 | -11.89 | QP |
| 4 | | 0.2340 | 18.77 | 9.62 | 28.39 | 52.30 | -23.91 | AVG |
| 5 | | 0.6938 | 30.51 | 9.59 | 40.10 | 56.00 | -15.90 | QP |
| 6 | | 0.6940 | 14.79 | 9.59 | 24.38 | 46.00 | -21.62 | AVG |
| 7 | | 1.7580 | 29.16 | 9.60 | 38.76 | 56.00 | -17.24 | QP |
| 8 | | 1.7580 | 4.35 | 9.60 | 13.95 | 46.00 | -32.05 | AVG |
| 9 | | 3.4740 | 27.60 | 9.69 | 37.29 | 56.00 | -18.71 | QP |
| 10 | | 3.4740 | -4.61 | 9.69 | 5.08 | 46.00 | -40.92 | AVG |
| 11 | | 18.6980 | 1.95 | 10.64 | 12.59 | 50.00 | -37.41 | AVG |

Emission Level= Read Level+ Correct Factor

Attachment B-- Radiated Emission Test Data

9KHz~30MHz

From 9KHz to 30MHz: Conclusion: PASS

Note: The amplitude of spurious emissions which are attenuated by more than 20dB below the permissible value has no need to be reported.

30MHz~1GHz

| | | | |
|---------------|-----------------------------|--------------------|-----|
| Temperature: | 25 °C | Relative Humidity: | 55% |
| Test Voltage: | AC 120V/60 Hz | | |
| Ant. Pol. | Horizontal | | |
| Test Mode: | TX B Mode 2412MHz | | |
| Remark: | Only worse case is reported | | |

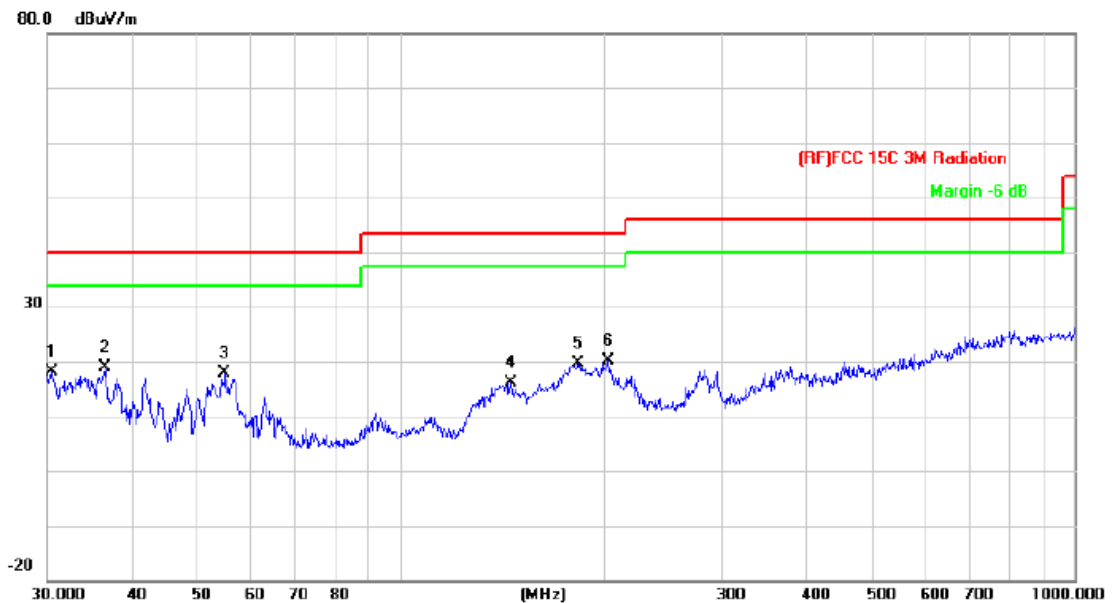

| No. | Mk. | Freq. MHz | Reading Level dBuV | Correct Factor dB/m | Measure- ment dBuV/m | Limit dBuV/m | Over dB | Detector |
|-----|-----|--------------|--------------------------|---------------------------|----------------------------|-----------------|------------|----------|
| 1 | | 30.4238 | 31.96 | -13.74 | 18.22 | 40.00 | -21.78 | QP |
| 2 | * | 36.6375 | 36.54 | -17.54 | 19.00 | 40.00 | -21.00 | QP |
| 3 | | 55.0274 | 41.74 | -23.86 | 17.88 | 40.00 | -22.12 | QP |
| 4 | | 145.8611 | 36.99 | -20.86 | 16.13 | 43.50 | -27.37 | QP |
| 5 | | 183.8440 | 39.60 | -19.85 | 19.75 | 43.50 | -23.75 | QP |
| 6 | | 203.5228 | 39.43 | -19.29 | 20.14 | 43.50 | -23.36 | QP |

*:Maximum data x:Over limit !:over margin

Emission Level= Read Level+ Correct Factor

| | | | |
|----------------------|-----------------------------|---------------------------|-----|
| Temperature: | 25 °C | Relative Humidity: | 55% |
| Test Voltage: | AC 120V/60 Hz | | |
| Ant. Pol. | Vertical | | |
| Test Mode: | TX B Mode 2412MHz | | |
| Remark: | Only worse case is reported | | |

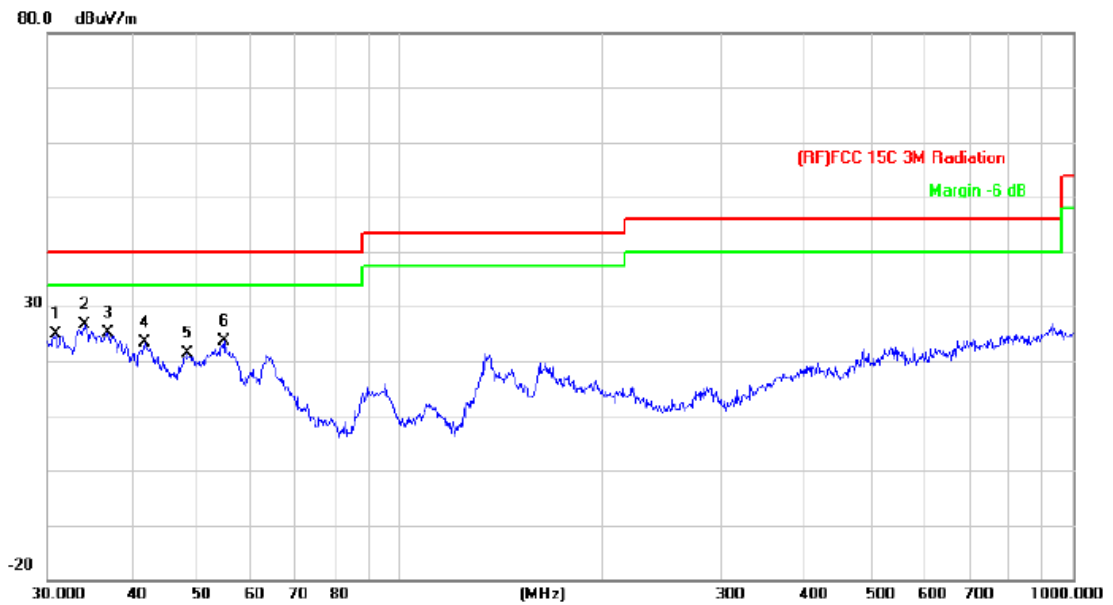

| No. | Mk. | Freq. MHz | Reading Level dBuV | Correct Factor dB/m | Measure- ment dBuV/m | Limit dBuV/m | Over dB | Detector |
|-----|-----|--------------|--------------------------|---------------------------|----------------------------|-----------------|------------|----------|
| 1 | | 30.8535 | 38.78 | -13.99 | 24.79 | 40.00 | -15.21 | QP |
| 2 | * | 34.1561 | 42.57 | -16.02 | 26.55 | 40.00 | -13.45 | QP |
| 3 | | 36.8953 | 42.93 | -17.70 | 25.23 | 40.00 | -14.77 | QP |
| 4 | | 41.8596 | 43.67 | -20.39 | 23.28 | 40.00 | -16.72 | QP |
| 5 | | 48.5016 | 44.51 | -23.16 | 21.35 | 40.00 | -18.65 | QP |
| 6 | | 55.0274 | 47.44 | -23.86 | 23.58 | 40.00 | -16.42 | QP |

*:Maximum data x:Over limit !:over margin

Emission Level= Read Level+ Correct Factor

Above 1GHz

| | | | |
|----------------------|--|---------------------------|-----|
| Temperature: | 25 °C | Relative Humidity: | 55% |
| Test Voltage: | DC 3.7V | | |
| Ant. Pol. | Horizontal | | |
| Test Mode: | TX B Mode 2412MHz | | |
| Remark: | No report for the emission which more than 10 dB below the prescribed limit. | | |

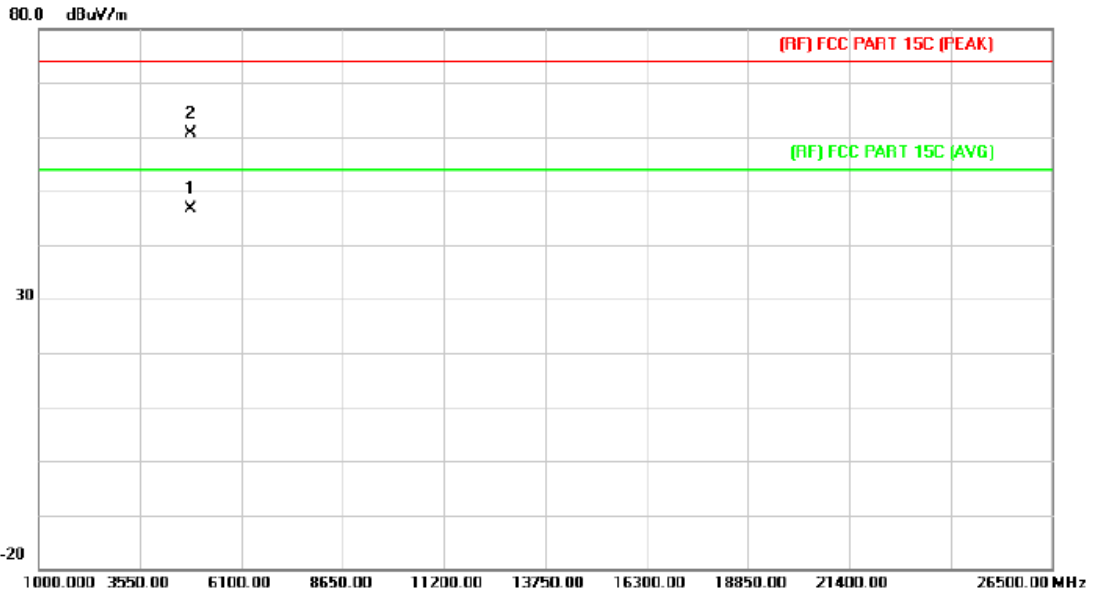

| No. | Mk. | Freq. | Reading Level | Correct Factor | Measurement | Limit | Over | Detector |
|-----|-----|----------|---------------|----------------|-------------|--------|--------|----------|
| | | MHz | dBuV | dB/m | dBuV/m | dBuV/m | dB | |
| 1 | * | 4823.948 | 31.96 | 14.55 | 46.51 | 54.00 | -7.49 | AVG |
| 2 | | 4824.872 | 46.14 | 14.55 | 60.69 | 74.00 | -13.31 | peak |

Emission Level= Read Level+ Correct Factor

| | | | |
|----------------------|--|---------------------------|-----|
| Temperature: | 25 °C | Relative Humidity: | 55% |
| Test Voltage: | DC 3.7V | | |
| Ant. Pol. | Vertical | | |
| Test Mode: | TX B Mode 2412MHz | | |
| Remark: | No report for the emission which more than 10 dB below the prescribed limit. | | |

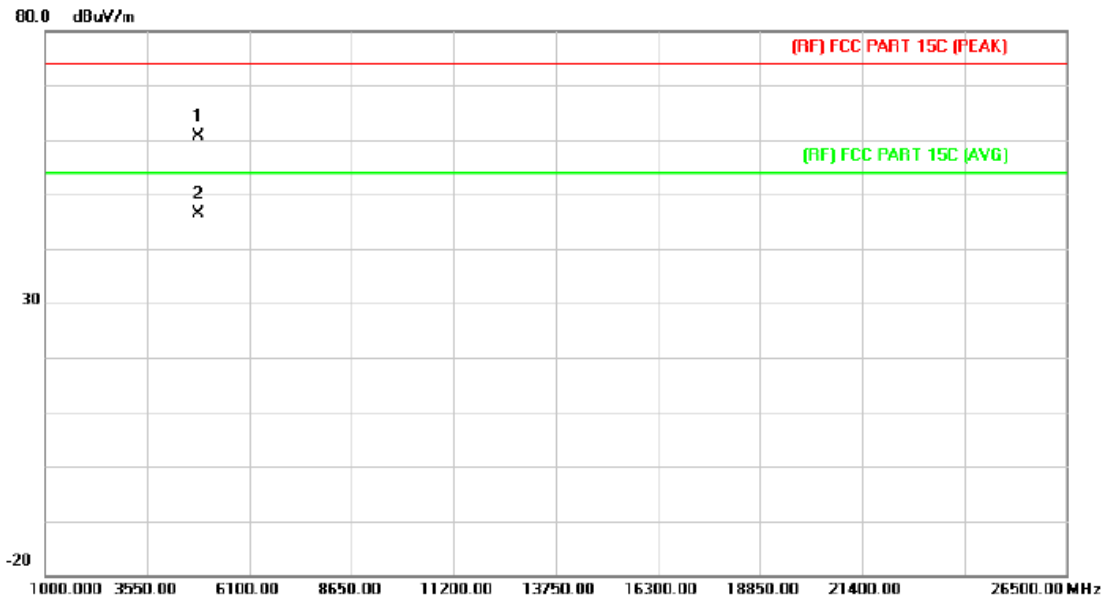

| No. | Mk. | Freq. MHz | Reading Level dBuV | Correct Factor dB/m | Measure- ment dBuV/m | Limit dBuV/m | Over dB | Detector |
|-----|-----|--------------|--------------------------|---------------------------|----------------------------|-----------------|------------|----------|
| 1 | | 4824.268 | 46.11 | 14.55 | 60.66 | 74.00 | -13.34 | peak |
| 2 | * | 4823.844 | 31.82 | 14.55 | 46.37 | 54.00 | -7.63 | AVG |

Emission Level= Read Level+ Correct Factor

| | | | |
|----------------------|--|---------------------------|-----|
| Temperature: | 25 °C | Relative Humidity: | 55% |
| Test Voltage: | DC 3.7V | | |
| Ant. Pol. | Horizontal | | |
| Test Mode: | TX B Mode 2437MHz | | |
| Remark: | No report for the emission which more than 10 dB below the prescribed limit. | | |

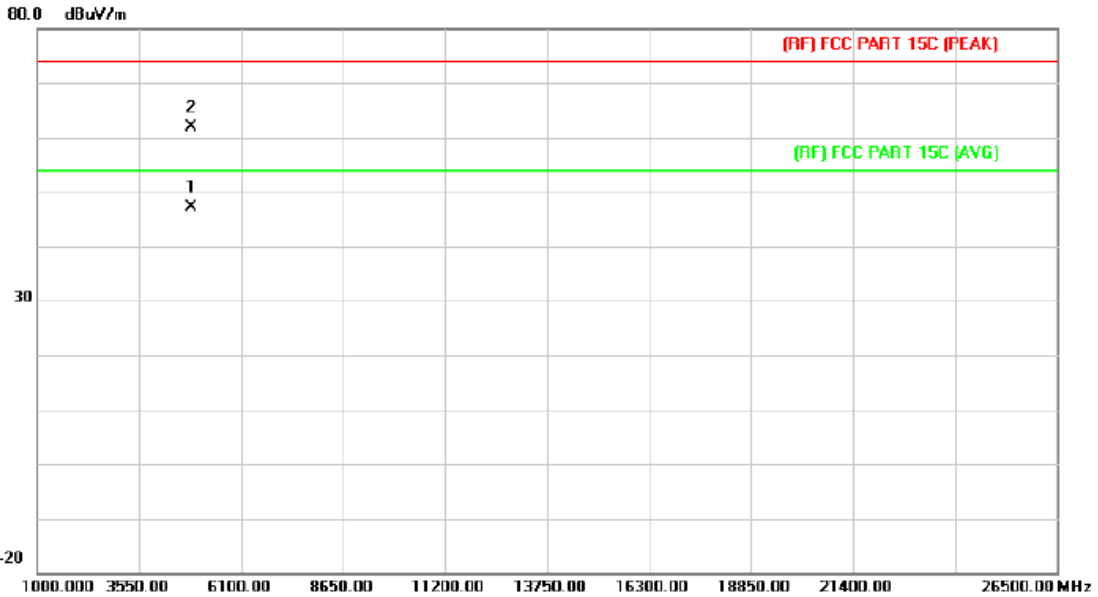

| No. | Mk. | Freq. MHz | Reading Level dBuV | Correct Factor dB/m | Measure- ment dBuV/m | Limit dBuV/m | Over dB | Detector |
|-----|-----|--------------|--------------------------|---------------------------|----------------------------|-----------------|------------|----------|
| 1 | * | 4873.840 | 32.32 | 14.86 | 47.18 | 54.00 | -6.82 | AVG |
| 2 | | 4874.952 | 47.06 | 14.86 | 61.92 | 74.00 | -12.08 | peak |

Emission Level= Read Level+ Correct Factor

| | | | |
|----------------------|--|---------------------------|-----|
| Temperature: | 25 °C | Relative Humidity: | 55% |
| Test Voltage: | DC 3.7V | | |
| Ant. Pol. | Vertical | | |
| Test Mode: | TX B Mode 2437MHz | | |
| Remark: | No report for the emission which more than 10 dB below the prescribed limit. | | |

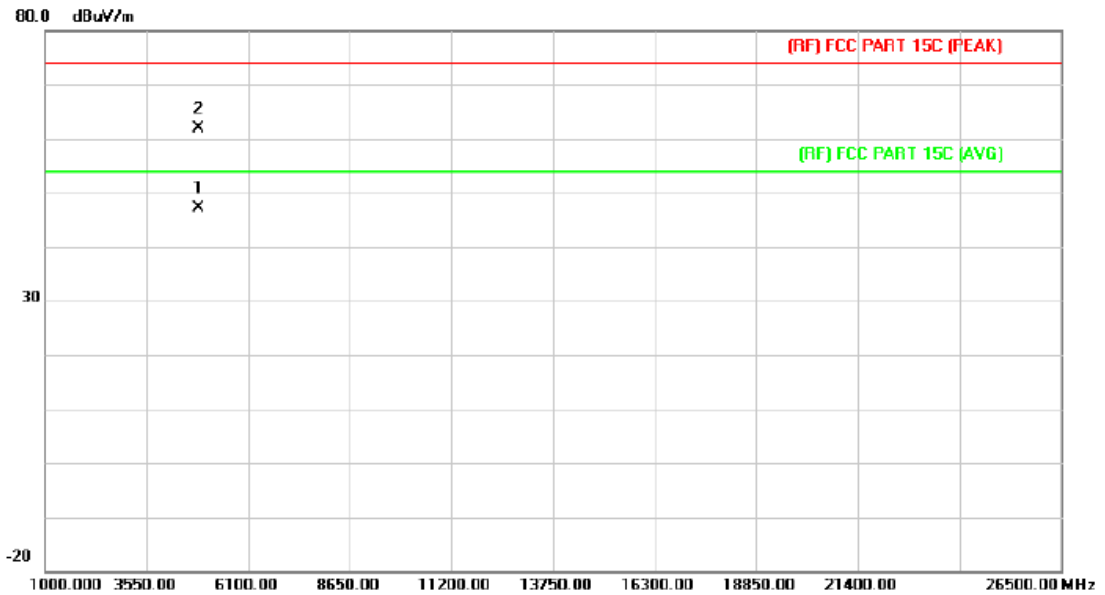

| No. | Mk. | Freq. MHz | Reading Level dBuV | Correct Factor dB/m | Measure- ment dBuV/m | Limit dBuV/m | Over dB | Detector |
|-----|-----|--------------|--------------------------|---------------------------|----------------------------|-----------------|------------|----------|
| 1 | * | 4874.892 | 32.20 | 14.86 | 47.06 | 54.00 | -6.94 | AVG |
| 2 | | 4874.768 | 46.97 | 14.86 | 61.83 | 74.00 | -12.17 | peak |

Emission Level= Read Level+ Correct Factor

| | | | |
|----------------------|--|---------------------------|-----|
| Temperature: | 25 °C | Relative Humidity: | 55% |
| Test Voltage: | DC 3.7V | | |
| Ant. Pol. | Horizontal | | |
| Test Mode: | TX B Mode 2462MHz | | |
| Remark: | No report for the emission which more than 10 dB below the prescribed limit. | | |

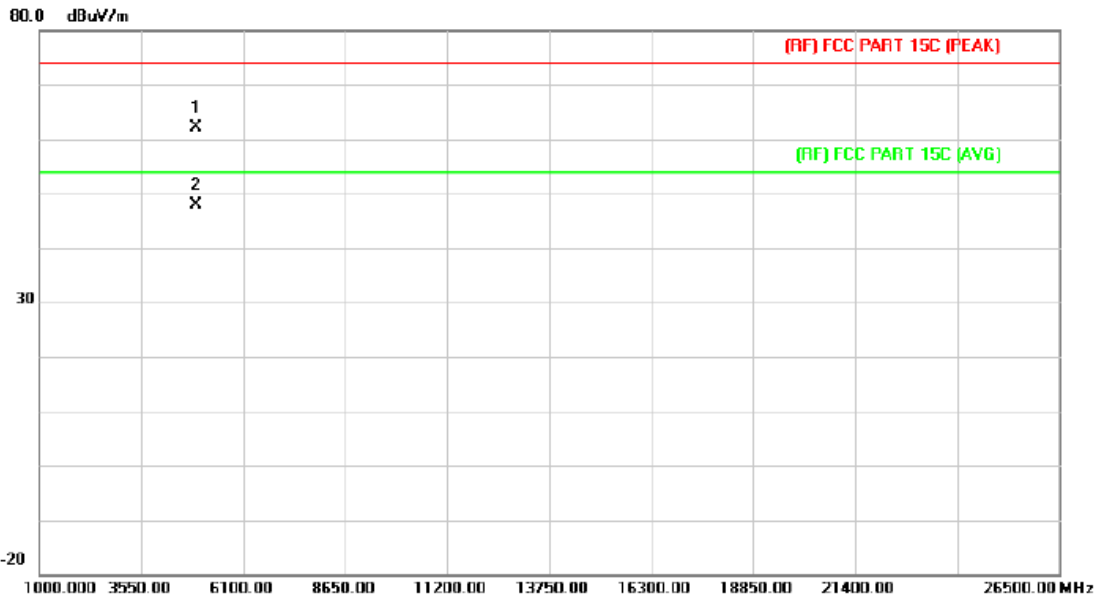

| No. | Mk. | Freq. | Reading Level | Correct Factor | Measurement | Limit | Over | Detector |
|-----|-----|----------|---------------|----------------|-------------|--------|--------|----------|
| | | MHz | dBuV | dB/m | dBuV/m | dBuV/m | dB | |
| 1 | | 4924.136 | 47.08 | 15.17 | 62.25 | 74.00 | -11.75 | peak |
| 2 | * | 4925.000 | 32.66 | 15.18 | 47.84 | 54.00 | -6.16 | AVG |

Emission Level= Read Level+ Correct Factor

| | | | |
|----------------------|--|---------------------------|-----|
| Temperature: | 25 °C | Relative Humidity: | 55% |
| Test Voltage: | DC 3.7V | | |
| Ant. Pol. | Vertical | | |
| Test Mode: | TX B Mode 2462MHz | | |
| Remark: | No report for the emission which more than 10 dB below the prescribed limit. | | |

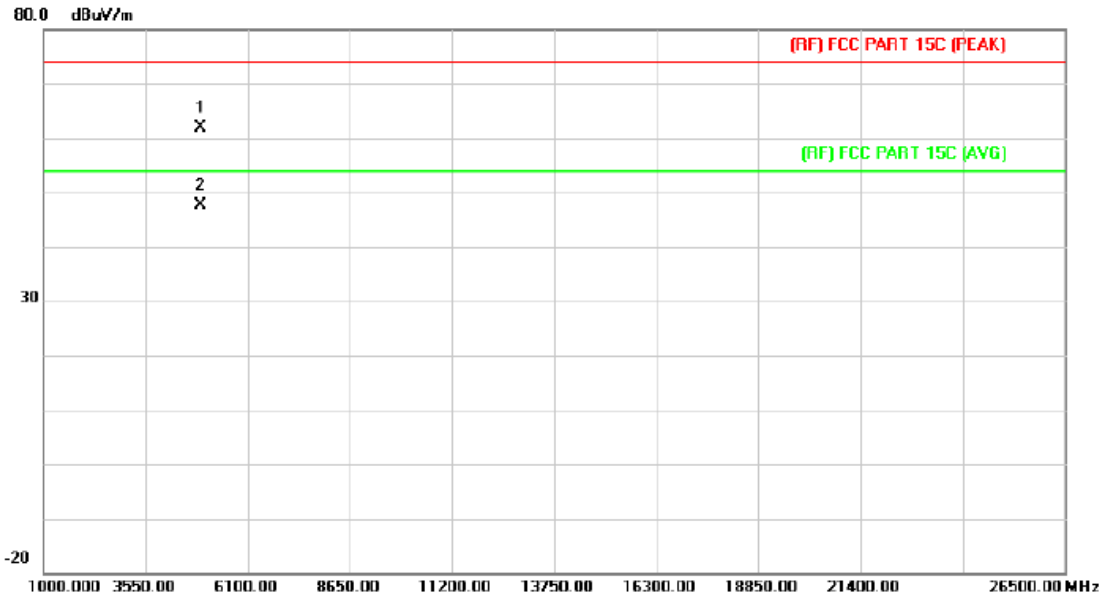

| No. | Mk. | Freq. MHz | Reading Level dBuV | Correct Factor dB/m | Measure- ment dBuV/m | Limit dBuV/m | Over dB | Detector |
|-----|-----|--------------|--------------------------|---------------------------|----------------------------|-----------------|------------|----------|
| 1 | | 4923.440 | 46.82 | 15.17 | 61.99 | 74.00 | -12.01 | peak |
| 2 | * | 4924.368 | 32.46 | 15.17 | 47.63 | 54.00 | -6.37 | AVG |

Emission Level= Read Level+ Correct Factor

| | | | |
|----------------------|--|---------------------------|-----|
| Temperature: | 25 °C | Relative Humidity: | 55% |
| Test Voltage: | DC 3.7V | | |
| Ant. Pol. | Horizontal | | |
| Test Mode: | TX G Mode 2412MHz | | |
| Remark: | No report for the emission which more than 10 dB below the prescribed limit. | | |

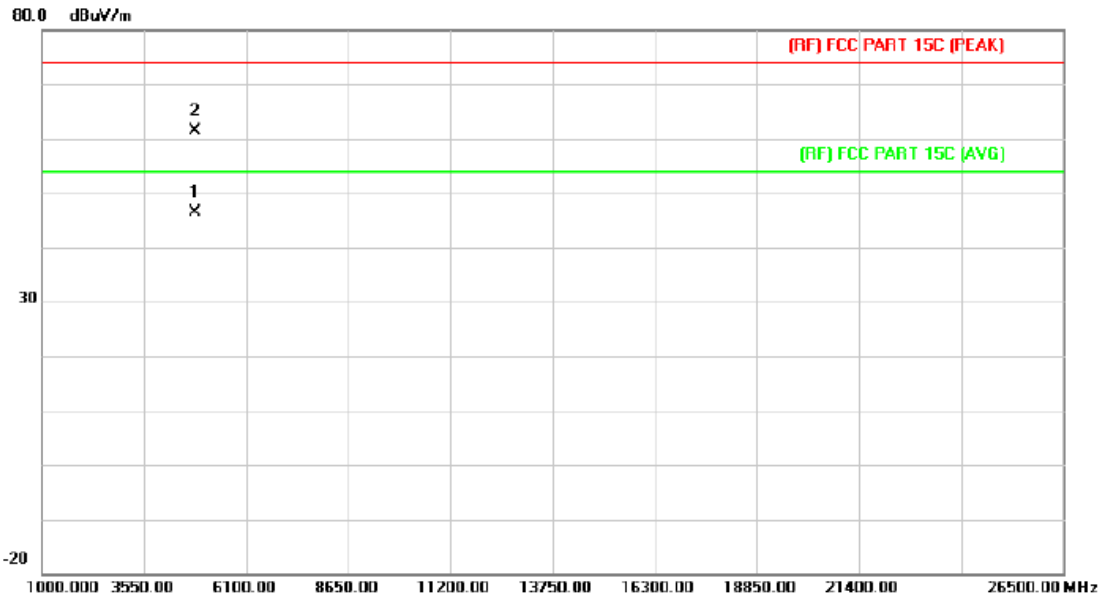

| No. | Mk. | Freq. MHz | Reading Level dBuV | Correct Factor dB/m | Measure- ment dBuV/m | Limit dBuV/m | Over dB | Detector |
|-----|-----|--------------|--------------------------|---------------------------|----------------------------|-----------------|------------|----------|
| 1 | * | 4823.840 | 31.95 | 14.55 | 46.50 | 54.00 | -7.50 | AVG |
| 2 | | 4824.352 | 46.71 | 14.55 | 61.26 | 74.00 | -12.74 | peak |

Emission Level= Read Level+ Correct Factor

| | | | |
|----------------------|--|---------------------------|-----|
| Temperature: | 25 °C | Relative Humidity: | 55% |
| Test Voltage: | DC 3.7V | | |
| Ant. Pol. | Vertical | | |
| Test Mode: | TX G Mode 2412MHz | | |
| Remark: | No report for the emission which more than 10 dB below the prescribed limit. | | |

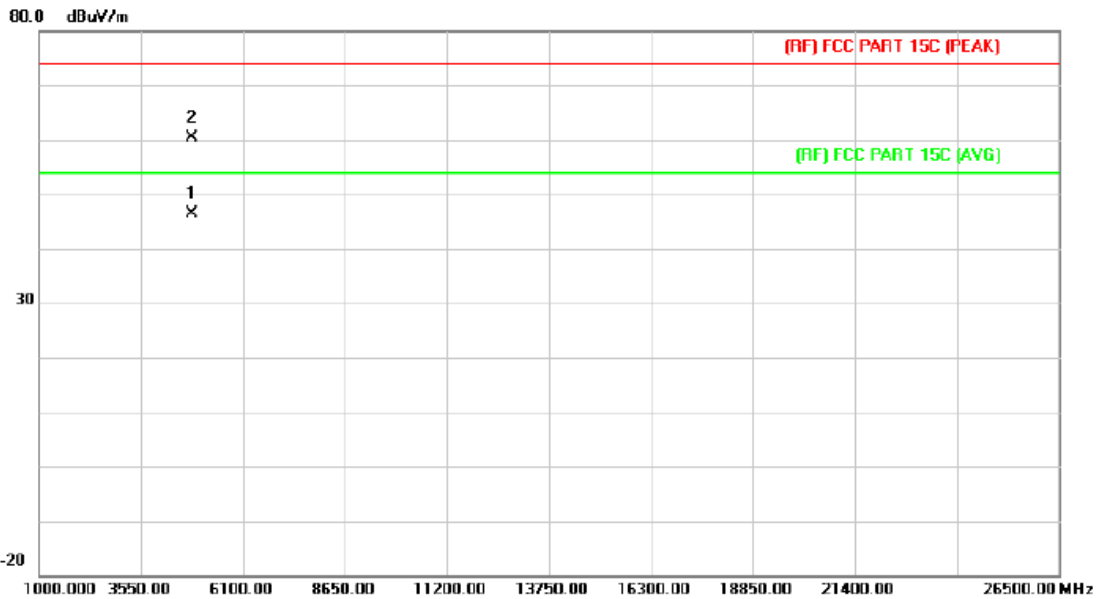

| No. | Mk. | Freq. | Reading Level | Correct Factor | Measurement | Limit | Over | Detector |
|-----|-----|----------|---------------|----------------|-------------|--------|--------|----------|
| | | MHz | dBuV | dB/m | dBuV/m | dBuV/m | dB | |
| 1 | * | 4823.104 | 31.81 | 14.55 | 46.36 | 54.00 | -7.64 | AVG |
| 2 | | 4824.700 | 45.80 | 14.55 | 60.35 | 74.00 | -13.65 | peak |

Emission Level= Read Level+ Correct Factor

| | | | |
|----------------------|--|---------------------------|-----|
| Temperature: | 25 °C | Relative Humidity: | 55% |
| Test Voltage: | DC 3.7V | | |
| Ant. Pol. | Horizontal | | |
| Test Mode: | TX G Mode 2437MHz | | |
| Remark: | No report for the emission which more than 10 dB below the prescribed limit. | | |

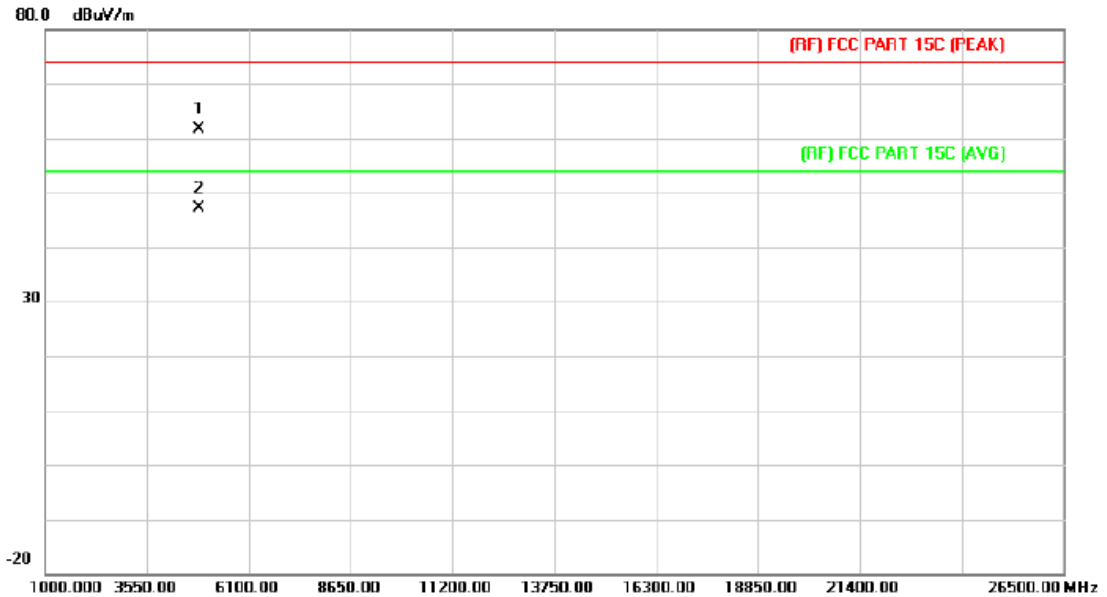

| No. | Mk. | Freq. MHz | Reading Level dBuV | Correct Factor dB/m | Measure- ment dBuV/m | Limit dBuV/m | Over dB | Detector |
|-----|-----|--------------|--------------------------|---------------------------|----------------------------|-----------------|------------|----------|
| 1 | | 4873.708 | 46.83 | 14.86 | 61.69 | 74.00 | -12.31 | peak |
| 2 | * | 4874.472 | 32.29 | 14.86 | 47.15 | 54.00 | -6.85 | AVG |

Emission Level= Read Level+ Correct Factor

| | | | |
|----------------------|--|---------------------------|-----|
| Temperature: | 25 °C | Relative Humidity: | 55% |
| Test Voltage: | DC 3.7V | | |
| Ant. Pol. | Vertical | | |
| Test Mode: | TX G Mode 2437MHz | | |
| Remark: | No report for the emission which more than 10 dB below the prescribed limit. | | |

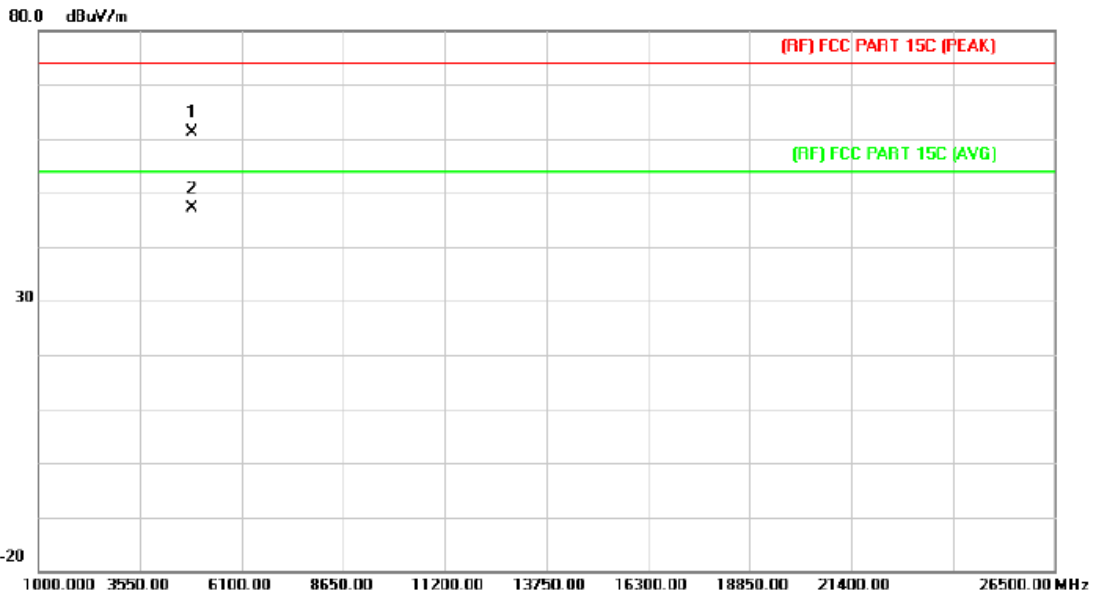

| No. | Mk. | Freq. MHz | Reading Level dBuV | Correct Factor dB/m | Measure- ment dBuV/m | Limit dBuV/m | Over dB | Detector |
|-----|-----|--------------|--------------------------|---------------------------|----------------------------|-----------------|------------|----------|
| 1 | | 4873.276 | 46.38 | 14.86 | 61.24 | 74.00 | -12.76 | peak |
| 2 | * | 4874.260 | 32.19 | 14.86 | 47.05 | 54.00 | -6.95 | AVG |

Emission Level= Read Level+ Correct Factor

| | | | |
|----------------------|--|---------------------------|-----|
| Temperature: | 25 °C | Relative Humidity: | 55% |
| Test Voltage: | DC 3.7V | | |
| Ant. Pol. | Horizontal | | |
| Test Mode: | TX G Mode 2462MHz | | |
| Remark: | No report for the emission which more than 10 dB below the prescribed limit. | | |

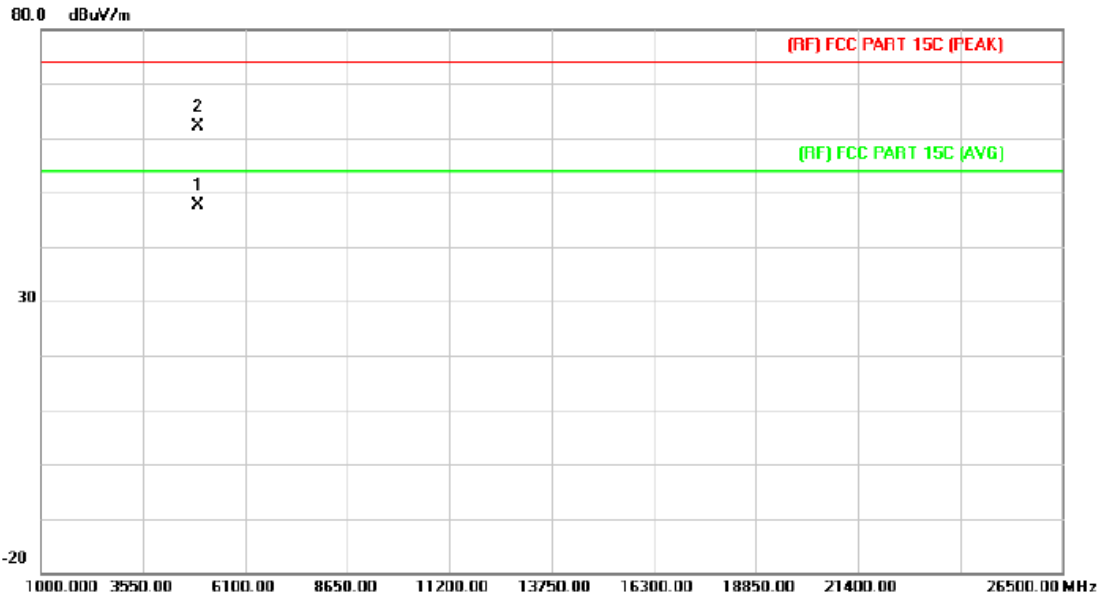

| No. | Mk. | Freq. | Reading Level | Correct Factor | Measurement | Limit | Over | Detector |
|-----|-----|----------|---------------|----------------|-------------|--------|--------|----------|
| | | MHz | dBuV | dB/m | dBuV/m | dBuV/m | dB | |
| 1 | * | 4925.000 | 32.54 | 15.18 | 47.72 | 54.00 | -6.28 | AVG |
| 2 | | 4923.452 | 47.02 | 15.17 | 62.19 | 74.00 | -11.81 | peak |

Emission Level= Read Level+ Correct Factor

| | | | |
|----------------------|--|---------------------------|-----|
| Temperature: | 25 °C | Relative Humidity: | 55% |
| Test Voltage: | DC 3.7V | | |
| Ant. Pol. | Vertical | | |
| Test Mode: | TX G Mode 2462MHz | | |
| Remark: | No report for the emission which more than 10 dB below the prescribed limit. | | |

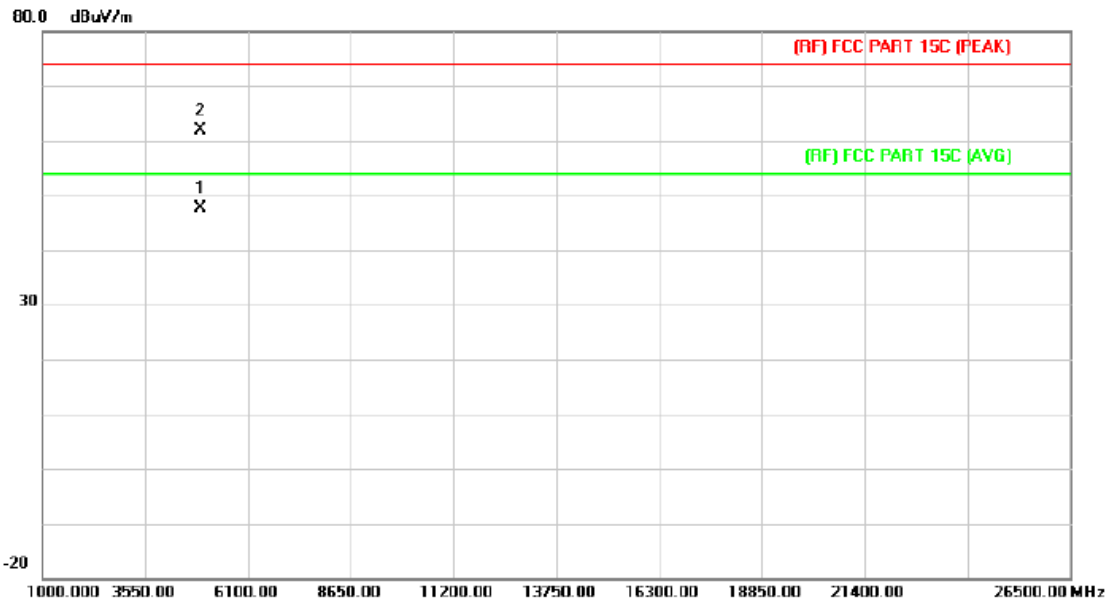

| No. | Mk. | Freq. | Reading Level | Correct Factor | Measurement | Limit | Over | Detector |
|-----|-----|----------|---------------|----------------|-------------|--------|--------|----------|
| | | MHz | dBuV | dB/m | dBuV/m | dBuV/m | dB | |
| 1 | * | 4924.156 | 32.43 | 15.17 | 47.60 | 54.00 | -6.40 | AVG |
| 2 | | 4923.400 | 46.82 | 15.17 | 61.99 | 74.00 | -12.01 | peak |

Emission Level= Read Level+ Correct Factor

| | | | |
|----------------------|--|---------------------------|-----|
| Temperature: | 25 °C | Relative Humidity: | 55% |
| Test Voltage: | DC 3.7V | | |
| Ant. Pol. | Horizontal | | |
| Test Mode: | TX N(HT20) Mode 2412MHz | | |
| Remark: | No report for the emission which more than 10 dB below the prescribed limit. | | |

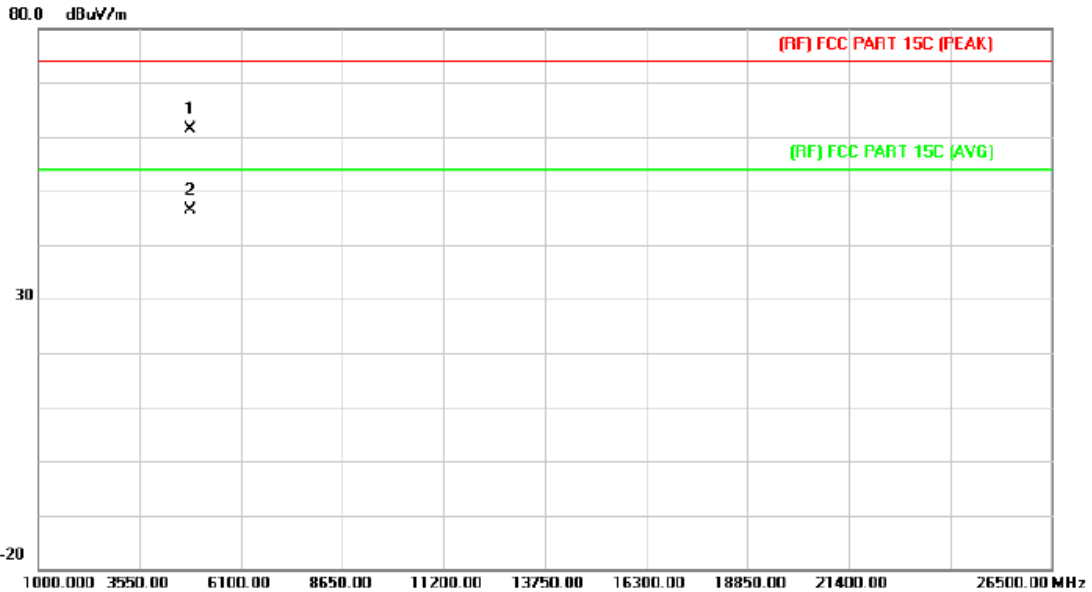

| No. | Mk. | Freq. MHz | Reading Level dBuV | Correct Factor dB/m | Measure- ment dBuV/m | Limit dBuV/m | Over dB | Detector |
|-----|-----|--------------|--------------------------|---------------------------|----------------------------|-----------------|------------|----------|
| 1 | | 4823.432 | 46.80 | 14.55 | 61.35 | 74.00 | -12.65 | peak |
| 2 | * | 4824.896 | 31.86 | 14.55 | 46.41 | 54.00 | -7.59 | AVG |

Emission Level= Read Level+ Correct Factor

| | | | |
|----------------------|--|---------------------------|-----|
| Temperature: | 25 °C | Relative Humidity: | 55% |
| Test Voltage: | DC 3.7V | | |
| Ant. Pol. | Vertical | | |
| Test Mode: | TX N(HT20) Mode 2412MHz | | |
| Remark: | No report for the emission which more than 10 dB below the prescribed limit. | | |

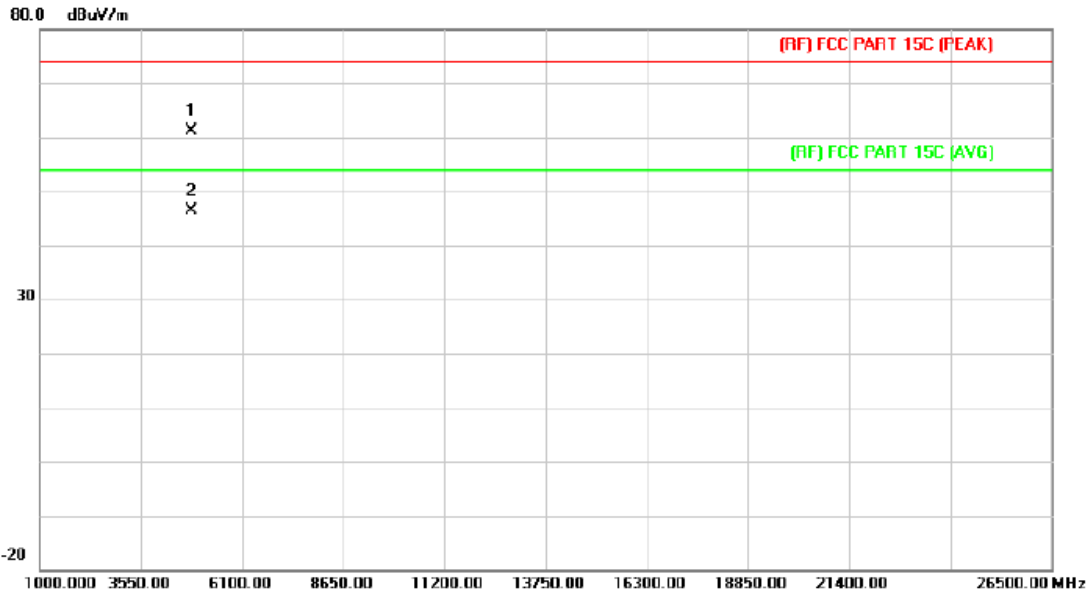

| No. | Mk. | Freq. | Reading Level | Correct Factor | Measurement | Limit | Over | Detector |
|-----|-----|----------|---------------|----------------|-------------|--------|--------|----------|
| | | MHz | dBuV | dB/m | dBuV/m | dBuV/m | dB | |
| 1 | | 4824.440 | 46.69 | 14.55 | 61.24 | 74.00 | -12.76 | peak |
| 2 | * | 4824.264 | 31.79 | 14.55 | 46.34 | 54.00 | -7.66 | AVG |

Emission Level= Read Level+ Correct Factor

| | | | |
|----------------------|--|---------------------------|-----|
| Temperature: | 25 °C | Relative Humidity: | 55% |
| Test Voltage: | DC 3.7V | | |
| Ant. Pol. | Horizontal | | |
| Test Mode: | TX N(HT20) Mode 2437MHz | | |
| Remark: | No report for the emission which more than 10 dB below the prescribed limit. | | |

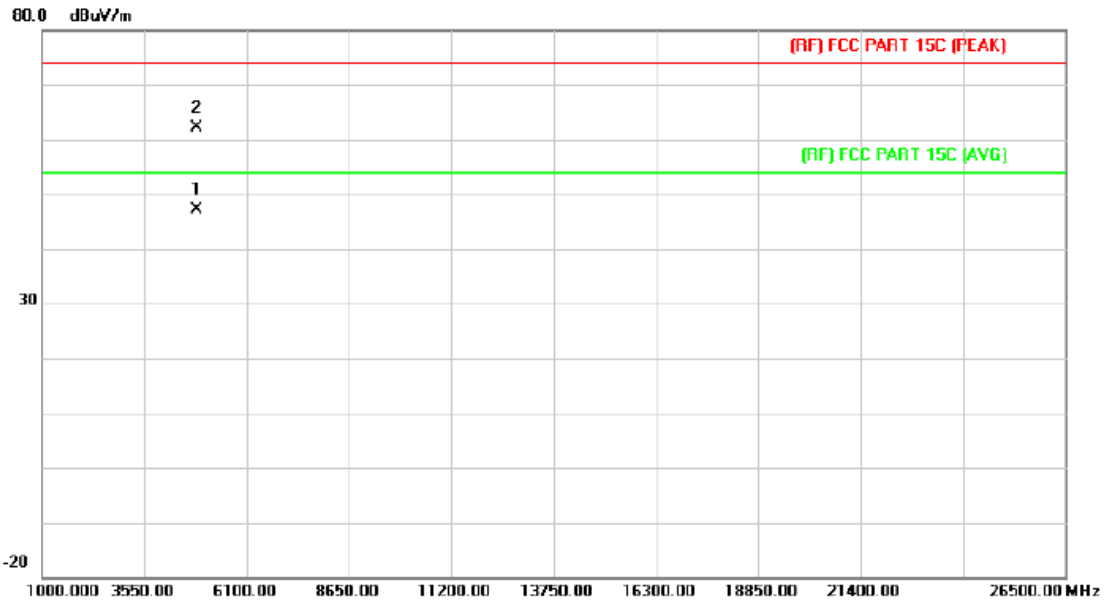

| No. | Mk. | Freq. MHz | Reading Level dBuV | Correct Factor dB/m | Measure- ment dBuV/m | Limit dBuV/m | Over dB | Detector |
|-----|-----|--------------|--------------------------|---------------------------|----------------------------|-----------------|------------|----------|
| 1 | * | 4874.052 | 32.25 | 14.86 | 47.11 | 54.00 | -6.89 | AVG |
| 2 | | 4874.548 | 47.21 | 14.86 | 62.07 | 74.00 | -11.93 | peak |

Emission Level= Read Level+ Correct Factor

| | | | |
|----------------------|--|---------------------------|-----|
| Temperature: | 25 °C | Relative Humidity: | 55% |
| Test Voltage: | DC 3.7V | | |
| Ant. Pol. | Vertical | | |
| Test Mode: | TX N(HT20) Mode 2437MHz | | |
| Remark: | No report for the emission which more than 10 dB below the prescribed limit. | | |

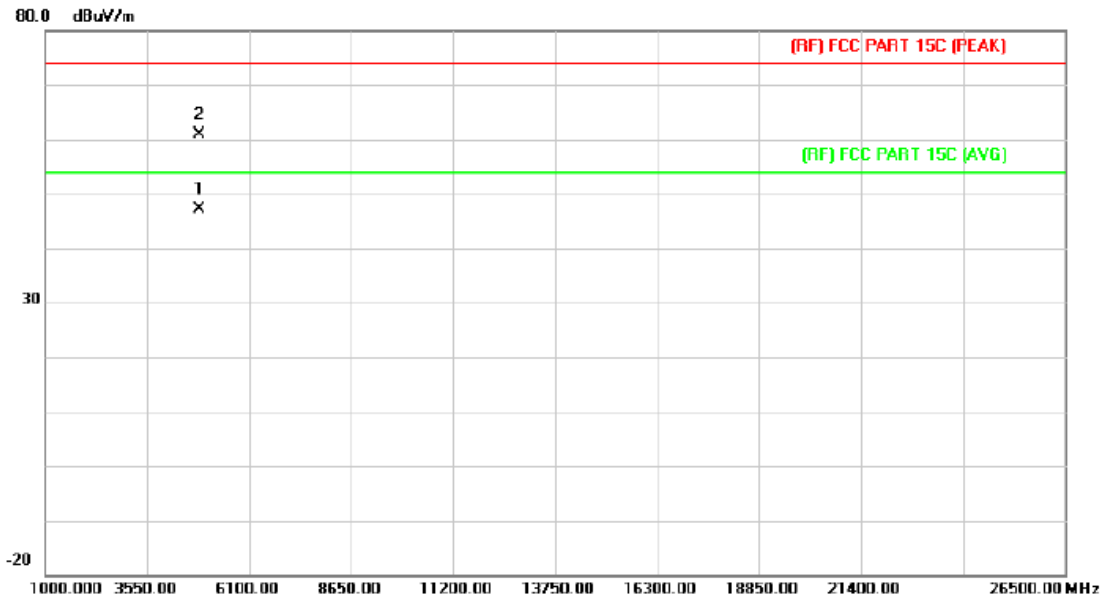

| No. | Mk. | Freq. MHz | Reading Level dBuV | Correct Factor dB/m | Measure- ment dBuV/m | Limit dBuV/m | Over dB | Detector |
|-----|-----|--------------|--------------------------|---------------------------|----------------------------|-----------------|------------|----------|
| 1 | * | 4873.948 | 32.18 | 14.86 | 47.04 | 54.00 | -6.96 | AVG |
| 2 | | 4874.044 | 46.10 | 14.86 | 60.96 | 74.00 | -13.04 | peak |

Emission Level= Read Level+ Correct Factor

| | | | |
|----------------------|--|---------------------------|-----|
| Temperature: | 25 °C | Relative Humidity: | 55% |
| Test Voltage: | DC 3.7V | | |
| Ant. Pol. | Horizontal | | |
| Test Mode: | TX N(HT20) Mode 2462MHz | | |
| Remark: | No report for the emission which more than 10 dB below the prescribed limit. | | |

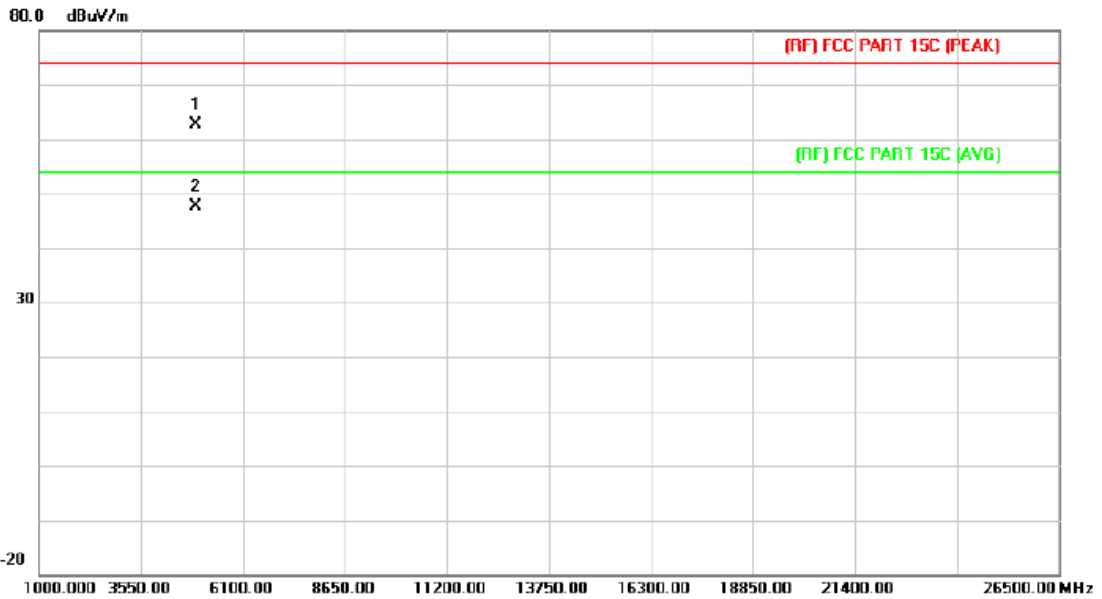

| No. | Mk. | Freq. MHz | Reading Level dBuV | Correct Factor dB/m | Measure- ment dBuV/m | Limit dBuV/m | Over dB | Detector |
|-----|-----|--------------|--------------------------|---------------------------|----------------------------|-----------------|------------|----------|
| 1 | | 4923.864 | 47.42 | 15.17 | 62.59 | 74.00 | -11.41 | peak |
| 2 | * | 4923.444 | 32.52 | 15.17 | 47.69 | 54.00 | -6.31 | AVG |

Emission Level= Read Level+ Correct Factor

| | | | |
|----------------------|--|---------------------------|-----|
| Temperature: | 25 °C | Relative Humidity: | 55% |
| Test Voltage: | DC 3.7V | | |
| Ant. Pol. | Vertical | | |
| Test Mode: | TX N(HT20) Mode 2462MHz | | |
| Remark: | No report for the emission which more than 10 dB below the prescribed limit. | | |

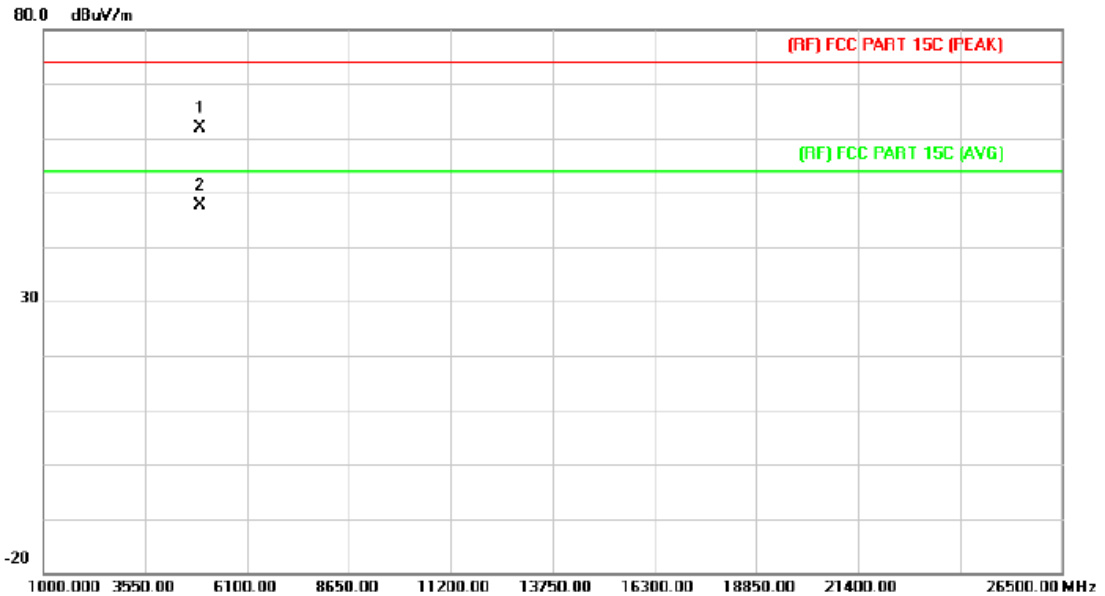

| No. | Mk. | Freq. | Reading Level | Correct Factor | Measurement | Limit | Over | |
|-----|-----|----------|---------------|----------------|-------------|--------|--------|----------|
| | | MHz | dBuV | dB/m | dBuV/m | dBuV/m | dB | Detector |
| 1 | | 4924.124 | 46.63 | 15.17 | 61.80 | 74.00 | -12.20 | peak |
| 2 | * | 4925.000 | 32.40 | 15.18 | 47.58 | 54.00 | -6.42 | AVG |

Emission Level= Read Level+ Correct Factor

| | | | |
|----------------------|--|---------------------------|-----|
| Temperature: | 25 °C | Relative Humidity: | 55% |
| Test Voltage: | DC 3.7V | | |
| Ant. Pol. | Horizontal | | |
| Test Mode: | TX N(HT40) Mode 2422MHz | | |
| Remark: | No report for the emission which more than 10 dB below the prescribed limit. | | |

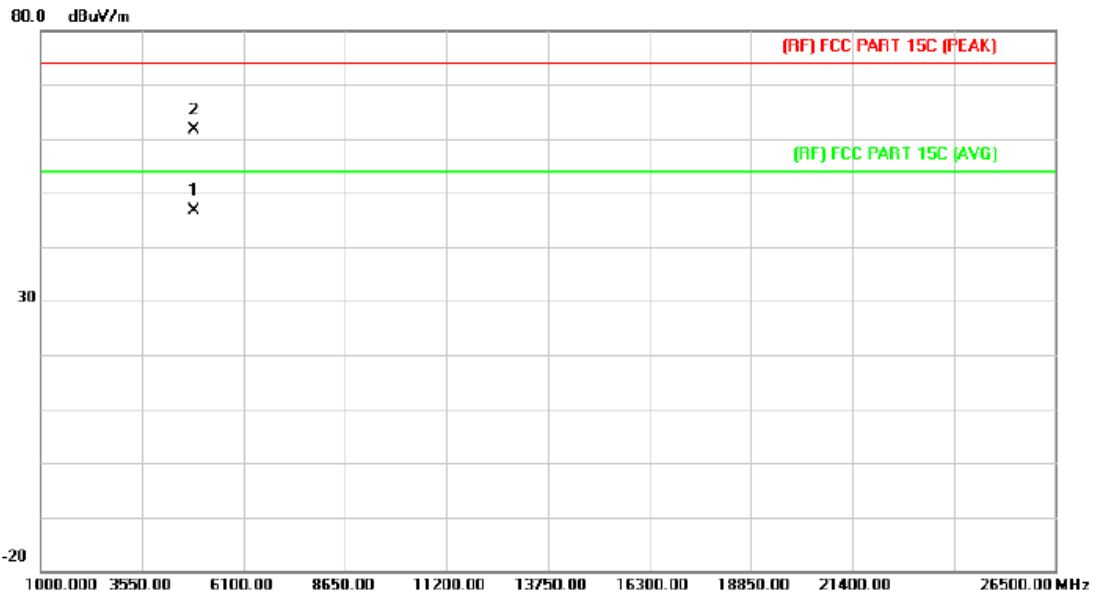

| No. | Mk. | Freq. | Reading Level | Correct Factor | Measurement | Limit | Over | Detector |
|-----|-----|----------|---------------|----------------|-------------|--------|--------|----------|
| | | MHz | dBuV | dB/m | dBuV/m | dBuV/m | dB | |
| 1 | * | 4844.684 | 32.01 | 14.68 | 46.69 | 54.00 | -7.31 | AVG |
| 2 | | 4843.640 | 47.01 | 14.67 | 61.68 | 74.00 | -12.32 | peak |

Emission Level= Read Level+ Correct Factor

| | | | |
|----------------------|--|---------------------------|-----|
| Temperature: | 25 °C | Relative Humidity: | 55% |
| Test Voltage: | DC 3.7V | | |
| Ant. Pol. | Vertical | | |
| Test Mode: | TX N(HT40) Mode 2422MHz | | |
| Remark: | No report for the emission which more than 10 dB below the prescribed limit. | | |

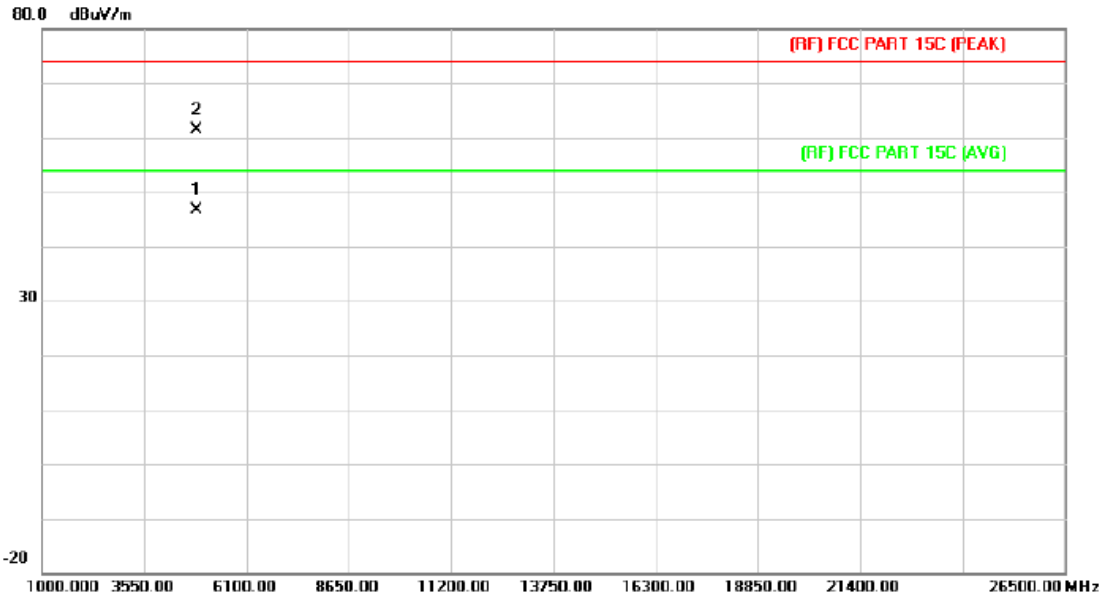

| No. | Mk. | Freq. MHz | Reading Level dBuV | Correct Factor dB/m | Measure- ment dBuV/m | Limit dBuV/m | Over dB | Detector |
|-----|-----|--------------|--------------------------|---------------------------|----------------------------|-----------------|------------|----------|
| 1 | * | 4845.000 | 31.94 | 14.68 | 46.62 | 54.00 | -7.38 | AVG |
| 2 | | 4844.800 | 46.61 | 14.68 | 61.29 | 74.00 | -12.71 | peak |

Emission Level= Read Level+ Correct Factor

| | | | |
|----------------------|--|---------------------------|-----|
| Temperature: | 25 °C | Relative Humidity: | 55% |
| Test Voltage: | DC 3.7V | | |
| Ant. Pol. | Horizontal | | |
| Test Mode: | TX N(HT40) Mode 2437MHz | | |
| Remark: | No report for the emission which more than 10 dB below the prescribed limit. | | |

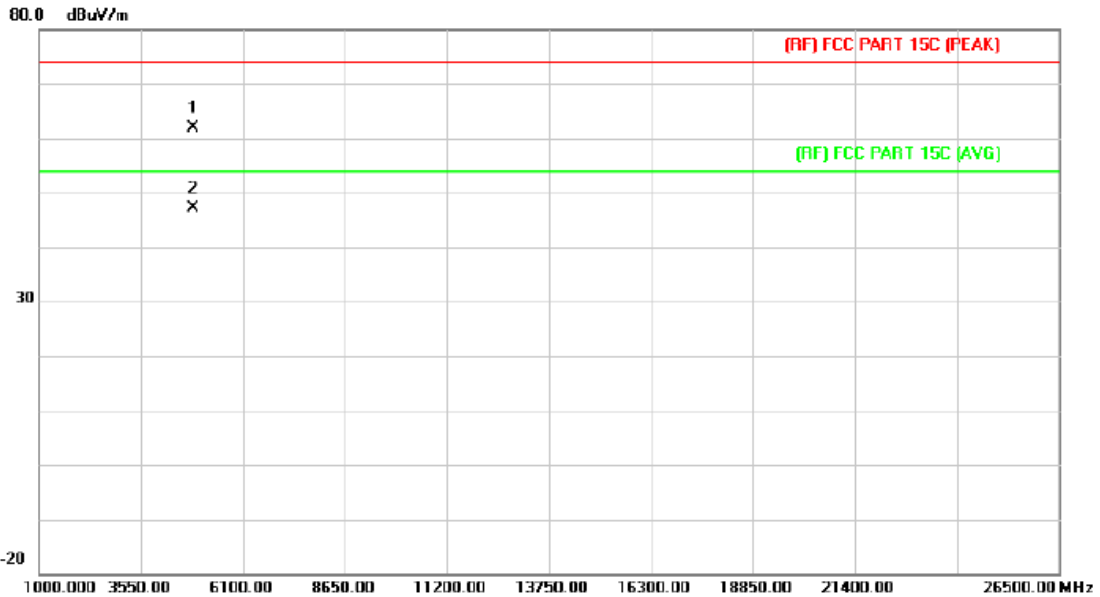

| No. | Mk. | Freq. | Reading Level | Correct Factor | Measurement | Limit | Over | Detector |
|-----|-----|----------|---------------|----------------|-------------|--------|--------|----------|
| | | MHz | dBuV | dB/m | dBuV/m | dBuV/m | dB | |
| 1 | | 4874.572 | 46.92 | 14.86 | 61.78 | 74.00 | -12.22 | peak |
| 2 | * | 4873.316 | 32.21 | 14.86 | 47.07 | 54.00 | -6.93 | AVG |

Emission Level= Read Level+ Correct Factor

| | | | |
|----------------------|--|---------------------------|-----|
| Temperature: | 25 °C | Relative Humidity: | 55% |
| Test Voltage: | DC 3.7V | | |
| Ant. Pol. | Vertical | | |
| Test Mode: | TX N(HT40) Mode 2437MHz | | |
| Remark: | No report for the emission which more than 10 dB below the prescribed limit. | | |

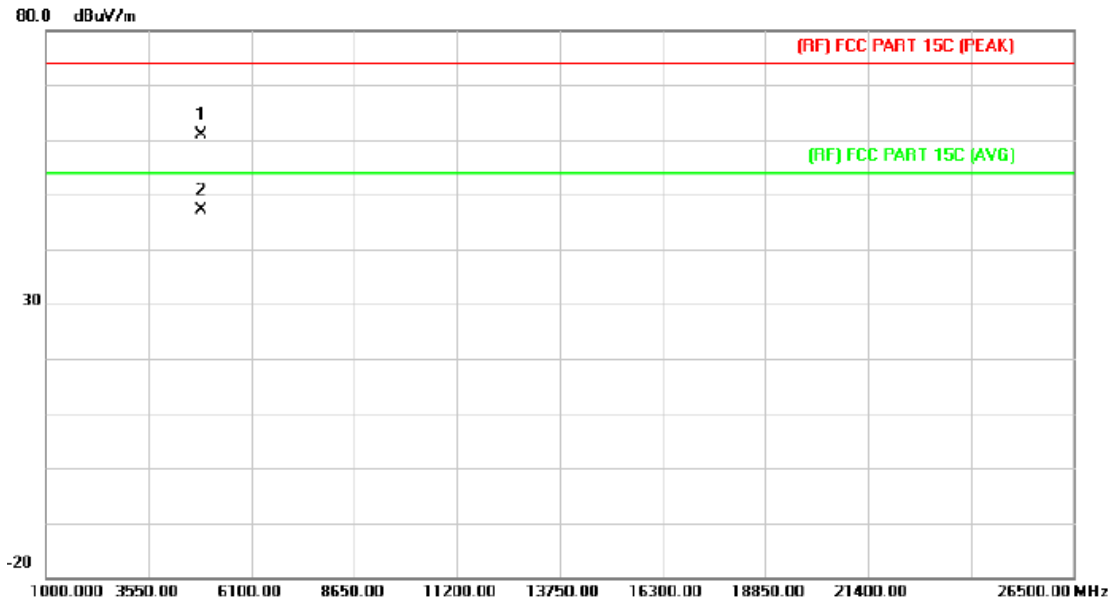

| No. | Mk. | Freq. MHz | Reading Level dBuV | Correct Factor dB/m | Measure- ment dBuV/m | Limit dBuV/m | Over dB | Detector |
|-----|-----|--------------|--------------------------|---------------------------|----------------------------|-----------------|------------|----------|
| 1 | | 4874.412 | 46.13 | 14.86 | 60.99 | 74.00 | -13.01 | peak |
| 2 | * | 4874.896 | 32.16 | 14.86 | 47.02 | 54.00 | -6.98 | AVG |

Emission Level= Read Level+ Correct Factor

| | | | |
|----------------------|--|---------------------------|-----|
| Temperature: | 25 °C | Relative Humidity: | 55% |
| Test Voltage: | DC 3.7V | | |
| Ant. Pol. | Horizontal | | |
| Test Mode: | TX N(HT40) Mode 2452MHz | | |
| Remark: | No report for the emission which more than 10 dB below the prescribed limit. | | |

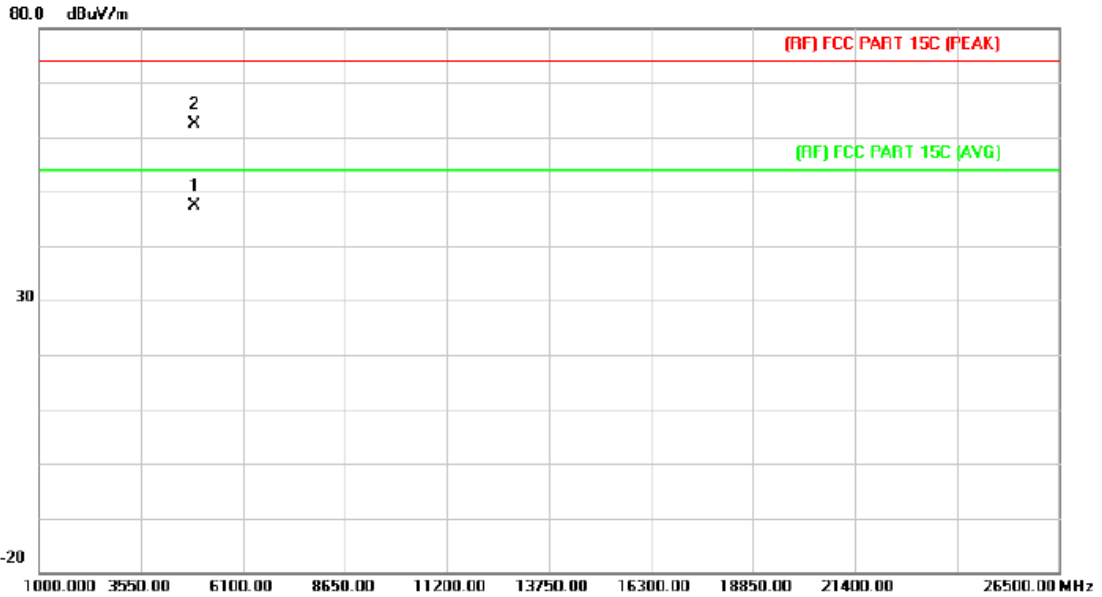

| No. | Mk. | Freq. MHz | Reading Level dBuV | Correct Factor dB/m | Measure- ment dBuV/m | Limit dBuV/m | Over dB | Detector |
|-----|-----|--------------|--------------------------|---------------------------|----------------------------|-----------------|------------|----------|
| 1 | * | 4904.368 | 32.44 | 15.04 | 47.48 | 54.00 | -6.52 | AVG |
| 2 | | 4904.152 | 47.38 | 15.04 | 62.42 | 74.00 | -11.58 | peak |

Emission Level= Read Level+ Correct Factor

| | | | |
|----------------------|--|---------------------------|-----|
| Temperature: | 25 °C | Relative Humidity: | 55% |
| Test Voltage: | DC 3.7V | | |
| Ant. Pol. | Vertical | | |
| Test Mode: | TX N(HT40) Mode 2452MHz | | |
| Remark: | No report for the emission which more than 10 dB below the prescribed limit. | | |

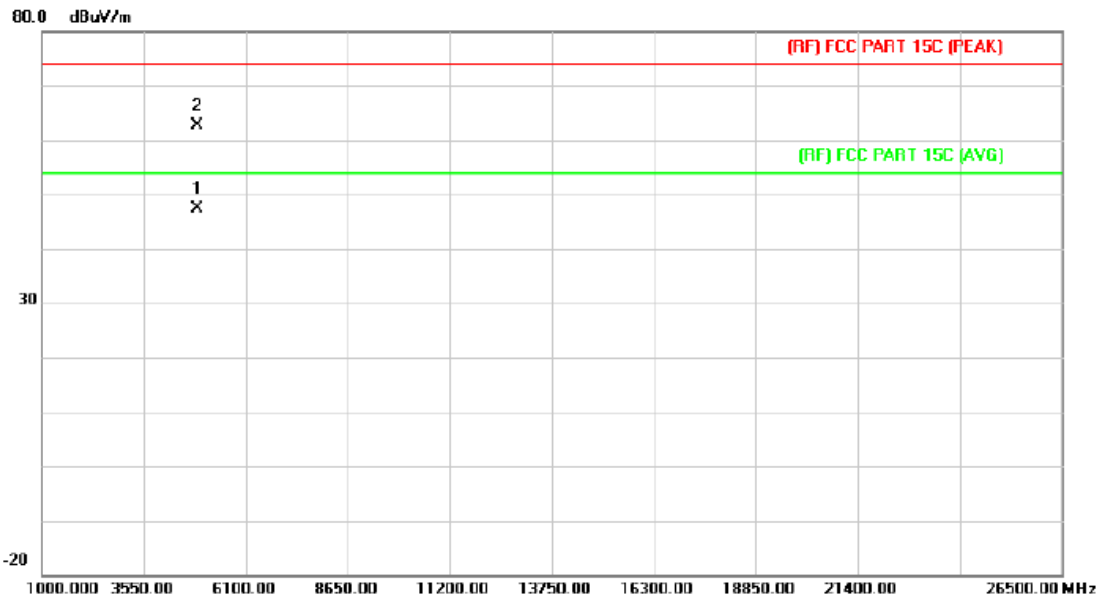

| No. | Mk. | Freq. MHz | Reading Level dBuV | Correct Factor dB/m | Measure- ment dBuV/m | Limit dBuV/m | Over dB | Detector |
|-----|-----|--------------|--------------------------|---------------------------|----------------------------|-----------------|------------|----------|
| 1 | * | 4904.896 | 32.36 | 15.05 | 47.41 | 54.00 | -6.59 | AVG |
| 2 | | 4903.684 | 47.49 | 15.04 | 62.53 | 74.00 | -11.47 | peak |

Emission Level= Read Level+ Correct Factor

Attachment C-- Restricted Bands Requirement Test Data

(1) Radiation Test

| | | | |
|---------------|-------------------|--------------------|-----|
| Temperature: | 25 °C | Relative Humidity: | 55% |
| Test Voltage: | DC 3.7V | | |
| Ant. Pol. | Horizontal | | |
| Test Mode: | TX B Mode 2412MHz | | |
| Remark: | N/A | | |

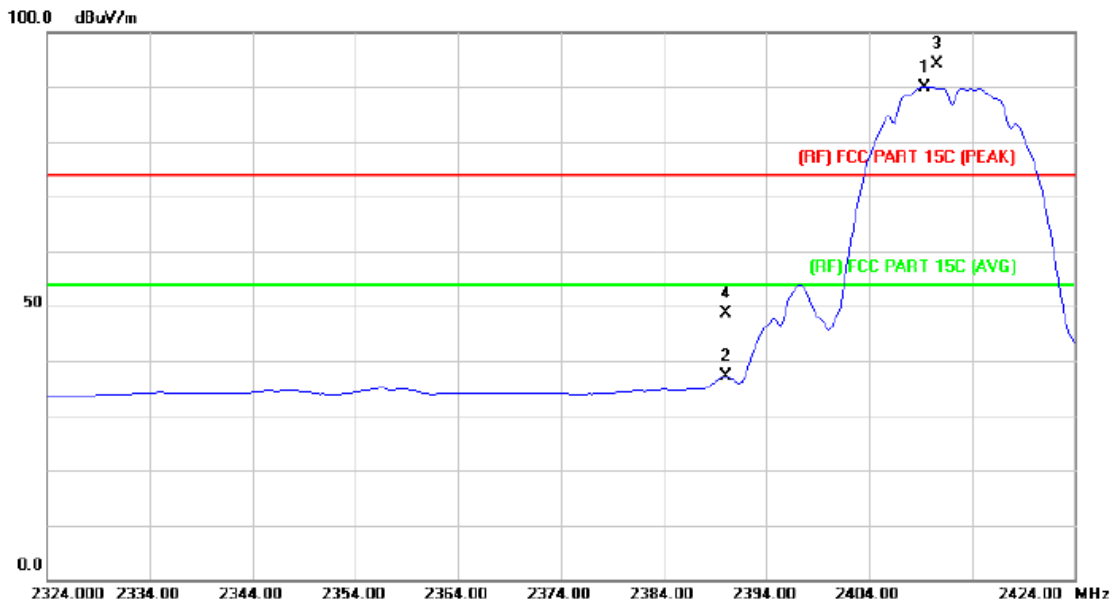

| No. | Mk. | Freq. | Reading Level | Correct Factor | Measurement | Limit | Over | Detector |
|-----|-----|----------|---------------|----------------|-------------|-----------------------|--------|----------|
| | | MHz | dBuV | dB/m | dBuV/m | dBuV/m | dB | |
| 1 | * | 2409.400 | 88.96 | 1.01 | 89.97 | Fundamental Frequency | | AVG |
| 2 | | 2390.000 | 36.17 | 0.91 | 37.08 | 54.00 | -16.92 | AVG |
| 3 | X | 2410.600 | 93.11 | 1.02 | 94.13 | Fundamental Frequency | | peak |
| 4 | | 2390.000 | 47.75 | 0.91 | 48.66 | 74.00 | -25.34 | peak |

Emission Level= Read Level+ Correct Factor

| | | | |
|----------------------|-------------------|---------------------------|-----|
| Temperature: | 25 °C | Relative Humidity: | 55% |
| Test Voltage: | DC 3.7V | | |
| Ant. Pol. | Vertical | | |
| Test Mode: | TX B Mode 2412MHz | | |
| Remark: | N/A | | |

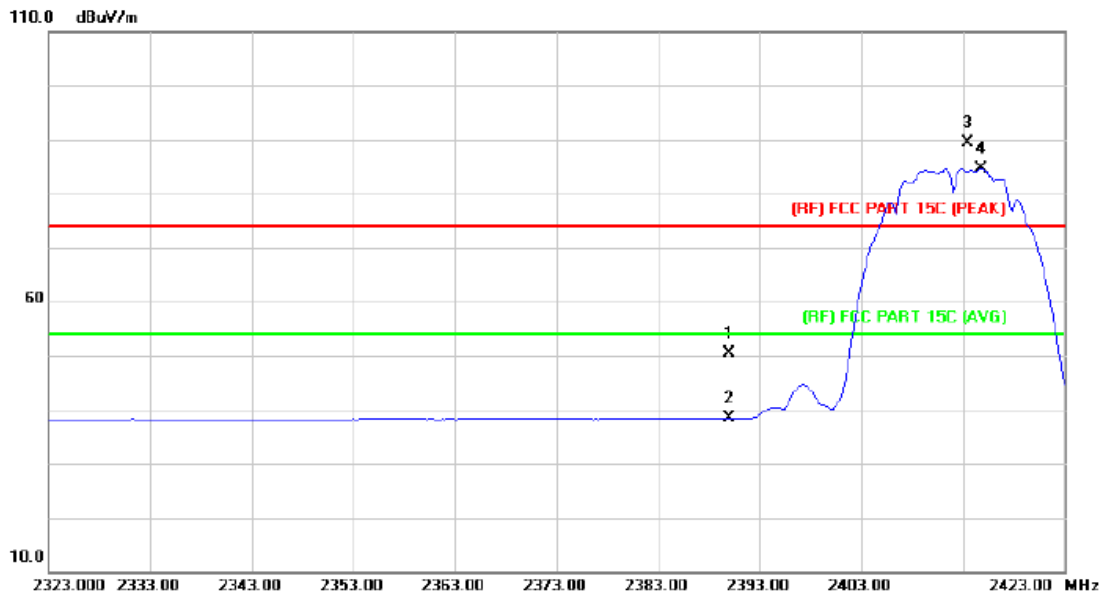

| No. | Mk. | Freq. MHz | Reading Level dBuV | Correct Factor dB/m | Measure- ment dBuV/m | Limit dBuV/m | Over dB | Detector |
|-----|-----|--------------|--------------------------|---------------------------|----------------------------|-----------------------|------------|----------|
| 1 | | 2390.000 | 49.42 | 0.91 | 50.33 | 74.00 | -23.67 | peak |
| 2 | | 2390.000 | 37.45 | 0.91 | 38.36 | 54.00 | -15.64 | AVG |
| 3 | X | 2413.400 | 88.40 | 1.02 | 89.42 | Fundamental Frequency | | peak |
| 4 | * | 2414.800 | 83.66 | 1.03 | 84.69 | Fundamental Frequency | | AVG |

Emission Level= Read Level+ Correct Factor

| | | | |
|----------------------|-------------------|---------------------------|-----|
| Temperature: | 25 °C | Relative Humidity: | 55% |
| Test Voltage: | DC 3.7V | | |
| Ant. Pol. | Horizontal | | |
| Test Mode: | TX B Mode 2462MHz | | |
| Remark: | N/A | | |

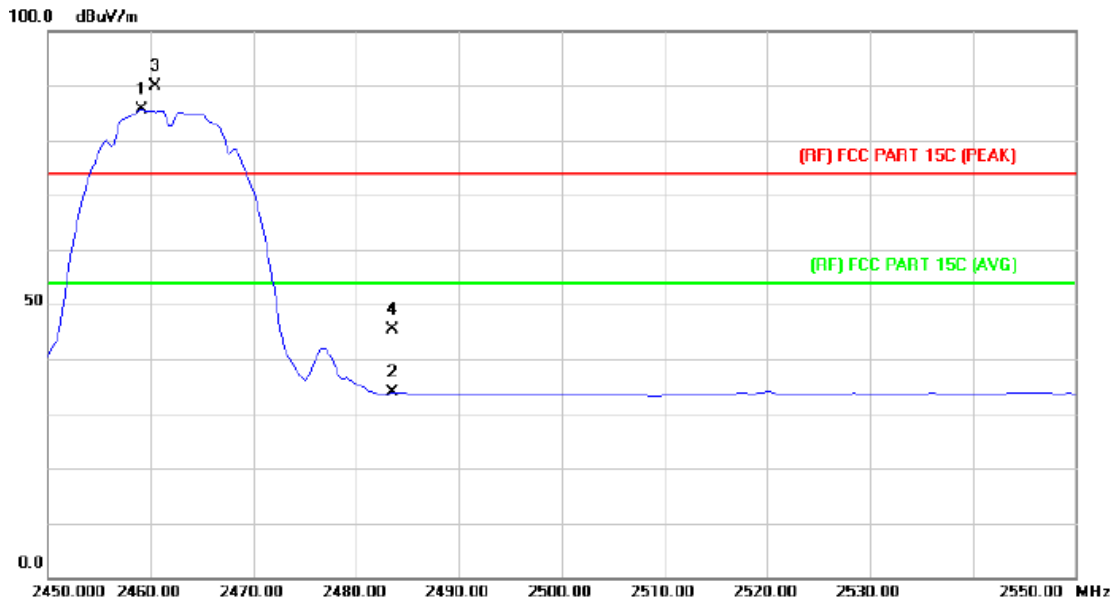

| No. | Mk. | Freq. MHz | Reading Level dBuV | Correct Factor dB/m | Measure- ment dBuV/m | Limit dBuV/m | Over dB | Detector |
|-----|-----|--------------|--------------------------|---------------------------|----------------------------|-----------------------|------------|----------|
| 1 | * | 2459.200 | 84.39 | 1.22 | 85.61 | Fundamental Frequency | | AVG |
| 2 | | 2483.500 | 32.56 | 1.34 | 33.90 | 54.00 | -20.10 | AVG |
| 3 | X | 2460.400 | 88.53 | 1.23 | 89.76 | Fundamental Frequency | | peak |
| 4 | | 2483.500 | 44.04 | 1.34 | 45.38 | 74.00 | -28.62 | peak |

Emission Level= Read Level+ Correct Factor

| | | | |
|----------------------|-------------------|---------------------------|-----|
| Temperature: | 25 °C | Relative Humidity: | 55% |
| Test Voltage: | DC 3.7V | | |
| Ant. Pol. | Vertical | | |
| Test Mode: | TX B Mode 2462MHz | | |
| Remark: | N/A | | |

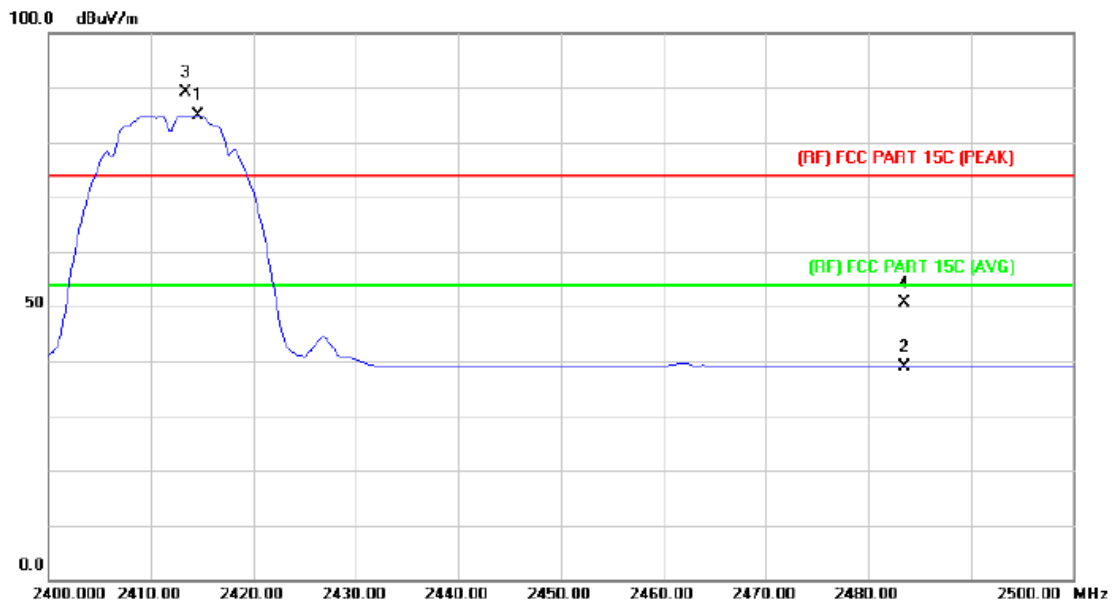

| No. | Mk. | Freq. MHz | Reading Level dBuV | Correct Factor dB/m | Measure- ment dBuV/m | Limit dBuV/m | Over dB | Detector |
|-----|-----|--------------|--------------------------|---------------------------|----------------------------|-----------------------|------------|----------|
| 1 | * | 2414.600 | 83.85 | 1.03 | 84.88 | Fundamental Frequency | | AVG |
| 2 | | 2483.500 | 37.65 | 1.34 | 38.99 | 54.00 | -15.01 | AVG |
| 3 | X | 2413.400 | 88.20 | 1.02 | 89.22 | Fundamental Frequency | | peak |
| 4 | | 2483.500 | 49.25 | 1.34 | 50.59 | 74.00 | -23.41 | peak |

Emission Level= Read Level+ Correct Factor

| | | | |
|----------------------|-------------------|---------------------------|-----|
| Temperature: | 25 °C | Relative Humidity: | 55% |
| Test Voltage: | DC 3.7V | | |
| Ant. Pol. | Horizontal | | |
| Test Mode: | TX G Mode 2412MHz | | |
| Remark: | N/A | | |

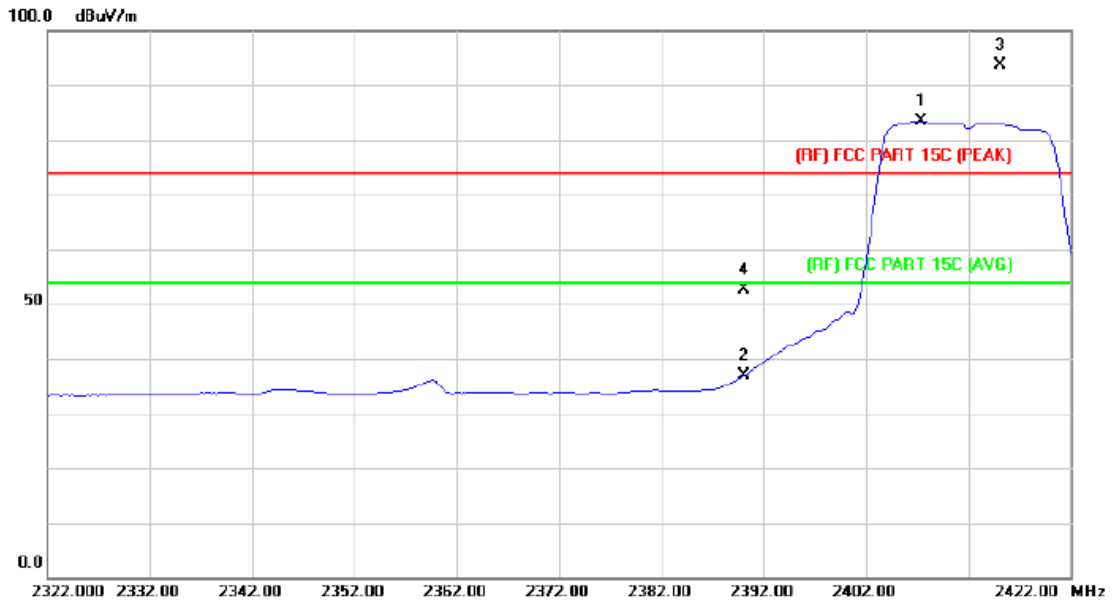

| No. | Mk. | Freq. MHz | Reading Level dBuV | Correct Factor dB/m | Measure- ment dBuV/m | Limit dBuV/m | Over dB | Detector |
|-----|-----|--------------|--------------------------|---------------------------|----------------------------|-----------------------|------------|----------|
| 1 | * | 2407.400 | 82.39 | 1.00 | 83.39 | Fundamental Frequency | | AVG |
| 2 | | 2390.000 | 35.88 | 0.91 | 36.79 | 54.00 | -17.21 | AVG |
| 3 | X | 2415.200 | 92.56 | 1.03 | 93.59 | Fundamental Frequency | | peak |
| 4 | | 2390.000 | 51.75 | 0.91 | 52.66 | 74.00 | -21.34 | peak |

Emission Level= Read Level+ Correct Factor

| | | | |
|----------------------|-------------------|---------------------------|-----|
| Temperature: | 25 °C | Relative Humidity: | 55% |
| Test Voltage: | DC 3.7V | | |
| Ant. Pol. | Vertical | | |
| Test Mode: | TX G Mode 2412MHz | | |
| Remark: | N/A | | |

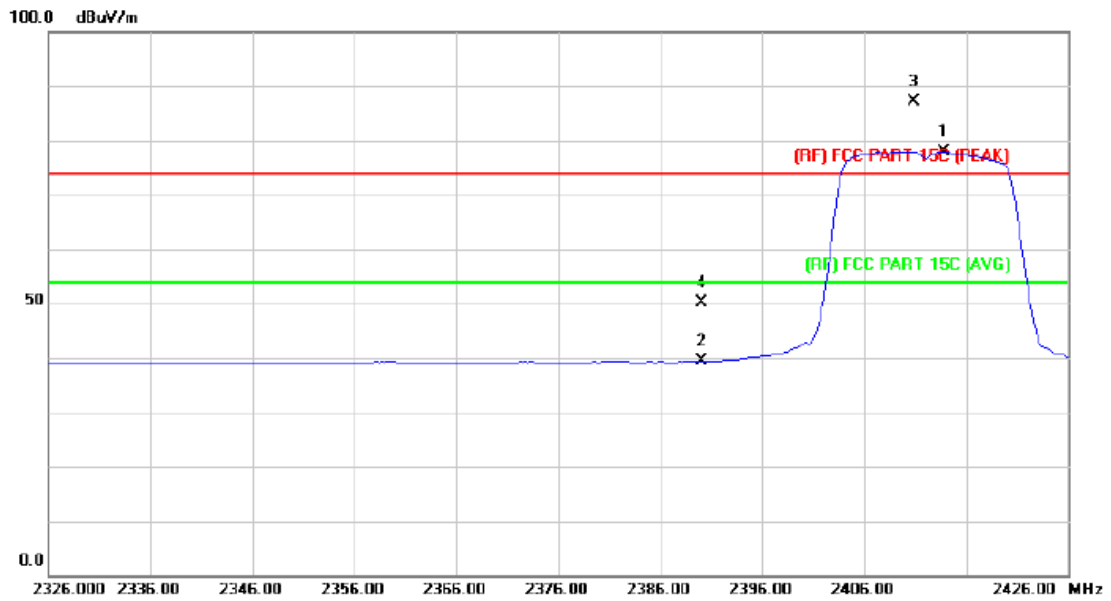

| No. | Mk. | Freq. MHz | Reading Level dBuV | Correct Factor dB/m | Measure- ment dBuV/m | Limit dBuV/m | Over dB | Detector |
|-----|-----|--------------|--------------------------|---------------------------|----------------------------|-----------------------|------------|----------|
| 1 | * | 2413.800 | 76.81 | 1.02 | 77.83 | Fundamental Frequency | | AVG |
| 2 | | 2390.000 | 38.44 | 0.91 | 39.35 | 54.00 | -14.65 | AVG |
| 3 | X | 2410.800 | 86.15 | 1.02 | 87.17 | Fundamental Frequency | | peak |
| 4 | | 2390.000 | 49.32 | 0.91 | 50.23 | 74.00 | -23.77 | peak |

Emission Level= Read Level+ Correct Factor

| | | | |
|----------------------|-------------------|---------------------------|-----|
| Temperature: | 25 °C | Relative Humidity: | 55% |
| Test Voltage: | DC 3.7V | | |
| Ant. Pol. | Horizontal | | |
| Test Mode: | TX G Mode 2462MHz | | |
| Remark: | N/A | | |

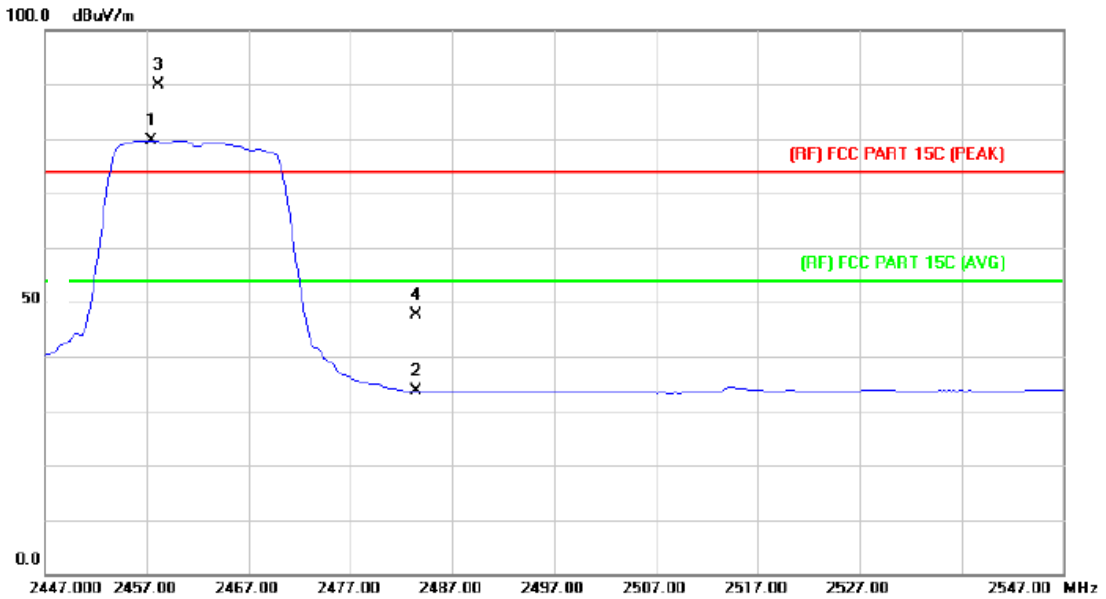

| No. | Mk. | Freq. MHz | Reading Level dBuV | Correct Factor dB/m | Measure- ment dBuV/m | Limit dBuV/m | Over dB | Detector |
|-----|-----|--------------|--------------------------|---------------------------|----------------------------|-----------------------|------------|----------|
| 1 | * | 2457.400 | 78.52 | 1.21 | 79.73 | Fundamental Frequency | | AVG |
| 2 | | 2483.500 | 32.21 | 1.34 | 33.55 | 54.00 | -20.45 | AVG |
| 3 | X | 2458.200 | 88.67 | 1.22 | 89.89 | Fundamental Frequency | | peak |
| 4 | | 2483.500 | 46.18 | 1.34 | 47.52 | 74.00 | -26.48 | peak |

Emission Level= Read Level+ Correct Factor

| | | | |
|----------------------|-------------------|---------------------------|-----|
| Temperature: | 25 °C | Relative Humidity: | 55% |
| Test Voltage: | DC 3.7V | | |
| Ant. Pol. | Vertical | | |
| Test Mode: | TX G Mode 2462MHz | | |
| Remark: | N/A | | |

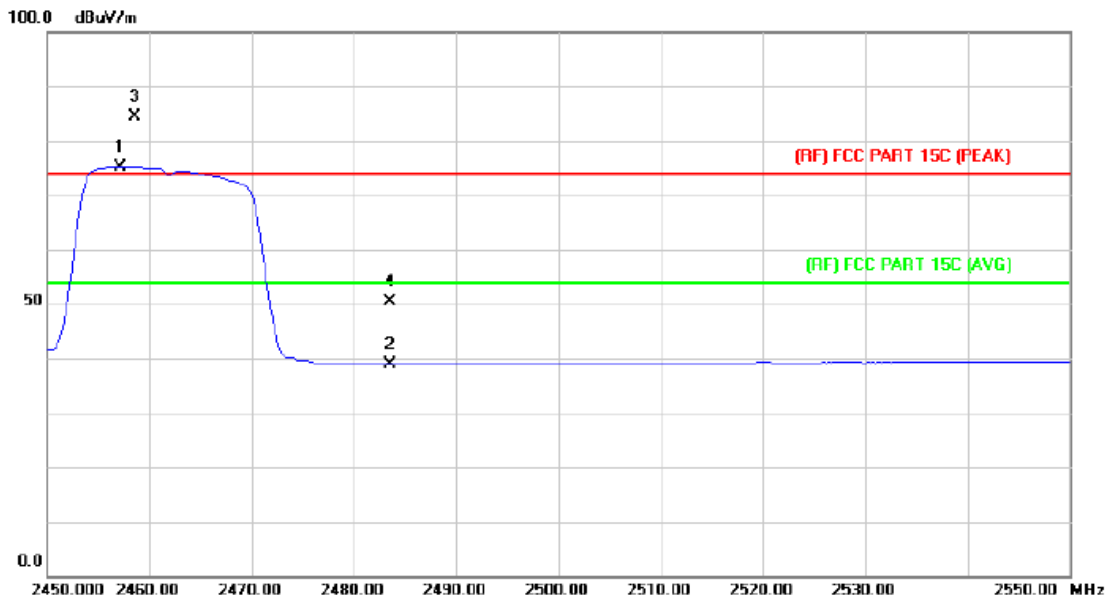

| No. | Mk. | Freq. MHz | Reading Level dBuV | Correct Factor dB/m | Measure- ment dBuV/m | Limit dBuV/m | Over dB | Detector |
|-----|-----|--------------|--------------------------|---------------------------|----------------------------|-----------------------|------------|----------|
| 1 | * | 2457.200 | 73.93 | 1.21 | 75.14 | Fundamental Frequency | | AVG |
| 2 | | 2483.500 | 37.62 | 1.34 | 38.96 | 54.00 | -15.04 | AVG |
| 3 | X | 2458.600 | 83.27 | 1.22 | 84.49 | Fundamental Frequency | | peak |
| 4 | | 2483.500 | 48.99 | 1.34 | 50.33 | 74.00 | -23.67 | peak |

Emission Level= Read Level+ Correct Factor

| | | | |
|----------------------|-------------------------|---------------------------|-----|
| Temperature: | 25 °C | Relative Humidity: | 55% |
| Test Voltage: | DC 3.7V | | |
| Ant. Pol. | Horizontal | | |
| Test Mode: | TX N(HT20) Mode 2412MHz | | |
| Remark: | N/A | | |

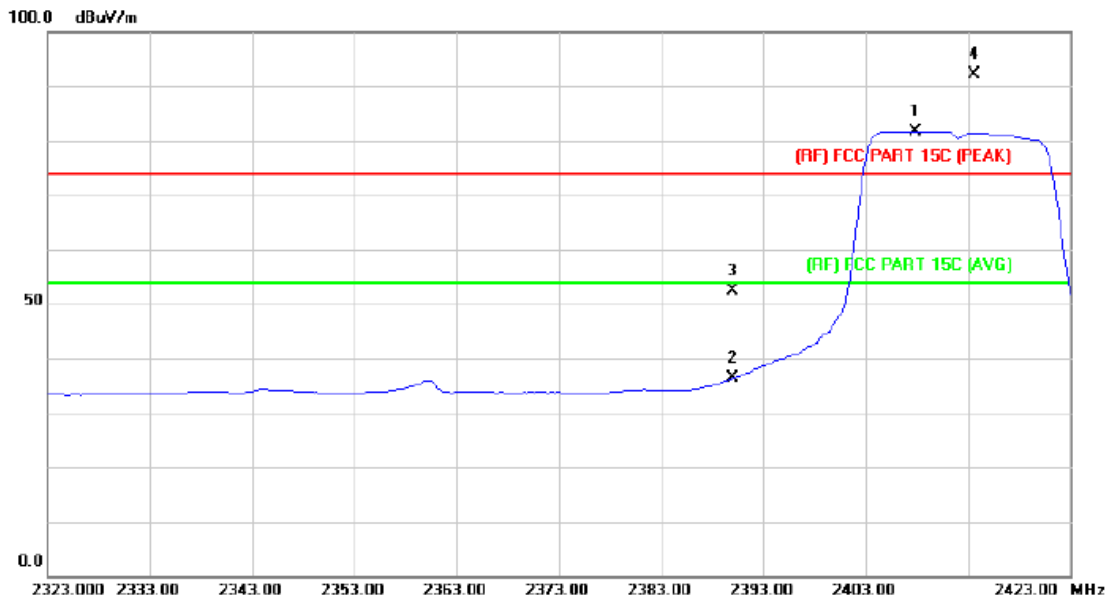

| No. | Mk. | Freq. MHz | Reading Level dBuV | Correct Factor dB/m | Measure- ment dBuV/m | Limit dBuV/m | Over dB | Detector |
|-----|-----|--------------|--------------------------|---------------------------|----------------------------|-----------------------|------------|----------|
| 1 | * | 2407.800 | 80.75 | 1.00 | 81.75 | Fundamental Frequency | | AVG |
| 2 | | 2390.000 | 35.44 | 0.91 | 36.35 | 54.00 | -17.65 | AVG |
| 3 | | 2390.000 | 51.53 | 0.91 | 52.44 | 74.00 | -21.56 | peak |
| 4 | X | 2413.600 | 91.23 | 1.02 | 92.25 | Fundamental Frequency | | peak |

Emission Level= Read Level+ Correct Factor

| | | | |
|----------------------|-------------------------|---------------------------|-----|
| Temperature: | 25 °C | Relative Humidity: | 55% |
| Test Voltage: | DC 3.7V | | |
| Ant. Pol. | Vertical | | |
| Test Mode: | TX N(HT20) Mode 2412MHz | | |
| Remark: | N/A | | |

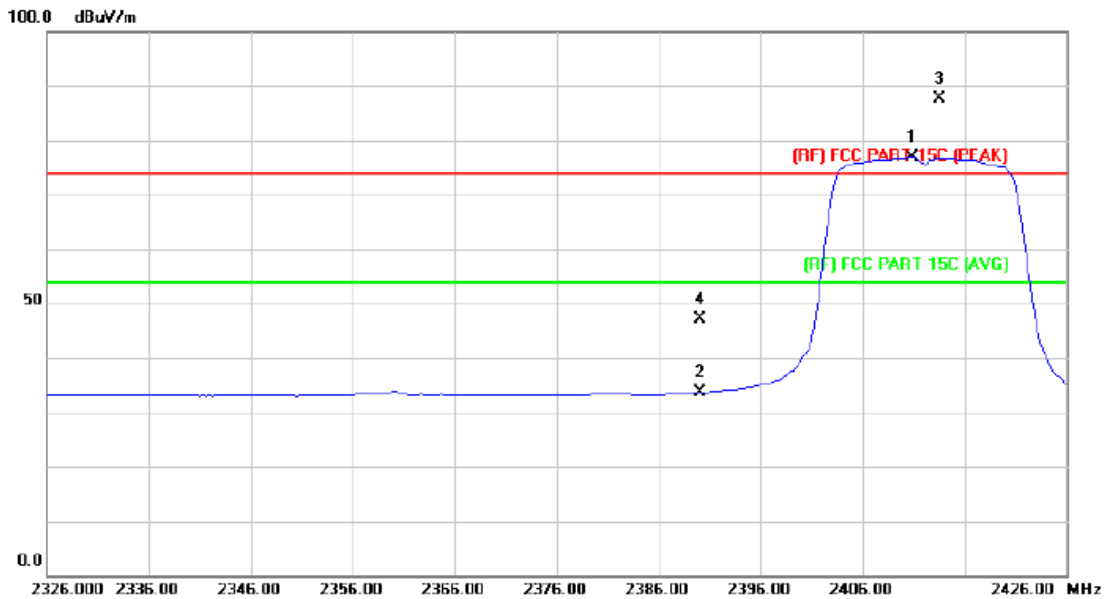

| No. | Mk. | Freq. MHz | Reading Level dBuV | Correct Factor dB/m | Measure- ment dBuV/m | Limit dBuV/m | Over dB | Detector |
|-----|-----|--------------|--------------------------|---------------------------|----------------------------|-----------------------|------------|----------|
| 1 | * | 2410.800 | 75.79 | 1.02 | 76.81 | Fundamental Frequency | | AVG |
| 2 | | 2390.000 | 32.72 | 0.91 | 33.63 | 54.00 | -20.37 | AVG |
| 3 | X | 2413.600 | 86.53 | 1.02 | 87.55 | Fundamental Frequency | | peak |
| 4 | | 2390.000 | 46.34 | 0.91 | 47.25 | 74.00 | -26.75 | peak |

Emission Level= Read Level+ Correct Factor

| | | | |
|----------------------|-------------------------|---------------------------|-----|
| Temperature: | 25 °C | Relative Humidity: | 55% |
| Test Voltage: | DC 3.7V | | |
| Ant. Pol. | Horizontal | | |
| Test Mode: | TX N(HT20) Mode 2462MHz | | |
| Remark: | N/A | | |

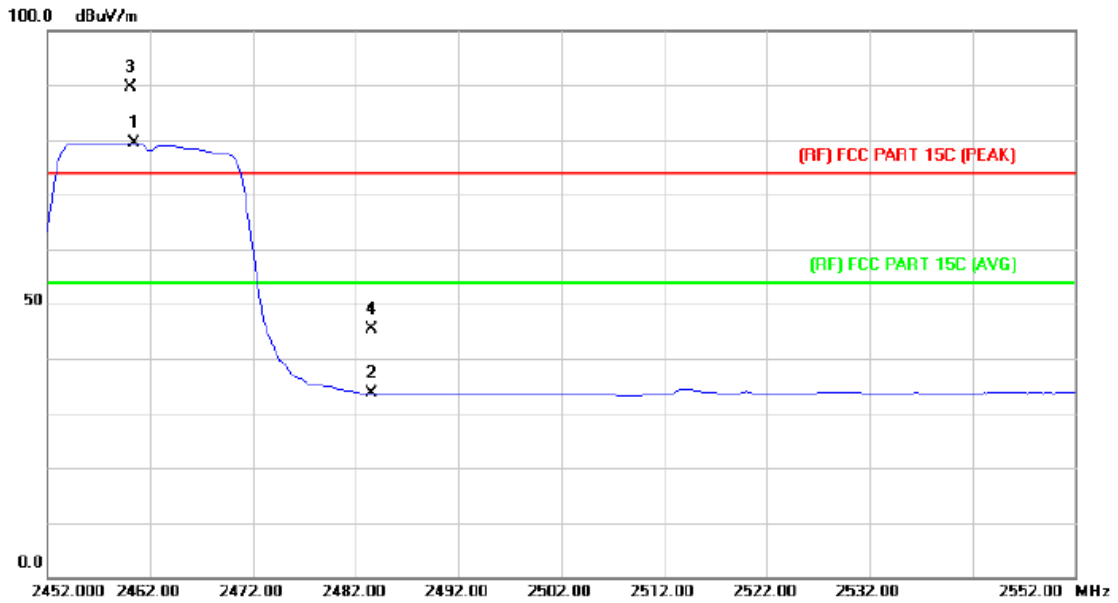

| No. | Mk. | Freq. | Reading Level | Correct Factor | Measurement | Limit | Over | |
|-----|-----|----------|---------------|----------------|-------------|--------|--------|----------------------------|
| | | MHz | dBuV | dB/m | dBuV/m | dBuV/m | dB | Detector |
| 1 | * | 2460.400 | 78.23 | 1.23 | 79.46 | | | Fundamental Frequency AVG |
| 2 | | 2483.500 | 32.22 | 1.34 | 33.56 | 54.00 | -20.44 | AVG |
| 3 | X | 2460.000 | 88.40 | 1.23 | 89.63 | | | Fundamental Frequency peak |
| 4 | | 2483.500 | 44.01 | 1.34 | 45.35 | 74.00 | -28.65 | peak |

Emission Level= Read Level+ Correct Factor

| | | | |
|----------------------|-------------------------|---------------------------|-----|
| Temperature: | 25 °C | Relative Humidity: | 55% |
| Test Voltage: | DC 3.7V | | |
| Ant. Pol. | Vertical | | |
| Test Mode: | TX N(HT20) Mode 2462MHz | | |
| Remark: | N/A | | |

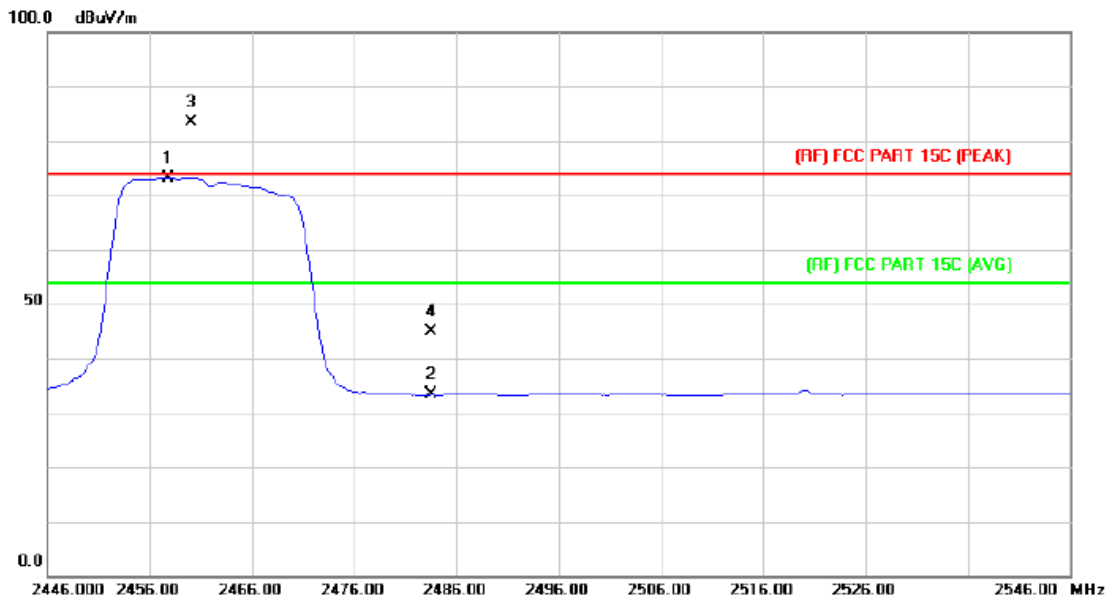

| No. | Mk. | Freq. MHz | Reading Level dBuV | Correct Factor dB/m | Measure- ment dBuV/m | Limit dBuV/m | Over dB | Detector |
|-----|-----|--------------|--------------------------|---------------------------|----------------------------|-----------------------|------------|----------|
| 1 | * | 2457.800 | 71.87 | 1.22 | 73.09 | Fundamental Frequency | | AVG |
| 2 | | 2483.500 | 31.92 | 1.34 | 33.26 | 54.00 | -20.74 | AVG |
| 3 | X | 2460.000 | 82.06 | 1.23 | 83.29 | Fundamental Frequency | | peak |
| 4 | | 2483.500 | 43.57 | 1.34 | 44.91 | 74.00 | -29.09 | peak |

Emission Level= Read Level+ Correct Factor

| | | | |
|----------------------|-------------------------|---------------------------|-----|
| Temperature: | 25 °C | Relative Humidity: | 55% |
| Test Voltage: | DC 3.7V | | |
| Ant. Pol. | Horizontal | | |
| Test Mode: | TX N(HT40) Mode 2422MHz | | |
| Remark: | N/A | | |

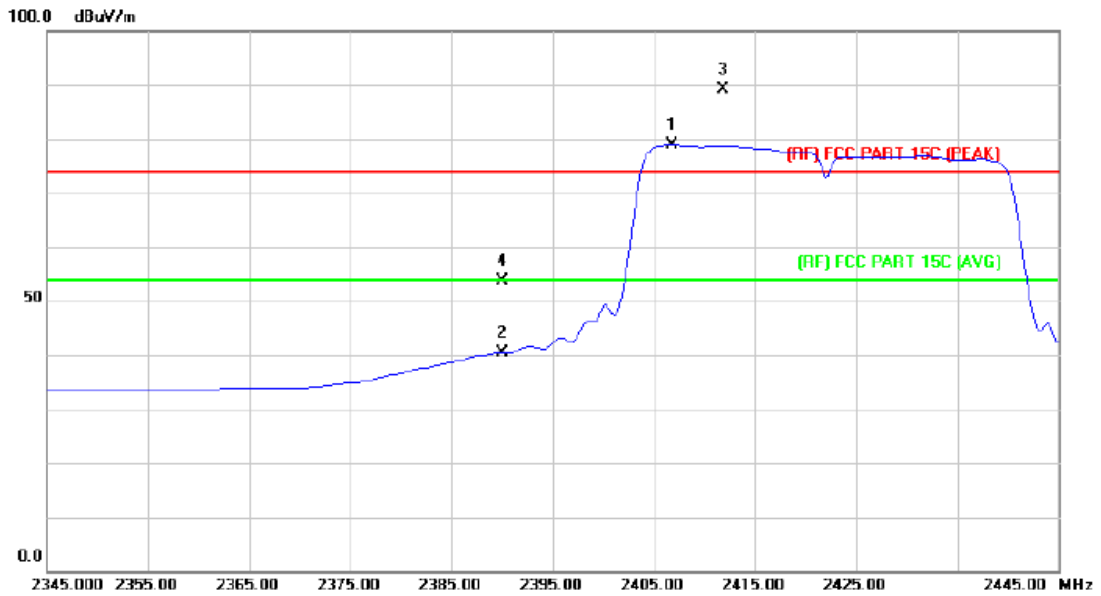

| No. | Mk. | Freq. MHz | Reading Level dBuV | Correct Factor dB/m | Measure- ment dBuV/m | Limit dBuV/m | Over dB | Detector |
|-----|-----|--------------|--------------------------|---------------------------|----------------------------|-----------------------|------------|----------|
| 1 | * | 2406.800 | 77.91 | 0.99 | 78.90 | Fundamental Frequency | | AVG |
| 2 | | 2390.000 | 39.53 | 0.91 | 40.44 | 54.00 | -13.56 | AVG |
| 3 | X | 2411.800 | 88.05 | 1.02 | 89.07 | Fundamental Frequency | | peak |
| 4 | | 2390.000 | 52.60 | 0.91 | 53.51 | 74.00 | -20.49 | peak |

Emission Level= Read Level+ Correct Factor

| | | | |
|----------------------|-------------------------|---------------------------|-----|
| Temperature: | 25 °C | Relative Humidity: | 55% |
| Test Voltage: | DC 3.7V | | |
| Ant. Pol. | Vertical | | |
| Test Mode: | TX N(HT40) Mode 2422MHz | | |
| Remark: | N/A | | |

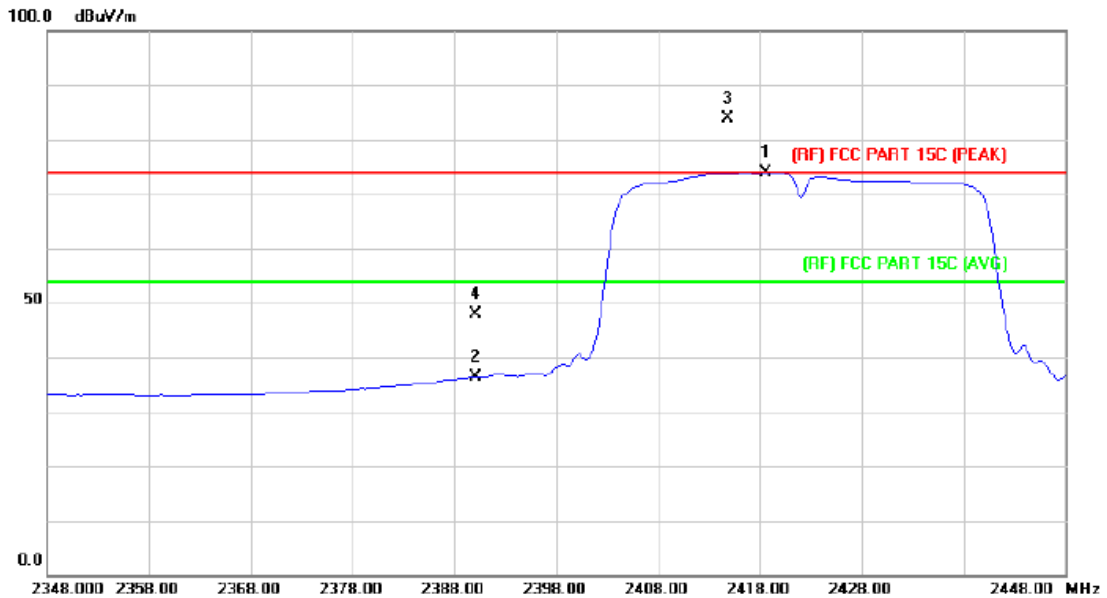

| No. | Mk. | Freq. MHz | Reading Level dBuV | Correct Factor dB/m | Measure- ment dBuV/m | Limit dBuV/m | Over dB | Detector |
|-----|-----|--------------|--------------------------|---------------------------|----------------------------|-----------------------|------------|----------|
| 1 | * | 2418.600 | 72.79 | 1.05 | 73.84 | Fundamental Frequency | | AVG |
| 2 | | 2390.000 | 35.47 | 0.91 | 36.38 | 54.00 | -17.62 | AVG |
| 3 | X | 2414.800 | 82.96 | 1.03 | 83.99 | Fundamental Frequency | | peak |
| 4 | | 2390.000 | 46.89 | 0.91 | 47.80 | 74.00 | -26.20 | peak |

Emission Level= Read Level+ Correct Factor

| | | | |
|----------------------|-------------------------|---------------------------|-----|
| Temperature: | 25 °C | Relative Humidity: | 55% |
| Test Voltage: | DC 3.7V | | |
| Ant. Pol. | Horizontal | | |
| Test Mode: | TX N(HT40) Mode 2452MHz | | |
| Remark: | N/A | | |

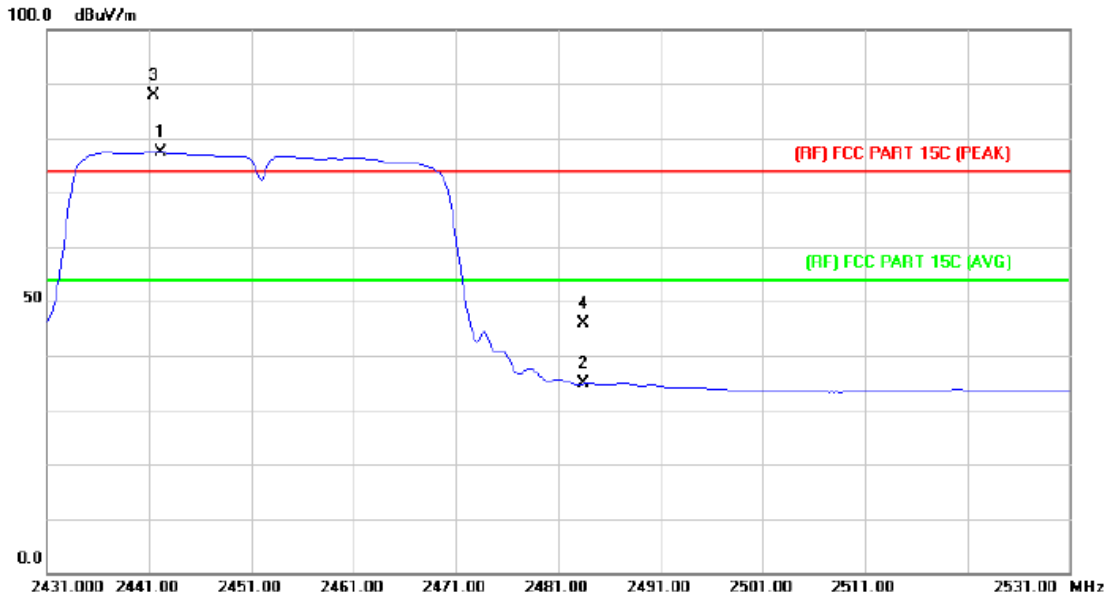

| No. | Mk. | Freq. | Reading Level | Correct Factor | Measurement | Limit | Over | Detector |
|-----|-----|----------|---------------|----------------|-------------|-----------------------|--------|----------|
| | | MHz | dBuV | dB/m | dBuV/m | dBuV/m | dB | |
| 1 | * | 2442.200 | 76.22 | 1.15 | 77.37 | Fundamental Frequency | | AVG |
| 2 | | 2483.500 | 33.43 | 1.34 | 34.77 | 54.00 | -19.23 | AVG |
| 3 | X | 2441.400 | 86.66 | 1.15 | 87.81 | Fundamental Frequency | | peak |
| 4 | | 2483.500 | 44.42 | 1.34 | 45.76 | 74.00 | -28.24 | peak |

Emission Level= Read Level+ Correct Factor

| | | | |
|----------------------|-------------------------|---------------------------|-----|
| Temperature: | 25 °C | Relative Humidity: | 55% |
| Test Voltage: | DC 3.7V | | |
| Ant. Pol. | Vertical | | |
| Test Mode: | TX N(HT40) Mode 2452MHz | | |
| Remark: | N/A | | |

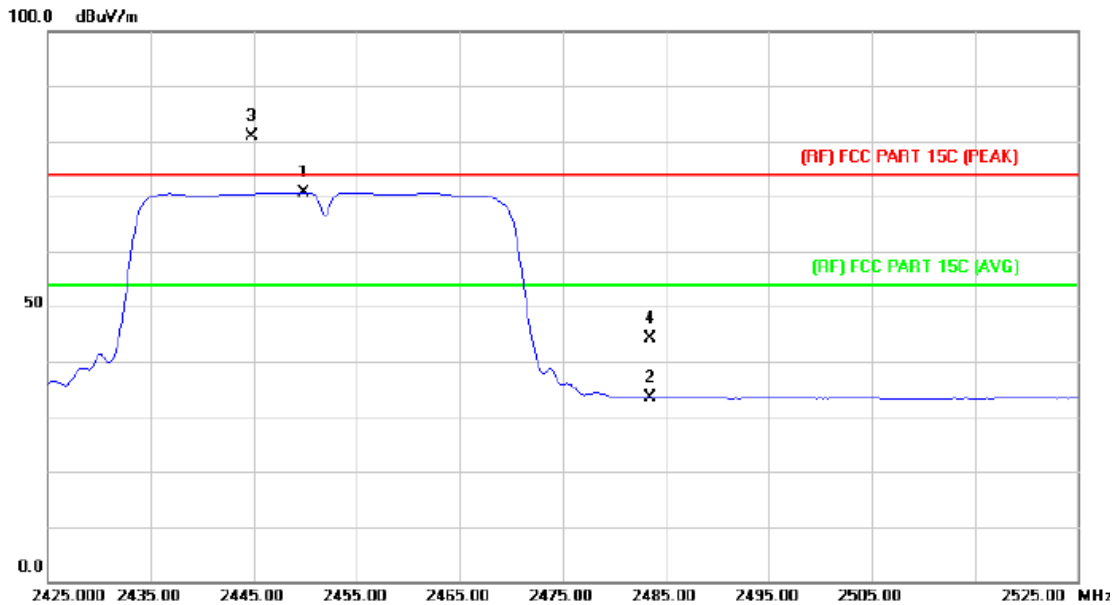

| No. | Mk. | Freq. MHz | Reading Level dBuV | Correct Factor dB/m | Measure- ment dBuV/m | Limit dBuV/m | Over dB | Detector |
|-----|-----|--------------|--------------------------|---------------------------|----------------------------|-----------------------|------------|----------|
| 1 | * | 2449.800 | 69.56 | 1.18 | 70.74 | Fundamental Frequency | | AVG |
| 2 | | 2483.500 | 32.07 | 1.34 | 33.41 | 54.00 | -20.59 | AVG |
| 3 | X | 2444.800 | 79.74 | 1.16 | 80.90 | Fundamental Frequency | | peak |
| 4 | | 2483.500 | 42.72 | 1.34 | 44.06 | 74.00 | -29.94 | peak |

Emission Level= Read Level+ Correct Factor

(2) Conducted Test

| | | | |
|---------------|--|--------------------|-----|
| Temperature: | 25 °C | Relative Humidity: | 55% |
| Test Voltage: | DC 3.7V | | |
| Test Mode: | TX B Mode 2412MHz / TX B Mode 2462MHz | | |
| Remark: | The EUT is programed in continuously transmitting mode | | |

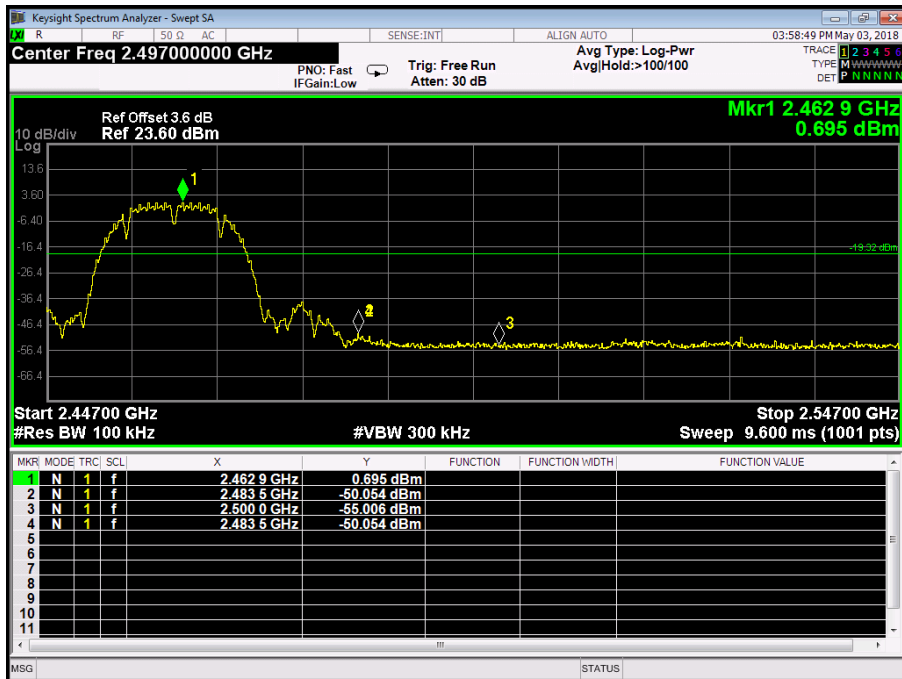
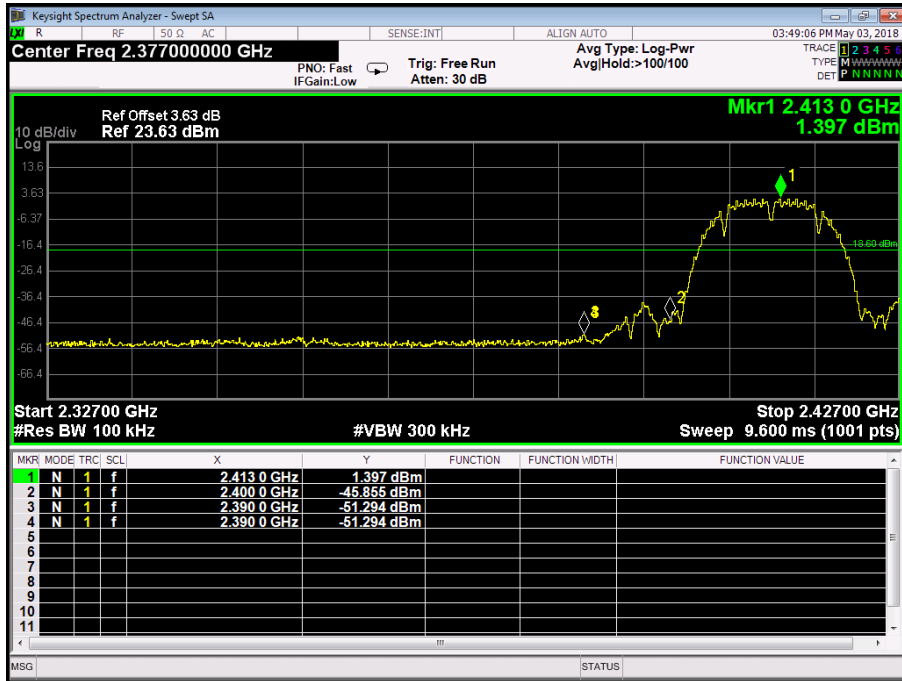

| | | | |
|---------------|--|--------------------|-----|
| Temperature: | 25 °C | Relative Humidity: | 55% |
| Test Voltage: | DC 3.7V | | |
| Test Mode: | TX G Mode 2412MHz / TX G Mode 2462MHz | | |
| Remark: | The EUT is programed in continuously transmitting mode | | |

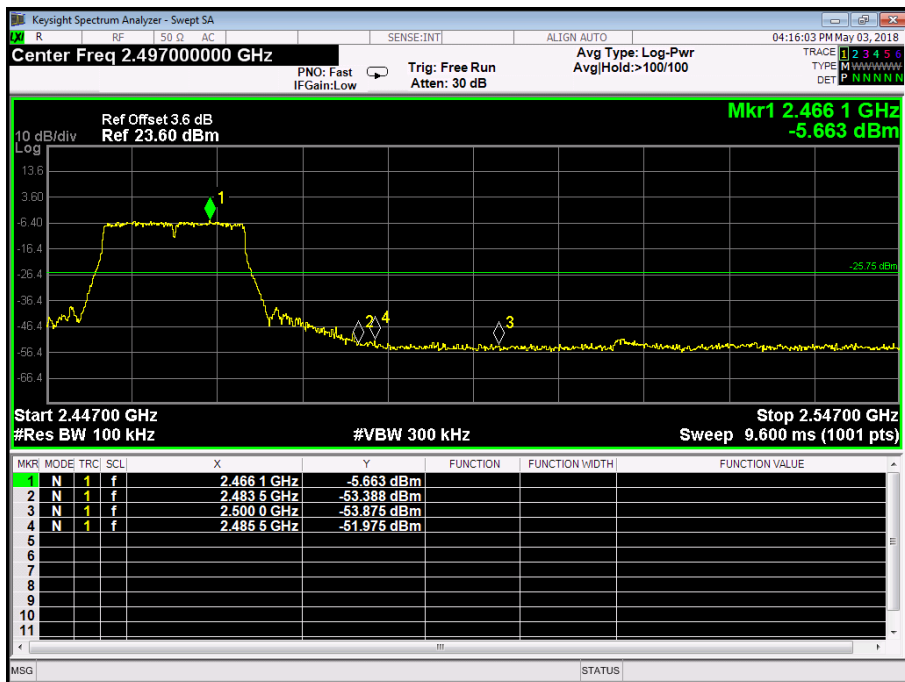
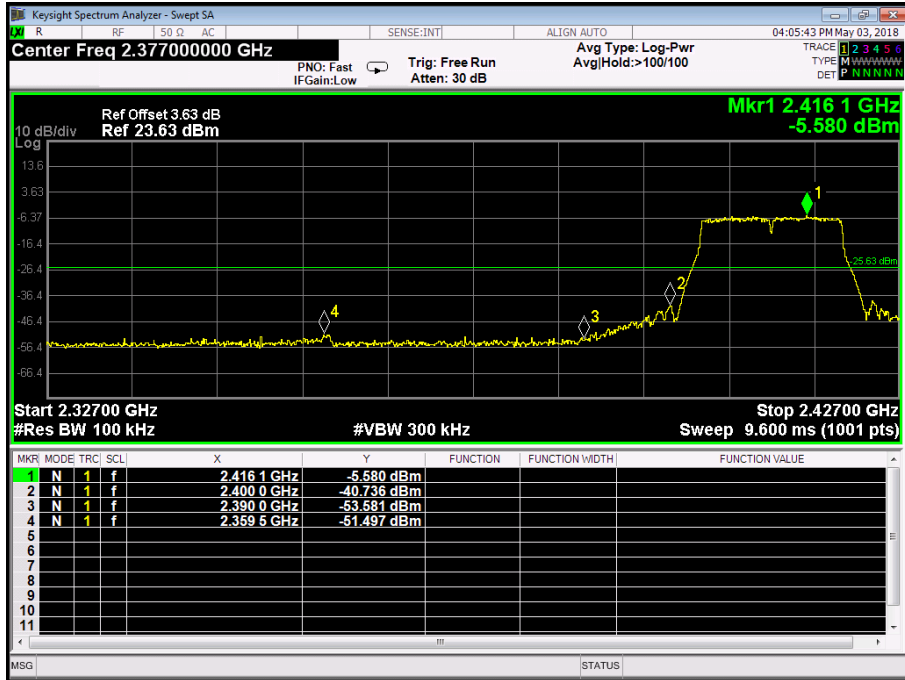

| | | | |
|----------------------|--|---------------------------|-----|
| Temperature: | 25 °C | Relative Humidity: | 55% |
| Test Voltage: | DC 3.7V | | |
| Test Mode: | TX N(HT20) Mode 2412MHz / TX N(HT20) Mode 2462MHz | | |
| Remark: | The EUT is programed in continuously transmitting mode | | |

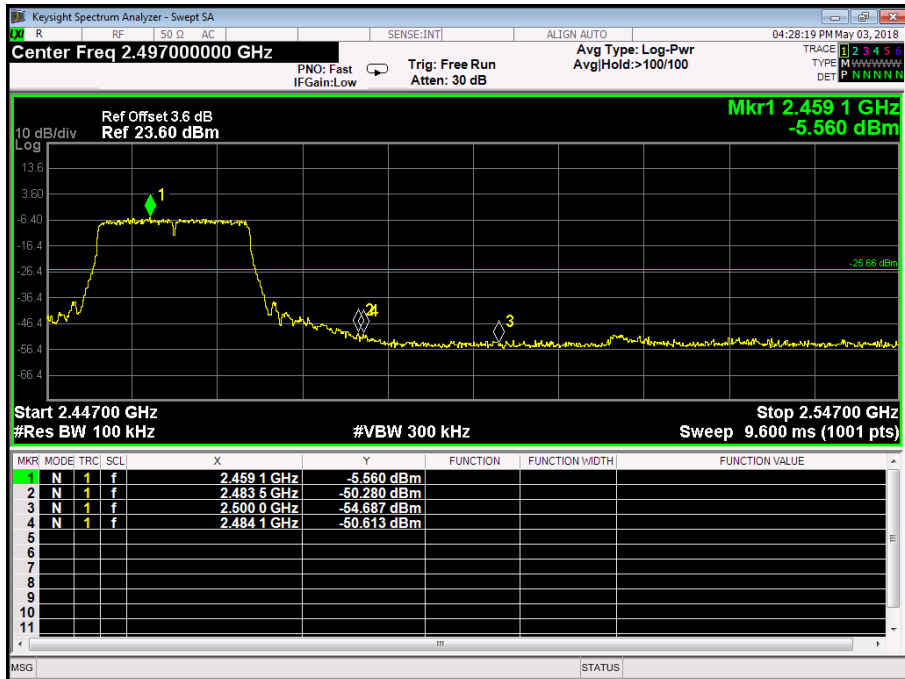
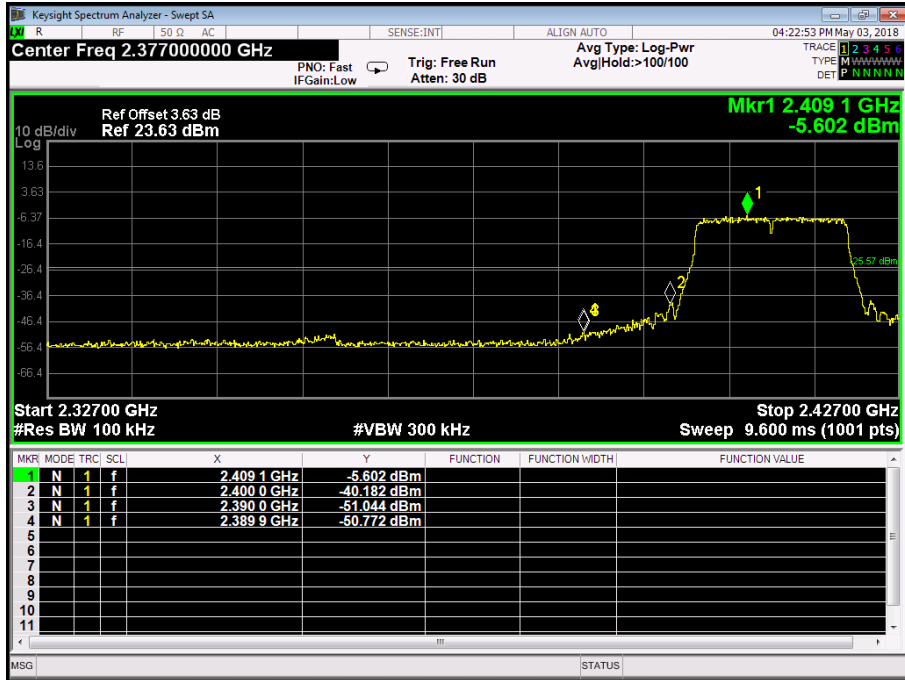

| | | | |
|----------------------|--|---------------------------|-----|
| Temperature: | 25 °C | Relative Humidity: | 55% |
| Test Voltage: | DC 3.7V | | |
| Test Mode: | TX N(HT40) Mode 2422MHz / TX N(HT40) Mode 2452MHz | | |
| Remark: | The EUT is programed in continuously transmitting mode | | |

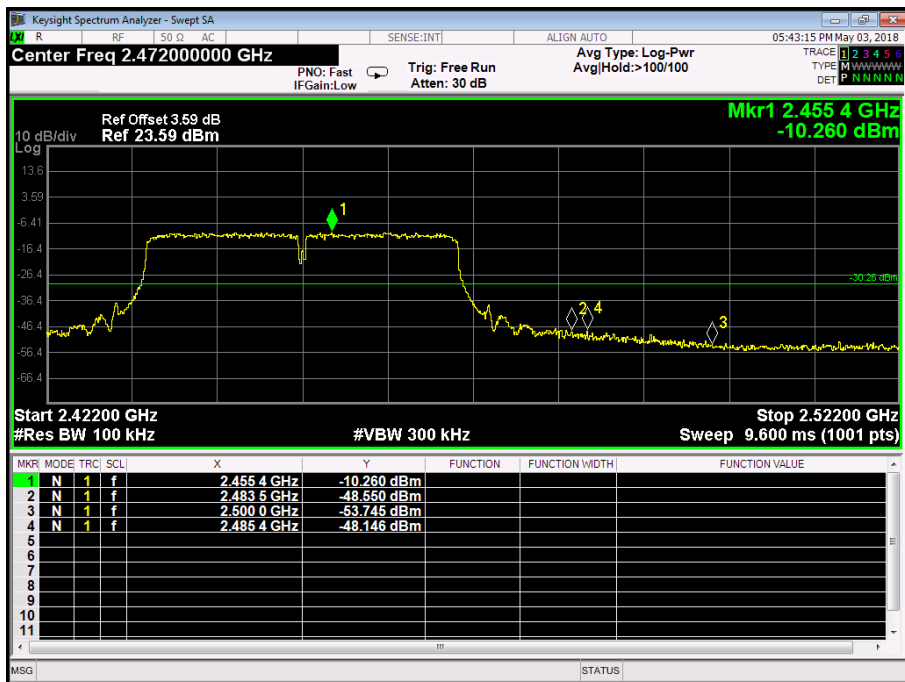
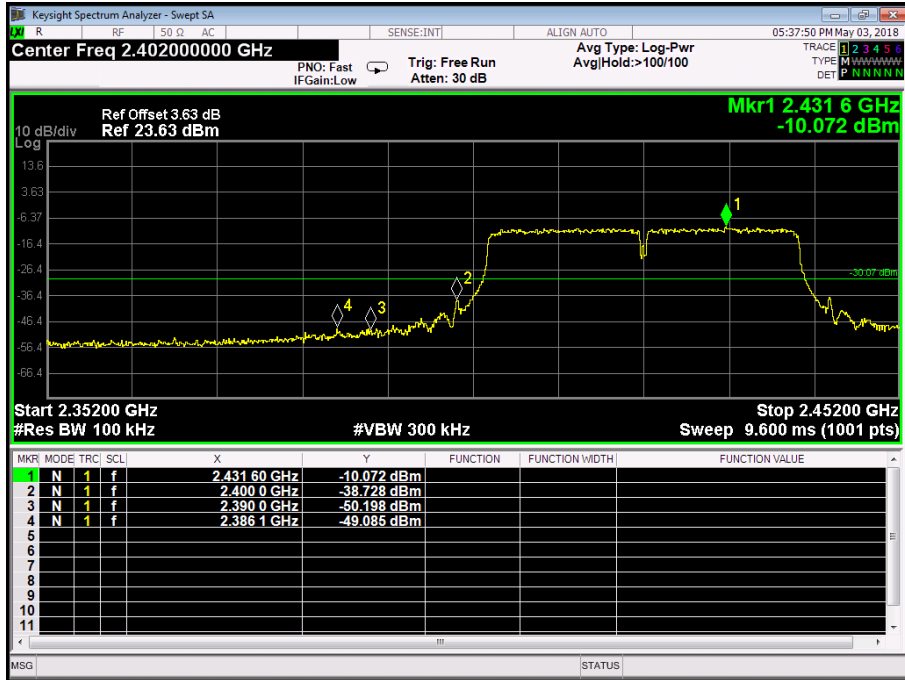

Attachment D-- Bandwidth Test Data

| Temperature: | 25 °C | Relative Humidity: | 55% |
|-------------------------|---------------------|---------------------|-------------|
| Test Voltage: | DC 3.7V | | |
| Test Mode: | TX 802.11B Mode | | |
| Channel frequency (MHz) | 6dB Bandwidth (MHz) | 99% Bandwidth (MHz) | Limit (MHz) |
| 2412 | 12.11 | 15.015 | >=0.5 |
| 2437 | 12.11 | 15.016 | |
| 2462 | 12.11 | 15.013 | |

802.11B Mode

2412 MHz

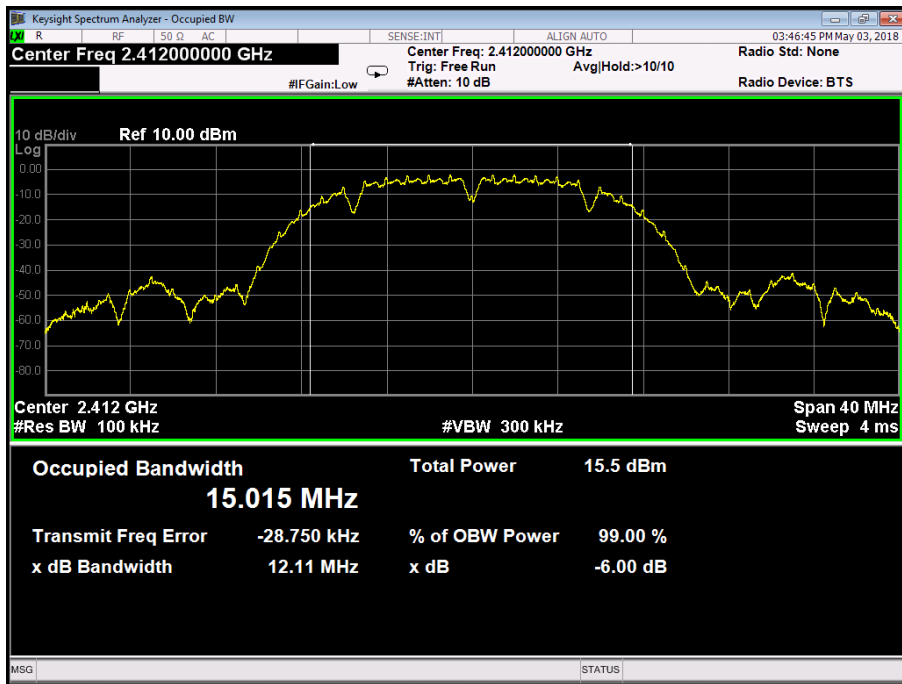

802.11B Mode

2437 MHz

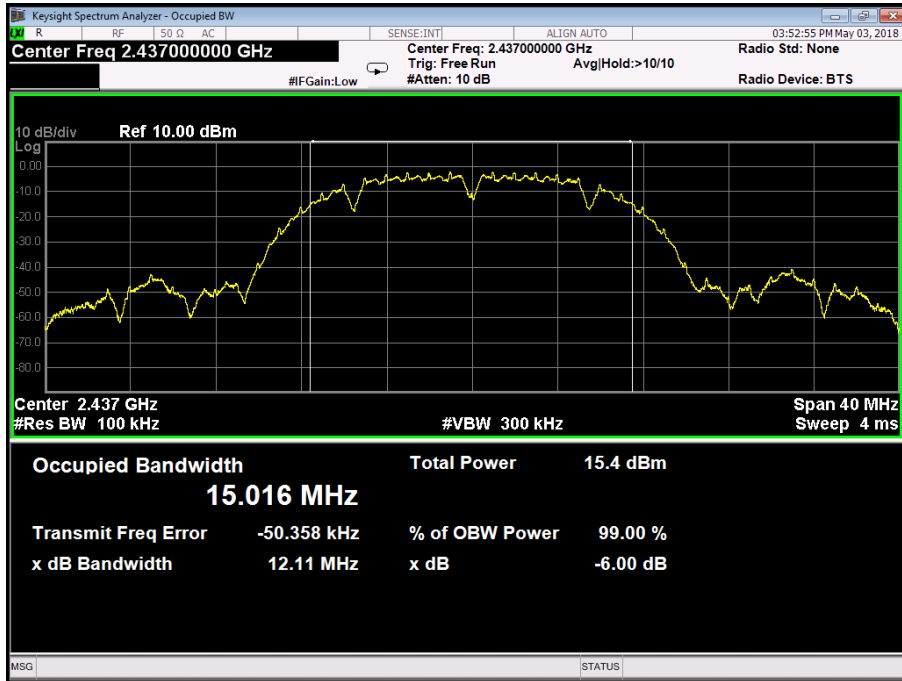

802.11B Mode

2462 MHz

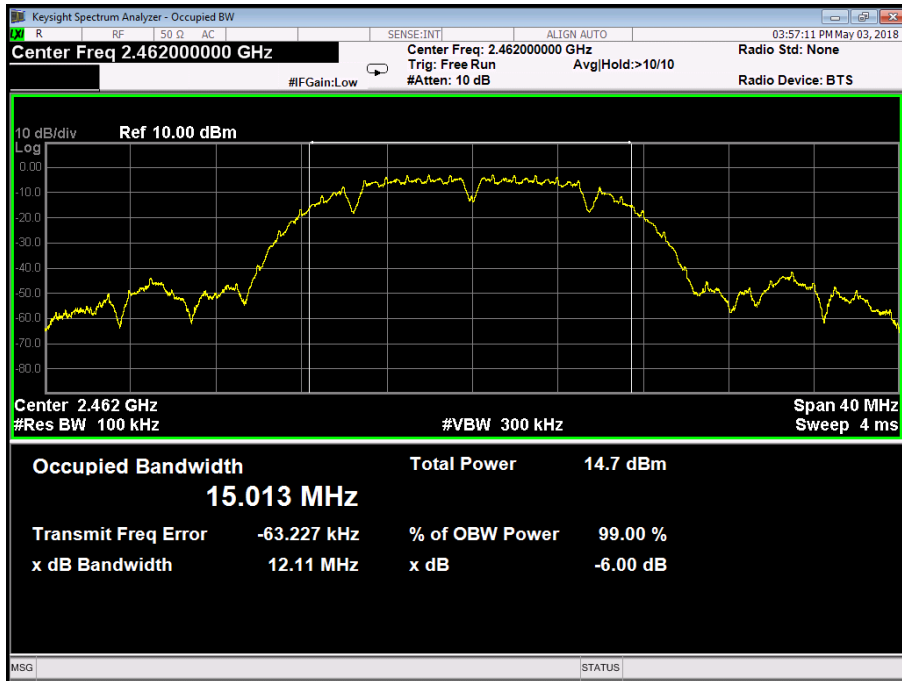

| | | | | | | | | | | | | | | | | | | | |
|--|----------------------------|----------------------------|--------------------|---------------------------|--------------------|-----------------|--|-------------------|--|--|--|----------------------------|--------------------|-----------------------|----------------|-----------------------|------------------|-------------|-----------------|
| Temperature: | 25 °C | Relative Humidity: | 55% | | | | | | | | | | | | | | | | |
| Test Voltage: | DC 3.7V | | | | | | | | | | | | | | | | | | |
| Test Mode: | TX 802.11G Mode | | | | | | | | | | | | | | | | | | |
| Channel frequency (MHz) | 6dB Bandwidth (MHz) | 99% Bandwidth (MHz) | Limit (MHz) | | | | | | | | | | | | | | | | |
| 2412 | 16.57 | 16.457 | ≥0.5 | | | | | | | | | | | | | | | | |
| 2437 | 16.56 | 16.429 | | | | | | | | | | | | | | | | | |
| 2462 | 16.56 | 16.438 | | | | | | | | | | | | | | | | | |
| 802.11G Mode | | | | | | | | | | | | | | | | | | | |
| 2412 MHz | | | | | | | | | | | | | | | | | | | |
| | | | | | | | | | | | | | | | | | | | |
| <table border="1"> <tr> <td>Occupied Bandwidth</td> <td>Total Power</td> <td colspan="2">10.5 dBm</td> </tr> <tr> <td>16.457 MHz</td> <td></td> <td></td> <td></td> </tr> <tr> <td>Transmit Freq Error</td> <td>-46.056 kHz</td> <td>% of OBW Power</td> <td>99.00 %</td> </tr> <tr> <td>x dB Bandwidth</td> <td>16.57 MHz</td> <td>x dB</td> <td>-6.00 dB</td> </tr> </table> | | | | Occupied Bandwidth | Total Power | 10.5 dBm | | 16.457 MHz | | | | Transmit Freq Error | -46.056 kHz | % of OBW Power | 99.00 % | x dB Bandwidth | 16.57 MHz | x dB | -6.00 dB |
| Occupied Bandwidth | Total Power | 10.5 dBm | | | | | | | | | | | | | | | | | |
| 16.457 MHz | | | | | | | | | | | | | | | | | | | |
| Transmit Freq Error | -46.056 kHz | % of OBW Power | 99.00 % | | | | | | | | | | | | | | | | |
| x dB Bandwidth | 16.57 MHz | x dB | -6.00 dB | | | | | | | | | | | | | | | | |

802.11G Mode

2437 MHz

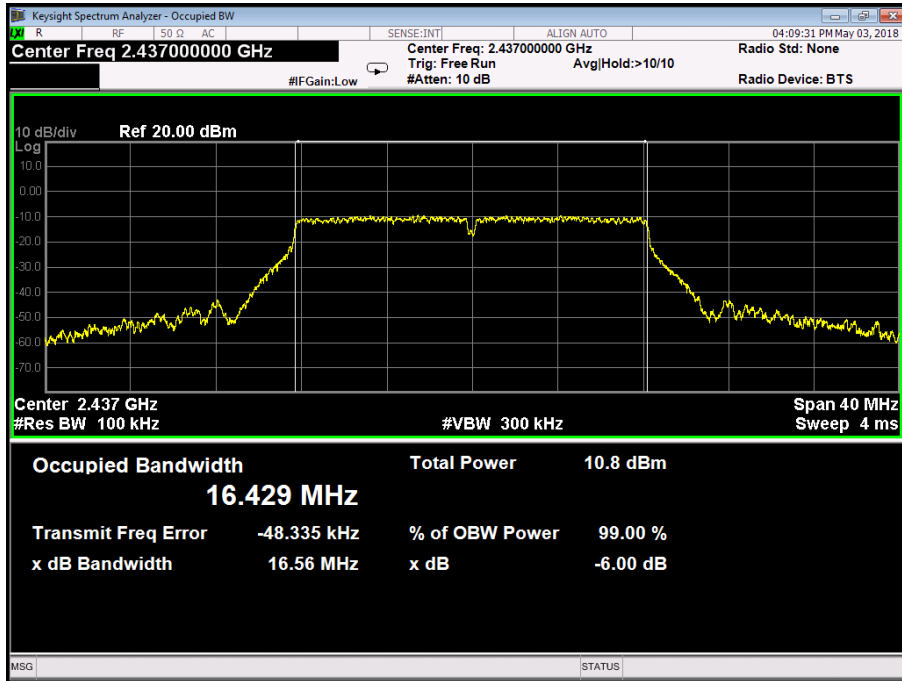

802.11G Mode

2462 MHz

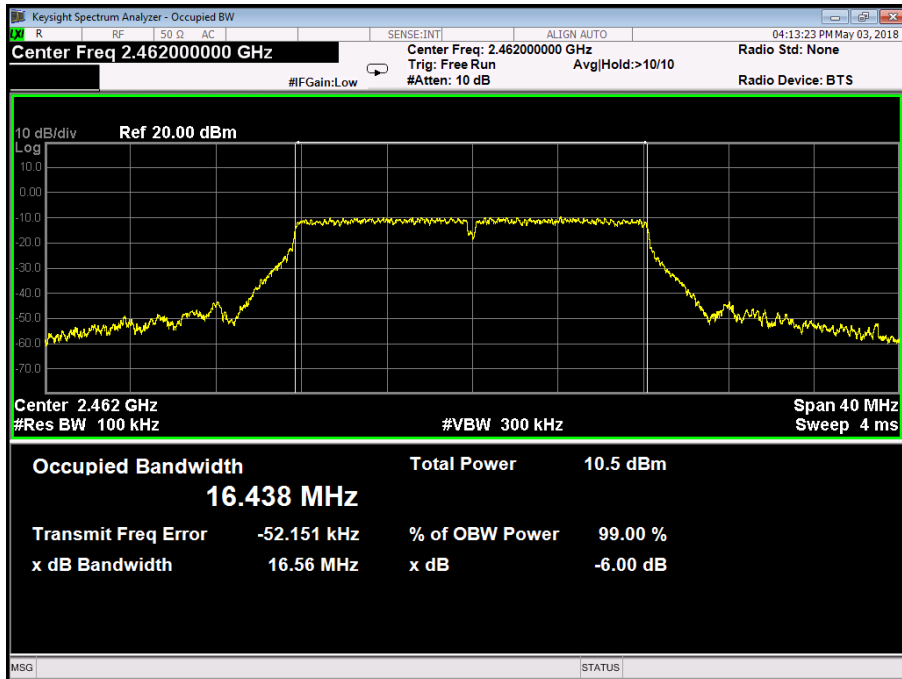

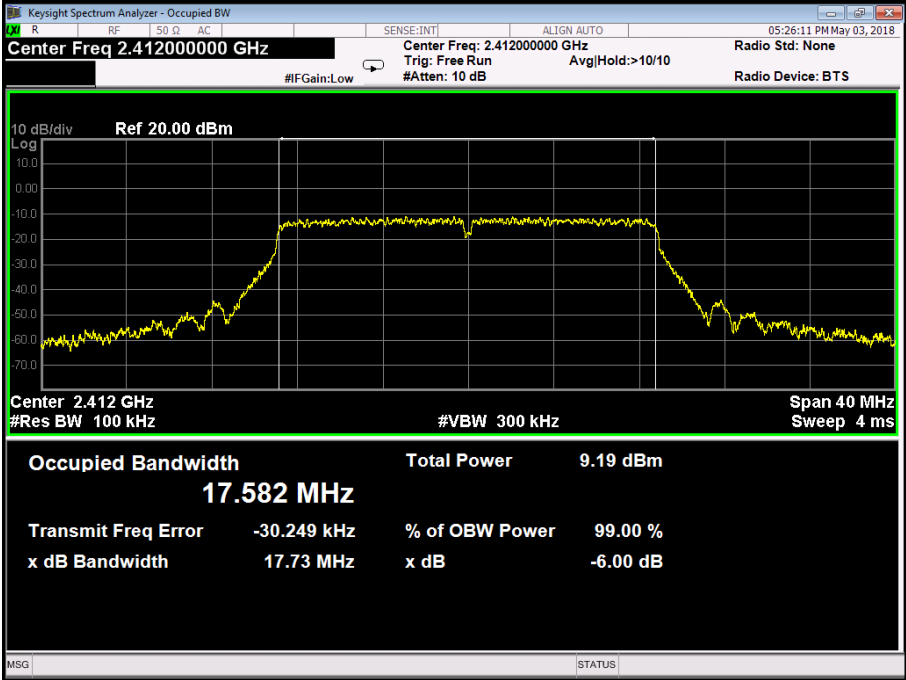
| Temperature: | 25 °C | Relative Humidity: | 55% |
|---|-----------------------|---------------------------|-------------|
| Test Voltage: | DC 3.7V | | |
| Test Mode: | TX 802.11N(HT20) Mode | | |
| Channel frequency (MHz) | 6dB Bandwidth (MHz) | 99% Bandwidth (MHz) | Limit (MHz) |
| 2412 | 17.73 | 17.582 | >=0.5 |
| 2437 | 17.66 | 17.576 | |
| 2462 | 17.67 | 17.578 | |
| 802.11N(HT20) Mode | | | |
| 2412 MHz | | | |
|  | | | |

802.11N(HT20) Mode
2437 MHz

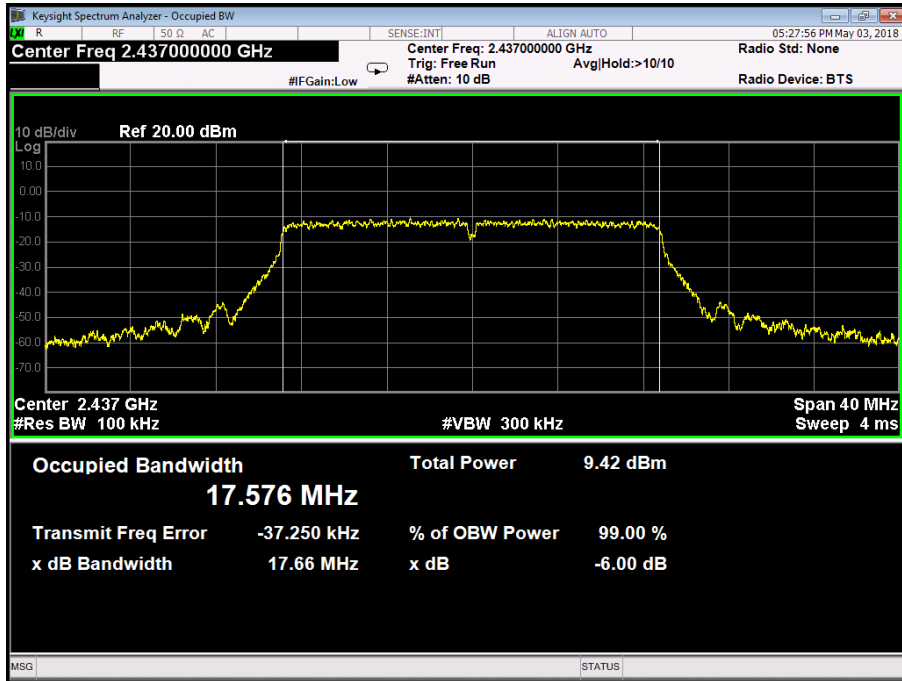

802.11N(HT20) Mode
2462 MHz

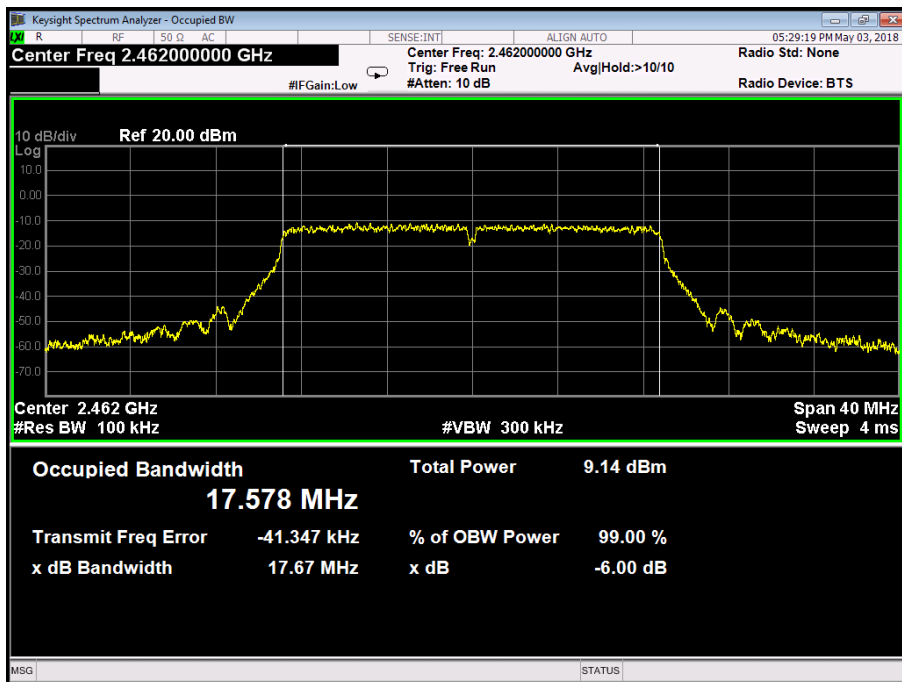

| Temperature: | 25 °C | Relative Humidity: | 55% |
|-------------------------|-----------------------|---------------------------|-------------|
| Test Voltage: | DC 3.7V | | |
| Test Mode: | TX 802.11N(HT40) Mode | | |
| Channel frequency (MHz) | 6dB Bandwidth (MHz) | 99% Bandwidth (MHz) | Limit (MHz) |
| 2422 | 36.37 | 35.969 | >=0.5 |
| 2437 | 36.40 | 35.963 | |
| 2452 | 36.40 | 35.963 | |

802.11N(HT20) Mode

2422 MHz

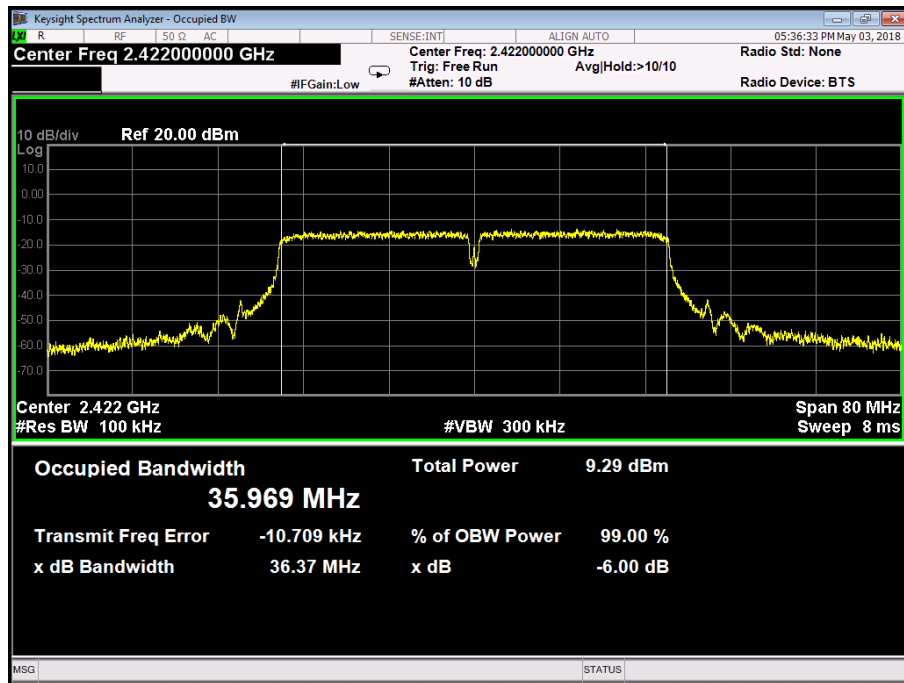

802.11N(HT20) Mode
2437 MHz

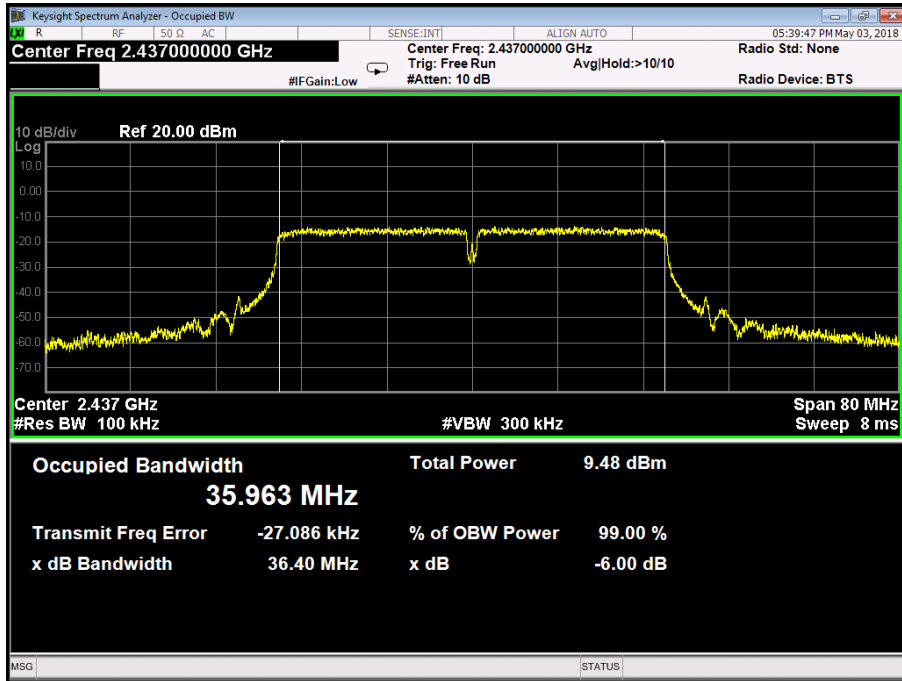

802.11N(HT20) Mode
2452 MHz

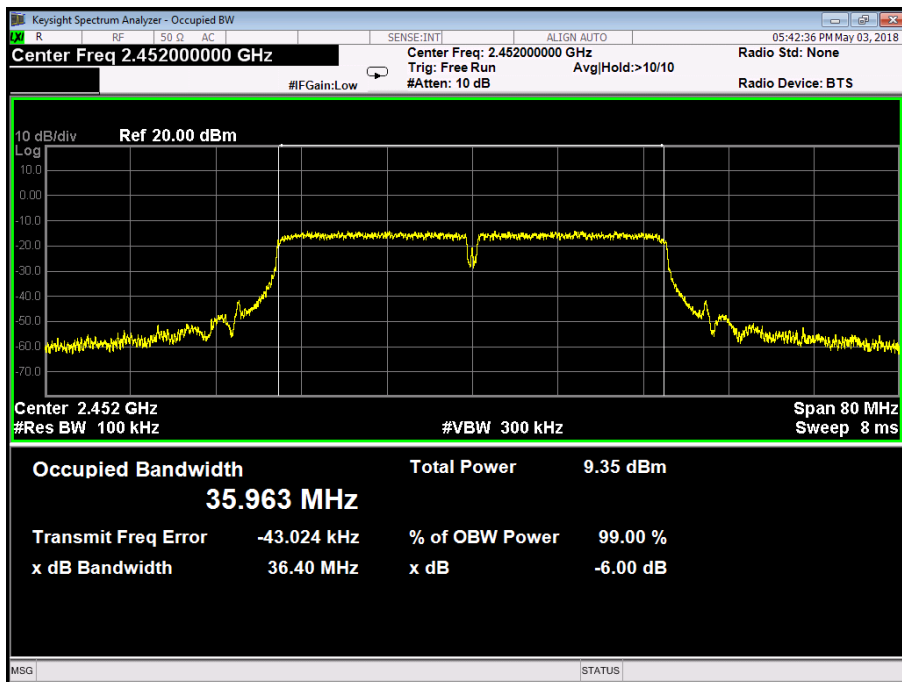

Attachment E-- Peak Output Power Test Data

| Test Conditions: | | Continuous Transmitting Mode | |
|-------------------------|-------------------------|------------------------------|-------------------------------|
| Temperature: | | 25 °C | Relative Humidity: 55% |
| Test Voltage: | | DC 3.7V | |
| Mode | Channel frequency (MHz) | Test Result (dBm) | Limit (dBm) |
| 802.11b | 2412 | 14.54 | 30 |
| | 2437 | 14.26 | |
| | 2462 | 13.67 | |
| 802.11g | 2412 | 13.78 | |
| | 2437 | 13.88 | |
| | 2462 | 13.59 | |
| 802.11n (HT20) | 2412 | 13.73 | |
| | 2437 | 12.80 | |
| | 2462 | 12.55 | |
| 802.11n (HT40) | 2422 | 13.16 | |
| | 2437 | 12.11 | |
| | 2452 | 12.64 | |
| Result: PASS | | | |

| Duty Cycle | | |
|------------------------|-------------------------|-------------|
| Mode | Channel frequency (MHz) | Test Result |
| 802.11b | 2412 | >98% |
| | 2437 | |
| | 2462 | |
| 802.11g | 2412 | |
| | 2437 | |
| | 2462 | |
| 802.11n (HT20) | 2412 | |
| | 2437 | |
| | 2462 | |
| 802.11n (HT40) | 2422 | |
| | 2437 | |
| | 2452 | |
| Please see below plots | | |

802.11 B Mode 2437 MHz

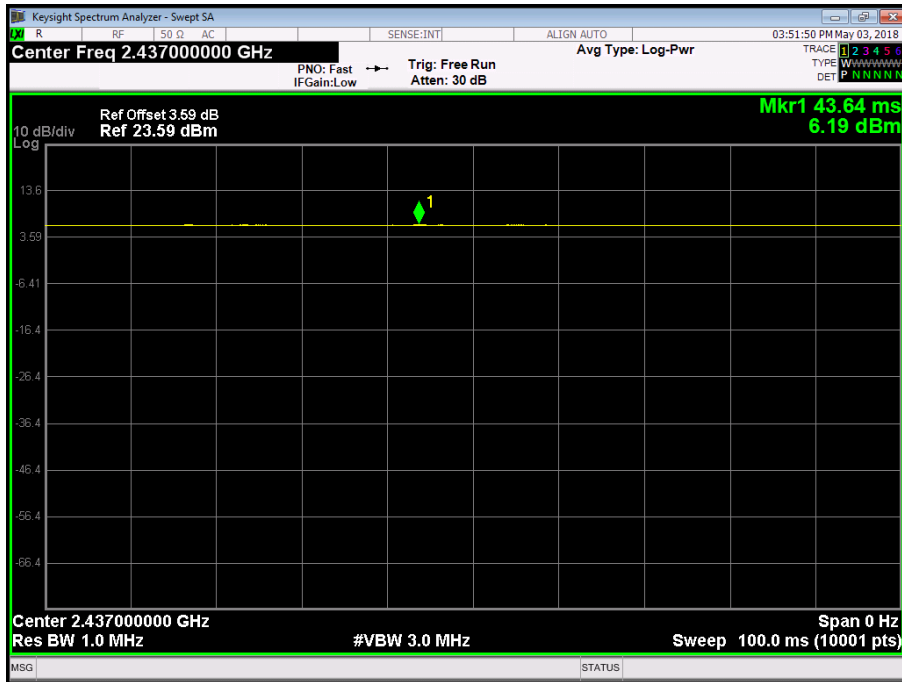

802.11 G Mode 2437 MHz

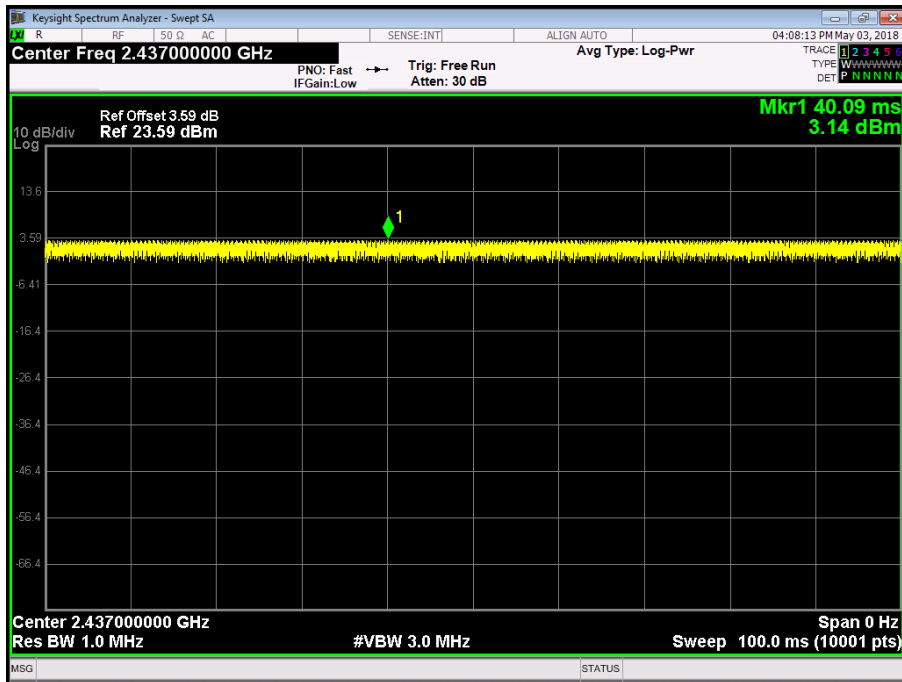

802.11 N20 Mode 2437 MHz

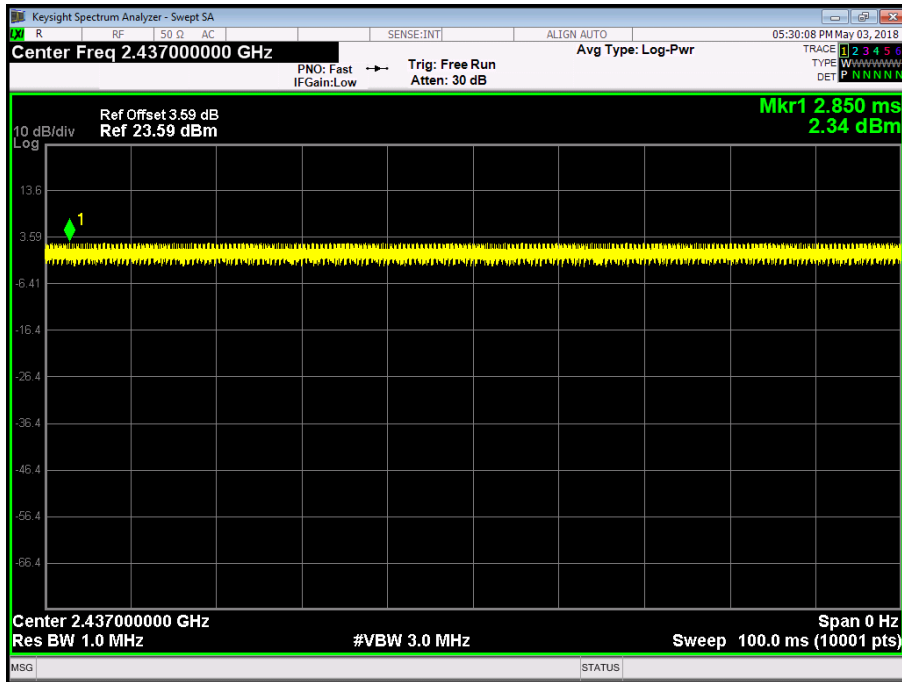

802.11 N40 Mode 2437 MHz

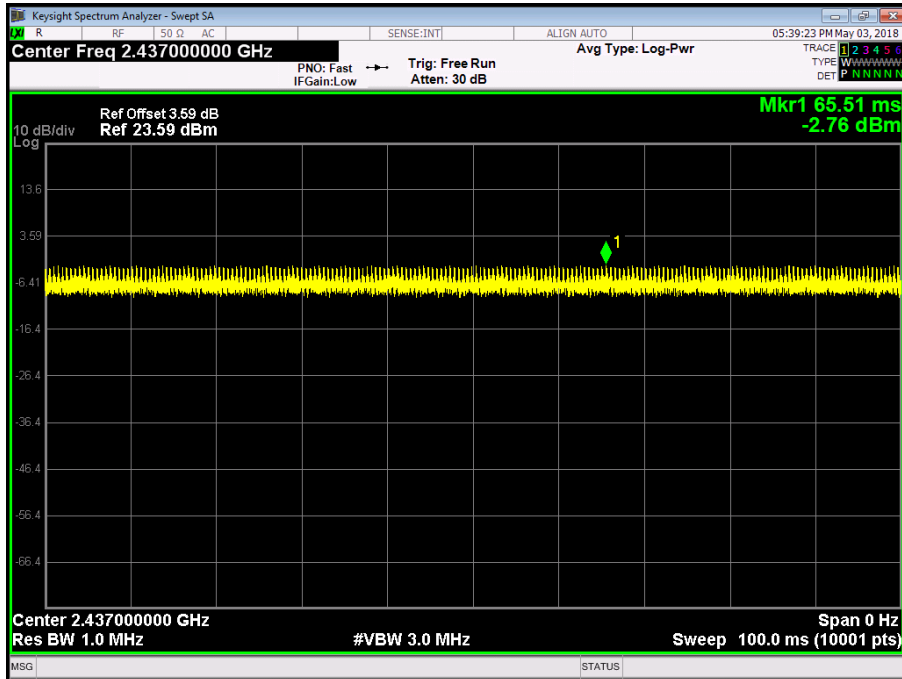

Attachment F-- Power Spectral Density Test Data

| Temperature: | 25 °C | Relative Humidity: | 55% |
|-------------------------|---------------------------|--------------------|-----|
| Test Voltage: | DC 3.7V | | |
| Test Mode: | TX 802.11B Mode | | |
| Channel Frequency (MHz) | Power Density (dBm/3 kHz) | Limit (dBm/3 kHz) | |
| 2412 | -17.121 | 8 | |
| 2437 | -17.257 | | |
| 2462 | -17.869 | | |

802.11B Mode

2412 MHz

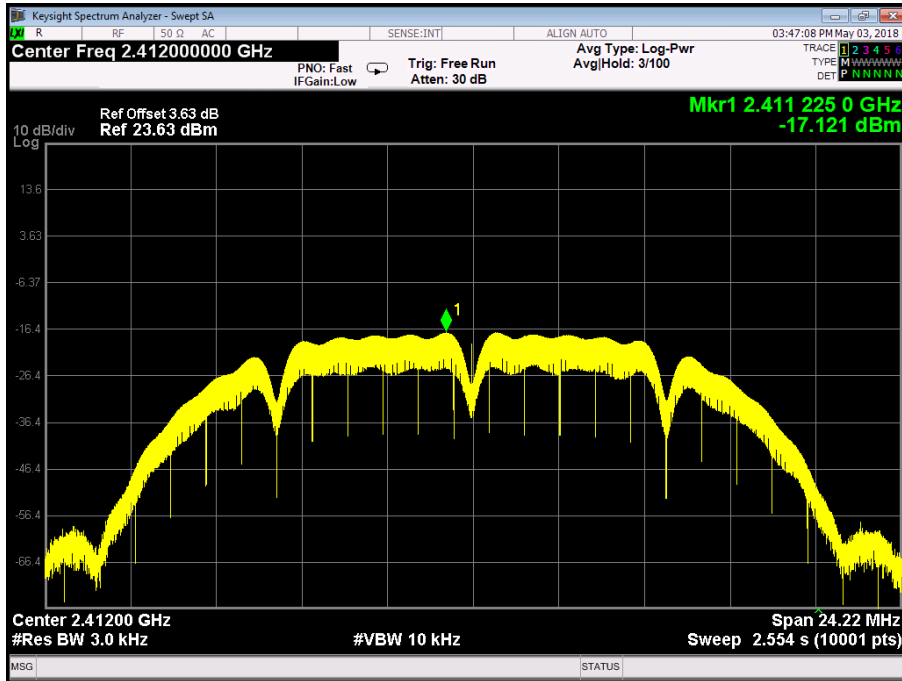

802.11B Mode

2437 MHz

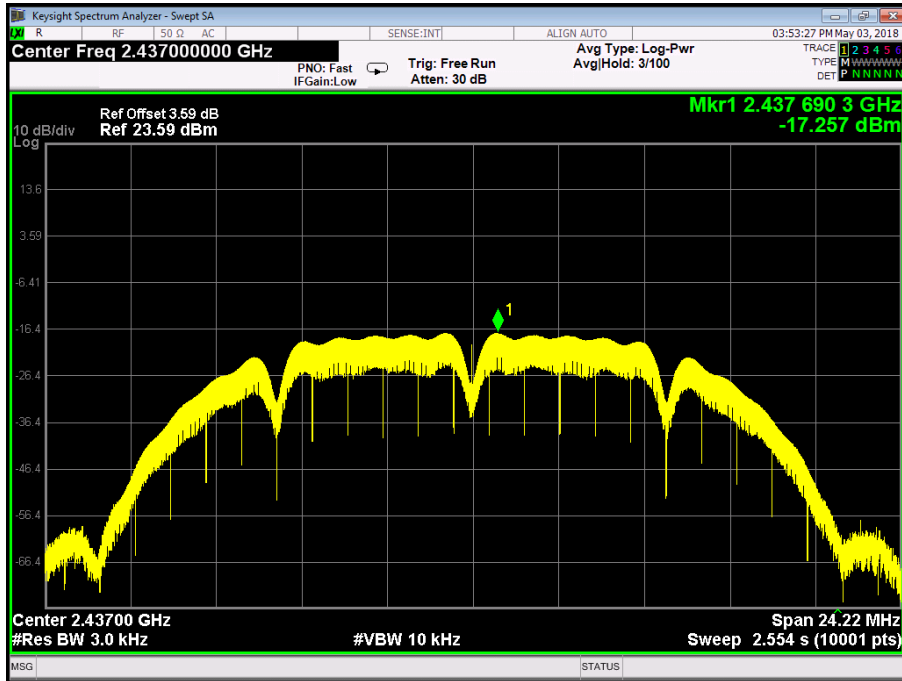

802.11B Mode

2462 MHz

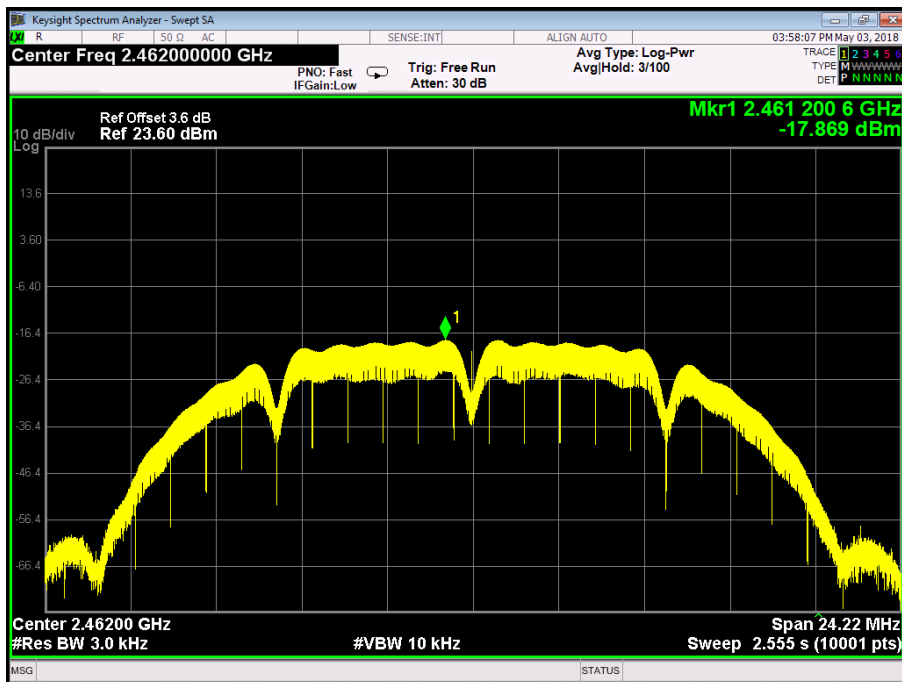

| Temperature: | 25 °C | Temperature: | 25 °C |
|-------------------------|---------------------------|-------------------|-------|
| Test Voltage: | DC 3.7V | | |
| Test Mode: | TX 802.11G Mode | | |
| Channel Frequency (MHz) | Power Density (dBm/3 kHz) | Limit (dBm/3 kHz) | |
| 2412 | -20.083 | 8 | |
| 2437 | -19.976 | | |
| 2462 | -19.813 | | |

802.11G Mode

2412 MHz

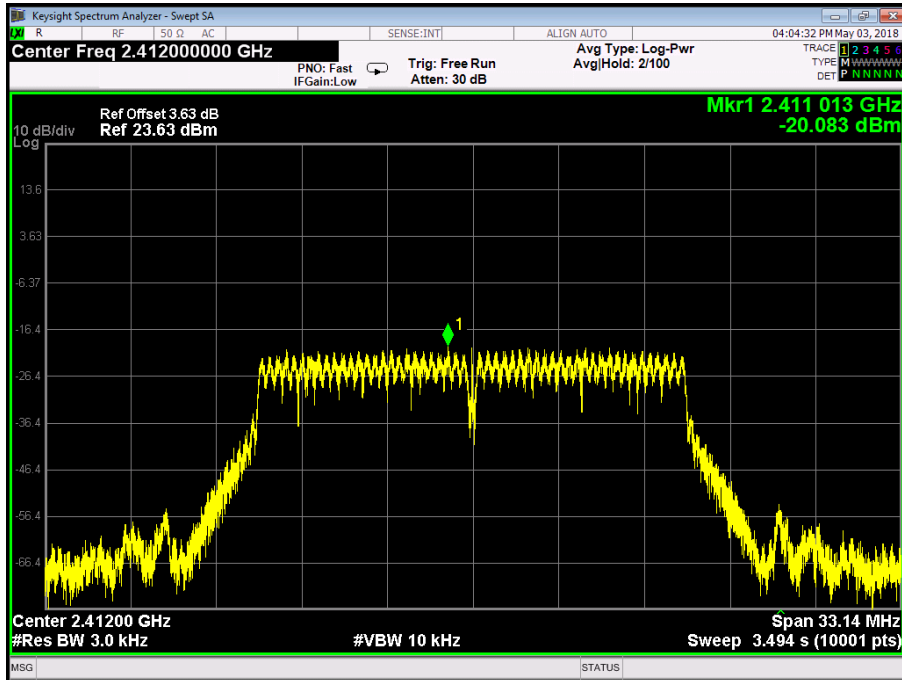

802.11G Mode

2437 MHz

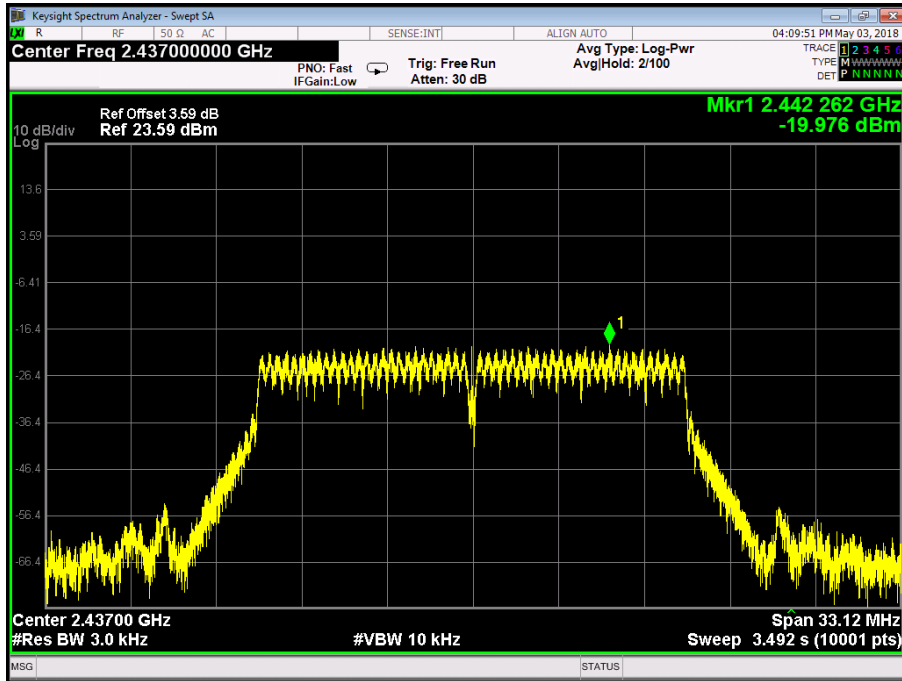

802.11G Mode

2462 MHz

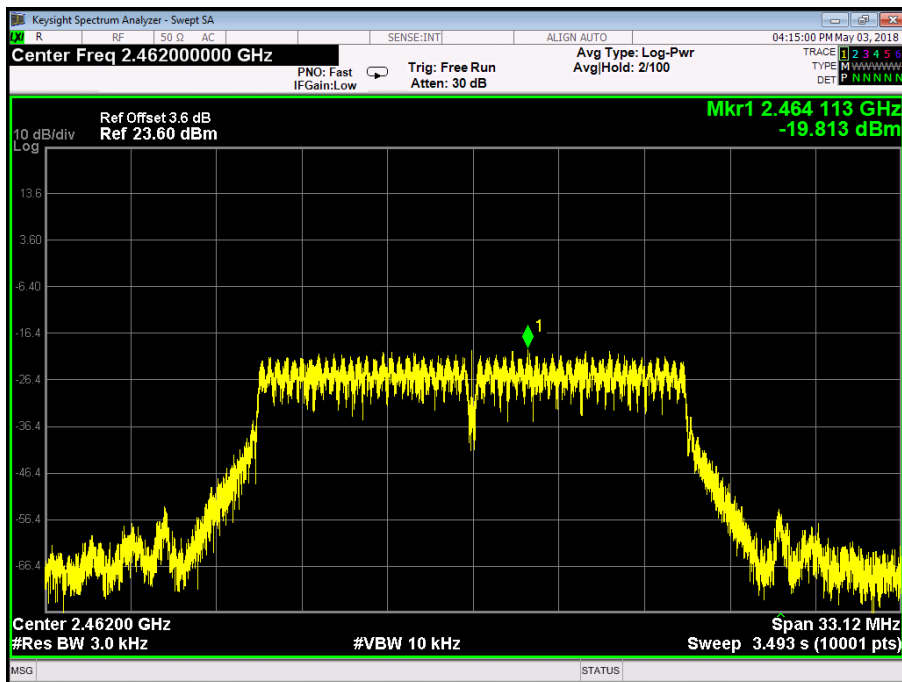

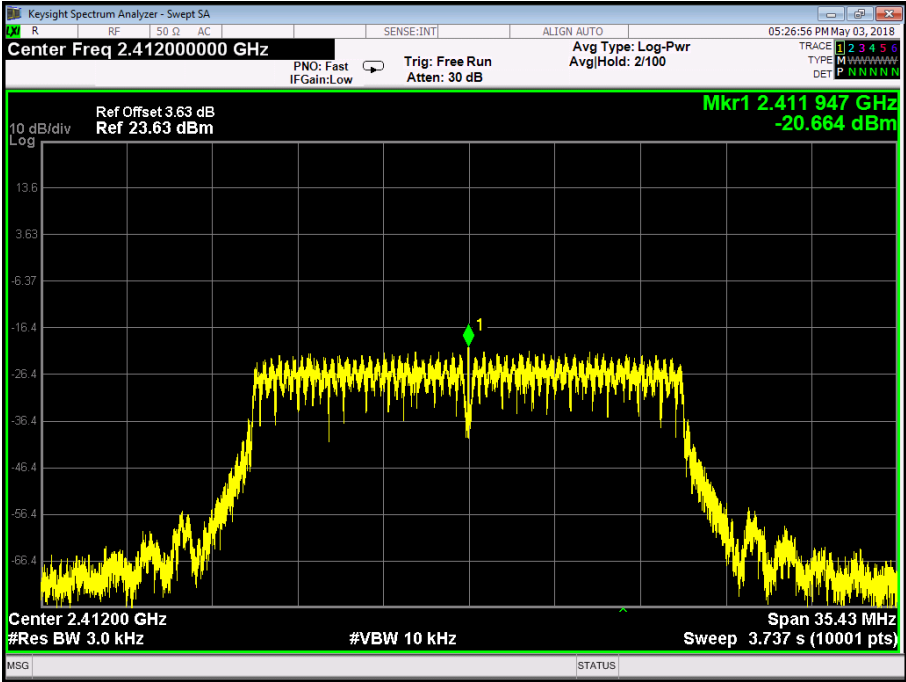
| Temperature: | 25 °C | Temperature: | 25 °C |
|---|---------------------------|---------------------|-------|
| Test Voltage: | DC 3.7V | | |
| Test Mode: | TX 802.11N(HT20) Mode | | |
| Channel Frequency (MHz) | Power Density (dBm/3 kHz) | Limit (dBm/3 kHz) | |
| 2412 | -20.664 | 8 | |
| 2437 | -20.421 | | |
| 2462 | -20.497 | | |
| 802.11N(HT20) Mode | | | |
| 2412 MHz | | | |
|  | | | |

802.11N(HT20) Mode
2437 MHz

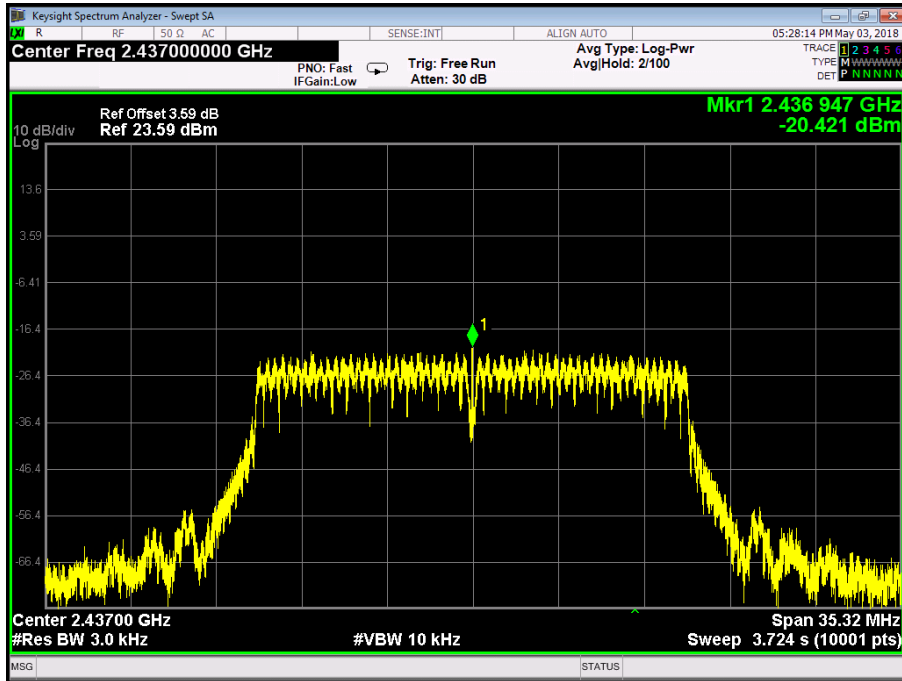

802.11N(HT20) Mode
2462 MHz

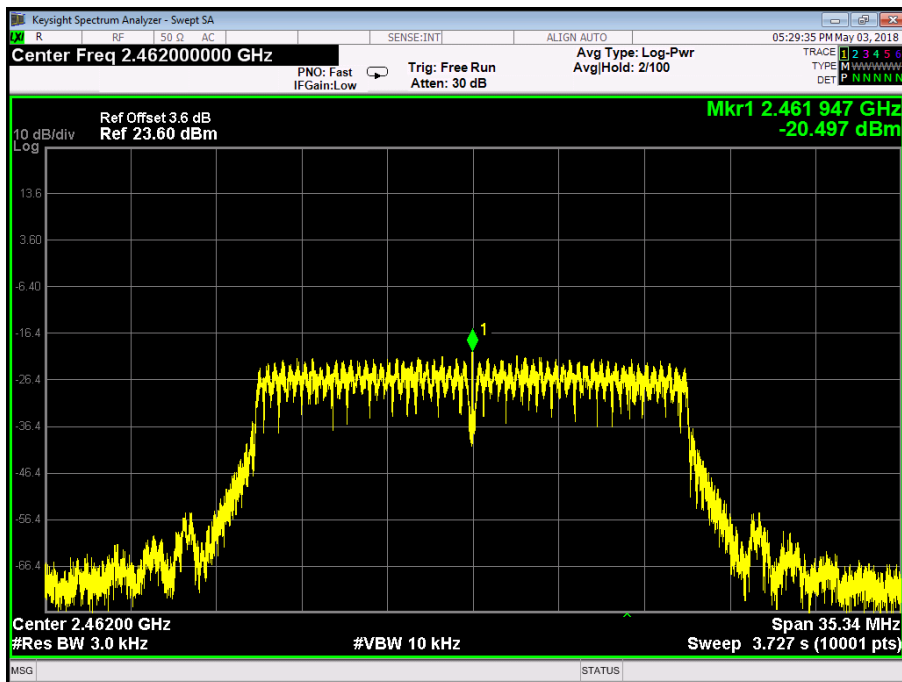

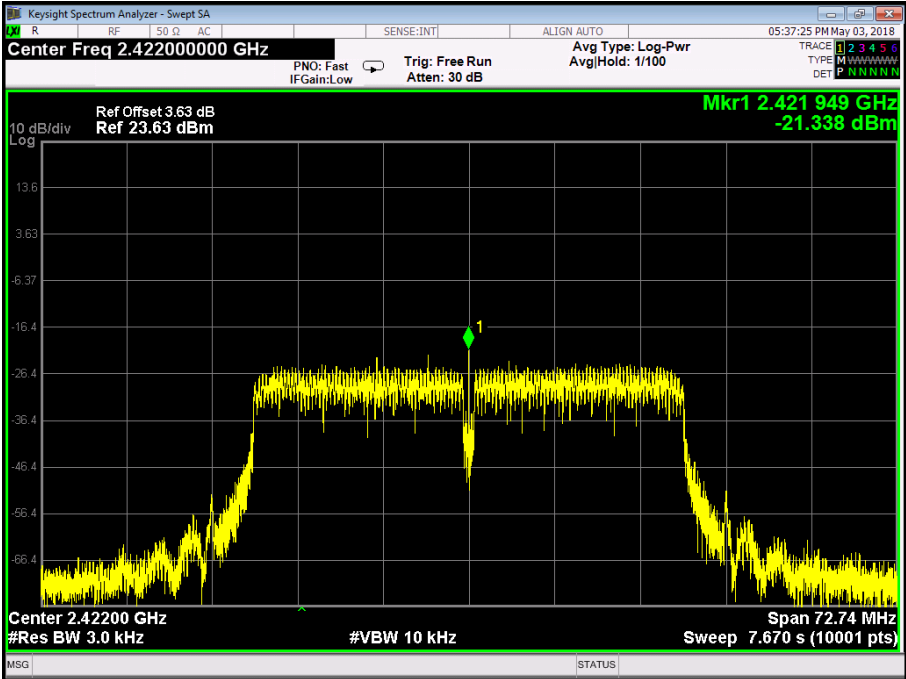
| | | | |
|---|----------------------------------|--------------------------|-------|
| Temperature: | 25 °C | Temperature: | 25 °C |
| Test Voltage: | DC 3.7V | | |
| Test Mode: | TX 802.11N(HT40) Mode | | |
| Channel Frequency (MHz) | Power Density (dBm/3 kHz) | Limit (dBm/3 kHz) | |
| 2422 | -21.338 | 8 | |
| 2437 | -21.450 | | |
| 2452 | -21.483 | | |
| 802.11N(HT40) Mode | | | |
| 2422 MHz | | | |
|  | | | |

802.11N(HT40) Mode

2437 MHz

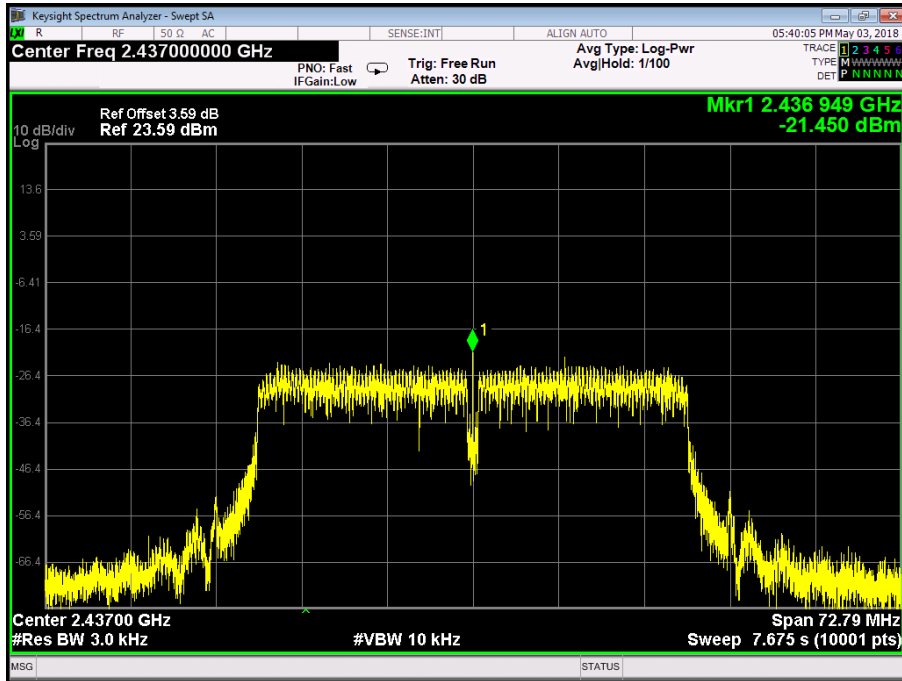

802.11N(HT40) Mode

2452 MHz

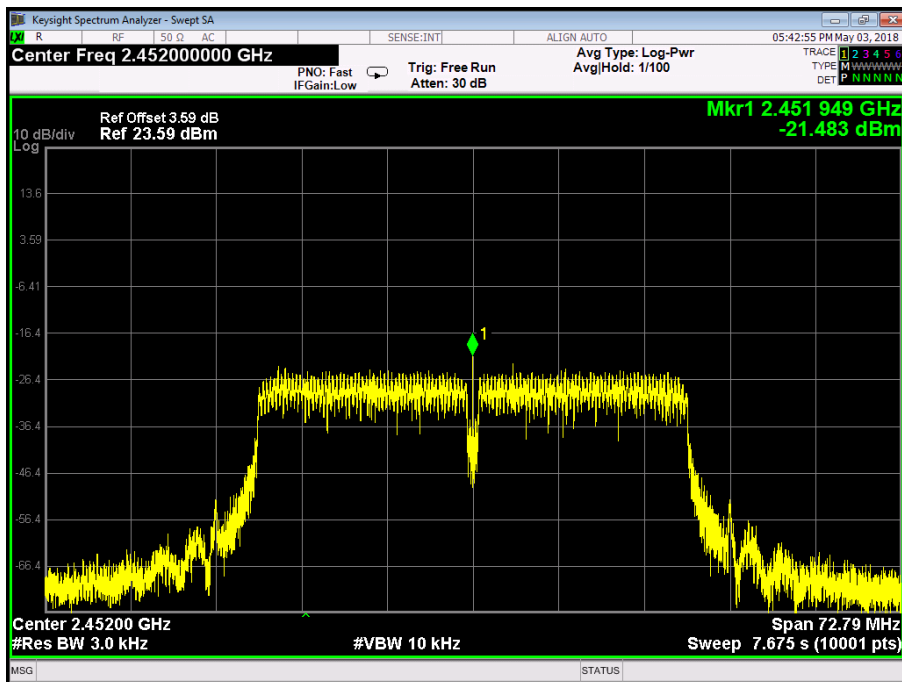

-----END OF REPORT-----