

TEST REPORT

Application No.: KSCR2210002457AT
FCC ID: 2APJ4-SRM825NNA
Applicant: MeiG Smart Technology Co., Ltd LTD.
Address of Applicant: 2nd Floor,Office Building,No.5 Lingxia Road,Fenghuang,Fuyong Street,Bao'an District,Shenzhen
Manufacturer: MeiG Smart Technology Co., Ltd LTD.
Address of Manufacturer: 2nd Floor,Office Building,No.5 Lingxia Road,Fenghuang,Fuyong Street,Bao'an District,Shenzhen

Equipment Under Test (EUT):

EUT Name: SRM825
Model No.: SRM825N-NA
Trade Mark: MEIGLink
Standard(s): FCC Part 96.47
FCC KDB 940660 D01 Part 96 CBRS Eqpt v03
WINNF-TS-0122-V1.0.2 CBRS CBSD Test Specification
WINNF-18-IN-00178 CBRS End User Device as UUT Test Guidelines

Date of Receipt: 2022-12-12
Date of Test: 2022-12-12 to 2023-02-15
Date of Issue: 2023-02-16

Test Result:	Pass*
---------------------	--------------

* In the configuration tested, the EUT complied with the standards specified above.

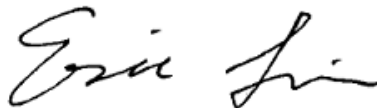

Eric Lin
Laboratory Manager



Unless otherwise agreed in writing, this document is issued by the Company subject to its General Conditions of Service printed overleaf, available on request or accessible at <https://www.sgs.com/en/Terms-and-Conditions>. Attention is drawn to the limitation of liability, indemnification and jurisdiction issues defined therein. Any holder of this document is advised that information contained hereon reflects the Company's findings at the time of its intervention only and within the limits of Client's instructions, if any. The Company's sole responsibility is to its Client and this document does not exonerate parties to a transaction from exercising all their rights and obligations under the transaction documents. This document cannot be reproduced except in full, without prior written approval of the Company. Any unauthorized alteration, forgery or falsification of the content or appearance of this document is unlawful and offenders may be prosecuted to the fullest extent of the law. Unless otherwise stated the results shown in this test report refer only to the sample(s) tested and such sample(s) are retained for 30 days only.

Attention: To check the authenticity of testing /inspection report & certificate, please contact us at telephone: (86-755) 8307 1443, or email: CN.Doccheck@sgs.com

Compliance Certification Services (Kunshan) Inc.
EMC Laboratory
No.10 Weiyue Road, Development Zone, Kunshan, Jiangsu, China 215300 t(86-512) 5735 5888 f(86-512) 57370818 www.sgs.com.cn
中国·江苏·昆山开发区伟业路10号 邮编: 215300 t(86-512) 57355888 f(86-512) 57370818 sgs.china@sgs.com

Revision Record			
Version	Description	Date	Remark
00	Original	2023-02-16	/

Authorized for issue by:			
		<i>Damon Zhou</i>	
		Damon Zhou / Project Engineer	
		<i>Eric Lin</i>	
		Eric Lin / Reviewer	



Unless otherwise agreed in writing, this document is issued by the Company subject to its General Conditions of Service printed overleaf, available on request or accessible at <https://www.sgs.com/en/Terms-and-Conditions>. Attention is drawn to the limitation of liability, indemnification and jurisdiction issues defined therein. Any holder of this document is advised that information contained hereon reflects the Company's findings at the time of its intervention only and within the limits of Client's instructions, if any. The Company's sole responsibility is to its Client and this document does not exonerate parties to a transaction from exercising all their rights and obligations under the transaction documents. This document cannot be reproduced except in full, without prior written approval of the Company. Any unauthorized alteration, forgery or falsification of the content or appearance of this document is unlawful and offenders may be prosecuted to the fullest extent of the law. Unless otherwise stated the results shown in this test report refer only to the sample(s) tested and such sample(s) are retained for 30 days only.

Attention: To check the authenticity of testing /inspection report & certificate, please contact us at telephone: (86-755) 8307 1443, or email: CN.Doccheck@sgs.com

No.10 Weiye Road, Development Zone, Kunshan, Jiangsu, China 215300 t(86-512) 5735 5888 f(86-512) 57370818 www.sgsgroup.com.cn
 中国·江苏·昆山开发区伟业路10号 邮编: 215300 t(86-512) 57355888 f(86-512) 57370818 sgs.china@sgs.com

2 Test Summary

Item	Standard	Test Case ID	Result
End User Device additional requirement	96.47	/	Pass

The UUT is an End User Device. According to the specifications of the manufacturer, it must comply with the requirements of the following standards:

Test standards:

FCC Part 96.47

FCC KDB 940660 D01 Part 96 CBRS Eqpt v03

WINNF-TS-0122-V1.0.2 CBRS CBSD Test Specification

WINNF-18-IN-00178 CBRS End User Device as UUT Test Guidelines



Unless otherwise agreed in writing, this document is issued by the Company subject to its General Conditions of Service printed overleaf, available on request or accessible at <https://www.sgs.com/en/Terms-and-Conditions>. Attention is drawn to the limitation of liability, indemnification and jurisdiction issues defined therein. Any holder of this document is advised that information contained hereon reflects the Company's findings at the time of its intervention only and within the limits of Client's instructions, if any. The Company's sole responsibility is to its Client and this document does not exonerate parties to a transaction from exercising all their rights and obligations under the transaction documents. This document cannot be reproduced except in full, without prior written approval of the Company. Any unauthorized alteration, forgery or falsification of the content or appearance of this document is unlawful and offenders may be prosecuted to the fullest extent of the law. Unless otherwise stated the results shown in this test report refer only to the sample(s) tested and such sample(s) are retained for 30 days only.

Attention: To check the authenticity of testing /inspection report & certificate, please contact us at telephone: (86-755) 8307 1443, or email: CN.Doccheck@sgs.com

No.10 Weiye Road, Development Zone, Kunshan, Jiangsu, China 215300 t(86-512) 5735 5888 f(86-512) 57370818 www.sgsgroup.com.cn
 中国·江苏·昆山开发区伟业路10号 邮编: 215300 t(86-512) 57355888 f(86-512) 57370818 sgs.china@sgs.com

3 Contents

	Page
1 COVER PAGE	1
2 TEST SUMMARY	3
3 CONTENTS	4
4 GENERAL INFORMATION	5
4.1 DETAILS OF E.U.T.	5
4.2 MEASUREMENT UNCERTAINTY	5
4.3 DESCRIPTION OF SUPPORT UNITS	5
4.4 TEST LOCATION	6
4.5 TEST FACILITY	6
4.6 DEVIATION FROM STANDARDS	6
4.7 ABNORMALITIES FROM STANDARD CONDITIONS	6
5 EQUIPMENT LIST	7
6 TEST METHOD AND ENVIRONMENT	8
6.1 END USER DEVICE CONFORMANCE AND PERFORMANCE	8
6.2 TEST ENVIRONMENT	8
6.3 TEST REQUIREMENT	8
6.4 TEST PROCEDURE	9
6.5 TEST SETUP	10
6.6 TEST RESULT	11
7 TEST SETUP PHOTOGRAPHS.....	15



Unless otherwise agreed in writing, this document is issued by the Company subject to its General Conditions of Service printed overleaf, available on request or accessible at <https://www.sgs.com/en/Terms-and-Conditions>. Attention is drawn to the limitation of liability, indemnification and jurisdiction issues defined therein. Any holder of this document is advised that information contained hereon reflects the Company's findings at the time of its intervention only and within the limits of Client's instructions, if any. The Company's sole responsibility is to its Client and this document does not exonerate parties to a transaction from exercising all their rights and obligations under the transaction documents. This document cannot be reproduced except in full, without prior written approval of the Company. Any unauthorized alteration, forgery or falsification of the content or appearance of this document is unlawful and offenders may be prosecuted to the fullest extent of the law. Unless otherwise stated the results shown in this test report refer only to the sample(s) tested and such sample(s) are retained for 30 days only.

Attention: To check the authenticity of testing /inspection report & certificate, please contact us at telephone: (86-755) 8307 1443, or email: CN.Doccheck@sgs.com

No.10 Weiye Road, Development Zone, Kunshan, Jiangsu, China 215300 t(86-512) 5735 5888 f(86-512) 57370818 www.sgsgroup.com.cn
 中国·江苏·昆山开发区伟业路10号 邮编: 215300 t(86-512) 57355888 f(86-512) 57370818 sgs.china@sgs.com

4 General Information

4.1 Details of E.U.T.

Power supply:	DC3.8V
Sample Type:	End User device
Transmitter Frequency Band:	LTE: Band 48 5G NR: n48
Transmitter Frequency Range:	3550~3700MHz
Antenna Type:	External Antenna
Hardware Version:	SRM825WN_X62_V1.01
Software Version:	SRM825N_6.0.3_EQ101
Antenna Gain:	3.1dBi

4.2 Measurement Uncertainty

No.	Item	Measurement Uncertainty
1	Radio Frequency	$\pm 7.25 \times 10^{-8}$
2	RF conducted power	$\pm 0.75\text{dB}$
3	Temperature test	$\pm 1^{\circ}\text{C}$
4	Humidity test	$\pm 3\%$
5	Supply voltages	$\pm 1.5\%$
6	Time	$\pm 3\%$

4.3 Description of Support Units

For LTE test:

Description	Manufacturer	Model No.	Serial No.
EPC	Lanner Electronics Inc.	LICA-1513A	LR202002004052
Router	TP-LINK	TL-R860+	1175379002425
Base station	Baicells	pBS31010 (FCC ID: 2AG32PBS31010)	12020002912122B0001

For 5G NR test:

Description	Manufacturer	Model No.	Serial No.
DP	Mavenir	Dell PowerEdge R740	2SVG243
Base station	Mavenir Systems, Inc.	MU44UA (FCC ID: 2AWAS-MU44UA)	LX2151MU44UA000007



Unless otherwise agreed in writing, this document is issued by the Company subject to its General Conditions of Service printed overleaf, available on request or accessible at <https://www.sgs.com/en/Terms-and-Conditions>. Attention is drawn to the limitation of liability, indemnification and jurisdiction issues defined therein. Any holder of this document is advised that information contained hereon reflects the Company's findings at the time of its intervention only and within the limits of Client's instructions, if any. The Company's sole responsibility is to its Client and this document does not exonerate parties to a transaction from exercising all their rights and obligations under the transaction documents. This document cannot be reproduced except in full, without prior written approval of the Company. Any unauthorized alteration, forgery or falsification of the content or appearance of this document is unlawful and offenders may be prosecuted to the fullest extent of the law. Unless otherwise stated the results shown in this test report refer only to the sample(s) tested and such sample(s) are retained for 30 days only.

Attention: To check the authenticity of testing /inspection report & certificate, please contact us at telephone: (86-755) 8307 1443, or email: CN.Doccheck@sgs.com

No.10 Weiye Road, Development Zone, Kunshan, Jiangsu, China 215300 t(86-512) 5735 5888 f(86-512) 57370818 www.sgs.com.cn
 中国·江苏·昆山开发区伟业路10号 邮编: 215300 t(86-512) 57355888 f(86-512) 57370818 sgs.china@sgs.com

Compliance Certification Services (Kunshan) Inc.

Report No.: KSCR221000245702

Page: 6 of 15

4.4 Test Location

All tests were performed at:

Compliance Certification Services (Kunshan) Inc.

No.10 Weiye Rd, Innovation park, Eco&Tec, Development Zone, Kunshan City, Jiangsu, China.

Tel: +86 512 5735 5888 Fax: +86 512 5737 0818

No tests were sub-contracted.

Note:

1.SGS is not responsible for wrong test results due to incorrect information (e.g., max. internal working frequency, antenna gain, cable loss, etc) is provided by the applicant. (If applicable).

2.SGS is not responsible for the authenticity, integrity and the validity of the conclusion based on results of the data provided by applicant. (If applicable).

4.5 Test Facility

The test facility is recognized, certified, or accredited by the following organizations:

• A2LA

Compliance Certification Services (Kunshan) Inc. is accredited by the American Association for Laboratory Accreditation (A2LA). Certificate No. 2541.01.

• FCC

Compliance Certification Services (Kunshan) Inc. has been recognized as an accredited testing laboratory. Designation Number: CN1172.

• ISED

Compliance Certification Services (Kunshan) Inc. has been recognized by Innovation, Science and Economic Development Canada (ISED) as an accredited testing laboratory. Company Number: 2324E

• VCCI

The 3m and 10m Semi-anechoic chamber and Shielded Room of Compliance Certification Services (Kunshan) Inc. has been registered in accordance with the Regulations for Voluntary Control Measures with Registration No.: R-20134, R-11600, C-11707, T-11499, G-10216 respectively.

4.6 Deviation from Standards

None

4.7 Abnormalities from Standard Conditions

None



Unless otherwise agreed in writing, this document is issued by the Company subject to its General Conditions of Service printed overleaf, available on request or accessible at <https://www.sgs.com/en/Terms-and-Conditions>. Attention is drawn to the limitation of liability, indemnification and jurisdiction issues defined therein. Any holder of this document is advised that information contained hereon reflects the Company's findings at the time of its intervention only and within the limits of Client's instructions, if any. The Company's sole responsibility is to its Client and this document does not exonerate parties to a transaction from exercising all their rights and obligations under the transaction documents. This document cannot be reproduced except in full, without prior written approval of the Company. Any unauthorized alteration, forgery or falsification of the content or appearance of this document is unlawful and offenders may be prosecuted to the fullest extent of the law. Unless otherwise stated the results shown in this test report refer only to the sample(s) tested and such sample(s) are retained for 30 days only.

Attention: To check the authenticity of testing /inspection report & certificate, please contact us at telephone: (86-755) 8307 1443, or email: CN.Doccheck@sgs.com

No.10 Weiye Road, Development Zone, Kunshan, Jiangsu, China 215300 t(86-512) 5735 5888 f(86-512) 57370818 www.sgsgroup.com.cn
中国·江苏·昆山开发区伟业路10号 邮编: 215300 t(86-512) 57355888 f(86-512) 57370818 sgs.china@sgs.com

5 Equipment List

Test Equipment	Manufacturer	Model No.	Inventory No.	Cal. Date (yyyy-mm-dd)	Cal. Due date (yyyy-mm-dd)
Laptop	Lenovo	Y510P	HFL000026	N/A	N/A
Spectrum Analyzer	KEYSIGHT	N9020A	KUS2001M00 1-2	2022/8/22	2023/8/21
Shield Room	YanChuang	N/A	KS301115-2	N/A	N/A
Coaxial Cable	Thermax	N/A	13	2022/9/16	2023/9/15
Attenuator	Mini-Circuits	NAT-6-2W	15542-1	N.C.R.	N.C.R.
Humidity / Temperature Indicator	Renke	RS-WS-N01-6J	1032844	2022/4/1	2023/3/31



Unless otherwise agreed in writing, this document is issued by the Company subject to its General Conditions of Service printed overleaf, available on request or accessible at <https://www.sgs.com/en/Terms-and-Conditions>. Attention is drawn to the limitation of liability, indemnification and jurisdiction issues defined therein. Any holder of this document is advised that information contained hereon reflects the Company's findings at the time of its intervention only and within the limits of Client's instructions, if any. The Company's sole responsibility is to its Client and this document does not exonerate parties to a transaction from exercising all their rights and obligations under the transaction documents. This document cannot be reproduced except in full, without prior written approval of the Company. Any unauthorized alteration, forgery or falsification of the content or appearance of this document is unlawful and offenders may be prosecuted to the fullest extent of the law. Unless otherwise stated the results shown in this test report refer only to the sample(s) tested and such sample(s) are retained for 30 days only.

Attention: To check the authenticity of testing /inspection report & certificate, please contact us at telephone: (86-755) 8307 1443, or email: CN.Doccheck@sgs.com

No. 10 Weiye Road, Development Zone, Kunshan, Jiangsu, China 215300 t(86-512) 5735 5888 f(86-512) 57370818 www.sgsgroup.com.cn
 中国·江苏·昆山开发区伟业路10号 邮编: 215300 t(86-512) 57355888 f(86-512) 57370818 sgs.china@sgs.com

6 Test Method and Environment

6.1 End User Device Conformance and Performance

Test Requirement: FCC Part 96.47

Test Method: WINNF-18-IN-00178 CBRS End User Device as UUT Test Guidelines

6.2 Test Environment

Environmental Conditions: 25°C, 65%RH

6.3 Test Requirement

FCC Part 96.47

- a). End User Devices may operate only if they can positively receive and decode an authorization signal transmitted by a CBSD, including the frequencies and power limits for their operation.
- b). An End User Device must discontinue operations, change frequencies, or change its operational power level within 10 seconds of receiving instructions from its associated CBSD.



Unless otherwise agreed in writing, this document is issued by the Company subject to its General Conditions of Service printed overleaf, available on request or accessible at <https://www.sgs.com/en/Terms-and-Conditions>. Attention is drawn to the limitation of liability, indemnification and jurisdiction issues defined therein. Any holder of this document is advised that information contained hereon reflects the Company's findings at the time of its intervention only and within the limits of Client's instructions, if any. The Company's sole responsibility is to its Client and this document does not exonerate parties to a transaction from exercising all their rights and obligations under the transaction documents. This document cannot be reproduced except in full, without prior written approval of the Company. Any unauthorized alteration, forgery or falsification of the content or appearance of this document is unlawful and offenders may be prosecuted to the fullest extent of the law. Unless otherwise stated the results shown in this test report refer only to the sample(s) tested and such sample(s) are retained for 30 days only.

Attention: To check the authenticity of testing /inspection report & certificate, please contact us at telephone: (86-755) 8307 1443, or email: CN.Doccheck@sgs.com

No. 10 Weiye Road, Development Zone, Kunshan, Jiangsu, China 215300 t(86-512) 5735 5888 f(86-512) 57370818 www.sgsgroup.com.cn
中国·江苏·昆山开发区伟业路10号 邮编: 215300 t(86-512) 57355888 f(86-512) 57370818 sgs.china@sgs.com

6.4 Test Procedure

Following procedure can be done by applying WINNF-TS-0122-V1.0.2 CBRS CBSD Test Specification, use the certified LTE Base station CBSD (FCC ID: 2AG32PBS31010) and 5G NR Base station CBSD (FCC ID: 2AWAS-MU44UA) as companion device to show compliance with Part 96.47 requirement for End User Device (EUD):

For LTE:

1. Setup with frequency 3550-3570MHz and power level 14dBm/MHz;
2. Enable CBSD service ;
3. Check EUD Tx Frequency and power;
4. Disable AP service ;
5. Check EUD stops transmission within 10seconds;
6. Setup with 3570-3590MHz & power level 8dBm/MHz;
7. Enable CBSD service;
8. Check EUD Tx Frequency and power;
9. Disable CBSD service;
10. Check EUD stops transmission within 10seconds.

For 5G NR:

1. Setup with frequency 3590-3610MHz and power level 14dBm/MHz;
2. Enable CBSD service ;
3. Check EUD Tx Frequency and power;
4. Disable AP service ;
5. Check EUD stops transmission within 10seconds;
6. Setup with 3640-3660MHz & power level 8dBm/MHz;
7. Enable CBSD service;
8. Check EUD Tx Frequency and power;
9. Disable CBSD service;
10. Check EUD stops transmission within 10seconds.



Unless otherwise agreed in writing, this document is issued by the Company subject to its General Conditions of Service printed overleaf, available on request or accessible at <https://www.sgs.com/en/Terms-and-Conditions>. Attention is drawn to the limitation of liability, indemnification and jurisdiction issues defined therein. Any holder of this document is advised that information contained hereon reflects the Company's findings at the time of its intervention only and within the limits of Client's instructions, if any. The Company's sole responsibility is to its Client and this document does not exonerate parties to a transaction from exercising all their rights and obligations under the transaction documents. This document cannot be reproduced except in full, without prior written approval of the Company. Any unauthorized alteration, forgery or falsification of the content or appearance of this document is unlawful and offenders may be prosecuted to the fullest extent of the law. Unless otherwise stated the results shown in this test report refer only to the sample(s) tested and such sample(s) are retained for 30 days only.

Attention: To check the authenticity of testing /inspection report & certificate, please contact us at telephone: (86-755) 8307 1443, or email: CN.Doccheck@sgs.com

No.10 Weiye Road, Development Zone, Kunshan, Jiangsu, China 215300 t(86-512) 5735 5888 f(86-512) 57370818 www.sgsgroup.com.cn
中国·江苏·昆山开发区伟业路10号 邮编: 215300 t(86-512) 57355888 f(86-512) 57370818 sgs.china@sgs.com

6.5 Test Setup

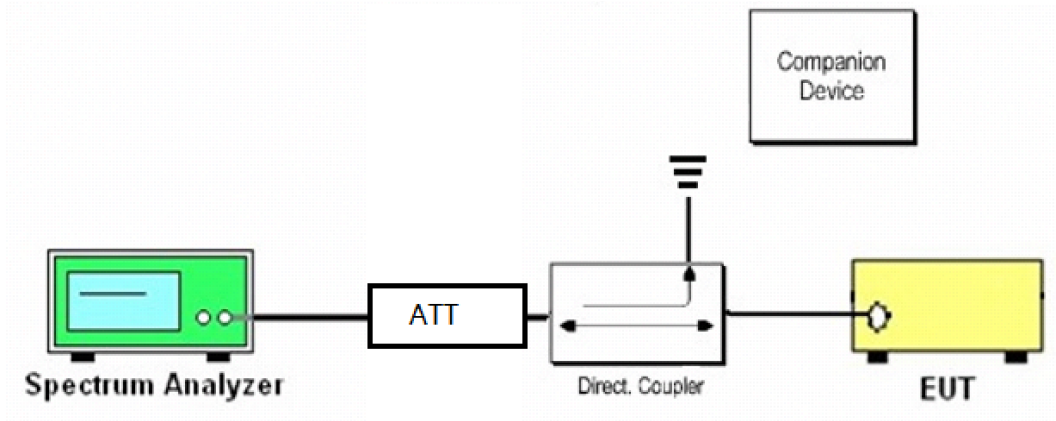

For LTE:

End User Device as UUT, the companion device is certified CBRS (FCC ID: 2AG32PBS31010)

For 5G NR:

End User Device as UUT, the companion device is certified CBRS (FCC ID: WBKRU4370)



Unless otherwise agreed in writing, this document is issued by the Company subject to its General Conditions of Service printed overleaf, available on request or accessible at <https://www.sgs.com/en/Terms-and-Conditions>. Attention is drawn to the limitation of liability, indemnification and jurisdiction issues defined therein. Any holder of this document is advised that information contained hereon reflects the Company's findings at the time of its intervention only and within the limits of Client's instructions, if any. The Company's sole responsibility is to its Client and this document does not exonerate parties to a transaction from exercising all their rights and obligations under the transaction documents. This document cannot be reproduced except in full, without prior written approval of the Company. Any unauthorized alteration, forgery or falsification of the content or appearance of this document is unlawful and offenders may be prosecuted to the fullest extent of the law. Unless otherwise stated the results shown in this test report refer only to the sample(s) tested and such sample(s) are retained for 30 days only.

Attention: To check the authenticity of testing /inspection report & certificate, please contact us at telephone: (86-755) 8307 1443, or email: CN.Doccheck@sgs.com

No. 10 Weiye Road, Development Zone, Kunshan, Jiangsu, China 215300 t(86-512) 5735 5888 f(86-512) 57370818 www.sgsgroup.com.cn
 中国·江苏·昆山开发区伟业路10号 邮编: 215300 t(86-512) 57355888 f(86-512) 57370818 sgs.china@sgs.com

6.6 Test Result

For LTE

[Step 1] Setup with frequency 3550-3570MHz and power level 14dBm/MHz

[Step 3] Check EUD Tx Frequency and power

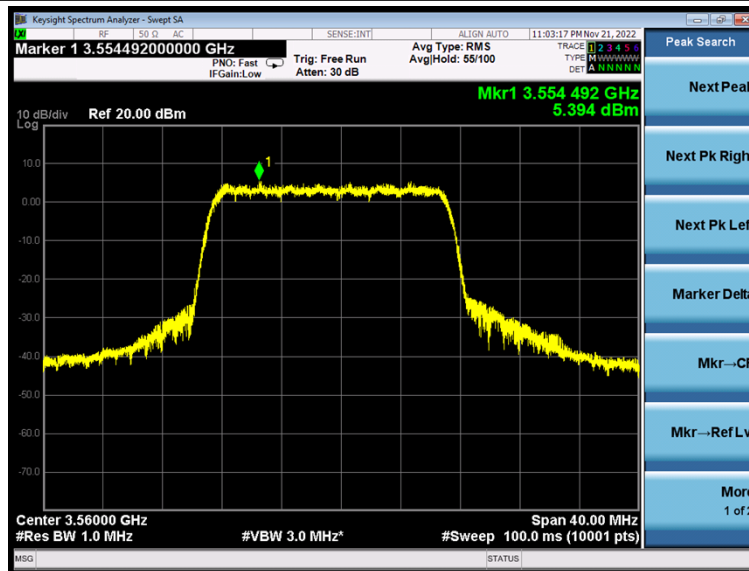

EIRP PSD=5.394+3.1-6=2.494dBm/MHz, Antenna gain is 3.1dBi,the path loss is 6dB

[Step 5] EUD stops transmission within 10 seconds of receiving instructions from its associated CBSB.

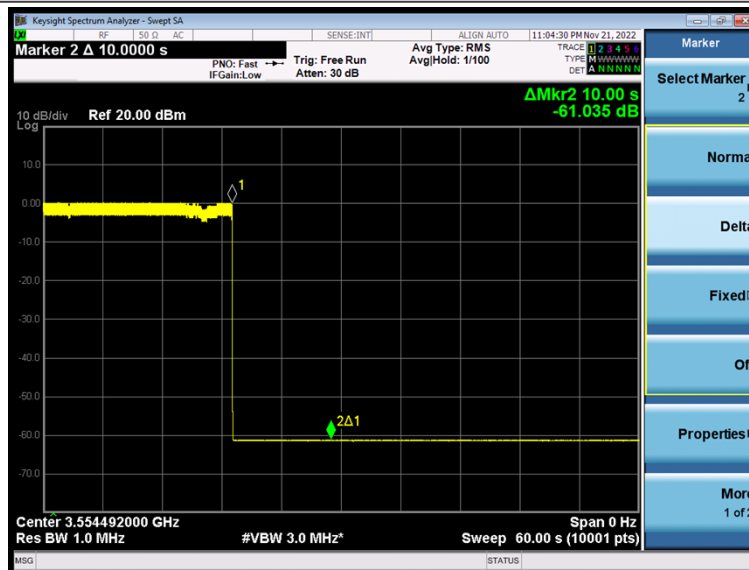

Unless otherwise agreed in writing, this document is issued by the Company subject to its General Conditions of Service printed overleaf, available on request or accessible at <https://www.sgs.com/en/Terms-and-Conditions>. Attention is drawn to the limitation of liability, indemnification and jurisdiction issues defined therein. Any holder of this document is advised that information contained hereon reflects the Company's findings at the time of its intervention only and within the limits of Client's instructions, if any. The Company's sole responsibility is to its Client and this document does not exonerate parties to a transaction from exercising all their rights and obligations under the transaction documents. This document cannot be reproduced except in full, without prior written approval of the Company. Any unauthorized alteration, forgery or falsification of the content or appearance of this document is unlawful and offenders may be prosecuted to the fullest extent of the law. Unless otherwise stated the results shown in this test report refer only to the sample(s) tested and such sample(s) are retained for 30 days only.

Attention: To check the authenticity of testing /inspection report & certificate, please contact us at telephone: (86-755) 8307 1443, or email: CN.Doccheck@sgs.com

No.10 Weiye Road, Development Zone, Kunshan, Jiangsu, China 215300 t(86-512) 5735 5888 f(86-512) 57370818 www.sgs.com.cn
 中国·江苏·昆山开发区伟业路10号 邮编: 215300 t(86-512) 57355888 f(86-512) 57370818 sgs.china@sgs.com

[Step 6] Setup with frequency 3570-3590MHz and power level 8dBm/MHz

[Step 8] Check EUD Tx Frequency and power

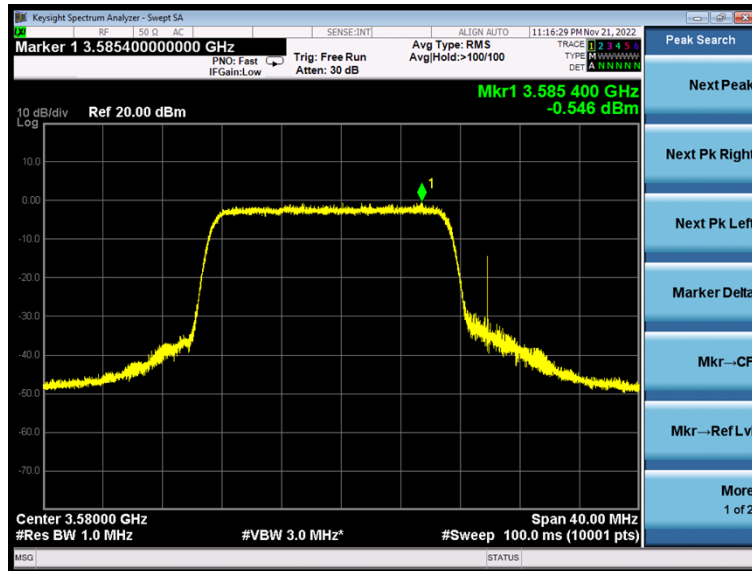

EIRP PSD=-0.546+3.1-6=-3.446dBm/MHz, Antenna gain is 3.1dBi, the path loss is 6dB

[Step 10] EUD stops transmission within 10 seconds of receiving instructions from its associated CBSD.

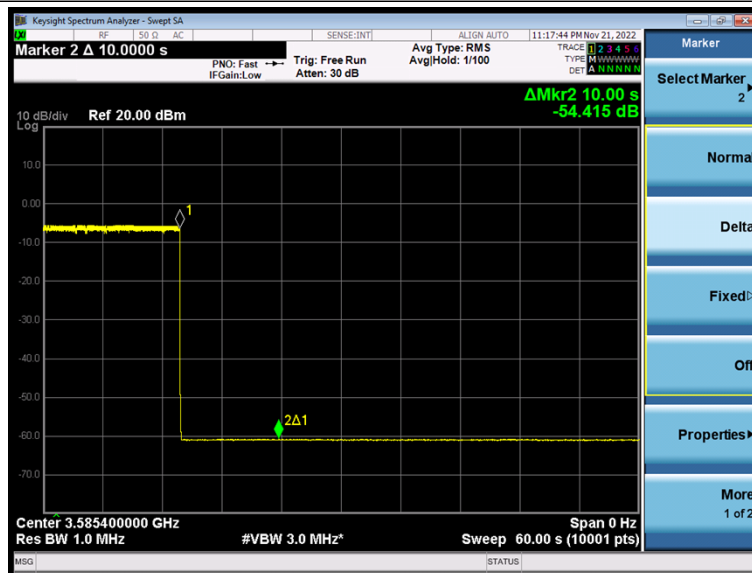

Unless otherwise agreed in writing, this document is issued by the Company subject to its General Conditions of Service printed overleaf, available on request or accessible at <https://www.sgs.com/en/Terms-and-Conditions>. Attention is drawn to the limitation of liability, indemnification and jurisdiction issues defined therein. Any holder of this document is advised that information contained hereon reflects the Company's findings at the time of its intervention only and within the limits of Client's instructions, if any. The Company's sole responsibility is to its Client and this document does not exonerate parties to a transaction from exercising all their rights and obligations under the transaction documents. This document cannot be reproduced except in full, without prior written approval of the Company. Any unauthorized alteration, forgery or falsification of the content or appearance of this document is unlawful and offenders may be prosecuted to the fullest extent of the law. Unless otherwise stated the results shown in this test report refer only to the sample(s) tested and such sample(s) are retained for 30 days only.

Attention: To check the authenticity of testing /inspection report & certificate, please contact us at telephone: (86-755) 8307 1443, or email: CN.Doccheck@sgs.com

No.10 Weiye Road, Development Zone, Kunshan, Jiangsu, China 215300 t(86-512) 5735 5888 f(86-512) 57370818 www.sgsgroup.com.cn
 中国·江苏·昆山开发区伟业路10号 邮编: 215300 t(86-512) 57355888 f(86-512) 57370818 sgs.china@sgs.com

[Step 6] Setup with frequency 3640-3660MHz and power level 8dBm/MHz

[Step 8] Check EUD Tx Frequency and power

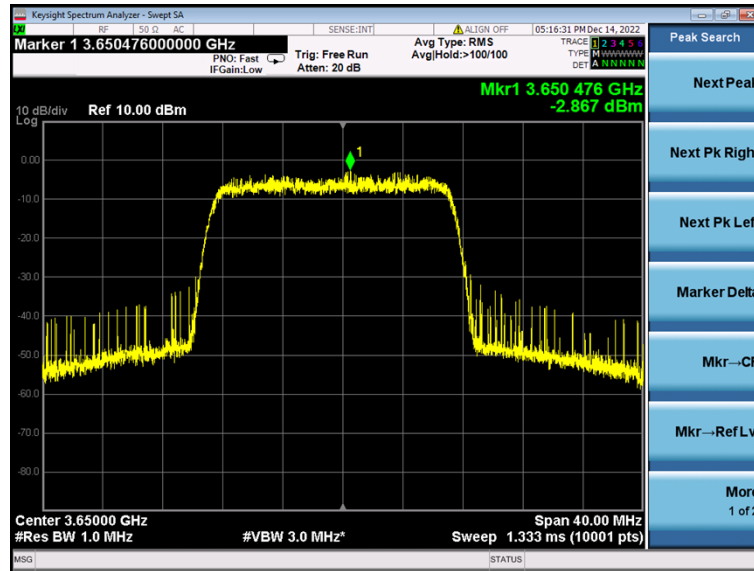

EIRP PSD=-2.867+3.1-6=-5.767dBm/MHz, Antenna gain is 3.1dBi,the path loss is 6dB

[Step 10] EUD stops transmission within 10 seconds of receiving instructions from its associated CBSD.

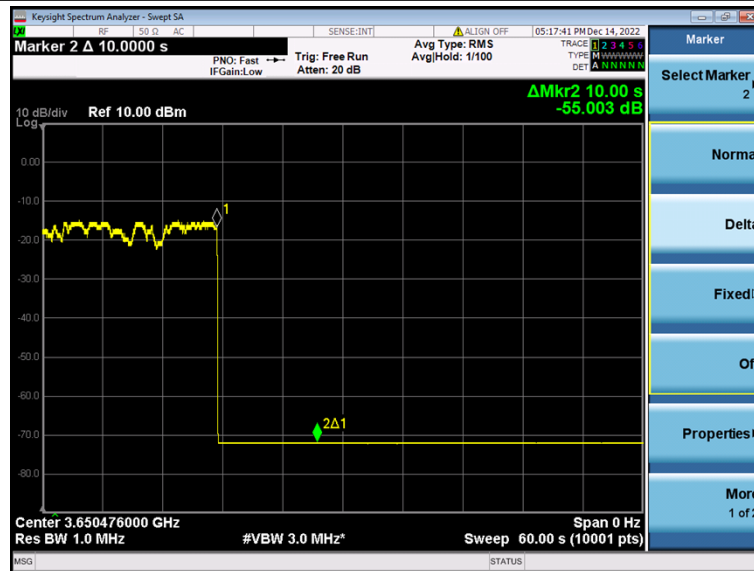

Unless otherwise agreed in writing, this document is issued by the Company subject to its General Conditions of Service printed overleaf, available on request or accessible at <https://www.sgs.com/en/Terms-and-Conditions>. Attention is drawn to the limitation of liability, indemnification and jurisdiction issues defined therein. Any holder of this document is advised that information contained hereon reflects the Company's findings at the time of its intervention only and within the limits of Client's instructions, if any. The Company's sole responsibility is to its Client and this document does not exonerate parties to a transaction from exercising all their rights and obligations under the transaction documents. This document cannot be reproduced except in full, without prior written approval of the Company. Any unauthorized alteration, forgery or falsification of the content or appearance of this document is unlawful and offenders may be prosecuted to the fullest extent of the law. Unless otherwise stated the results shown in this test report refer only to the sample(s) tested and such sample(s) are retained for 30 days only.

Attention: To check the authenticity of testing /inspection report & certificate, please contact us at telephone: (86-755) 8307 1443, or email: CN.Doccheck@sgs.com

No.10 Weiye Road, Development Zone, Kunshan, Jiangsu, China 215300 t(86-512) 5735 5888 f(86-512) 57370818 www.sgs.com.cn
 中国·江苏·昆山开发区伟业路10号 邮编: 215300 t(86-512) 57355888 f(86-512) 57370818 sgs.china@sgs.com

7 Test Setup Photographs

Refer to the < Test Setup photos>.

- End of the Report -



Unless otherwise agreed in writing, this document is issued by the Company subject to its General Conditions of Service printed overleaf, available on request or accessible at <https://www.sgs.com/en/Terms-and-Conditions>. Attention is drawn to the limitation of liability, indemnification and jurisdiction issues defined therein. Any holder of this document is advised that information contained hereon reflects the Company's findings at the time of its intervention only and within the limits of Client's instructions, if any. The Company's sole responsibility is to its Client and this document does not exonerate parties to a transaction from exercising all their rights and obligations under the transaction documents. This document cannot be reproduced except in full, without prior written approval of the Company. Any unauthorized alteration, forgery or falsification of the content or appearance of this document is unlawful and offenders may be prosecuted to the fullest extent of the law. Unless otherwise stated the results shown in this test report refer only to the sample(s) tested and such sample(s) are retained for 30 days only.

Attention: To check the authenticity of testing /inspection report & certificate, please contact us at telephone: (86-755) 8307 1443, or email: CN.Doccheck@sgs.com

No. 10 Weiye Road, Development Zone, Kunshan, Jiangsu, China 215300 t(86-512) 5735 5888 f(86-512) 57370818 www.sgsgroup.com.cn
中国·江苏·昆山开发区伟业路10号 邮编: 215300 t(86-512) 57355888 f(86-512) 57370818 sgs.china@sgs.com