



# FCC RF Test Report

APPLICANT : MeiG Smart Technology Co., Ltd  
EQUIPMENT : CPE  
BRAND NAME : MEIGLink  
MODEL NAME : SLT866  
FCC ID : 2APJ4-SLT866  
STANDARD : 47 CFR Part 2, 96  
CLASSIFICATION : Citizens Band End User Devices (CBE)  
EQUIPMENT TYPE : End User Equipment  
TEST DATE(S) : Oct. 25, 2022 ~ Nov. 11, 2022

We, Sporton International Inc. (Kunshan), would like to declare that the tested sample has been evaluated in accordance with the procedures given in ANSI C63.26 and shown compliance with the applicable technical standards.

This report contains data that were produced under subcontract by Sporton International Inc. (Shenzhen).

The test results in this report apply exclusively to the tested model / sample. Without written approval of Sporton International Inc. (Kunshan), the test report shall not be reproduced except in full.

Jason Jia

Approved by: Jason Jia



**Sporton International Inc. (Kunshan)**

**No. 1098, Pengxi North Road, Kunshan Economic Development Zone Jiangsu Province 215300  
People's Republic of China**



# Table of Contents

**History of this test report..... 3**

**Summary of Test Result..... 4**

**1 General Description ..... 5**

    1.1 Applicant..... 5

    1.2 Manufacturer ..... 5

    1.3 Feature of Equipment Under Test..... 5

    1.4 Maximum EIRP and Emission Designator ..... 6

    1.5 Testing Site..... 6

    1.6 Test Software ..... 7

    1.7 Applied Standards ..... 7

**2 Test Configuration of Equipment Under Test ..... 8**

    2.1 Test Mode..... 8

    2.2 Connection Diagram of Test System ..... 9

    2.3 Support Unit used in test configuration ..... 9

    2.4 Measurement Results Explanation Example ..... 9

    2.5 Frequency List of Low/Middle/High Channels..... 10

**3 Conducted Test Items..... 11**

    3.1 Measuring Instruments..... 11

    3.2 Conducted Output Power ..... 12

    3.3 EIRP ..... 13

    3.4 Occupied Bandwidth ..... 14

    3.5 Conducted Band Edge ..... 15

    3.6 Conducted Spurious Emission ..... 16

    3.7 Frequency Stability..... 17

**4 Radiated Test Items ..... 18**

    4.1 Measuring Instruments..... 18

    4.2 Test Setup ..... 18

    4.3 Test Result of Radiated Test..... 19

    4.4 Radiated Spurious Emission ..... 20

**5 List of Measuring Equipment..... 21**

**6 Uncertainty of Evaluation ..... 22**

**Appendix A. Test Results of Conducted Test**

**Appendix B. Test Results of Radiated Test**

**Appendix C. Test Setup Photographs**





### Summary of Test Result

| Report Clause | Ref Std. Clause   | Test Items  | Result (PASS/FAIL) | Remark                                    |
|---------------|-------------------|---|--------------------|---|
| 3.2           | §2.1046           | Conducted Output Power  | Reporting only     | -   |
| -             | §96.41            | Peak-to-Average Ratio   | Not Applicable     | Not applicable for End User Devices       |
| 3.3           | §96.41            | Maximum E.I.R.P   | Pass               | -   |
|               |                   | Maximum Power Spectral Density                                    | Not Applicable     | Not applicable for End User Devices       |
| 3.4           | §2.1049<br>§96.41 | Occupied Bandwidth  | Reporting only     | -   |
| 3.5           | §2.1051<br>§96.41 | Conducted Band Edge Measurement<br>Adjacent Channel Leakage Ratio | Pass               | -   |
| 3.6           | §2.1051<br>§96.41 | Conducted Spurious Emission                                       | Pass               | -   |
| 3.7           | §2.1055           | Frequency Stability for<br>Temperature & Voltage                  | Pass               | -   |
| 4.4           | §2.1051<br>§96.41 | Radiated Spurious Emission  | Pass               | Under limit<br>9.33 dB at<br>14464.00 MHz |

|  |
|--|
| <b>Declaration of Conformity:</b>  |
| The test results with all measurement uncertainty excluded are presented in accordance with the regulation limits or requirements declared by manufacturers.   |
| <b>Comments and Explanations:</b>  |
| The declared of product specification for EUT presented in the report are provided by the manufacturer, and the manufacturer takes all the responsibilities for the accuracy of product specification. |



# 1 General Description

## 1.1 Applicant

MeiG Smart Technology Co., Ltd

2nd Floor,Office Building,No.5 Lingxia Road,Fenghuang,Fuyong Street,Bao'an District,Shenzhen

## 1.2 Manufacturer

MeiG Smart Technology Co., Ltd

2nd Floor,Office Building,No.5 Lingxia Road,Fenghuang,Fuyong Street,Bao'an District,Shenzhen

## 1.3 Feature of Equipment Under Test

| Product Feature                 |   |
|---------------------------------|---|
| Equipment                       | CPE   |
| Brand Name                      | MEIGLink  |
| Model Name                      | SLT866  |
| FCC ID                          | 2APJ4-SLT866  |
| Tx Frequency                    | LTE Band 48 : 3550 MHz ~ 3700 MHz<br>LTE Band 42 : 3550 MHz ~ 3600 MHz<br>LTE Band 43 : 3600 MHz ~ 3700 MHz         |
| Rx Frequency                    | LTE Band 48 : 3550 MHz ~ 3700 MHz<br>LTE Band 42 : 3550 MHz ~ 3600 MHz<br>LTE Band 43 : 3600 MHz ~ 3700 MHz         |
| Bandwidth                       | 5MHz / 10MHz / 15MHz / 20MHz  |
| Maximum Output Power to Antenna | LTE Band 42 : 20.79 dBm<br>LTE Band 43 : 20.78 dBm<br>LTE Band 48 : 21.50 dBm                                       |
| Antenna Type / Gain             | <b>LTE Band 42/43/48:</b><br>Fixed External Antenna 1 with gain 1.0 dBi<br>Fixed Internal Antenna with gain 1.0 dBi |
| Type of Modulation              | QPSK / 16QAM  |
| IMEI Code                       | Conducted: 864630066663500<br>Radiation: 864630066621144  |
| HW Version                      | SLT866_V1.01_PCB  |
| SW Version                      | SLT866_EQ100_C44_V1403  |
| EUT Stage                       | Identical Prototype   |

**Remark:** The above EUT's information was declared by manufacturer. Please refer to the specifications or user's manual for more detailed description.

### 1.4 Maximum EIRP and Emission Designator

| LTE Band 42 |                       | QPSK            |                              | 16QAM           |                              |
|-------------|-----------------------|-----------------|------------------------------|-----------------|------------------------------|
| BW (MHz)    | Frequency Range (MHz) | Maximum EIRP(W) | Emission Designator (99%OBW) | Maximum EIRP(W) | Emission Designator (99%OBW) |
| 20          | 3560~3590             | 0.1510          | 17M9G7D                      | 0.1225          | 17M8W7D                      |
| LTE Band 43 |                       | QPSK            |                              | 16QAM           |                              |
| BW (MHz)    | Frequency Range (MHz) | Maximum EIRP(W) | Emission Designator (99%OBW) | Maximum EIRP(W) | Emission Designator (99%OBW) |
| 20          | 3610~3690             | 0.1507          | 17M9G7D                      | 0.1253          | 17M8W7D                      |
| LTE Band 48 |                       | QPSK            |                              | 16QAM           |                              |
| BW (MHz)    | Frequency Range (MHz) | Maximum EIRP(W) | Emission Designator (99%OBW) | Maximum EIRP(W) | Emission Designator (99%OBW) |
| 20          | 3560~3690             | 0.1778          | 17M9G7D                      | 0.1552          | 17M8W7D                      |

**Note:**

1. Based on engineering evaluation, only the maximum bandwidth and the worst modulation test results are shown in the report.
2. LTE Band 48 overlaps the entire frequency range of LTE Band 42/43. Therefore, the test results provided in this report covers Band 48 as well as Band 42/43.

### 1.5 Testing Site

Sporton International Inc. (Kunshan) is accredited to ISO/IEC 17025:2017 by American Association for Laboratory Accreditation with Certificate Number 5145.02.

|                           |  |                            |                                       |
|---------------------------|--|----------------------------|---------------------------------------|
| <b>Test Firm</b>          | Sporton International Inc. (Kunshan)   |                            |                                       |
| <b>Test Site Location</b> | No. 1098, Pengxi North Road, Kunshan Economic Development Zone<br>Jiangsu Province 215300 People's Republic of China<br>TEL : +86-512-57900158<br>FAX : +86-512-57900958 |                            |                                       |
| <b>Test Site No.</b>      | <b>Sporton Site No.</b>  | <b>FCC Designation No.</b> | <b>FCC Test Firm Registration No.</b> |
|                           | TH01-KS  | CN1257                     | 314309                                |



Sporton International Inc. (Shenzhen) is accredited to ISO/IEC 17025:2017 by American Association for Laboratory Accreditation with Certificate Number 5145.01.

|                           |   |                            |                                       |
|---------------------------|---|----------------------------|---------------------------------------|
| <b>Test Firm</b>          | Sporton International Inc. (Shenzhen)   |                            |                                       |
| <b>Test Site Location</b> | 101, 1st Floor, Block B, Building 1, No. 2, Tengfeng 4th Road, Fenghuang Community, Fuyong Street, Baoan District, Shenzhen City Guangdong Province China 518103<br>TEL: +86-755-33202398 |                            |                                       |
| <b>Test Site No.</b>      | <b>Sporton Site No.</b>   | <b>FCC Designation No.</b> | <b>FCC Test Firm Registration No.</b> |
|                           | 03CH02-SZ   | CN1256                     | 421272                                |

Test data subcontracted: Radiated test items in section 4.4 of this report.

### 1.6 Test Software

| Item | Site      | Manufacturer | Name | Version      |
|------|-----------|--------------|------|--------------|
| 1.   | 03CH02-SZ | AUDIX        | E3   | 6.2009-8-24a |

### 1.7 Applied Standards

According to the specifications of the manufacturer, the EUT must comply with the requirements of the following standards:

- ♦ ANSI C63.26-2015
- ♦ 47 CFR Part 2, 96
- ♦ FCC KDB 971168 D01 Power Meas. License Digital Systems v03r01
- ♦ FCC KDB 940660 D01 Part 96 CBRS v03
- ♦ FCC KDB 412172 D01 Determining ERP and EIRP v01r01

**Remark:**

1. All test items were verified and recorded according to the standards and without any deviation during the test.
2. This EUT has also been tested and complied with the requirements of FCC Part 15, Subpart B, recorded in a separate test report.



## 2 Test Configuration of Equipment Under Test

### 2.1 Test Mode

Antenna port conducted and radiated test items listed below are performed according to KDB 971168 D01 Power Meas. License Digital Systems v03r01 with maximum output power.

For radiated measurement, pre-scanned in three orthogonal panels, X, Y, Z. The worst cases (Y plane) were recorded in this report.

| Test Items                     | Band  | Bandwidth (MHz) |   |   |    |    |    | Modulation |       |       | RB # |      |      | Test Channel |   |   |
|--------------------------------|---|-----------------|---|---|----|----|----|------------|-------|-------|------|------|------|--------------|---|---|
|                                |   | 1.4             | 3 | 5 | 10 | 15 | 20 | QPSK       | 16QAM | 64QAM | 1    | Half | Full | L            | M | H |
| Max. Output Power              | 42  | -               | - | v | v  | v  | v  | v          | v     | -     | v    |      | v    | v            | v | v |
|                                | 43  | -               | - | v | v  | v  | v  | v          | v     | -     | v    |      | v    | v            | v | v |
|                                | 48  | -               | - | v | v  | v  | v  | v          | v     | -     | v    |      | v    | v            | v | v |
| Adjacent Channel Leakage Ratio | 48  | -               | - | v | v  | v  | v  | v          | v     | -     | v    |      | v    | v            | v | v |
| 26dB and 99% Bandwidth         | 48  | -               | - |   |    |    | v  | v          | v     | -     |      |      | v    |              | v |   |
| Conducted Band Edge            | 48  | -               | - | v | v  | v  | v  | v          | v     | -     | v    |      | v    | v            |   | v |
| Conducted Spurious Emission    | 48  | -               | - | v | v  | v  | v  | v          |       | -     | v    |      |      | v            | v | v |
| E.I.R.P                        | 42  | -               | - | v | v  | v  | v  | v          | v     | -     | v    |      | v    | v            | v | v |
|                                | 43  | -               | - | v | v  | v  | v  | v          | v     | -     | v    |      | v    | v            | v | v |
|                                | 48  | -               | - | v | v  | v  | v  | v          | v     | -     | v    |      | v    | v            | v | v |
| Frequency Stability            | 48  | -               | - |   | v  |    |    | v          |       | -     | v    |      |      |              | v |   |
| Radiated Spurious Emission     | 48  | Worst Case      |   |   |    |    |    |            |       |       |      |      |      | v            |   |   |
| Note                           | <ol style="list-style-type: none"> <li>The mark "v " means that this configuration is chosen for testing</li> <li>The mark "-" means that this bandwidth is not supported.</li> <li>The device is investigated from 30MHz to 10 times of fundamental signal for radiated spurious emission test under different RB size/offset and modulations in exploratory test. Subsequently, only the worst case emissions are reported.</li> <li>All test items are based on engineering evaluation.</li> <li>All the radiated test cases were performed with Adapter1.</li> <li>LTE Band 48 overlaps the entire frequency range of LTE Band 42/43. Therefore, the test results provided in this report covers Band 48 as well as Band 42/43</li> </ol> |                 |   |   |    |    |    |            |       |       |      |      |      |              |   |   |



## 2.2 Connection Diagram of Test System

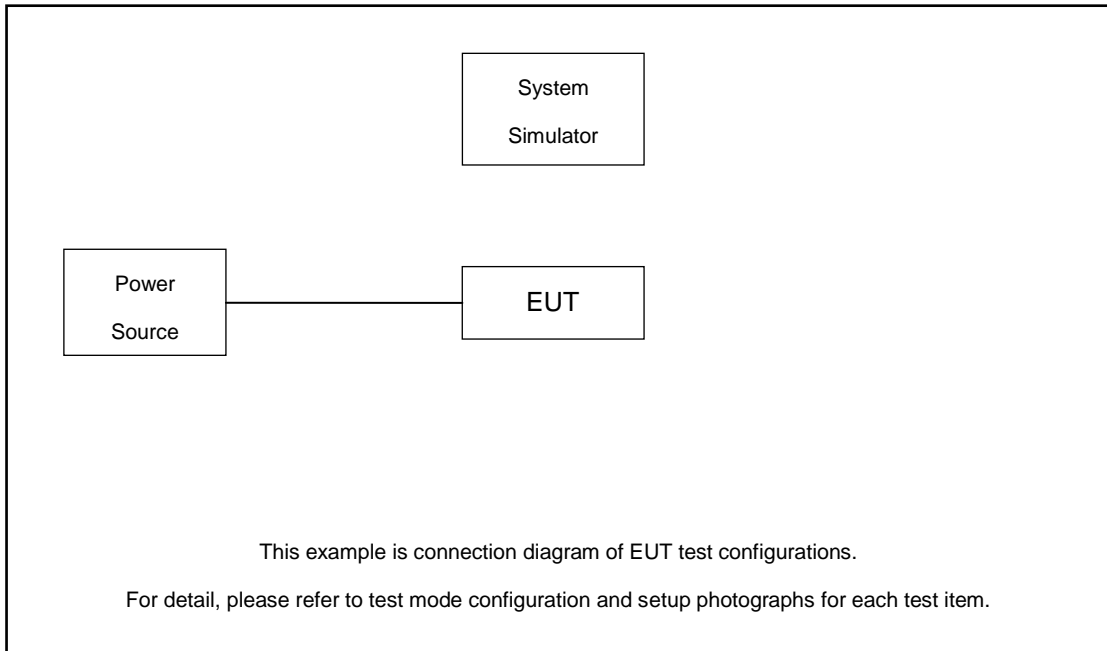

## 2.3 Support Unit used in test configuration

| Item | Equipment        | Trade Name | Model No. | FCC ID | Data Cable | Power Cord        |
|------|------------------|------------|-----------|--------|------------|-------------------|
| 1.   | Power Supply     | GWINSTEK   | PSS-2002  | N/A    | N/A        | Unshielded, 1.8 m |
| 2.   | LTE Base Station | Anritsu    | MT8821C   | N/A    | N/A        | Unshielded, 1.8 m |

## 2.4 Measurement Results Explanation Example

### For all conducted test items:

The offset level is set in the spectrum analyzer to compensate the RF cable loss between EUT conducted output port and spectrum analyzer. With the offset compensation, the spectrum analyzer reading level is exactly the EUT RF output level.

The spectrum analyzer offset is derived from RF cable loss.

*Offset = RF cable loss.*

Following shows an offset computation example with cable loss 8.72 dB.

Example :

$$\begin{aligned} \text{Offset(dB)} &= \text{RF cable loss(dB)}. \\ &= 8.72 \text{ (dB)} \end{aligned}$$



### 2.5 Frequency List of Low/Middle/High Channels

| LTE Band 48 Channel and Frequency List |                        |        |        |         |
|--|------------------------|--------|--------|---------|
| BW [MHz]                               | Channel/Frequency(MHz) | Lowest | Middle | Highest |
| 20                                     | Channel                | 55340  | 55990  | 56640   |
|  | Frequency              | 3560.0 | 3625.0 | 3690.0  |
| 15                                     | Channel                | 55315  | 55990  | 56665   |
|  | Frequency              | 3557.5 | 3625.0 | 3692.5  |
| 10                                     | Channel                | 55290  | 55990  | 56690   |
|  | Frequency              | 3555.0 | 3625.0 | 3695.0  |
| 5                                      | Channel                | 55265  | 55990  | 56715   |
|  | Frequency              | 3552.5 | 3625.0 | 3697.5  |

| LTE Band 42 Channel and Frequency List |                        |        |        |         |
|--|------------------------|--------|--------|---------|
| BW [MHz]                               | Channel/Frequency(MHz) | Lowest | Middle | Highest |
| 20                                     | Channel                | 43190  | 43340  | 43490   |
|  | Frequency              | 3560   | 3575   | 3590    |
| 15                                     | Channel                | 43165  | 43340  | 43515   |
|  | Frequency              | 3557.5 | 3575   | 3592.5  |
| 10                                     | Channel                | 43140  | 43340  | 43540   |
|  | Frequency              | 3555   | 3575   | 3595    |
| 5                                      | Channel                | 43115  | 43340  | 43565   |
|  | Frequency              | 3552.5 | 3575   | 3597.5  |

| LTE Band 43 Channel and Frequency List |                        |        |        |         |
|--|------------------------|--------|--------|---------|
| BW [MHz]                               | Channel/Frequency(MHz) | Lowest | Middle | Highest |
| 20                                     | Channel                | 43690  | 44090  | 44490   |
|  | Frequency              | 3610   | 3650   | 3690    |
| 15                                     | Channel                | 43665  | 44090  | 44515   |
|  | Frequency              | 3607.5 | 3650   | 3692.5  |
| 10                                     | Channel                | 43640  | 44090  | 44540   |
|  | Frequency              | 3605   | 3650   | 3695    |
| 5                                      | Channel                | 43615  | 44090  | 44565   |
|  | Frequency              | 3602.5 | 3650   | 3697.5  |

### 3 Conducted Test Items

#### 3.1 Measuring Instruments

See list of measuring instruments of this test report.

##### 3.1.1 Test Setup

##### 3.1.2 Conducted Output Power / ACLR



##### 3.1.3 26dB & 99% Occupied Bandwidth, Conducted Band-Edge and Conducted Spurious Emission

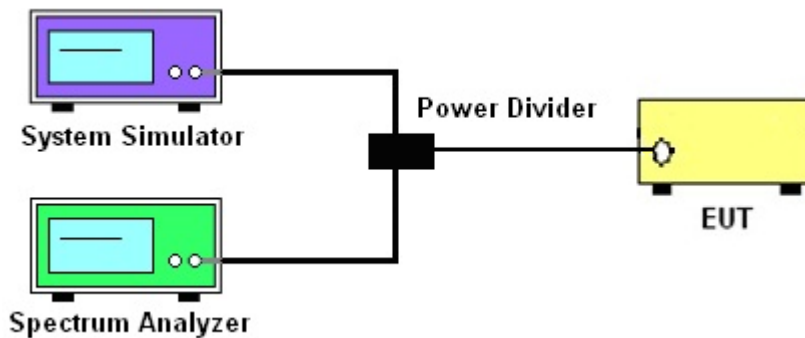

##### 3.1.4 Frequency Stability

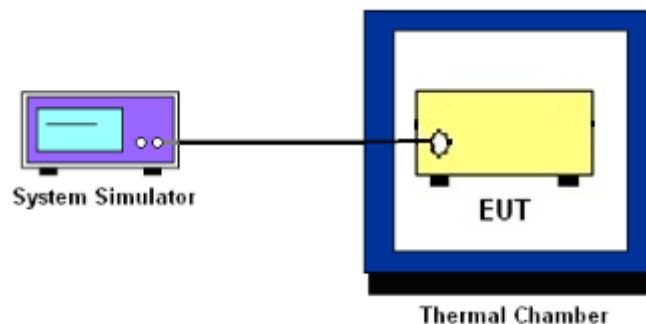

##### 3.1.5 Test Result of Conducted Test

Please refer to Appendix A.



## **3.2 Conducted Output Power**

### **3.2.1 Description of the Conducted Output Power Measurement**

A system simulator was used to establish communication with the EUT. Its parameters were set to force the EUT transmitting at maximum output power. The measured power in the radio frequency on the transmitter output terminals shall be reported.

### **3.2.2 Test Procedures**

1. The transmitter output port was connected to the system simulator.
2. Set EUT at maximum power through the system simulator.
3. Select lowest, middle, and highest channels for each band and different modulation.
4. Measure and record the power level from the system simulator.

### 3.3 EIRP

#### 3.3.1 Description of the EIRP Measurement

EIRP limits for CBRS equipment as below table:

| Device                   |                 | Maximum EIRP<br>(dBm/10 MHz) |
|--------------------------|-----------------|------------------------------|
| Applied                  | End User Device | 23                           |
| <input type="checkbox"/> | Category A CBSD | 30                           |
| <input type="checkbox"/> | Category B CBSD | 47                           |

**Remark:** The worst case EIRP shown in this section is found with LTE operating only using 1RB. As such, the EIRP/10MHz and full channel EIRP values will be identical since 1RB is fully contained within all available channel bandwidths for LTE Band 48 (i.e. 5, 10, 15, 20MHz)

#### 3.3.2 Test Procedures for EIRP

1. Establishing a communications link with the call box (Base station) to measure the Maximum conducted power, the parameters were set to force the EUT transmitting at maximum output power level. Use the average power measurement function to measure total channel power of each channel bandwidth (per ANSI C63.26-2015 Section 5.2.1)
2. Determining ERP and/or EIRP from conducted RF output power measurements (Per ANSI C63.26-2015 Section 5.2.5.5)
  - EIRP =  $P_T + G_T - L_C$ , ERP = EIRP -2.15, where
  - $P_T$  = transmitter output power in dBm
  - $G_T$  = gain of the transmitting antenna in dBi
  - $L_C$  = signal attenuation in the connecting cable between the transmitter and antenna in dB



### 3.4 Occupied Bandwidth

#### 3.4.1 Description of Occupied Bandwidth Measurement

The occupied bandwidth is the width of a frequency band such that, below the lower and above the upper frequency limits, the mean powers emitted are each equal to a specified percentage 0.5% of the total mean transmitted power.

The 26 dB emission bandwidth is defined as the frequency range between two points, one above and one below the carrier frequency, at which the spectral density of the emission is attenuated 26 dB below the maximum in-band spectral density of the modulated signal. Spectral density (power per unit bandwidth) is to be measured with a detector of resolution bandwidth equal to approximately 1.0% of the emission bandwidth.

#### 3.4.2 Test Procedures

The testing follows ANSI C63.26-2015 Section 5.4.3 (26dB) and Section 5.4.4 (99OB)

1. The EUT was connected to spectrum analyzer and system simulator via a power divider.
2. The spectrum analyzer center frequency is set to the nominal EUT channel center frequency. The span range for the spectrum analyzer shall be between two and five times the anticipated OBW.
3. The nominal resolution bandwidth (RBW) shall be in the range of 1 to 5 % of the anticipated OBW, and the VBW shall be at least 3 times the RBW.
4. Set the detection mode to peak, and the trace mode to max hold.
5. Determine the reference value: Set the EUT to transmit a modulated signal. Allow the trace to stabilize. Set the spectrum analyzer marker to the highest level of the displayed trace.  
(this is the reference value)
6. Determine the “-26 dB down amplitude” as equal to (Reference Value – X).
7. Place two markers, one at the lowest and the other at the highest frequency of the envelope of the spectral display such that each marker is at or slightly below the “-X dB down amplitude” determined in step 6. If a marker is below this “-X dB down amplitude” value it shall be placed as close as possible to this value. The OBW is the positive frequency difference between the two markers.
8. Use the 99 % power bandwidth function of the spectrum analyzer and report the measured bandwidth.

## 3.5 Conducted Band Edge

### 3.5.1 Description of Conducted Band Edge Measurement

Part 96.41 (e) (1) (ii)

For End User Devices the emission limits outside the fundamental are as follows:

Within 0 MHz to B MHz above and below the assigned channel  $\leq -13$  dBm/MHz

Greater than B MHz above and below the assigned channel  $\leq -25$  dBm/MHz

where B is the bandwidth in megahertz of the assigned channel or multiple contiguous channels of the End User Device.

Notwithstanding the emission limits in this paragraph, the Adjacent Channel Leakage Ratio for End User Devices shall be at least 30 dB.

Part 96.41 (e) (2)

For CBSDs and End User Devices, the conducted power of emissions below 3540 MHz or above 3710 MHz shall not exceed  $-25$  dBm/MHz, and the conducted power of emissions below 3530 MHz or above 3720 MHz shall not exceed  $-40$ dBm/MHz

### 3.5.2 Test Procedures

The testing follows FCC KDB 971168 D01 v03r01 Section 6.1.

1. The EUT was connected to spectrum analyzer and system simulator via a power divider.
2. The band edges of low and high channels for the highest RF powers were measured.
3. Set RBW  $\geq 1\%$  EBW in the 1MHz band immediately outside and adjacent to the band edge.
4. Beyond the 1 MHz band from the band edge, RBW=1MHz was used
5. Offset has included the duty factor for LTE Band 48. Duty factor  $=10 \log (1/x)$ , where x is the measured duty cycle.
6. Set spectrum analyzer with RMS detector.
7. The RF fundamental frequency should be excluded against the limit line in the operating frequency band.



## 3.6 Conducted Spurious Emission

### 3.6.1 Description of Conducted Spurious Emission Measurement

96.41 (e)(2)

The conducted power of any emissions below 3530 MHz or above 3720 MHz shall not exceed -40dBm/MHz.

### 3.6.2 Test Procedures

The testing follows FCC KDB 971168 D01 v03r01 Section 6.1.

1. The EUT was connected to spectrum analyzer and system simulator via a power divider.
2. The RF output of EUT was connected to the spectrum analyzer by RF cable and attenuator. The path loss was compensated to the results for each measurement.
3. The middle channel for the highest RF power within the transmitting frequency was measured.
4. The conducted spurious emission for the whole frequency range was taken.
5. Make the measurement with the spectrum analyzer's RBW = 1MHz, VBW = 3MHz.
6. Set spectrum analyzer with RMS detector.
7. Taking the record of maximum spurious emission.
8. The RF fundamental frequency should be excluded against the limit line in the operating frequency band.
9. The limit line is -40dBm/MHz.





## 3.7 Frequency Stability

### 3.7.1 Description of Frequency Stability Measurement

The frequency stability shall be measured by variation of ambient temperature and variation of primary supply voltage to ensure that the fundamental emission stays within the authorized frequency block. The frequency stability of the transmitter shall be maintained within  $\pm 0.00025\%$  ( $\pm 2.5\text{ppm}$ ) of the center frequency

### 3.7.2 Test Procedures for Temperature Variation

The testing follows FCC KDB 971168 D01 v03r01 Section 9.0.

1. The EUT was set up in the thermal chamber and connected with the system simulator.
2. With power OFF, the temperature was decreased to  $-30^{\circ}\text{C}$  and the EUT was stabilized before testing. Power was applied and the maximum change in frequency was recorded within one minute.
3. With power OFF, the temperature was raised in  $10^{\circ}\text{C}$  step up to  $50^{\circ}\text{C}$ . The EUT was stabilized at each step for at least half an hour. Power was applied and the maximum frequency change was recorded within one minute.

### 3.7.3 Test Procedures for Voltage Variation

The testing follows FCC KDB 971168 D01 v03r01 Section 9.0.

1. The EUT was placed in a temperature chamber at  $25\pm 5^{\circ}\text{C}$  and connected with the system simulator.
2. The power supply voltage to the EUT was varied from 85% to 115% of the nominal value measured at the input to the EUT.
3. The variation in frequency was measured for the worst case.

## 4 Radiated Test Items

### 4.1 Measuring Instruments

See list of measuring instruments of this test report.

### 4.2 Test Setup

#### 4.2.1 For radiated test below 30MHz

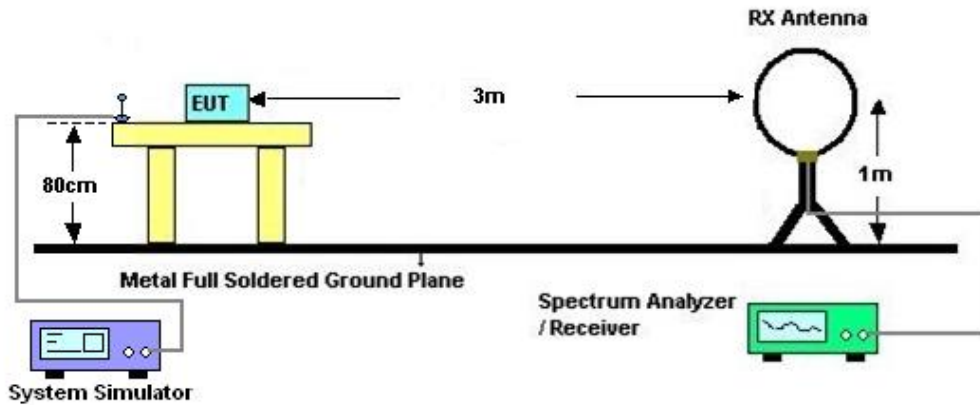

#### 4.2.2 For radiated test from 30MHz to 1GHz

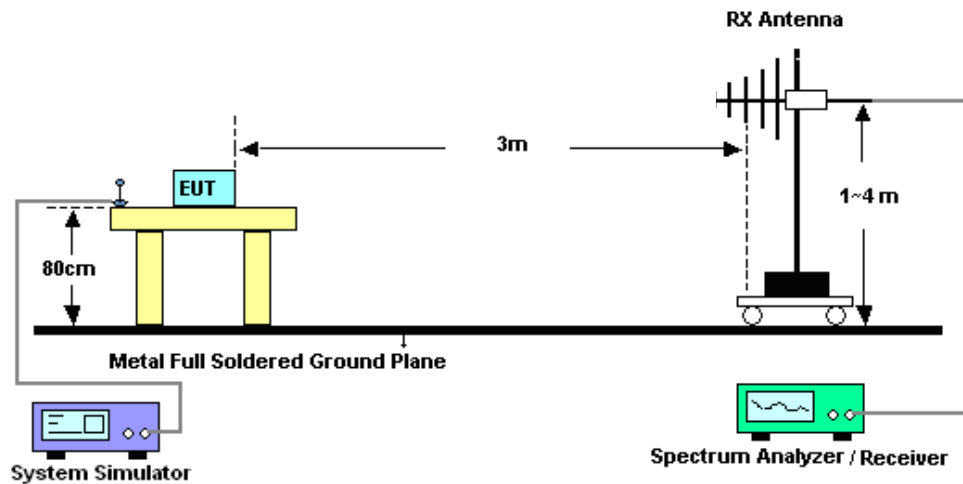

### 4.2.3 For radiated test above 1GHz

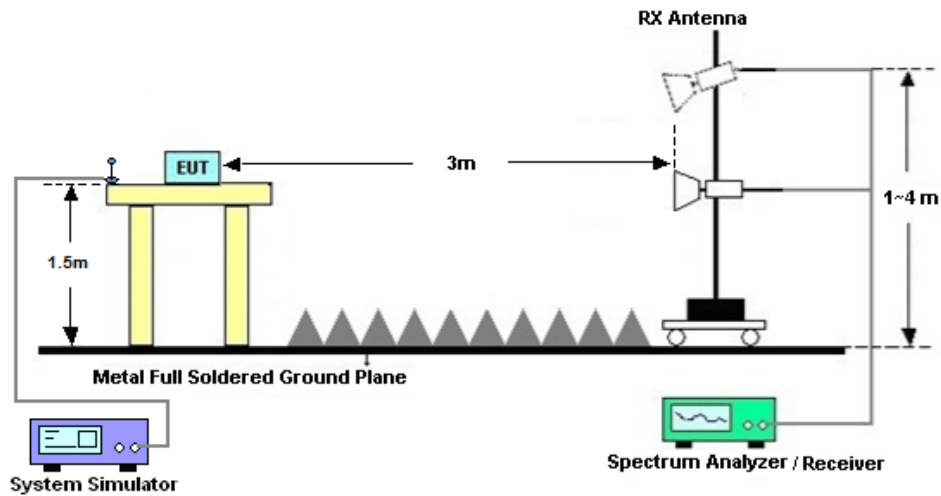

### 4.3 Test Result of Radiated Test

The low frequency, which started from 9 kHz to 30MHz, was pre-scanned and the result which was 20dB lower than the limit line was not reported.

Please refer to Appendix B.



## 4.4 Radiated Spurious Emission

### 4.4.1 Description of Radiated Spurious Emission Measurement

The radiated spurious emission was measured by substitution method according to ANSI C63.26-2015. The power of any emission outside of the authorized operating frequency ranges must be attenuated below the transmitter power (P) by a factor of at least -40dBm / MHz. The spectrum is scanned from 30 MHz up to a frequency including its 10th harmonic.

### 4.4.2 Test Procedures

1. The EUT was placed on a turntable with 0.8 meter height for frequency below 1GHz and 1.5 meter height for frequency above 1GHz respectively above ground.
2. The EUT was set 3 meters from the receiving antenna mounted on the antenna tower.
3. The table was rotated 360 degrees to determine the position of the highest spurious emission.
4. The height of the receiving antenna is varied between 1m to 4m to search the maximum spurious emission for both horizontal and vertical polarizations.
5. During the measurement, the system simulator parameters were set to force the EUT transmitting at maximum output power.
6. Make the measurement with the spectrum analyzer's RBW = 1MHz, VBW = 3MHz, taking the record of maximum spurious emission.
7. A horn antenna was substituted in place of the EUT and was driven by a signal generator. Tune the output power of signal generator to the same emission level with EUT maximum spurious emission.  
$$\text{EIRP (dBm)} = \text{S.G. Power} - \text{Tx Cable Loss} + \text{Tx Antenna Gain}$$
$$\text{ERP (dBm)} = \text{EIRP} - 2.15$$
8. The RF fundamental frequency should be excluded against the limit line in the operating frequency band.  
The limit line is -40dBm/MHz



## 5 List of Measuring Equipment

| Instrument                     | Manufacturer | Model No.     | Serial No.       | Characteristics         | Calibration Date | Test Date                      | Due Date      | Remark                |
|--------------------------------|--------------|---------------|------------------|-------------------------|------------------|--------------------------------|---------------|-----------------------|
| Spectrum Analyzer              | R&S          | FSV40         | 101040           | 10Hz~40GHz              | Oct. 12, 2022    | Oct. 25 2022~<br>Oct. 26, 2022 | Oct. 11, 2023 | Conducted (TH01-KS)   |
| Power divider                  | STI          | STI08-0055    | -                | 0.5~40GHz               | Aug. 25, 2022    | Oct. 25 2022~<br>Oct. 26, 2022 | Aug. 24, 2023 | Conducted (TH01-KS)   |
| Temperature & humidity chamber | Hongzhan     | LP-150U       | H2014011<br>440  | -40~+150°C<br>20%~95%RH | Jul. 15, 2022    | Oct. 25 2022~<br>Oct. 26, 2022 | Jul. 14, 2023 | Conducted (TH01-KS)   |
| EXA Spectrum Analyzer          | KEYSIGHT     | N9010A        | MY551502<br>13   | 10Hz~44GHz              | Jul. 07, 2022    | Nov. 11, 2022                  | Jul. 06, 2023 | Radiation (03CH02-SZ) |
| Loop Antenna                   | R&S          | HFH2-Z2       | 100354           | 9kHz~30MHz              | Jul. 28, 2022    | Nov. 11, 2022                  | Jul. 27, 2024 | Radiation (03CH02-SZ) |
| Bilog Antenna                  | TeseQ        | CBL6112D      | 35407            | 30MHz-2GHz              | Oct. 19, 2022    | Nov. 11, 2022                  | Oct. 18, 2023 | Radiation (03CH02-SZ) |
| Double Ridge Horn Antenna      | ETS-Lindgren | 3117          | 00119436         | 1GHz~18GHz              | Jul. 07, 2022    | Nov. 11, 2022                  | Jul. 06, 2023 | Radiation (03CH02-SZ) |
| HF Amplifier                   | MITEQ        | TTA1840-35-HG | 1871923          | 18GHz~40GHz             | Jul. 07, 2022    | Nov. 11, 2022                  | Jul. 06, 2023 | Radiation (03CH02-SZ) |
| SHF-EHF Horn                   | com-power    | AH-840        | 101071           | 18Ghz-40GHz             | Apr. 10, 2022    | Nov. 11, 2022                  | Apr. 09, 2023 | Radiation (03CH02-SZ) |
| LF Amplifier                   | Burgeon      | BPA-530       | 102211           | 0.01~3000Mhz            | Oct. 19, 2022    | Nov. 11, 2022                  | Oct. 18, 2023 | Radiation (03CH02-SZ) |
| HF Amplifier                   | KEYSIGHT     | 83017A        | MY532701<br>05   | 0.5GHz~26.5GHz          | Oct. 19, 2022    | Nov. 11, 2022                  | Oct. 18, 2023 | Radiation (03CH02-SZ) |
| AC Power Source                | Chroma       | 61601         | 616010003<br>043 | N/A                     | Nov. 11, 2022    | Nov. 11, 2022                  | Nov. 10, 2023 | Radiation (03CH02-SZ) |
| Turn Table                     | Chaintek     | T-200         | N/A              | 0~360 degree            | NCR              | Nov. 11, 2022                  | NCR           | Radiation (03CH02-SZ) |
| Antenna Mast                   | Chaintek     | MBS-400       | N/A              | 1 m~4 m                 | NCR              | Nov. 11, 2022                  | NCR           | Radiation (03CH02-SZ) |

NCR: No Calibration Required



## 6 Uncertainty of Evaluation

### Uncertainty of Conducted Measurement

| Test Item                  | Uncertainty |
|----------------------------|-------------|
| Conducted Power            | ±0.46 dB    |
| Conducted Emissions        | ±0.48 dB    |
| Occupied Channel Bandwidth | ±0.10 %     |

### Uncertainty of Radiated Emission Measurement (30 MHz ~ 1000 MHz)

|   |        |
|---|--------|
| Measuring Uncertainty for a Level of Confidence of 95% (U = 2Uc(y)) | 2.47dB |
|---|--------|

### Uncertainty of Radiated Emission Measurement (1 GHz ~ 18 GHz)

|   |        |
|---|--------|
| Measuring Uncertainty for a Level of Confidence of 95% (U = 2Uc(y)) | 3.31dB |
|---|--------|

### Uncertainty of Radiated Emission Measurement (18 GHz ~ 40 GHz)

|   |        |
|---|--------|
| Measuring Uncertainty for a Level of Confidence of 95% (U = 2Uc(y)) | 3.72dB |
|---|--------|

----- THE END -----



### Appendix A. Test Results of Conducted Test

|                 |        |                     |         |
|-----------------|--------|---------------------|---------|
| Test Engineer : | Lex Wu | Temperature :       | 22~23°C |
|                 |        | Relative Humidity : | 40~42%  |

### Conducted Output Power(Average power) and EIRP

**LTE Band 42:**

| BW [MHz]        | Modulation | RB Size | RB Offset | Power Low Ch. / Freq. | Power Middle Ch. / Freq. | Power High Ch. / Freq. | EIRP(W) |        |        |
|-----------------|------------|---------|-----------|-----------------------|--------------------------|------------------------|---------|--------|--------|
| Channel         |            |         |           | 43190                 | 43340                    | 43490                  | EIRP(W) |        |        |
| Frequency (MHz) |            |         |           | 3560                  | 3575                     | 3590                   | L       | M      | H      |
| 20              | QPSK       | 1       | 0         | 20.63                 | 20.70                    | 20.79                  | 0.1455  | 0.1479 | 0.1510 |
| 20              | QPSK       | 1       | 99        | 20.43                 | 20.53                    | 20.49                  | 0.1390  | 0.1422 | 0.1409 |
| 20              | QPSK       | 100     | 0         | 19.64                 | 19.68                    | 19.72                  | 0.1159  | 0.1169 | 0.1180 |
| 20              | 16QAM      | 1       | 0         | 19.76                 | 19.88                    | 19.80                  | 0.1191  | 0.1225 | 0.1202 |
| Channel         |            |         |           | 43165                 | 43340                    | 43515                  | EIRP(W) |        |        |
| Frequency (MHz) |            |         |           | 3557.5                | 3575                     | 3592.5                 | L       | M      | H      |
| 15              | QPSK       | 1       | 0         | 20.55                 | 20.71                    | 20.62                  | 0.1429  | 0.1483 | 0.1452 |
| 15              | 16QAM      | 1       | 0         | 19.81                 | 19.82                    | 19.83                  | 0.1205  | 0.1208 | 0.1211 |
| Channel         |            |         |           | 43140                 | 43340                    | 43540                  | EIRP(W) |        |        |
| Frequency (MHz) |            |         |           | 3555                  | 3575                     | 3595                   | L       | M      | H      |
| 10              | QPSK       | 1       | 0         | 20.58                 | 20.64                    | 20.39                  | 0.1439  | 0.1459 | 0.1377 |
| 10              | 16QAM      | 1       | 0         | 19.75                 | 19.83                    | 19.76                  | 0.1189  | 0.1211 | 0.1191 |
| Channel         |            |         |           | 43115                 | 43340                    | 43565                  | EIRP(W) |        |        |
| Frequency (MHz) |            |         |           | 3552.5                | 3575                     | 3597.5                 | L       | M      | H      |
| 5               | QPSK       | 1       | 0         | 20.48                 | 20.47                    | 20.35                  | 0.1406  | 0.1403 | 0.1365 |
| 5               | 16QAM      | 1       | 0         | 19.74                 | 19.74                    | 19.61                  | 0.1186  | 0.1186 | 0.1151 |



**LTE Band 43:**

| BW [MHz]        | Modulation | RB Size | RB Offset | Power Low Ch. / Freq. | Power Middle Ch. / Freq. | Power High Ch. / Freq. | EIRP(W) |        |        |
|-----------------|------------|---------|-----------|-----------------------|--------------------------|------------------------|---------|--------|--------|
| Channel         |            |         |           | 43690                 | 44090                    | 44490                  | EIRP(W) |        |        |
| Frequency (MHz) |            |         |           | 3610                  | 3650                     | 3690                   | L       | M      | H      |
| 20              | QPSK       | 1       | 0         | 20.55                 | 20.59                    | 20.78                  | 0.1429  | 0.1442 | 0.1507 |
| 20              | QPSK       | 1       | 99        | 20.49                 | 20.43                    | 20.59                  | 0.1409  | 0.1390 | 0.1442 |
| 20              | QPSK       | 100     | 0         | 19.57                 | 19.53                    | 19.75                  | 0.1140  | 0.1130 | 0.1189 |
| 20              | 16QAM      | 1       | 0         | 19.76                 | 19.82                    | 19.98                  | 0.1191  | 0.1208 | 0.1253 |
| Channel         |            |         |           | 43665                 | 44090                    | 44515                  | EIRP(W) |        |        |
| Frequency (MHz) |            |         |           | 3607.5                | 3650                     | 3692.5                 | L       | M      | H      |
| 15              | QPSK       | 1       | 0         | 20.54                 | 20.54                    | 20.76                  | 0.1426  | 0.1426 | 0.1500 |
| 15              | 16QAM      | 1       | 0         | 19.86                 | 19.76                    | 19.92                  | 0.1219  | 0.1191 | 0.1236 |
| Channel         |            |         |           | 43640                 | 44090                    | 44540                  | EIRP(W) |        |        |
| Frequency (MHz) |            |         |           | 3605                  | 3650                     | 3695                   | L       | M      | H      |
| 10              | QPSK       | 1       | 0         | 20.46                 | 20.60                    | 20.59                  | 0.1400  | 0.1445 | 0.1442 |
| 10              | 16QAM      | 1       | 0         | 19.72                 | 19.90                    | 19.89                  | 0.1180  | 0.1230 | 0.1227 |
| Channel         |            |         |           | 43615                 | 44090                    | 44565                  | EIRP(W) |        |        |
| Frequency (MHz) |            |         |           | 3602.5                | 3650                     | 3697.5                 | L       | M      | H      |
| 5               | QPSK       | 1       | 0         | 20.41                 | 20.49                    | 20.65                  | 0.1384  | 0.1409 | 0.1462 |
| 5               | 16QAM      | 1       | 0         | 19.57                 | 19.76                    | 19.78                  | 0.1140  | 0.1191 | 0.1197 |





LTE Band 48:

| BW [MHz]        | Modulation | RB Size | RB Offset | Power Low Ch. / Freq. | Power Middle Ch. / Freq. | Power High Ch. / Freq. | Gain | EIRP   |        |        |
|-----------------|------------|---------|-----------|-----------------------|--------------------------|------------------------|------|--------|--------|--------|
| Channel         |            |         |           | 55340                 | 55990                    | 56640                  |      | L      | M      | H      |
| Frequency (MHz) |            |         |           | 3560                  | 3625                     | 3690                   |      |        |        |        |
| 20              | QPSK       | 1       | 0         | 21.50                 | 21.31                    | 21.29                  | 1.00 | 0.1778 | 0.1702 | 0.1694 |
| 20              | QPSK       | 1       | 99        | 21.16                 | 21.43                    | 21.11                  | 1.00 | 0.1644 | 0.1750 | 0.1626 |
| 20              | QPSK       | 100     | 0         | 20.62                 | 20.30                    | 20.35                  | 1.00 | 0.1452 | 0.1349 | 0.1365 |
| 20              | 16QAM      | 1       | 0         | 20.91                 | 20.27                    | 20.38                  | 1.00 | 0.1552 | 0.1340 | 0.1374 |
| 20              | 16QAM      | 1       | 99        | 20.21                 | 20.42                    | 20.22                  | 1.00 | 0.1321 | 0.1387 | 0.1324 |
| 20              | 16QAM      | 100     | 0         | 19.64                 | 19.30                    | 19.37                  | 1.00 | 0.1159 | 0.1072 | 0.1089 |
| Channel         |            |         |           | 55315                 | 55990                    | 56665                  | Gain | L      | M      | H      |
| Frequency (MHz) |            |         |           | 3557.5                | 3625                     | 3692.5                 |      |        |        |        |
| 15              | QPSK       | 1       | 0         | 21.49                 | 21.18                    | 21.38                  | 1.00 | 0.1774 | 0.1652 | 0.1730 |
| 15              | QPSK       | 1       | 74        | 21.47                 | 21.31                    | 21.14                  | 1.00 | 0.1766 | 0.1702 | 0.1637 |
| 15              | QPSK       | 75      | 0         | 20.79                 | 20.32                    | 20.38                  | 1.00 | 0.1510 | 0.1355 | 0.1374 |
| 15              | 16QAM      | 1       | 0         | 20.88                 | 20.27                    | 20.45                  | 1.00 | 0.1542 | 0.1340 | 0.1396 |
| 15              | 16QAM      | 1       | 74        | 20.57                 | 20.43                    | 20.21                  | 1.00 | 0.1435 | 0.1390 | 0.1321 |
| 15              | 16QAM      | 75      | 0         | 19.86                 | 19.33                    | 19.39                  | 1.00 | 0.1219 | 0.1079 | 0.1094 |
| Channel         |            |         |           | 55290                 | 55990                    | 56690                  | Gain | L      | M      | H      |
| Frequency (MHz) |            |         |           | 3555                  | 3625                     | 3695                   |      |        |        |        |
| 10              | QPSK       | 1       | 0         | 21.48                 | 21.17                    | 21.26                  | 1.00 | 0.1770 | 0.1648 | 0.1683 |
| 10              | QPSK       | 1       | 49        | 21.37                 | 21.27                    | 21.42                  | 1.00 | 0.1726 | 0.1687 | 0.1746 |
| 10              | QPSK       | 50      | 0         | 20.90                 | 20.29                    | 20.54                  | 1.00 | 0.1549 | 0.1346 | 0.1426 |
| 10              | 16QAM      | 1       | 0         | 20.81                 | 20.34                    | 20.37                  | 1.00 | 0.1517 | 0.1361 | 0.1371 |
| 10              | 16QAM      | 1       | 49        | 20.78                 | 20.37                    | 20.73                  | 1.00 | 0.1507 | 0.1371 | 0.1489 |
| 10              | 16QAM      | 50      | 0         | 19.93                 | 19.32                    | 19.56                  | 1.00 | 0.1239 | 0.1076 | 0.1138 |
| Channel         |            |         |           | 55265                 | 55990                    | 56715                  | Gain | L      | M      | H      |
| Frequency (MHz) |            |         |           | 3552.5                | 3625                     | 3697.5                 |      |        |        |        |
| 5               | QPSK       | 1       | 0         | 21.43                 | 21.19                    | 21.28                  | 1.00 | 0.1750 | 0.1656 | 0.1690 |
| 5               | QPSK       | 1       | 24        | 21.46                 | 21.20                    | 21.04                  | 1.00 | 0.1762 | 0.1660 | 0.1600 |
| 5               | QPSK       | 25      | 0         | 20.98                 | 20.26                    | 20.26                  | 1.00 | 0.1578 | 0.1337 | 0.1337 |
| 5               | 16QAM      | 1       | 0         | 20.79                 | 20.26                    | 20.29                  | 1.00 | 0.1510 | 0.1337 | 0.1346 |
| 5               | 16QAM      | 1       | 24        | 20.75                 | 20.35                    | 20.13                  | 1.00 | 0.1496 | 0.1365 | 0.1297 |
| 5               | 16QAM      | 25      | 0         | 19.99                 | 19.26                    | 19.24                  | 1.00 | 0.1256 | 0.1062 | 0.1057 |



**ACLR**

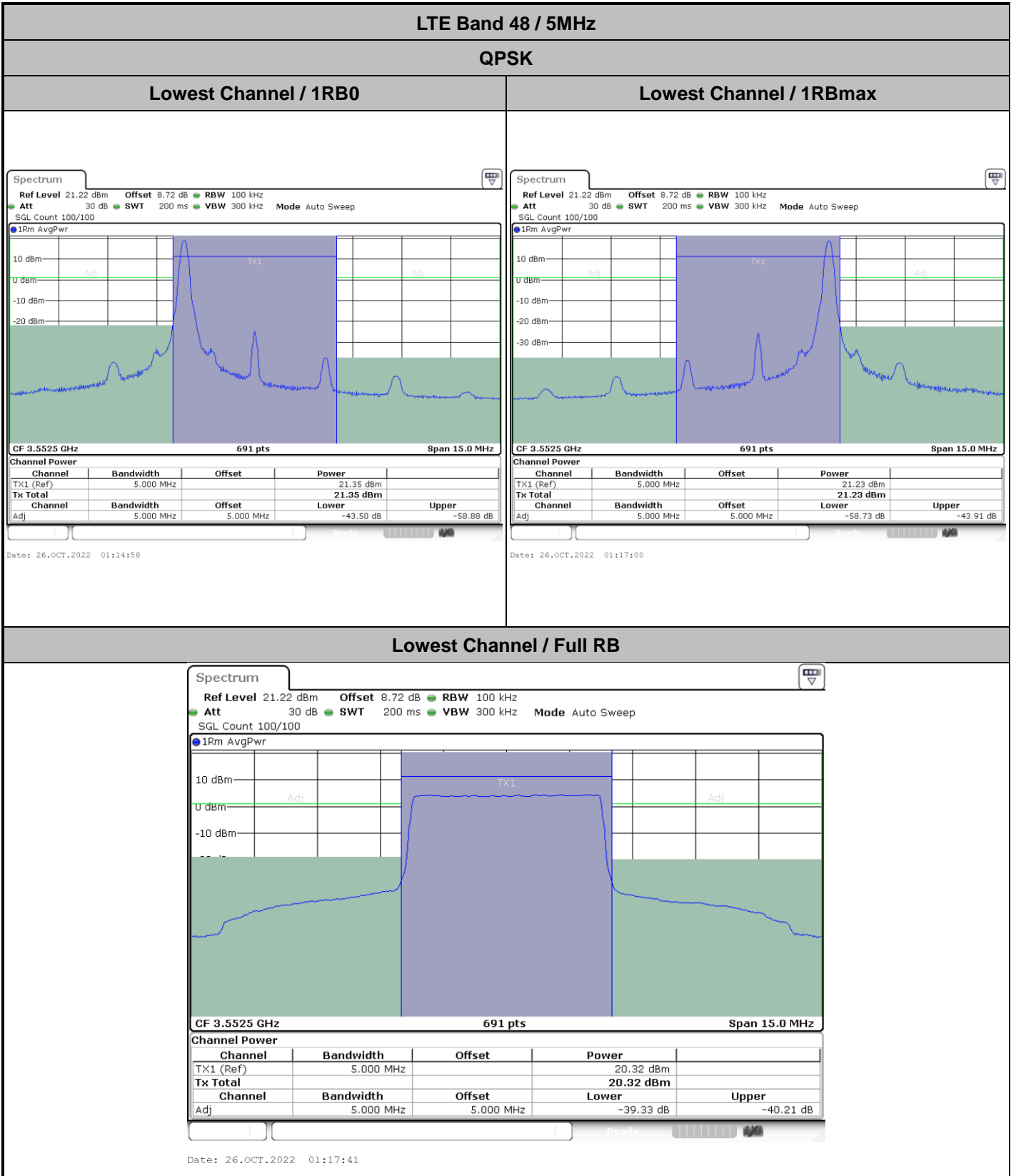



LTE Band 48 / 5MHz

QPSK

Middle Channel / 1RB0

Middle Channel / 1RBmax

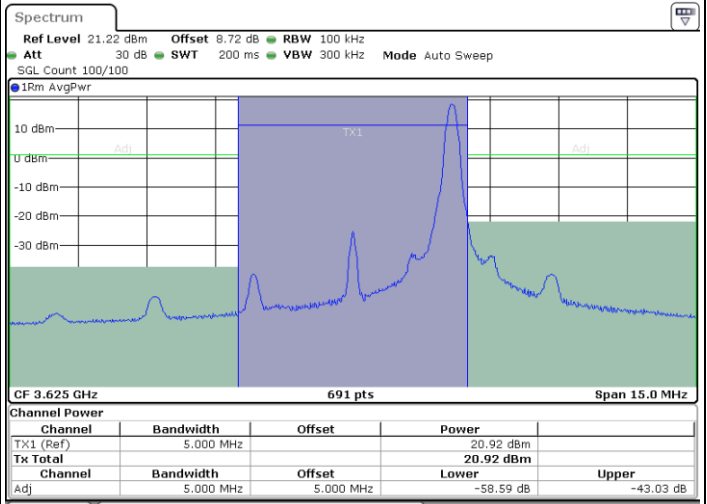
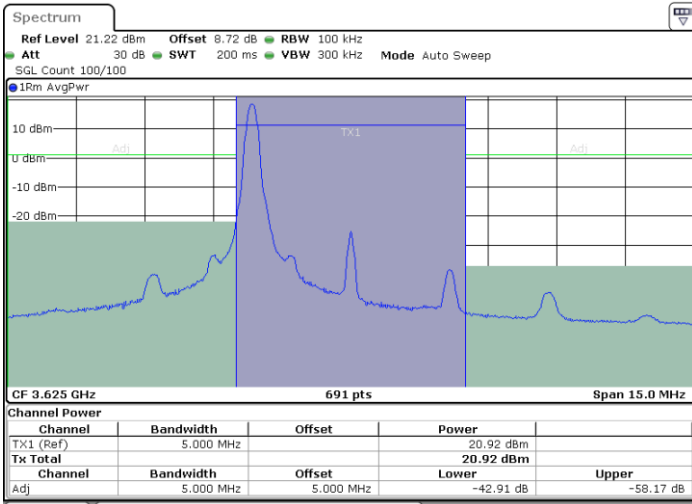

Date: 26.OCT.2022 01:19:02

Date: 26.OCT.2022 01:21:01

Middle Channel / Full RB

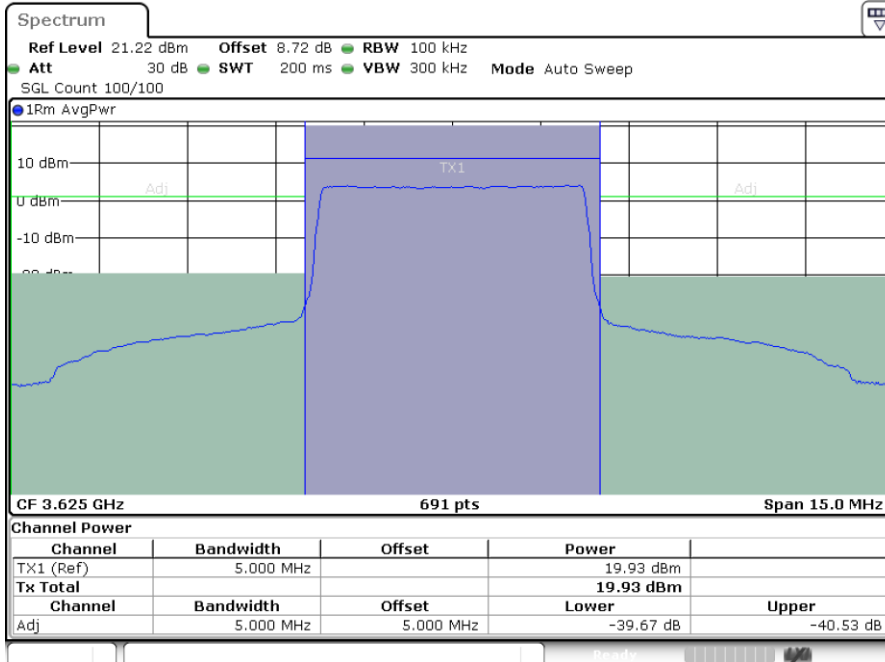

Date: 26.OCT.2022 01:21:40



LTE Band 48 / 5MHz

QPSK

Highest Channel / 1RB0

Highest Channel / 1RBmax

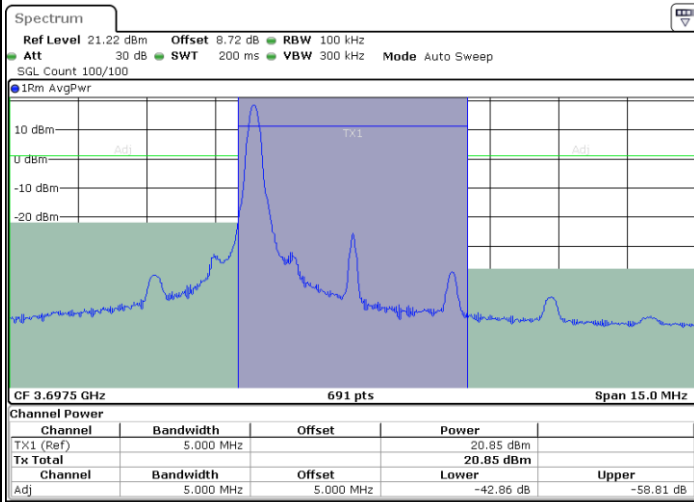

Date: 26.OCT.2022 01:23:02

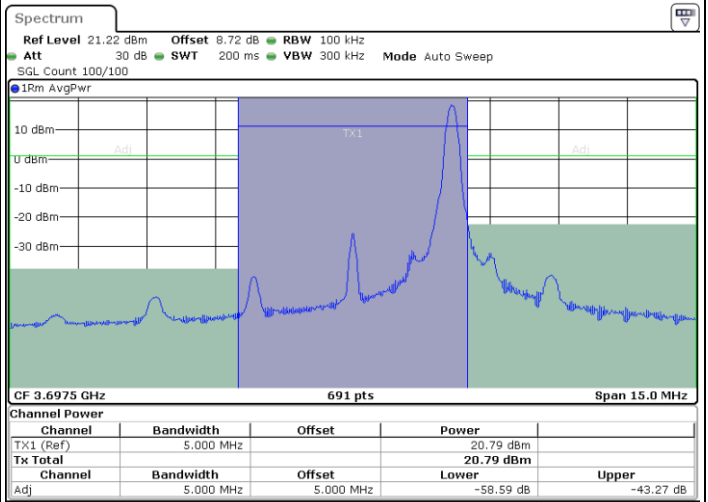

Date: 26.OCT.2022 01:25:06

Highest Channel / Full RB

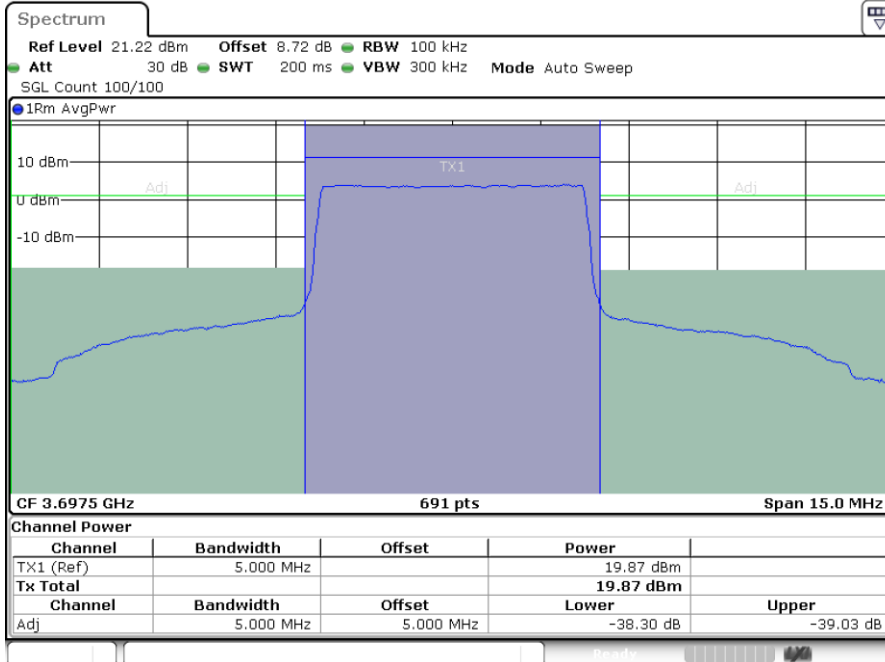

Date: 26.OCT.2022 01:25:47



**LTE Band 48 / 10MHz**

**QPSK**

**Lowest Channel / 1RB0**

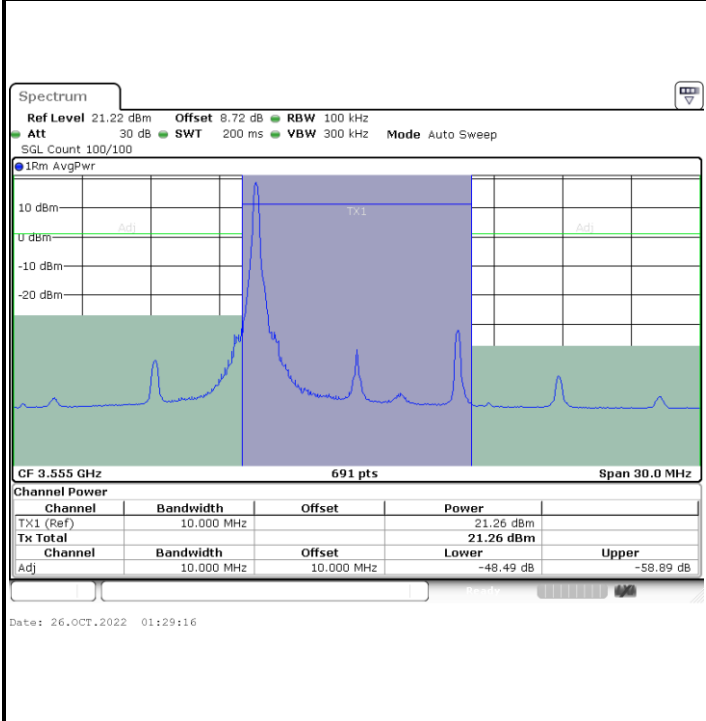

**Lowest Channel / 1RBmax**

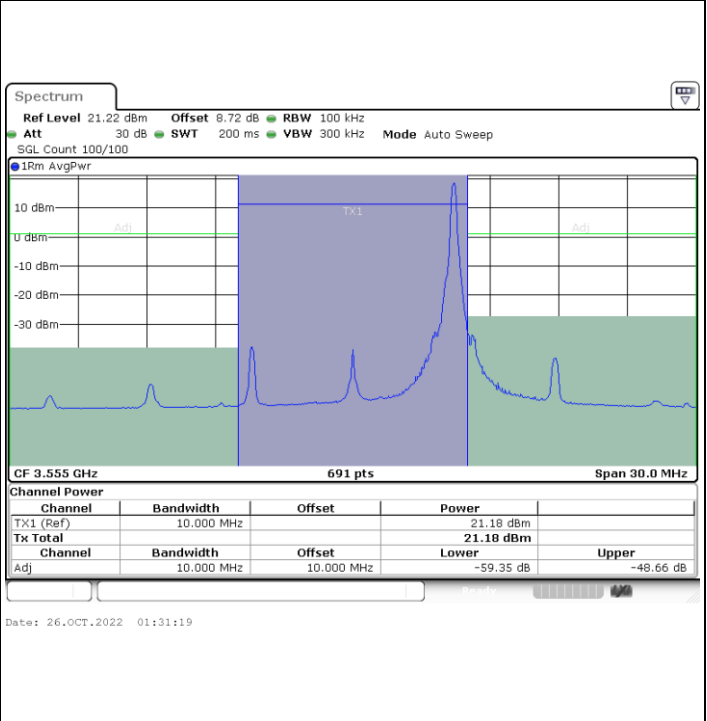

**Lowest Channel / Full RB**

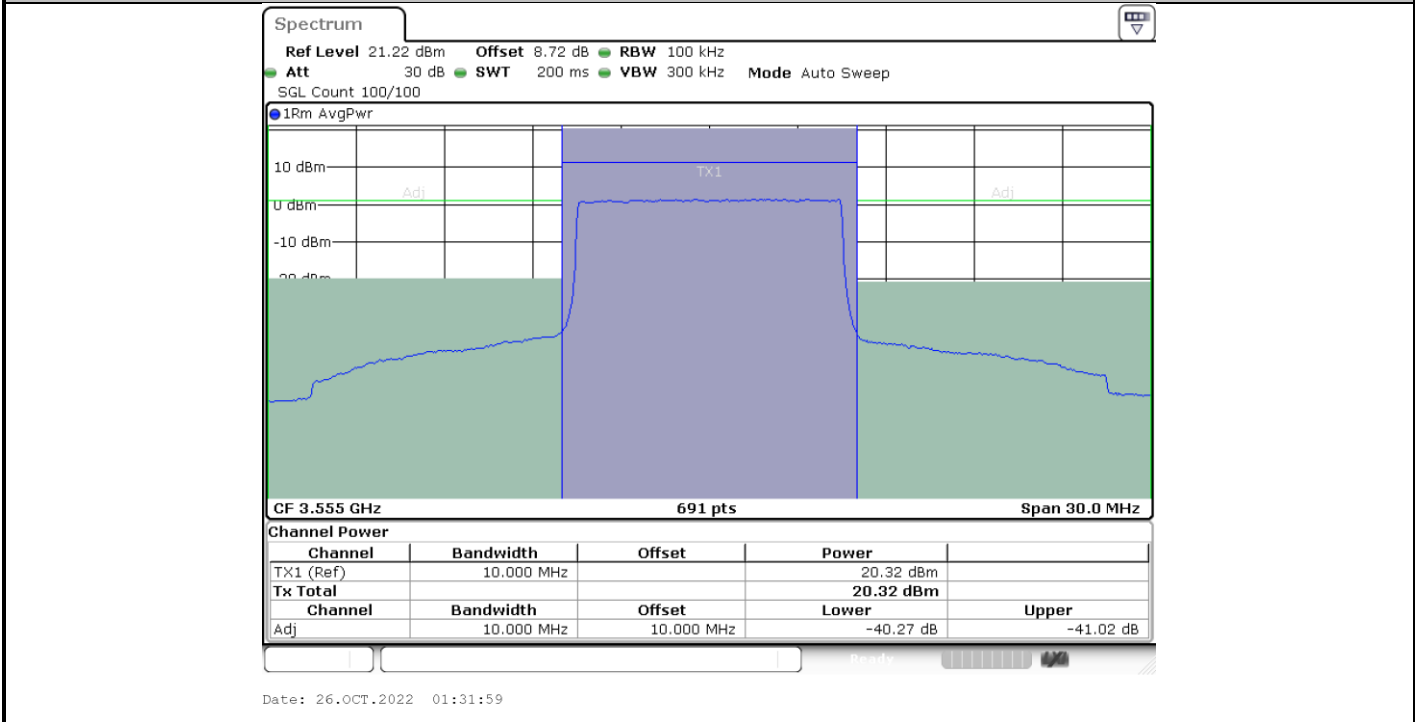



LTE Band 48 / 10MHz

QPSK

MiddleChannel / 1RB0

Middle Channel / 1RBmax

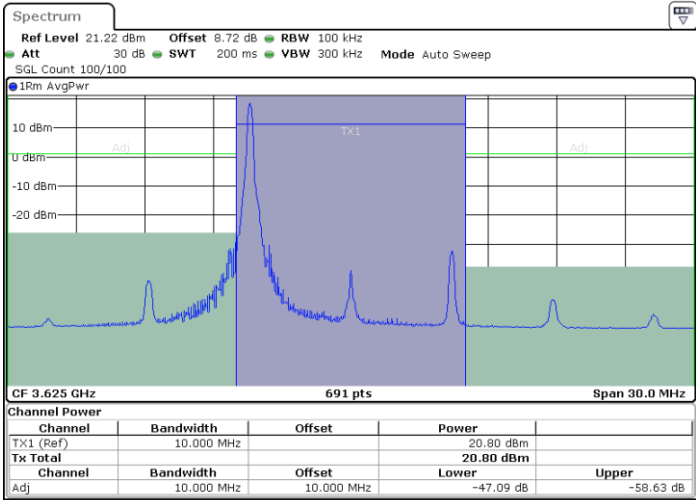

Date: 26.OCT.2022 01:33:21

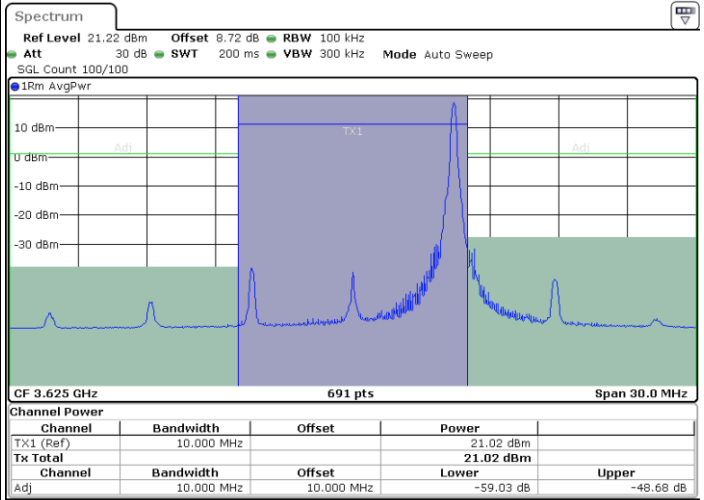

Date: 26.OCT.2022 01:34:41

Middle Channel / Full RB

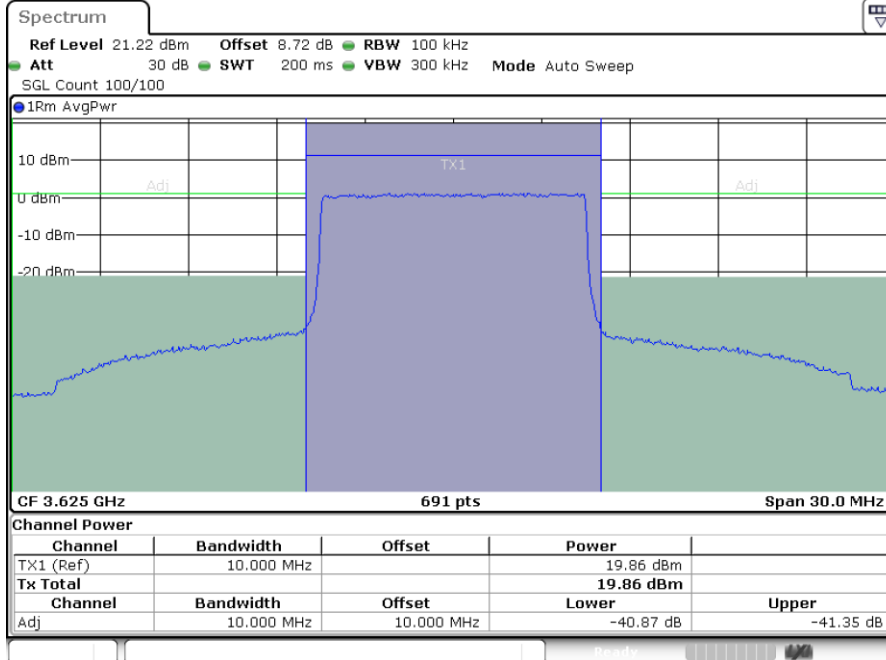

Date: 26.OCT.2022 01:36:42



**LTE Band 48 / 10MHz**

**QPSK**

**Highest Channel / 1RB0**

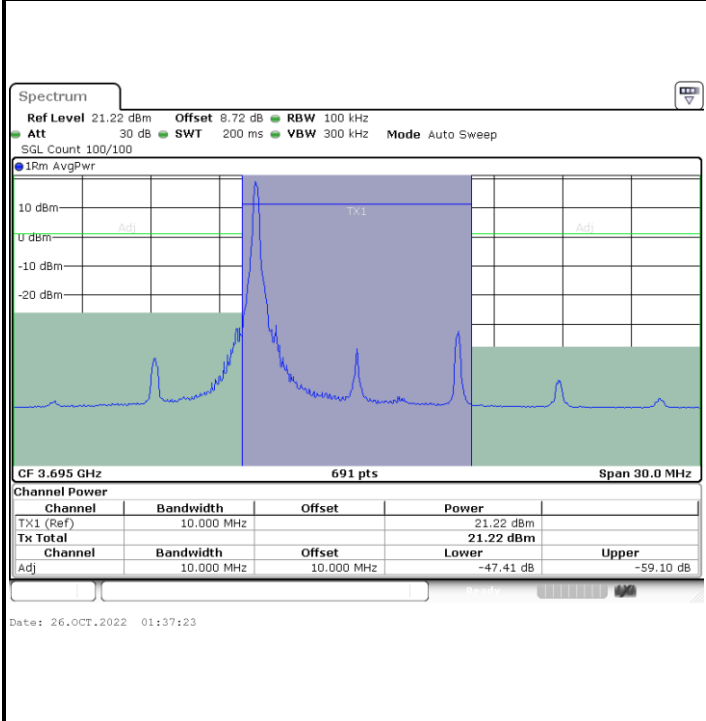

**Highest Channel / 1RBmax**

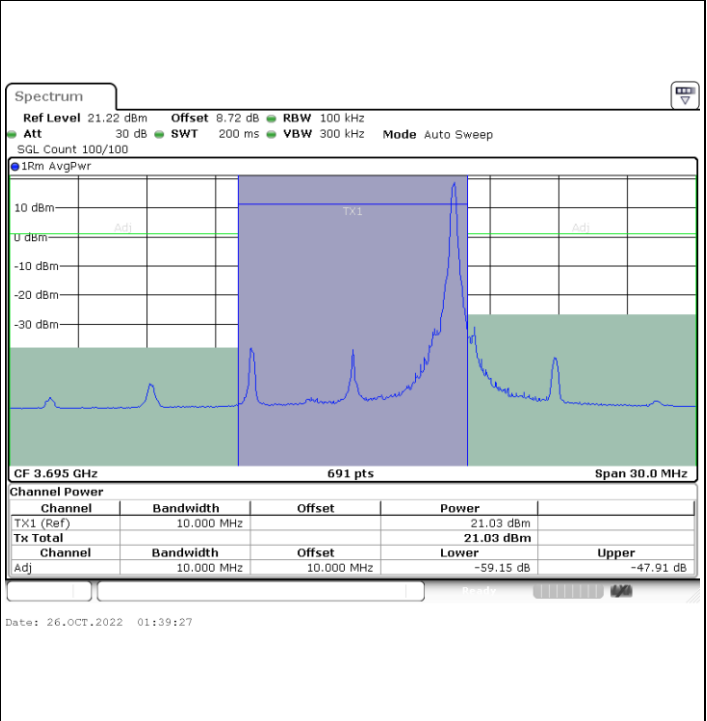

**Highest Channel / Full RB**

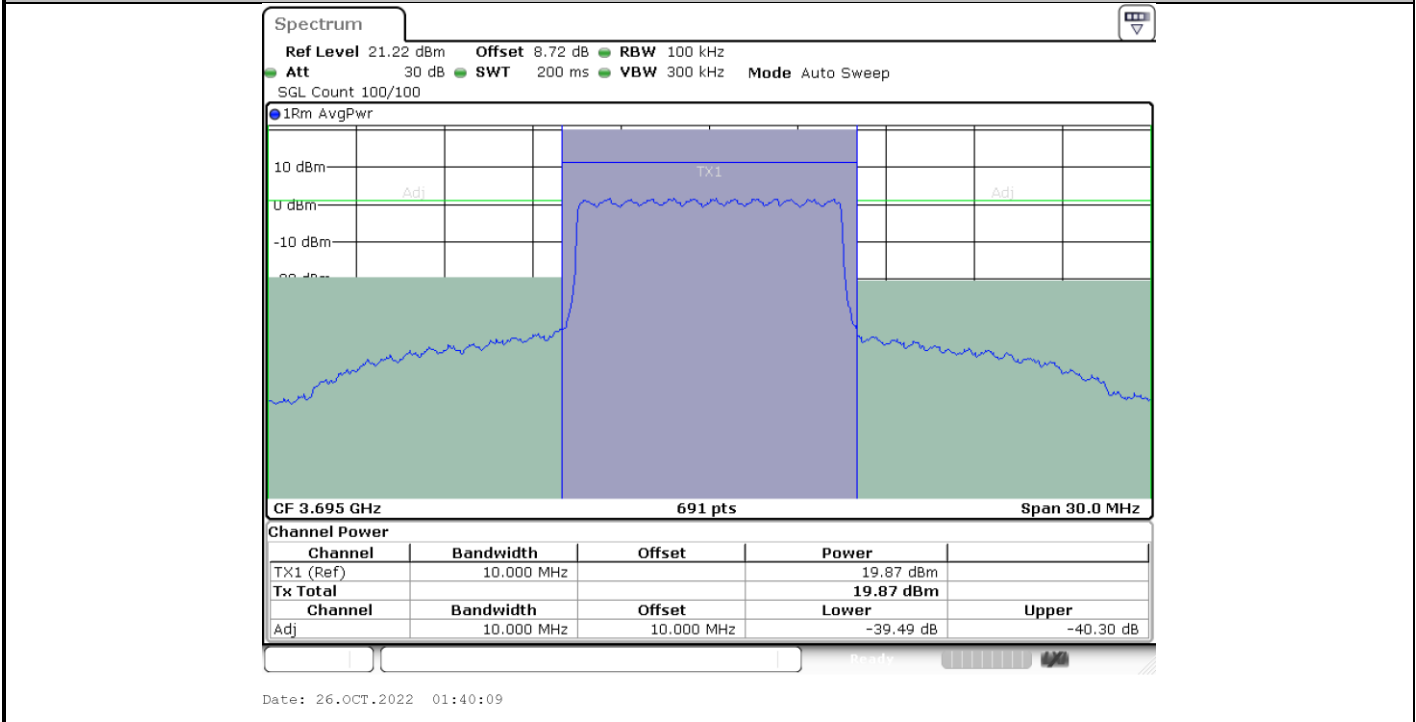



**LTE Band 48 / 15MHz**

**QPSK**

**Lowest Channel / 1RB0**

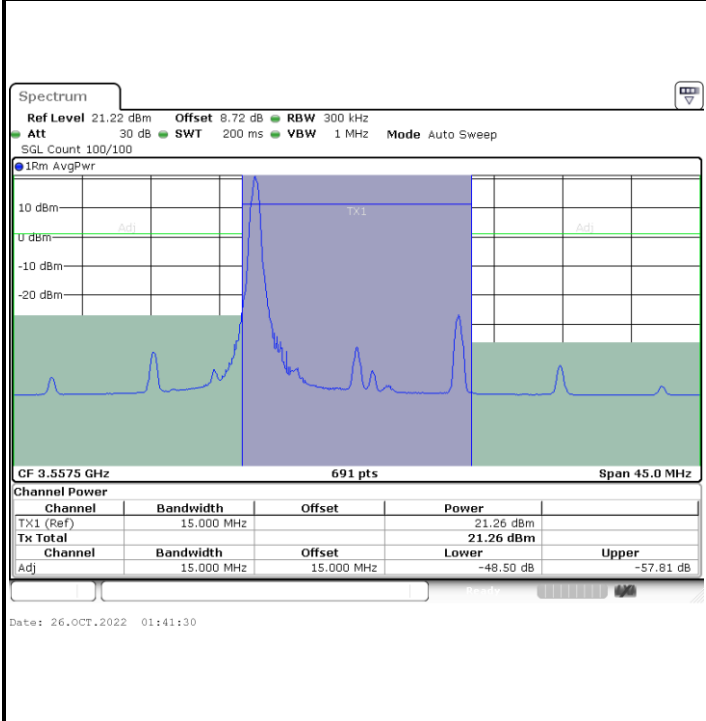

**Lowest Channel / 1RBmax**

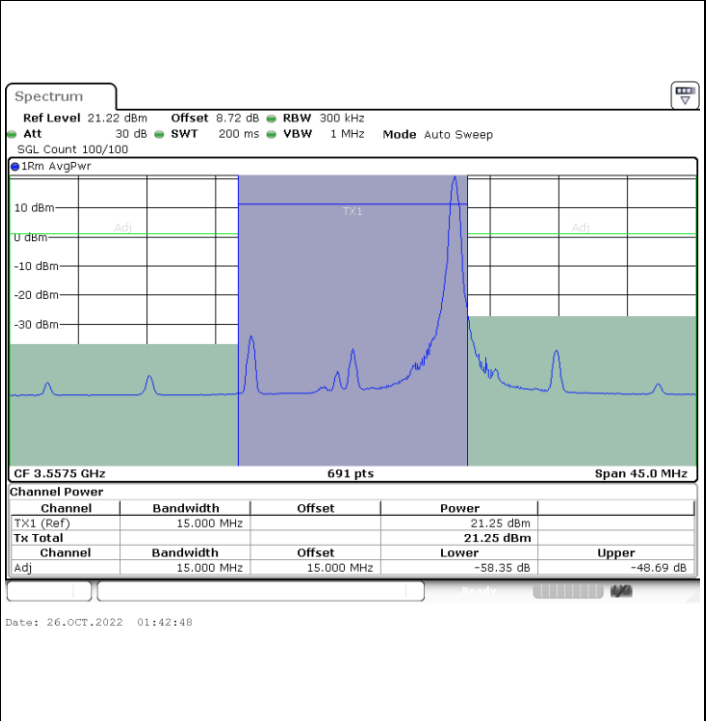

**Lowest Channel / Full RB**

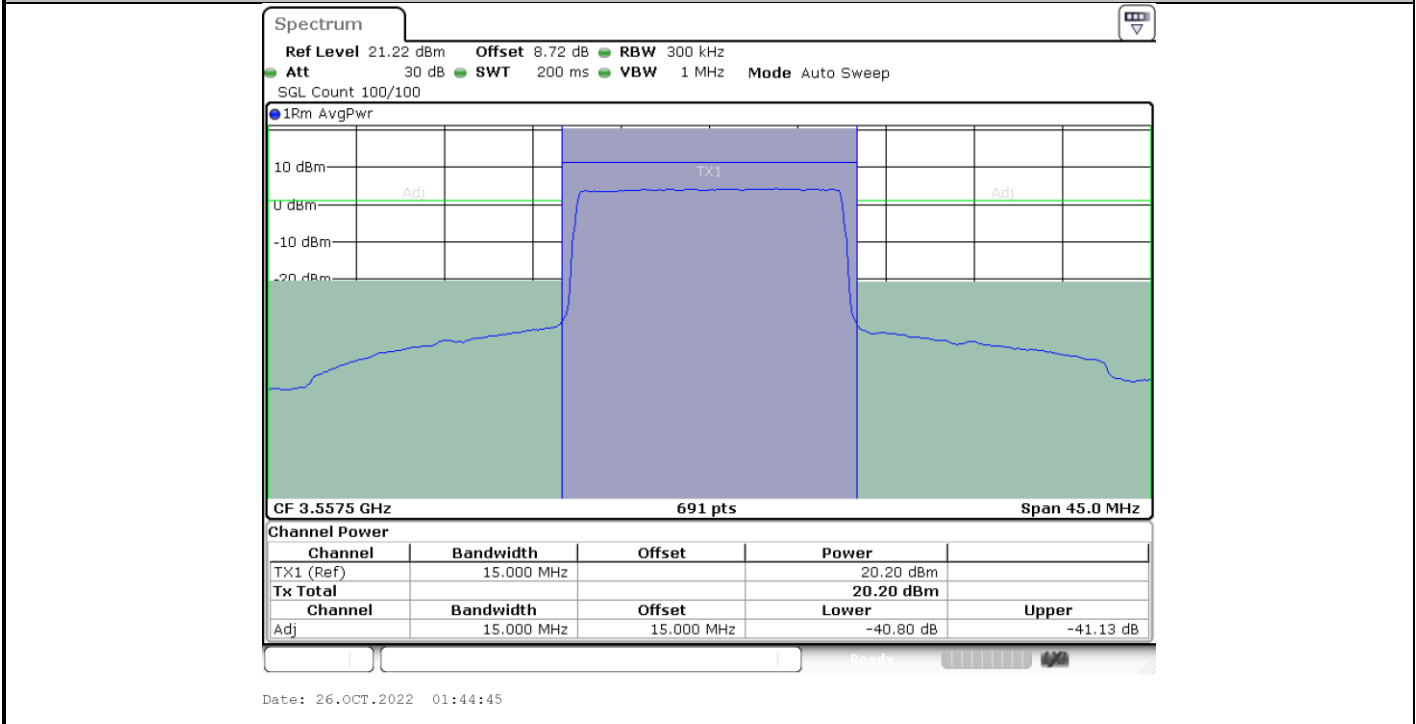





LTE Band 48 / 15MHz

QPSK

Middle Channel / 1RB0

Middle Channel / 1RBmax

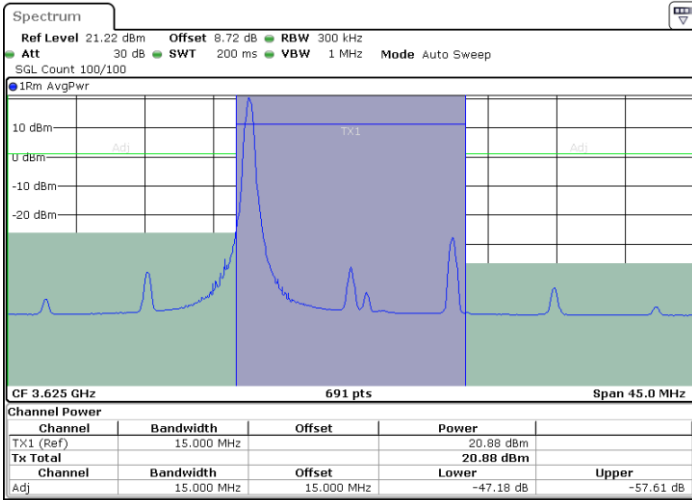

Date: 26.OCT.2022 01:45:24

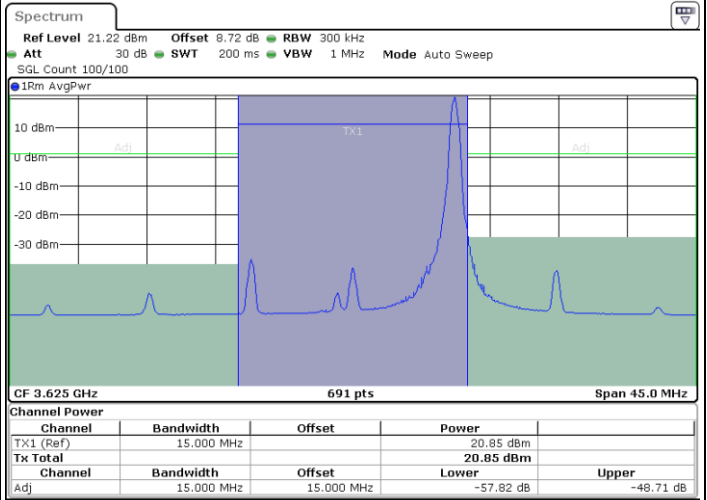

Date: 26.OCT.2022 01:47:19

Middle Channel / Full RB

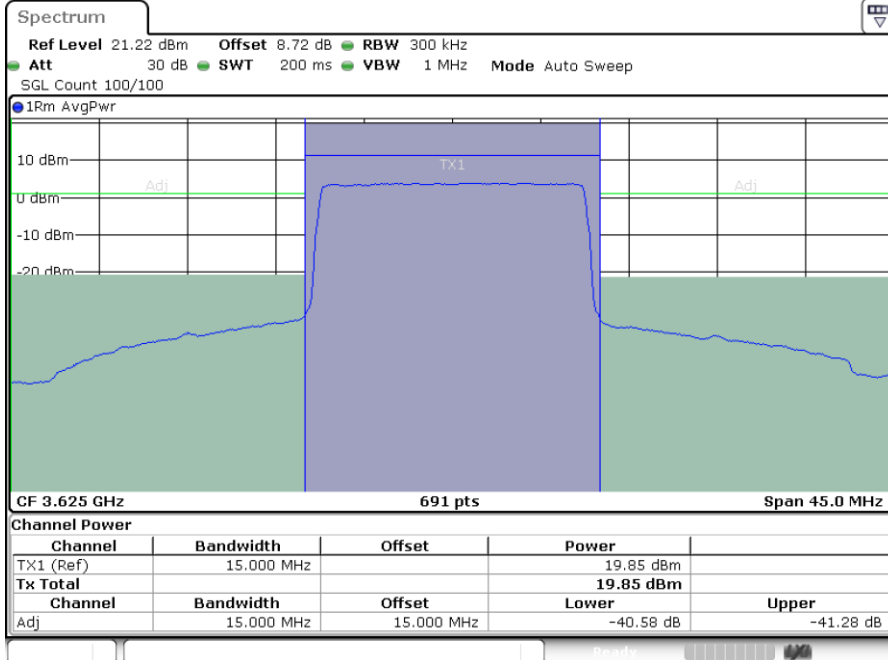

Date: 26.OCT.2022 01:47:58



LTE Band 48 / 15MHz

QPSK

Highest Channel / 1RB0

Highest Channel / 1RBmax

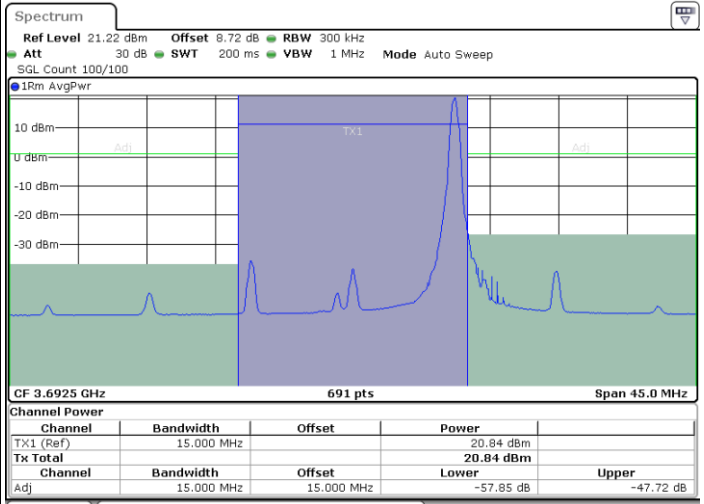
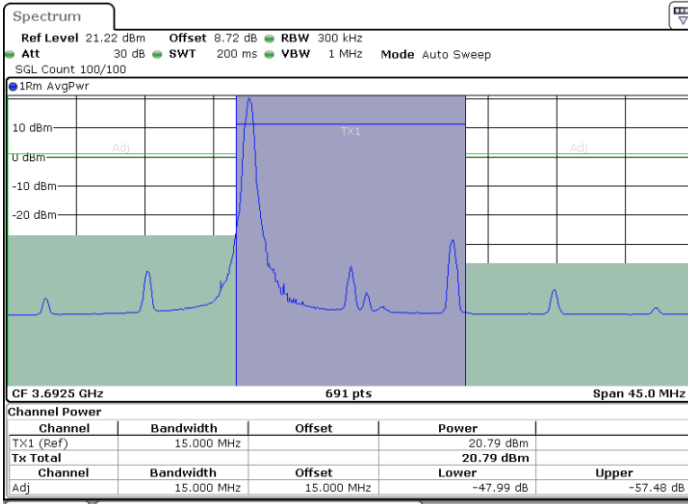

Date: 26.OCT.2022 01:49:15

Date: 26.OCT.2022 01:51:12

Highest Channel / Full RB

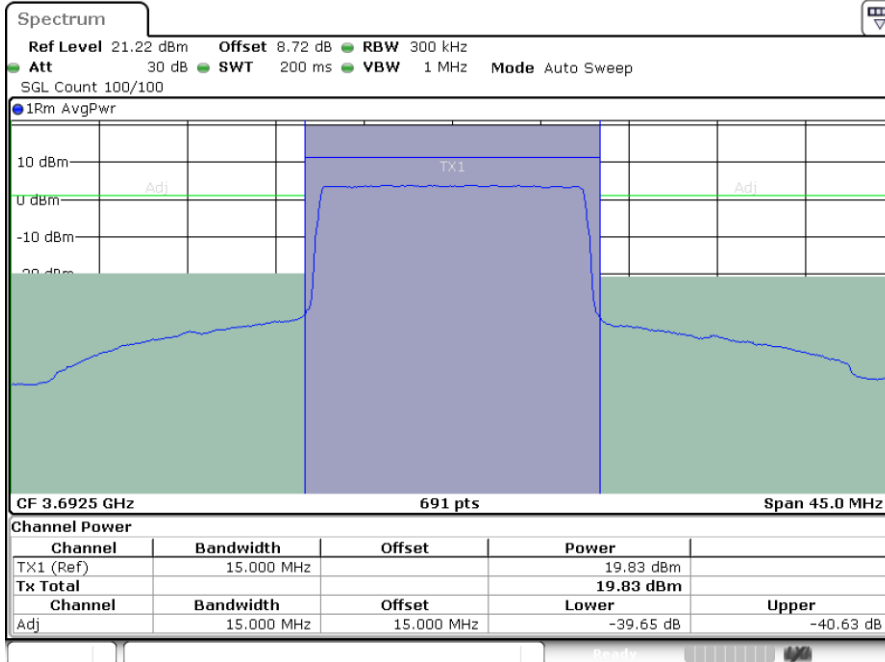

Date: 26.OCT.2022 01:51:51



LTE Band 48 / 20MHz

QPSK

Lowest Channel / 1RB0

Lowest Channel / 1RBmax

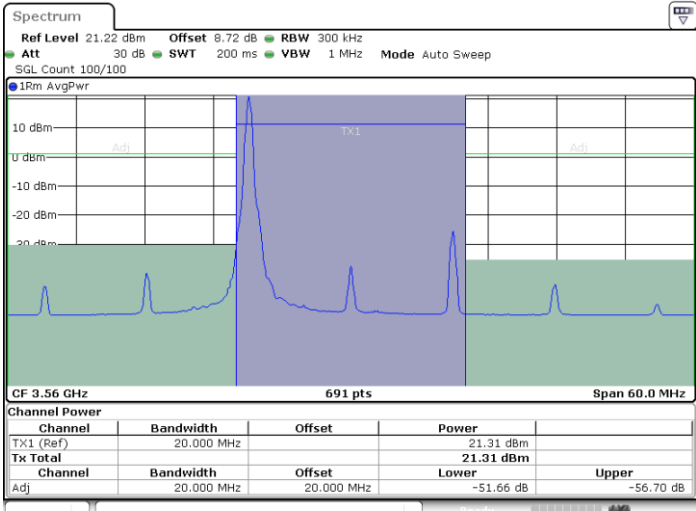

Date: 26.OCT.2022 01:53:09

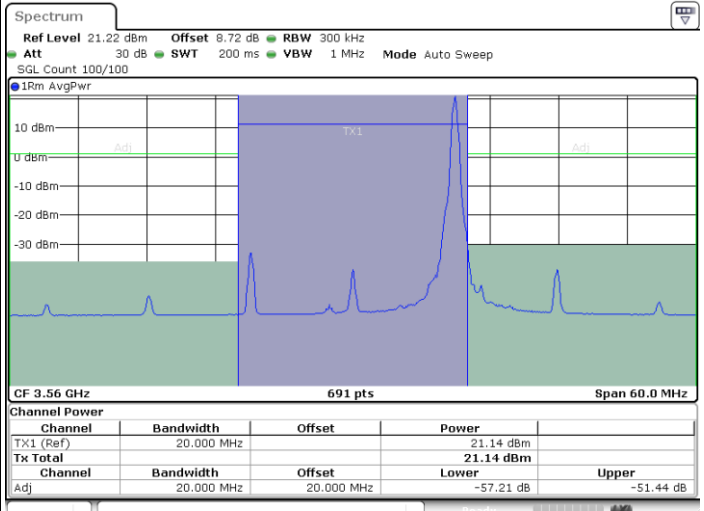

Date: 26.OCT.2022 01:55:06

Lowest Channel / Full RB

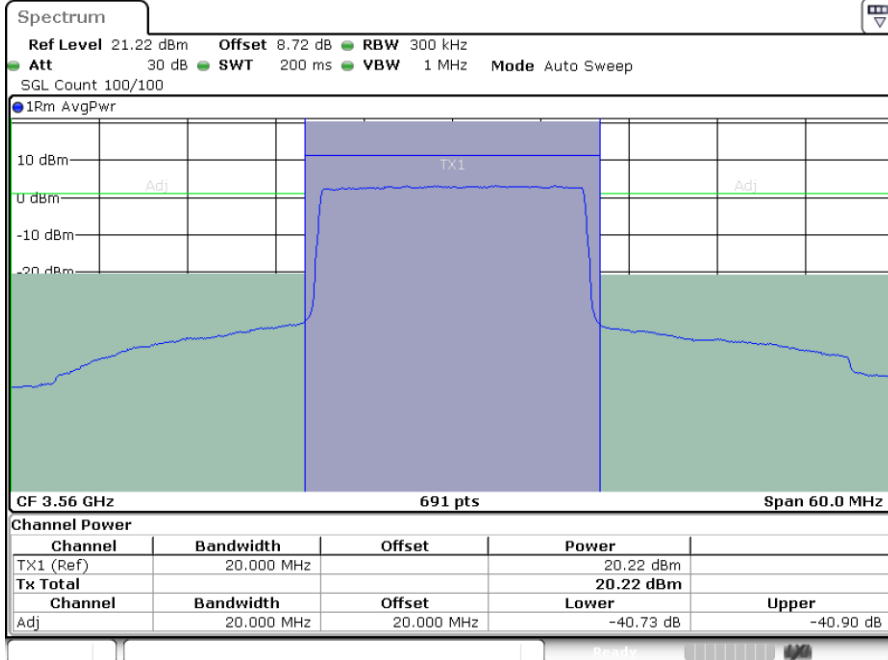

Date: 26.OCT.2022 01:55:45



LTE Band 48 / 20MHz

QPSK

Middle Channel / 1RB0

Middle Channel / 1RBmax

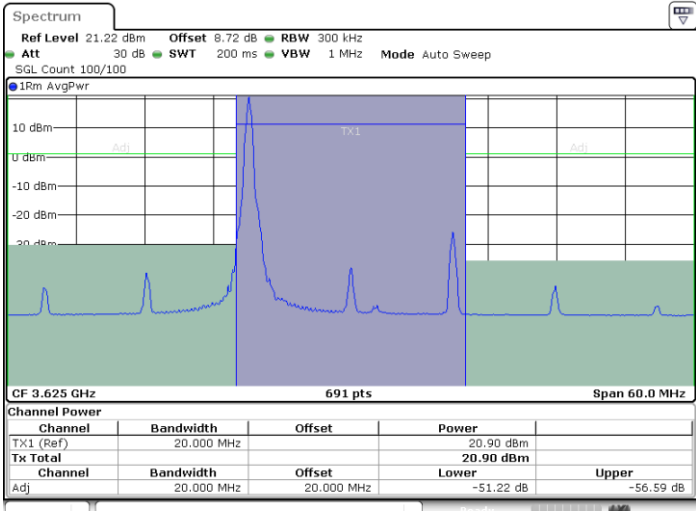

Date: 26.OCT.2022 01:57:02

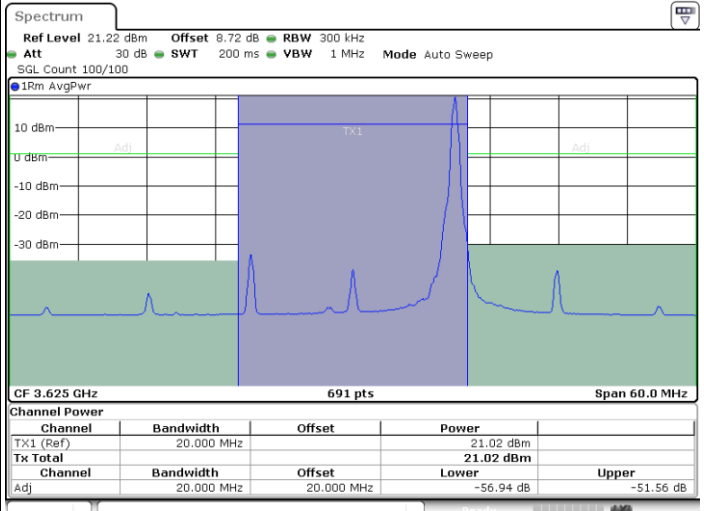

Date: 26.OCT.2022 01:58:56

Middle Channel / Full RB

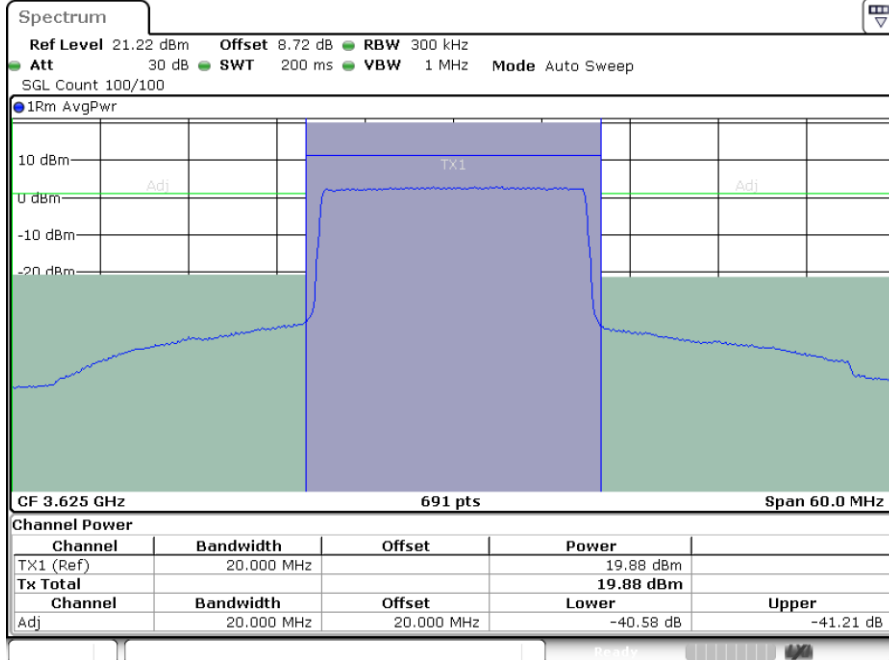

Date: 26.OCT.2022 01:59:35



LTE Band 48 / 20MHz

QPSK

Highest Channel / 1RB0

Highest Channel / 1RBmax

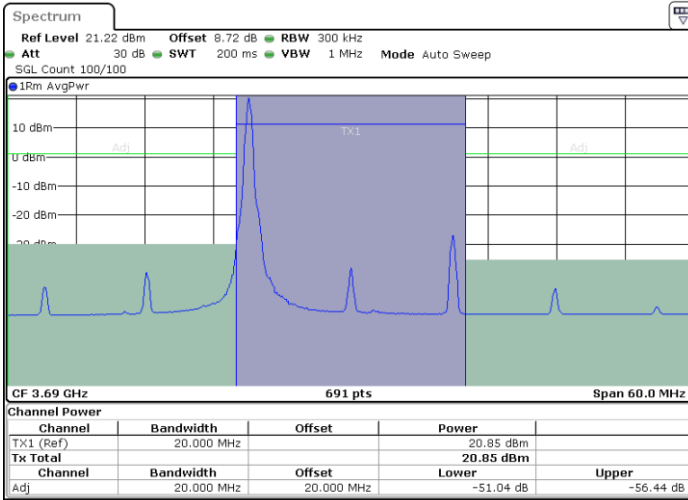

Date: 26.OCT.2022 02:00:51

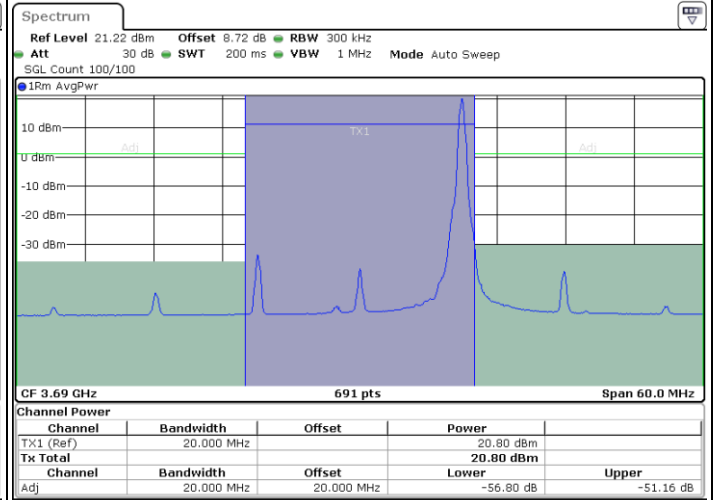

Date: 26.OCT.2022 02:02:47

Highest Channel / Full RB

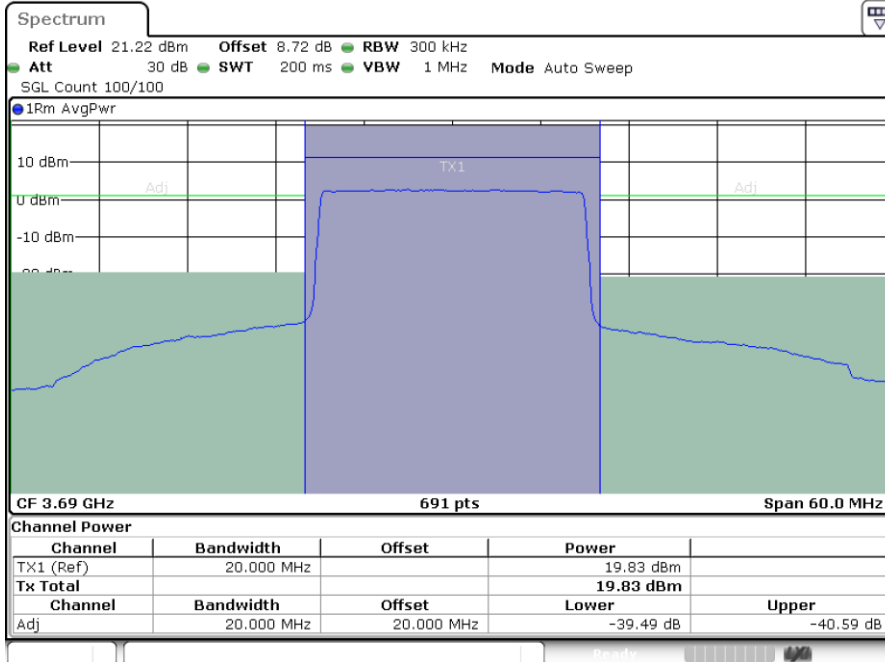

Date: 26.OCT.2022 02:03:26



LTE Band 48 / 5MHz

16QAM

Lowest Channel / 1RB0

Lowest Channel / 1RBmax

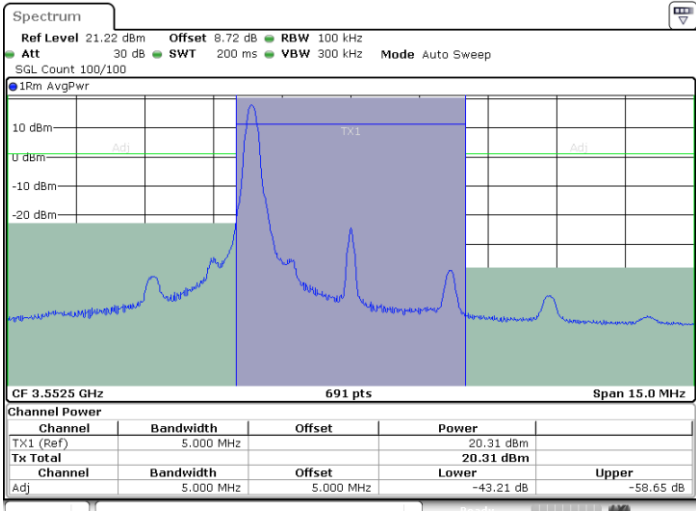

Date: 26.OCT.2022 01:15:39

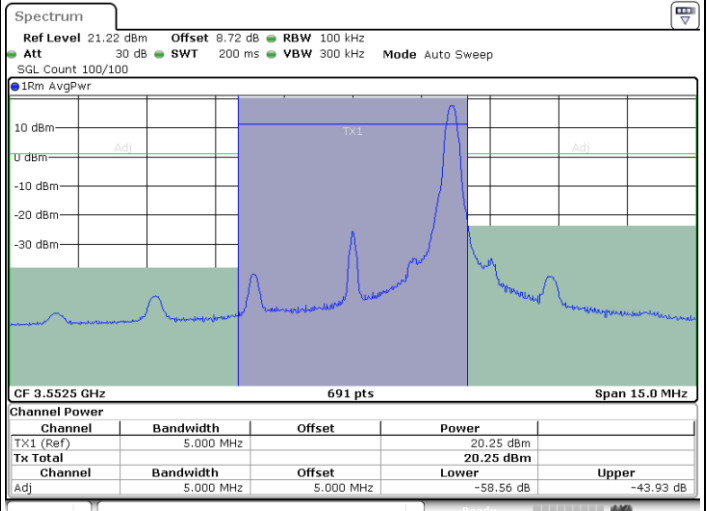

Date: 26.OCT.2022 01:16:20

Lowest Channel / Full RB

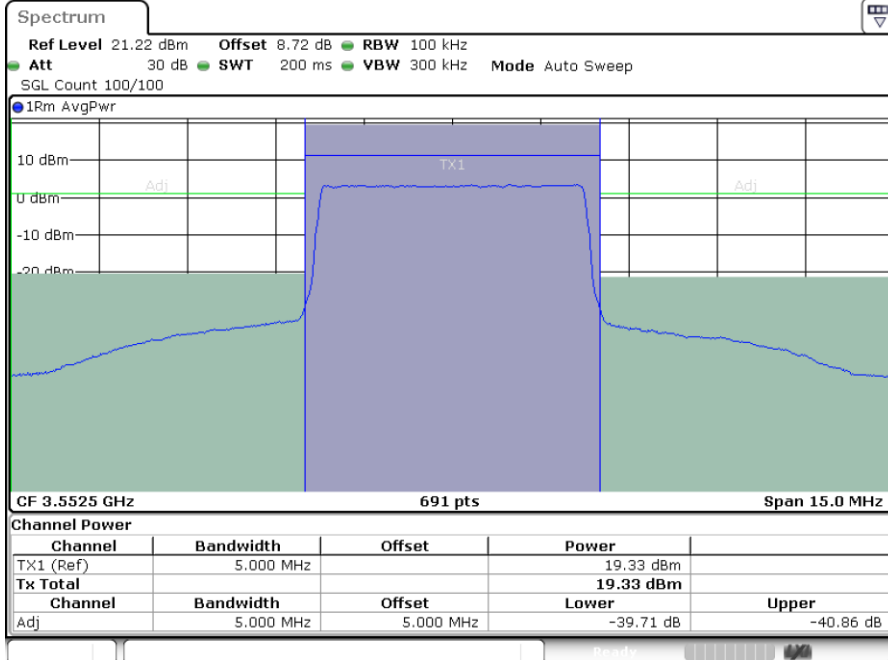

Date: 26.OCT.2022 01:18:22



LTE Band 48 / 5MHz

16QAM

Middle Channel / 1RB0

Middle Channel / 1RBmax

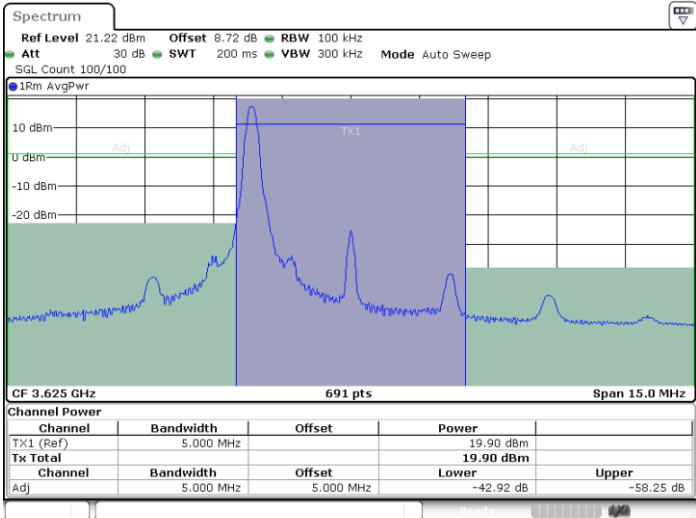

Date: 26.OCT.2022 01:19:41

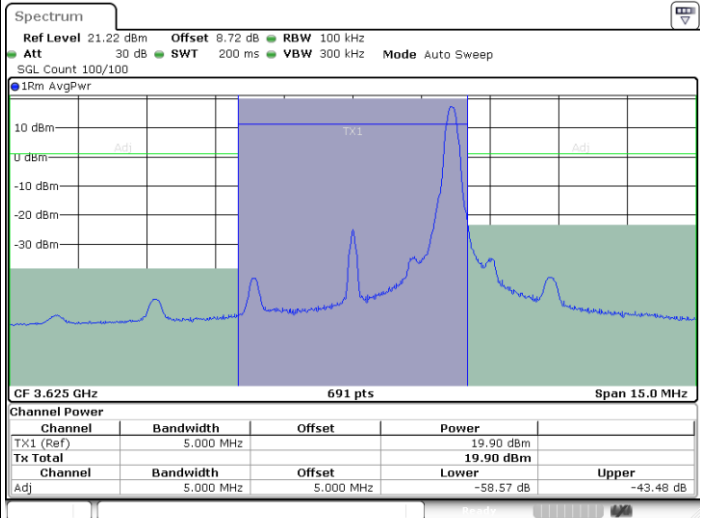

Date: 26.OCT.2022 01:20:21

Middle Channel / Full RB

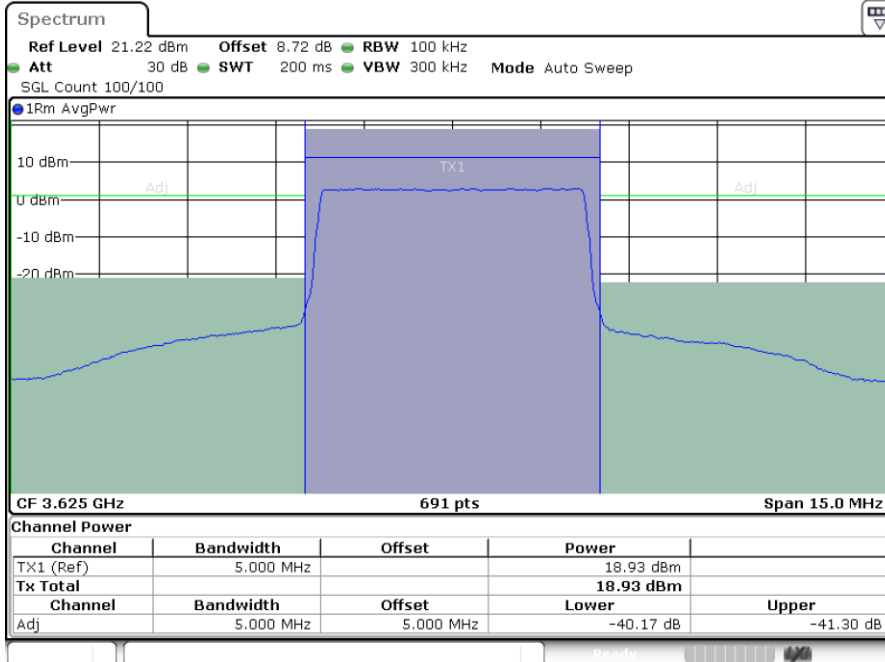

Date: 26.OCT.2022 01:22:20



LTE Band 48 / 5MHz

16QAM

Highest Channel / 1RB0

Highest Channel / 1RBmax

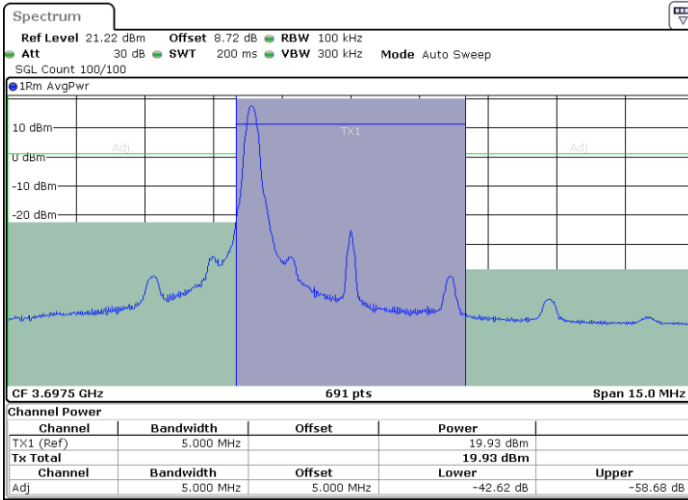

Date: 26.OCT.2022 01:23:43

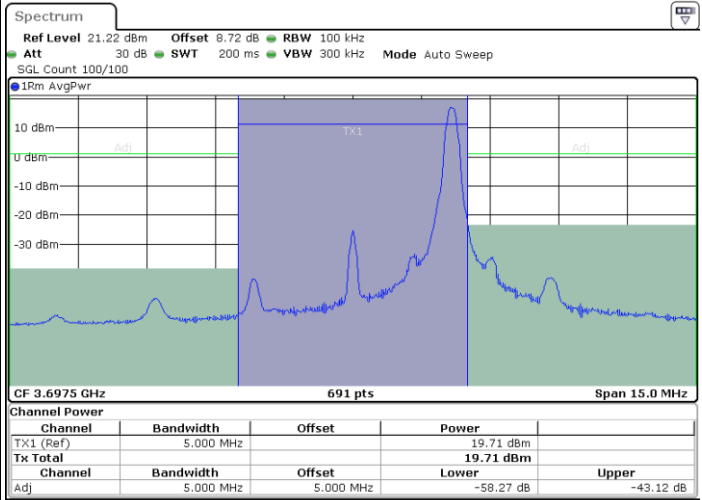

Date: 26.OCT.2022 01:24:24

Highest Channel / Full RB

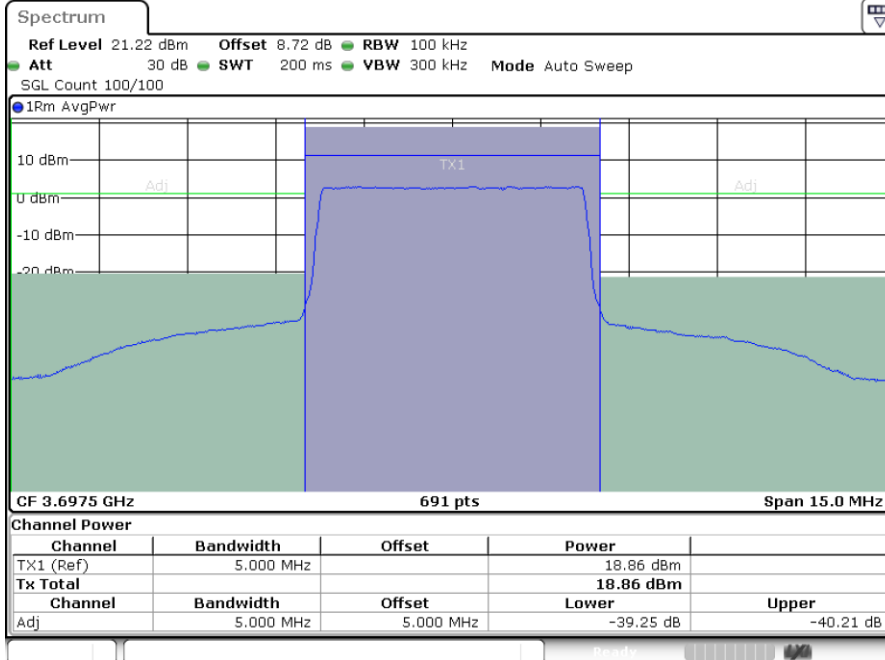

Date: 26.OCT.2022 01:26:29





LTE Band 48 / 10MHz

16QAM

Lowest Channel / 1RB0

Lowest Channel / 1RBmax

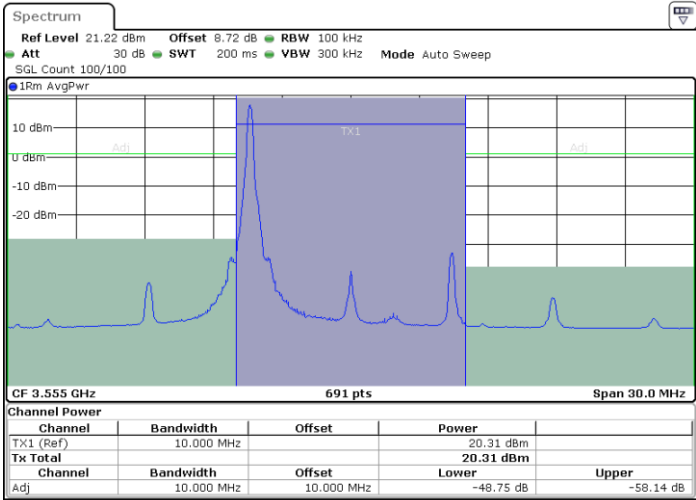

Date: 26.OCT.2022 01:29:57

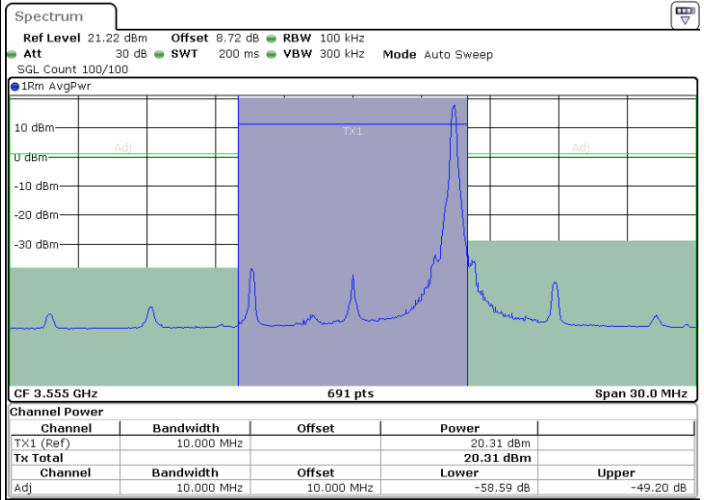

Date: 26.OCT.2022 01:30:38

Lowest Channel / Full RB

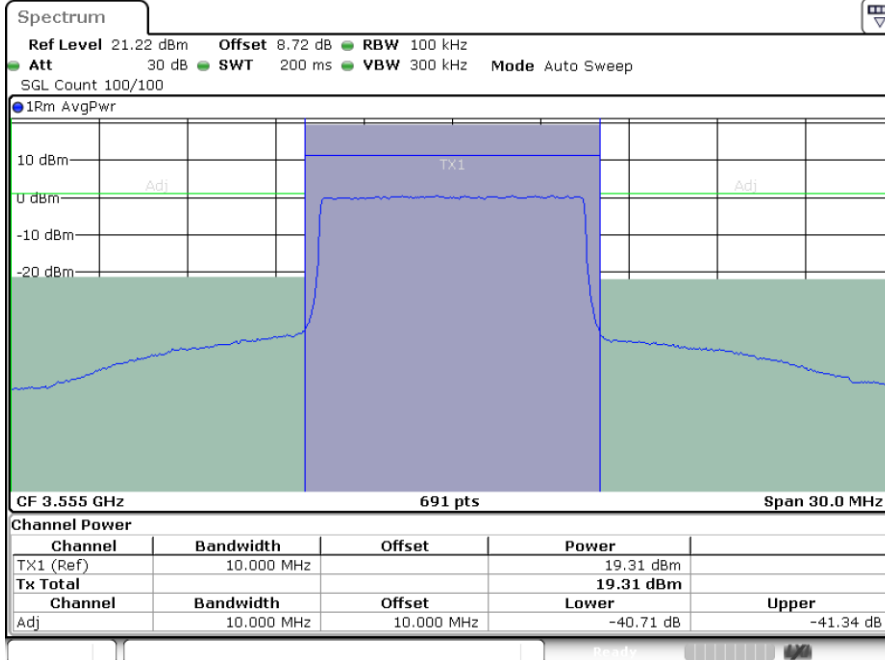

Date: 26.OCT.2022 01:32:40



LTE Band 48 / 10MHz

16QAM

MiddleChannel / 1RB0

Middle Channel / 1RBmax

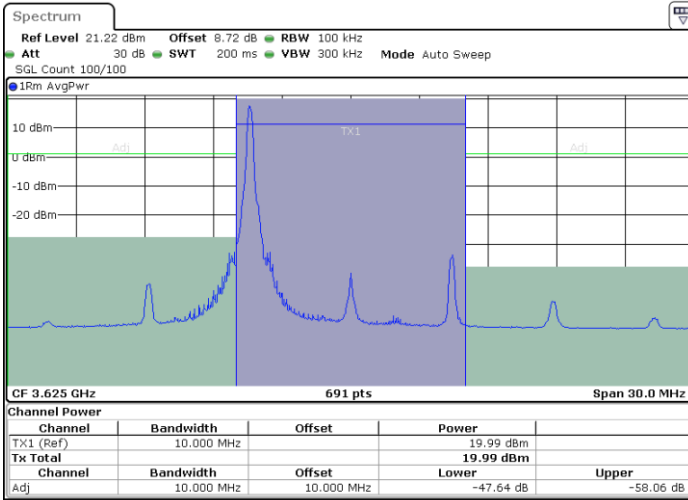

Date: 26.OCT.2022 01:34:01

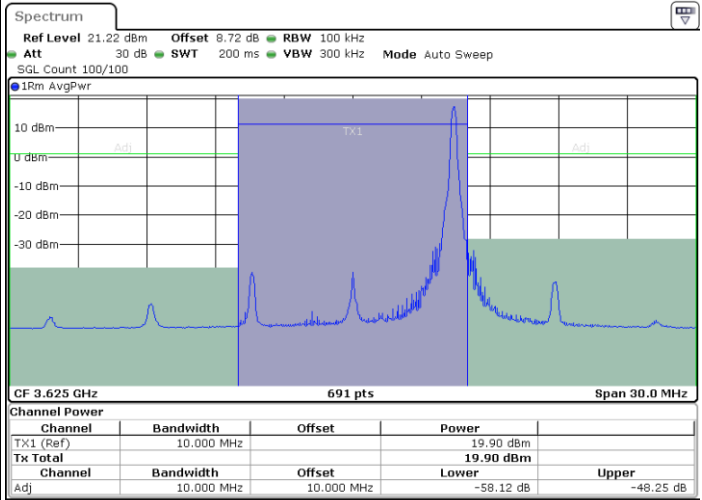

Date: 26.OCT.2022 01:35:22

Middle Channel / Full RB

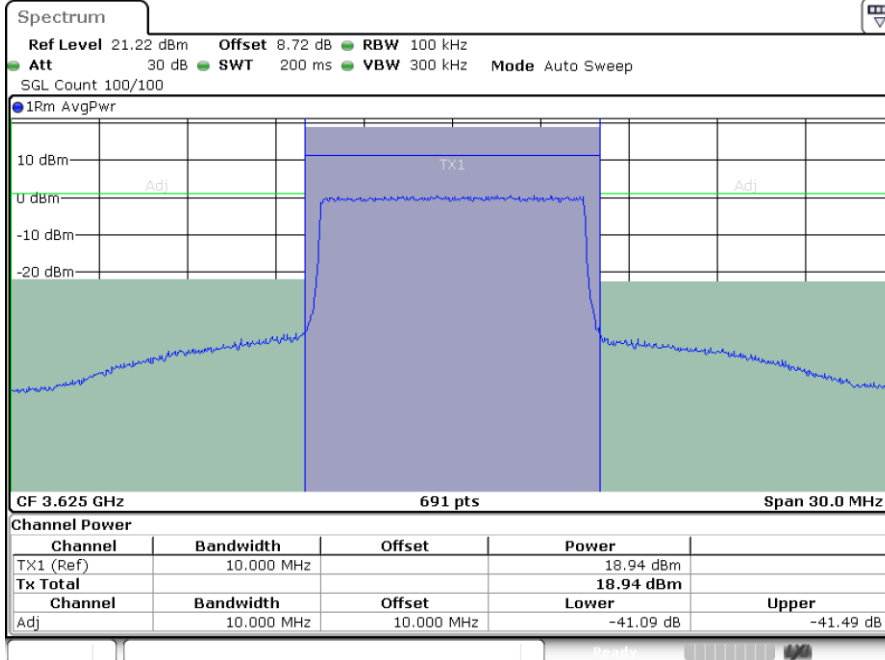

Date: 26.OCT.2022 01:36:02



LTE Band 48 / 10MHz

16QAM

Highest Channel / 1RB0

Highest Channel / 1RBmax

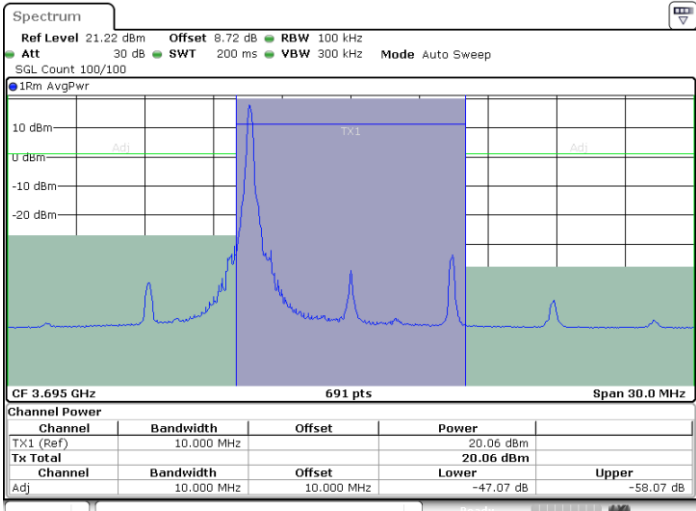

Date: 26.OCT.2022 01:38:04

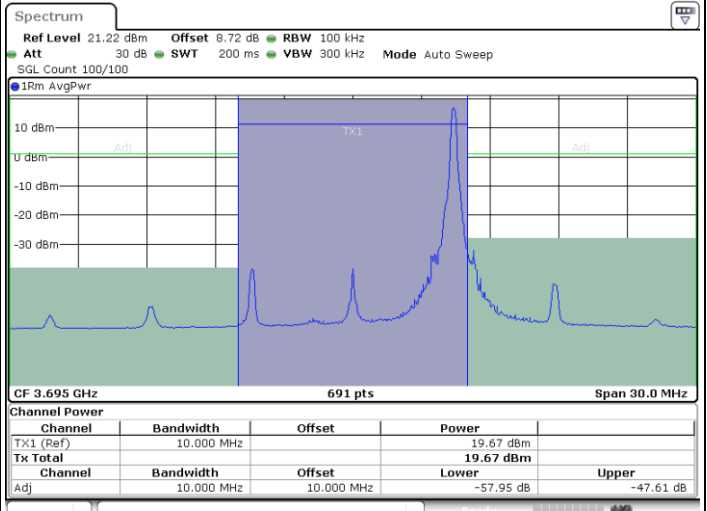

Date: 26.OCT.2022 01:38:46

Highest Channel / Full RB

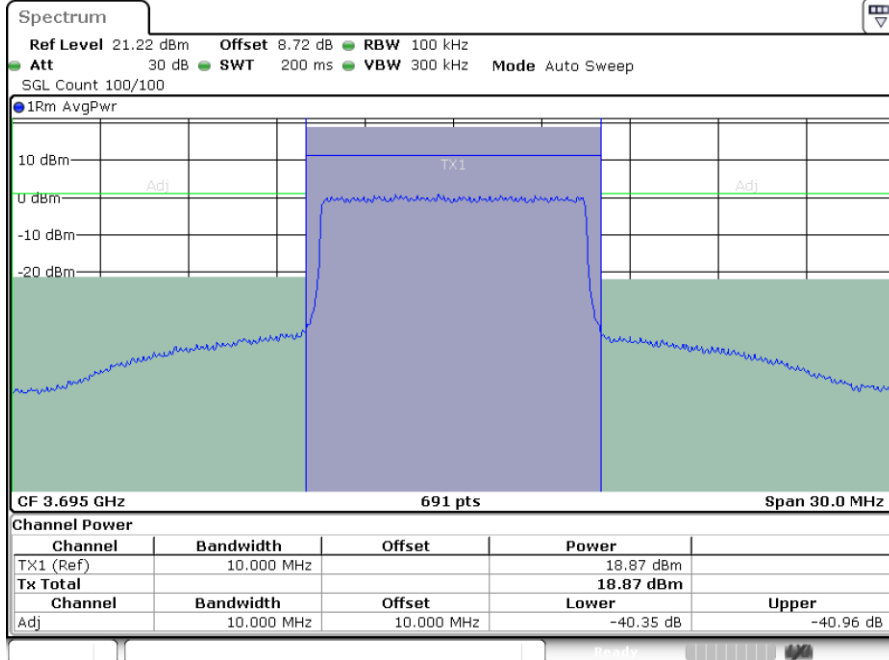

Date: 26.OCT.2022 01:40:50



LTE Band 48 / 15MHz

16QAM

Lowest Channel / 1RB0

Lowest Channel / 1RBmax

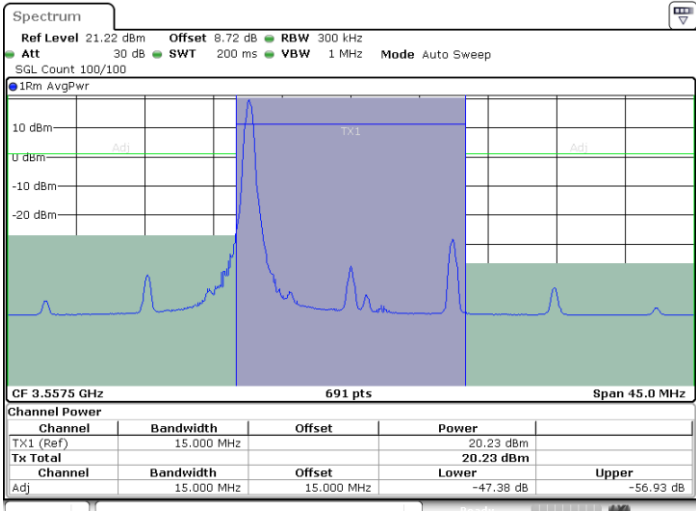

Date: 26.OCT.2022 01:42:09

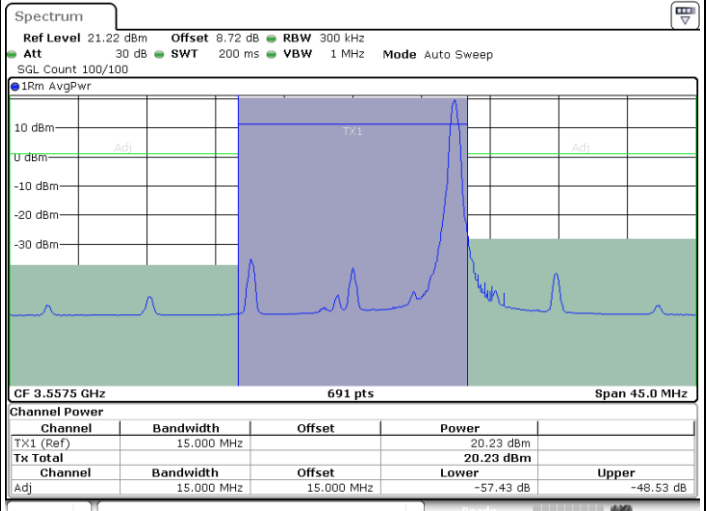

Date: 26.OCT.2022 01:43:27

Lowest Channel / Full RB

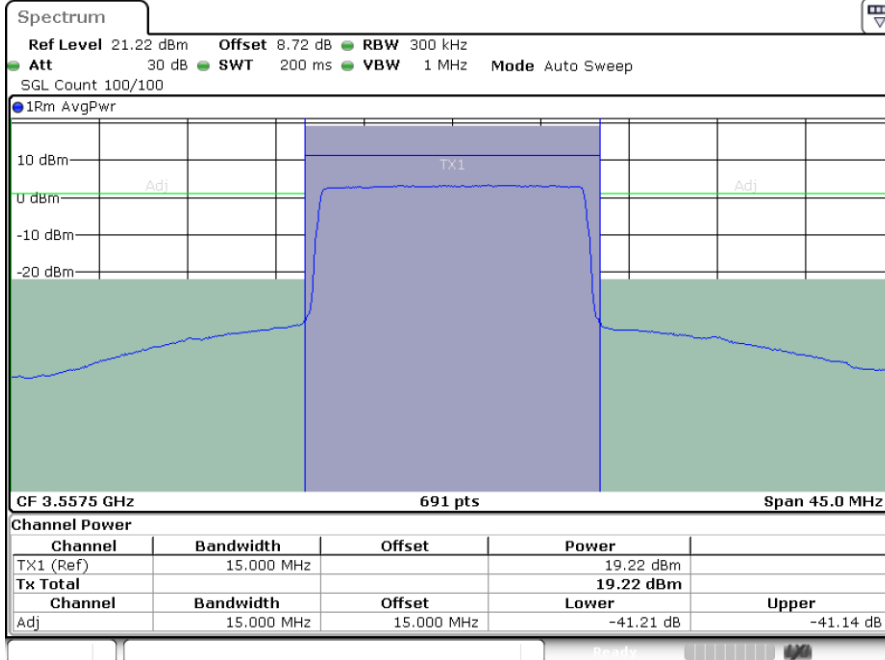

Date: 26.OCT.2022 01:44:06



LTE Band 48 / 15MHz

16QAM

Middle Channel / 1RB0

Middle Channel / 1RBmax

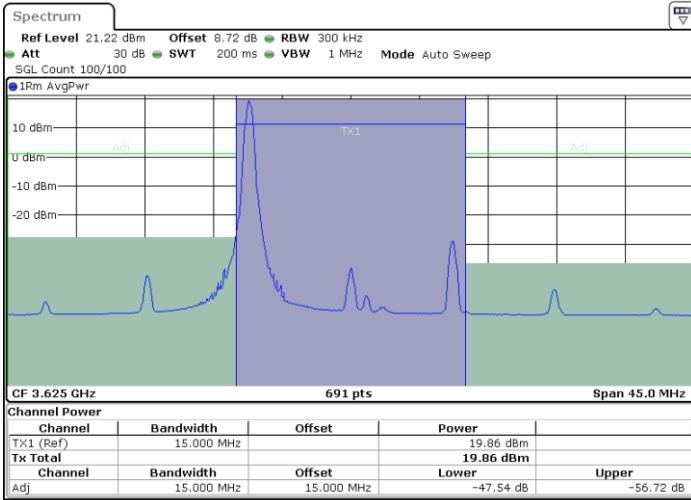

Date: 26.OCT.2022 01:46:03

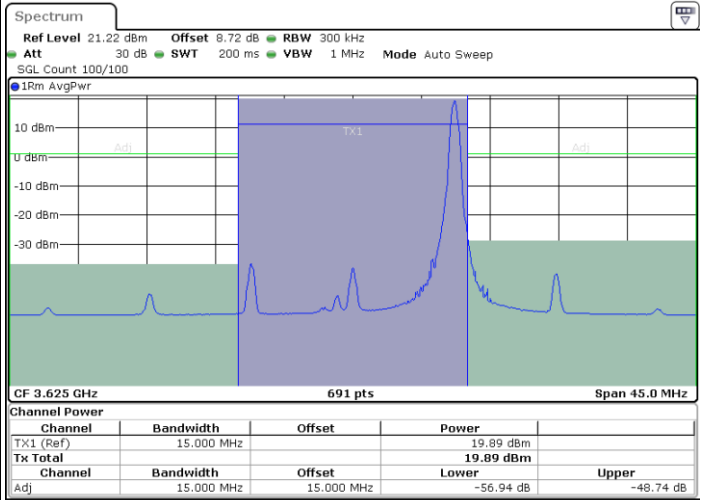

Date: 26.OCT.2022 01:46:41

Middle Channel / Full RB

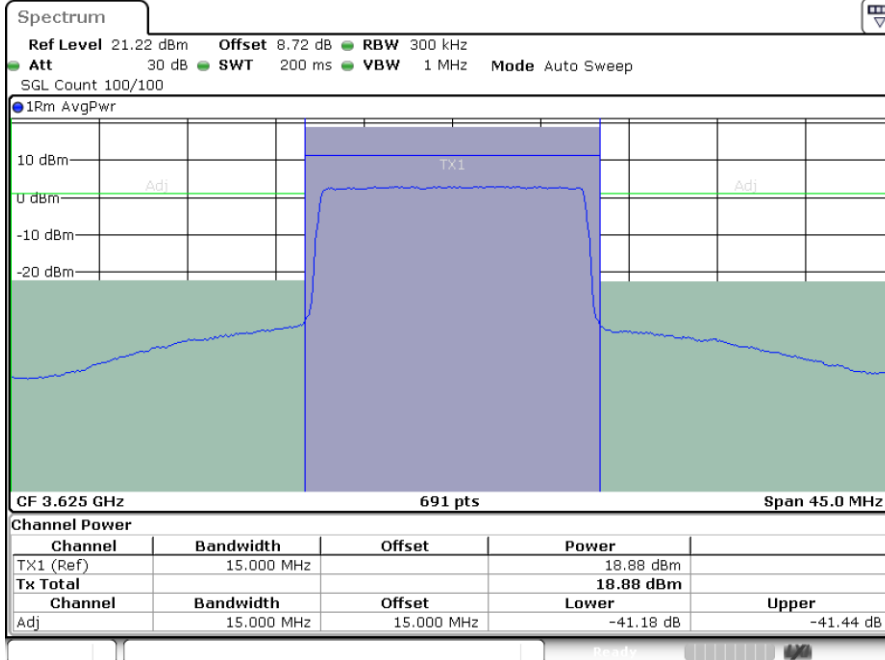

Date: 26.OCT.2022 01:48:36



LTE Band 48 / 15MHz

16QAM

Highest Channel / 1RB0

Highest Channel / 1RBmax

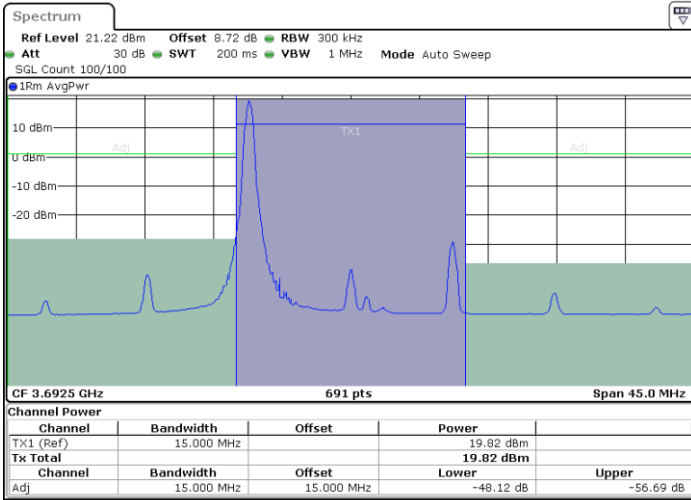

Date: 26.OCT.2022 01:49:54

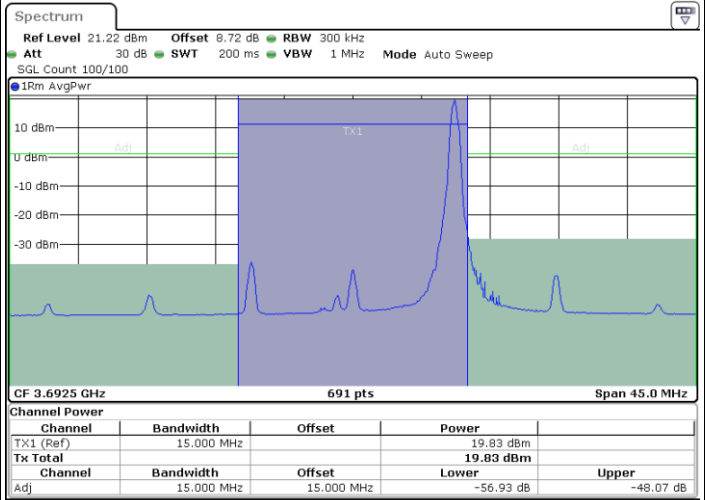

Date: 26.OCT.2022 01:50:33

Highest Channel / Full RB

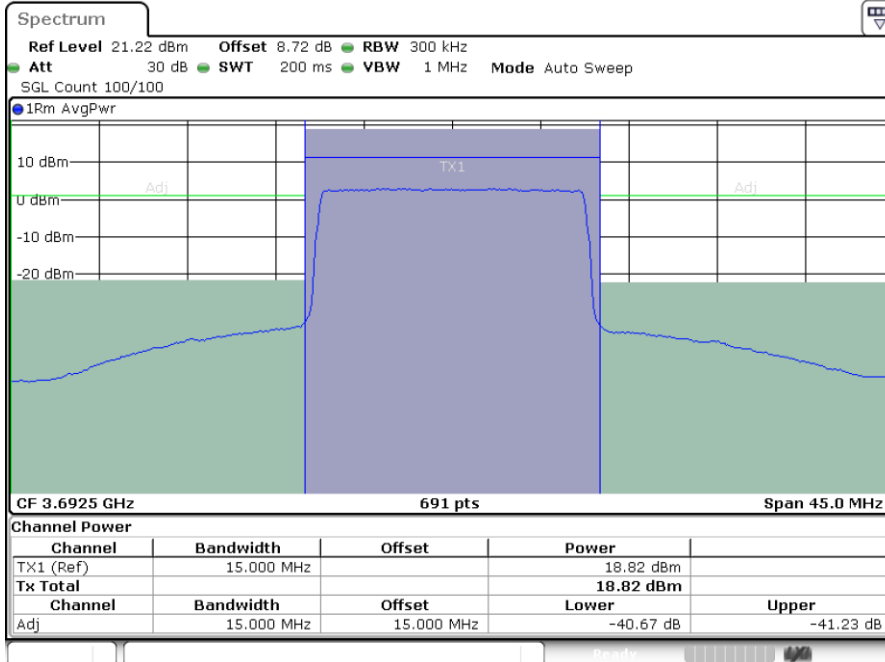

Date: 26.OCT.2022 01:52:30



LTE Band 48 / 20MHz

16QAM

Lowest Channel / 1RB0

Lowest Channel / 1RBmax

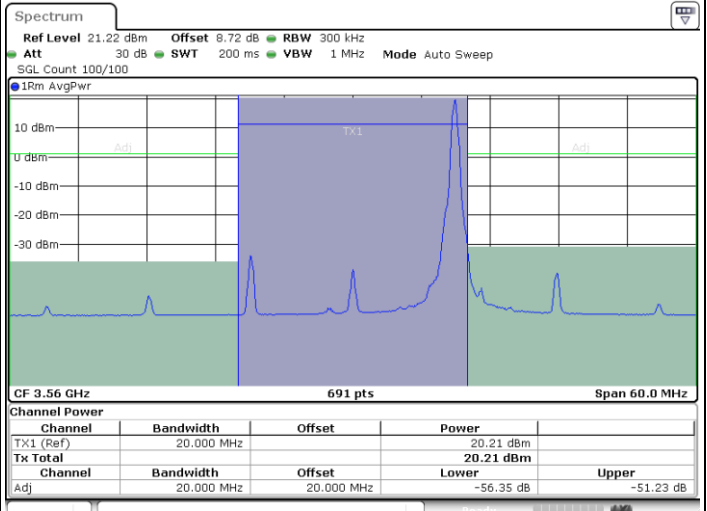
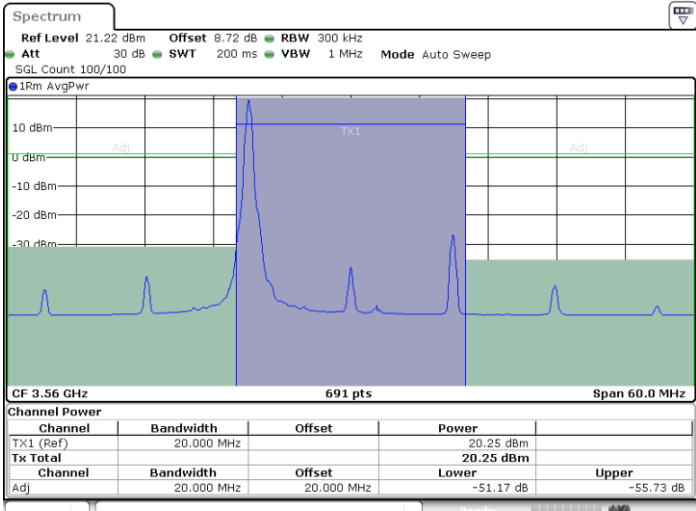

Date: 26.OCT.2022 01:53:48

Date: 26.OCT.2022 01:54:27

Lowest Channel / Full RB

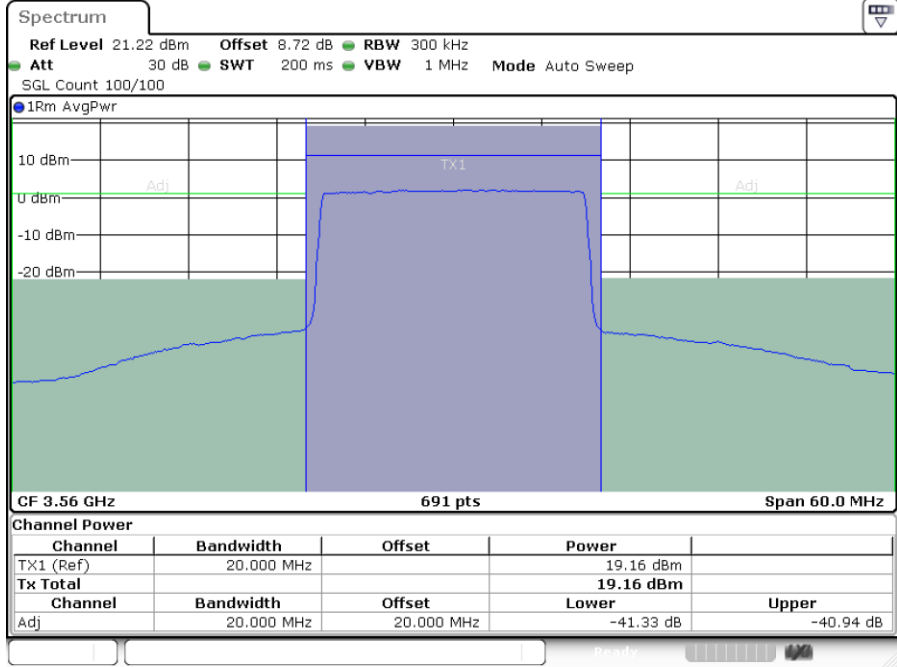

Date: 26.OCT.2022 01:56:24



LTE Band 48 / 20MHz

16QAM

Middle Channel / 1RB0

Middle Channel / 1RBmax

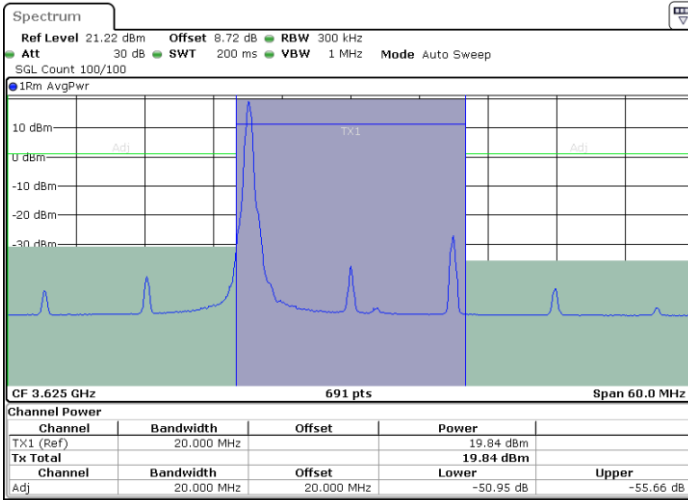

Date: 26.OCT.2022 01:57:40

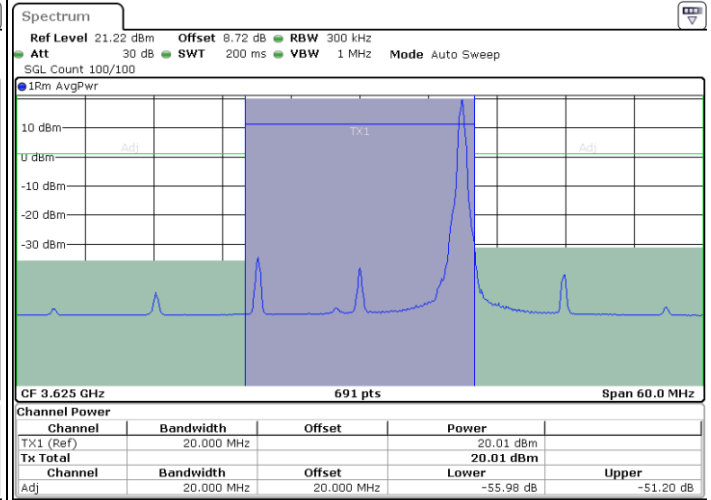

Date: 26.OCT.2022 01:58:18

Middle Channel / Full RB

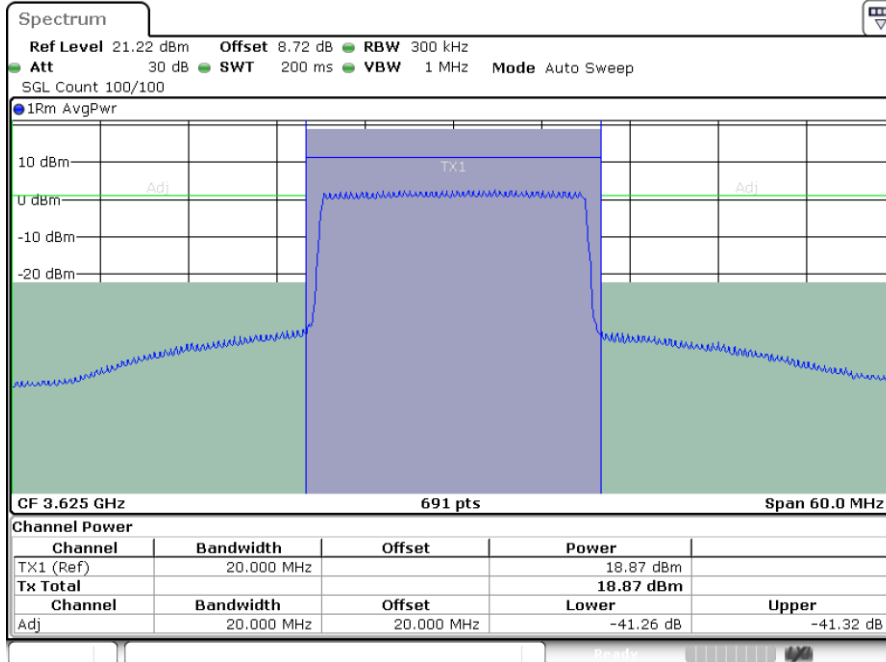

Date: 26.OCT.2022 02:00:13





LTE Band 48 / 20MHz

16QAM

Highest Channel / 1RB0

Highest Channel / 1RBmax

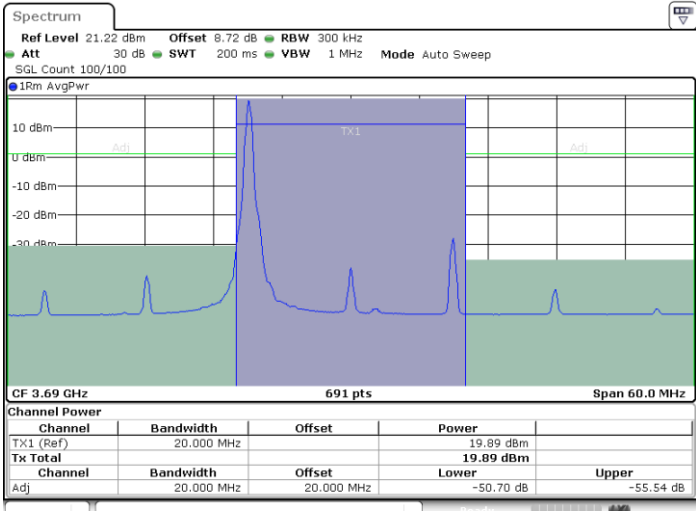

Date: 26.OCT.2022 02:01:30

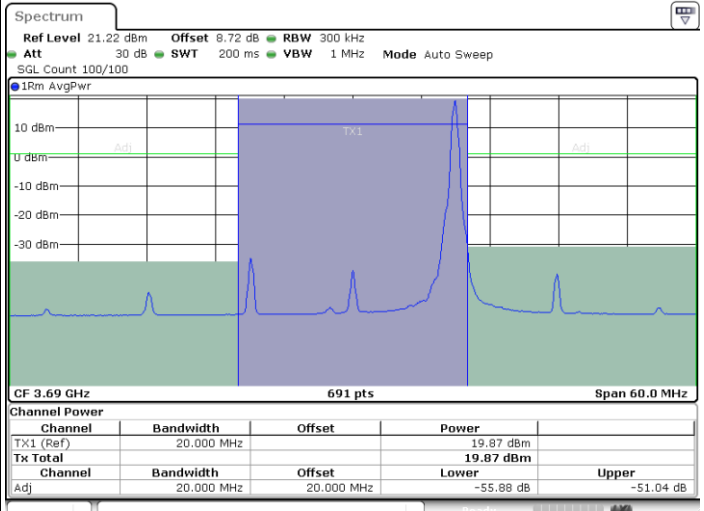

Date: 26.OCT.2022 02:02:09

Highest Channel / Full RB

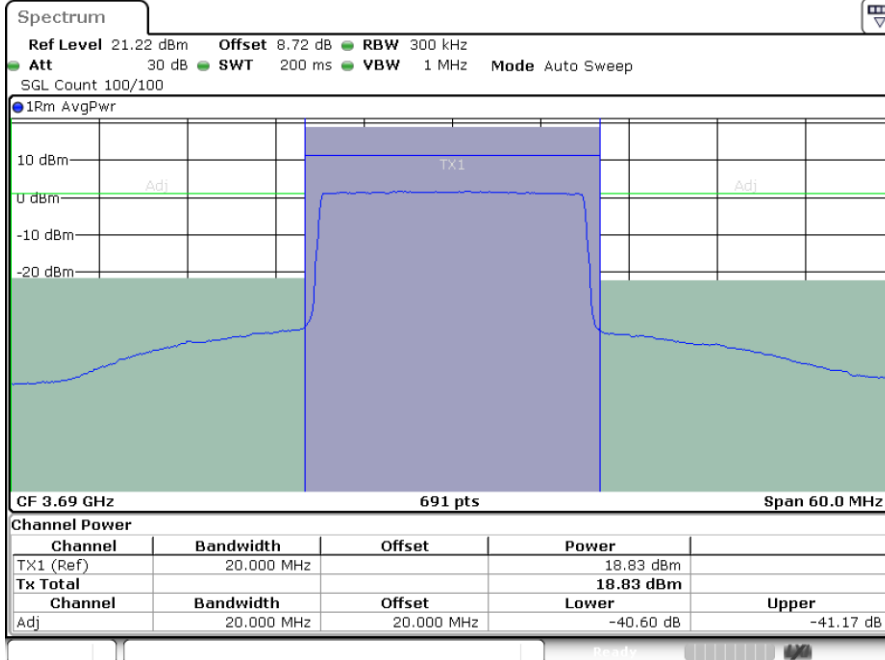

Date: 26.OCT.2022 02:04:05



**26dB Bandwidth**

|                  |              |              |
|------------------|--------------|--------------|
| <b>BW</b>        | <b>20MHz</b> |              |
| <b>Mod.</b>      | <b>QPSK</b>  | <b>16QAM</b> |
| <b>Middle CH</b> | <b>18.86</b> | <b>18.94</b> |

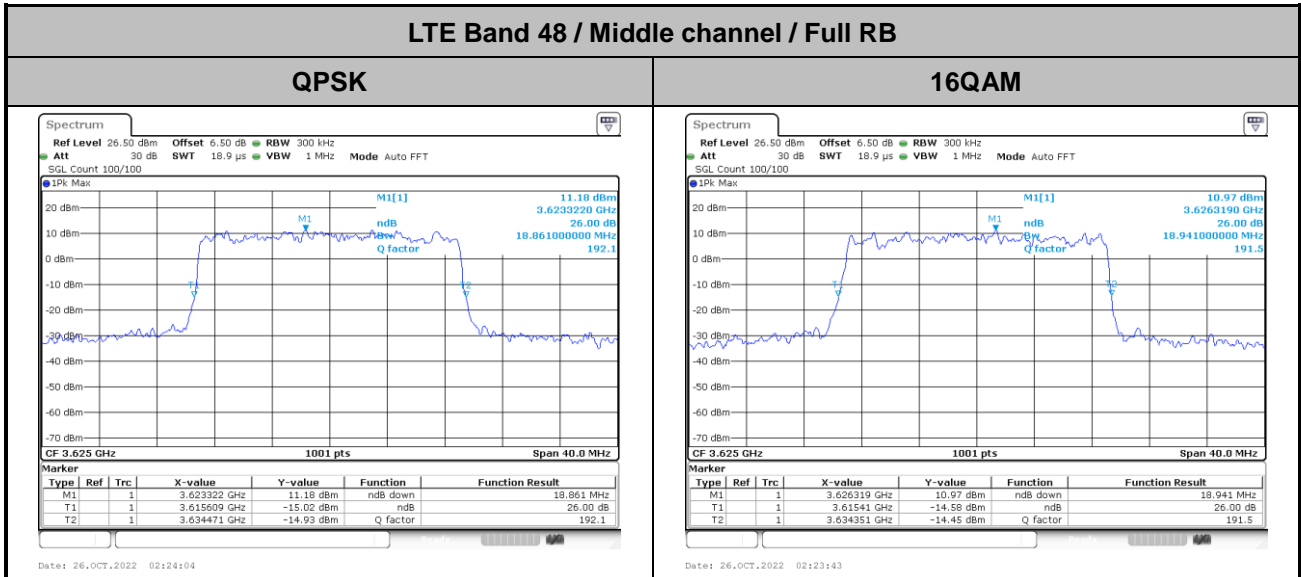



# Occupied Bandwidth

|                  |              |              |
|------------------|--------------|--------------|
| <b>BW</b>        | <b>20MHz</b> |              |
| <b>Mod.</b>      | <b>QPAK</b>  | <b>16QAM</b> |
| <b>Middle CH</b> | 17.94        | 17.82        |

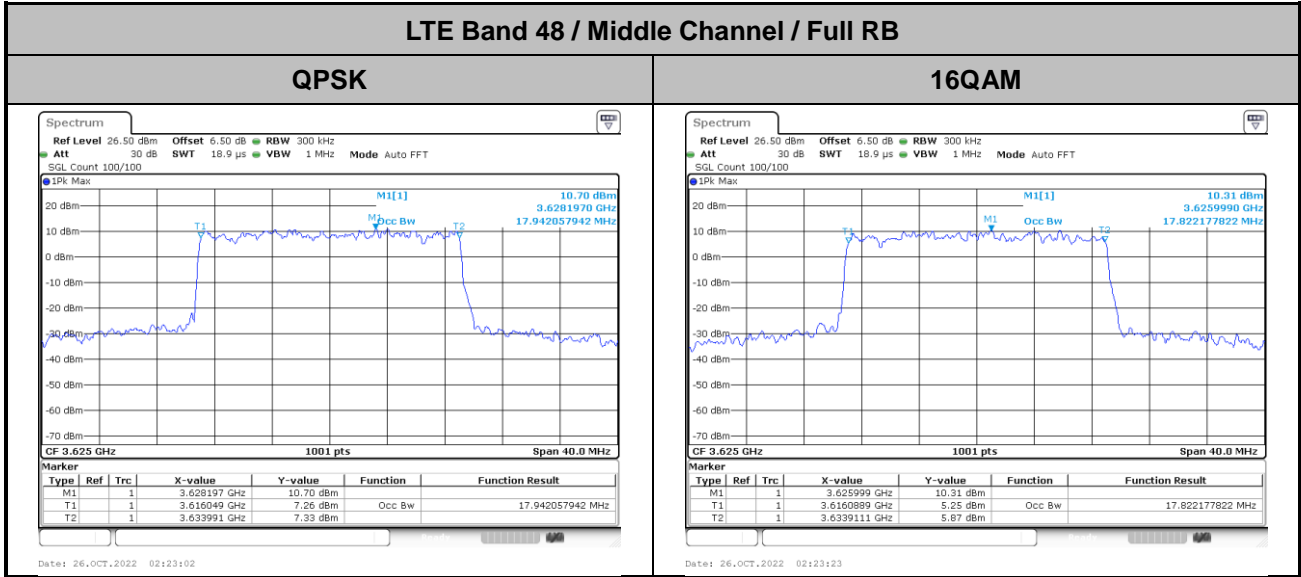



Conducted Band Edge

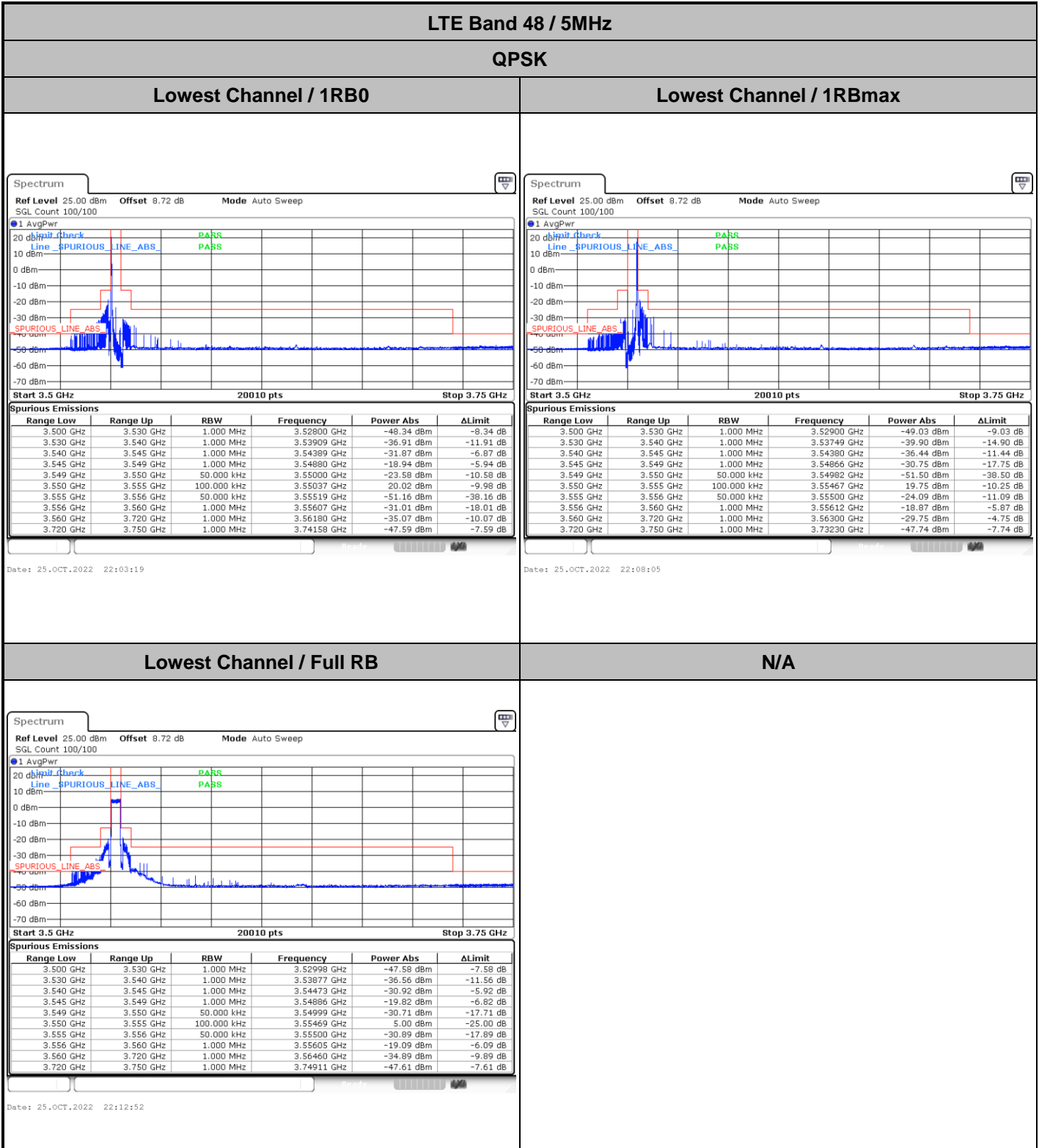



LTE Band 48 / 5MHz

QPSK

Middle Channel / 1RB0

Middle Channel / 1RBmax

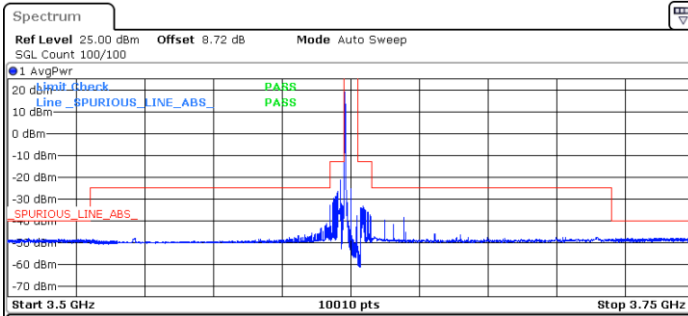

| Range Low | Range Up  | RBW         | Frequency   | Power Abs  | ΔLimit    |
|-----------|-----------|-------------|-------------|------------|-----------|
| 3.500 GHz | 3.530 GHz | 1.000 MHz   | 3.50751 GHz | -48.29 dBm | -8.29 dB  |
| 3.530 GHz | 3.540 GHz | 1.000 MHz   | 3.53099 GHz | -48.47 dBm | -23.47 dB |
| 3.540 GHz | 3.618 GHz | 1.000 MHz   | 3.61622 GHz | -41.44 dBm | -16.44 dB |
| 3.618 GHz | 3.622 GHz | 1.000 MHz   | 3.62134 GHz | -21.48 dBm | -8.48 dB  |
| 3.622 GHz | 3.623 GHz | 50.000 kHz  | 3.62250 GHz | -25.69 dBm | -12.69 dB |
| 3.623 GHz | 3.627 GHz | 100.000 kHz | 3.62285 GHz | 18.94 dBm  | -11.06 dB |
| 3.627 GHz | 3.629 GHz | 50.000 kHz  | 3.62789 GHz | -54.12 dBm | -41.12 dB |
| 3.629 GHz | 3.633 GHz | 1.000 MHz   | 3.62931 GHz | -33.38 dBm | -20.38 dB |
| 3.633 GHz | 3.720 GHz | 1.000 MHz   | 3.64417 GHz | -38.79 dBm | -13.79 dB |
| 3.720 GHz | 3.750 GHz | 1.000 MHz   | 3.73629 GHz | -48.01 dBm | -8.01 dB  |

Date: 25.OCT.2022 22:20:01

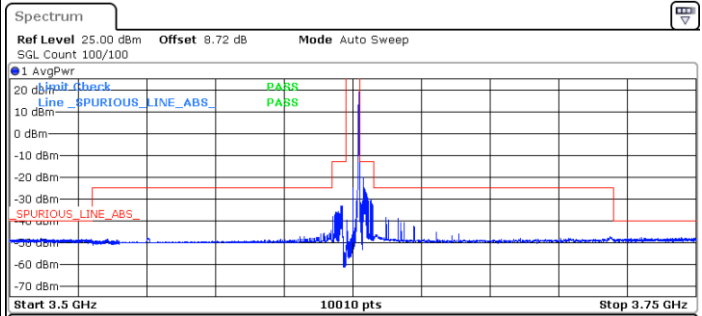

| Range Low | Range Up  | RBW         | Frequency   | Power Abs  | ΔLimit    |
|-----------|-----------|-------------|-------------|------------|-----------|
| 3.500 GHz | 3.530 GHz | 1.000 MHz   | 3.52624 GHz | -48.48 dBm | -8.48 dB  |
| 3.530 GHz | 3.540 GHz | 1.000 MHz   | 3.53576 GHz | -48.64 dBm | -23.64 dB |
| 3.540 GHz | 3.618 GHz | 1.000 MHz   | 3.61715 GHz | -44.51 dBm | -19.51 dB |
| 3.618 GHz | 3.622 GHz | 1.000 MHz   | 3.62117 GHz | -33.26 dBm | -20.26 dB |
| 3.622 GHz | 3.623 GHz | 50.000 kHz  | 3.62248 GHz | -54.28 dBm | -41.28 dB |
| 3.623 GHz | 3.627 GHz | 100.000 kHz | 3.62716 GHz | 18.86 dBm  | -11.14 dB |
| 3.627 GHz | 3.629 GHz | 50.000 kHz  | 3.62750 GHz | -25.69 dBm | -12.69 dB |
| 3.629 GHz | 3.633 GHz | 1.000 MHz   | 3.62881 GHz | -20.32 dBm | -7.32 dB  |
| 3.633 GHz | 3.720 GHz | 1.000 MHz   | 3.63718 GHz | -38.49 dBm | -13.49 dB |
| 3.720 GHz | 3.750 GHz | 1.000 MHz   | 3.73008 GHz | -47.94 dBm | -7.94 dB  |

Date: 25.OCT.2022 22:24:46

Middle Channel / Full RB

N/A

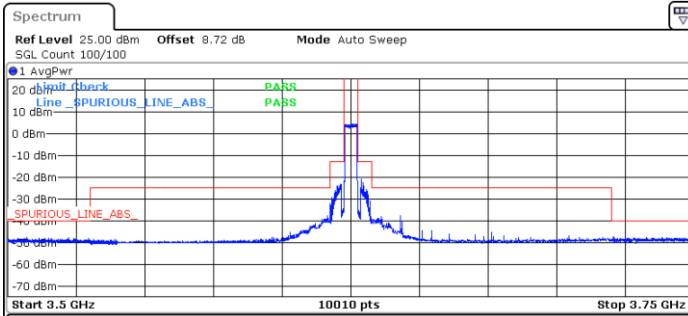

| Range Low | Range Up  | RBW         | Frequency   | Power Abs  | ΔLimit    |
|-----------|-----------|-------------|-------------|------------|-----------|
| 3.500 GHz | 3.530 GHz | 1.000 MHz   | 3.52201 GHz | -47.80 dBm | -7.80 dB  |
| 3.530 GHz | 3.540 GHz | 1.000 MHz   | 3.53913 GHz | -48.47 dBm | -23.47 dB |
| 3.540 GHz | 3.618 GHz | 1.000 MHz   | 3.61653 GHz | -37.95 dBm | -12.95 dB |
| 3.618 GHz | 3.622 GHz | 1.000 MHz   | 3.62123 GHz | -23.28 dBm | -10.28 dB |
| 3.622 GHz | 3.623 GHz | 50.000 kHz  | 3.62250 GHz | -30.50 dBm | -17.50 dB |
| 3.623 GHz | 3.627 GHz | 100.000 kHz | 3.62717 GHz | 4.20 dBm   | -25.80 dB |
| 3.627 GHz | 3.629 GHz | 50.000 kHz  | 3.62750 GHz | -31.91 dBm | -18.91 dB |
| 3.629 GHz | 3.633 GHz | 1.000 MHz   | 3.62882 GHz | -21.10 dBm | -8.10 dB  |
| 3.633 GHz | 3.720 GHz | 1.000 MHz   | 3.64303 GHz | -37.70 dBm | -12.70 dB |
| 3.720 GHz | 3.750 GHz | 1.000 MHz   | 3.72043 GHz | -47.29 dBm | -7.29 dB  |

Date: 25.OCT.2022 22:29:32



LTE Band 48 / 5MHz

QPSK

Highest Channel / 1RB0

Highest Channel / 1RBmax

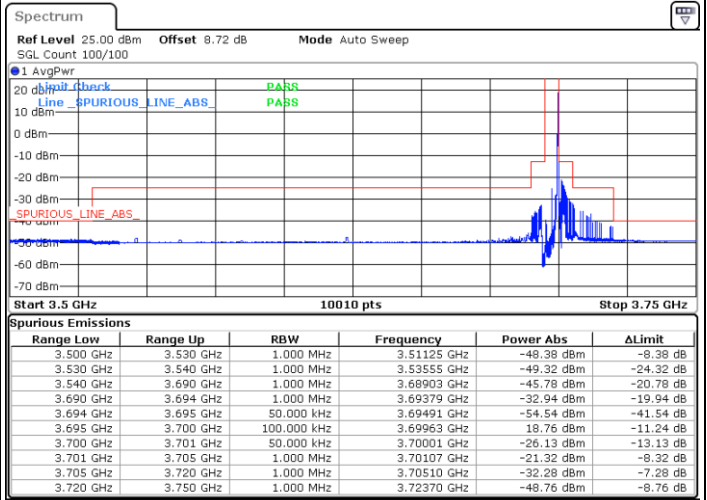
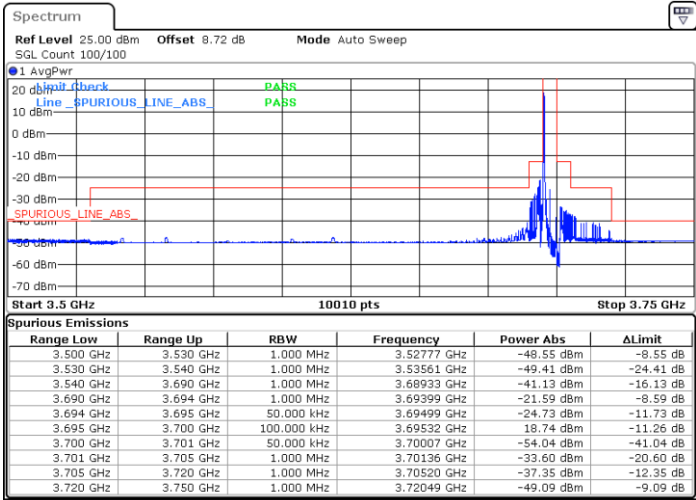

Date: 25.OCT.2022 22:31:56

Date: 25.OCT.2022 22:41:29

Highest Channel / Full RB

N/A

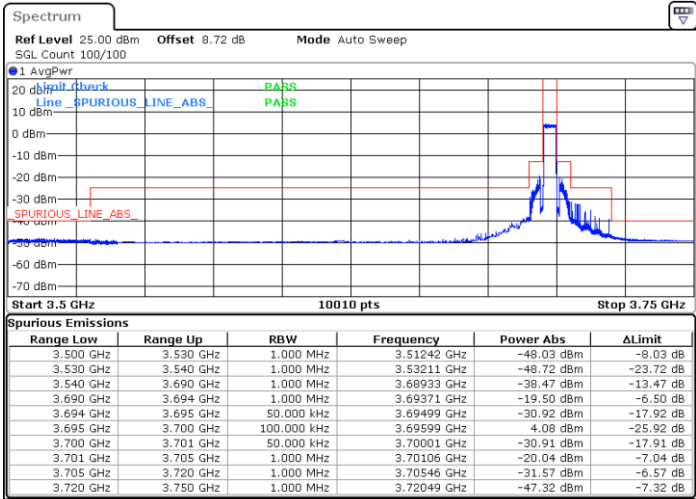

Date: 25.OCT.2022 22:36:42



LTE Band 48 / 10MHz

QPSK

Lowest Channel / 1RB0

Lowest Channel / 1RBmax

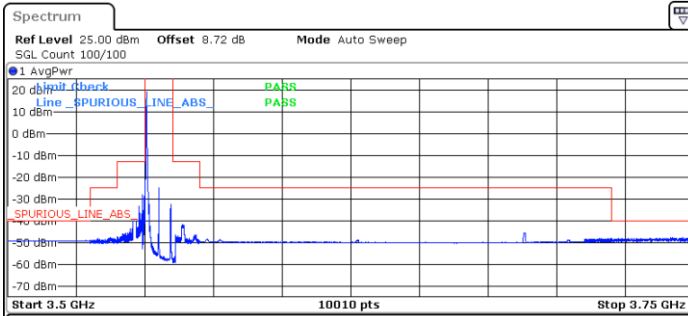

| Range Low | Range Up  | RBW         | Frequency   | Power Abs  | ΔLimit    |
|-----------|-----------|-------------|-------------|------------|-----------|
| 3.500 GHz | 3.530 GHz | 1.000 MHz   | 3.52855 GHz | -49.19 dBm | -9.19 dB  |
| 3.530 GHz | 3.540 GHz | 1.000 MHz   | 3.53986 GHz | -47.40 dBm | -22.40 dB |
| 3.540 GHz | 3.549 GHz | 1.000 MHz   | 3.54897 GHz | -28.22 dBm | -15.22 dB |
| 3.549 GHz | 3.550 GHz | 100.000 kHz | 3.54999 GHz | -26.23 dBm | -13.23 dB |
| 3.550 GHz | 3.560 GHz | 100.000 kHz | 3.55061 GHz | 18.88 dBm  | -11.12 dB |
| 3.560 GHz | 3.561 GHz | 100.000 kHz | 3.56074 GHz | -56.63 dBm | -43.63 dB |
| 3.561 GHz | 3.570 GHz | 1.000 MHz   | 3.56358 GHz | -41.86 dBm | -28.86 dB |
| 3.570 GHz | 3.710 GHz | 1.000 MHz   | 3.68853 GHz | -45.77 dBm | -20.77 dB |
| 3.710 GHz | 3.720 GHz | 1.000 MHz   | 3.71862 GHz | -48.09 dBm | -23.09 dB |
| 3.720 GHz | 3.750 GHz | 1.000 MHz   | 3.74204 GHz | -47.85 dBm | -7.85 dB  |

Date: 25.OCT.2022 22:48:40

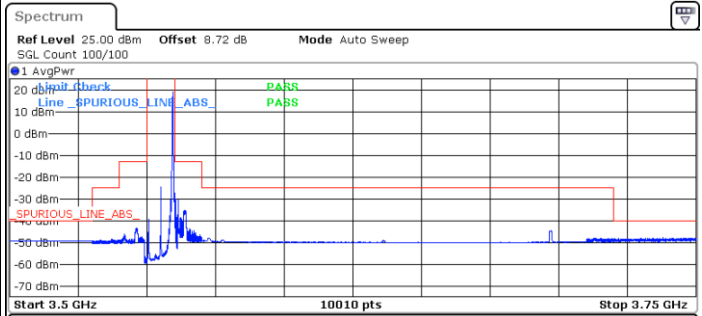

| Range Low | Range Up  | RBW         | Frequency   | Power Abs  | ΔLimit    |
|-----------|-----------|-------------|-------------|------------|-----------|
| 3.500 GHz | 3.530 GHz | 1.000 MHz   | 3.52888 GHz | -49.29 dBm | -9.29 dB  |
| 3.530 GHz | 3.540 GHz | 1.000 MHz   | 3.53742 GHz | -48.63 dBm | -23.63 dB |
| 3.540 GHz | 3.549 GHz | 1.000 MHz   | 3.54630 GHz | -43.39 dBm | -30.39 dB |
| 3.549 GHz | 3.550 GHz | 100.000 kHz | 3.54930 GHz | -56.80 dBm | -43.80 dB |
| 3.550 GHz | 3.560 GHz | 100.000 kHz | 3.55945 GHz | 19.11 dBm  | -10.89 dB |
| 3.560 GHz | 3.561 GHz | 100.000 kHz | 3.56003 GHz | -27.27 dBm | -14.27 dB |
| 3.561 GHz | 3.570 GHz | 1.000 MHz   | 3.56127 GHz | -30.52 dBm | -17.52 dB |
| 3.570 GHz | 3.710 GHz | 1.000 MHz   | 3.69706 GHz | -44.74 dBm | -19.74 dB |
| 3.710 GHz | 3.720 GHz | 1.000 MHz   | 3.71269 GHz | -48.02 dBm | -23.02 dB |
| 3.720 GHz | 3.750 GHz | 1.000 MHz   | 3.73806 GHz | -47.99 dBm | -7.99 dB  |

Date: 25.OCT.2022 22:53:27

Lowest Channel / Full RB

N/A

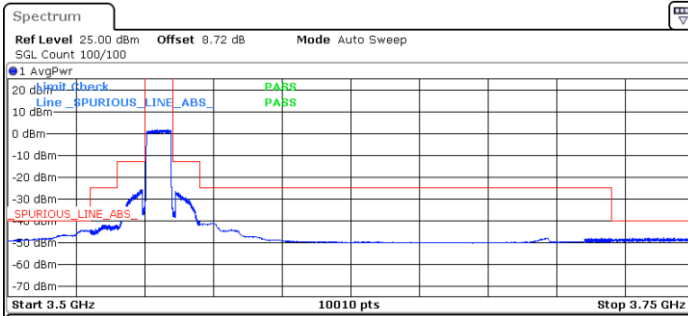

| Range Low | Range Up  | RBW         | Frequency   | Power Abs  | ΔLimit    |
|-----------|-----------|-------------|-------------|------------|-----------|
| 3.500 GHz | 3.530 GHz | 1.000 MHz   | 3.52840 GHz | -44.50 dBm | -4.50 dB  |
| 3.530 GHz | 3.540 GHz | 1.000 MHz   | 3.53561 GHz | -42.02 dBm | -17.02 dB |
| 3.540 GHz | 3.549 GHz | 1.000 MHz   | 3.54832 GHz | -25.70 dBm | -12.70 dB |
| 3.549 GHz | 3.550 GHz | 100.000 kHz | 3.54998 GHz | -33.50 dBm | -20.50 dB |
| 3.550 GHz | 3.560 GHz | 100.000 kHz | 3.55451 GHz | 1.65 dBm   | -28.35 dB |
| 3.560 GHz | 3.561 GHz | 100.000 kHz | 3.56000 GHz | -34.26 dBm | -21.26 dB |
| 3.561 GHz | 3.570 GHz | 1.000 MHz   | 3.56103 GHz | -26.64 dBm | -13.64 dB |
| 3.570 GHz | 3.710 GHz | 1.000 MHz   | 3.67510 GHz | -40.98 dBm | -15.98 dB |
| 3.710 GHz | 3.720 GHz | 1.000 MHz   | 3.71971 GHz | -48.12 dBm | -23.12 dB |
| 3.720 GHz | 3.750 GHz | 1.000 MHz   | 3.73896 GHz | -47.83 dBm | -7.83 dB  |

Date: 25.OCT.2022 22:58:14