



TEST REPORT

Report Number: D21T00510-SRD06-V00

Applicant	MeiG Smart Technology Co., Ltd
Product Name	Wireless communication module
Model Name	SLM900
Brand Name	MEIGLink
FCC ID	2APJ4-SLM900

Industrial Internet Innovation Center (Shanghai) Co., Ltd. tested the above equipment in accordance with the requirements in FCC CFR47 Part 15E (2019). RSS-Gen Issue 5, RSS-247 Issue 2.

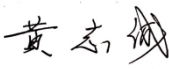
Prepared by 

Reviewed by 

Approved by 

Issue Date 2021-12-06

Industrial Internet Innovation Center (Shanghai) Co., Ltd.



NOTE

1. This report is invalid without the signature of the writer, reviewer and authorizer.
2. This report is invalid if altered.
3. For the benefit of clients, if you have any objection to the report, please inform the testing laboratory within 15 days from the date of receiving this report.
4. Samples in the test report are provided by the client. The test results are only applicable to the samples received by the laboratory. The source information of samples (such as sample sender, manufacturer, etc.) in the test report is provided by the client, and the laboratory is not responsible for its authenticity and the measurement accuracy.
5. The test report does not represent the identification of a product by a certification body or an authorized body.
6. This report is only valid as a whole, and no part of the report can be reproduced without the written approval of Industrial Internet Innovation Center (Shanghai) Co., Ltd.
7. Without the written permission of testing institutions and accreditation bodies, this report cannot be used in part or in whole for publicity or product introduction.
8. "N/A" is used in this report to indicate that it is not applicable or available.
9. Industrial Internet Innovation Center (Shanghai) Co., Ltd. assumes the legal responsibility for the report.
10. The measurement uncertainty is not taken into account when deciding conformity, and the results of measurement (or the average of measurement results) are directly used as the criterion for the stating conformity.

Test Laboratory:

Industrial Internet Innovation Center (Shanghai) Co., Ltd.

Add: Building 4, No. 766 Jingang Rd, Pudong, Shanghai, China

Tel: +86 21 68866880



Revision Version

Report Number	Revision	Date	Memo
D21T00510-SRD06-V00	00	2021-12-06	Initial creation of test report



CONTENTS

1. TEST LABORATORY	6
1.1. TESTING LOCATION	6
1.2. TESTING ENVIRONMENT	6
1.3. PROJECT INFORMATION	6
2. CLIENT INFORMATION	7
2.1. APPLICANT INFORMATION	7
2.2. MANUFACTURER INFORMATION	7
3. EQUIPMENT UNDER TEST (EUT) AND ANCILLARY EQUIPMENT (AE)	8
3.1. ABOUT EUT	8
3.2. INTERNAL IDENTIFICATION OF EUT USED DURING THE TEST	8
3.3. INTERNAL IDENTIFICATION OF AE USED DURING THE TEST	8
4. REFERENCE DOCUMENTS	9
4.1. REFERENCE DOCUMENTS FOR TESTING	9
4.2. REFERENCE INFORMATION FROM CLIENT	9
5. TEST RESULTS	10
5.1. SUMMARY OF TEST RESULTS	10
5.2. STATEMENTS	11
6. MEASUREMENT REQUIREMENTS	12
6.1. DFS TECHNICAL REQUIREMENTS AND RADAR TEST WAVEFORMS	12
6.2. TEST SET-UP	16
7. MEASUREMENT RESULTS	17
7.1. DFS DETECTION THRESHOLDS	17
7.2. IN-SERVICE MONITORING FOR CHANNEL MOVE TIME, CHANNEL CLOSING TRANSMISSION TIME AND NON-OCCUPANCY PERIOD	22



8. TEST EQUIPMENT LIST.....	28
9. TEST ENVIRONMENT	29
ANNEX A: MEASUREMENT UNCERTAINTY	30
ANNEX B: ACCREDITATION CERTIFICATE.....	31

1. Test Laboratory

1.1. Testing Location

Primary Lab:

Company Name	Industrial Internet Innovation Center (Shanghai) Co., Ltd.
Address	Building 4, No. 766 Jingang Rd, Pudong, Shanghai, China
FCC Registration No.	958356
FCC Designation No.	CN1177

Subcontracting Lab #1:

Company Name	N/A
Address	N/A

1.2. Testing Environment

Normal Temperature	15°C~35°C
Relative Humidity	30%RH~60%RH
Supply Voltage	120V/60Hz

1.3. Project Information

Project Leader	Wang Wenen
Testing Start Date	2021-11-19
Testing End Date	2021-12-03



2. Client Information

2.1. Applicant Information

Company Name	MeiG Smart Technology Co., Ltd
Address	3/F, No.88, Qinjiang Road, Xuhui District, Shanghai, China
Telephone	021-54278676

2.2. Manufacturer Information

Company Name	MeiG Smart Technology Co., Ltd
Address	Floor 2, No.5 Office Building, Lingxia Road, Fenghuang Community, Fuyong Street, Bao 'an District, Shenzhen
Telephone	021-54278676

3. Equipment under Test (EUT) and Ancillary Equipment (AE)

3.1. About EUT

Product Name	Wireless communication module
Model name	SLM900
Supported Radio Technology and Bands	WLAN 802.11a,n,ac
Operational Mode	Client Without Radar Detection
Hardware Version	SLM900_MB_V1.01_PCB
Software Version	SLM900A_EQ000_2774.1F29708.FDF14BA_210831_100_V01_T04
FCC ID	2APJ4-SLM900

Note: Photographs of EUT are shown in ANNEX B of this test report.

3.2. Internal Identification of EUT used during the test

EUT ID*	SN or IMEI	HW Version	SW Version	Date of Receipt
N01	865171050693624	SLM900_MB_V1 .01_PCB	SLM900A_EQ000_ 2774.1F29708.FDF 14BA_210831_100 _V01_T04	2021-11-18
N02	865171050693608	SLM900_MB_V1 .01_PCB	SLM900A_EQ000_ 2774.1F29708.FDF 14BA_210831_100 _V01_T04	2021-11-25

*EUT ID: is internally used to identify the test sample in the lab.

3.3. Internal Identification of AE used during the test

AE ID*	Description	Model	SN/Remark
AE1	RF cable	N/A	N/A

*AE ID: is internally used to identify the test sample in the lab.

*The AE is provided by the client.

4. Reference Documents

4.1. Reference Documents for testing

The following documents listed in this section are referred for testing.

Reference	Title	Version
FCC Part15	Title 47 of the Code of Federal Regulations; Chapter I Part 15 - Radio frequency devices	2020
ANSI 63.10	Methods of Measurement of Radio-Noise Emissions from Low-Voltage Electrical and Electronic Equipment in the Range of 9 kHz to 40 GHz	2013
KDB 789033	Information Infrastructure (U-NII) Devices - Part 15, Subpart E	2017
KDB 905462 D02	COMPLIANCE MEASUREMENT PROCEDURES FOR UNLICENSED-NATIONAL INFORMATION INFRASTRUCTURE DEVICES OPERATING IN THE 5250-5350 MHz AND 5470-5725 MHz BANDS INCORPORATING DYNAMIC FREQUENCY SELECTION	2016
RSS-247 Issue 2	Digital Transmission Systems (DTSSs), Frequency Hopping Systems (FHSs) and Licence-Exempt Local Area Network (LE-LAN) Devices	2017
RSS-Gen Issue 5	General Requirements for Compliance of Radio Apparatus	2019

4.2. Reference Information from client

Antenna gain Information of the test sample provided by client.

Note:The product SLM900 use an integral antenna which compliance with the requirement of 15.203.

5. Test Results

5.1. Summary of Test Results

A brief summary of the tests carried out is shown as following.

SUMMARY OF MEASUREMENT RESULTS	Sub-clause of Part15E	Verdict
DFS	15.407	P

Please refer to section 6 for detail.

Terms used in Verdict column

P	Pass, the EUT complies with the essential requirements in the standard.
NP	Not Perform, the test was not performed by ECIT.
NA	Not Applicable, the test was not applicable.
F	Fail, the EUT does not comply with the essential requirements in the standard.

Test Conditions

Tnom	Normal temperature
Tmin	Low Temperature
Tmax	High Temperature
Vnom	Normal Voltage
Vmin	Low Voltage
Vmax	High Voltage
Hnom	Norm Humidity
Anom	Norm Air Pressure

For this report, all the test case listed above are tested under Normal Temperature and Normal Voltage, and also under norm humidity, the specific conditions as following:

Temperature	Tnom	25°C
Voltage	Vnom	3.8 V
Humidity	Hnom	48%

5.2. Statements

The SLM900 manufactured by MeiG Smart Technology Co., Ltd., Incorporated are new products for testing.

Industrial Internet Innovation Center (Shanghai) Co., Ltd. only performed test cases which identified with Pass/Fail/Inc result in section 5.1.

Industrial Internet Innovation Center (Shanghai) Co., Ltd. has verified that the compliance of the tested device specified in section 3 of this test report is successfully evaluated according to the procedure and test methods as defined in type certification requirement listed in section 4 of this test report.

6. Measurement Requirements

6.1. DFS Technical Requirements and Radar Test Waveforms

6.1.1 DFS Overview

Applicability of DFS requirements Prior to Use of a Channel

Requirement	DFS Operational mode		
	Master	Slave without radar detection	Slave with radar detection
Channel Availability Check	Required	Not required	Required (see note 2)
Off-Channel CAC (see note 1)	Required	Not required	Required (see note 2)
In-Service Monitoring	Required	Not required	Required
Channel Shutdown	Required	Required	Required
Non-Occupancy Period	Required	Not required	Required
Uniform Spreading	Required	Not required	Not required

NOTE 1: Where implemented by the manufacturer.

NOTE 2: A slave with radar detection is not required to perform a CAC or Off-Channel CAC at initial use of the channel but only after the slave has detected a radar signal on the Operating Channel by In-Service Monitoring and the Non-Occupancy Period resulting from this detection has elapsed.

6.1.2 DFS Detection Thresholds

DFS Requirement Values

Parameter	Value
Channel Availability Check Time	60 s (see note 1)
Minimum Off-Channel CAC Time	6 minutes (see note 2)
Maximum Off-Channel CAC Time	4 hours (see note 2)
Channel Move Time	10 s
Channel Closing Transmission Time	1 s
Non-Occupancy Period	30 minutes

NOTE 1: For channels whose nominal bandwidth falls completely or partly within the band 5 600 MHz to 5 650 MHz, the Channel Availability Check Time shall be 10 minutes.

NOTE 2: For channels whose nominal bandwidth falls completely or partly within the band 5 600 MHz to 5 650 MHz, the Off-Channel CAC Time shall be within the range 1 hour to 24 hours.

EIRP Spectral Density (dBm/MHz)	Value (see note 1 and note 2)
10	-62 dBm

NOTE 1: This is the level at the input of the receiver of an RLAN device with a maximum EIRP density of 10 dBm/MHz and assuming a 0 dBi receive antenna. For devices employing different EIRP spectral density and/or a different receive antenna gain G (dBi) the Radar Detection Threshold Level at the receiver input follows the following relationship: DFS Detection Threshold (dBm) = -62 + 10 - EIRP Spectral Density (dBm/MHz)+ G (dBi); however the Radar Detection Threshold Level shall not be less than -64 dBm assuming a 0 dBi receive antenna gain.

NOTE 2: Slave devices with a maximum e.i.r.p. of less than 23 dBm do not have to implement radar detection unless these devices are used in fixed outdoor point to point or fixed outdoor point to multi point applications .

6.1.3 Radar Test Waveforms

Parameters of the reference DFS test signal

Pulse width W (μs)	Pulse repetition frequency PRF (PPS)	Pulses per burst (PPB)
1	700	18

Parameters of radar test signals

Radar test signal # (see note 1 to note 3)	Pulse width W (μs)		Pulse repetition frequency PRF (PPS)		Number of different PRFs	Pulses per burst for each PRF (PPB) (see note 5)
	Min	Max	Min	Max		
1	0,5	5	200	1 000	1	10 (see note 6)
2	0,5	15	200	1 600	1	15 (see note 6)
3	0,5	15	2 300	4 000	1	25
4	20	30	2 000	4 000	1	20
5	0,5	2	300	400	2/3	10 (see note 6)
6	0,5	2	400	1 200	2/3	15 (see note 6)

NOTE 1: Radar test signals #1 to #4 are constant PRF based signals. See figure D.1. These radar test signals are intended to simulate also radars using a packet based Staggered PRF. See figure D.2.

NOTE 2: Radar test signal #4 is a modulated radar test signal. The modulation to be used is a chirp modulation with a ±2,5 MHz frequency deviation which is described below.

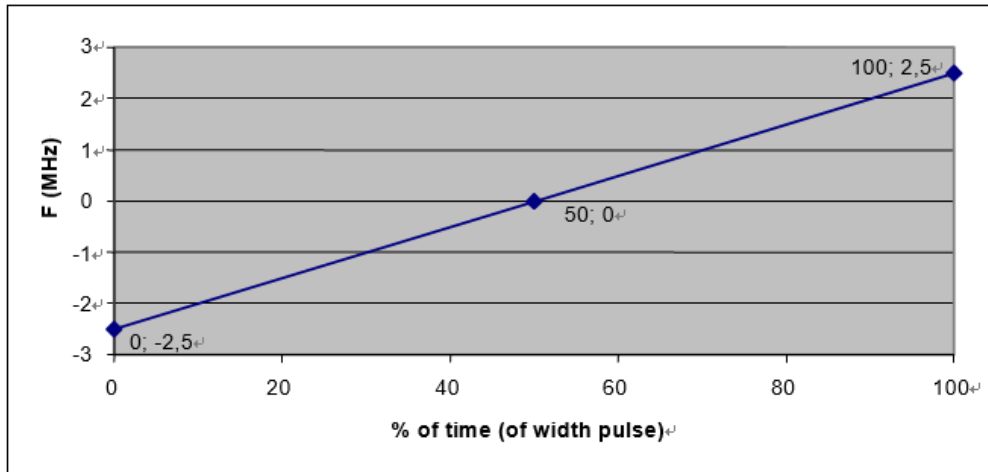

NOTE 3: Radar test signals #5 and #6 are single pulse based Staggered PRF radar test signals using 2 or 3 different PRF values. For radar test signal #5, the difference between the PRF values chosen shall be between 20 PPS and 50 PPS. For radar test signal #6, the difference between the PRF values chosen shall be between 80 PPS and 400 PPS. See figure D.3.

NOTE 4: Apart for the Off-Channel CAC testing, the radar test signals above shall only contain a single burst of pulses. See figure D.1, figure D.3 and figure D.4.

For the Off-Channel CAC testing, repetitive bursts shall be used for the total duration of the test. See figure D.2 and figure D.5.

NOTE 5: The total number of pulses in a burst is equal to the number of pulses for a single PRF multiplied by the number of different PRFs used.

NOTE 6: For the CAC and Off-Channel CAC requirements, the minimum number of pulses (for each PRF) for any of the radar test signals to be detected in the band 5 600 MHz to 5 650 MHz shall be 18.

Detection probability

Parameter	Detection Probability (P_d)	
	Channels whose nominal bandwidth falls partly or completely within the 5 600 MHz to 5 650 MHz band	Other channels
CAC, Off-Channel CAC	99,99 %	60 %
In-Service Monitoring	60 %	60 %

NOTE: P_d gives the probability of detection per simulated radar burst and represents a minimum level of detection performance under defined conditions. Therefore P_d does not represent the overall detection probability for any particular radar under real life conditions.

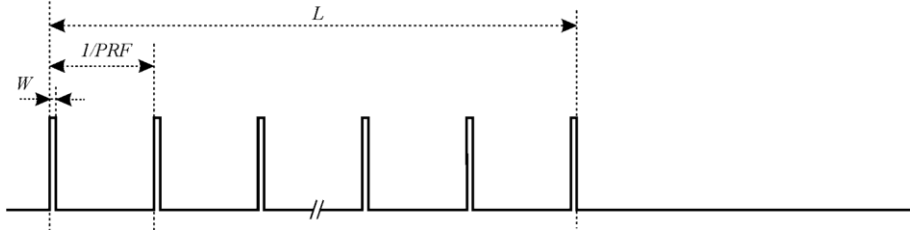

Figure 1: General structure of a single burst/constant PRF based radar test signal

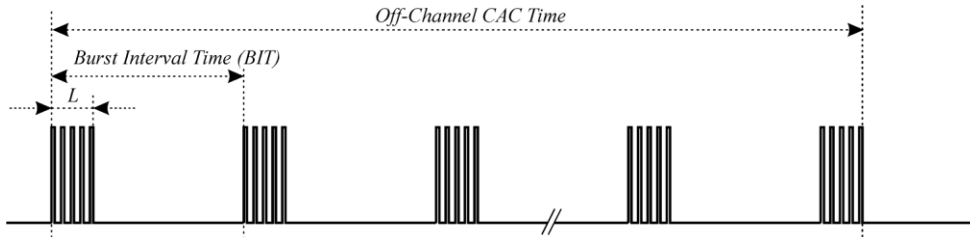

Figure 2: General structure of a multiple burst/constant PRF based radar test signal

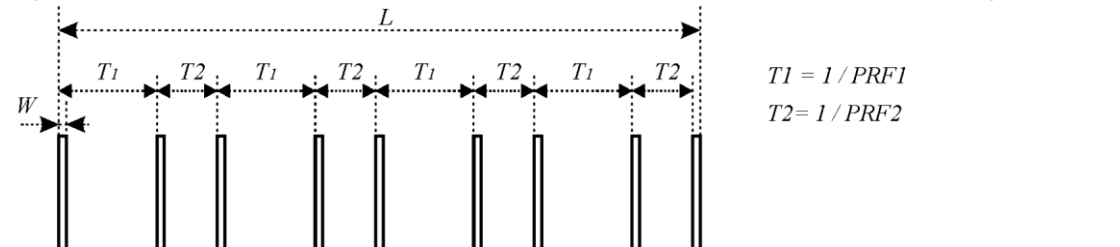

Figure 3: General structure of a single burst/single pulse based staggered PRF radar test signal

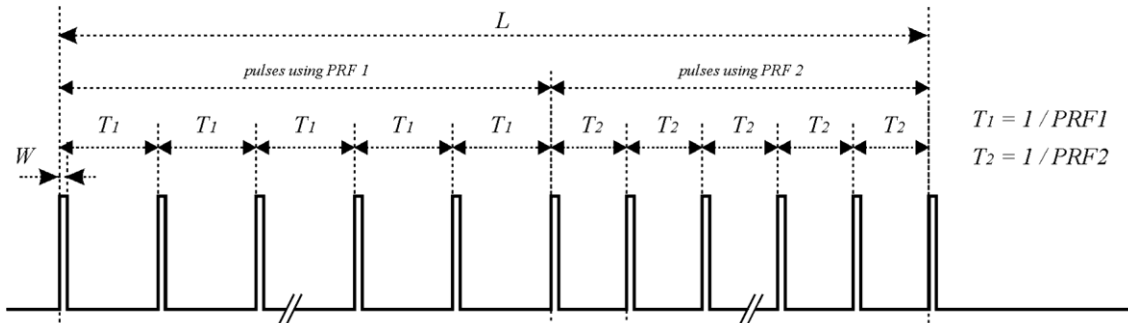

Figure 4: General structure of a single burst/package based staggered PRF radar test signal

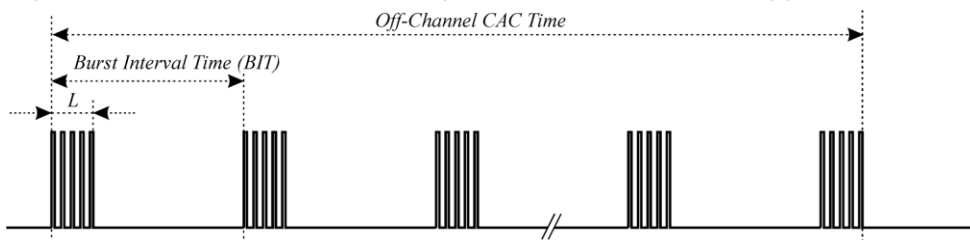

Figure 5: General structure of a multiple burst/package based staggered PRF based radar test signal

6.2. Test Set-up

6.2.1. Set-up

Set up B is a set-up whereby the UUT is an RLAN device operating in slave mode, with or without Radar Interference Detection function. This set-up also contains an RLAN device operating in master mode. The radar test signals are injected into the master device. The UUT (slave device) is associated with the master device.

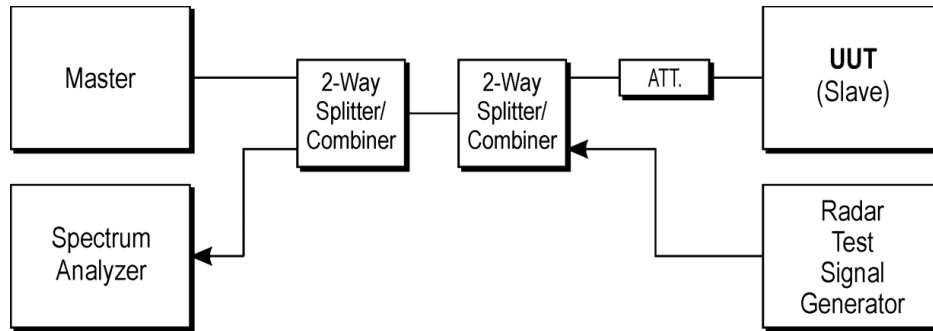

Figure 6: Set-up B

6.2.2. Set-up Photo:

The setup photos please refer to document “DFS Set-up Photo” .

7. Measurement Results

7.1. DFS Detection Thresholds

Radar Detection Threshold during the Channel Availability Check

- a) The signal generator and UUT are connected using Set-up A described. The power of the UUT is switched off.
- b) The UUT is powered on at T_0 . T_1 denotes the instant when the UUT has completed its power-up sequence (T_{power_up}) and is ready to start the radar detection. The Channel Availability Check on Chr is expected to commence at instant T_1 and is expected to end no sooner than $T_1 + T_{ch_avail_check}$ unless the radar test signal is detected sooner.

Additional verification may be needed to define T_1 in case it is not exactly known or indicated by the UUT.

- c) A single burst radar test signal is generated on Chr using any of the radar test signals defined in table D.4 at a level defined. This single-burst radar test signal may commence at any time within the applicable Channel Availability Check Time.

For the purpose of reducing test time, it is recommended that the single-burst radar test signal starts approximately 10 s after T_1 .

- d) It shall be recorded if the radar test signal was detected.
- e) Step c) to step d) shall be performed 20 times and each time a unique radar test signal shall be generated from options provided in table D.4. When selecting these 20 unique radar test signals, the radar test signals #1 to #6 from table D.4 shall be included as well as variations of pulse width, pulse repetition frequency and number of different PRFs (if applicable) within the ranges given. The radar test signals used shall be recorded in the report. The radar test signal shall be detected at least 12 times out of the 20 trials in order to comply with the detection probability specified for this frequency range in table D.5.

Where the declared channel plan includes channels whose nominal bandwidth falls completely or partly within the 5 600 MHz to 5 650 MHz band, additional testing as described in the steps below shall be performed on a channel within this band.

- f) A single burst radar test signal is generated on Chr using any of the radar test signals defined in table D.4 (except signals #3 and #4) at a level of 10 dB above the level defined. This single burst radar test signal may commence at any time within the applicable Channel Availability Check Time.

For the purpose of reducing test time, it is recommended that the single burst radar test signal starts approximately 10 s after T_1 .

- g) Step f) shall be performed 20 times, each time a different radar test signal shall be generated from options provided in table D.4 (except signals #3 and #4). The radar test signals used shall be recorded in the report. The radar test signal shall be detected during each of these tests and this shall be recorded.

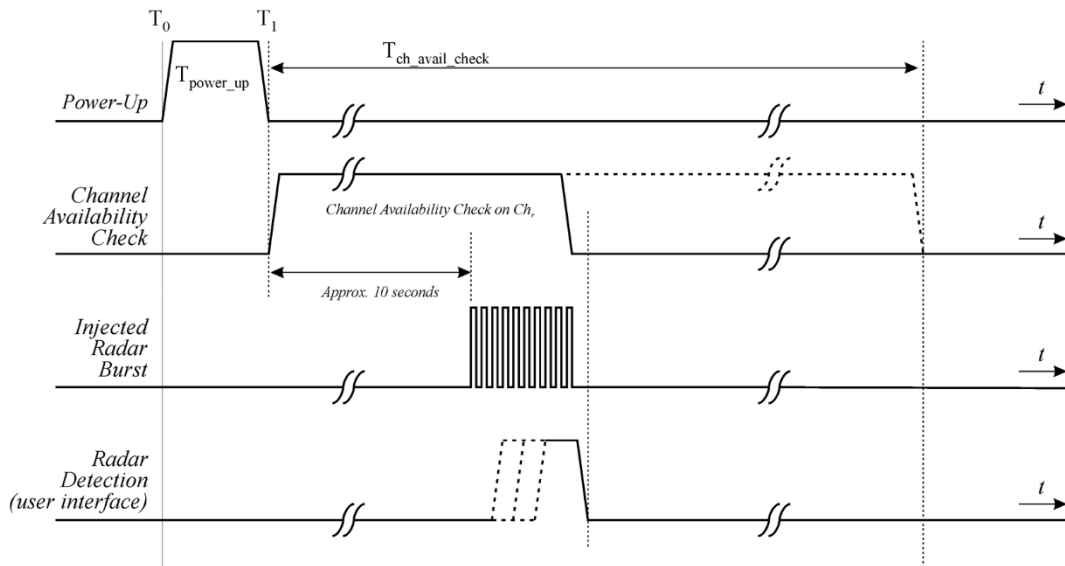

Figure 7: Example of timing for radar testing during the Channel Availability Check

Radar Detection Threshold during the In-Service Monitoring

- When the UUT is a master device, a slave device will be used that associates with the UUT. The signal generator and the UUT are connected using Set-up A described .
When the UUT is a slave device with a Radar Interference Detection function, the UUT shall associate with a master device. The signal generator and the UUT are connected using Set-up C described .
- The UUT shall transmit a test transmission sequence in accordance with clause 5.3.1.2 on the selected channel Chr. While the testing is performed on Chr, the equipment is allowed to have simultaneous transmissions on other adjacent or non-adjacent Operating Channels.
- At a certain time T_0 , a single burst radar test signal is generated on Chr using radar test signal #1 defined in table D.4 and at a level defined. T_1 denotes the end of the radar burst.
- It shall be recorded if the radar test signal was detected.
- Step b) to step d) shall be performed 20 times, each time a random value shall be chosen for pulse width and pulse repetition frequency from the corresponding ranges provided in table D.4. For radar test signal #5 and radar test signal #6 provided in table D.4 the number of PRF values shall vary between 2 or 3. The radar test signal shall be detected at least 12 times out of the 20 trials in order to comply with the detection probability specified in table D.5.
- Step b) to step e) shall be repeated for each of the radar test signals defined in table D.4 and as described .

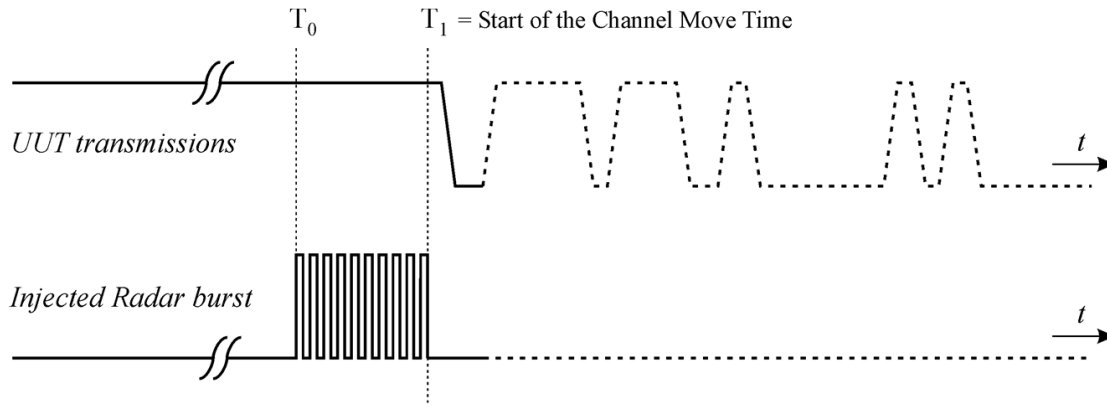

Figure 8: Example of timing for radar testing during the In-Service Monitoring

Frequency of Calibration	
Bandwidth	Central Frequency
20MHz	5320MHz
	5500MHz
40MHz	5310MHz
	5510MHz
80MHz	5290MHz
	5530MHz

The Calibration is listed below:

Relative Humidity: 50%~60% at normal and high temperature.

Calibration Measurement Results:

Radar Test Waveforms

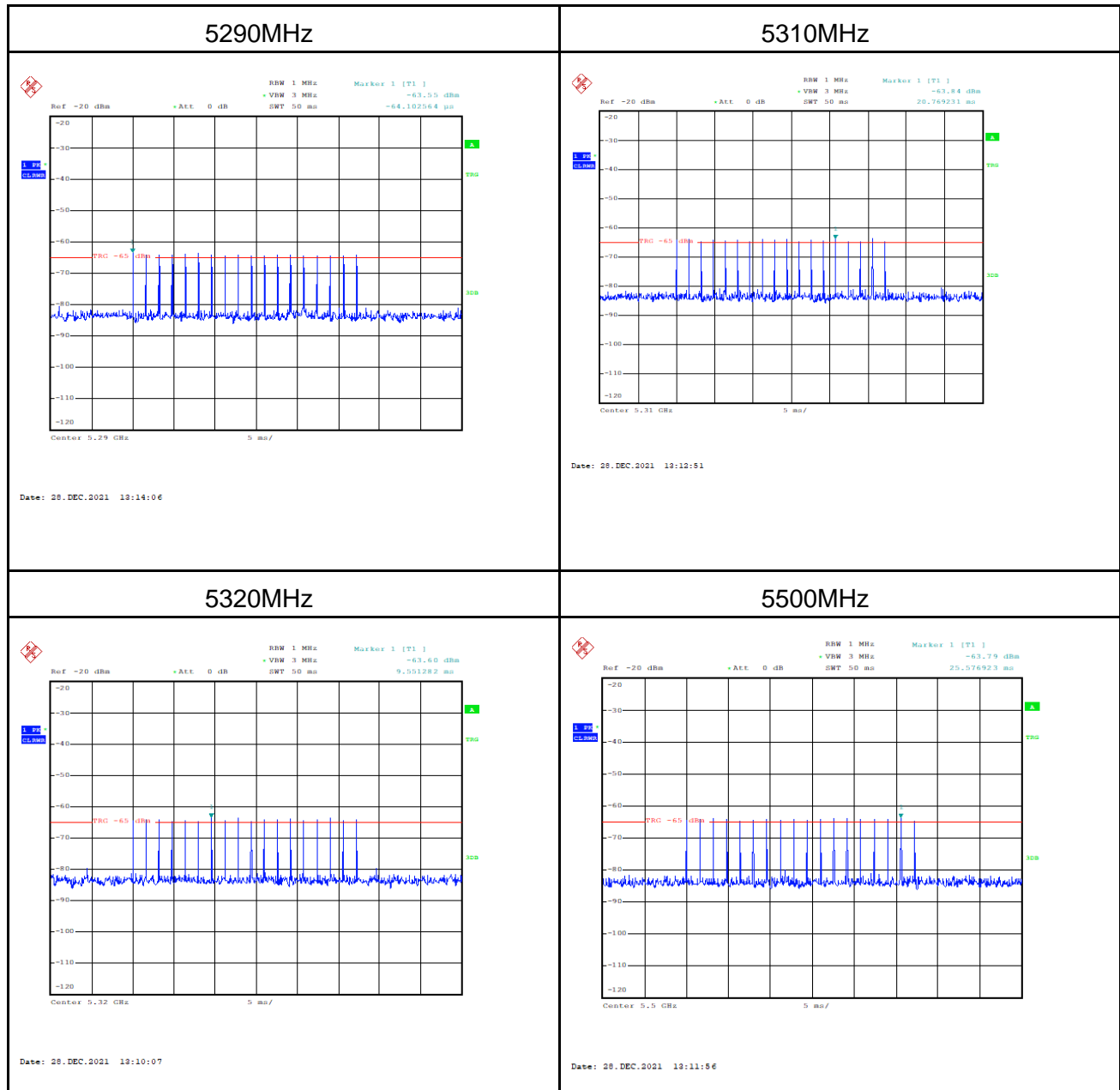

5510MHz

5530MHz

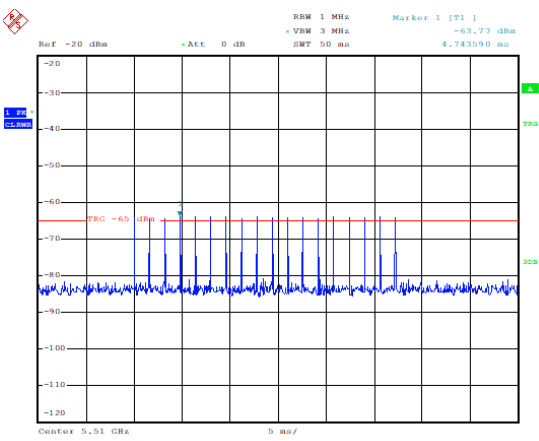

Date: 28.DEC.2021 13:13:24

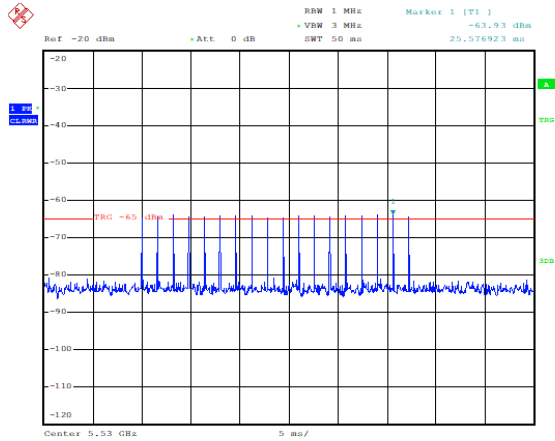

Date: 28.DEC.2021 13:14:44

7.2. In-Service Monitoring for Channel Move Time, Channel Closing Transmission Time and Non-Occupancy Period

Methods of Measurement

These tests define how the following DFS parameters are verified during In-Service Monitoring;

Channel Closing Transmission Time

Channel Move Time

Non-Occupancy Period

The steps below define the procedure to determine the above mentioned parameters when a radar Burst with a level equal to the DFS Detection Threshold + 1dB is generated on the Operating Channel of the U-NII device (In- Service Monitoring).

1. One frequency will be chosen from the Operating Channels of the EUT within the 5250-5350 MHz or 5470-5725 MHz bands. For 802.11 devices, the test frequency must contain control signals. This can be verified by disabling channel loading and monitoring the spectrum analyzer. If no control signals are detected, another frequency must be selected within the emission bandwidth where control signals are detected.

2. In case the EUT is a U-NII device operating as a Client Device (with or without DFS), a U-NII device operating as a Master Device will be used to allow the EUT (Client device) to Associate with the Master Device. In case the EUT is a Master Device, a U-NII device operating as a Client Device will be used and it is assumed that the Client will Associate with the EUT (Master). In both cases for conducted tests, the Radar Waveform generator will be connected to the Master Device. For radiated tests, the emissions of the Radar Waveform generator will be directed towards the Master Device. If the Master Device has antenna gain, the main beam of the antenna will be directed toward the radar emitter.

Vertical polarization is used for testing.

3. Stream the channel loading test file from the Master Device to the Client Device on the test Channel for the entire period of the test.

4. At time T_0 the Radar Waveform generator sends a Burst of pulses for one of the Radar Type 0 in Table 5 at levels defined in Table 3, on the Operating Channel. An additional 1 dB is added to the radar test signal to ensure it is at or above the DFS Detection Threshold, accounting for equipment variation /errors.

5. Observe the transmissions of the EUT at the end of the radar Burst on the Operating Channel for duration greater than 10 seconds. Measure and record the transmissions from the EUT during the observation time (Channel Move Time). Measure and record the Channel Move Time and Channel Closing Transmission Time if radar detection occurs. Figure 17 illustrates Channel Closing Transmission Time.

6. When operating as a Master Device, monitor the EUT for more than 30 minutes following instant T2 to verify that the EUT does not resume any transmissions on this Channel. Perform this test once and record the measurement result.

7. In case the EUT is a U-NII device operating as a Client Device with In-Service Monitoring, perform steps 1 to 6.

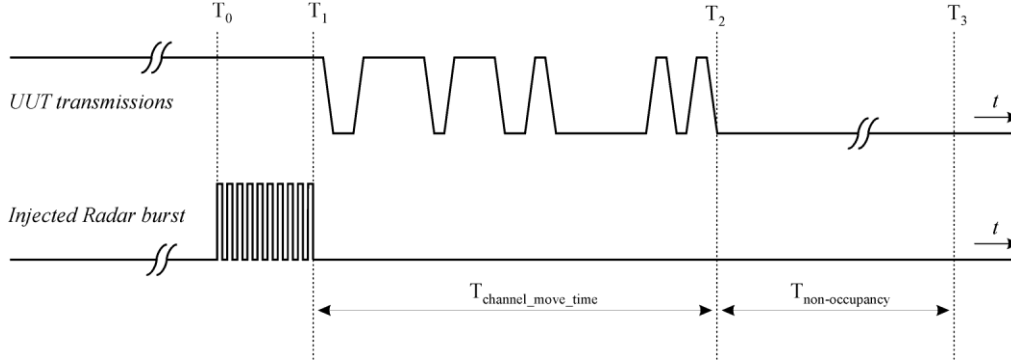

Figure 9: Channel Closing Transmission Time, Channel Move Time and Non-Occupancy Period

Limits:

Channel Move Time	$\leq 10s$
Channel Closing Transmission Time	$\leq 200ms + 60ms$ (over remaining 10s period)
Non-Occupancy Period	$\geq 30min$

Note 1: Channel Move Time and the Channel Closing Transmission Time should be performed with Radar Type 0. The measurement timing begins at the end of the Radar Type 0 burst.

Note 2: The Channel Closing Transmission Time is comprised of 200 milliseconds starting at the beginning of the Channel Move Time plus any additional intermittent control signals required to facilitate a channel move (an aggregate of 60 milliseconds) during the remainder of the 10 second period. The aggregate duration of control signals will not count quiet periods in between transmissions.

Note 3: The Channel Closing Transmission Time is calculated by the computer.

Method of calculation:

The Channel Closing Transmission Time =

Time to start the test and stop the transfer - The time between the start of the test and the insertion of the jamming signal.

The whole process is controlled and timed by a computer.

Measurement Results:



7.2.1 In-Service Monitoring for Channel Move Time and Channel Closing Transmission Time

Slave

MoveAndClose Time			
Bandwidth	Central Frequency	Move Time/s	Closing Transmission Time/ms
20MHz	5320MHz	0.113	20.997
	5500MHz	0.11	15.748
40MHz	5310MHz	0.066	5.249
	5510MHz	0.364	8.749
80MHz	5290MHz	0.075	6.999
	5530MHz	0.068	3.5

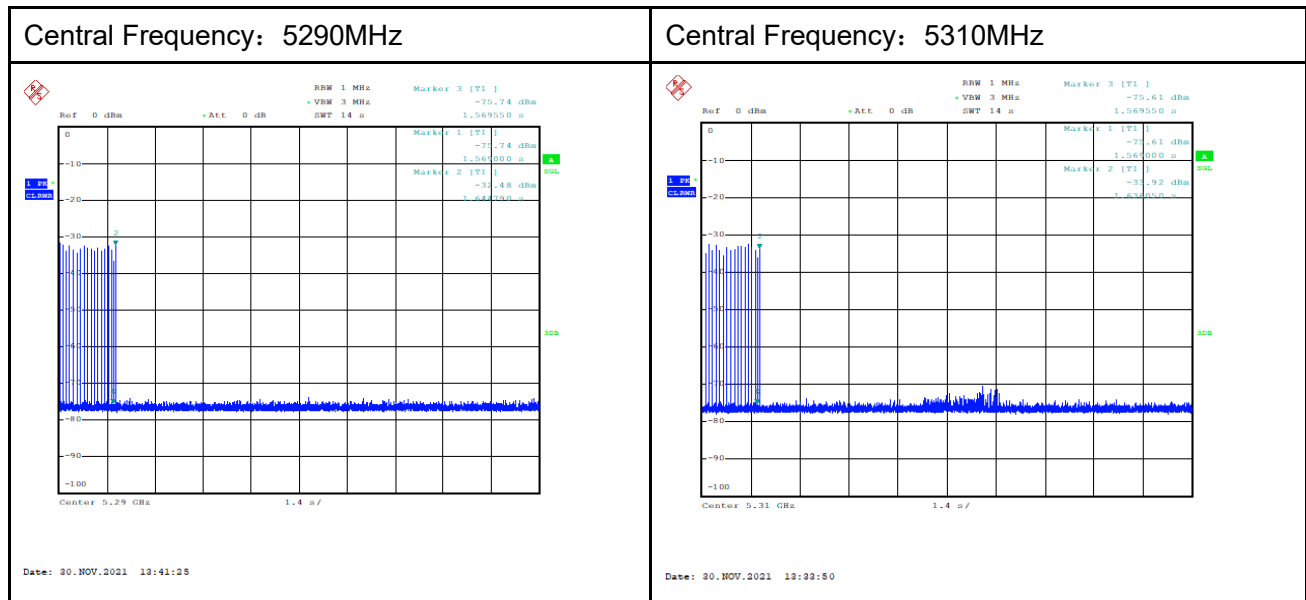

Central Frequency: 5320MHz	Central Frequency: 5500MHz
----------------------------	----------------------------

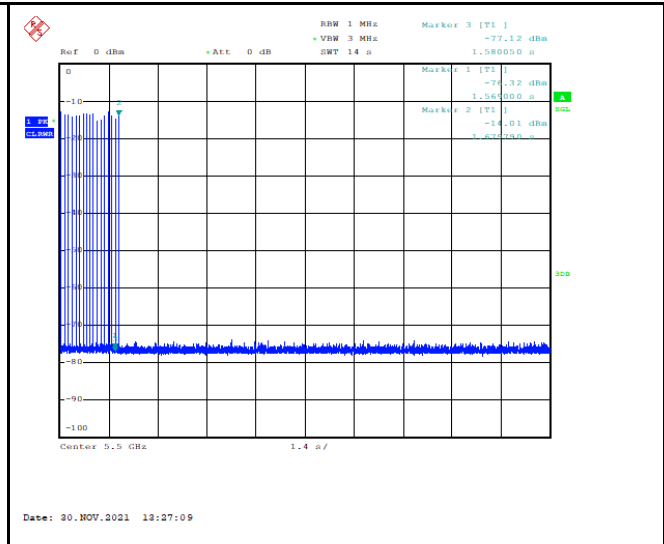
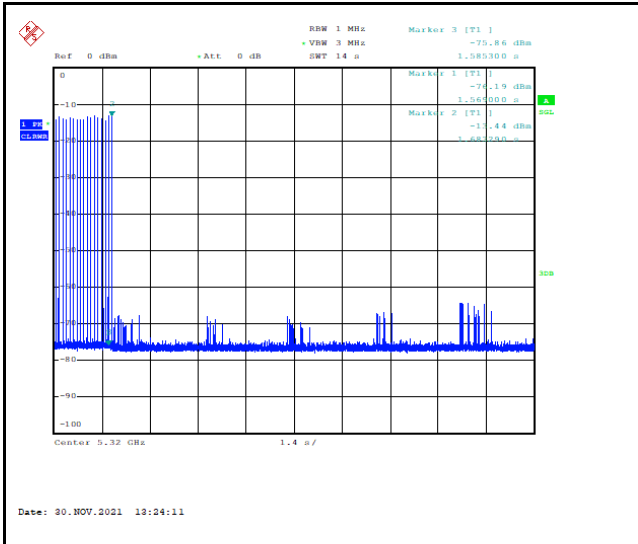

Central Frequency: 5510MHz

Central Frequency: 5530MHz

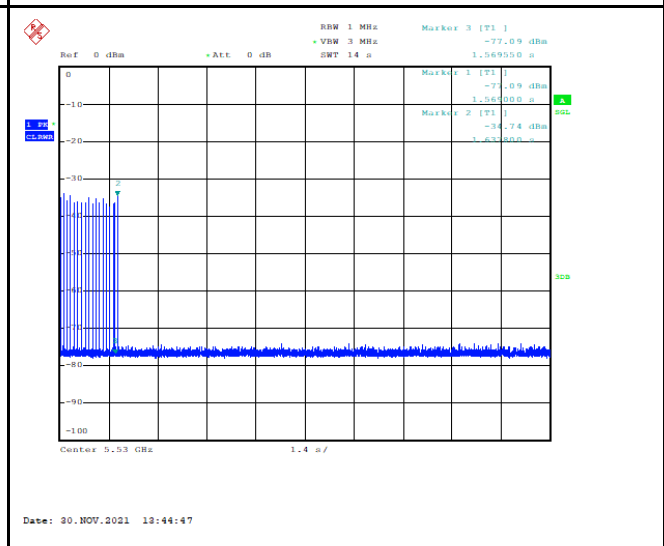
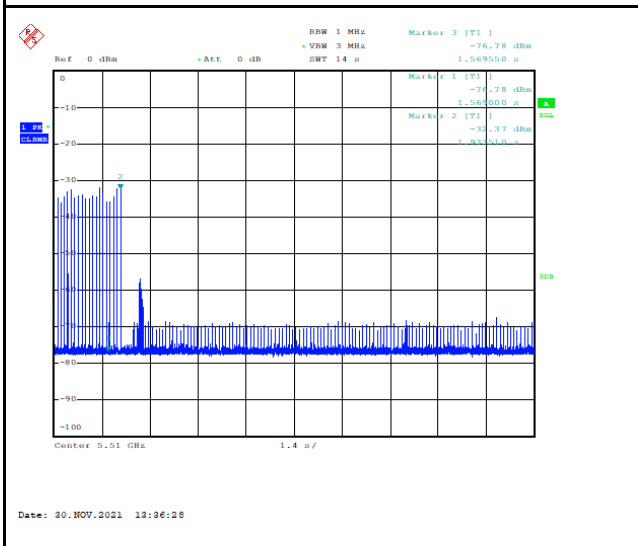

7.2.2 In-Service Monitoring for Non-Occupancy Period Slave

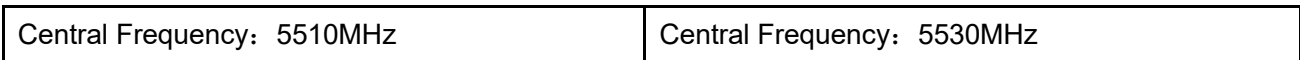
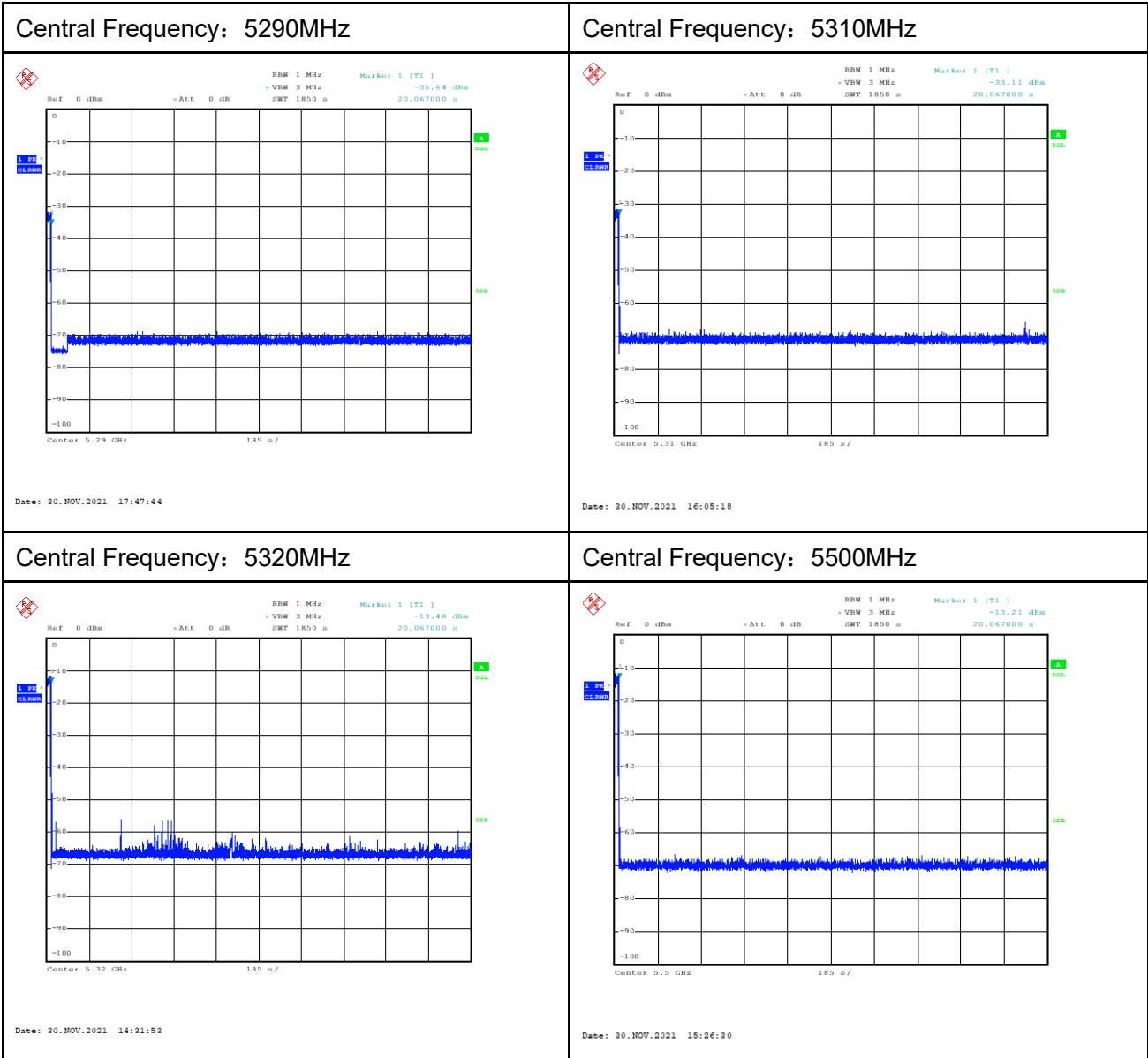

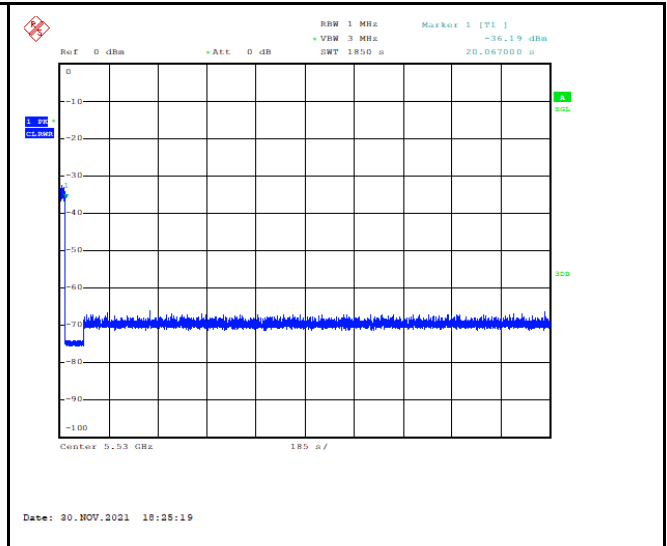
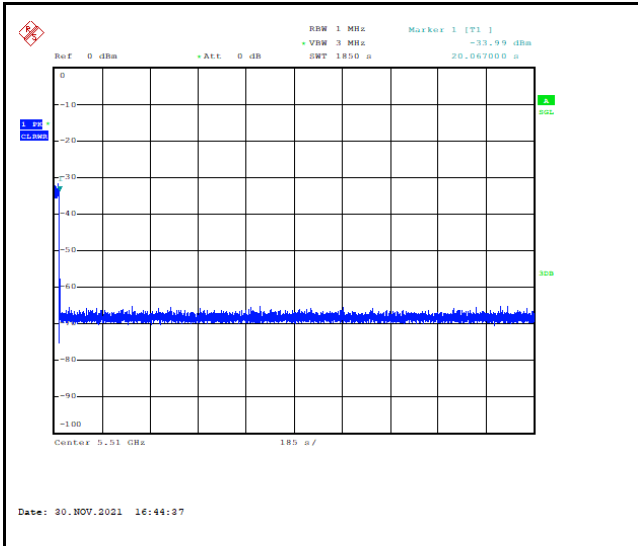

8. Test Equipment List

The test equipment and ancillaries used are as follows.

Conducted test system

Item	Equipment Name	Type	Serial Number	Manufacturer	Cal. Date	Cal. interval
1	Vector Signal Analyser	FSQ40	200063	R&S	2021-11-02	1 year
2	Wireless communication	CMW500	148904	R&S	2021-05-10	1 year
3	Network test unit AP	R7800	4H4E875F0105 1	NETGEAR	N/A	N/A
6	Eagle Test Software	Eagle V3.1 FCC	N/A	ECIT	N/A	N/A

Anechoic chamber

Fully anechoic chamber by ETS.

9. Test Environment

Shielding Room (6.0 meters×3.0 meters×2.7 meters) did not exceed following limits along the conducted RF performance testing:

Temperature	Min. = 15 °C, Max. = 35 °C
Relative humidity	Min. = 25 %, Max. = 75 %
Shielding effectiveness	> 100 dB
Ground system resistance	< 0.5 Ω

Annex A: Measurement Uncertainty

Measurement Uncertainty of Channel Shutdown:

The assessed measurement uncertainty to ensure 95% confidence level for the normal distribution is with the coverage factor $K=1.96$, $U=2.69\text{dB}$.

Measurement Uncertainty of Radiation test

Frequency Range	Uncertainty(dB)
$30\text{MHz} \leq f \leq 2\text{GHz}$	± 4.98
$2\text{GHz} \leq f \leq 12.75\text{GHz}$	± 5.06

Measurement Uncertainty of Conducted test

Measurement Items	Range	Confidence Level	Calculated Uncertainty
Peak Output Power-Conducted	2400MHz-2480MHz	95%	0.544dB
Peak Power Spectral Density	2400MHz-2480MHz	95%	0.088dB/MHz
Occupied Bandwidth	2400MHz-2480MHz	95%	69.26kHz
Conducted Emission	30MHz-2GHz	95%	0.90dB
Conducted Emission	2GHz-3.6GHz	95%	0.88dB
Conducted Emission	3.6GHz-8GHz	95%	0.96dB
Conducted Emission	8GHz-20GHz	95%	0.94dB
Conducted Emission	20GHz-22GHz	95%	0.88dB
Conducted Emission	22GHz-26GHz	95%	0.86dB

Annex B: Accreditation Certificate



Accredited Laboratory

A2LA has accredited

INDUSTRIAL INTERNET INNOVATION CENTER (SHANGHAI) CO., LTD.

Shanghai, People's Republic of China

for technical competence in the field of

Electrical Testing

This laboratory is accredited in accordance with the recognized International Standard ISO/IEC 17025:2017 *General requirements for the competence of testing and calibration laboratories*. This accreditation demonstrates technical competence for a defined scope and the operation of a laboratory quality management system (refer to joint ISO-ILAC-IAF Communiqué dated April 2017).



Presented this 12th day of April 2021.

Vice President, Accreditation Services
For the Accreditation Council
Certificate Number 3682.01
Valid to February 28, 2023

For the tests to which this accreditation applies, please refer to the laboratory's Electrical Scope of Accreditation.

*****END OF REPORT*****