

S

T

S

L

A

B



LTE RADIO TEST REPORT

Report No: STS1804055W02

Issued for

MeiG Smart Technology Co., Ltd

#5 Lingxia Road, Fenghuang the 4th Industrial Park, Fuyong Street, Bao'an District, Shenzhen, Guangdong, China

Product Name:	SLM757-module
Brand Name:	MeiGLink
Model Name:	SLM757
Series Model:	N/A
FCC ID:	2APJ4-SLM757
Test Standard:	47 CFR Part 2, 24(E), 27



Any reproduction of this document must be done in full. No single part of this document may be reproduced without permission from STS, All Test Data Presented in this report is only applicable to presented Test sample.



TEST RESULT CERTIFICATION

Applicant's name: MeiG Smart Technology Co., Ltd
 Address: #5 Lingxia Road,Fenghuang the 4th Industrial Park,Fuyong Street,Bao'an District,Shenzhen,Guangdong,China
Manufacture's Name: MeiG Smart Technology Co., Ltd
 Address: The 1st, 2nd, 3rd floor, BuildingA ,B, #5 Lingxia Road, Fenghuang the 4th Industrial Park, Fuyong Street, Bao'an District, Shenzhen, Guangdong, China

Product description

Product Name.....: SLM757-module
 Brand Name: MeiGLink
 Model Name: SLM757
 Series Model.....: N/A

Test Standards.....: 47 CFR Part 2, 24(E), 27

Test procedure.....: KDB 971168 D01 v03r01 , ANSI C63.26 2015

This device described above has been tested by STS and the test results show that the equipment under test (EUT) is in compliance with the FCC requirements. And it is applicable only to the tested sample identified in the report.

This report shall not be reproduced except in full, without the written approval of STS, this document only be altered or revised by STS, personal only, and shall be noted in the revision of the document.

Date of Test

Date of performance of tests 09 Apr. 2018~24 Apr. 2018

Date of Issue..... 25 Apr. 2018

Test Result..... **Pass**

Testing Engineer :

(Chris chen)

Technical Manager :

(Sean she)

Authorized Signatory :

(Vita Li)





TABLE OF CONTENTS	Page
1. TEST FACTORY&	5
2. GENERAL INFORMATION	6
3. CONDUCTED OUTPUT POWER	15
4. PEAK-TO-AVERAGE RATIO	28
5. RADIATED POWER AND EFFECTIVE ISOTROPIC RADIATED POWER	31
6. OCCUPIED BANDWIDTH	46
7. CONDUCTED BAND EDGE	50
8. CONDUCTED SPURIOUS EMISSION	52
9. RADIATED SPURIOUS EMISSION	53
10. FREQUENCY STABILITY	79
PHOTOS OF TEST SETUP	86





Revision History

Rev.	Issue Date	Report NO.	Effect Page	Contents
00	25 Apr. 2018	STS1804055W02	ALL	Initial Issue





1. TEST FACTORY& MEASUREMENT UNCERTAINTY

1.1.1 TEST FACTORY

Shenzhen STS Test Services Co., Ltd.

Add. : 1/F., Building B, Zhuoke Science Park, No.190, Chongqing Road, Fuyong Street, Bao'an District, Shenzhen, Guangdong, China

CNAS Registration No.: L7649; FCC Registration No.: 625569

IC Registration No.: 12108A; A2LA Certificate No.: 4338.01;

1.1.2 MEASUREMENT UNCERTAINTY

The reported uncertainty of measurement $y \pm U$, where expanded uncertainty U is based on a standard uncertainty multiplied by a coverage factor of $k=2$, providing a level of confidence of approximately **95 %**.

No.	Item	Uncertainty
3	RF power,conducted	± 0.71 dB
5	All emissions,radiated(<1G) 30MHz-200MHz	± 2.83 dB
6	All emissions,radiated(<1G) 200MHz-1000MHz	± 2.94 dB
7	All emissions,radiated(>1G)	± 3.03 dB



2. GENERAL INFORMATION

2.1 TECHNICAL SPECIFICATIONS AND REGULATIONS

2.1.1 PRODUCT DESCRIPTION

A major technical description of EUT is described as following:

Product Name:	SLM757-module
Hardware version:	SLM757-A_MB_PCB_V1.02
Software version:	SLM757AMG_EQ000_2EE0.21E13EB.484806A_171110_100_V01_T05
FCC ID:	2APJ4-SLM757
Frequency Bands:	U.S. Bands: <input checked="" type="checkbox"/> LTE FDD Band 2 <input checked="" type="checkbox"/> LTE FDD Band 4 <input checked="" type="checkbox"/> LTE FDD Band 5: <input type="checkbox"/> LTE FDD Band 7: <input checked="" type="checkbox"/> LTE FDD Band 12: <input checked="" type="checkbox"/> LTE FDD Band 13: <input checked="" type="checkbox"/> LTE FDD Band 17:
SIM CARD:	SIM 1 and SIM 2 is a chipset unit and tested as single chipset,SIM 1 is used to tested
Power Supply:	DC 3.8V



2.1.2 PRODUCT SPECIFICATION SUBJECTIVE TO THIS STANDARD

Product Specification Subjective To This Standard	
Tx Frequency	LTE Band 2:1850~1910MHz LTE Band 4:1710~1755MHz LTE Band 5:824~849MHz LTE Band 12:699~716MHz LTE Band 13:777~787MHz LTE Band 17:704~716MHz
Rx Frequency	LTE Band 2:1930 ~1990MHz LTE Band 4:2110~2155MHz LTE Band 5:869~894MHz LTE Band 12:729~746MHz LTE Band 13:746~756MHz LTE Band 17:736~746MHz
Bandwidth	LTE Band 2 : 1.4MHz / 3MHz / 5MHz / 10MHz / 15MHz / 20MHz LTE Band 4 : 1.4MHz / 3MHz / 5MHz / 10MHz / 15MHz / 20MHz LTE Band 5 : 1.4MHz / 3MHz / 5MHz / 10MHz LTE Band 12 : 1.4MHz / 3MHz / 5MHz / 10MHz LTE Band 13 : 5MHz / 10MHz LTE Band 17 : 5MHz / 10MHz
Maximum Output Power Limit	LTE Band 2 : 21.64dBm LTE Band 4 : 22.91 dBm LTE Band 5 : 22.15 dBm LTE Band 12 : 23.05 dBm LTE Band 13 : 22.70 dBm LTE Band 17 : 22.62 dBm
Type of Modulation	QPSK / 16QAM



2.1.3 EMISSION DESIGNATOR

LTE Band 2 BW(MHz)	Emission Designator (26dBc)QPSK	Emission Designator (26dBc)16QAM
1.4	1M33G7D	1M31W7D
3	2M94G7D	2M95W7D
5	5M02G7D	5M03W7D
10	9M73G7D	9M65W7D
15	14M7G7D	14M8W7D
20	19M5G7D	19M3W7D

LTE Band 4 BW(MHz)	Emission Designator (26dBc)QPSK	Emission Designator (26dBc)16QAM
1.4	1M33G7D	1M31W7D
3	2M93G7D	2M94W7D
5	5M00G7D	5M03W7D
10	9M77G7D	9M64W7D
15	14M8G7D	14M8W7D
20	19M4G7D	19M4W7D

LTE Band 5 BW(MHz)	Emission Designator (26dBc)QPSK	Emission Designator (26dBc)16QAM
1.4	1M30G7D	1M30W7D
3	2M93G7D	2M93W7D
5	5M02G7D	5M02W7D
10	9M73G7D	9M69W7D

LTE Band 12 BW(MHz)	Emission Designator (26dBc)QPSK	Emission Designator (26dBc)16QAM
1.4	1M31G7D	1M30W7D
3	2M93G7D	2M93W7D
5	5M00G7D	5M03W7D
10	9M77G7D	9M71W7D

LTE Band 13 BW(MHz)	Emission Designator (26dBc)QPSK	Emission Designator (26dBc)16QAM
5	5M01G7D	5M03W7D
10	9M75G7D	9M62W7D

LTE Band 17 BW(MHz)	Emission Designator (26dBc)QPSK	Emission Designator (26dBc)16QAM
5	5M01G7D	5M03W7D
10	9M71G7D	9M70W7D



2.1.4 TEST CONFIGURATION OF EQUIPMENT UNDER TEST

Antenna port conducted and radiated test items listed below are performed according to KDB 971168 D01 v03r01 and ANSI C63.26 2015 Power Meas. License Digital Systems with maximum output power. Radiated measurements are performed by rotating the EUT in three different orthogonal test planes to find the maximum emission.

Remark:

1. The mark “v “ means that this configuration is chosen for testing
2. The mark “-“ means that this bandwidth is not supported.
3. The device is investigated from 30MHz to 10 times of fundamental signal for radiated

ITEMS	Band	Bandwidth (MHz)						Modulation		RB #			Test Channel		
		1.4	3	5	10	15	20	QPSK	16QAM	1	Half	Full	L	M	H
Max. Output Power	2	v	v	v	v	v	v	v	v	v	v	v	v	v	v
	4	v	v	v	v	v	v	v	v	v	v	v	v	v	v
	5	v	v	v	v	-	-	v	v	v	v	v	v	v	v
	12	v	v	v	v	-	-	v	v	v	v	v	v	v	v
	13	-	-	v	v	-	-	v	v	v	v	v	v	v	v
	17	-	-	v	v	-	-	v	v	v	v	v	v	v	v
Peak&Avera Ratio	2	-	-	-	-	-	v	v	v	v		v	v	v	v
	4	-	-	-	-	-	v	v	v	v		v	v	v	v
	5	-	-	-	v	-	-	v	v	v		v	v	v	v
	12	-	-	-	v	-	-	v	v	v		v	-	v	-
	13	-	-	-	v	-	-	v	v	v		v	v	v	v
	17	-	-	-	v	-	-	v	v	v		v	v	v	v
26dB&99% Bandwidth	2	v	v	v	v	v	v	v	v			v	v	v	v
	4	v	v	v	v	v	v	v	v			v	v	v	v
	5	v	v	v	v	-	-	v	v			v	v	v	v
	12	v	v	v	v	-	-	v	v			v	v	v	v
	13	-	-	v	v	-	-	v	v			v	v	v	v
	17	-	-	v	v	-	-	v	v			v	v	v	v
Conducted Band Edge	2	v	v	v	v	v	v	v	v	v		v	v	v	v
	4	v	v	v	v	v	v	v	v	v		v	v	v	v
	5	v	v	v	v	-	-	v	v	v		v	v	v	v
	12	v	v	v	v	-	-	v	v	v		v	v	v	v
	13	-	-	v	v	-	-	v	v	v		v	v	v	v
	17	-	-	v	v	-	-	v	v	v		v	v	v	v



ITEMS	Band	Bandwidth (MHz)						Modulation		RB #			Test Channel		
		1.4	3	5	10	15	20	QPSK	16QAM	1	Half	Full	L	M	H
Conducted Spurious Emission	2	v	v	v	v	v	v	v	v	v			v	v	v
	4	v	v	v	v	v	v	v	v	v			v	v	v
	5	v	v	v	v	-	-	v	v	v			v	v	v
	12	v	v	v	v	-	-	v	v	v			v	v	v
	13	-	-	v	v	-	-	v	v	v			v	v	v
	17	-	-	v	v	-	-	v	v	v			v	v	v
Frequency Stability	2	-	-	-	v	-	-	v				v		v	
	4	-	-	-	v	-	-	v				v		v	
	5	-	-	-	v	-	-	v				v		v	
	12	-	-	-	v	-	-	v				v		v	
	13	-	-	-	v	-	-	v				v		v	
	17	-	-	-	v	-	-	v				v		v	
E.R.P.& E.I.R.P.	2	v	v	v	v	v	v	v	v	v			v	v	v
	4	v	v	v	v	v	v	v	v	v			v	v	v
	5	v	v	v	v	-	-	v	v	v			v	v	v
	12	v	v	v	v	-	-	v	v	v			v	v	v
	13	-	-	v	v	-	-	v	v	v			v	v	v
	17	-	-	v	v	-	-	v	v	v			v	v	v
Radiated Spurious Emission	2	v	v	v	v	v	v	v		v			v	v	v
	4	v	v	v	v	v	v	v		v			v	v	v
	5	v	v	v	v	-	-	v		v			v	v	v
	12	v	v	v	v	-	-	v		v			v	v	v
	13	-	-	v	v	-	-	v		v			v	v	v
	17	-	-	v	v	-	-	v		v			v	v	v



2.1.5 RELATED SUBMITTAL(S) / GRANT (S)

This submittal(s) (test report) is intended for filing to comply with the 47 CFR Part 2, 24(E), 27

2.1.6 SPECIAL ACCESSORIES

The battery and the charger, earphone supplied by the applicant were used as accessories and being tested with eut intended for fcc grant together.

2.1.7 EUT CONFIGURATION

The EUT configuration for testing is installed on RF field strength measurement to meet the Commission's requirement and operating in a manner which intends to maximize its emission characteristics in a continuous normal application.

2.1.8 EUT EXERCISE

The Transmitter was operated in the maximum output power mode through Communication Tester. The TX frequency was fixed which was for the purpose of the measurements.

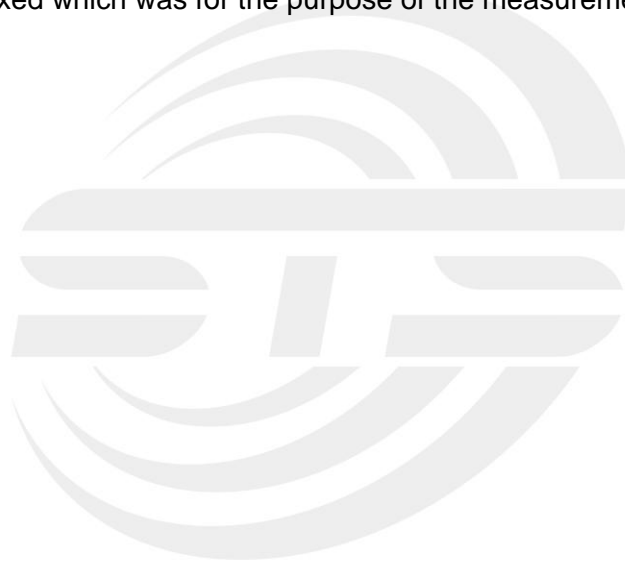



2.1.9 CONFIGURATION OF EUT SYSTEM

The EUT configuration for testing is installed on RF field strength measurement to meet the Commission's requirement and operating in a manner which intends to maximize its emission characteristics in a continuous normal application.

E-1
EUT

Table 2-1 Equipment Used in EUT System

Item	Equipment	Model No.	Serial No.	Note

Note:

- (1) The support equipment was authorized by Declaration of Confirmation.
- (2) For detachable type I/O cable should be specified the length in cm in 『Length』 column.



2.1.10 MEASUREMENT INSTRUMENTS

The radiated emission testing was performed according to the procedures of ANSI C63.26 2015 and FCC CFR 47 rules of 2.1046, 2.1047, 2.1049, 2.1051, 2.1053, 2.1055, 2.1057.

Kind of Equipment	Manufacturer	Type No.	Serial No.	Last Calibration	Calibrated Until
Test Receiver	R&S	ESCI	101427	2017.10.15	2018.10.14
Wireless Communications Test Set	R&S	CMW 500	131428	2018.03.11	2019.03.10
Bilog Antenna	TESEQ	CBL6111D	34678	2017.11.02	2018.11.01
Horn Antenna	Schwarzbeck	BBHA 9120D (1201)	9120D-1343	2017.10.27	2018.10.26
MXA SIGNAL Analyzer	Agilent	N9020A	MY49100060	2017.10.15	2018.10.14
Low frequency cable	N/A	R01	N/A	NCR	NCR
High frequency cable	SCHWARZBECK	AK9515H	SN-96286/96287	NCR	NCR
Signal Generator	Agilent	N5182A	MY46240556	2017.10.15	2018.10.14
Pre-mpifier (0.1M-3GHz)	EM	EM330	60538	2018.03.11	2019.03.10
PreAmplifier (1G-26.5GHz)	Agilent	8449B	60538	2017.10.15	2018.10.14
Temperature & Humidity test chamber	GZGONGWEN	GDS-250	080821	2017.10.15	2018.10.14
Band Reject filter(1920-1980MHz)	COM-MW	ZBSF-1920-1980	0092	2017.10.15	2018.10.14
Band Reject filter(880-915MHz)	COM-MW	ZBSF-C897.5-35	707	2017.10.15	2018.10.14
Band Reject filter(1710-1785MHz)	COM-MW	ZBSF-C1747.5-75	708	2017.10.15	2018.10.14
Band Reject filter(1850-1910MHz)	COM-MW	ZBSF-C1880-60	709	2017.10.15	2018.10.14
Band Reject filter(2500-2570MHz)	COM-MW	ZBSF-C2535-70	710	2017.10.15	2018.10.14
Highpass Filter	WHKX7.0/18G-8SS	Wainwright	18	2017.10.15	2018.10.14



2. 1.11 MEASUREMENT RESULTS EXPLANATION EXAMPLE

For all conducted test items:

The offset level is set in the spectrum analyzer to compensate the RF cable loss and attenuator factor between EUT conducted output port and spectrum analyzer. With the offset compensation, the spectrum analyzer reading level is exactly the EUT RF output level.

The spectrum analyzer offset is derived from RF cable loss and attenuator factor.

Offset = RF Cable Loss + Attenuator Factor.



3. CONDUCTED OUTPUT POWER

3.1 DESCRIPTION OF THE CONDUCTED OUTPUT POWER MEASUREMENT

3.1.1 MEASUREMENT METHOD

A System Simulator Was Used To Establish Communication With The EUT. Its Parameters Were Set To Force The EUT Transmitting At Maximum Output Power. The Measured Power In The Radio Frequency On The Transmitter Output Terminals Shall Be Reported.
configuration follows KDB 971168 D01 v03r01.

3.1.2 TEST SETUP

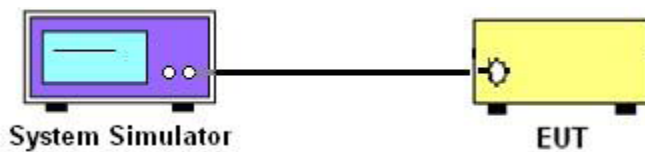

3.1.3 TEST PROCEDURES

1. The Transmitter Output Port Was Connected To The System Simulator.
2. Set EUT at maximum power through the system simulator.
3. Select lowest, middle, and highest channels for each band and different modulation.
4. Measure and record the power level from the system simulator.



3.1.4 TEST RESULTS

LTE BAND 2

LTE Band 2 Maximum Average Power [dBm]						
BW [MHz]	RB Size	RB Offset	Mod	Lowest	Middle	Highest
1.4	1	0	QPSK	21.16	21.31	20.94
1.4	1	2		21.42	21.36	20.91
1.4	1	5		21.15	21.37	20.83
1.4	3	0		21.36	21.04	21.12
1.4	3	1		21.39	21.32	21.13
1.4	3	2		21.38	21.06	21.18
1.4	6	0		20.15	20.16	20.14
1.4	1	0	16-QAM	20.36	19.85	20.06
1.4	1	2		20.59	20.04	20.07
1.4	1	5		20.51	19.86	19.95
1.4	3	0		20.5	20.45	19.93
1.4	3	1		20.26	20.69	19.94
1.4	3	2		20.4	20.6	19.9
1.4	6	0		19.45	19.58	18.89
3	1	0	QPSK	21.49	21.22	21.17
3	1	7		21.25	21.29	21.12
3	1	14		21.33	21.23	21.06
3	8	0		20.27	20.15	20.23
3	8	4		20.28	20.19	20.21
3	8	7		20.21	20.17	20.18
3	15	0		20.25	20.24	20.28
3	1	0	16-QAM	20.02	20.37	20.31
3	1	7		19.79	20.21	20.18
3	1	14		19.9	19.95	20.2
3	8	0		19.23	19.34	18.97
3	8	4		19.27	19.38	18.86
3	8	7		19.26	19.35	19.01
3	15	0		19.32	19.34	19.19



LTE BAND 2

LTE Band 2 Maximum Average Power [dBm]						
BW [MHz]	RB Size	RB Offset	Mod	Lowest	Middle	Highest
5	1	0	QPSK	21.42	21.06	21.15
5	1	12		21.55	21.11	21.15
5	1	24		21.64	21.18	21.18
5	12	0		20.41	20.19	20.29
5	12	6		20.23	20.18	20.28
5	12	11		20.23	20.27	20.21
5	25	0		20.33	20.31	20.25
5	1	0	16-QAM	20.03	19.81	20.06
5	1	12		19.71	19.93	20.21
5	1	24		19.95	19.61	20.12
5	12	0		19.42	19.36	19.07
5	12	6		19.34	19.36	18.97
5	12	11		19.36	19.36	18.91
5	25	0		19.39	19.39	19.36
10	1	0	QPSK	21.37	21.24	21.5
10	1	24		21.52	21.3	21.46
10	1	49		21.28	21.35	21.18
10	25	0		20.3	20.24	20.35
10	25	12		20.31	20.36	20.3
10	25	24		20.31	20.33	20.3
10	50	0		20.3	20.23	20.23
10	1	0	16-QAM	20.27	19.68	20.62
10	1	24		20.18	20.06	20.51
10	1	49		19.84	20.12	20.53
10	25	0		19.41	19.36	19.51
10	25	12		19.33	19.37	19.46
10	25	24		19.33	19.32	19.53
10	50	0		19.43	19.37	19.38



LTE BAND 2

LTE Band 2 Maximum Average Power [dBm]						
BW [MHz]	RB Size	RB Offset	Mod	Lowest	Middle	Highest
15	1	0	QPSK	21.4	21.04	21.02
15	1	37		21.16	20.77	20.8
15	1	74		20.95	20.48	20.56
15	36	0		20.66	20.28	20.31
15	36	18		20.42	19.98	20.04
15	36	39		20.19	19.73	19.8
15	75	0		19.93	19.44	19.52
15	1	0	16-QAM	21.11	20.74	20.73
15	1	38		20.84	20.54	20.5
15	1	75		20.62	20.32	20.3
15	36	0		20.4	20.07	20.03
15	36	18		20.12	19.79	19.76
15	36	39		19.9	19.58	19.55
15	75	0		19.62	19.3	19.35
20	1	0	QPSK	21.35	21.02	21
20	1	49		21.08	20.73	20.79
20	1	99		20.87	20.44	20.57
20	50	0		20.59	20.19	20.32
20	50	24		20.31	19.98	20.11
20	50	49		20.08	19.68	19.85
20	100	0		19.83	19.45	19.62
20	1	0	16-QAM	21.05	20.8	20.71
20	1	49		20.79	20.58	20.47
20	1	99		20.56	20.38	20.2
20	50	0		20.28	20.15	19.93
20	50	24		20.08	19.95	19.64
20	50	49		19.83	19.65	19.43
20	100	0		19.57	19.39	19.19



LTE BAND 4

LTE Band 4 Maximum Average Power [dBm]						
BW [MHz]	RB Size	RB Offset	Mod	Lowest	Middle	Highest
1.4	1	0	QPSK	22.41	22.34	22.12
1.4	1	2		22.61	22.6	22.23
1.4	1	5		22.56	22.25	22.13
1.4	3	0		22.62	22.31	22.17
1.4	3	1		22.51	22.44	22.21
1.4	3	2		22.64	22.44	22.03
1.4	6	0		21.52	21.4	21.13
1.4	1	0	16-QAM	21.78	21.25	21.04
1.4	1	2		21.68	21.24	21.18
1.4	1	5		21.51	21.11	21.09
1.4	3	0		21.61	21.46	20.92
1.4	3	1		21.7	21.38	20.95
1.4	3	2		21.74	21.58	20.96
1.4	6	0		20.74	20.54	20.22
3	1	0	QPSK	22.6	22.37	22.08
3	1	7		22.35	22.41	22.42
3	1	14		22.47	22.47	22.45
3	8	0		21.54	21.4	21.15
3	8	4		21.58	21.52	21.28
3	8	7		21.53	21.51	21.25
3	15	0		21.53	21.49	21.27
3	1	0	16-QAM	21.23	21.4	21.37
3	1	7		21.08	21.5	21.68
3	1	14		21.14	21.31	21.56
3	8	0		20.65	20.44	20.17
3	8	4		20.58	20.62	20.16
3	8	7		20.55	20.6	20.28
3	15	0		20.41	20.21	20.26



LTE BAND 4

LTE Band 4 Maximum Average Power [dBm]						
BW [MHz]	RB Size	RB Offset	Mod	Lowest	Middle	Highest
5	1	0	QPSK	22.46	22.33	22.18
5	1	12		22.91	22.58	22.36
5	1	24		22.31	22.55	22.56
5	12	0		21.59	21.43	21.39
5	12	6		21.48	21.53	21.31
5	12	11		21.45	21.61	21.3
5	25	0		21.58	21.54	21.38
5	1	0	16-QAM	21.16	21.08	21.16
5	1	12		21.02	21.21	21.25
5	1	24		21	21.05	21.25
5	12	0		20.4	20.25	20.27
5	12	6		20.29	20.4	20.18
5	12	11		20.27	20.39	20.26
5	25	0		20.44	20.41	20.47
10	1	0	QPSK	22.77	22.43	22.53
10	1	24		22.56	22.37	22.41
10	1	49		22.56	22.28	22.31
10	25	0		21.65	21.41	21.4
10	25	12		21.45	21.43	21.28
10	25	24		21.42	21.56	21.35
10	50	0		21.59	21.42	21.41
10	1	0	16-QAM	21.37	21.23	21.66
10	1	24		21.41	21.44	21.38
10	1	49		21.28	21.46	21.68
10	25	0		20.6	20.3	20.57
10	25	12		20.54	20.51	20.53
10	25	24		20.53	20.46	20.59
10	50	0		20.53	20.26	20.41



LTE BAND 4

LTE Band 4 Maximum Average Power [dBm]						
BW [MHz]	RB Size	RB Offset	Mod	Lowest	Middle	Highest
15	1	0	QPSK	22.43	22.3	22.15
15	1	37		22.19	22.03	21.86
15	1	74		21.93	21.76	21.57
15	36	0		21.65	21.47	21.36
15	36	18		21.39	21.27	21.11
15	36	39		21.14	20.97	20.83
15	75	0		20.84	20.77	20.6
15	1	0	16-QAM	22.19	22.04	21.89
15	1	38		21.95	21.79	21.6
15	1	75		21.68	21.55	21.38
15	36	0		21.46	21.29	21.1
15	36	18		21.19	20.99	20.89
15	36	39		20.98	20.7	20.68
15	75	0		20.77	20.4	20.46
20	1	0	QPSK	22.4	22.28	22.12
20	1	49		22.16	22	21.88
20	1	99		21.89	21.78	21.66
20	50	0		21.67	21.5	21.41
20	50	24		21.4	21.27	21.17
20	50	49		21.13	21.02	20.97
20	100	0		20.92	20.8	20.69
20	1	0	16-QAM	22.2	21.99	21.83
20	1	49		21.95	21.77	21.54
20	1	99		21.69	21.55	21.27
20	50	0		21.48	21.29	21.04
20	50	24		21.22	21.02	20.79
20	50	49		20.95	20.77	20.55
20	100	0		20.67	20.56	20.26



LTE BAND 5

LTE Band 5 Maximum Average Power [dBm]						
BW [MHz]	RB Size	RB Offset	Mod	Lowest	Middle	Highest
1.4	1	0	QPSK	21.84	21.87	21.69
1.4	1	2		21.89	21.93	21.98
1.4	1	5		21.77	21.81	21.72
1.4	3	0		21.94	21.91	21.79
1.4	3	1		21.99	21.92	21.78
1.4	3	2		21.89	21.96	21.89
1.4	6	0		20.94	20.88	20.74
1.4	1	0	16-QAM	20.81	20.64	20.59
1.4	1	2		20.74	20.88	20.74
1.4	1	5		20.62	20.75	20.49
1.4	3	0		21.15	20.7	20.62
1.4	3	1		21.18	20.73	20.41
1.4	3	2		21.17	20.78	20.53
1.4	6	0		20.06	19.76	19.83
3	1	0	QPSK	21.95	21.95	22.02
3	1	7		21.82	22.04	22.08
3	1	14		21.91	22.14	21.92
3	8	0		20.88	20.91	20.72
3	8	4		20.87	20.92	20.8
3	8	7		20.74	20.9	20.78
3	15	0		20.81	20.91	20.78
3	1	0	16-QAM	21	20.61	21.04
3	1	7		20.76	20.56	21.34
3	1	14		20.97	20.63	20.9
3	8	0		19.78	20.01	19.72
3	8	4		19.75	20.01	19.81
3	8	7		19.75	19.9	19.82
3	15	0		19.57	19.89	19.84



LTE BAND 5

LTE Band 5 Maximum Average Power [dBm]						
BW [MHz]	RB Size	RB Offset	Mod	Lowest	Middle	Highest
5	1	0	QPSK	21.94	21.9	21.65
5	1	12		22.15	22.12	21.87
5	1	24		21.62	22.03	21.84
5	12	0		20.78	20.97	20.66
5	12	6		20.81	20.94	20.81
5	12	11		20.85	20.92	20.79
5	25	0		20.76	21.01	20.75
5	1	0		16-QAM	20.59	20.5
5	1	12	20.63		20.74	20.52
5	1	24	20.28		20.7	20.63
5	12	0	19.67		20.03	19.6
5	12	6	19.71		20.02	19.68
5	12	11	19.64		19.96	19.71
5	25	0	19.69		19.98	19.79
10	1	0	QPSK		21.81	21.73
10	1	24		21.7	21.91	21.75
10	1	49		21.82	21.89	21.81
10	25	0		20.78	20.89	20.84
10	25	12		20.85	20.88	20.8
10	25	24		20.8	20.96	20.89
10	50	0		20.82	20.93	20.86
10	1	0		16-QAM	20.44	20.56
10	1	24	20.57		20.9	21.01
10	1	49	20.43		20.73	20.78
10	25	0	19.88		19.88	19.99
10	25	12	19.95		19.82	19.93
10	25	24	19.9		19.95	20.18
10	50	0	19.81		19.96	20.07



LTE BAND 12

LTE Band 12 Maximum Average Power [dBm]						
BW [MHz]	RB Size	RB Offset	Mod	Lowest	Middle	Highest
1.4	1	0	QPSK	22.66	22.38	22.82
1.4	1	2		22.85	22.62	22.65
1.4	1	5		22.71	22.52	22.54
1.4	3	0		22.7	22.53	21.91
1.4	3	1		22.82	22.7	21.88
1.4	3	2		22.79	22.75	21.73
1.4	6	0		21.78	21.67	21.86
1.4	1	0	16-QAM	21.96	21.77	21.91
1.4	1	2		22	21.89	21.54
1.4	1	5		22.01	21.76	21.48
1.4	3	0		22.14	21.51	20.69
1.4	3	1		22.26	21.5	20.66
1.4	3	2		22.13	21.61	20.83
1.4	6	0		20.89	20.67	20.71
3	1	0	QPSK	22.51	22.55	22.75
3	1	7		22.89	22.78	23.02
3	1	14		22.85	22.79	22.8
3	8	0		21.66	21.7	21.76
3	8	4		21.84	21.67	21.61
3	8	7		21.95	21.63	21.61
3	15	0		21.8	21.71	21.73
3	1	0	16-QAM	21.43	21.93	21.23
3	1	7		21.68	21.88	21.04
3	1	14		21.56	21.9	20.92
3	8	0		20.45	20.44	20.73
3	8	4		20.63	20.43	20.48
3	8	7		20.73	20.42	20.46
3	15	0		20.57	20.68	20.75



LTE BAND 12

LTE Band 12 Maximum Average Power [dBm]						
BW [MHz]	RB Size	RB Offset	Mod	Lowest	Middle	Highest
5	1	0	QPSK	22.75	22.56	22.64
5	1	12		23.02	22.89	22.77
5	1	24		22.8	22.87	22.67
5	12	0		21.76	21.64	21.86
5	12	6		21.61	21.84	21.76
5	12	11		21.61	21.88	21.71
5	25	0		21.73	21.72	21.76
5	1	0	16-QAM	21.23	20.84	21.45
5	1	12		21.04	21	21.24
5	1	24		20.92	21.37	21.27
5	12	0		20.73	20.41	20.29
5	12	6		20.48	20.61	20.52
5	12	11		20.46	20.65	20.4
5	25	0		20.75	20.69	20.65
10	1	0	QPSK	22.65	22.43	22.62
10	1	24		22.73	22.92	22.72
10	1	49		23.05	22.59	22.52
10	25	0		21.7	21.64	21.86
10	25	12		21.6	21.8	21.73
10	25	24		21.86	21.72	21.68
10	50	0		21.76	21.69	21.84
10	1	0	16-QAM	21.83	21.36	21.9
10	1	24		21.7	21.47	22.11
10	1	49		21.9	21.26	21.36
10	25	0		20.7	20.45	20.91
10	25	12		20.59	20.5	20.78
10	25	24		20.68	20.67	20.89
10	50	0		20.68	20.61	20.85



LTE BAND 13

LTE Band 13 Maximum Average Power [dBm]						
BW [MHz]	RB Size	RB Offset	Mod	Lowest	Middle	Highest
5	1	0	QPSK	22.21	22.19	22.41
5	1	12		22.44	22.7	22.49
5	1	24		22.54	22.48	22.45
5	12	0		21.18	21.16	21.47
5	12	6		21.1	21.22	21.41
5	12	11		21.19	21.47	21.39
5	25	0		21.3	21.31	21.55
5	1	0	16-QAM	20.9	20.89	21.12
5	1	12		21	21.44	20.96
5	1	24		21.52	21.03	21.15
5	12	0		20.16	20.31	20.44
5	12	6		20.13	20.38	20.27
5	12	11		20	20.44	20.25
5	25	0		20.33	20.43	20.53
10	1	0	QPSK	--	22.43	--
10	1	24		--	22.47	--
10	1	49		--	22.38	--
10	25	0		--	21.16	--
10	25	12		--	21.4	--
10	25	24		--	21.51	--
10	50	0		--	21.29	--
10	1	0	16-QAM	--	21.47	--
10	1	24		--	21.67	--
10	1	49		--	20.97	--
10	25	0		--	20.35	--
10	25	12		--	20.51	--
10	25	24		--	20.62	--
10	50	0		--	20.32	--



LTE BAND 17

LTE Band 17 Maximum Average Power [dBm]						
BW [MHz]	RB Size	RB Offset	Mod	Lowest	Middle	Highest
5	1	0	QPSK	22.27	22.29	22.24
5	1	12		22.54	22.44	22.39
5	1	24		22.59	22.14	22.13
5	12	0		21.16	21.33	21.17
5	12	6		21.33	21.32	21.07
5	12	11		21.42	21.28	21.13
5	25	0		21.33	21.3	21.29
5	1	0	16-QAM	20.92	21.05	20.95
5	1	12		21.02	21.29	20.98
5	1	24		21.03	21.09	20.71
5	12	0		20.34	20.32	20.1
5	12	6		20.43	20.25	20.01
5	12	11		20.41	20.23	19.99
5	25	0		20.25	20.49	20.26
10	1	0	QPSK	22.28	22.11	22.46
10	1	24		22.62	22.4	22.29
10	1	49		22.22	22.18	22.1
10	25	0		21.4	21.43	21.5
10	25	12		21.39	21.3	21.32
10	25	24		21.29	21.24	21.2
10	50	0		21.3	21.34	21.38
10	1	0	16-QAM	20.99	21.08	21.19
10	1	24		21.59	21.61	21.31
10	1	49		21.03	20.85	20.89
10	25	0		20.32	20.5	20.38
10	25	12		20.48	20.41	20.32
10	25	24		20.44	20.28	20.27
10	50	0		20.32	20.17	20.19

4. PEAK-TO-AVERAGE RATIO

4.1 DESCRIPTION OF THE CONDUCTED OUTPUT POWER MEASUREMENT

4.1.1 MEASUREMENT METHOD

Use one of the procedures presented in 4.1 to measure the total peak power and record as PPk. Use one of the applicable procedures presented 4.2 to measure the total average power and record as PAvg. Both the peak and average power levels must be expressed in the same logarithmic units (e.g., dBm). Determine the PAPR from:
 $PAPR (dB) = PPk (dBm) - PAvg (dBm)$.

4.1.2 TEST SETUP

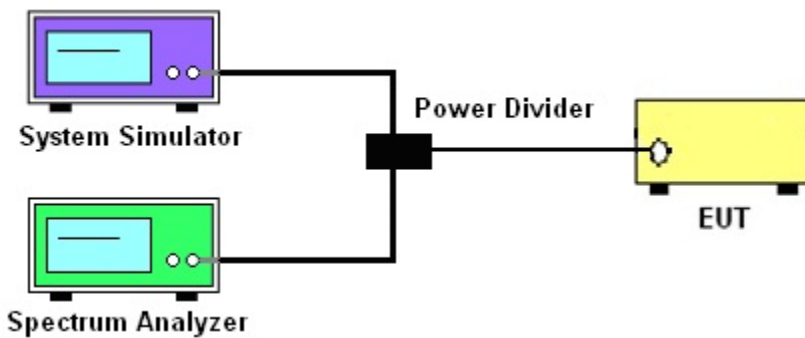

4.1.3 TEST PROCEDURES

1. The testing follows FCC KDB 971168 D01 v03r01 Section 5.7.2 and ANSI C63.26 2015 Section 5.2.3.4
2. The EUT was connected to spectrum and system simulator via a power divider
3. Select lowest, middle, and highest channels for each band and different modulation.
4. Set the test probe and measure the peak and average power of the spectrum analyzer
5. Record the deviation as Peak to Average Ratio.

	LTE					
LTE BW	1.4M	3M	5M	10M	15M	20M
Span	3MHz	6MHz	10MHz	20MHz	30MHz	40MHz
RBW	30kHz	30kHz	100kHz	100kHz	300kHz	300kHz
VBW	100kHz	100kHz	300kHz	300kHz	1000kHz	1000kHz
Detector	PK/AVG	PK/AVG	PK/AVG	PK/AVG	PK/AVG	PK/AVG
Trace	Max	Max	Max	Max	Max	Max
Sweep Count	Auto	Auto	Auto	Auto	Auto	Auto



4.1.4 TEST RESULTS

LTE BAND 2

LTE Band 2 PAR [dB]											
BW [MHz]	RB Size	Modulation	Lowest			Middle			Highest		
			PEAK	AVG	P-A	PEAK	AVG	P-A	PEAK	AVG	P-A
20	1	QPSK	27.09	21.35	5.74	26.84	21.02	5.82	26.92	21	5.92
20	100		25.72	19.83	5.89	25.25	19.45	5.8	25.33	19.62	5.71
20	1	16-QAM	26.99	21.05	5.94	26.67	20.8	5.87	26.64	20.71	5.93
20	100		25.51	19.57	5.94	25.32	19.39	5.93	25.08	19.19	5.89
Limit			≤13dB								

LTE BAND 4

LTE Band 4 PAR [dB]											
BW [MHz]	RB Size	Modulation	Lowest			Middle			Highest		
			PEAK	AVG	P-A	PEAK	AVG	P-A	PEAK	AVG	P-A
20	1	QPSK	28.26	22.4	5.86	28.19	22.28	5.91	27.91	22.12	5.79
20	100		26.67	20.92	5.75	26.55	20.8	5.75	26.41	20.69	5.72
20	1	16-QAM	28.18	22.2	5.98	27.72	21.99	5.73	27.62	21.83	5.79
20	100		26.46	20.67	5.79	26.49	20.56	5.93	26.04	20.26	5.78
Limit			≤13dB								

LTE BAND 5

LTE Band 5 PAR [dB]											
BW [MHz]	RB Size	Modulation	Lowest			Middle			Highest		
			PEAK	AVG	P-A	PEAK	AVG	P-A	PEAK	AVG	P-A
10	1	QPSK	27.77	21.81	5.96	27.63	21.73	5.9	27.83	21.95	5.88
10	50		26.68	20.82	5.86	26.71	20.93	5.78	26.66	20.86	5.8
10	1	16-QAM	26.38	20.44	5.94	26.51	20.56	5.95	26.82	20.85	5.97
10	50		25.71	19.81	5.9	25.73	19.96	5.77	26.05	20.07	5.98
Limit			≤13dB								



LTE BAND 12

LTE Band 12 PAR [dB]											
BW [MHz]	RB Size	Modulation	Lowest			Middle			Highest		
			PEAK	AVG	P-A	PEAK	AVG	P-A	PEAK	AVG	P-A
10	1	QPSK	28.46	22.65	5.81	28.17	22.43	5.74	28.33	22.62	5.71
10	50		27.68	21.76	5.92	27.54	21.69	5.85	27.59	21.84	5.75
10	1	16-QAM	27.62	21.83	5.79	27.2	21.36	5.84	27.87	21.9	5.97
10	50		26.65	20.68	5.97	26.34	20.61	5.73	26.77	20.85	5.92
Limit			≤13dB								

LTE BAND 13

LTE Band 13 PAR [dB]					
BW [MHz]	RB Size	Modulation	Middle		
			PEAK	AVG	P-A
10	1	QPSK	28.23	22.43	5.8
10	50		27.21	21.29	5.92
10	1	16-QAM	27.19	21.47	5.72
10	50		26.13	20.32	5.81
Limit			≤13dB		

LTE BAND 17

LTE Band 17 PAR [dB]											
BW [MHz]	RB Size	Modulation	Lowest			Middle			Highest		
			PEAK	AVG	P-A	PEAK	AVG	P-A	PEAK	AVG	P-A
10	1	QPSK	28.08	22.28	5.8	28.1	22.11	5.99	28.28	22.46	5.82
10	50		27.07	21.3	5.77	27.11	21.34	5.77	27.31	21.38	5.93
10	1	16-QAM	26.73	20.99	5.74	26.87	21.08	5.79	27.17	21.19	5.98
10	50		26.26	20.32	5.94	26.16	20.17	5.99	26.13	20.19	5.94
Limit			≤13dB								

5. RADIATED POWER AND EFFECTIVE ISOTROPIC RADIATED POWER

5.1 DESCRIPTION OF THE ERP/EIRP MEASUREMENT

5.1.1 MEASUREMENT METHOD

Effective radiated power output measurements by substitution method according to ANSI C63.26 2015, and the spectrum analyzer configuration follows KDB 971168 D01 Power Meas. License Digital Systems. Mobile and portable (hand-held) stations operating are limited to average ERP, Equivalent isotropic radiated power output measurements by substitution method according to ANSI /TIA / EIA-603-D, and the spectrum analyzer configuration follows KDB 971168 D01 Power Meas ,Mobile and portable (hand-held) stations operating are limited to average EIRP.

5.1.2 TEST SETUP

The procedure of radiated spurious emissions is as follows:

a) Pre-calibration With pre-calibration method, the Radiated Spurious Emissions(RSE) is calculated as, $RSE = Rx(dBuV) + CL(dB) + SA(dB) + Gain(dBi) - 107(dBuV \text{ to } dBm)$ The SA is calibrated using following setup.

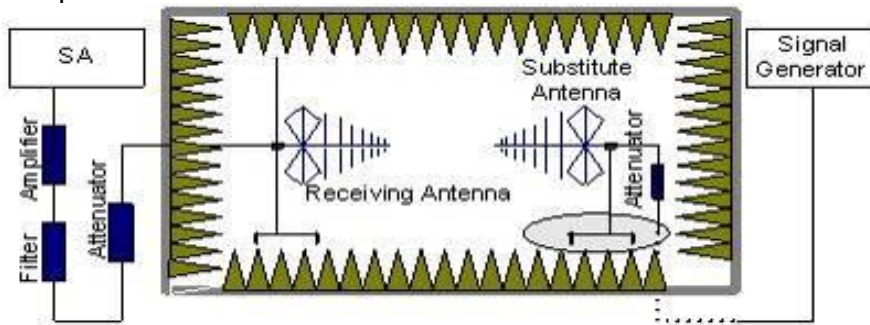

b) EUT was placed on a 1.5 meter high non-conductive stand at a 3 meter test distance from the receive antenna. A receiving antenna was placed on the antenna mast 3 meters from the test item for emission measurements. The height of receiving antenna is 0.8m. The test setup refers to figure below. Detected emissions were maximized at each frequency by rotating the test item and adjusting the receiving antenna polarization. The radiated emission measurements of all non-harmonic and harmonics of the transmit frequency through the 10th harmonic were measured with peak detector and 1MHz bandwidth.

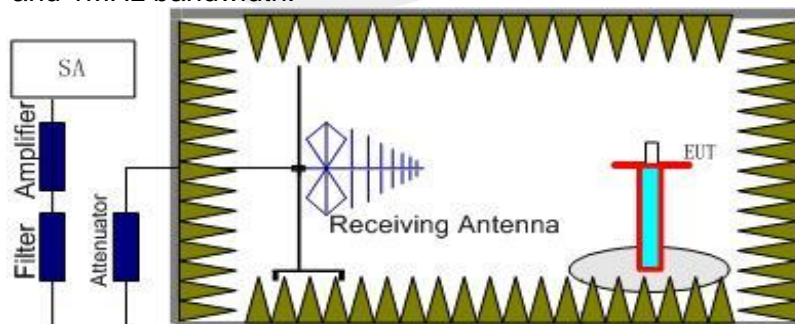

Radiated emissions measurements were made only at the upper, middle, and lower carrier frequencies It was decided that measurements at these three carrier frequencies would be sufficient to demonstrate compliance with emissions limits because it was seen that all the significant spurs occur well outside the band and no radiation was seen from a carrier in one block of any band into any of the other blocks.

The substitution method is used. Substitution values at each frequency are measured before and saved to the test software. A "reference path loss" is established and the ARpl is the attenuation of "reference path loss", and including the gain of receive antenna, the gain of the preamplifier, the cable loss and the air loss. The measurement results are obtained as described below: $Power = P_{Mea} + AR_{pl}$



5.1.3 TEST PROCEDURES

1. The testing follows FCC KDB 971168 D01v03r01 Section 5.6. and ANSI C63.26 2015 Section 5.2.
2. The EUT was placed on a non-conductive rotating platform 1.5 meters high in a semi-anechoic chamber. The radiated emission at the fundamental frequency was measured at 3 m with a test antenna and a spectrum analyzer with Peak detector.
3. During the measurement, the system simulator parameters were set to force the EUT transmitting at maximum output power. The maximum emission was recorded from analyzer power level (LVL) from the 360 degrees rotation of the turntable and the test antenna raised and lowered over a range from 1 to 4 meters in both horizontally and vertically polarized orientations.
4. Effective Isotropic Radiated Power (EIRP) was measured by substitution method according to TIA/EIA-603-D. The EUT was replaced by dipole antenna (substitution antenna) at same location, and then a known power from S.G. was applied into the dipole antenna through a Tx cable, and then recorded the maximum Analyzer reading through raised and lowered the test antenna. The correction factor (in dB) = S.G. - Tx Cable loss + Substitution antenna gain - Analyzer reading. Then the EUT's EIRP was calculated with the correction factor, $EIRP = LVL + \text{Correction factor}$ and $ERP = EIRP - 2.15$.
5. RB Set greater than bandwidth, Vb Set spectrum analyzer Maximum support.

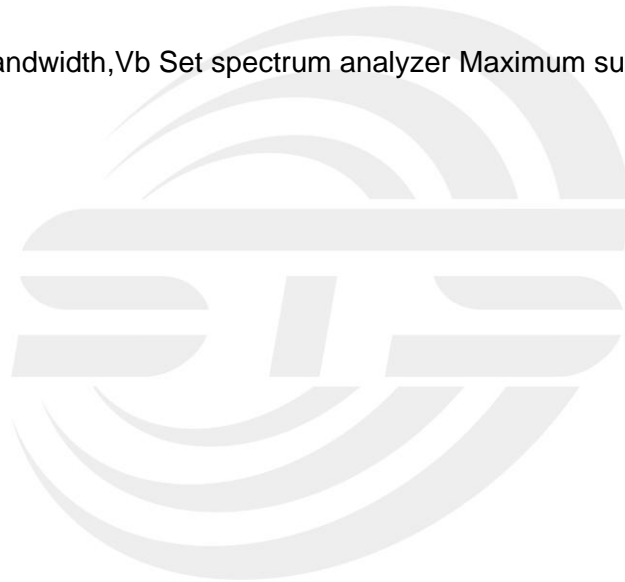



5.1.4 TEST RESULTS

LTE Band 2

Radiated Power (EIRP) for LTE Band 2 / 1.4M									
Modulation	RB		Channel	Result					Conclusion
	Size	Offset		S G.Level (dBm)	Cable loss	Gain (dBi)	PMeas E.I.R.P(dBm)	Polarization	
								Of Max. EIRP	
QPSK	1	0	Lowest	10.28	2.37	10.40	18.31	Horizontal	Pass
	1	0	Middle	10.44	2.39	10.42	18.47	Vertical	Pass
	1	0	Highest	10.19	2.40	10.44	18.23	Horizontal	Pass
	1	0	Lowest	11.77	2.37	10.40	19.80	Vertical	Pass
	1	0	Middle	11.89	2.39	10.42	19.92	Horizontal	Pass
	1	0	Highest	11.56	2.40	10.44	19.60	Vertical	Pass
16QAM	1	0	Lowest	9.63	2.37	10.40	17.66	Horizontal	Pass
	1	0	Middle	9.27	2.39	10.42	17.30	Vertical	Pass
	1	0	Highest	9.28	2.40	10.44	17.32	Horizontal	Pass
	1	0	Lowest	10.97	2.37	10.40	19.00	Vertical	Pass
	1	0	Middle	10.6	2.39	10.42	18.63	Horizontal	Pass
	1	0	Highest	10.73	2.40	10.44	18.77	Vertical	Pass
Limit	EIRP<2W=33dBm								



Radiated Power (EIRP) for LTE Band 2 / 3M									
Modulation	RB		Channel	Result					Conclusion
	Size	Offset		S G.Level (dBm)	Cable loss	Gain (dBi)	PMeas E.I.R.P.(dBm)	Polarization	
								Of Max. EIRP	
QPSK	1	0	Lowest	10.8	2.37	10.40	18.83	Horizontal	Pass
	1	0	Middle	10.58	2.39	10.42	18.61	Vertical	Pass
	1	0	Highest	10.34	2.40	10.44	18.38	Horizontal	Pass
	1	0	Lowest	12.15	2.37	10.40	20.18	Vertical	Pass
	1	0	Middle	11.88	2.39	10.42	19.91	Horizontal	Pass
	1	0	Highest	11.81	2.40	10.44	19.85	Vertical	Pass
16QAM	1	0	Lowest	9.42	2.37	10.40	17.45	Horizontal	Pass
	1	0	Middle	9.57	2.39	10.42	17.60	Vertical	Pass
	1	0	Highest	9.42	2.40	10.44	17.46	Horizontal	Pass
	1	0	Lowest	10.78	2.37	10.40	18.81	Vertical	Pass
	1	0	Middle	11.02	2.39	10.42	19.05	Horizontal	Pass
	1	0	Highest	10.89	2.40	10.44	18.93	Vertical	Pass
Limit	EIRP<2W=33dBm								

Radiated Power (EIRP) for LTE Band 2 / 5M									
Modulation	RB		Channel	Result					Conclusion
	Size	Offset		S G.Level (dBm)	Cable loss	Gain (dBi)	PMeas E.I.R.P.(dBm)	Polarization	
								Of Max. EIRP	
QPSK	1	0	Lowest	10.75	2.37	10.40	18.78	Horizontal	Pass
	1	0	Middle	10.32	2.39	10.42	18.35	Vertical	Pass
	1	0	Highest	10.44	2.40	10.44	18.48	Horizontal	Pass
	1	0	Lowest	12.15	2.37	10.40	20.18	Vertical	Pass
	1	0	Middle	11.68	2.39	10.42	19.71	Horizontal	Pass
	1	0	Highest	11.9	2.40	10.44	19.94	Vertical	Pass
16QAM	1	0	Lowest	9.28	2.37	10.40	17.31	Horizontal	Pass
	1	0	Middle	9.08	2.39	10.42	17.11	Vertical	Pass
	1	0	Highest	9.31	2.40	10.44	17.35	Horizontal	Pass
	1	0	Lowest	10.67	2.37	10.40	18.70	Vertical	Pass
	1	0	Middle	10.48	2.39	10.42	18.51	Horizontal	Pass
	1	0	Highest	10.76	2.40	10.44	18.80	Vertical	Pass
Limit	EIRP<2W=33dBm								



Radiated Power (EIRP) for LTE Band 2 / 10M									
Modulation	RB		Channel	Result					Conclusion
	Size	Offset		S G.Level (dBm)	Cable loss	Gain (dBi)	PMeas E.I.R.P(dBm)	Polarization	
								Of Max. EIRP	
QPSK	1	0	Lowest	10.75	2.37	10.40	18.78	Horizontal	Pass
	1	0	Middle	10.51	2.39	10.42	18.54	Vertical	Pass
	1	0	Highest	10.87	2.40	10.44	18.91	Horizontal	Pass
	1	0	Lowest	12.1	2.37	10.40	20.13	Vertical	Pass
	1	0	Middle	11.9	2.39	10.42	19.93	Horizontal	Pass
	1	0	Highest	12.2	2.40	10.44	20.24	Vertical	Pass
16QAM	1	0	Lowest	9.53	2.37	10.40	17.56	Horizontal	Pass
	1	0	Middle	8.91	2.39	10.42	16.94	Vertical	Pass
	1	0	Highest	9.81	2.40	10.44	17.85	Horizontal	Pass
	1	0	Lowest	10.99	2.37	10.40	19.02	Vertical	Pass
	1	0	Middle	10.4	2.39	10.42	18.43	Horizontal	Pass
	1	0	Highest	11.3	2.40	10.44	19.34	Vertical	Pass
Limit	EIRP<2W=33dBm								

Radiated Power (EIRP) for LTE Band 2 / 15M									
Modulation	RB		Channel	Result					Conclusion
	Size	Offset		S G.Level (dBm)	Cable loss	Gain (dBi)	PMeas E.I.R.P(dBm)	Polarization	
								Of Max. EIRP	
QPSK	1	0	Lowest	10.63	2.37	10.40	18.66	Horizontal	Pass
	1	0	Middle	10.44	2.39	10.42	18.47	Vertical	Pass
	1	0	Highest	10.35	2.40	10.44	18.39	Horizontal	Pass
	1	0	Lowest	12.07	2.37	10.40	20.10	Vertical	Pass
	1	0	Middle	11.81	2.39	10.42	19.84	Horizontal	Pass
	1	0	Highest	11.76	2.40	10.44	19.80	Vertical	Pass
16QAM	1	0	Lowest	10.36	2.37	10.40	18.39	Horizontal	Pass
	1	0	Middle	9.96	2.39	10.42	17.99	Vertical	Pass
	1	0	Highest	9.94	2.40	10.44	17.98	Horizontal	Pass
	1	0	Lowest	11.8	2.37	10.40	19.83	Vertical	Pass
	1	0	Middle	11.43	2.39	10.42	19.46	Horizontal	Pass
	1	0	Highest	11.36	2.40	10.44	19.40	Vertical	Pass
Limit	EIRP<2W=33dBm								



Radiated Power (EIRP) for LTE Band 2 / 20M									
Modulation	RB		Channel	Result					Conclusion
	Size	Offset		S G.Level (dBm)	Cable loss	Gain (dBi)	PMeas E.I.R.P(dBm)	Polarization	
								Of Max. EIRP	
QPSK	1	0	Lowest	10.49	2.37	10.40	18.52	Horizontal	Pass
	1	0	Middle	10.24	2.39	10.42	18.27	Vertical	Pass
	1	0	Highest	10.29	2.40	10.44	18.33	Horizontal	Pass
	1	0	Lowest	11.96	2.37	10.40	19.99	Vertical	Pass
	1	0	Middle	11.64	2.39	10.42	19.67	Horizontal	Pass
	1	0	Highest	11.66	2.40	10.44	19.70	Vertical	Pass
16QAM	1	0	Lowest	10.39	2.37	10.40	18.42	Horizontal	Pass
	1	0	Middle	10.04	2.39	10.42	18.07	Vertical	Pass
	1	0	Highest	10.01	2.40	10.44	18.05	Horizontal	Pass
	1	0	Lowest	11.78	2.37	10.40	19.81	Vertical	Pass
	1	0	Middle	11.54	2.39	10.42	19.57	Horizontal	Pass
	1	0	Highest	11.39	2.40	10.44	19.43	Vertical	Pass
Limit	EIRP<2W=33dBm								



LTE Band 4

Radiated Power (EIRP) for LTE Band 4 / 1.4M									
Modulation	RB		Channel	Result					Conclusion
	Size	Offset		S G.Level (dBm)	Cable loss	Gain (dBi)	PMeas E.I.R.P(dBm)	Polarization	
								Of Max. EIRP	
QPSK	1	0	Lowest	12.06	2.35	10.13	19.84	Horizontal	Pass
	1	0	Middle	11.85	2.36	10.16	19.65	Vertical	Pass
	1	0	Highest	11.56	2.37	10.22	19.41	Horizontal	Pass
	1	0	Lowest	13.41	2.35	10.13	21.19	Vertical	Pass
	1	0	Middle	13.27	2.36	10.16	21.07	Horizontal	Pass
	1	0	Highest	13.03	2.37	10.22	20.88	Vertical	Pass
16QAM	1	0	Lowest	11.42	2.35	10.13	19.20	Horizontal	Pass
	1	0	Middle	10.79	2.36	10.16	18.59	Vertical	Pass
	1	0	Highest	10.53	2.37	10.22	18.38	Horizontal	Pass
	1	0	Lowest	12.76	2.35	10.13	20.54	Vertical	Pass
	1	0	Middle	12.22	2.36	10.16	20.02	Horizontal	Pass
	1	0	Highest	11.84	2.37	10.22	19.69	Vertical	Pass
Limit	EIRP<1W=30dBm								

Radiated Power (EIRP) for LTE Band 4 / 3M									
Modulation	RB		Channel	Result					Conclusion
	Size	Offset		S G.Level (dBm)	Cable loss	Gain (dBi)	PMeas E.I.R.P(dBm)	Polarization	
								Of Max. EIRP	
QPSK	1	0	Lowest	12.06	2.35	10.13	19.84	Horizontal	Pass
	1	0	Middle	11.86	2.36	10.16	19.66	Vertical	Pass
	1	0	Highest	11.57	2.37	10.22	19.42	Horizontal	Pass
	1	0	Lowest	13.47	2.35	10.13	21.25	Vertical	Pass
	1	0	Middle	13.27	2.36	10.16	21.07	Horizontal	Pass
	1	0	Highest	13.01	2.37	10.22	20.86	Vertical	Pass
16QAM	1	0	Lowest	10.62	2.35	10.13	18.40	Horizontal	Pass
	1	0	Middle	10.98	2.36	10.16	18.78	Vertical	Pass
	1	0	Highest	10.84	2.37	10.22	18.69	Horizontal	Pass
	1	0	Lowest	12.05	2.35	10.13	19.83	Vertical	Pass
	1	0	Middle	12.32	2.36	10.16	20.12	Horizontal	Pass
	1	0	Highest	12.18	2.37	10.22	20.03	Vertical	Pass
Limit	EIRP<1W=30dBm								



Radiated Power (EIRP) for LTE Band 4 / 5M									
Modulation	RB		Channel	Result					Conclusion
	Size	Offset		S G.Level (dBm)	Cable loss	Gain (dBi)	PMeas E.I.R.P.(dBm)	Polarization	
								Of Max. EIRP	
QPSK	1	0	Lowest	11.96	2.35	10.13	19.74	Horizontal	Pass
	1	0	Middle	11.74	2.36	10.16	19.54	Vertical	Pass
	1	0	Highest	11.56	2.37	10.22	19.41	Horizontal	Pass
	1	0	Lowest	13.32	2.35	10.13	21.10	Vertical	Pass
	1	0	Middle	13.13	2.36	10.16	20.93	Horizontal	Pass
	1	0	Highest	13.01	2.37	10.22	20.86	Vertical	Pass
16QAM	1	0	Lowest	10.75	2.35	10.13	18.53	Horizontal	Pass
	1	0	Middle	10.69	2.36	10.16	18.49	Vertical	Pass
	1	0	Highest	10.76	2.37	10.22	18.61	Horizontal	Pass
	1	0	Lowest	12.09	2.35	10.13	19.87	Vertical	Pass
	1	0	Middle	12.02	2.36	10.16	19.82	Horizontal	Pass
	1	0	Highest	12.09	2.37	10.22	19.94	Vertical	Pass
Limit	EIRP<1W=30dBm								

Radiated Power (EIRP) for LTE Band 4 / 10M									
Modulation	RB		Channel	Result					Conclusion
	Size	Offset		S G.Level (dBm)	Cable loss	Gain (dBi)	PMeas E.I.R.P.(dBm)	Polarization	
								Of Max. EIRP	
QPSK	1	0	Lowest	12.4	2.35	10.13	20.18	Horizontal	Pass
	1	0	Middle	11.97	2.36	10.16	19.77	Vertical	Pass
	1	0	Highest	12.05	2.37	10.22	19.90	Horizontal	Pass
	1	0	Lowest	13.79	2.35	10.13	21.57	Vertical	Pass
	1	0	Middle	13.41	2.36	10.16	21.21	Horizontal	Pass
	1	0	Highest	13.37	2.37	10.22	21.22	Vertical	Pass
16QAM	1	0	Lowest	10.82	2.35	10.13	18.60	Horizontal	Pass
	1	0	Middle	10.82	2.36	10.16	18.62	Vertical	Pass
	1	0	Highest	11.06	2.37	10.22	18.91	Horizontal	Pass
	1	0	Lowest	12.24	2.35	10.13	20.02	Vertical	Pass
	1	0	Middle	12.22	2.36	10.16	20.02	Horizontal	Pass
	1	0	Highest	12.52	2.37	10.22	20.37	Vertical	Pass
Limit	EIRP<1W=30dBm								



Radiated Power (EIRP) for LTE Band 4 / 15M									
Modulation	RB		Channel	Result					Conclusion
	Size	Offset		S G.Level (dBm)	Cable loss	Gain (dBi)	PMeas E.I.R.P(dBm)	Polarization	
								Of Max. EIRP	
QPSK	1	0	Lowest	12.1	2.35	10.13	19.88	Horizontal	Pass
	1	0	Middle	11.84	2.36	10.16	19.64	Vertical	Pass
	1	0	Highest	11.67	2.37	10.22	19.52	Horizontal	Pass
	1	0	Lowest	13.44	2.35	10.13	21.22	Vertical	Pass
	1	0	Middle	13.21	2.36	10.16	21.01	Horizontal	Pass
	1	0	Highest	13.07	2.37	10.22	20.92	Vertical	Pass
16QAM	1	0	Lowest	11.58	2.35	10.13	19.36	Horizontal	Pass
	1	0	Middle	11.46	2.36	10.16	19.26	Vertical	Pass
	1	0	Highest	11.39	2.37	10.22	19.24	Horizontal	Pass
	1	0	Lowest	13.08	2.35	10.13	20.86	Vertical	Pass
	1	0	Middle	12.85	2.36	10.16	20.65	Horizontal	Pass
	1	0	Highest	12.77	2.37	10.22	20.62	Vertical	Pass
Limit	EIRP<1W=30dBm								

Radiated Power (EIRP) for LTE Band 4 / 20M									
Modulation	RB		Channel	Result					Conclusion
	Size	Offset		S G.Level (dBm)	Cable loss	Gain (dBi)	PMeas E.I.R.P(dBm)	Polarization	
								Of Max. EIRP	
QPSK	1	0	Lowest	11.98	2.35	10.13	19.76	Horizontal	Pass
	1	0	Middle	11.9	2.36	10.16	19.70	Vertical	Pass
	1	0	Highest	11.6	2.37	10.22	19.45	Horizontal	Pass
	1	0	Lowest	13.28	2.35	10.13	21.06	Vertical	Pass
	1	0	Middle	13.26	2.36	10.16	21.06	Horizontal	Pass
	1	0	Highest	13	2.37	10.22	20.85	Vertical	Pass
16QAM	1	0	Lowest	11.7	2.35	10.13	19.48	Horizontal	Pass
	1	0	Middle	11.54	2.36	10.16	19.34	Vertical	Pass
	1	0	Highest	11.22	2.37	10.22	19.07	Horizontal	Pass
	1	0	Lowest	13.13	2.35	10.13	20.91	Vertical	Pass
	1	0	Middle	12.89	2.36	10.16	20.69	Horizontal	Pass
	1	0	Highest	12.61	2.37	10.22	20.46	Vertical	Pass
Limit	EIRP<1W=30dBm								



LTE Band 5

Radiated Power (EIRP) for LTE Band 5 / 1.4M									
Modulation	RB		Channel	Result					Conclusion
	Size	Offset		S G.Level (dBm)	Cable loss	Gain (dBi)	PMeas E.I.R.P(dBm)	Polarization	
								Of Max. EIRP	
QPSK	1	0	Lowest	13.75	1.27	6.70	19.18	Horizontal	Pass
	1	0	Middle	13.81	1.28	6.70	19.23	Vertical	Pass
	1	0	Highest	13.52	1.29	6.70	18.93	Horizontal	Pass
	1	0	Lowest	15.05	1.27	6.70	20.48	Vertical	Pass
	1	0	Middle	15.21	1.28	6.70	20.63	Horizontal	Pass
	1	0	Highest	14.92	1.29	6.70	20.33	Vertical	Pass
16QAM	1	0	Lowest	12.68	1.27	6.70	18.11	Horizontal	Pass
	1	0	Middle	12.49	1.28	6.70	17.91	Vertical	Pass
	1	0	Highest	12.51	1.29	6.70	17.92	Horizontal	Pass
	1	0	Lowest	14.13	1.27	6.70	19.56	Vertical	Pass
	1	0	Middle	13.9	1.28	6.70	19.32	Horizontal	Pass
	1	0	Highest	13.85	1.29	6.70	19.26	Vertical	Pass
Limit	EIRP<2W=33dBm								

Radiated Power (EIRP) for LTE Band 5 / 3M									
Modulation	RB		Channel	Result					Conclusion
	Size	Offset		S G.Level (dBm)	Cable loss	Gain (dBi)	PMeas E.I.R.P(dBm)	Polarization	
								Of Max. EIRP	
QPSK	1	0	Lowest	13.82	1.27	6.70	19.25	Horizontal	Pass
	1	0	Middle	13.88	1.28	6.70	19.30	Vertical	Pass
	1	0	Highest	13.87	1.29	6.70	19.28	Horizontal	Pass
	1	0	Lowest	15.31	1.27	6.70	20.74	Vertical	Pass
	1	0	Middle	15.33	1.28	6.70	20.75	Horizontal	Pass
	1	0	Highest	15.27	1.29	6.70	20.68	Vertical	Pass
16QAM	1	0	Lowest	12.96	1.27	6.70	18.39	Horizontal	Pass
	1	0	Middle	12.57	1.28	6.70	17.99	Vertical	Pass
	1	0	Highest	12.81	1.29	6.70	18.22	Horizontal	Pass
	1	0	Lowest	14.29	1.27	6.70	19.72	Vertical	Pass
	1	0	Middle	13.94	1.28	6.70	19.36	Horizontal	Pass
	1	0	Highest	14.3	1.29	6.70	19.71	Vertical	Pass
Limit	EIRP<2W=33dBm								



Radiated Power (EIRP) for LTE Band 5 / 5M									
Modulation	RB		Channel	Result					Conclusion
	Size	Offset		S G.Level (dBm)	Cable loss	Gain (dBi)	PMeas E.I.R.P(dBm)	Polarization	
								Of Max. EIRP	
QPSK	1	0	Lowest	13.82	1.27	6.70	19.25	Horizontal	Pass
	1	0	Middle	13.72	1.28	6.70	19.14	Vertical	Pass
	1	0	Highest	13.51	1.29	6.70	18.92	Horizontal	Pass
	1	0	Lowest	15.26	1.27	6.70	20.69	Vertical	Pass
	1	0	Middle	15.17	1.28	6.70	20.59	Horizontal	Pass
	1	0	Highest	14.95	1.29	6.70	20.36	Vertical	Pass
16QAM	1	0	Lowest	12.4	1.27	6.70	17.83	Horizontal	Pass
	1	0	Middle	12.47	1.28	6.70	17.89	Vertical	Pass
	1	0	Highest	12.43	1.29	6.70	17.84	Horizontal	Pass
	1	0	Lowest	13.86	1.27	6.70	19.29	Vertical	Pass
	1	0	Middle	13.8	1.28	6.70	19.22	Horizontal	Pass
	1	0	Highest	13.73	1.29	6.70	19.14	Vertical	Pass
Limit	EIRP<2W=33dBm								

Radiated Power (EIRP) for LTE Band 5 / 10M									
Modulation	RB		Channel	Result					Conclusion
	Size	Offset		S G.Level (dBm)	Cable loss	Gain (dBi)	PMeas E.I.R.P(dBm)	Polarization	
								Of Max. EIRP	
QPSK	1	0	Lowest	13.59	1.27	6.70	19.02	Horizontal	Pass
	1	0	Middle	13.79	1.28	6.70	19.21	Vertical	Pass
	1	0	Highest	13.67	1.29	6.70	19.08	Horizontal	Pass
	1	0	Lowest	15.03	1.27	6.70	20.46	Vertical	Pass
	1	0	Middle	15.11	1.28	6.70	20.53	Horizontal	Pass
	1	0	Highest	15.14	1.29	6.70	20.55	Vertical	Pass
16QAM	1	0	Lowest	12.34	1.27	6.70	17.77	Horizontal	Pass
	1	0	Middle	12.42	1.28	6.70	17.84	Vertical	Pass
	1	0	Highest	12.7	1.29	6.70	18.11	Horizontal	Pass
	1	0	Lowest	13.73	1.27	6.70	19.16	Vertical	Pass
	1	0	Middle	13.82	1.28	6.70	19.24	Horizontal	Pass
	1	0	Highest	14.17	1.29	6.70	19.58	Vertical	Pass
Limit	EIRP<2W=33dBm								



LTE Band 12

Radiated Power (EIRP) for LTE Band 12 / 1.4M									
Modulation	RB		Channel	Result					Conclusion
	Size	Offset		S G.Level (dBm)	Cable loss	Gain (dBi)	PMeas E.I.R.P(dBm)	Polarization	
								Of Max. EIRP	
QPSK	1	0	Lowest	14.69	1.21	6.40	19.88	Horizontal	Pass
	1	0	Middle	14.55	1.22	6.40	19.73	Vertical	Pass
	1	0	Highest	15.04	1.23	6.40	20.21	Horizontal	Pass
	1	0	Lowest	16.18	1.21	6.40	21.37	Vertical	Pass
	1	0	Middle	15.92	1.22	6.40	21.10	Horizontal	Pass
	1	0	Highest	16.43	1.23	6.40	21.60	Vertical	Pass
16QAM	1	0	Lowest	13.9	1.21	6.40	19.09	Horizontal	Pass
	1	0	Middle	14	1.22	6.40	19.18	Vertical	Pass
	1	0	Highest	14	1.23	6.40	19.17	Horizontal	Pass
	1	0	Lowest	15.38	1.21	6.40	20.57	Vertical	Pass
	1	0	Middle	15.34	1.22	6.40	20.52	Horizontal	Pass
	1	0	Highest	15.43	1.23	6.40	20.60	Vertical	Pass
Limit	EIRP<2W=33dBm								

Radiated Power (EIRP) for LTE Band 12 / 3M									
Modulation	RB		Channel	Result					Conclusion
	Size	Offset		S G.Level (dBm)	Cable loss	Gain (dBi)	PMeas E.I.R.P(dBm)	Polarization	
								Of Max. EIRP	
QPSK	1	0	Lowest	14.66	1.21	6.40	19.85	Horizontal	Pass
	1	0	Middle	14.74	1.22	6.40	19.92	Vertical	Pass
	1	0	Highest	14.87	1.23	6.40	20.04	Horizontal	Pass
	1	0	Lowest	15.97	1.21	6.40	21.16	Vertical	Pass
	1	0	Middle	16.11	1.22	6.40	21.29	Horizontal	Pass
	1	0	Highest	16.37	1.23	6.40	21.54	Vertical	Pass
16QAM	1	0	Lowest	13.64	1.21	6.40	18.83	Horizontal	Pass
	1	0	Middle	13.93	1.22	6.40	19.11	Vertical	Pass
	1	0	Highest	13.37	1.23	6.40	18.54	Horizontal	Pass
	1	0	Lowest	15	1.21	6.40	20.19	Vertical	Pass
	1	0	Middle	15.38	1.22	6.40	20.56	Horizontal	Pass
	1	0	Highest	14.68	1.23	6.40	19.85	Vertical	Pass
Limit	EIRP<2W=33dBm								



Radiated Power (EIRP) for LTE Band 12 / 5M									
Modulation	RB		Channel	Result					Conclusion
	Size	Offset		S G.Level (dBm)	Cable loss	Gain (dBi)	PMeas E.I.R.P(dBm)	Polarization	
								Of Max. EIRP	
QPSK	1	0	Lowest	14.87	1.21	6.40	20.06	Horizontal	Pass
	1	0	Middle	14.61	1.22	6.40	19.79	Vertical	Pass
	1	0	Highest	14.77	1.23	6.40	19.94	Horizontal	Pass
	1	0	Lowest	16.25	1.21	6.40	21.44	Vertical	Pass
	1	0	Middle	16.03	1.22	6.40	21.21	Horizontal	Pass
	1	0	Highest	16.26	1.23	6.40	21.43	Vertical	Pass
16QAM	1	0	Lowest	13.32	1.21	6.40	18.51	Horizontal	Pass
	1	0	Middle	13.04	1.22	6.40	18.22	Vertical	Pass
	1	0	Highest	13.46	1.23	6.40	18.63	Horizontal	Pass
	1	0	Lowest	14.74	1.21	6.40	19.93	Vertical	Pass
	1	0	Middle	14.46	1.22	6.40	19.64	Horizontal	Pass
	1	0	Highest	14.95	1.23	6.40	20.12	Vertical	Pass
Limit	EIRP<2W=33dBm								

Radiated Power (EIRP) for LTE Band 12 / 10M									
Modulation	RB		Channel	Result					Conclusion
	Size	Offset		S G.Level (dBm)	Cable loss	Gain (dBi)	PMeas E.I.R.P(dBm)	Polarization	
								Of Max. EIRP	
QPSK	1	0	Lowest	14.82	1.21	6.40	20.01	Horizontal	Pass
	1	0	Middle	14.55	1.22	6.40	19.73	Vertical	Pass
	1	0	Highest	14.77	1.23	6.40	19.94	Horizontal	Pass
	1	0	Lowest	16.18	1.21	6.40	21.37	Vertical	Pass
	1	0	Middle	15.98	1.22	6.40	21.16	Horizontal	Pass
	1	0	Highest	16.15	1.23	6.40	21.32	Vertical	Pass
16QAM	1	0	Lowest	13.91	1.21	6.40	19.10	Horizontal	Pass
	1	0	Middle	13.62	1.22	6.40	18.80	Vertical	Pass
	1	0	Highest	14.01	1.23	6.40	19.18	Horizontal	Pass
	1	0	Lowest	15.39	1.21	6.40	20.58	Vertical	Pass
	1	0	Middle	14.96	1.22	6.40	20.14	Horizontal	Pass
	1	0	Highest	15.43	1.23	6.40	20.60	Vertical	Pass
Limit	EIRP<2W=33dBm								



LTE Band 13

Radiated Power (EIRP) for LTE Band 13 / 5M									
Modulation	RB		Channel	Result					Conclusion
	Size	Offset		S G.Level (dBm)	Cable loss	Gain (dBi)	PMeas E.I.R.P.(dBm)	Polarization	
								Of Max. EIRP	
QPSK	1	0	Lowest	14.2	1.21	6.40	19.39	Horizontal	Pass
	1	0	Middle	14.24	1.22	6.40	19.42	Vertical	Pass
	1	0	Highest	14.38	1.23	6.40	19.55	Horizontal	Pass
	1	0	Lowest	15.65	1.21	6.40	20.84	Vertical	Pass
	1	0	Middle	15.71	1.22	6.40	20.89	Horizontal	Pass
	1	0	Highest	15.86	1.23	6.40	21.03	Vertical	Pass
16QAM	1	0	Lowest	12.99	1.21	6.40	18.18	Horizontal	Pass
	1	0	Middle	13	1.22	6.40	18.18	Vertical	Pass
	1	0	Highest	13.29	1.23	6.40	18.46	Horizontal	Pass
	1	0	Lowest	14.31	1.21	6.40	19.50	Vertical	Pass
	1	0	Middle	14.36	1.22	6.40	19.54	Horizontal	Pass
	1	0	Highest	14.74	1.23	6.40	19.91	Vertical	Pass
Limit	ERP<3W=34.77dBm								

Radiated Power (EIRP) for LTE Band 13 / 10M									
Modulation	RB		Channel	Result					Conclusion
	Size	Offset		S G.Level (dBm)	Cable loss	Gain (dBi)	PMeas E.I.R.P.(dBm)	Polarization	
								Of Max. EIRP	
QPSK	1	0	Middle	16.74	1.22	6.40	21.92	Horizontal	Pass
	1	0	Middle	14.95	1.22	6.40	20.13	Vertical	Pass
16QAM	1	0	Middle	16.63	1.22	6.40	21.81	Horizontal	Pass
	1	0	Middle	14.8	1.22	6.40	19.98	Vertical	Pass
Limit	ERP<3W=34.77dBm								



LTE Band 17

Radiated Power (EIRP) for LTE Band 17 / 5M									
Modulation	RB		Channel	Result					Conclusion
	Size	Offset		S G.Level (dBm)	Cable loss	Gain (dBi)	PMeas E.I.R.P.(dBm)	Polarization	
								Of Max. EIRP	
QPSK	1	0	Lowest	14.38	1.21	6.40	19.57	Horizontal	Pass
	1	0	Middle	14.33	1.22	6.40	19.51	Vertical	Pass
	1	0	Highest	14.43	1.23	6.40	19.60	Horizontal	Pass
	1	0	Lowest	15.84	1.21	6.40	21.03	Vertical	Pass
	1	0	Middle	15.75	1.22	6.40	20.93	Horizontal	Pass
	1	0	Highest	15.81	1.23	6.40	20.98	Vertical	Pass
16QAM	1	0	Lowest	13.11	1.21	6.40	18.30	Horizontal	Pass
	1	0	Middle	13.07	1.22	6.40	18.25	Vertical	Pass
	1	0	Highest	12.99	1.23	6.40	18.16	Horizontal	Pass
	1	0	Lowest	14.48	1.21	6.40	19.67	Vertical	Pass
	1	0	Middle	14.56	1.22	6.40	19.74	Horizontal	Pass
	1	0	Highest	14.39	1.23	6.40	19.56	Vertical	Pass
Limit	ERP<3W=34.77dBm								

Radiated Power (EIRP) for LTE Band 17 / 10M									
Modulation	RB		Channel	Result					Conclusion
	Size	Offset		S G.Level (dBm)	Cable loss	Gain (dBi)	PMeas E.I.R.P.(dBm)	Polarization	
								Of Max. EIRP	
QPSK	1	0	Lowest	14.53	1.21	6.40	19.72	Horizontal	Pass
	1	0	Middle	14.3	1.22	6.40	19.48	Vertical	Pass
	1	0	Highest	14.57	1.23	6.40	19.74	Horizontal	Pass
	1	0	Lowest	15.84	1.21	6.40	21.03	Vertical	Pass
	1	0	Middle	15.69	1.22	6.40	20.87	Horizontal	Pass
	1	0	Highest	16	1.23	6.40	21.17	Vertical	Pass
16QAM	1	0	Lowest	13.17	1.21	6.40	18.36	Horizontal	Pass
	1	0	Middle	13.2	1.22	6.40	18.38	Vertical	Pass
	1	0	Highest	13.3	1.23	6.40	18.47	Horizontal	Pass
	1	0	Lowest	14.52	1.21	6.40	19.71	Vertical	Pass
	1	0	Middle	14.58	1.22	6.40	19.76	Horizontal	Pass
	1	0	Highest	14.73	1.23	6.40	19.90	Vertical	Pass
Limit	ERP<3W=34.77dBm								

6. OCCUPIED BANDWIDTH

6.1 DESCRIPTION OF OCCUPIED BANDWIDTH MEASUREMENT

6.1.1 MEASUREMENT METHOD

1.The occupied bandwidth is the width of a frequency band such that, below the lower and above the upper frequency limits, the mean powers emitted are each equal to a specified percentage 0.5% of the total mean transmitted power.

2.The 26 db emission bandwidth is defined as the frequency range between two points, one above and one below the carrier frequency, at which the spectral density of the emission is attenuated 26 db below the maximum in-band spectral density of the modulated signal. spectral density (power per unit bandwidth) is to be measured with a detector of resolution bandwidth equal to approximately 1.0% of the emission bandwidth.

6.1.2 TEST SETUP

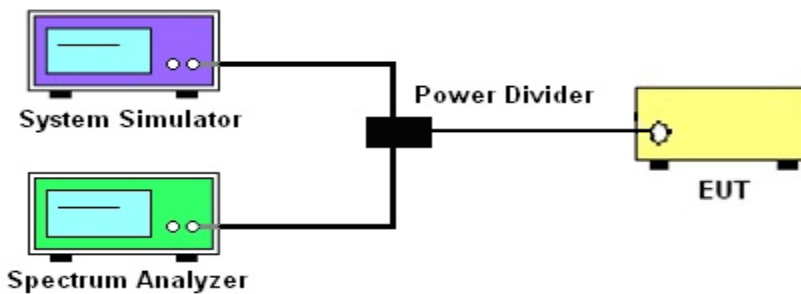

6.1.3 TEST PROCEDURES

1. The testing follows FCC KDB 971168 D01 v03r01 Section 4.1.and 4.2
2. The EUT was connected to spectrum and system simulator via a power divider
3. Select lowest, middle, and highest channels for each band and different modulation.
4. Set the test probe and measure the Occupied Bandwidth of the spectrum analyzer
5. Measure and record the Occupied Bandwidth from the Spectrum Analyzer.

	LTE					
LTE BW	1.4M	3M	5M	10M	15M	20M
Span	3MHz	6MHz	10MHz	20MHz	30MHz	40MHz
RBW	30kHz	30kHz	100kHz	100kHz	300kHz	300kHz
VBW	100kHz	100kHz	300kHz	300kHz	1000kHz	1000kHz
Detector	PK	PK	PK	PK	PK	PK
Trace	Max	Max	Max	Max	Max	Max
Sweep Count	Auto	Auto	Auto	Auto	Auto	Auto



6.1.4 MEASUREMENT RESULT

LTE BAND 2

LTE Band 2 Bandwidth [MHz]							
BW [MHz]	Mod	Lowest		Middle		Highest	
		26dB BW	99% BW	26dB BW	99% BW	26dB BW	99% BW
1.4	QPSK	1.320	1.0985	1.297	1.0962	1.325	1.0980
1.4	16-QAM	1.294	1.0903	1.300	1.0976	1.312	1.1023
3	QPSK	2.925	2.6835	2.929	2.6911	2.942	2.6825
3	16-QAM	2.945	2.6804	2.938	2.6827	2.924	2.6825
5	QPSK	5.006	4.5078	4.985	4.5080	5.015	4.5094
5	16-QAM	5.025	4.5116	5.008	4.5162	4.998	4.5073
10	QPSK	9.731	8.9334	9.684	8.9197	9.677	8.9161
10	16-QAM	9.646	8.9291	9.612	8.9205	9.607	8.9234
15	QPSK	14.72	13.466	14.72	13.444	14.64	13.423
15	16-QAM	14.69	13.459	14.67	13.443	14.75	13.450
20	QPSK	19.46	17.880	19.15	17.858	19.23	17.879
20	16-QAM	19.23	17.927	19.27	17.842	19.26	17.877

LTE BAND 4

LTE Band 4 Bandwidth [MHz]							
BW [MHz]	Mod	Lowest		Middle		Highest	
		26dB BW	99% BW	26dB BW	99% BW	26dB BW	99% BW
1.4	QPSK	1.313	1.0997	1.284	1.1036	1.326	1.0961
1.4	16-QAM	1.300	1.0959	1.310	1.0995	1.291	1.0935
3	QPSK	2.918	2.6830	2.922	2.6915	2.930	2.6857
3	16-QAM	2.941	2.6809	2.923	2.6821	2.907	2.6815
5	QPSK	4.997	4.5074	4.996	4.5200	4.997	4.5102
5	16-QAM	5.006	4.5140	5.025	4.5078	5.027	4.5222
10	QPSK	9.768	8.9359	9.606	8.9189	9.600	8.9318
10	16-QAM	9.641	8.9281	9.629	8.9265	9.628	8.9264
15	QPSK	14.78	13.439	14.77	13.442	14.67	13.407
15	16-QAM	14.68	13.459	14.71	13.439	14.78	13.452
20	QPSK	19.11	17.883	19.16	17.834	19.39	17.901
20	16-QAM	19.36	17.866	19.31	17.896	19.31	17.888



LTE BAND 5

LTE Band 5 Bandwidth [MHz]							
BW [MHz]	Mod	Lowest		Middle		Highest	
		26dB BW	99% BW	26dB BW	99% BW	26dB BW	99% BW
1.4	QPSK	1.298	1.0973	1.281	1.1058	1.291	1.0950
1.4	16-QAM	1.277	1.0928	1.275	1.0923	1.300	1.0982
3	QPSK	2.920	2.6795	2.924	2.6903	2.927	2.6814
3	16-QAM	2.926	2.6818	2.932	2.6781	2.929	2.6798
5	QPSK	4.973	4.5090	5.019	4.5114	4.996	4.4987
5	16-QAM	5.002	4.5191	5.016	4.5049	5.019	4.5055
10	QPSK	9.730	8.9308	9.663	8.9276	9.721	8.9208
10	16-QAM	9.629	8.9240	9.661	8.9323	9.692	8.9191

LTE BAND 12

LTE Band 12 Bandwidth [MHz]							
BW [MHz]	Mod	Lowest		Middle		Highest	
		26dB BW	99% BW	26dB BW	99% BW	26dB BW	99% BW
1.4	QPSK	1.277	1.1057	1.293	1.0935	1.308	1.0980
1.4	16-QAM	1.277	1.0935	1.302	1.0998	1.279	1.0937
3	QPSK	2.914	2.6857	2.926	2.6836	2.925	2.6894
3	16-QAM	2.928	2.6770	2.926	2.6806	2.923	2.6806
5	QPSK	4.987	4.4985	4.995	4.5186	5.001	4.5047
5	16-QAM	4.992	4.4980	5.029	4.5179	4.977	4.5075
10	QPSK	9.678	8.9248	9.770	8.9464	9.652	8.9074
10	16-QAM	9.588	8.9154	9.705	8.9374	9.653	8.9064

**LTE BAND 13**

LTE Band 13 Bandwidth [MHz]							
BW [MHz]	Mod	Lowest		Middle		Highest	
		26dB BW	99% BW	26dB BW	99% BW	26dB BW	99% BW
5	QPSK	4.987	4.5112	5.006	4.5111	5.008	4.5071
5	16-QAM	4.986	4.5044	5.033	4.5086	5.006	4.5157
10	QPSK	--	--	9.749	8.9364	--	--
10	16-QAM	--	--	9.618	8.9332	--	--

LTE BAND 17

LTE Band 17 Bandwidth [MHz]							
BW [MHz]	Mod	Lowest		Middle		Highest	
		26dB BW	99% BW	26dB BW	99% BW	26dB BW	99% BW
5	QPSK	4.966	4.5160	4.972	4.5165	5.006	4.5055
5	16-QAM	5.025	4.5152	5.003	4.5203	5.016	4.4994
10	QPSK	9.710	8.9374	9.714	8.9236	9.618	8.9003
10	16-QAM	9.683	8.9288	9.703	8.9208	9.636	8.9150

NOTE: Test chart See Appendix A



7. CONDUCTED BAND EDGE

7.1 DESCRIPTION OF CONDUCTED BAND EDGE MEASUREMENT

7.1.1 MEASUREMENT METHOD

1. §22.917(a)

For operations in the 824 – 849 MHz band, the FCC limit is $43 + 10\log_{10}(P[\text{Watts}])$ dB below the transmitter power $P(\text{Watts})$ in a 100kHz bandwidth. However, in the 1MHz bands immediately outside and adjacent to the licensee's frequency block, a resolution bandwidth of at least one percent of the emission bandwidth of the fundamental emission of the transmitter may be employed.

2. §24.238 (a)

For operations in the 1850-1910 and 1930-1990 MHz band, the FCC limit is $43 + 10\log_{10}(P[\text{Watts}])$ dB below the transmitter power $P(\text{Watts})$ in a 1MHz bandwidth. However, in the 1 MHz bands immediately outside and adjacent to the frequency block a resolution bandwidth of at least one percent of the emission bandwidth of the fundamental emission of the transmitter may be employed

3. §27.53 (h)

For operations in the 1710 – 1755 MHz band, the FCC limit is $43 + 10\log_{10}(P[\text{Watts}])$ dB below the transmitter power $P(\text{Watts})$ in a 1 MHz bandwidth. However, in the 1MHz bands immediately outside and adjacent to the licensee's frequency block, a resolution bandwidth of at least one percent of the emission bandwidth of the fundamental emission of the transmitter may be employed.

4. §27.53(m)(4)

For operations in the 2500 MHz ~ 2570 MHz band this section, the attenuation factor shall be not less than $40 + 10 \log (P)$ dB on all frequencies between the channel edge and 5 megahertz from the channel edge, $43 + 10 \log (P)$ dB on all frequencies between 5 megahertz and X megahertz from the channel edge, and $55 + 10 \log (P)$ dB on all frequencies more than X megahertz from the channel edge, where X is the greater of 6 megahertz or the actual emission bandwidth as defined in paragraph (m)(6) of this section. In addition, the attenuation factor shall not be less than $43 + 10 \log (P)$ dB on all frequencies between 2490.5 MHz and 2496 MHz and $55 + 10 \log (P)$ dB at or below 2490.5 MHz. Mobile Satellite Service licensees operating on frequencies below 2495 MHz may also submit a documented interference complaint against BRS licensees operating on channel BRS Channel 1 on the same terms and conditions as adjacent channel BRS or EBS licensees.

5. §27.53 (g)

For operations in the 698 -746 MHz band, the FCC limit is $43 + 10\log_{10}(P[\text{Watts}])$ dB below the transmitter power $P(\text{Watts})$ in a 100 kHz bandwidth. However, in the 100 kilohertz bands immediately outside and adjacent to a licensee's frequency block, a resolution bandwidth of at least 30 kHz may be employed.

7.1.2 TEST SETUP

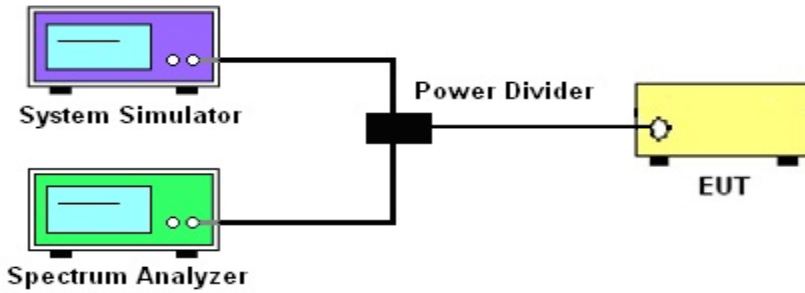

7.1.3 TEST PROCEDURES

1. The testing FCC KDB 971168 D01 v03r01 Section 6.0. and ANSI C63.26 2015 Section 5.7.
2. The EUT was connected to spectrum analyzer and system simulator via a power divider.
3. The band edges of low and high channels for the highest RF powers were measured. Set RBW \geq 1% EBW in the 1MHz band immediately outside and adjacent to the band edge.
4. Set spectrum analyzer with RMS/AVG detector
5. The RF fundamental frequency should be excluded against the limit line in the operating frequency band.
6. The limit line is derived from $43 + 10\log(P)$ dB below the transmitter power P(Watts)
 $= P(W) - [43 + 10\log(P)]$ (dB)
 $= [30 + 10\log(P)]$ (dBm) - $[43 + 10\log(P)]$ (dB)
 $= -13$ dBm.

Band 7:
 $= P(W) - [55 + 10\log(P)]$ (dB)
 $= [30 + 10\log(P)]$ (dBm) - $[55 + 10\log(P)]$ (dB)
 $= -25$ dBm.

	LTE					
LTE BW	1.4M	3M	5M	10M	15M	20M
Span	12MHz	13MHz	15MHz	20MHz	25MHz	30MHz
RBW	30kHz	30kHz	100kHz	100kHz	300kHz	300kHz
VBW	100kHz	100kHz	300kHz	300kHz	1000kHz	1000kHz
Detector	RMS	RMS	RMS	RMS	RMS	RMS
Trace	Max	Max	Max	Max	Max	Max
Sweep Count	Auto	Auto	Auto	Auto	Auto	Auto

7.1.4 MEASUREMENT RESULT

NOTE: Test chart See Appendix B

8. CONDUCTED SPURIOUS EMISSION

8.1 DESCRIPTION OF CONDUCTED SPURIOUS EMISSION MEASUREMENT

8.1.1 MEASUREMENT METHOD

The power of any emission outside of the authorized operating frequency ranges must be lower than the transmitter power (P) by a factor of at least 43 + 10 log (P) dB.

For Band 7:

The power of any emission outside of the authorized operating frequency ranges must be lower than the transmitter power (P) by a factor of at least 55 + 10 log (P) dB.

It is measured by means of a calibrated spectrum analyzer and scanned from 30 MHz up to a frequency including its 10th harmonic.

8.1.2 TEST SETUP

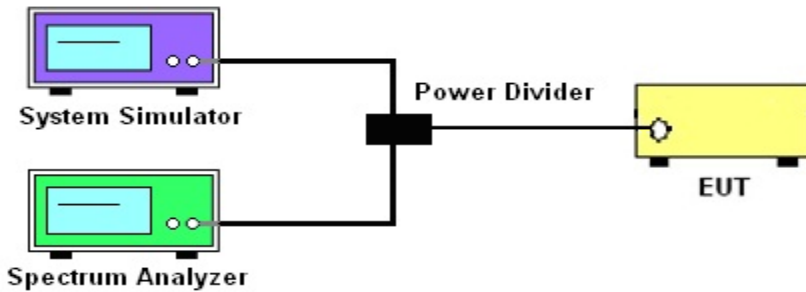

8.1.3 TEST PROCEDURES

1. The testing FCC KDB 971168 D01 v03r01 Section 6.0. and ANSI C63.26 2015 Section 5.7.
2. The EUT was connected to spectrum analyzer and system simulator via a power divider.
3. The RF output of EUT was connected to the spectrum analyzer by RF cable and attenuator. The path loss was compensated to the results for each measurement
4. Make the measurement with the spectrum analyzer's RBW = 1MHz, VBW = 3MHz, taking the record of maximum spurious emission.
5. The RF fundamental frequency should be excluded against the limit line in the operating frequency band.
6. The limit line is derived from $43 + 10\log(P)$ dB below the transmitter power P(Watts)
 $= P(W) - [43 + 10\log(P)] \text{ (dB)} = [30 + 10\log(P)] \text{ (dBm)} - [43 + 10\log(P)] \text{ (dB)}$
 $= -13\text{dBm}$.
 For Band 7: $P(W) - [43 + 10\log(P)] \text{ (dB)} = -25\text{dBm}$

	LTE					
LTE BW	1.4M	3M	5M	10M	15M	20M
Span	Auto	Auto	Auto	Auto	Auto	Auto
RBW	1000kHz	1000kHz	1000kHz	1000kHz	1000kHz	1000kHz
VBW	3000kHz	3000kHz	3000kHz	3000kHz	3000kHz	3000kHz
Detector	PK	PK	PK	PK	PK	PK
Trace	Max	Max	Max	Max	Max	Max

8.1.4 TEST RESULTS

NOTE: Test chart See Appendix C

9. RADIATED SPURIOUS EMISSION

9.1 DESCRIPTION OF RADIATED SPURIOUS EMISSION

9.1.1 MEASUREMENT METHOD

The radiated spurious emission was measured by substitution method according to ANSI / TIA / EIA-603-D-2010. The power of any emission outside of the authorized operating frequency ranges must be attenuated below the transmitter power (P) by a factor of at least $43 + 10 \log (P)$ dB. For Band 7 The power of any emission outside of the authorized operating frequency ranges must be attenuated below the transmitter power (P) by a factor of at least $55 + 10 \log (P)$ dB. For Band. The spectrum is scanned from 30 MHz up to a frequency including its 10th harmonic.

5.1.2 Test Setup

The procedure of radiated spurious emissions is as follows:

a) Pre-calibration With pre-calibration method, the Radiated Spurious Emissions(RSE) is calculated as, $RSE = R_x \text{ (dBuV)} + CL \text{ (dB)} + SA \text{ (dB)} + Gain \text{ (dBi)} - 107 \text{ (dBuV to dBm)}$ The SA is calibrated using following setup.

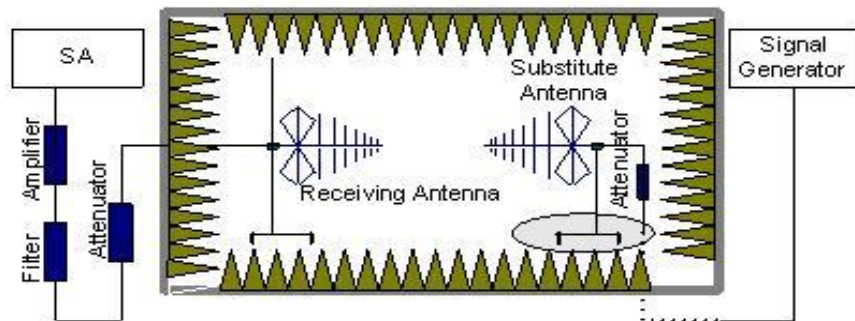

b) EUT was placed on a 1.5 meter high non-conductive stand at a 3 meter test distance from the receive antenna. A receiving antenna was placed on the antenna mast 3 meters from the test item for emission measurements. The height of receiving antenna is 0.8m. The test setup refers to figure below. Detected emissions were maximized at each frequency by rotating the test item and adjusting the receiving antenna polarization. The radiated emission measurements of all non-harmonic and harmonics of the transmit frequency through the 10th harmonic were measured with peak detector and 1MHz bandwidth.

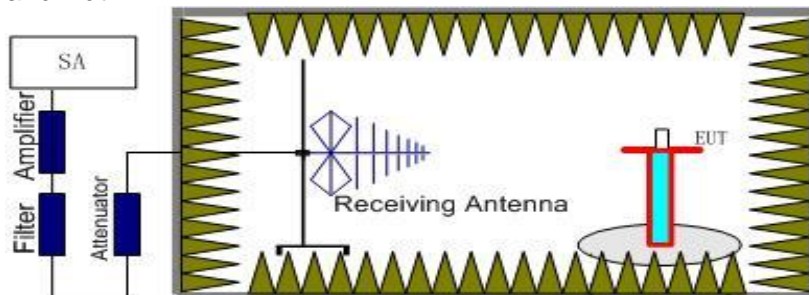

Radiated emissions measurements were made only at the upper, middle, and lower carrier frequencies. It was decided that measurements at these three carrier frequencies would be sufficient to demonstrate compliance with emissions limits because it was seen that all the significant spurs occur well outside the band and no radiation was seen from a carrier in one block of any band into any of the other blocks.

The substitution method is used. Substitution values at each frequency are measured before and saved to the test software. A "reference path loss" is established and the ARpl is the attenuation of "reference path loss", and including the gain of receive antenna, the gain of the preamplifier, the cable loss and the air loss. The measurement results are obtained as described below: $Power = P_{Mea} + AR_{pl}$



9.1.3 TEST PROCEDURES

1. The testing FCC KDB 971168 D01 Section 5.8 and ANSI C63.26 2015 Section 5.5.
2. The EUT was placed on a rotatable wooden table with 0.8 meter above ground.
3. The EUT was set 3 meters from the receiving antenna, which was mounted on the antenna tower.
4. The table was rotated 360 degrees to determine the position of the highest spurious emission.
5. The height of the receiving antenna is varied between one meter and four meters to search the maximum spurious emission for both horizontal and vertical polarizations
6. Make the measurement with the spectrum analyzer's RBW = 1MHz, VBW = 3MHz, taking the record of maximum spurious emission.
7. A horn antenna was substituted in place of the EUT and was driven by a signal generator.
8. Tune the output power of signal generator to the same emission level with EUT maximum spurious emission.
9. Taking the record of output power at antenna port.
10. Repeat step 7 to step 8 for another polarization.
11. The RF fundamental frequency should be excluded against the limit line in the operating frequency band.

The limit line is derived from $43 + 10\log(P)$ dB below the transmitter power P(Watts)
 $= P(W) - [43 + 10\log(P)]$ (dB)
 $= [30 + 10\log(P)]$ (dBm) - $[43 + 10\log(P)]$ (dB)
 $= -13$ dBm

For Band 7:

The limit line is derived from $55 + 10\log(P)$ dB below the transmitter power P(Watts)
 $= [30 + 10\log(P)]$ (dBm) - $[55 + 10\log(P)]$ (dB)
 $= -25$ dBm

EIRP (dBm) = S.G. Power - Tx Cable Loss + Tx Antenna Gain

ERP (dBm) = EIRP - 2.15



9.1.4 TEST RESULTS

LTE BAND 2

LTE Band 2 / 1.4MHz / QPSK / RB Size 1 Offset 0/ The Worst Test Results for Lowest							
Frequency(MHz)	S G.Lev (dBm)	Ant(dBi)	Loss	PMea	Limit	Margin	Polarity
				(dBm)	(dBm)	(dB)	
3701.27	-34.81	12.60	12.93	-35.14	-13.00	-22.14	H
5551.75	-35.40	13.10	17.11	-39.41	-13.00	-26.41	H
7402.61	-33.34	11.50	22.20	-44.04	-13.00	-31.04	H
3701.27	-35.70	12.60	12.93	-36.03	-13.00	-23.03	V
5551.75	-34.67	13.10	17.11	-38.68	-13.00	-25.68	V
7402.61	-32.11	11.50	22.20	-42.81	-13.00	-29.81	V
LTE Band 2 / 1.4MHz / QPSK / RB Size 1 Offset 0/ The Worst Test Results for Middle							
Frequency(MHz)	S G.Lev (dBm)	Ant(dBi)	Loss	PMea	Limit	Margin	Polarity
				(dBm)	(dBm)	(dB)	
3760.17	-34.34	12.60	12.93	-34.67	-13.00	-21.67	H
5640.08	-35.07	13.10	17.11	-39.08	-13.00	-26.08	H
7520.11	-33.19	11.50	22.20	-43.89	-13.00	-30.89	H
3760.17	-35.27	12.60	12.93	-35.60	-13.00	-22.60	V
5640.08	-34.88	13.10	17.11	-38.89	-13.00	-25.89	V
7520.11	-33.11	11.50	22.20	-43.81	-13.00	-30.81	V
LTE Band 2 / 1.4MHz / QPSK / RB Size 1 Offset 0/ The Worst Test Results for Highest							
Frequency(MHz)	S G.Lev (dBm)	Ant(dBi)	Loss	PMea	Limit	Margin	Polarity
				(dBm)	(dBm)	(dB)	
3818.45	-34.71	12.60	12.93	-35.04	-13.00	-22.04	H
5727.65	-35.10	13.10	17.11	-39.11	-13.00	-26.11	H
7637.07	-33.00	11.50	22.20	-43.70	-13.00	-30.70	H
3818.45	-34.54	12.60	12.93	-34.87	-13.00	-21.87	V
5727.65	-35.11	13.10	17.11	-39.12	-13.00	-26.12	V
7637.07	-32.39	11.50	22.20	-43.09	-13.00	-30.09	V

Remark: Spurious emissions within 30-1000MHz were found more than 20dB below limit line..

Test is divided into three directions, X/Y/Z. X pattern for the worst.



LTE BAND 2

LTE Band 2 / 3MHz / QPSK / RB Size 1 Offset 0/ The Worst Test Results for Lowest							
Frequency(MHz)	S G.Lev (dBm)	Ant(dBi)	Loss	PMea	Limit	Margin	Polarity
				(dBm)	(dBm)	(dB)	
3703.09	-34.45	12.60	12.93	-34.78	-13.00	-21.78	H
5554.48	-34.73	13.10	17.11	-38.74	-13.00	-25.74	H
7406.49	-33.30	11.50	22.20	-44.00	-13.00	-31.00	H
3703.09	-34.85	12.60	12.93	-35.18	-13.00	-22.18	V
5554.48	-35.22	13.10	17.11	-39.23	-13.00	-26.23	V
7406.49	-31.96	11.50	22.20	-42.66	-13.00	-29.66	V
LTE Band 2 / 3MHz / QPSK / RB Size 1 Offset 0/ The Worst Test Results for Middle							
Frequency(MHz)	S G.Lev (dBm)	Ant(dBi)	Loss	PMea	Limit	Margin	Polarity
				(dBm)	(dBm)	(dB)	
3760.14	-34.12	12.60	12.93	-34.45	-13.00	-21.45	H
5639.84	-34.44	13.10	17.11	-38.45	-13.00	-25.45	H
7520.25	-33.50	11.50	22.20	-44.20	-13.00	-31.20	H
3760.14	-34.55	12.60	12.93	-34.88	-13.00	-21.88	V
5639.84	-34.57	13.10	17.11	-38.58	-13.00	-25.58	V
7520.25	-31.89	11.50	22.20	-42.59	-13.00	-29.59	V
LTE Band 2 / 3MHz / QPSK / RB Size 1 Offset 0/ The Worst Test Results for Highest							
Frequency(MHz)	S G.Lev (dBm)	Ant(dBi)	Loss	PMea	Limit	Margin	Polarity
				(dBm)	(dBm)	(dB)	
3816.77	-33.73	12.60	12.93	-34.06	-13.00	-21.06	H
5724.94	-34.88	13.10	17.11	-38.89	-13.00	-25.89	H
7633.54	-33.06	11.50	22.20	-43.76	-13.00	-30.76	H
3816.77	-35.97	12.60	12.93	-36.30	-13.00	-23.30	V
5724.94	-34.25	13.10	17.11	-38.26	-13.00	-25.26	V
7633.54	-32.29	11.50	22.20	-42.99	-13.00	-29.99	V

Remark: Spurious emissions within 30-1000MHz were found more than 20dB below limit line.

Test is divided into three directions, X/Y/Z. X pattern for the worst.



LTE BAND 2

LTE Band 2 / 5MHz / QPSK / RB Size 1 Offset 0/ The Worst Test Results for Lowest							
Frequency(MHz)	S G.Lev (dBm)	Ant(dBi)	Loss	PMea	Limit	Margin	Polarity
				(dBm)	(dBm)	(dB)	
3705.01	-34.45	12.60	12.93	-34.78	-13.00	-21.78	H
5557.74	-35.08	13.10	17.11	-39.09	-13.00	-26.09	H
7410.40	-32.25	11.50	22.20	-42.95	-13.00	-29.95	H
3705.01	-35.18	12.60	12.93	-35.51	-13.00	-22.51	V
5557.74	-34.22	13.10	17.11	-38.23	-13.00	-25.23	V
7410.40	-33.10	11.50	22.20	-43.80	-13.00	-30.80	V
LTE Band 2 / 5MHz / QPSK / RB Size 1 Offset 0/ The Worst Test Results for Middle							
Frequency(MHz)	S G.Lev (dBm)	Ant(dBi)	Loss	PMea	Limit	Margin	Polarity
				(dBm)	(dBm)	(dB)	
3759.79	-34.45	12.60	12.93	-34.78	-13.00	-21.78	H
5639.90	-34.71	13.10	17.11	-38.72	-13.00	-25.72	H
7520.28	-32.26	11.50	22.20	-42.96	-13.00	-29.96	H
3759.79	-34.76	12.60	12.93	-35.09	-13.00	-22.09	V
5639.90	-34.84	13.10	17.11	-38.85	-13.00	-25.85	V
7520.28	-32.98	11.50	22.20	-43.68	-13.00	-30.68	V
LTE Band 2 / 5MHz / QPSK / RB Size 1 Offset 0/ The Worst Test Results for Highest							
Frequency(MHz)	S G.Lev (dBm)	Ant(dBi)	Loss	PMea	Limit	Margin	Polarity
				(dBm)	(dBm)	(dB)	
3813.99	-34.42	12.60	12.93	-34.75	-13.00	-21.75	H
5721.38	-34.99	13.10	17.11	-39.00	-13.00	-26.00	H
7628.65	-33.22	11.50	22.20	-43.92	-13.00	-30.92	H
3813.99	-34.88	12.60	12.93	-35.21	-13.00	-22.21	V
5721.38	-34.24	13.10	17.11	-38.25	-13.00	-25.25	V
7628.65	-32.46	11.50	22.20	-43.16	-13.00	-30.16	V

Remark: Spurious emissions within 30-1000MHz were found more than 20dB below limit line.
 Test is divided into three directions, X/Y/Z. X pattern for the worst.



LTE BAND 2

LTE Band 2 / 10MHz / QPSK / RB Size 1 Offset 0/ The Worst Test Results for Lowest							
Frequency(MHz)	S G.Lev (dBm)	Ant(dBi)	Loss	PMea	Limit	Margin	Polarity
				(dBm)	(dBm)	(dB)	
3710.30	-33.92	12.60	12.93	-34.25	-13.00	-21.25	H
5565.79	-34.36	13.10	17.11	-38.37	-13.00	-25.37	H
7420.89	-33.50	11.50	22.20	-44.20	-13.00	-31.20	H
3710.30	-35.32	12.60	12.93	-35.65	-13.00	-22.65	V
5565.79	-33.84	13.10	17.11	-37.85	-13.00	-24.85	V
7420.89	-32.25	11.50	22.20	-42.95	-13.00	-29.95	V
LTE Band 2 / 10MHz / QPSK / RB Size 1 Offset 0/ The Worst Test Results for Middle							
Frequency(MHz)	S G.Lev (dBm)	Ant(dBi)	Loss	PMea	Limit	Margin	Polarity
				(dBm)	(dBm)	(dB)	
3759.78	-33.58	12.60	12.93	-33.91	-13.00	-20.91	H
5640.11	-35.40	13.10	17.11	-39.41	-13.00	-26.41	H
7520.27	-32.43	11.50	22.20	-43.13	-13.00	-30.13	H
3759.78	-35.52	12.60	12.93	-35.85	-13.00	-22.85	V
5640.11	-33.81	13.10	17.11	-37.82	-13.00	-24.82	V
7520.27	-32.32	11.50	22.20	-43.02	-13.00	-30.02	V
LTE Band 2 / 10MHz / QPSK / RB Size 1 Offset 0/ The Worst Test Results for Highest							
Frequency(MHz)	S G.Lev (dBm)	Ant(dBi)	Loss	PMea	Limit	Margin	Polarity
				(dBm)	(dBm)	(dB)	
3809.08	-34.88	12.60	12.93	-35.21	-13.00	-22.21	H
5713.82	-35.07	13.10	17.11	-39.08	-13.00	-26.08	H
7618.19	-32.81	11.50	22.20	-43.51	-13.00	-30.51	H
3809.08	-35.74	12.60	12.93	-36.07	-13.00	-23.07	V
5713.82	-34.84	13.10	17.11	-38.85	-13.00	-25.85	V
7618.19	-32.60	11.50	22.20	-43.30	-13.00	-30.30	V

Remark: Spurious emissions within 30-1000MHz were found more than 20dB below limit line.
 Test is divided into three directions, X/Y/Z. X pattern for the worst.



LTE BAND 2

LTE Band 2 / 15MHz / QPSK / RB Size 1 Offset 0/ The Worst Test Results for Lowest							
Frequency(MHz)	S G.Lev (dBm)	Ant(dBi)	Loss	PMea	Limit	Margin	Polarity
				(dBm)	(dBm)	(dB)	
3716.03	-33.55	12.60	12.93	-33.88	-13.00	-20.88	H
5573.90	-34.44	13.10	17.11	-38.45	-13.00	-25.45	H
7618.84	-32.85	11.50	22.20	-43.55	-13.00	-30.55	H
3716.03	-35.81	12.60	12.93	-36.14	-13.00	-23.14	V
5573.90	-34.90	13.10	17.11	-38.91	-13.00	-25.91	V
7618.84	-31.78	11.50	22.20	-42.48	-13.00	-29.48	V
LTE Band 2 / 15MHz / QPSK / RB Size 1 Offset 0/ The Worst Test Results for Middle							
Frequency(MHz)	S G.Lev (dBm)	Ant(dBi)	Loss	PMea	Limit	Margin	Polarity
				(dBm)	(dBm)	(dB)	
3759.88	-34.28	12.60	12.93	-34.61	-13.00	-21.61	H
5640.27	-35.22	13.10	17.11	-39.23	-13.00	-26.23	H
7520.26	-32.54	11.50	22.20	-43.24	-13.00	-30.24	H
3759.88	-35.25	12.60	12.93	-35.58	-13.00	-22.58	V
5640.27	-35.06	13.10	17.11	-39.07	-13.00	-26.07	V
7520.26	-33.17	11.50	22.20	-43.87	-13.00	-30.87	V
LTE Band 2 / 15MHz / QPSK / RB Size 1 Offset 0/ The Worst Test Results for Highest							
Frequency(MHz)	S G.Lev (dBm)	Ant(dBi)	Loss	PMea	Limit	Margin	Polarity
				(dBm)	(dBm)	(dB)	
3803.68	-34.70	12.60	12.93	-35.03	-13.00	-22.03	H
5705.36	-34.09	13.10	17.11	-38.10	-13.00	-25.10	H
7607.28	-33.12	11.50	22.20	-43.82	-13.00	-30.82	H
3803.68	-35.92	12.60	12.93	-36.25	-13.00	-23.25	V
5705.36	-34.50	13.10	17.11	-38.51	-13.00	-25.51	V
7607.28	-32.49	11.50	22.20	-43.19	-13.00	-30.19	V

Remark: Spurious emissions within 30-1000MHz were found more than 20dB below limit line.

Test is divided into three directions, X/Y/Z. X pattern for the worst.



LTE BAND 2

LTE Band 2 / 20MHz / QPSK / RB Size 1 Offset 0/ The Worst Test Results for Lowest							
Frequency(MHz)	S G.Lev (dBm)	Ant(dBi)	Loss	PMea	Limit	Margin	Polarity
				(dBm)	(dBm)	(dB)	
3721.32	-33.58	12.60	12.93	-33.91	-13.00	-20.91	H
5581.35	-34.11	13.10	17.11	-38.12	-13.00	-25.12	H
7441.84	-32.32	11.50	22.20	-43.02	-13.00	-30.02	H
3721.32	-35.93	12.60	12.93	-36.26	-13.00	-23.26	V
5581.35	-34.12	13.10	17.11	-38.13	-13.00	-25.13	V
7441.84	-31.76	11.50	22.20	-42.46	-13.00	-29.46	V
LTE Band 2 / 20MHz / QPSK / RB Size 1 Offset 0/ The Worst Test Results for Middle							
Frequency(MHz)	S G.Lev (dBm)	Ant(dBi)	Loss	PMea	Limit	Margin	Polarity
				(dBm)	(dBm)	(dB)	
3760.02	-34.89	12.60	12.93	-35.22	-13.00	-22.22	H
5640.09	-34.60	13.10	17.11	-38.61	-13.00	-25.61	H
7519.95	-32.81	11.50	22.20	-43.51	-13.00	-30.51	H
3760.02	-35.28	12.60	12.93	-35.61	-13.00	-22.61	V
5640.09	-34.16	13.10	17.11	-38.17	-13.00	-25.17	V
7519.95	-32.14	11.50	22.20	-42.84	-13.00	-29.84	V
LTE Band 2 / 20MHz / QPSK / RB Size 1 Offset 0/ The Worst Test Results for Highest							
Frequency(MHz)	S G.Lev (dBm)	Ant(dBi)	Loss	PMea	Limit	Margin	Polarity
				(dBm)	(dBm)	(dB)	
3798.28	-33.76	12.60	12.93	-34.09	-13.00	-21.09	H
5697.25	-35.33	13.10	17.11	-39.34	-13.00	-26.34	H
7596.78	-32.89	11.50	22.20	-43.59	-13.00	-30.59	H
3798.28	-34.80	12.60	12.93	-35.13	-13.00	-22.13	V
5697.25	-34.30	13.10	17.11	-38.31	-13.00	-25.31	V
7596.78	-32.14	11.50	22.20	-42.84	-13.00	-29.84	V

Remark: Spurious emissions within 30-1000MHz were found more than 20dB below limit line.

Test is divided into three directions, X/Y/Z. X pattern for the worst.



LTE BAND 4

LTE Band 4 / 1.4MHz / QPSK / RB Size 1 Offset 0/ The Worst Test Results for Lowest							
Frequency(MHz)	S G.Lev (dBm)	Ant(dBi)	Loss	PMea	Limit	Margin	Polarity
				(dBm)	(dBm)	(dB)	
3422.01	-34.81	12.90	12.56	-34.47	-13.00	-21.47	H
5133.46	-34.51	13.10	12.46	-33.87	-13.00	-20.87	H
6844.85	-32.36	12.33	21.13	-41.16	-13.00	-28.16	H
3422.01	-35.08	12.90	12.76	-34.94	-13.00	-21.94	V
5133.46	-33.75	13.10	16.32	-36.97	-13.00	-23.97	V
6844.85	-32.41	12.33	21.13	-41.21	-13.00	-28.21	V
LTE Band 4 / 1.4MHz / QPSK / RB Size 1 Offset 0/ The Worst Test Results for Middle							
Frequency(MHz)	S G.Lev (dBm)	Ant(dBi)	Loss	PMea	Limit	Margin	Polarity
				(dBm)	(dBm)	(dB)	
3465.99	-33.63	12.80	12.56	-33.39	-13.00	-20.39	H
5198.98	-34.69	13.10	12.46	-34.05	-13.00	-21.05	H
6932.13	-32.74	12.33	21.13	-41.54	-13.00	-28.54	H
3465.99	-35.66	12.80	12.76	-35.62	-13.00	-22.62	V
5198.98	-34.53	13.10	16.32	-37.75	-13.00	-24.75	V
6932.13	-31.78	12.33	21.13	-40.58	-13.00	-27.58	V
LTE Band 4 / 1.4MHz / QPSK / RB Size 1 Offset 0/ The Worst Test Results for Highest							
Frequency(MHz)	S G.Lev (dBm)	Ant(dBi)	Loss	PMea	Limit	Margin	Polarity
				(dBm)	(dBm)	(dB)	
3508.44	-33.70	12.61	12.56	-33.65	-13.00	-20.65	H
5262.28	-35.39	13.12	12.46	-34.73	-13.00	-21.73	H
7016.03	-32.62	12.32	21.13	-41.43	-13.00	-28.43	H
3508.44	-35.57	12.61	12.76	-35.72	-13.00	-22.72	V
5262.28	-35.15	13.12	16.32	-38.35	-13.00	-25.35	V
7016.03	-32.92	12.32	21.13	-41.73	-13.00	-28.73	V

Remark: Spurious emissions within 30-1000MHz were found more than 20dB below limit line.

Test is divided into three directions, X/Y/Z. X pattern for the worst.



LTE BAND 4

LTE Band 4 / 3MHz / QPSK / RB Size 1 Offset 0/ The Worst Test Results for Lowest							
Frequency(MHz)	S G.Lev (dBm)	Ant(dBi)	Loss	PMea	Limit	Margin	Polarity
				(dBm)	(dBm)	(dB)	
3424.35	-34.75	12.90	12.56	-34.41	-13.00	-21.41	H
5136.41	-35.25	13.10	12.46	-34.61	-13.00	-21.61	H
6848.50	-33.07	12.33	21.13	-41.87	-13.00	-28.87	H
3424.35	-34.72	12.90	12.76	-34.58	-13.00	-21.58	V
5136.41	-34.68	13.10	16.32	-37.90	-13.00	-24.90	V
6848.50	-31.92	12.33	21.13	-40.72	-13.00	-27.72	V
LTE Band 4 / 3MHz / QPSK / RB Size 1 Offset 0/ The Worst Test Results for Middle							
Frequency(MHz)	S G.Lev (dBm)	Ant(dBi)	Loss	PMea	Limit	Margin	Polarity
				(dBm)	(dBm)	(dB)	
3466.06	-34.59	12.80	12.56	-34.35	-13.00	-21.35	H
5199.13	-35.01	13.10	12.46	-34.37	-13.00	-21.37	H
6931.87	-32.29	12.33	21.13	-41.09	-13.00	-28.09	H
3466.06	-34.60	12.80	12.76	-34.56	-13.00	-21.56	V
5199.13	-35.17	13.10	16.32	-38.39	-13.00	-25.39	V
6931.87	-31.71	12.33	21.13	-40.51	-13.00	-27.51	V
LTE Band 4 / 3MHz / QPSK / RB Size 1 Offset 0/ The Worst Test Results for Highest							
Frequency(MHz)	S G.Lev (dBm)	Ant(dBi)	Loss	PMea	Limit	Margin	Polarity
				(dBm)	(dBm)	(dB)	
3506.50	-34.73	12.61	12.56	-34.68	-13.00	-21.68	H
5262.40	-35.47	13.12	12.46	-34.81	-13.00	-21.81	H
7012.98	-32.44	12.32	21.13	-41.25	-13.00	-28.25	H
3506.50	-35.91	12.61	12.76	-36.06	-13.00	-23.06	V
5262.40	-35.01	13.12	16.32	-38.21	-13.00	-25.21	V
7012.98	-32.92	12.32	21.13	-41.73	-13.00	-28.73	V

Remark: Spurious emissions within 30-1000MHz were found more than 20dB below limit line.
 Test is divided into three directions, X/Y/Z. X pattern for the worst.



LTE BAND 4

LTE Band 4 / 5MHz / QPSK / RB Size 1 Offset 0/ The Worst Test Results for Lowest							
Frequency(MHz)	S G.Lev (dBm)	Ant(dBi)	Loss	PMea	Limit	Margin	Polarity
				(dBm)	(dBm)	(dB)	
3426.32	-34.18	12.90	12.56	-33.84	-13.00	-20.84	H
5139.22	-34.13	13.10	12.46	-33.49	-13.00	-20.49	H
6852.74	-32.51	12.33	21.13	-41.31	-13.00	-28.31	H
3426.32	-35.93	12.90	12.76	-35.79	-13.00	-22.79	V
5139.22	-34.94	13.10	16.32	-38.16	-13.00	-25.16	V
6852.74	-33.11	12.33	21.13	-41.91	-13.00	-28.91	V
LTE Band 4 / 5MHz / QPSK / RB Size 1 Offset 0/ The Worst Test Results for Middle							
Frequency(MHz)	S G.Lev (dBm)	Ant(dBi)	Loss	PMea	Limit	Margin	Polarity
				(dBm)	(dBm)	(dB)	
3466.02	-33.72	12.80	12.56	-33.48	-13.00	-20.48	H
5199.01	-34.83	13.10	12.46	-34.19	-13.00	-21.19	H
6931.80	-33.04	12.33	21.13	-41.84	-13.00	-28.84	H
3466.02	-35.23	12.80	12.76	-35.19	-13.00	-22.19	V
5199.01	-34.89	13.10	16.32	-38.11	-13.00	-25.11	V
6931.80	-33.17	12.33	21.13	-41.97	-13.00	-28.97	V
LTE Band 4 / 5MHz / QPSK / RB Size 1 Offset 0/ The Worst Test Results for Highest							
Frequency(MHz)	S G.Lev (dBm)	Ant(dBi)	Loss	PMea	Limit	Margin	Polarity
				(dBm)	(dBm)	(dB)	
3506.50	-33.65	12.61	12.56	-33.60	-13.00	-20.60	H
5262.37	-35.48	13.12	12.46	-34.82	-13.00	-21.82	H
7013.03	-32.54	12.32	21.13	-41.35	-13.00	-28.35	H
3506.50	-34.75	12.61	12.76	-34.90	-13.00	-21.90	V
5262.37	-33.76	13.12	16.32	-36.96	-13.00	-23.96	V
7013.03	-31.74	12.32	21.13	-40.55	-13.00	-27.55	V

Remark: Spurious emissions within 30-1000MHz were found more than 20dB below limit line.

Test is divided into three directions, X/Y/Z. X pattern for the worst.



LTE BAND 4

LTE Band 4 / 10MHz / QPSK / RB Size 1 Offset 0/ The Worst Test Results for Lowest							
Frequency(MHz)	S G.Lev (dBm)	Ant(dBi)	Loss	PMea	Limit	Margin	Polarity
				(dBm)	(dBm)	(dB)	
3436.15	-34.38	12.90	12.56	-34.04	-13.00	-21.04	H
5154.50	-35.17	13.10	12.46	-34.53	-13.00	-21.53	H
6872.63	-33.15	12.33	21.13	-41.95	-13.00	-28.95	H
3436.15	-34.97	12.90	12.76	-34.83	-13.00	-21.83	V
5154.50	-33.91	13.10	16.32	-37.13	-13.00	-24.13	V
6872.63	-31.72	12.33	21.13	-40.52	-13.00	-27.52	V
LTE Band 4 / 10MHz / QPSK / RB Size 1 Offset 0/ The Worst Test Results for Middle							
Frequency(MHz)	S G.Lev (dBm)	Ant(dBi)	Loss	PMea	Limit	Margin	Polarity
				(dBm)	(dBm)	(dB)	
3465.89	-34.90	12.80	12.56	-34.66	-13.00	-21.66	H
5199.06	-34.66	13.10	12.46	-34.02	-13.00	-21.02	H
6932.29	-32.69	12.33	21.13	-41.49	-13.00	-28.49	H
3465.89	-35.32	12.80	12.76	-35.28	-13.00	-22.28	V
5199.06	-34.91	13.10	16.32	-38.13	-13.00	-25.13	V
6932.29	-32.14	12.33	21.13	-40.94	-13.00	-27.94	V
LTE Band 4 / 10MHz / QPSK / RB Size 1 Offset 0/ The Worst Test Results for Highest							
Frequency(MHz)	S G.Lev (dBm)	Ant(dBi)	Loss	PMea	Limit	Margin	Polarity
				(dBm)	(dBm)	(dB)	
3494.69	-34.34	12.61	12.56	-34.29	-13.00	-21.29	H
5241.35	-35.19	13.12	12.46	-34.53	-13.00	-21.53	H
6988.11	-32.85	12.32	21.13	-41.66	-13.00	-28.66	H
3494.69	-34.77	12.61	12.76	-34.92	-13.00	-21.92	V
5241.35	-34.95	13.12	16.32	-38.15	-13.00	-25.15	V
6988.11	-32.94	12.32	21.13	-41.75	-13.00	-28.75	V

Remark: Spurious emissions within 30-1000MHz were found more than 20dB below limit line.

Test is divided into three directions, X/Y/Z. X pattern for the worst.



LTE BAND 4

LTE Band 4 / 15MHz / QPSK / RB Size 1 Offset 0/ The Worst Test Results for Lowest							
Frequency(MHz)	S G.Lev (dBm)	Ant(dBi)	Loss	PMea	Limit	Margin	Polarity
				(dBm)	(dBm)	(dB)	
3436.24	-33.66	12.90	12.56	-33.32	-13.00	-20.32	H
5154.52	-34.68	13.10	12.46	-34.04	-13.00	-21.04	H
6872.74	-33.19	12.33	21.13	-41.99	-13.00	-28.99	H
3436.24	-35.00	12.90	12.76	-34.86	-13.00	-21.86	V
5154.52	-34.91	13.10	16.32	-38.13	-13.00	-25.13	V
6872.74	-32.13	12.33	21.13	-40.93	-13.00	-27.93	V
LTE Band 4 / 15MHz / QPSK / RB Size 1 Offset 0/ The Worst Test Results for Middle							
Frequency(MHz)	S G.Lev (dBm)	Ant(dBi)	Loss	PMea	Limit	Margin	Polarity
				(dBm)	(dBm)	(dB)	
3465.87	-34.55	12.80	12.56	-34.31	-13.00	-21.31	H
5198.90	-35.42	13.10	12.46	-34.78	-13.00	-21.78	H
6932.13	-32.71	12.33	21.13	-41.51	-13.00	-28.51	H
3465.87	-35.60	12.80	12.76	-35.56	-13.00	-22.56	V
5198.90	-34.31	13.10	16.32	-37.53	-13.00	-24.53	V
6932.13	-32.12	12.33	21.13	-40.92	-13.00	-27.92	V
LTE Band 4 / 15MHz / QPSK / RB Size 1 Offset 0/ The Worst Test Results for Highest							
Frequency(MHz)	S G.Lev (dBm)	Ant(dBi)	Loss	PMea	Limit	Margin	Polarity
				(dBm)	(dBm)	(dB)	
3494.36	-34.68	12.61	12.56	-34.63	-13.00	-21.63	H
5242.08	-35.07	13.12	12.46	-34.41	-13.00	-21.41	H
6989.65	-32.42	12.32	21.13	-41.23	-13.00	-28.23	H
3494.36	-34.77	12.61	12.76	-34.92	-13.00	-21.92	V
5242.08	-34.25	13.12	16.32	-37.45	-13.00	-24.45	V
6989.65	-32.50	12.32	21.13	-41.31	-13.00	-28.31	V

Remark: Spurious emissions within 30-1000MHz were found more than 20dB below limit line.

Test is divided into three directions, X/Y/Z. X pattern for the worst.



LTE BAND 4

LTE Band 4 / 20MHz / QPSK / RB Size 1 Offset 0/ The Worst Test Results for Lowest							
Frequency(MHz)	S G.Lev (dBm)	Ant(dBi)	Loss	PMea	Limit	Margin	Polarity
				(dBm)	(dBm)	(dB)	
3440.00	-33.71	12.90	12.56	-33.37	-13.00	-20.37	H
5160.43	-34.58	13.10	12.46	-33.94	-13.00	-20.94	H
6880.83	-33.55	12.33	21.13	-42.35	-13.00	-29.35	H
3440.00	-35.54	12.90	12.76	-35.40	-13.00	-22.40	V
5160.43	-34.19	13.10	16.32	-37.41	-13.00	-24.41	V
6880.83	-32.73	12.33	21.13	-41.53	-13.00	-28.53	V
LTE Band 4 / 20MHz / QPSK / RB Size 1 Offset 0/ The Worst Test Results for Middle							
Frequency(MHz)	S G.Lev (dBm)	Ant(dBi)	Loss	PMea	Limit	Margin	Polarity
				(dBm)	(dBm)	(dB)	
3465.98	-33.70	12.80	12.56	-33.46	-13.00	-20.46	H
5199.22	-34.22	13.10	12.46	-33.58	-13.00	-20.58	H
6931.84	-32.97	12.33	21.13	-41.77	-13.00	-28.77	H
3465.98	-34.55	12.80	12.76	-34.51	-13.00	-21.51	V
5199.22	-33.85	13.10	16.32	-37.07	-13.00	-24.07	V
6931.84	-31.71	12.33	21.13	-40.51	-13.00	-27.51	V
LTE Band 4 / 20MHz / QPSK / RB Size 1 Offset 0/ The Worst Test Results for Highest							
Frequency(MHz)	S G.Lev (dBm)	Ant(dBi)	Loss	PMea	Limit	Margin	Polarity
				(dBm)	(dBm)	(dB)	
3490.62	-34.42	12.61	12.56	-34.37	-13.00	-21.37	H
5235.39	-35.01	13.12	12.46	-34.35	-13.00	-21.35	H
6980.06	-32.82	12.32	21.13	-41.63	-13.00	-28.63	H
3490.62	-35.31	12.61	12.76	-35.46	-13.00	-22.46	V
5235.39	-34.94	13.12	16.32	-38.14	-13.00	-25.14	V
6980.06	-32.55	12.32	21.13	-41.36	-13.00	-28.36	V

Remark: Spurious emissions within 30-1000MHz were found more than 20dB below limit line.
 Test is divided into three directions, X/Y/Z. X pattern for the worst.



LTE BAND 5

LTE Band 5 / 1.4MHz / QPSK / RB Size 1 Offset 0/ The Worst Test Results for Lowest							
Frequency(MHz)	S G.Lev (dBm)	Ant(dBi)	Loss	PMea	Limit	Margin	Polarity
				(dBm)	(dBm)	(dB)	
1649.35	-33.78	9.56	9.72	-33.94	-13.00	-20.94	H
2474.10	-35.29	10.50	10.86	-35.65	-13.00	-22.65	H
3298.69	-33.38	12.78	11.57	-32.17	-13.00	-19.17	H
1649.35	-34.76	9.56	9.34	-34.54	-13.00	-21.54	V
2474.10	-35.03	10.50	10.42	-34.95	-13.00	-21.95	V
3298.69	-32.94	12.78	11.12	-31.28	-13.00	-18.28	V
LTE Band 5 / 1.4MHz / QPSK / RB Size 1 Offset 0/ The Worst Test Results for Middle							
Frequency(MHz)	S G.Lev (dBm)	Ant(dBi)	Loss	PMea	Limit	Margin	Polarity
				(dBm)	(dBm)	(dB)	
1672.98	-34.04	9.56	9.72	-34.20	-13.00	-21.20	H
2509.47	-35.24	10.50	10.86	-35.60	-13.00	-22.60	H
3345.60	-32.86	12.78	11.57	-31.65	-13.00	-18.65	H
1672.98	-34.63	9.56	9.34	-34.41	-13.00	-21.41	V
2509.47	-33.81	10.50	10.42	-33.73	-13.00	-20.73	V
3345.60	-32.32	12.78	11.12	-30.66	-13.00	-17.66	V
LTE Band 5 / 1.4MHz / QPSK / RB Size 1 Offset 0/ The Worst Test Results for Highest							
Frequency(MHz)	S G.Lev (dBm)	Ant(dBi)	Loss	PMea	Limit	Margin	Polarity
				(dBm)	(dBm)	(dB)	
1696.43	-33.49	9.56	9.72	-33.65	-13.00	-20.65	H
2544.75	-34.28	10.50	10.86	-34.64	-13.00	-21.64	H
3392.74	-33.22	12.78	11.57	-32.01	-13.00	-19.01	H
1696.43	-34.64	9.56	9.34	-34.42	-13.00	-21.42	V
2544.75	-34.02	10.50	10.42	-33.94	-13.00	-20.94	V
3392.74	-31.93	12.78	11.12	-30.27	-13.00	-17.27	V

Remark: Spurious emissions within 30-1000MHz were found more than 20dB below limit line.

Test is divided into three directions, X/Y/Z. X pattern for the worst.



LTE BAND 5

LTE Band 5 / 3MHz / QPSK / RB Size 1 Offset 0/ The Worst Test Results for Lowest							
Frequency(MHz)	S G.Lev (dBm)	Ant(dBi)	Loss	PMea	Limit	Margin	Polarity
				(dBm)	(dBm)	(dB)	
1650.99	-34.22	9.56	9.72	-34.38	-13.00	-21.38	H
2476.41	-35.28	10.50	10.86	-35.64	-13.00	-22.64	H
3301.84	-32.38	12.78	11.57	-31.17	-13.00	-18.17	H
1650.99	-35.03	9.56	9.34	-34.81	-13.00	-21.81	V
2476.41	-34.97	10.50	10.42	-34.89	-13.00	-21.89	V
3301.84	-32.13	12.78	11.12	-30.47	-13.00	-17.47	V
LTE Band 5 / 3MHz / QPSK / RB Size 1 Offset 0/ The Worst Test Results for Middle							
Frequency(MHz)	S G.Lev (dBm)	Ant(dBi)	Loss	PMea	Limit	Margin	Polarity
				(dBm)	(dBm)	(dB)	
1672.88	-34.01	9.56	9.72	-34.17	-13.00	-21.17	H
2509.25	-34.24	10.50	10.86	-34.60	-13.00	-21.60	H
3345.73	-33.13	12.78	11.57	-31.92	-13.00	-18.92	H
1672.88	-35.57	9.56	9.34	-35.35	-13.00	-22.35	V
2509.25	-35.19	10.50	10.42	-35.11	-13.00	-22.11	V
3345.73	-32.86	12.78	11.12	-31.20	-13.00	-18.20	V
LTE Band 5 / 3MHz / QPSK / RB Size 1 Offset 0/ The Worst Test Results for Highest							
Frequency(MHz)	S G.Lev (dBm)	Ant(dBi)	Loss	PMea	Limit	Margin	Polarity
				(dBm)	(dBm)	(dB)	
1694.97	-34.51	9.56	9.72	-34.67	-13.00	-21.67	H
2542.50	-34.75	10.50	10.86	-35.11	-13.00	-22.11	H
3389.96	-33.65	12.78	11.57	-32.44	-13.00	-19.44	H
1694.97	-35.19	9.56	9.34	-34.97	-13.00	-21.97	V
2542.50	-33.88	10.50	10.42	-33.80	-13.00	-20.80	V
3389.96	-32.47	12.78	11.12	-30.81	-13.00	-17.81	V

Remark: Spurious emissions within 30-1000MHz were found more than 20dB below limit line.

Test is divided into three directions, X/Y/Z. X pattern for the worst.



LTE BAND 5

LTE Band 5 / 5MHz / QPSK / RB Size 1 Offset 0/ The Worst Test Results for Lowest							
Frequency(MHz)	S G.Lev (dBm)	Ant(dBi)	Loss	PMea	Limit	Margin	Polarity
				(dBm)	(dBm)	(dB)	
1652.59	-33.65	9.56	9.72	-33.81	-13.00	-20.81	H
2479.43	-34.74	10.50	10.86	-35.10	-13.00	-22.10	H
3305.96	-33.00	12.78	11.57	-31.79	-13.00	-18.79	H
1652.59	-35.38	9.56	9.34	-35.16	-13.00	-22.16	V
2479.43	-34.71	10.50	10.42	-34.63	-13.00	-21.63	V
3305.96	-32.54	12.78	11.12	-30.88	-13.00	-17.88	V
LTE Band 5 / 5MHz / QPSK / RB Size 1 Offset 0/ The Worst Test Results for Middle							
Frequency(MHz)	S G.Lev (dBm)	Ant(dBi)	Loss	PMea	Limit	Margin	Polarity
				(dBm)	(dBm)	(dB)	
1672.86	-33.52	9.56	9.72	-33.68	-13.00	-20.68	H
2509.17	-35.32	10.50	10.86	-35.68	-13.00	-22.68	H
3345.70	-32.47	12.78	11.57	-31.26	-13.00	-18.26	H
1672.86	-35.38	9.56	9.34	-35.16	-13.00	-22.16	V
2509.17	-35.24	10.50	10.42	-35.16	-13.00	-22.16	V
3345.70	-32.71	12.78	11.12	-31.05	-13.00	-18.05	V
LTE Band 5 / 5MHz / QPSK / RB Size 1 Offset 0/ The Worst Test Results for Highest							
Frequency(MHz)	S G.Lev (dBm)	Ant(dBi)	Loss	PMea	Limit	Margin	Polarity
				(dBm)	(dBm)	(dB)	
1692.89	-33.93	9.56	9.72	-34.09	-13.00	-21.09	H
2539.35	-34.94	10.50	10.86	-35.30	-13.00	-22.30	H
3385.54	-33.42	12.78	11.57	-32.21	-13.00	-19.21	H
1692.89	-35.83	9.56	9.34	-35.61	-13.00	-22.61	V
2539.35	-34.66	10.50	10.42	-34.58	-13.00	-21.58	V
3385.54	-31.98	12.78	11.12	-30.32	-13.00	-17.32	V

Remark: Spurious emissions within 30-1000MHz were found more than 20dB below limit line.

Test is divided into three directions, X/Y/Z. X pattern for the worst.



LTE BAND 5

LTE Band 5 / 10MHz / QPSK / RB Size 1 Offset 0/ The Worst Test Results for Lowest							
Frequency(MHz)	S G.Lev (dBm)	Ant(dBi)	Loss	PMea	Limit	Margin	Polarity
				(dBm)	(dBm)	(dB)	
1657.54	-33.48	9.56	9.72	-33.64	-13.00	-20.64	H
2486.64	-34.60	10.50	10.86	-34.96	-13.00	-21.96	H
3316.00	-32.66	12.78	11.57	-31.45	-13.00	-18.45	H
1657.54	-35.25	9.56	9.34	-35.03	-13.00	-22.03	V
2486.64	-33.87	10.50	10.42	-33.79	-13.00	-20.79	V
3316.00	-32.71	12.78	11.12	-31.05	-13.00	-18.05	V
LTE Band 5 / 10MHz / QPSK / RB Size 1 Offset 0/ The Worst Test Results for Middle							
Frequency(MHz)	S G.Lev (dBm)	Ant(dBi)	Loss	PMea	Limit	Margin	Polarity
				(dBm)	(dBm)	(dB)	
1672.93	-34.27	9.56	9.72	-34.43	-13.00	-21.43	H
2509.29	-34.64	10.50	10.86	-35.00	-13.00	-22.00	H
3345.78	-32.44	12.78	11.57	-31.23	-13.00	-18.23	H
1672.93	-35.69	9.56	9.34	-35.47	-13.00	-22.47	V
2509.29	-35.16	10.50	10.42	-35.08	-13.00	-22.08	V
3345.78	-32.76	12.78	11.12	-31.10	-13.00	-18.10	V
LTE Band 5 / 10MHz / QPSK / RB Size 1 Offset 0/ The Worst Test Results for Highest							
Frequency(MHz)	S G.Lev (dBm)	Ant(dBi)	Loss	PMea	Limit	Margin	Polarity
				(dBm)	(dBm)	(dB)	
1687.91	-34.55	9.56	9.72	-34.71	-13.00	-21.71	H
2531.66	-34.71	10.50	10.86	-35.07	-13.00	-22.07	H
3375.86	-32.42	12.78	11.57	-31.21	-13.00	-18.21	H
1687.91	-35.65	9.56	9.34	-35.43	-13.00	-22.43	V
2531.66	-34.87	10.50	10.42	-34.79	-13.00	-21.79	V
3375.86	-33.05	12.78	11.12	-31.39	-13.00	-18.39	V

Remark: Spurious emissions within 30-1000MHz were found more than 20dB below limit line.
Test is divided into three directions, X/Y/Z. X pattern for the worst.



LTE BAND 12

LTE Band 12 / 1.4MHz / QPSK / RB Size 1 Offset 0/ The Worst Test Results for Lowest							
Frequency(MHz)	S G.Lev (dBm)	Ant(dBi)	Loss	PMea	Limit	Margin	Polarity
				(dBm)	(dBm)	(dB)	
1399.32	-34.80	8.17	9.34	-35.97	-13.00	-22.97	H
2099.06	-34.61	9.53	10.42	-35.50	-13.00	-22.50	H
2798.40	-32.16	11.27	11.12	-32.01	-13.00	-19.01	H
1399.32	-35.13	8.17	9.34	-36.30	-13.00	-23.30	V
2099.06	-34.02	9.53	10.42	-34.91	-13.00	-21.91	V
2798.40	-32.16	11.27	11.12	-32.01	-13.00	-19.01	V
LTE Band 12 / 1.4MHz / QPSK / RB Size 1 Offset 0/ The Worst Test Results for Middle							
Frequency(MHz)	S G.Lev (dBm)	Ant(dBi)	Loss	PMea	Limit	Margin	Polarity
				(dBm)	(dBm)	(dB)	
1414.78	-34.91	8.17	9.34	-36.08	-13.00	-23.08	H
2122.16	-34.71	9.53	10.42	-35.60	-13.00	-22.60	H
2829.57	-32.34	11.27	11.12	-32.19	-13.00	-19.19	H
1414.78	-35.54	8.17	9.34	-36.71	-13.00	-23.71	V
2122.16	-34.30	9.53	10.42	-35.19	-13.00	-22.19	V
2829.57	-32.53	11.27	11.12	-32.38	-13.00	-19.38	V
LTE Band 12 / 1.4MHz / QPSK / RB Size 1 Offset 0/ The Worst Test Results for Highest							
Frequency(MHz)	S G.Lev (dBm)	Ant(dBi)	Loss	PMea	Limit	Margin	Polarity
				(dBm)	(dBm)	(dB)	
1430.16	-34.07	8.17	9.34	-35.24	-13.00	-22.24	H
2145.84	-35.45	9.53	10.42	-36.34	-13.00	-23.34	H
2860.77	-33.27	11.27	11.12	-33.12	-13.00	-20.12	H
1430.16	-35.52	8.17	9.34	-36.69	-13.00	-23.69	V
2145.84	-34.70	9.53	10.42	-35.59	-13.00	-22.59	V
2860.77	-32.63	11.27	11.12	-32.48	-13.00	-19.48	V

Remark: Spurious emissions within 30-1000MHz were found more than 20dB below limit line.

Test is divided into three directions, X/Y/Z. X pattern for the worst.



LTE BAND 12

LTE Band 12 / 3MHz / QPSK / RB Size 1 Offset 0/ The Worst Test Results for Lowest							
Frequency(MHz)	S G.Lev (dBm)	Ant(dBi)	Loss	PMea	Limit	Margin	Polarity
				(dBm)	(dBm)	(dB)	
1400.74	-34.41	8.17	9.34	-35.58	-13.00	-22.58	H
2101.14	-34.66	9.53	10.42	-35.55	-13.00	-22.55	H
2801.53	-33.45	11.27	11.12	-33.30	-13.00	-20.30	H
1400.74	-35.76	8.17	9.34	-36.93	-13.00	-23.93	V
2101.14	-34.43	9.53	10.42	-35.32	-13.00	-22.32	V
2801.53	-32.04	11.27	11.12	-31.89	-13.00	-18.89	V
LTE Band 12 / 3MHz / QPSK / RB Size 1 Offset 0/ The Worst Test Results for Middle							
Frequency(MHz)	S G.Lev (dBm)	Ant(dBi)	Loss	PMea	Limit	Margin	Polarity
				(dBm)	(dBm)	(dB)	
1414.71	-34.00	8.17	9.34	-35.17	-13.00	-22.17	H
2122.27	-34.84	9.53	10.42	-35.73	-13.00	-22.73	H
2829.85	-32.32	11.27	11.12	-32.17	-13.00	-19.17	H
1414.71	-35.94	8.17	9.34	-37.11	-13.00	-24.11	V
2122.27	-34.95	9.53	10.42	-35.84	-13.00	-22.84	V
2829.85	-31.74	11.27	11.12	-31.59	-13.00	-18.59	V
LTE Band 12 / 3MHz / QPSK / RB Size 1 Offset 0/ The Worst Test Results for Highest							
Frequency(MHz)	S G.Lev (dBm)	Ant(dBi)	Loss	PMea	Limit	Margin	Polarity
				(dBm)	(dBm)	(dB)	
1428.57	-34.53	8.17	9.34	-35.70	-13.00	-22.70	H
2143.10	-34.70	9.53	10.42	-35.59	-13.00	-22.59	H
2857.60	-33.40	11.27	11.12	-33.25	-13.00	-20.25	H
1428.57	-35.18	8.17	9.34	-36.35	-13.00	-23.35	V
2143.10	-33.82	9.53	10.42	-34.71	-13.00	-21.71	V
2857.60	-32.70	11.27	11.12	-32.55	-13.00	-19.55	V

Remark: Spurious emissions within 30-1000MHz were found more than 20dB below limit line.

Test is divided into three directions, X/Y/Z. X pattern for the worst.



LTE BAND 12

LTE Band 12 / 5MHz / QPSK / RB Size 1 Offset 0/ The Worst Test Results for Lowest							
Frequency(MHz)	S G.Lev (dBm)	Ant(dBi)	Loss	PMea	Limit	Margin	Polarity
				(dBm)	(dBm)	(dB)	
1402.85	-34.35	8.17	9.34	-35.52	-13.00	-22.52	H
2104.47	-35.19	9.53	10.42	-36.08	-13.00	-23.08	H
2805.79	-32.21	11.27	11.12	-32.06	-13.00	-19.06	H
1402.85	-35.52	8.17	9.34	-36.69	-13.00	-23.69	V
2104.47	-33.94	9.53	10.42	-34.83	-13.00	-21.83	V
2805.79	-32.31	11.27	11.12	-32.16	-13.00	-19.16	V
LTE Band 12 / 5MHz / QPSK / RB Size 1 Offset 0/ The Worst Test Results for Middle							
Frequency(MHz)	S G.Lev (dBm)	Ant(dBi)	Loss	PMea	Limit	Margin	Polarity
				(dBm)	(dBm)	(dB)	
1414.92	-33.67	8.17	9.34	-34.84	-13.00	-21.84	H
2122.27	-34.04	9.53	10.42	-34.93	-13.00	-21.93	H
2829.53	-33.49	11.27	11.12	-33.34	-13.00	-20.34	H
1414.92	-35.42	8.17	9.34	-36.59	-13.00	-23.59	V
2122.27	-34.22	9.53	10.42	-35.11	-13.00	-22.11	V
2829.53	-31.87	11.27	11.12	-31.72	-13.00	-18.72	V
LTE Band 12 / 5MHz / QPSK / RB Size 1 Offset 0/ The Worst Test Results for Highest							
Frequency(MHz)	S G.Lev (dBm)	Ant(dBi)	Loss	PMea	Limit	Margin	Polarity
				(dBm)	(dBm)	(dB)	
1426.95	-34.82	8.17	9.34	-35.99	-13.00	-22.99	H
2140.08	-34.36	9.53	10.42	-35.25	-13.00	-22.25	H
2853.78	-33.23	11.27	11.12	-33.08	-13.00	-20.08	H
1426.95	-35.61	8.17	9.34	-36.78	-13.00	-23.78	V
2140.08	-34.10	9.53	10.42	-34.99	-13.00	-21.99	V
2853.78	-32.97	11.27	11.12	-32.82	-13.00	-19.82	V

Remark: Spurious emissions within 30-1000MHz were found more than 20dB below limit line.

Test is divided into three directions, X/Y/Z. X pattern for the worst.



LTE BAND 12

LTE Band 12 / 10MHz / QPSK / RB Size 1 Offset 0/ The Worst Test Results for Lowest							
Frequency(MHz)	S G.Lev (dBm)	Ant(dBi)	Loss	PMea	Limit	Margin	Polarity
				(dBm)	(dBm)	(dB)	
1407.54	-34.52	8.17	9.34	-35.69	-13.00	-22.69	H
2111.73	-35.36	9.53	10.42	-36.25	-13.00	-23.25	H
2815.55	-33.00	11.27	11.12	-32.85	-13.00	-19.85	H
1407.54	-35.07	8.17	9.34	-36.24	-13.00	-23.24	V
2111.73	-33.96	9.53	10.42	-34.85	-13.00	-21.85	V
2815.55	-33.17	11.27	11.12	-33.02	-13.00	-20.02	V
LTE Band 12 / 10MHz / QPSK / RB Size 1 Offset 0/ The Worst Test Results for Middle							
Frequency(MHz)	S G.Lev (dBm)	Ant(dBi)	Loss	PMea	Limit	Margin	Polarity
				(dBm)	(dBm)	(dB)	
1414.64	-34.12	8.17	9.34	-35.29	-13.00	-22.29	H
2122.23	-34.14	9.53	10.42	-35.03	-13.00	-22.03	H
2829.67	-33.26	11.27	11.12	-33.11	-13.00	-20.11	H
1414.64	-34.81	8.17	9.34	-35.98	-13.00	-22.98	V
2122.23	-34.06	9.53	10.42	-34.95	-13.00	-21.95	V
2829.67	-33.10	11.27	11.12	-32.95	-13.00	-19.95	V
LTE Band 12 / 10MHz / QPSK / RB Size 1 Offset 0/ The Worst Test Results for Highest							
Frequency(MHz)	S G.Lev (dBm)	Ant(dBi)	Loss	PMea	Limit	Margin	Polarity
				(dBm)	(dBm)	(dB)	
1421.56	-34.26	8.17	9.34	-35.43	-13.00	-22.43	H
2132.72	-35.40	9.53	10.42	-36.29	-13.00	-23.29	H
2843.94	-32.68	11.27	11.12	-32.53	-13.00	-19.53	H
1421.56	-35.52	8.17	9.34	-36.69	-13.00	-23.69	V
2132.72	-35.09	9.53	10.42	-35.98	-13.00	-22.98	V
2843.94	-32.60	11.27	11.12	-32.45	-13.00	-19.45	V

Remark: Spurious emissions within 30-1000MHz were found more than 20dB below limit line.
Test is divided into three directions, X/Y/Z. X pattern for the worst.



LTE BAND 13

LTE Band 13 / 5MHz / QPSK / RB Size 1 Offset 0/ The Worst Test Results for Lowest							
Frequency(MHz)	S G.Lev (dBm)	Ant(dBi)	Loss	PMea	Limit	Margin	Polarity
				(dBm)	(dBm)	(dB)	
1559.23	-34.18	8.17	9.34	-35.35	-13.00	-22.35	H
2338.41	-34.16	9.53	10.42	-35.05	-13.00	-22.05	H
3117.85	-33.10	11.27	11.12	-32.95	-13.00	-19.95	H
1559.23	-35.57	8.17	9.34	-36.74	-13.00	-23.74	V
2338.41	-34.19	9.53	10.42	-35.08	-13.00	-22.08	V
3117.85	-32.90	11.27	11.12	-32.75	-13.00	-19.75	V
LTE Band 13 / 5MHz / QPSK / RB Size 1 Offset 0/ The Worst Test Results for Middle							
Frequency(MHz)	S G.Lev (dBm)	Ant(dBi)	Loss	PMea	Limit	Margin	Polarity
				(dBm)	(dBm)	(dB)	
1564.00	-34.87	8.17	9.34	-36.04	-13.00	-23.04	H
2345.98	-34.33	9.53	10.42	-35.22	-13.00	-22.22	H
3128.17	-33.51	11.27	11.12	-33.36	-13.00	-20.36	H
1564.00	-35.46	8.17	9.34	-36.63	-13.00	-23.63	V
2345.98	-34.51	9.53	10.42	-35.40	-13.00	-22.40	V
3128.17	-31.82	11.27	11.12	-31.67	-13.00	-18.67	V
LTE Band 13 / 5MHz / QPSK / RB Size 1 Offset 0/ The Worst Test Results for Highest							
Frequency(MHz)	S G.Lev (dBm)	Ant(dBi)	Loss	PMea	Limit	Margin	Polarity
				(dBm)	(dBm)	(dB)	
1569.07	-34.45	8.17	9.34	-35.62	-13.00	-22.62	H
2353.34	-35.00	9.53	10.42	-35.89	-13.00	-22.89	H
3138.12	-32.79	11.27	11.12	-32.64	-13.00	-19.64	H
1569.07	-34.54	8.17	9.34	-35.71	-13.00	-22.71	V
2353.34	-34.81	9.53	10.42	-35.70	-13.00	-22.70	V
3138.12	-33.11	11.27	11.12	-32.96	-13.00	-19.96	V

Remark: Spurious emissions within 30-1000MHz were found more than 20dB below limit line.
 Test is divided into three directions, X/Y/Z. X pattern for the worst.



LTE BAND 13

LTE Band 13 / 10MHz / QPSK / RB Size 1 Offset 0/ The Worst Test Results for Middle							
Frequency(MHz)	S G.Lev (dBm)	Ant(dBi)	Loss	PMea	Limit	Margin	Polarity
				(dBm)	(dBm)	(dB)	
1564.04	-33.59	8.17	9.34	-34.76	-13.00	-21.76	H
2346.14	-35.27	9.53	10.42	-36.16	-13.00	-23.16	H
3128.08	-32.41	11.27	11.12	-32.26	-13.00	-19.26	H
1564.04	-34.93	8.17	9.34	-36.10	-13.00	-23.10	V
2346.14	-34.63	9.53	10.42	-35.52	-13.00	-22.52	V
3128.08	-32.64	11.27	11.12	-32.49	-13.00	-19.49	V

Remark: Spurious emissions within 30-1000MHz were found more than 20dB below limit line.

Test is divided into three directions, X/Y/Z. X pattern for the worst.





LTE BAND 17

LTE Band 17 / 5MHz / QPSK / RB Size 1 Offset 0/ The Worst Test Results for Lowest							
Frequency(MHz)	S G.Lev (dBm)	Ant(dBi)	Loss	PMea	Limit	Margin	Polarity
				(dBm)	(dBm)	(dB)	
1413.12	-34.93	8.17	9.34	-36.10	-13.00	-23.10	H
2120.52	-34.39	9.53	10.42	-35.28	-13.00	-22.28	H
2826.84	-32.73	11.27	11.12	-32.58	-13.00	-19.58	H
1413.12	-34.62	8.17	9.34	-35.79	-13.00	-22.79	V
2120.52	-34.12	9.53	10.42	-35.01	-13.00	-22.01	V
2826.84	-32.05	11.27	11.12	-31.90	-13.00	-18.90	V
LTE Band 17 / 5MHz / QPSK / RB Size 1 Offset 0/ The Worst Test Results for Middle							
Frequency(MHz)	S G.Lev (dBm)	Ant(dBi)	Loss	PMea	Limit	Margin	Polarity
				(dBm)	(dBm)	(dB)	
1420.14	-33.57	8.17	9.34	-34.74	-13.00	-21.74	H
2130.15	-35.03	9.53	10.42	-35.92	-13.00	-22.92	H
2840.21	-33.07	11.27	11.12	-32.92	-13.00	-19.92	H
1420.14	-34.89	8.17	9.34	-36.06	-13.00	-23.06	V
2130.15	-34.80	9.53	10.42	-35.69	-13.00	-22.69	V
2840.21	-32.75	11.27	11.12	-32.60	-13.00	-19.60	V
LTE Band 17 / 5MHz / QPSK / RB Size 1 Offset 0/ The Worst Test Results for Highest							
Frequency(MHz)	S G.Lev (dBm)	Ant(dBi)	Loss	PMea	Limit	Margin	Polarity
				(dBm)	(dBm)	(dB)	
1426.11	-34.35	8.17	9.34	-35.52	-13.00	-22.52	H
2139.11	-34.64	9.53	10.42	-35.53	-13.00	-22.53	H
2852.49	-33.13	11.27	11.12	-32.98	-13.00	-19.98	H
1426.11	-34.63	8.17	9.34	-35.80	-13.00	-22.80	V
2139.11	-35.13	9.53	10.42	-36.02	-13.00	-23.02	V
2852.49	-32.40	11.27	11.12	-32.25	-13.00	-19.25	V

Remark: Spurious emissions within 30-1000MHz were found more than 20dB below limit line.
 Test is divided into three directions, X/Y/Z. X pattern for the worst.



LTE BAND 17

LTE Band 17 / 10MHz / QPSK / RB Size 1 Offset 0/ The Worst Test Results for Lowest							
Frequency(MHz)	S G.Lev (dBm)	Ant(dBi)	Loss	PMea	Limit	Margin	Polarity
				(dBm)	(dBm)	(dB)	
1418.16	-33.76	8.17	9.34	-34.93	-13.00	-21.93	H
2127.29	-34.39	9.53	10.42	-35.28	-13.00	-22.28	H
2836.52	-32.62	11.27	11.12	-32.47	-13.00	-19.47	H
1418.16	-35.24	8.17	9.34	-36.41	-13.00	-23.41	V
2127.29	-34.29	9.53	10.42	-35.18	-13.00	-22.18	V
2836.52	-31.79	11.27	11.12	-31.64	-13.00	-18.64	V
LTE Band 17 / 10MHz / QPSK / RB Size 1 Offset 0/ The Worst Test Results for Middle							
Frequency(MHz)	S G.Lev (dBm)	Ant(dBi)	Loss	PMea	Limit	Margin	Polarity
				(dBm)	(dBm)	(dB)	
1420.18	-34.91	8.17	9.34	-36.08	-13.00	-23.08	H
2129.85	-35.20	9.53	10.42	-36.09	-13.00	-23.09	H
2839.85	-32.50	11.27	11.12	-32.35	-13.00	-19.35	H
1420.18	-34.80	8.17	9.34	-35.97	-13.00	-22.97	V
2129.85	-33.85	9.53	10.42	-34.74	-13.00	-21.74	V
2839.85	-32.92	11.27	11.12	-32.77	-13.00	-19.77	V
LTE Band 17 / 10MHz / QPSK / RB Size 1 Offset 0/ The Worst Test Results for Highest							
Frequency(MHz)	S G.Lev (dBm)	Ant(dBi)	Loss	PMea	Limit	Margin	Polarity
				(dBm)	(dBm)	(dB)	
1421.22	-33.76	8.17	9.34	-34.93	-13.00	-21.93	H
2131.89	-35.41	9.53	10.42	-36.30	-13.00	-23.30	H
2842.52	-32.80	11.27	11.12	-32.65	-13.00	-19.65	H
1421.22	-35.18	8.17	9.34	-36.35	-13.00	-23.35	V
2131.89	-34.98	9.53	10.42	-35.87	-13.00	-22.87	V
2842.52	-31.88	11.27	11.12	-31.73	-13.00	-18.73	V

Remark: Spurious emissions within 30-1000MHz were found more than 20dB below limit line.

Test is divided into three directions, X/Y/Z. X pattern for the worst.

10. FREQUENCY STABILITY

10.1 DESCRIPTION OF FREQUENCY STABILITY MEASUREMENT

10.1.1 MEASUREMENT METHOD

The frequency stability shall be measured by variation of ambient temperature and variation of primary supply voltage to ensure that the fundamental emission stays within the authorized frequency block. The frequency stability of the transmitter shall be maintained within $\pm 0.00025\%$ ($\pm 2.5\text{ppm}$) of the center frequency.

10.1.2 Test Setup

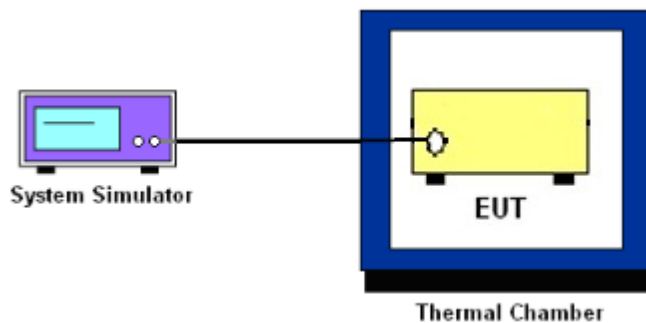

10.1.3 TEST PROCEDURES FOR TEMPERATURE VARIATION

1. The EUT was set up in the thermal chamber and connected with the system simulator.
2. With power OFF, the temperature was decreased to -30°C and the EUT was stabilized before testing. Power was applied and the maximum change in frequency was recorded within one minute.
3. With power OFF, the temperature was raised in 10°C step up to 50°C . The EUT was stabilized at each step for at least half an hour. Power was applied and the maximum frequency change was recorded within one minute.

10.1.4 TEST PROCEDURES FOR VOLTAGE VARIATION

1. The testing follows FCC KDB 971168 v03r01 Section 9.0.
2. The EUT was placed in a temperature chamber at $25\pm 5^{\circ}\text{C}$ and connected with the system simulator.
3. The power supply voltage to the EUT was varied from 85% to 115% of the nominal value measured at the input to the EUT.
4. The variation in frequency was measured for the worst case.



10.1.4 MEASUREMENT RESULT

LTE BAND 2

LTE Band 2 (QPSK) / 1880MHz / BW10M					
Temperature (°C)	Voltage	Freq. Dev.	Freq. Dev.	Limit	Result
	(Volt)	(Hz)	(ppm)		
50	Normal Voltage	24.49	0.013	2.5ppm	PASS
40		15.46	0.008		
30		20.98	0.011		
20		18.48	0.010		
10		15.37	0.008		
0		29.07	0.015		
-10		18.16	0.010		
-20		34.18	0.018		
-30		21.53	0.011		
25		Maximum Voltage	18.96		
25	BEP	20.88	0.011		

LTE Band 2 (QPSK) / 1880MHz / BW20M					
Temperature (°C)	Voltage	Freq. Dev.	Freq. Dev.	Limit	Result
	(Volt)	(Hz)	(ppm)		
50	Normal Voltage	23.65	0.013	2.5ppm	PASS
40		15.98	0.009		
30		27.76	0.015		
20		35.10	0.019		
10		18.98	0.010		
0		21.36	0.011		
-10		25.10	0.013		
-20		19.68	0.010		
-30		16.73	0.009		
25		Maximum Voltage	26.93		
25	BEP	18.06	0.010		

Note: The frequency fundamental emissions stay within the authorized frequency block based on the frequency deviation measured is small.



LTE BAND 4

LTE Band 4 (QPSK) / 1733MHz / BW10M					
Temperature (°C)	Voltage	Freq. Dev.	Freq. Dev.	Limit	Result
	(Volt)	(Hz)	(ppm)		
50	Normal Voltage	26.90	0.016	2.5ppm	PASS
40		27.56	0.016		
30		13.47	0.008		
20		34.78	0.020		
10		35.51	0.020		
0		28.99	0.017		
-10		30.47	0.018		
-20		20.29	0.012		
-30		19.32	0.011		
25		Maximum Voltage	25.64		
25	BEP	13.07	0.008		

LTE Band 4 (QPSK) / 1733MHz / BW20M					
Temperature (°C)	Voltage	Freq. Dev.	Freq. Dev.	Limit	Result
	(Volt)	(Hz)	(ppm)		
50	Normal Voltage	21.51	0.012	2.5ppm	PASS
40		25.79	0.015		
30		27.03	0.016		
20		27.63	0.016		
10		14.93	0.009		
0		32.43	0.019		
-10		26.11	0.015		
-20		16.65	0.010		
-30		35.01	0.020		
25		Maximum Voltage	23.36		
25	BEP	28.73	0.017		

Note: The frequency fundamental emissions stay within the authorized frequency block based on the frequency deviation measured is small.



LTE BAND 5

LTE Band 5 (QPSK) / 836.5MHz / BW5M					
Temperature (°C)	Voltage	Freq. Dev.	Freq. Dev.	Limit	Result
	(Volt)	(Hz)	(ppm)		
50	Normal Voltage	18.91	0.027	2.5ppm	PASS
40		13.75	0.019		
30		33.18	0.047		
20		14.48	0.020		
10		34.48	0.049		
0		33.81	0.048		
-10		28.45	0.004		
-20		32.44	0.046		
-30		12.80	0.018		
25		Maximum Voltage	14.53		
25	BEP	16.91	0.024		

LTE Band 5 (QPSK) / 836.5MHz / BW10M					
Temperature (°C)	Voltage	Freq. Dev.	Freq. Dev.	Limit	Result
	(Volt)	(Hz)	(ppm)		
50	Normal Voltage	20.29	0.029	2.5ppm	PASS
40		35.09	0.049		
30		16.00	0.023		
20		18.79	0.026		
10		13.00	0.018		
0		12.63	0.018		
-10		27.50	0.004		
-20		28.75	0.040		
-30		30.53	0.043		
25		Maximum Voltage	21.70		
25	BEP	12.46	0.018		

Note: The frequency fundamental emissions stay within the authorized frequency block based on the frequency deviation measured is small.



LTE BAND 12

LTE Band 12 (QPSK) / 707.5MHz / BW5M					
Temperature (°C)	Voltage	Freq. Dev.	Freq. Dev.	Limit	Result
	(Volt)	(Hz)	(ppm)		
50	Normal Voltage	20.26	0.029	2.5ppm	PASS
40		24.43	0.034		
30		13.63	0.019		
20		28.06	0.040		
10		33.01	0.046		
0		31.47	0.044		
-10		11.62	0.002		
-20		26.03	0.037		
-30		30.28	0.043		
25		Maximum Voltage	24.71		
25	BEP	34.48	0.049		

LTE Band 12 (QPSK) / 707.5MHz / BW10M					
Temperature (°C)	Voltage	Freq. Dev.	Freq. Dev.	Limit	Result
	(Volt)	(Hz)	(ppm)		
50	Normal Voltage	19.69	0.028	2.5ppm	PASS
40		36.18	0.051		
30		32.52	0.046		
20		24.81	0.035		
10		33.77	0.048		
0		21.17	0.030		
-10		36.00	0.005		
-20		23.19	0.033		
-30		18.14	0.026		
25		Maximum Voltage	11.99		
25	BEP	17.58	0.025		

Note: The frequency fundamental emissions stay within the authorized frequency block based on the frequency deviation measured is small.



LTE BAND 13

LTE Band 13 (QPSK) / 782MHz / BW5M					
Temperature (°C)	Voltage	Freq. Dev.	Freq. Dev.	Limit	Result
	(Volt)	(Hz)	(ppm)		
50	Normal Voltage	14.22	0.020	2.5ppm	PASS
40		35.52	0.050		
30		16.87	0.024		
20		22.29	0.031		
10		24.88	0.035		
0		20.89	0.029		
-10		14.76	0.002		
-20		28.96	0.041		
-30		23.11	0.033		
25		Maximum Voltage	22.32		
25	BEP	24.09	0.034		

LTE Band 13 (QPSK) / 782MHz / BW10M					
Temperature (°C)	Voltage	Freq. Dev.	Freq. Dev.	Limit	Result
	(Volt)	(Hz)	(ppm)		
50	Normal Voltage	19.02	0.027	2.5ppm	PASS
40		18.07	0.025		
30		28.01	0.039		
20		24.03	0.034		
10		17.67	0.025		
0		28.61	0.040		
-10		26.91	0.004		
-20		15.90	0.022		
-30		18.77	0.026		
25		Maximum Voltage	21.33		
25	BEP	29.72	0.042		

Note: The frequency fundamental emissions stay within the authorized frequency block based on the frequency deviation measured is small.



LTE BAND 17

LTE Band 17 (QPSK) / 710MHz / BW5M					
Temperature (°C)	Voltage	Freq. Dev.	Freq. Dev.	Limit	Result
	(Volt)	(Hz)	(ppm)		
50	Normal Voltage	25.26	0.036	2.5ppm	PASS
40		32.55	0.046		
30		15.60	0.022		
20		25.67	0.036		
10		17.10	0.024		
0		25.27	0.036		
-10		25.29	0.004		
-20		25.42	0.036		
-30		17.38	0.024		
25		Maximum Voltage	17.43		
25	BEP	19.56	0.028		

LTE Band 17 (QPSK) / 710MHz / BW10M					
Temperature (°C)	Voltage	Freq. Dev.	Freq. Dev.	Limit	Result
	(Volt)	(Hz)	(ppm)		
50	Normal Voltage	27.07	0.038	2.5ppm	PASS
40		28.41	0.040		
30		34.42	0.048		
20		33.56	0.047		
10		33.08	0.047		
0		31.76	0.045		
-10		28.29	0.004		
-20		16.67	0.023		
-30		17.92	0.025		
25		Maximum Voltage	18.73		
25	BEP	17.35	0.024		

Note: The frequency fundamental emissions stay within the authorized frequency block based on the frequency deviation measured is small.

PHOTOS OF TEST SETUP

RADIATED SPURIOUS EMISSION

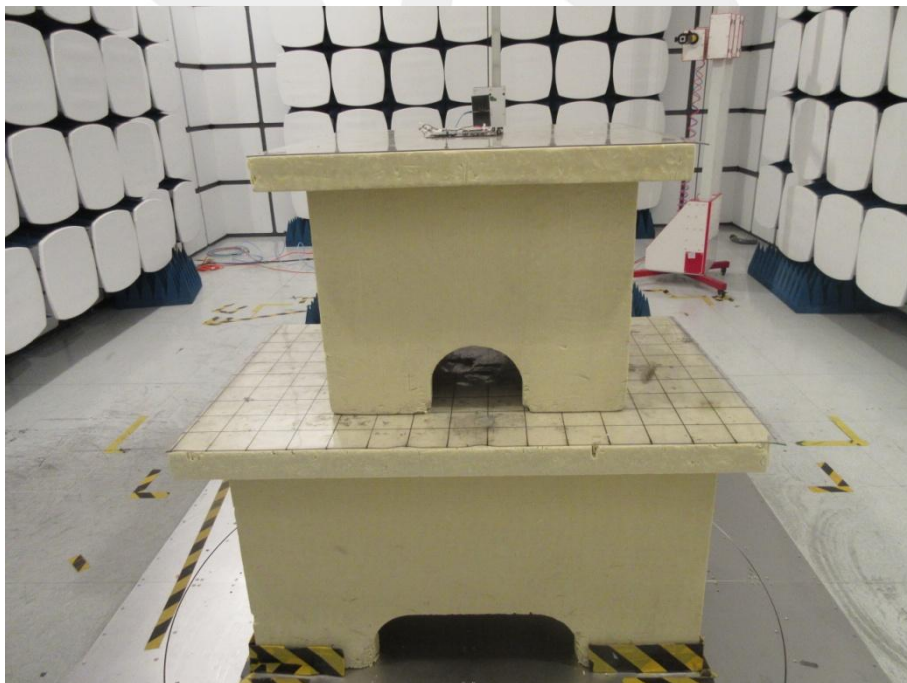
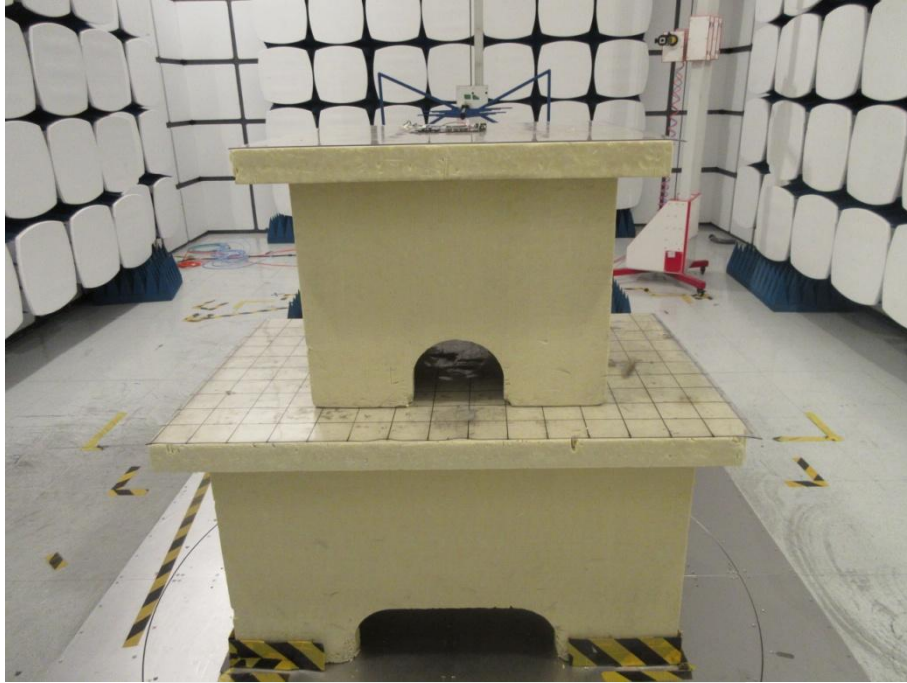

*****END OF THE REPORT*****