



RF TEST REPORT

Applicant MeiG Smart Technology Co., Ltd
FCC ID 2APJ4-SLM750VSA
Product SLM750VSA
Brand MEIGLink
Model SLM750VSA
Report No. R2202A0142-R4V2
Issue Date March 14, 2022

TA Technology (Shanghai) Co., Ltd. tested the above equipment in accordance with the requirements in **FCC CFR47 Part 2 (2021)/ FCC CFR47 Part 27C (2021)**. The test results show that the equipment tested is capable of demonstrating compliance with the requirements as documented in this report.

Prepared by: Peng Tao

Approved by: Kai Xu

TA Technology (Shanghai) Co., Ltd.

No.145, Jintang Rd, Tangzhen Industry Park, Pudong Shanghai, China

TEL: +86-021-50791141/2/3

FAX: +86-021-50791141/2/3-8000



TABLE OF CONTENT

1	Test Laboratory.....	5
1.1	Notes of the Test Report.....	5
1.2.	Test facility.....	5
1.3	Testing Location.....	5
2	General Description of Equipment under Test.....	6
2.1	Applicant and Manufacturer Information.....	6
2.2	General information.....	6
3	Applied Standards.....	7
4	Test Configuration.....	8
5	Test Case.....	10
5.1	RF Power Output and Effective Isotropic Radiated Power.....	10
5.2	Occupied Bandwidth.....	13
5.3	Band Edge Compliance.....	14
5.4	Peak-to-Average Power Ratio (PAPR).....	16
5.5	Frequency Stability.....	17
5.6	Spurious Emissions at Antenna Terminals.....	18
5.7	Radiates Spurious Emission.....	20
6	Test Results.....	23
6.1	RF Power Output and Effective Isotropic Radiated Power.....	23
6.2	Occupied Bandwidth.....	45
6.3	Band Edge Compliance.....	55
6.4	Peak-to-Average Power Ratio (PAPR).....	66
6.5	Frequency Stability.....	68
6.6	Spurious Emissions at Antenna Terminals.....	73
6.7	Radiates Spurious Emission.....	78
7	Main Test Instruments.....	81
	ANNEX A: The EUT Appearance.....	82
	ANNEX B: Test Setup Photos.....	83



Version	Revision description	Issue Date
Rev.0	Initial issue of report.	March 1, 2022
Rev.1	Update information in Page 6.	March 11, 2022
Rev.2	Update data in Page 39.	March 14, 2022

Note: This revised report (Report No. 2202A0142-R4V2) supersedes and replaces the previously issued report (Report No. 2202A0142-R4V1). Please discard or destroy the previously issued report and dispose of it accordingly.



Summary of Measurement Results

Number	Test Case	Clause in FCC rules	Verdict
1	RF Power Output and Effective Isotropic Radiated Power	2.1046 /27.50(h)(2)	PASS
2	Occupied Bandwidth	2.1049	PASS
3	Band Edge Compliance	/27.53(m) /27.53(4)(5)	PASS
4	Peak-to-Average Power Ratio	27.50(d)/KDB971168 D01(5.7)	PASS
5	Frequency Stability	2.1055 / 27.54	PASS
6	Spurious Emissions at Antenna Terminals	2.1051 /27.53(m)	PASS
7	Radiates Spurious Emission	2.1053 /27.53(m)	PASS

Date of Testing: February 18, 2022 and February 21, 2022

Date of Sample Received: February 16, 2022

Note: PASS: The EUT complies with the essential requirements in the standard.

FAIL: The EUT does not comply with the essential requirements in the standard.

All indications of Pass/Fail in this report are opinions expressed by TA Technology (Shanghai) Co., Ltd. based on interpretations and/or observations of test results. Measurement Uncertainties were not taken into account and are published for informational purposes only.



1 Test Laboratory

1.1 Notes of the Test Report

This report shall not be reproduced in full or partial, without the written approval of **TA technology (shanghai) co., Ltd.** The results documented in this report apply only to the tested sample, under the conditions and modes of operation as described herein .Measurement Uncertainties were not taken into account and are published for informational purposes only. This report is written to support regulatory compliance of the applicable standards stated above.

1.2. Test facility

FCC (Designation number: CN1179, Test Firm Registration Number: 446626)

TA Technology (Shanghai) Co., Ltd. has been listed on the US Federal Communications Commission list of test facilities recognized to perform measurements.

A2LA (Certificate Number: 3857.01)

TA Technology (Shanghai) Co., Ltd. has been listed by American Association for Laboratory Accreditation to perform measurement.

1.3 Testing Location

Company: TA Technology (Shanghai) Co., Ltd.
Address: No.145, Jintang Rd, Tangzhen Industry Park, Pudong Shanghai, China
City: Shanghai
Post code: 201201
Country: P. R. China
Contact: Xu Kai
Telephone: +86-021-50791141/2/3
Fax: +86-021-50791141/2/3-8000
Website: <http://www.ta-shanghai.com>
E-mail: xukai@ta-shanghai.com

2 General Description of Equipment under Test

2.1 Applicant and Manufacturer Information

Applicant	MeiG Smart Technology Co., Ltd
Applicant address	Floor 2, Office Building No.5, Lingxia Road, Fenghuang Community, Fuyong Street, Bao 'an District, Shenzhen
Manufacturer	MeiG Smart Technology Co., Ltd
Manufacturer address	Floor 2, Office Building No.5, Lingxia Road, Fenghuang Community, Fuyong Street, Bao 'an District, Shenzhen

2.2 General information

EUT Description			
Model	SLM750VSA		
IMEI	868159056261394		
Hardware Version	SLM750-V_MB_V1.00		
Software Version	SLM750-V_4.0.13_EQ101		
Power Supply	External power supply		
Antenna Type	PCB Antenna		
Antenna Gain	3.5dBi		
Test Mode(s)	LTE Band 7/40		
Test Modulation	(LTE)QPSK, 16QAM;		
LTE Category	4		
Maximum E.I.R.P.	LTE Band 7:	25.82dBm	
	LTE Band 40 Subset 1:	25.40 dBm	
		123.112 mW/MHz	220.75mW/5MHz
	LTE Band 40 Subset 2:	25.03dBm	
		172.703mW/MHz	244.231mW/5MHz
	Rated Power Supply Voltage	3.8V	
Operating Voltage	Minimum: 3.3V Maximum: 4.2V		
Operating Temperature	Lowest: -40°C Highest: +85°C		
Testing Temperature	Lowest: -40°C Highest: +85°C		
Operating Frequency Range(s)	Mode	Tx (MHz)	Rx (MHz)
	LTE Band 7	2500 ~ 2570	2620 ~ 2690
	LTE Band 40 Subset 1	2305 ~ 2315	2305 ~ 2315
	LTE Band 40 Subset 2	2350 ~ 2360	2350 ~ 2360
Note: 1. The EUT is sent from the applicant to TA and the information of the EUT is declared by the applicant.			



3 Applied Standards

According to the specifications of the manufacturer, it must comply with the requirements of the following standards:

Test standards:

FCC CFR47 Part 27C (2021)

FCC CFR47 Part 2 (2021)

Reference standard:

ANSI C63.26 (2015)

KDB 971168 D01 Power Meas License Digital Systems v03r01

4 Test Configuration

Radiated measurements are performed by rotating the EUT in three different orthogonal test planes. EUT stand-up position (Z axis), lie-down position (X, Y axis). Receiver antenna polarization (horizontal and vertical), the worst emission was found in position (Z axis, vertical polarization) and the worst case was recorded.

All mode and data rates and positions and RB size and modulations were investigated.

Subsequently, only the worst case emissions are reported.

The following testing in LTE is set based on the maximum RF Output Power.

The following testing in different Bandwidth is set to detail in the following table:

Test modes are chosen to be reported as the worst case configuration below:

Test items	Modes	Bandwidth (MHz)						Modulation		RB			Test Channel			
		1.4	3	5	10	15	20	QPSK	16QAM	1	50%	100%	L	M	H	
RF Power Output and Effective Isotropic Radiated Power	LTE 7	-	-	0	0	0	0	0	0	0	0	0	0	0	0	0
	LTE 40 Subset 1	-	-	0	0	-	-	0	0	0	0	0	0	0	0	0
	LTE 40 Subset 2	-	-	0	0	-	-	0	0	0	0	0	0	0	0	0
Occupied Bandwidth	LTE 7	-	-	0	0	0	0	0	0	-	-	0	0	0	0	
	LTE 40 Subset 1	-	-	0	0	-	-	0	0	-	-	0	0	0	0	
	LTE 40 Subset 2	-	-	0	0	-	-	0	0	-	-	0	0	0	0	
Band Edge Compliance	LTE 7	-	-	0	0	0	0	0	0	0	-	0	0	-	0	
	LTE 40 Subset 1	-	-	0	0	-	-	0	0	0	-	0	0	-	0	
	LTE 40 Subset 2	-	-	0	0	-	-	0	0	0	-	0	0	-	0	
Peak-to-Average Power Ratio	LTE 7	-	-	0	0	0	0	0	0	-	-	0	0	0	0	
	LTE 40 Subset 1	-	-	0	0	-	-	0	0	-	-	0	0	0	0	
	LTE 40 Subset 2	-	-	0	0	-	-	0	0	-	-	0	0	0	0	
Frequency Stability	LTE 7	-	-	0	0	0	0	0	0	0	-	-	-	0	-	
	LTE 40 Subset 1	-	-	0	0	-	-	0	0	0	-	-	-	0	-	
	LTE 40 Subset 2	-	-	0	0	-	-	0	0	0	-	-	-	0	-	
Spurious	LTE 7	-	-	0	0	0	0	0	-	0	-	-	0	0	0	



Emissions at Antenna Terminals	LTE 40 Subset 1	-	-	O	O	-	-	O	-	O	-	-	O	O	O
	LTE 40 Subset 2	-	-	O	O	-	-	O	-	O	-	-	O	O	O
Radiates Spurious Emission	LTE 7	-	-	O	-	-	O	O	-	O	-	-	-	O	-
	LTE 40 Subset 1	-	-	O	O	-	-	O	-	O	-	-	-	O	-
	LTE 40 Subset 2	-	-	O	O	-	-	O	-	O	-	-	-	O	-
Note	<p>1. The mark "O" means that this configuration is chosen for testing.</p> <p>2. The mark "-" means that this configuration is not testing.</p>														

5 Test Case

5.1 RF Power Output and Effective Isotropic Radiated Power

Ambient condition

Temperature	Relative humidity	Pressure
23°C ~25°C	45%~50%	101.5kPa

Methods of Measurement

During the process of the testing, The EUT was connected to the Base Station Simulator with a known loss. The EUT is controlled by the Base Station Simulator test set to ensure max power transmission with proper modulation.

ERP can then be calculated as follows:

$$\text{EIRP (dBm)} = \text{Output Power (dBm)} - \text{Losses (dB)} + \text{Antenna Gain (dBi)}$$

where:dBd refers to gain relative to an ideal dipole.

$$\text{EIRP (dBm)} = \text{ERP (dBm)} + 2.15 \text{ (dB.)}$$

Test Setup

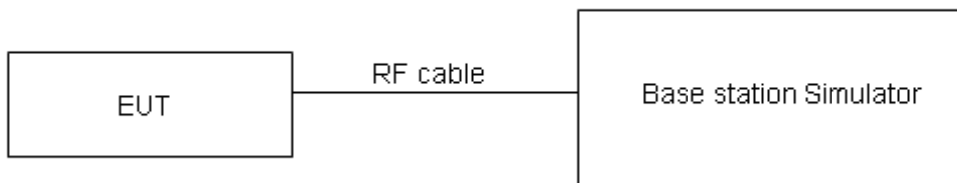

Limits

No specific RF power output requirements in part 2.1046.

Rule Part 27.50(a)(3) Mobile and portable stations. (i) For mobile and portable stations transmitting in the 2305-2315 MHz band or the 2350-2360 MHz band, the average EIRP must not exceed 50 milliwatts within any 1 megahertz of authorized bandwidth, except that for mobile and portable stations compliant with 3GPP LTE standards or another advanced mobile broadband protocol that avoids concentrating energy at the edge of the operating band the average EIRP must not exceed 250 milliwatts within any 5 megahertz of authorized bandwidth but may exceed 50 milliwatts within any 1 megahertz of authorized bandwidth. For mobile and portable stations using time division duplexing (TDD) technology, the duty cycle must not exceed 38 percent in the 2305-2315 MHz and 2350-2360 MHz bands. Mobile and portable stations using FDD technology are restricted to transmitting in the 2305-2315 MHz band. Power averaging shall not include intervals in which the transmitter is off.

Rule Part 27.53(m) (4) specifies that "for BRS and EBS stations. For mobile digital stations, the attenuation factor shall be not less than $40 + 10 \log (P)$ dB on all frequencies between the channel edge and 5 megahertz from the channel edge, $43 + 10 \log (P)$ dB on all frequencies between 5 megahertz and X megahertz from the channel edge, and $55 + 10 \log (P)$ dB on all frequencies more than X megahertz from the channel edge, where X is the greater of 6 megahertz or the actual emission bandwidth as defined in paragraph (m)(4) of this section. In addition, the attenuation factor shall not be less than $43 + 10 \log (P)$ dB on all frequencies between 2490.5 MHz and 2496 MHz and $55 + 10 \log (P)$ dB at or below 2490.5 MHz. Mobile Satellite Service licensees operating on frequencies below 2495 MHz may also submit a documented interference complaint against BRS licensees operating on channel BRS Channel 1 on the same terms and conditions as adjacent channel BRS or EBS licensees.

Rule Part 27.50(h) (2) specifies that "Mobile and other user stations. Mobile stations are limited to 2.0 watts EIRP. All user stations are limited to 2.0 watts transmitter output power."

Part 27.50(h)(2) Limit	$\leq 2 \text{ W}$ (33 dBm)
------------------------	-----------------------------

For mobile and portable stations transmitting in the 2305-2315 MHz band or the 2350-2360 MHz band, the average EIRP must not exceed 50 milliwatts within any 1 megahertz of authorized bandwidth, except that for mobile and portable stations compliant with 3GPP LTE standards or another advanced mobile broadband protocol that avoids concentrating energy at the edge of the operating band the average EIRP must not exceed 250 milliwatts within any 5 megahertz of authorized bandwidth but may exceed 50 milliwatts within any 1 megahertz of authorized bandwidth. For mobile and portable stations using time division duplexing (TDD) technology, the duty cycle must not exceed 38 percent in the 2305-2315 MHz and 2350-2360 MHz bands. Mobile and portable stations using FDD technology are restricted to transmitting in the 2305-2315 MHz band. Power averaging shall not include intervals in which the transmitter is off.

Measurement Uncertainty

The assessed measurement uncertainty to ensure 95% confidence level for the normal distribution is with the coverage factor $k = 2$, $U = 0.4$ dB for RF power output, $k = 2$, $U = 1.19$ dB for ERP/EIRP.



Test Results

Refer to the section 6.1 of this report for test data.

5.2 Occupied Bandwidth

Ambient condition

Temperature	Relative humidity	Pressure
23°C ~25°C	45%~50%	101.5kPa

Method of Measurement

The EUT was connected to Spectrum Analyzer and Base Station Simulator via power Splitter. The occupied bandwidth is measured using spectrum analyzer.

RBW is set to $\geq 1\%EBW$, VBW is set to 3x RBW.

99% power and -26dBc occupied bandwidths are recorded. Spectrum analyzer plots are included on the following pages.

Test Setup

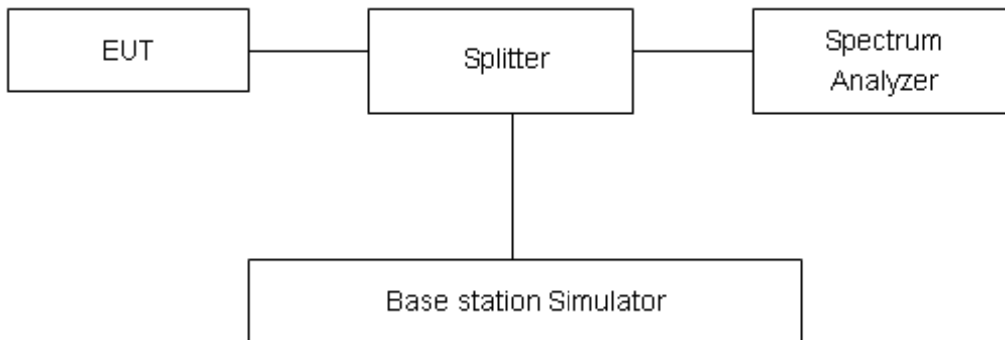

Limits

No specific occupied bandwidth requirements in part 2.1049.

Measurement Uncertainty

The assessed measurement uncertainty to ensure 95% confidence level for the normal distribution is with the coverage factor $k = 2$, $U=624\text{Hz}$.

Test Results

Refer to the section 6.2 of this report for test data.

5.3 Band Edge Compliance

Ambient condition

Temperature	Relative humidity	Pressure
23°C ~25°C	45%~50%	101.5kPa

Method of Measurement

The EUT was connected to Spectrum Analyzer and Base Station Simulator via power Splitter. The band edge of the lowest and highest channels were measured.

The testing follows KDB 971168 D01 v03r01 Section 6.0

The EUT was connected to spectrum analyzer and system simulator via a power divider.

The band edges of low and high channels for the highest RF powers were measured.

For LTE Band 7 set RBW \geq 1% EBW in the 1MHz band immediately outside and adjacent to the band edge. Beyond the 1 MHz band from the band edge, RBW=1MHz was used.

Test Setup

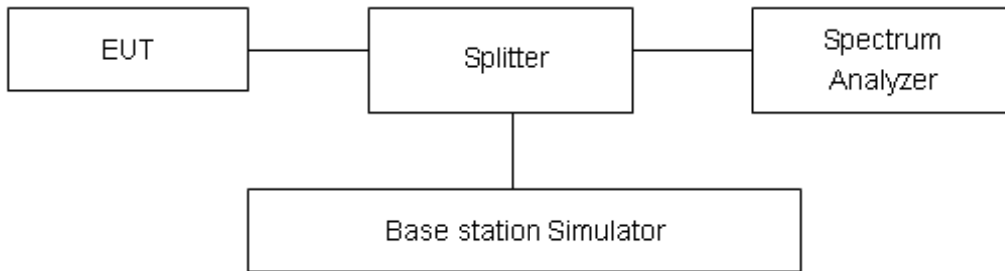

Limits

Rule Part 27.53(i) By a factor of not less than $43 + 10 \log (P)$ dB on all frequencies between 2305 and 2320 MHz.

Rule Part 27.53(a) (3) For mobile and portable stations operating in the 2305-2315 MHz and 2350-2360 MHz bands: (i) By a factor of not less than: $43 + 10 \log (P)$ dB on all frequencies between 2305 and 2320 MHz and on all frequencies between 2345 and 2360 MHz that are outside the licensed band(s) of operation, not less than $55 + 10 \log (P)$ dB on all frequencies between 2320 and 2324 MHz and on all frequencies between 2341 47 CFR Part 27 -- Miscellaneous Wireless Communications Services and 2345 MHz, not less than $61 + 10 \log (P)$ dB on all frequencies between 2324 and 2328 MHz and on all frequencies between 2337 and 2341 MHz, and not less than $67 + 10 \log (P)$ dB on all frequencies between 2328 and 2337 MHz; (ii) By a factor of not less than $43 + 10 \log (P)$ dB on all frequencies between 2300 and 2305 MHz, $55 + 10 \log (P)$ dB on all frequencies between 2296 and 2300 MHz, $61 + 10 \log (P)$ dB on all frequencies between 2292 and 2296 MHz, $67 + 10 \log (P)$ dB on all frequencies between 2288 and 2292 MHz, and $70 + 10 \log (P)$ dB below 2288 MHz; (iii) By a factor of not less than $43 + 10 \log (P)$ dB on all frequencies between 2360 and 2365 MHz, and not less than $70 + 10 \log (P)$ dB above 2365 MHz. (5) Measurement procedure.

Compliance with these rules is based on the use of measurement instrumentation employing a resolution bandwidth of 1 MHz or greater. However, in the 1 MHz bands immediately outside and



adjacent to the channel blocks at 2305, 2310, 2315, 2320, 2345, 2350, 2355, and 2360 MHz, a resolution bandwidth of at least 1 percent of the emission bandwidth of the fundamental emission of the transmitter may be employed. A narrower resolution bandwidth is permitted in all cases to improve measurement accuracy provided the measured power is integrated over the full required measurement bandwidth (i.e., 1 MHz). The emission bandwidth is defined as the width of the signal between two points, one below the carrier center frequency and one on spectrum analyzer. Set spectrum analyzer with RMS detector. The RF fundamental frequency should be excluded against the limit line in the operating frequency band. Checked that all the results comply with the emission limit line.

Example:

The limit line is derived from $43 + 10\log(P)$ dB below the transmitter power P(Watts)

$= P(W) - [43 + 10\log(P)]$ (dB)

$= [30 + 10\log(P)]$ (dBm) - $[43 + 10\log(P)]$ (dB) = -13dBm.

Measurement Uncertainty

The assessed measurement uncertainty to ensure 95% confidence level for the normal distribution is with the coverage factor $k = 1.96$, $U = 0.684$ dB.

Test Results

Refer to the section 6.3 of this report for test data.

5.4 Peak-to-Average Power Ratio (PAPR)

Ambient condition

Temperature	Relative humidity	Pressure
23°C ~25°C	45%~50%	101.5kPa

Methods of Measurement

Measure the total peak power and record as PPK. And measure the total average power and record as PAvg. Both the peak and average power levels must be expressed in the same logarithmic units (e.g., dBm). Determine the PAPR from:

$$PAPR (dB) = PPK (dBm) - PAvg (dBm).$$

Test Setup

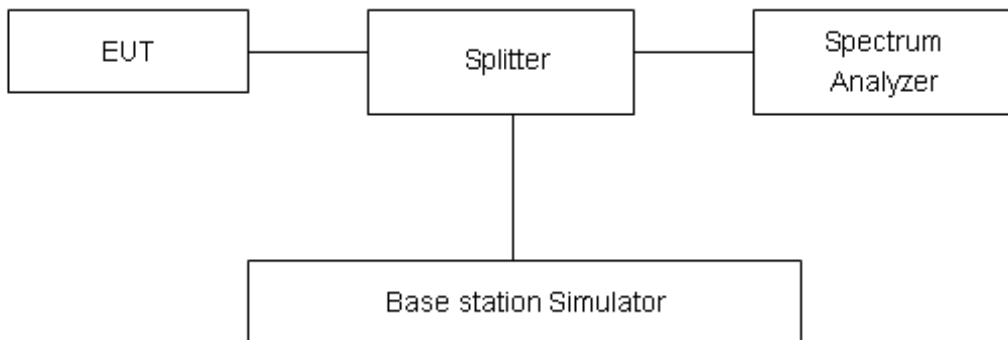

Limits

Rule Part 27.50(d)(5) Equipment employed must be authorized in accordance with the provisions of 24.51. Power measurements for transmissions by stations authorized under this section may be made either in accordance with a Commission-approved average power technique or in compliance with paragraph (d)(6) of this section. In measuring transmissions in this band using an average power technique, the peak-to-average ratio (PAR) of the transmission may not exceed 13 dB.

Measurement Uncertainty

The assessed measurement uncertainty to ensure 95% confidence level for the normal distribution is with the coverage factor k = 2, U= 0.4 dB.

Test Results

Refer to the section 6.4 of this report for test data.

5.5 Frequency Stability

Ambient condition

Temperature	Relative humidity	Pressure
23°C ~25°C	45%~50%	101.5kPa

Method of Measurement

Frequency Stability (Temperature Variation)

The temperature inside the climate chamber is varied from -40°C to +85°C in 10°C step size.

(1)With all power removed, the temperature was decreased to -10°C and permitted to stabilize for three hours.

(2)Measure the carrier frequency with the test equipment in a “call mode”. These measurements should be made within 1 minute of powering up the mobile station, to prevent significant self warming.

(3) Repeat the above measurements at 10°C increments from-40°C to +85°C. Allow at least 1.5 hours at each temperature, un-powered, before making measurements.

Frequency Stability (Voltage Variation)

The frequency stability shall be measured with variation of primary supply voltage as follows:

Primary Supply Voltage: The primary supply voltage is varied from 85% to 115% of the nominal value for non hand-carried battery and AC powered equipment. For hand-carried, battery-powered equipment, primary supply voltage is reduced to the battery operating end point which shall be specified by the manufacturer.

This transceiver is specified to operate with an input voltage of between 3.3 V and 4.2V, with a nominal voltage of 3.8V.

Test setup

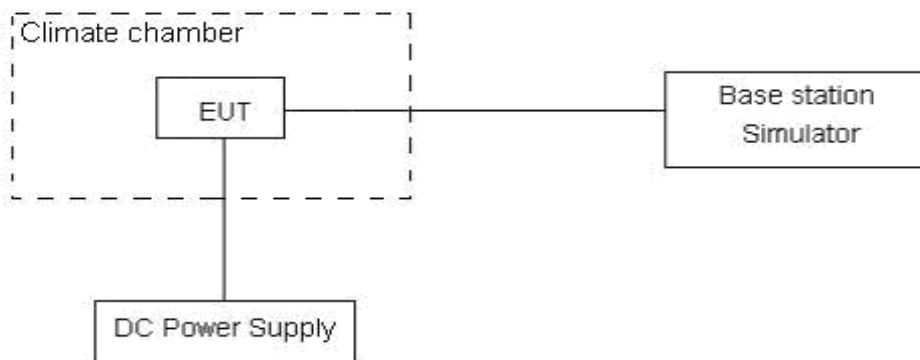

Limits

The frequency stability shall be sufficient to ensure that the fundamental emissions stay within the authorized bands of operation.

Measurement Uncertainty

The assessed measurement uncertainty to ensure 99.75% confidence level for the normal distribution is with the coverage factor $k = 3, U=0.01\text{ppm}$.

Test Results

Refer to the section 6.5 of this report for test data.

5.6 Spurious Emissions at Antenna Terminals

Ambient condition

Temperature	Relative humidity	Pressure
23°C ~25°C	45%~50%	101.5kPa

Method of Measurement

The EUT was connected to Spectrum Analyzer and Base Station Simulator via power Splitter. The measurement is carried out using a spectrum analyzer. The spectrum analyzer scans from 9kHz to the 10th harmonic of the carrier. The peak detector is used.

RBW is set to 100kHz, VBW is set to 300kHz for 30MHz~1GHz

RBW is set to 1MHz, VBW is set to 3MHz for above 1GHz, Sweep is set to ATUO.

RBW is set to 1 kHz (0.009MHz~ 0.15 MHz),

RBW is set to 10 kHz (0.15 MHz~ 30 MHz)

RBW is set to 100 kHz (30MHz~1000 MHz)

RBW is set to 1000 kHz (above 1000MHz)

Of those disturbances below (limit – 20 dB), the mark is not required for the EUT.

The modulation mode and RB allocation refer to section 5.1, using the maximum output power configuration.

Test setup

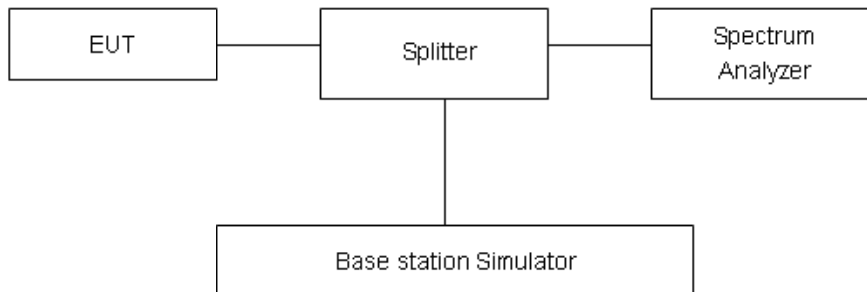

**Limits**

Rule Part 27.53(m) $55 + 10 \log (P)$ dB on all frequencies more than X megahertz from the channel edge, where X is the greater of 6 megahertz or the actual emission bandwidth as defined in paragraph (m)(4) of this section.

Part 27.53(m) Limit	-25 dBm
Part 27.53(a) Limit	-40 dBm

Measurement Uncertainty

The assessed measurement uncertainty to ensure 99.75% confidence level for the normal distribution is with the coverage factor $k = 1.96$.

Frequency	Uncertainty
9kHz-1GHz	0.684 dB
1GHz-30GHz	1.407 dB

Test Results

Refer to the section 6.6 of this report for test data.



5.7 Radiates Spurious Emission

Ambient condition

Temperature	Relative humidity	Pressure
23°C ~25°C	45%~50%	101.5kPa

Method of Measurement

- The testing follows FCC KDB 971168 D01 v03r01 Section 5.8 and ANSI C63.26 (2015).
- Below 1GHz: The EUT is placed on a turntable 0.8 meters above the ground in the chamber, 3 meter away from the antenna. The maximal emission value is acquired by adjusting the antenna height, polarisation and turntable azimuth. Normally, the height range of antenna is 1 m to 4 m, the azimuth range of turntable is 0° to 360°, and the receive antenna has two polarizations Vertical (V) and Horizontal (H). Above 1GHz: (Note: the FCC's permission to use 1.5m as an alternative per TCBC Conf call of Dec. 2, 2014.) The EUT is placed on a turntable 1.5 meters above the ground in the chamber, 3 meter away from the antenna. The maximal emission value is acquired by adjusting the antenna height, polarisation and turntable azimuth. Normally, the height range of antenna is 1 m to 4 m, the azimuth range of turntable is 0° to 360°, and the receive antenna has two polarizations Vertical (V) and Horizontal (H).
- A loop antenna, A log-periodic antenna or horn antenna shall be substituted in place of the EUT. The log-periodic antenna will be driven by a signal generator and the level will be adjusted till the same power value on the spectrum analyzer or receiver. The level of the spurious emissions can be calculated through the level of the signal generator, cable loss, the gain of the substitution antenna and the reading of the spectrum analyzer or receiver.
- The EUT is then put into continuously transmitting mode at its maximum power level during the test. Set Test Receiver or Spectrum RBW=100kHz, VBW=300kHz for 30MHz to 1GHz and RBW=1MHz, VBW=3MHz for above 1GHz, and the maximum value of the receiver should be recorded as (Pr).
- The EUT shall be replaced by a substitution antenna. In the chamber, an substitution antenna for the frequency band of interest is placed at the reference point of the chamber. An RF Signal source for the frequency band of interest is connected to the substitution antenna with a cable that has been constructed to not interfere with the radiation pattern of the antenna. A power (PMea) is applied to the input of the substitution antenna, and adjust the level of the signal generator output until the value of the receiver reach the previously recorded (Pr). The power of signal source (PMea) is recorded. The test should be performed by rotating the test item and adjusting the receiving antenna polarization.
- A amplifier should be connected to the Signal Source output port. And the cable should be connect between the Amplifier and the Substitution Antenna. The cable loss (Pcl) ,the Substitution Antenna Gain (Ga) and the Amplifier Gain (PAg) should be recorded after test.
- The measurement results are obtained as described below:

$$\text{Power(EIRP)} = \text{PMea} - \text{PAg} - \text{Pcl} + \text{Ga}$$
 The measurement results are amend as described below:

$$\text{Power(EIRP)} = \text{PMea} - \text{Pcl} + \text{Ga}$$
- This value is EIRP since the measurement is calibrated using an antenna of known gain (2.15 dB) and known input power. ERP can be calculated from EIRP by subtracting the gain of the dipole, $\text{ERP} = \text{EIRP} - 2.15\text{dB}$.

The modulation mode and RB allocation refer to section 5.1, using the maximum output power configuration.

Test setup

9KHz ~ 30MHz

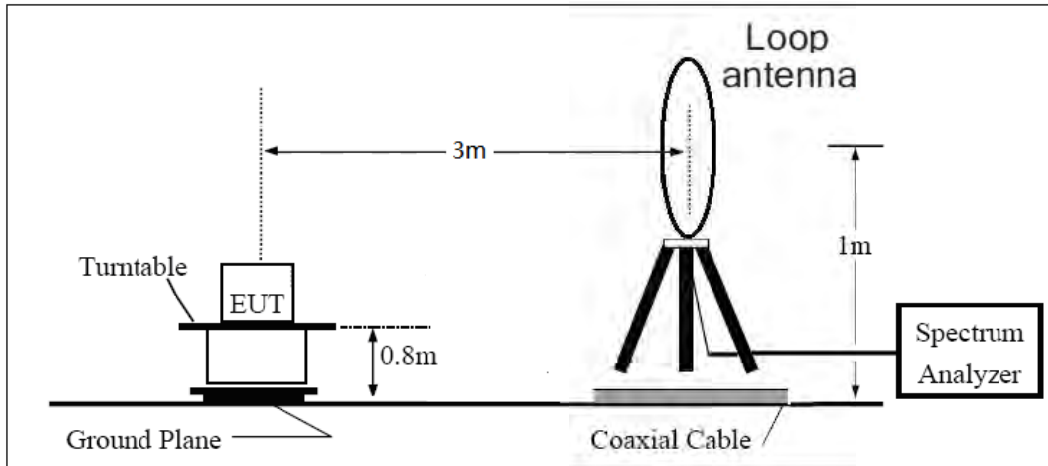

30MHz ~ 1GHz

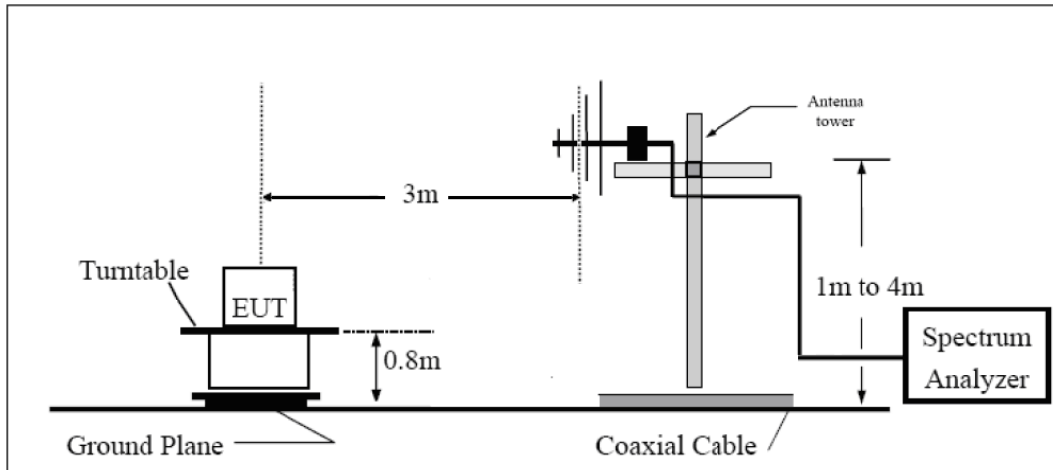

Above 1GHz

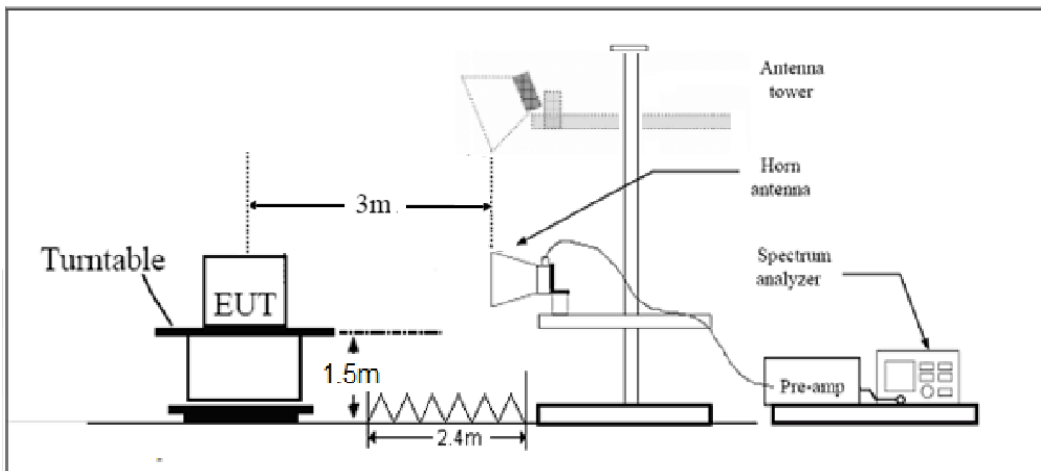

Note: Area side:2.4mX3.6m

**Limits**

Rule Part 27.53(m) $55 + 10 \log (P)$ dB on all frequencies more than X megahertz from the channel edge, where X is the greater of 6 megahertz or the actual emission bandwidth as defined in paragraph (m)(4) of this section.

Part 27.53(m) Limit	-25 dBm
---------------------	---------

Measurement Uncertainty

The assessed measurement uncertainty to ensure 95% confidence level for the normal distribution is with the coverage factor $k = \pm 1.96$, $U = \pm 3.55$ dB.

Test Results

Refer to the section 6.7 of this report for test data.



6 Test Results

6.1 RF Power Output and Effective Isotropic Radiated Power

LTE Band 7							
Bandwidth (MHz)	UL Channel	RB Size	RB Position	Modulation	Power (dBm)	EIRP (dBm)	Verdict
5	20775	1	#0	QPSK	22.08	25.58	PASS
5	20775	1	#Mid	QPSK	22.11	25.61	PASS
5	20775	1	#Max	QPSK	22.01	25.51	PASS
5	20775	12	#0	QPSK	21.38	24.88	PASS
5	20775	12	#Mid	QPSK	21.25	24.75	PASS
5	20775	12	#Max	QPSK	21.31	24.81	PASS
5	20775	25	#0	QPSK	21.42	24.92	PASS
5	20775	1	#0	QAM16	21.77	25.27	PASS
5	20775	1	#Mid	QAM16	21.69	25.19	PASS
5	20775	1	#Max	QAM16	21.57	25.07	PASS
5	20775	12	#0	QAM16	19.97	23.47	PASS
5	20775	12	#Mid	QAM16	19.97	23.47	PASS
5	20775	12	#Max	QAM16	19.93	23.43	PASS
5	20775	25	#0	QAM16	20.20	23.70	PASS
5	21100	1	#0	QPSK	21.85	25.35	PASS
5	21100	1	#Mid	QPSK	21.78	25.28	PASS
5	21100	1	#Max	QPSK	21.64	25.14	PASS
5	21100	12	#0	QPSK	20.62	24.12	PASS
5	21100	12	#Mid	QPSK	20.73	24.23	PASS
5	21100	12	#Max	QPSK	20.69	24.19	PASS
5	21100	25	#0	QPSK	20.74	24.24	PASS
5	21100	1	#0	QAM16	20.79	24.29	PASS
5	21100	1	#Mid	QAM16	20.93	24.43	PASS
5	21100	1	#Max	QAM16	20.52	24.02	PASS
5	21100	12	#0	QAM16	19.55	23.05	PASS
5	21100	12	#Mid	QAM16	19.70	23.20	PASS
5	21100	12	#Max	QAM16	19.68	23.18	PASS
5	21100	25	#0	QAM16	19.78	23.28	PASS
5	21425	1	#0	QPSK	21.40	24.90	PASS
5	21425	1	#Mid	QPSK	21.43	24.93	PASS
5	21425	1	#Max	QPSK	21.54	25.04	PASS
5	21425	12	#0	QPSK	20.61	24.11	PASS
5	21425	12	#Mid	QPSK	20.59	24.09	PASS
5	21425	12	#Max	QPSK	20.50	24.00	PASS



5	21425	25	#0	QPSK	20.58	24.08	PASS
5	21425	1	#0	QAM16	20.60	24.10	PASS
5	21425	1	#Mid	QAM16	20.62	24.12	PASS
5	21425	1	#Max	QAM16	20.21	23.71	PASS
5	21425	12	#0	QAM16	19.61	23.11	PASS
5	21425	12	#Mid	QAM16	19.61	23.11	PASS
5	21425	12	#Max	QAM16	19.53	23.03	PASS
5	21425	25	#0	QAM16	19.64	23.14	PASS
10	20800	1	#0	QPSK	22.32	25.82	PASS
10	20800	1	#Mid	QPSK	22.19	25.69	PASS
10	20800	1	#Max	QPSK	22.23	25.73	PASS
10	20800	25	#0	QPSK	21.25	24.75	PASS
10	20800	25	#Mid	QPSK	21.10	24.60	PASS
10	20800	25	#Max	QPSK	21.18	24.68	PASS
10	20800	50	#0	QPSK	21.26	24.76	PASS
10	20800	1	#0	QAM16	21.18	24.68	PASS
10	20800	1	#Mid	QAM16	21.25	24.75	PASS
10	20800	1	#Max	QAM16	21.22	24.72	PASS
10	20800	25	#0	QAM16	20.17	23.67	PASS
10	20800	25	#Mid	QAM16	20.08	23.58	PASS
10	20800	25	#Max	QAM16	20.31	23.81	PASS
10	20800	50	#0	QAM16	20.12	23.62	PASS
10	21100	1	#0	QPSK	21.76	25.26	PASS
10	21100	1	#Mid	QPSK	21.72	25.22	PASS
10	21100	1	#Max	QPSK	21.79	25.29	PASS
10	21100	25	#0	QPSK	20.84	24.34	PASS
10	21100	25	#Mid	QPSK	20.85	24.35	PASS
10	21100	25	#Max	QPSK	20.76	24.26	PASS
10	21100	50	#0	QPSK	20.76	24.26	PASS
10	21100	1	#0	QAM16	21.54	25.04	PASS
10	21100	1	#Mid	QAM16	21.33	24.83	PASS
10	21100	1	#Max	QAM16	21.17	24.67	PASS
10	21100	25	#0	QAM16	19.90	23.40	PASS
10	21100	25	#Mid	QAM16	19.90	23.40	PASS
10	21100	25	#Max	QAM16	19.80	23.30	PASS
10	21100	50	#0	QAM16	19.69	23.19	PASS
10	21400	1	#0	QPSK	21.76	25.26	PASS
10	21400	1	#Mid	QPSK	22.02	25.52	PASS
10	21400	1	#Max	QPSK	21.77	25.27	PASS
10	21400	25	#0	QPSK	20.62	24.12	PASS
10	21400	25	#Mid	QPSK	20.56	24.06	PASS
10	21400	25	#Max	QPSK	20.47	23.97	PASS
10	21400	50	#0	QPSK	20.52	24.02	PASS



10	21400	1	#0	QAM16	20.63	24.13	PASS
10	21400	1	#Mid	QAM16	21.11	24.61	PASS
10	21400	1	#Max	QAM16	20.37	23.87	PASS
10	21400	25	#0	QAM16	19.68	23.18	PASS
10	21400	25	#Mid	QAM16	19.61	23.11	PASS
10	21400	25	#Max	QAM16	19.79	23.29	PASS
10	21400	50	#0	QAM16	19.62	23.12	PASS
15	20825	1	#0	QPSK	22.23	25.73	PASS
15	20825	1	#Mid	QPSK	22.08	25.58	PASS
15	20825	1	#Max	QPSK	21.99	25.49	PASS
15	20825	36	#0	QPSK	21.17	24.67	PASS
15	20825	36	#Mid	QPSK	21.14	24.64	PASS
15	20825	36	#Max	QPSK	20.95	24.45	PASS
15	20825	75	#0	QPSK	21.12	24.62	PASS
15	20825	1	#0	QAM16	21.07	24.57	PASS
15	20825	1	#Mid	QAM16	21.14	24.64	PASS
15	20825	1	#Max	QAM16	20.99	24.49	PASS
15	20825	36	#0	QAM16	20.15	23.65	PASS
15	20825	36	#Mid	QAM16	20.21	23.71	PASS
15	20825	36	#Max	QAM16	19.91	23.41	PASS
15	20825	75	#0	QAM16	20.16	23.66	PASS
15	21100	1	#0	QPSK	21.57	25.07	PASS
15	21100	1	#Mid	QPSK	21.57	25.07	PASS
15	21100	1	#Max	QPSK	21.58	25.08	PASS
15	21100	36	#0	QPSK	20.63	24.13	PASS
15	21100	36	#Mid	QPSK	20.71	24.21	PASS
15	21100	36	#Max	QPSK	20.57	24.07	PASS
15	21100	75	#0	QPSK	20.61	24.11	PASS
15	21100	1	#0	QAM16	20.70	24.20	PASS
15	21100	1	#Mid	QAM16	21.14	24.64	PASS
15	21100	1	#Max	QAM16	21.18	24.68	PASS
15	21100	36	#0	QAM16	19.84	23.34	PASS
15	21100	36	#Mid	QAM16	19.67	23.17	PASS
15	21100	36	#Max	QAM16	19.67	23.17	PASS
15	21100	75	#0	QAM16	19.50	23.00	PASS
15	21375	1	#0	QPSK	21.65	25.15	PASS
15	21375	1	#Mid	QPSK	21.50	25.00	PASS
15	21375	1	#Max	QPSK	21.44	24.94	PASS
15	21375	36	#0	QPSK	20.48	23.98	PASS
15	21375	36	#Mid	QPSK	20.36	23.86	PASS
15	21375	36	#Max	QPSK	20.46	23.96	PASS
15	21375	75	#0	QPSK	20.44	23.94	PASS
15	21375	1	#0	QAM16	20.25	23.75	PASS



15	21375	1	#Mid	QAM16	20.13	23.63	PASS
15	21375	1	#Max	QAM16	19.42	22.92	PASS
15	21375	36	#0	QAM16	19.65	23.15	PASS
15	21375	36	#Mid	QAM16	19.65	23.15	PASS
15	21375	36	#Max	QAM16	19.43	22.93	PASS
15	21375	75	#0	QAM16	19.50	23.00	PASS
20	20850	1	#0	QPSK	21.97	25.47	PASS
20	20850	1	#Mid	QPSK	22.29	25.79	PASS
20	20850	1	#Max	QPSK	21.86	25.36	PASS
20	20850	50	#0	QPSK	20.94	24.44	PASS
20	20850	50	#Mid	QPSK	20.90	24.40	PASS
20	20850	50	#Max	QPSK	20.82	24.32	PASS
20	20850	100	#0	QPSK	20.76	24.26	PASS
20	20850	1	#0	QAM16	21.25	24.75	PASS
20	20850	1	#Mid	QAM16	21.51	25.01	PASS
20	20850	1	#Max	QAM16	20.90	24.40	PASS
20	20850	50	#0	QAM16	20.06	23.56	PASS
20	20850	50	#Mid	QAM16	20.17	23.67	PASS
20	20850	50	#Max	QAM16	19.96	23.46	PASS
20	20850	100	#0	QAM16	19.91	23.41	PASS
20	21100	1	#0	QPSK	21.63	25.13	PASS
20	21100	1	#Mid	QPSK	22.01	25.51	PASS
20	21100	1	#Max	QPSK	21.77	25.27	PASS
20	21100	50	#0	QPSK	20.59	24.09	PASS
20	21100	50	#Mid	QPSK	20.57	24.07	PASS
20	21100	50	#Max	QPSK	20.54	24.04	PASS
20	21100	100	#0	QPSK	20.59	24.09	PASS
20	21100	1	#0	QAM16	20.16	23.66	PASS
20	21100	1	#Mid	QAM16	20.29	23.79	PASS
20	21100	1	#Max	QAM16	19.93	23.43	PASS
20	21100	50	#0	QAM16	19.66	23.16	PASS
20	21100	50	#Mid	QAM16	19.59	23.09	PASS
20	21100	50	#Max	QAM16	19.65	23.15	PASS
20	21100	100	#0	QAM16	19.55	23.05	PASS
20	21350	1	#0	QPSK	21.61	25.11	PASS
20	21350	1	#Mid	QPSK	21.55	25.05	PASS
20	21350	1	#Max	QPSK	21.37	24.87	PASS
20	21350	50	#0	QPSK	20.49	23.99	PASS
20	21350	50	#Mid	QPSK	20.47	23.97	PASS
20	21350	50	#Max	QPSK	20.41	23.91	PASS
20	21350	100	#0	QPSK	20.36	23.86	PASS
20	21350	1	#0	QAM16	20.42	23.92	PASS
20	21350	1	#Mid	QAM16	20.98	24.48	PASS



20	21350	1	#Max	QAM16	20.39	23.89	PASS
20	21350	50	#0	QAM16	19.62	23.12	PASS
20	21350	50	#Mid	QAM16	19.66	23.16	PASS
20	21350	50	#Max	QAM16	19.42	22.92	PASS
20	21350	100	#0	QAM16	19.50	23.00	PASS

LTE Band 40 Subset 1							
Bandwidth (MHz)	UL Channel	RB Size	RB Position	Modulation	Power (dBm)	EIRP (dBm)	Verdict
5	38725	1	#0	QPSK	21.66	25.16	PASS
5	38725	1	#Mid	QPSK	21.58	25.08	PASS
5	38725	1	#Max	QPSK	21.51	25.01	PASS
5	38725	12	#0	QPSK	20.88	24.38	PASS
5	38725	12	#Mid	QPSK	20.90	24.40	PASS
5	38725	12	#Max	QPSK	20.83	24.33	PASS
5	38725	25	#0	QPSK	20.86	24.36	PASS
5	38725	1	#0	QAM16	20.80	24.30	PASS
5	38725	1	#Mid	QAM16	20.86	24.36	PASS
5	38725	1	#Max	QAM16	20.55	24.05	PASS
5	38725	12	#0	QAM16	19.87	23.37	PASS
5	38725	12	#Mid	QAM16	19.88	23.38	PASS
5	38725	12	#Max	QAM16	19.74	23.24	PASS
5	38725	25	#0	QAM16	19.89	23.39	PASS
5	38750	1	#0	QPSK	21.61	25.11	PASS
5	38750	1	#Mid	QPSK	21.55	25.05	PASS
5	38750	1	#Max	QPSK	21.36	24.86	PASS
5	38750	12	#0	QPSK	20.87	24.37	PASS
5	38750	12	#Mid	QPSK	20.89	24.39	PASS
5	38750	12	#Max	QPSK	20.79	24.29	PASS
5	38750	25	#0	QPSK	20.88	24.38	PASS
5	38750	1	#0	QAM16	21.27	24.77	PASS
5	38750	1	#Mid	QAM16	21.16	24.66	PASS
5	38750	1	#Max	QAM16	21.40	24.90	PASS
5	38750	12	#0	QAM16	19.85	23.35	PASS
5	38750	12	#Mid	QAM16	19.88	23.38	PASS
5	38750	12	#Max	QAM16	19.70	23.20	PASS
5	38750	25	#0	QAM16	19.87	23.37	PASS
5	38775	1	#0	QPSK	21.66	25.16	PASS
5	38775	1	#Mid	QPSK	21.66	25.16	PASS
5	38775	1	#Max	QPSK	21.59	25.09	PASS
5	38775	12	#0	QPSK	20.97	24.47	PASS
5	38775	12	#Mid	QPSK	20.98	24.48	PASS
5	38775	12	#Max	QPSK	20.88	24.38	PASS



5	38775	25	#0	QPSK	21.03	24.53	PASS
5	38775	1	#0	QAM16	21.26	24.76	PASS
5	38775	1	#Mid	QAM16	21.14	24.64	PASS
5	38775	1	#Max	QAM16	21.20	24.70	PASS
5	38775	12	#0	QAM16	19.83	23.33	PASS
5	38775	12	#Mid	QAM16	19.85	23.35	PASS
5	38775	12	#Max	QAM16	19.75	23.25	PASS
5	38775	25	#0	QAM16	19.95	23.45	PASS
10	38750	1	#0	QPSK	21.88	25.38	PASS
10	38750	1	#Mid	QPSK	21.85	25.35	PASS
10	38750	1	#Max	QPSK	21.90	25.40	PASS
10	38750	25	#0	QPSK	21.11	24.61	PASS
10	38750	25	#Mid	QPSK	21.13	24.63	PASS
10	38750	25	#Max	QPSK	21.00	24.50	PASS
10	38750	50	#0	QPSK	21.11	24.61	PASS
10	38750	1	#0	QAM16	20.90	24.40	PASS
10	38750	1	#Mid	QAM16	21.19	24.69	PASS
10	38750	1	#Max	QAM16	20.63	24.13	PASS
10	38750	25	#0	QAM16	20.07	23.57	PASS
10	38750	25	#Mid	QAM16	20.08	23.58	PASS
10	38750	25	#Max	QAM16	20.19	23.69	PASS
10	38750	50	#0	QAM16	20.12	23.62	PASS

LTE Band 40 Subset 2							
Bandwidth (MHz)	UL Channel	RB Size	RB Position	Modulation	Power (dBm)	EIRP (dBm)	Verdict
5	39175	1	#0	QPSK	21.19	24.69	PASS
5	39175	1	#Mid	QPSK	21.36	24.86	PASS
5	39175	1	#Max	QPSK	21.25	24.75	PASS
5	39175	12	#0	QPSK	20.35	23.85	PASS
5	39175	12	#Mid	QPSK	20.35	23.85	PASS
5	39175	12	#Max	QPSK	20.42	23.92	PASS
5	39175	25	#0	QPSK	20.43	23.93	PASS
5	39175	1	#0	QAM16	20.43	23.93	PASS
5	39175	1	#Mid	QAM16	20.48	23.98	PASS
5	39175	1	#Max	QAM16	20.36	23.86	PASS
5	39175	12	#0	QAM16	19.15	22.65	PASS
5	39175	12	#Mid	QAM16	19.15	22.65	PASS
5	39175	12	#Max	QAM16	19.14	22.64	PASS
5	39175	25	#0	QAM16	19.16	22.66	PASS
5	39200	1	#0	QPSK	21.16	24.66	PASS
5	39200	1	#Mid	QPSK	21.27	24.77	PASS
5	39200	1	#Max	QPSK	21.21	24.71	PASS



5	39200	12	#0	QPSK	20.44	23.94	PASS
5	39200	12	#Mid	QPSK	20.44	23.94	PASS
5	39200	12	#Max	QPSK	20.46	23.96	PASS
5	39200	25	#0	QPSK	20.32	23.82	PASS
5	39200	1	#0	QAM16	20.02	23.52	PASS
5	39200	1	#Mid	QAM16	20.18	23.68	PASS
5	39200	1	#Max	QAM16	20.09	23.59	PASS
5	39200	12	#0	QAM16	19.23	22.73	PASS
5	39200	12	#Mid	QAM16	19.23	22.73	PASS
5	39200	12	#Max	QAM16	19.24	22.74	PASS
5	39200	25	#0	QAM16	19.43	22.93	PASS
5	39225	1	#0	QPSK	21.14	24.64	PASS
5	39225	1	#Mid	QPSK	21.36	24.86	PASS
5	39225	1	#Max	QPSK	21.12	24.62	PASS
5	39225	12	#0	QPSK	20.60	24.10	PASS
5	39225	12	#Mid	QPSK	20.54	24.04	PASS
5	39225	12	#Max	QPSK	20.42	23.92	PASS
5	39225	25	#0	QPSK	20.51	24.01	PASS
5	39225	1	#0	QAM16	20.83	24.33	PASS
5	39225	1	#Mid	QAM16	21.04	24.54	PASS
5	39225	1	#Max	QAM16	20.78	24.28	PASS
5	39225	12	#0	QAM16	19.46	22.96	PASS
5	39225	12	#Mid	QAM16	19.36	22.86	PASS
5	39225	12	#Max	QAM16	19.19	22.69	PASS
5	39225	25	#0	QAM16	19.38	22.88	PASS
10	39200	1	#0	QPSK	21.40	24.90	PASS
10	39200	1	#Mid	QPSK	21.47	24.97	PASS
10	39200	1	#Max	QPSK	21.53	25.03	PASS
10	39200	25	#0	QPSK	20.38	23.88	PASS
10	39200	25	#Mid	QPSK	20.35	23.85	PASS
10	39200	25	#Max	QPSK	20.46	23.96	PASS
10	39200	50	#0	QPSK	20.44	23.94	PASS
10	39200	1	#0	QAM16	20.26	23.76	PASS
10	39200	1	#Mid	QAM16	20.44	23.94	PASS
10	39200	1	#Max	QAM16	20.27	23.77	PASS
10	39200	25	#0	QAM16	19.42	22.92	PASS
10	39200	25	#Mid	QAM16	19.32	22.82	PASS
10	39200	25	#Max	QAM16	19.35	22.85	PASS
10	39200	50	#0	QAM16	19.40	22.90	PASS

**EIRP and Duty Cycle for LTE Band 40**

Band	RB	Modulation	Bandwidth (MHz)	Channel	Frequency (MHz)	Duty Cycle
LTE Band 40 Subset 1	100%	QPSK	5	38725	2307.5	29.99%
				38750	2310	30.05%
				38775	2312.5	30.05%
			10	38750	2310	30.06%
		16QAM	5	38725	2307.5	29.99%
				38750	2310	30.00%
				38775	2312.5	30.05%
			10	38750	2310	29.99%

Band	RB	Modulation	Bandwidth (MHz)	Channel	Frequency (MHz)	Duty Cycle
LTE Band 40 Subset 2	100%	QPSK	5	39175	2352.5	30.05%
				39200	2355	30.00%
				39225	2357.5	30.06%
			10	39200	2355	29.99%
		16QAM	5	39175	2352.5	30.06%
				39200	2355	30.06%
				39225	2357.5	30.05%
			10	39200	2355	30.00%

Duty Cycle

LTE Band 40 Subset 1 QPSK 5MHz CH-Low

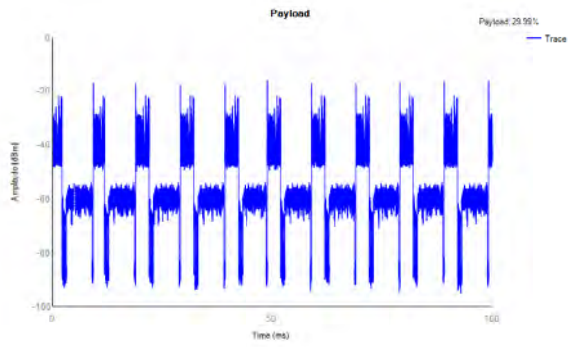

LTE Band 40 Subset 1 QPSK 10MHz

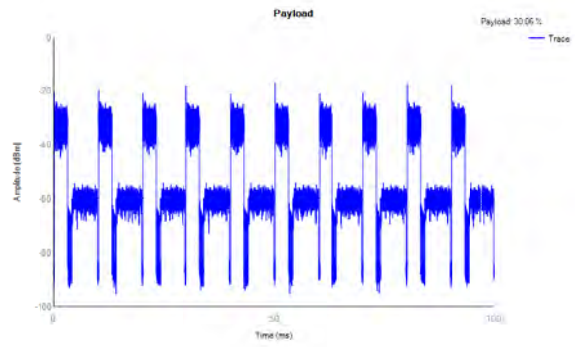

LTE Band 40 Subset 1 QPSK 5MHz CH-Middle

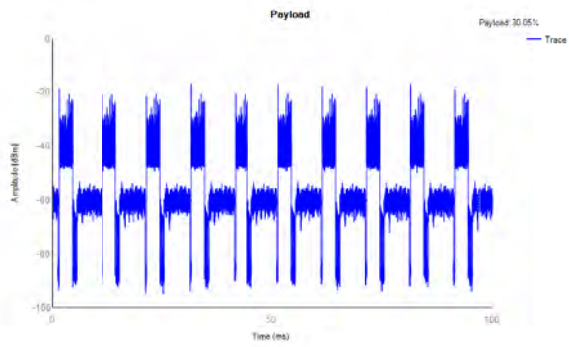

LTE Band 40 Subset 1 QPSK 5MHz CH-High

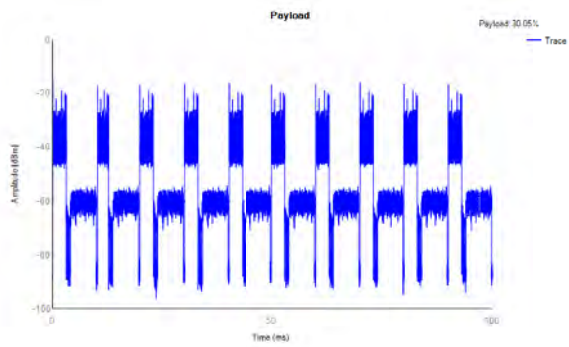

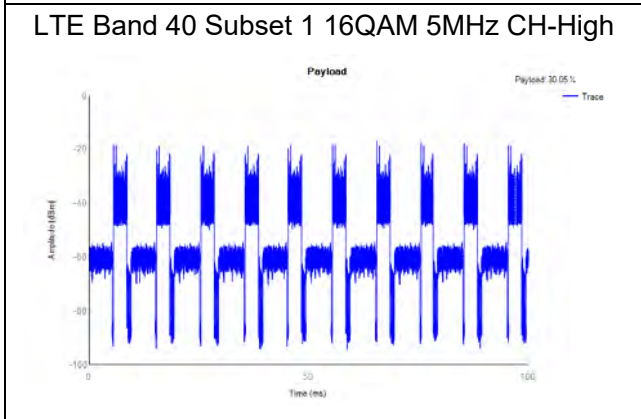
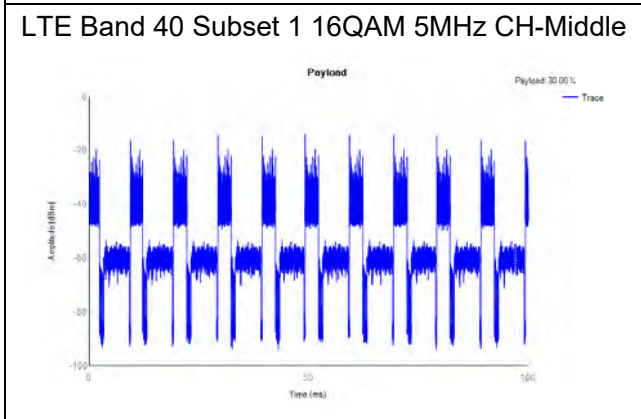
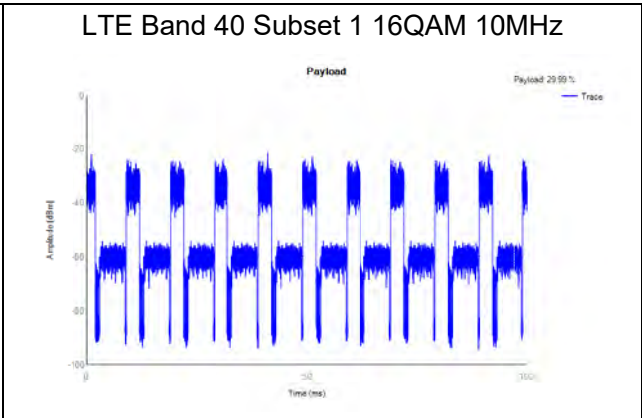
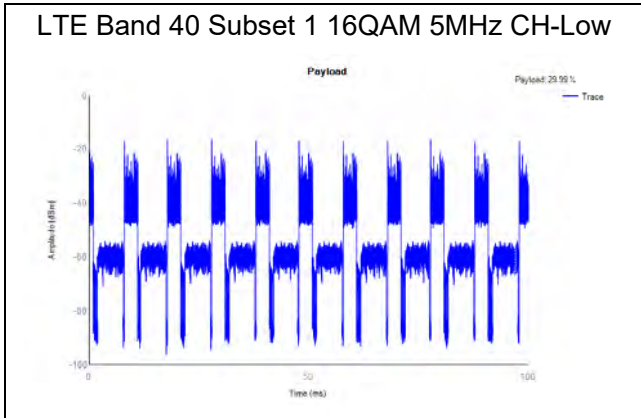

LTE Band 40 Subset 2 QPSK 5MHz CH-Low

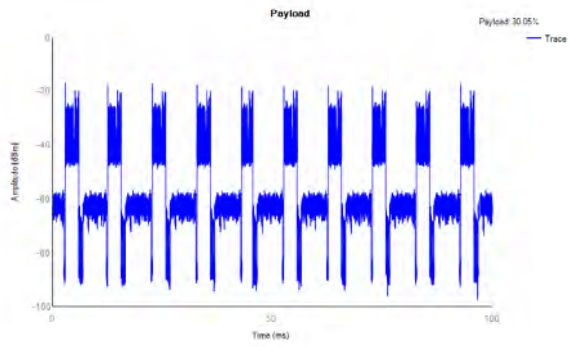

LTE Band 40 Subset 2 QPSK 10MHz

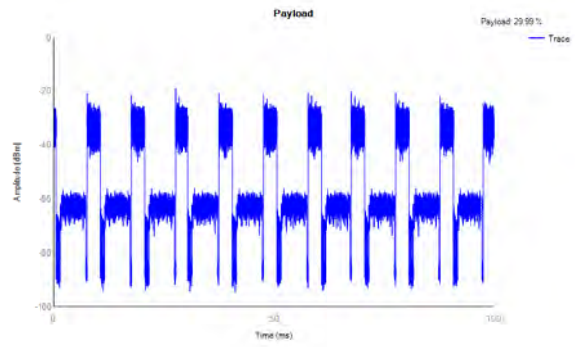

LTE Band 40 Subset 2 QPSK 5MHz CH-Middle

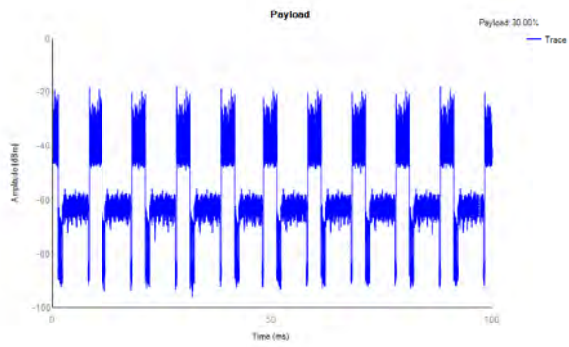

LTE Band 40 Subset 2 QPSK 5MHz CH-High

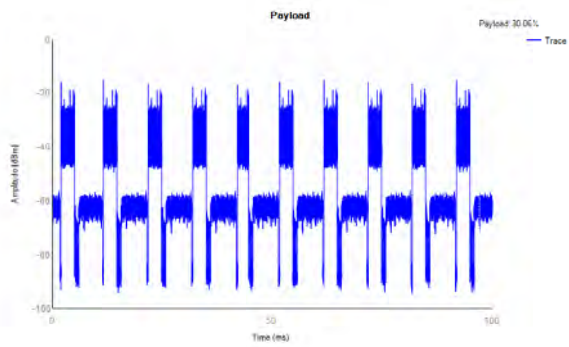

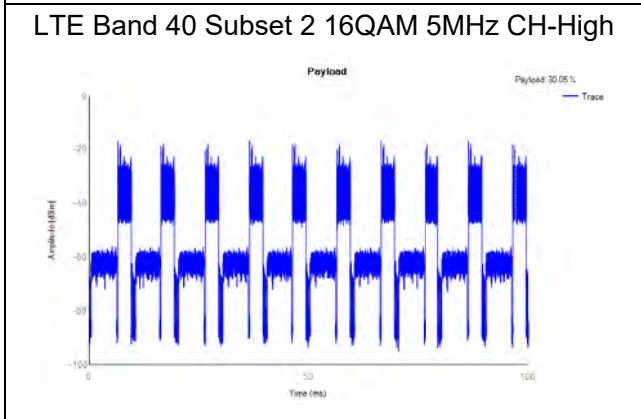
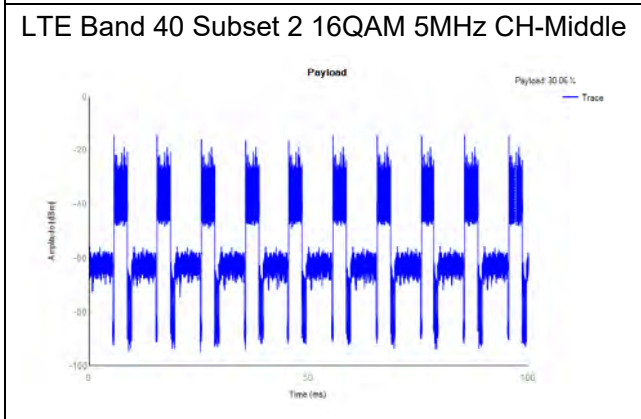
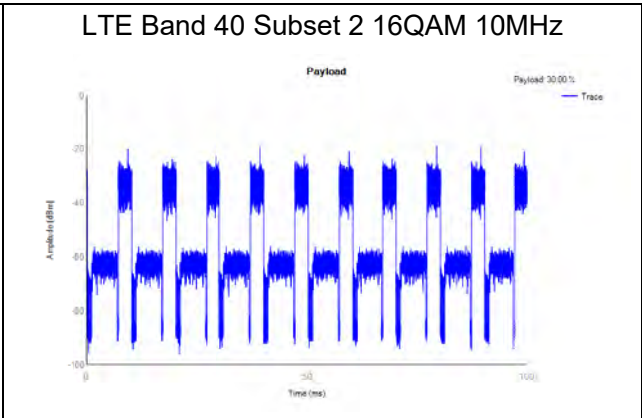
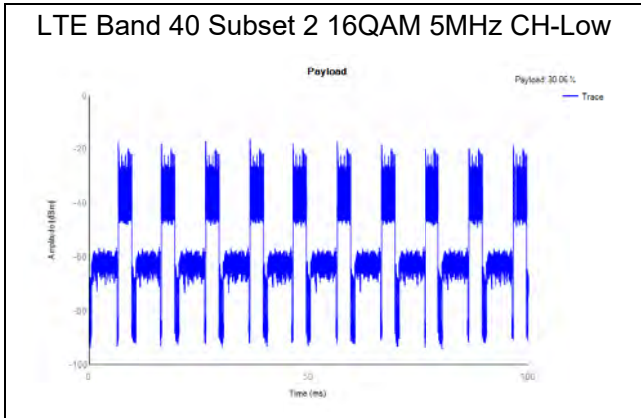



LTE Band 40 Subset 1				Conducted Power (dBm/MHz)			EIRP Power (dBm/MHz)			EIRP Power (mW/MHz)			Limit (mW /MHz)
BW	Modulation	RB size	RB offset	Channel/Frequency (MHz)			Channel/Frequency (MHz)			Channel/Frequency (MHz)			
				38725/2307.5	38750/2310	38775/2312.5	38725/2307.5	38750/2310	38775/2312.5	38725/2307.5	38750/2310	38775/2312.5	
5MHz	QPSK	25	0	16.487	16.907	17.403	19.987	20.407	20.903	99.701	109.825	123.112	250
	16QAM	25	0	16.471	15.368	16.291	19.971	18.868	19.791	99.335	77.055	95.302	250
BW	Modulation	RB size	RB offset	Channel/Frequency (MHz)			Channel/Frequency (MHz)			Channel/Frequency (MHz)			Limit (mW /MHz)
				38750/2310			38750/2310			38750/2310			
10MHz	QPSK	50	0	14.087			17.587			57.3720			250
	16QAM	50	0	13.451			16.951			49.5564			250

LTE Band 40 Subset 1				Conducted Power (dBm/5MHz)			EIRP Power (dBm/5MHz)			EIRP Power (mW/5MHz)			Limit (mW /5MHz)
BW	Modulation	RB size	RB offset	Channel/Frequency (MHz)			Channel/Frequency (MHz)			Channel/Frequency (MHz)			
				38725/2307.5	38750/2310	38775/2312.5	38725/2307.5	38750/2310	38775/2312.5	38725/2307.5	38750/2310	38775/2312.5	
5MHz	QPSK	25	0	19.790	19.939	19.902	23.290	23.439	23.402	213.305	220.750	218.877	250
	16QAM	25	0	19.812	19.926	19.779	23.312	23.426	23.279	214.388	220.090	212.765	250
BW	Modulation	RB size	RB offset	Channel/Frequency (MHz)			Channel/Frequency (MHz)			Channel/Frequency (MHz)			Limit (mW /5MHz)
				38750/2310			38750/2310			38750/2310			
10MHz	QPSK	50	0	18.352			21.852			153.179			250
	16QAM	50	0	17.851			21.351			136.490			250



LTE Band 40 Subset 2				Conducted Power (dBm/MHz)			EIRP Power (dBm/MHz)			EIRP Power (mW/MHz)			Limit (mW /MHz)
BW	Modulation	RB size	RB offset	Channel/Frequency (MHz)			Channel/Frequency (MHz)			Channel/Frequency (MHz)			
				38725/2307.5	38750/2310	38775/2312.5	38725/2307.5	38750/2310	38775/2312.5	38725/2307.5	38750/2310	38775/2312.5	
5MHz	QPSK	25	0	18.029	18.265	18.873	21.529	21.765	22.373	142.200	150.141	172.703	250
	16QAM	25	0	18.202	17.116	18.204	21.702	20.616	21.704	147.979	115.239	148.047	250
BW	Modulation	RB size	RB offset	Channel/Frequency (MHz)			Channel/Frequency (MHz)			Channel/Frequency (MHz)			Limit (mW /MHz)
				38750/2310			38750/2310			38750/2310			
10MHz	QPSK	50	0	17.108			20.608			115.027			250
	16QAM	50	0	16.671			20.171			104.016			250

LTE Band 40 Subset 2				Conducted Power (dBm/5MHz)			EIRP Power (dBm/5MHz)			EIRP Power (mW/5MHz)			Limit (mW /5MHz)
BW	Modulation	RB size	RB offset	Channel/Frequency (MHz)			Channel/Frequency (MHz)			Channel/Frequency (MHz)			
				38725/2307.5	38750/2310	38775/2312.5	38725/2307.5	38750/2310	38775/2312.5	38725/2307.5	38750/2310	38775/2312.5	
5MHz	QPSK	25	0	20.183	20.378	20.329	23.683	23.878	23.829	233.507	244.231	241.491	250
	16QAM	25	0	20.337	20.140	20.262	23.837	23.640	23.762	241.936	231.207	237.794	250
BW	Modulation	RB size	RB offset	Channel/Frequency (MHz)			Channel/Frequency (MHz)			Channel/Frequency (MHz)			Limit (mW /5MHz)
				38750/2310			38750/2310			38750/2310			
10MHz	QPSK	50	0	18.795			22.295			169.629			250
	16QAM	50	0	18.265			21.765			150.141			250



EIRP (dBm/1MHz)

LTE Band 40 Subset 1 QPSK 5MHz CH-Low

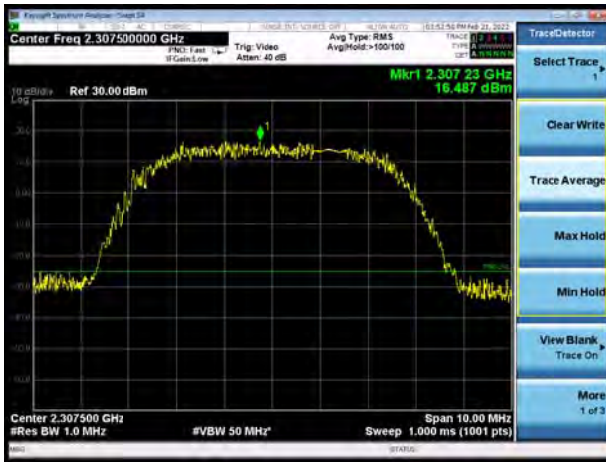

LTE Band 40 Subset 1 QPSK 10MHz

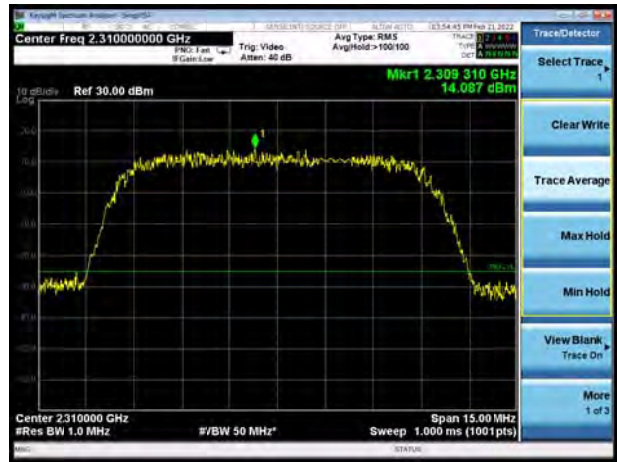

LTE Band 40 Subset 1 QPSK 5MHz CH-Middle

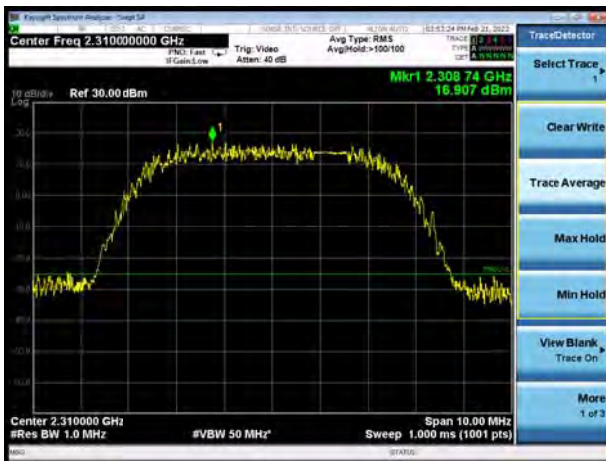

LTE Band 40 Subset 1 QPSK 5MHz CH-High

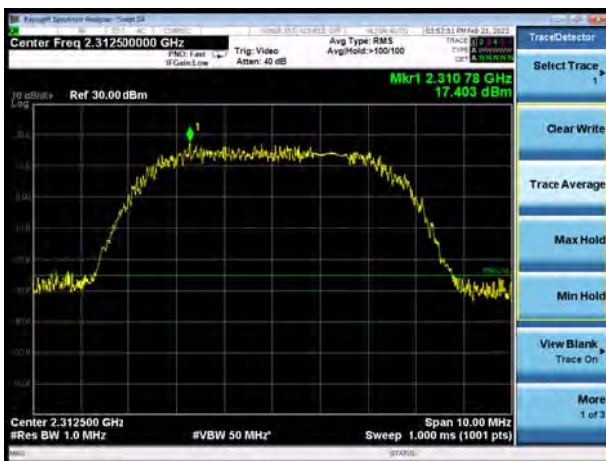



LTE Band 40 Subset 1 16QAM 5MHz CH-Low

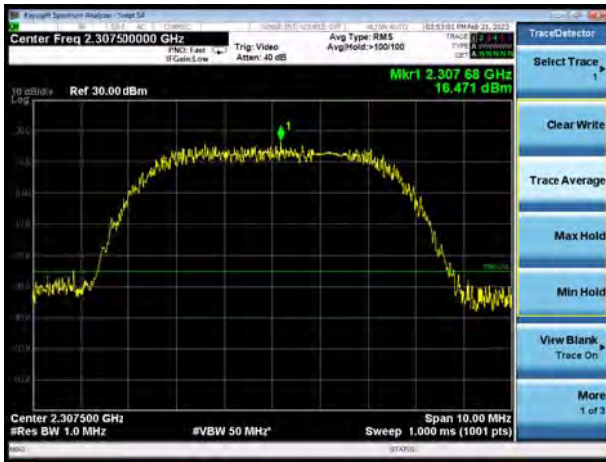

LTE Band 40 Subset 1 16QAM 10MHz

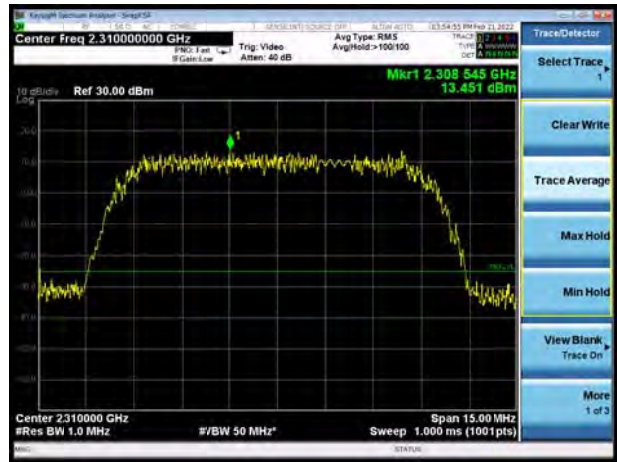

LTE Band 40 Subset 1 16QAM 5MHz CH-Middle

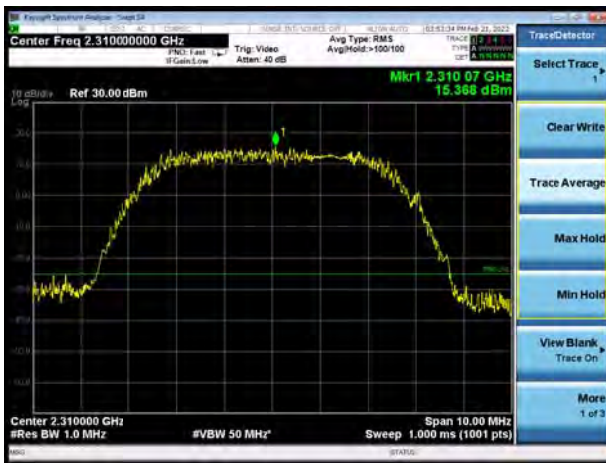

LTE Band 40 Subset 1 16QAM 5MHz CH-High





EIRP (dBm/5MHz)

LTE Band 40 Subset 1 QPSK 5MHz CH-Low

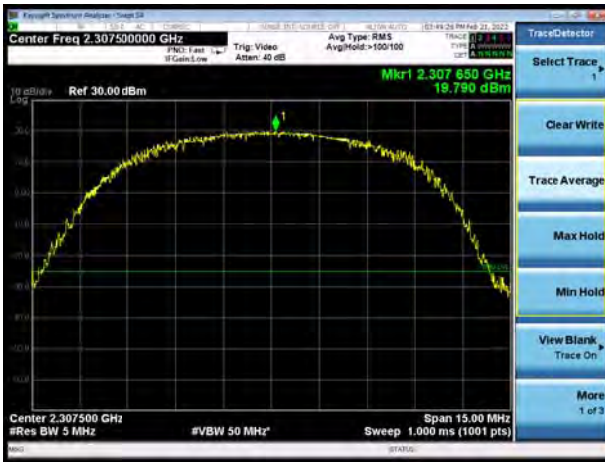

LTE Band 40 Subset 1 QPSK 10MHz



LTE Band 40 Subset 1 QPSK 5MHz CH-Middle

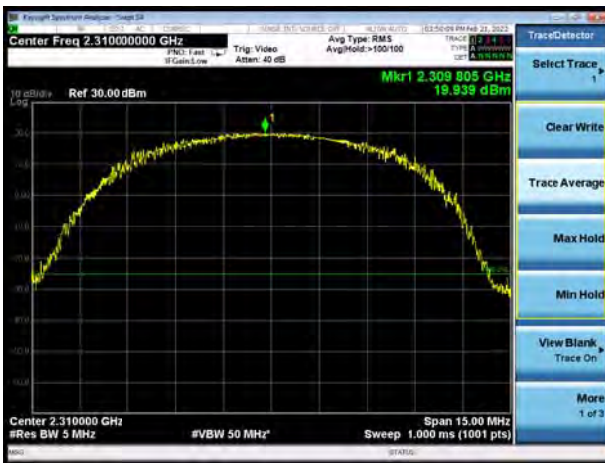

LTE Band 40 Subset 1 QPSK 5MHz CH-High





LTE Band 40 Subset 1 16QAM 5MHz CH-Low



LTE Band 40 Subset 1 16QAM 10MHz

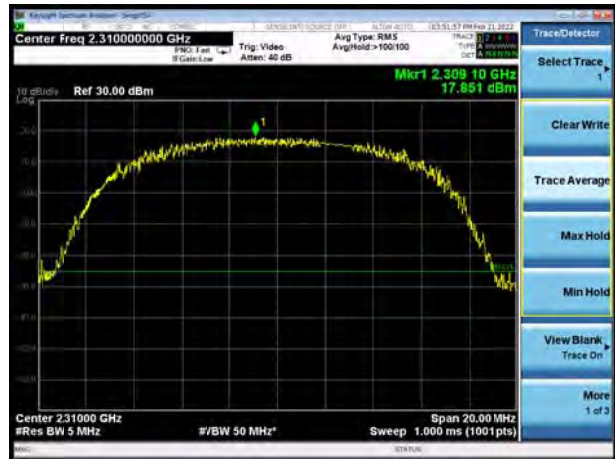

LTE Band 40 Subset 1 16QAM 5MHz CH-Middle

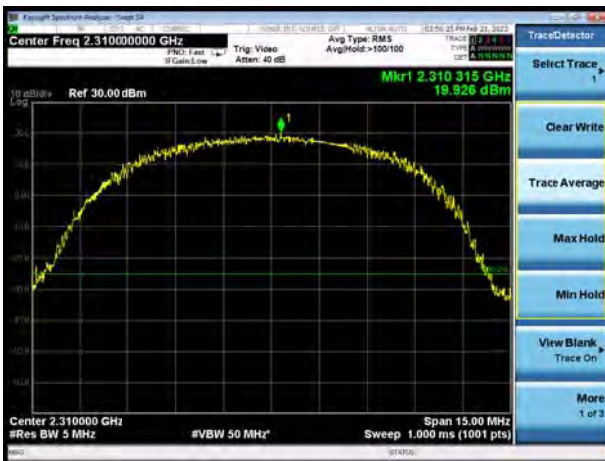

LTE Band 40 Subset 1 16QAM 5MHz CH-High

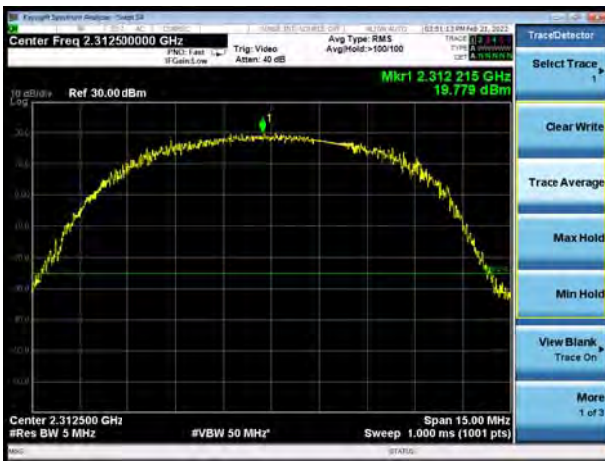

EIRP (dBm/1MHz)

LTE Band 40 Subset 2 QPSK 5MHz CH-Low



LTE Band 40 Subset 2 QPSK 10MHz



LTE Band 40 Subset 2 QPSK 5MHz CH-Middle

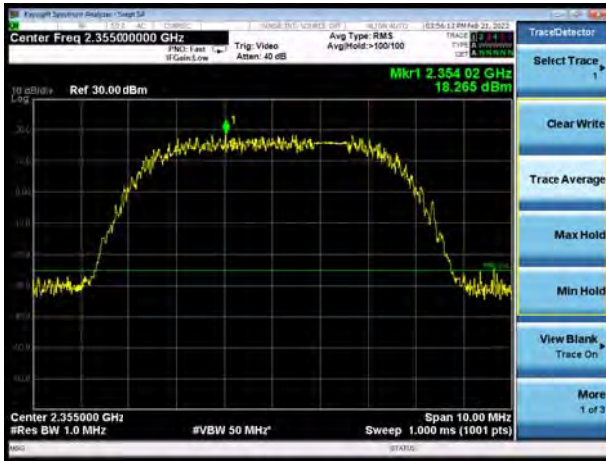

LTE Band 40 Subset 2 QPSK 5MHz CH-High





LTE Band 40 Subset 2 16QAM 5MHz CH-Low

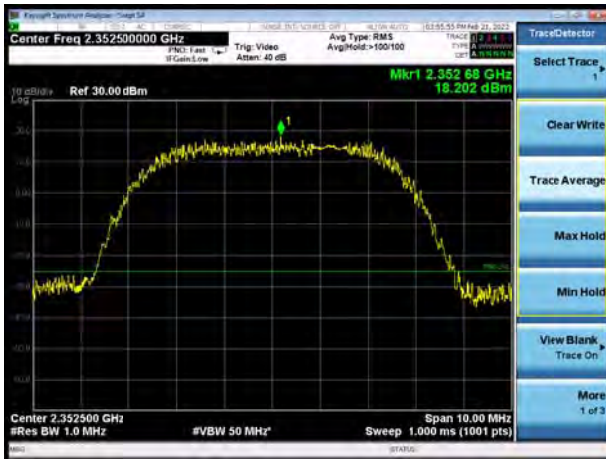

LTE Band 40 Subset 2 16QAM 10MHz

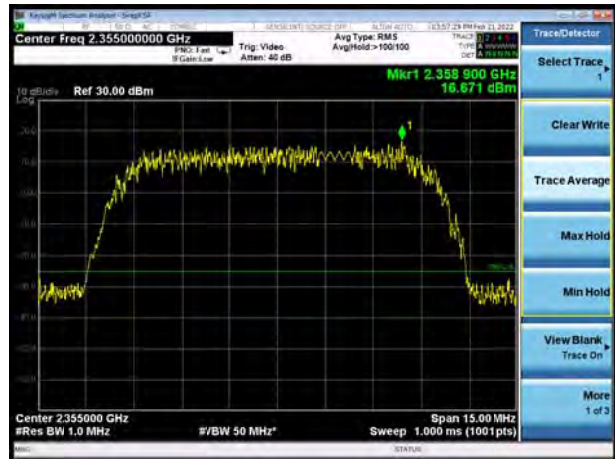

LTE Band 40 Subset 2 16QAM 5MHz CH-Middle

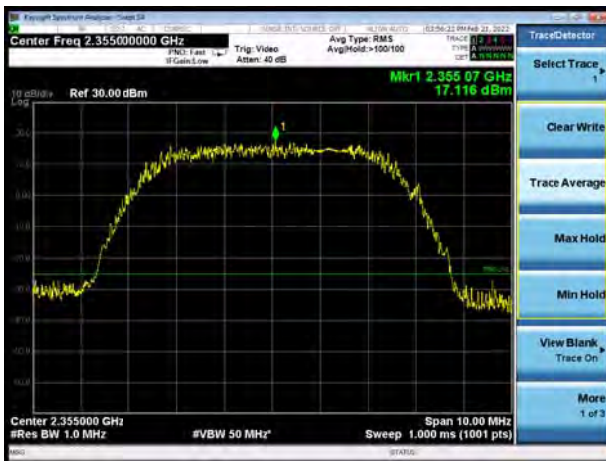

LTE Band 40 Subset 2 16QAM 5MHz CH-High



EIRP (dBm/5MHz)

LTE Band 40 Subset 2 QPSK 5MHz CH-Low



LTE Band 40 Subset 2 QPSK 10MHz

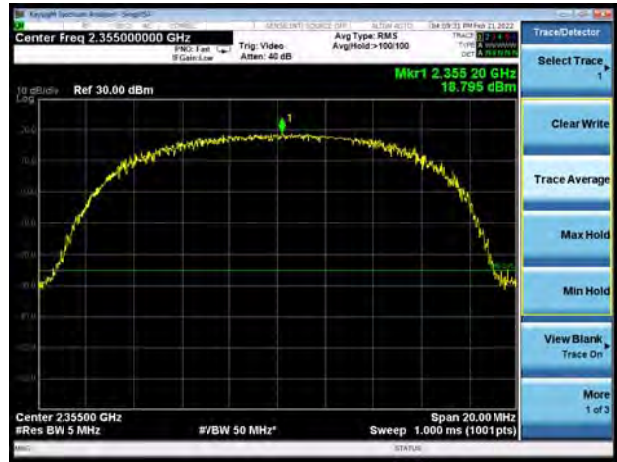

LTE Band 40 Subset 2 QPSK 5MHz CH-Middle

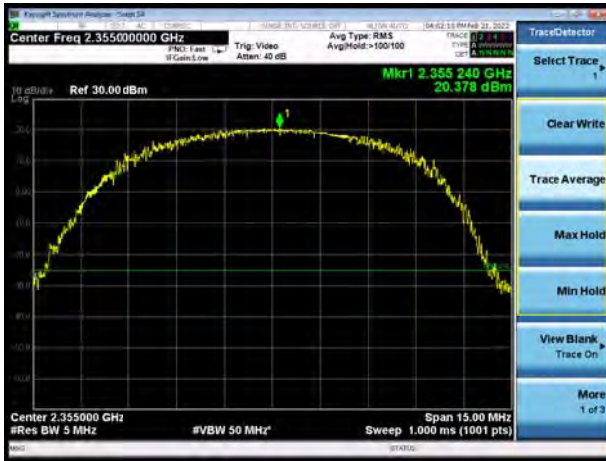

LTE Band 40 Subset 2 QPSK 5MHz CH-High



LTE Band 40 Subset 2 16QAM 5MHz CH-Low

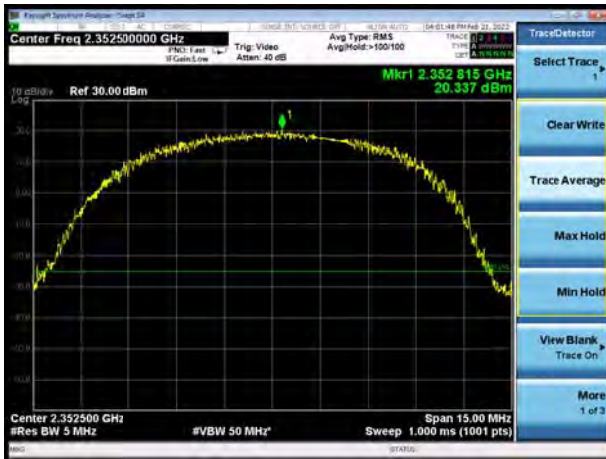

LTE Band 40 Subset 2 16QAM 10MHz

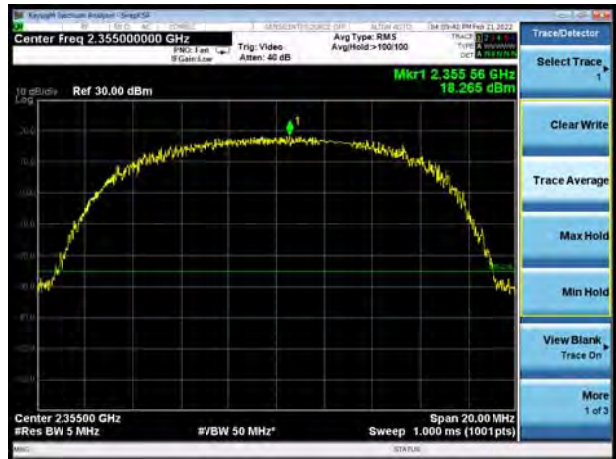

LTE Band 40 Subset 2 16QAM 5MHz CH-Middle

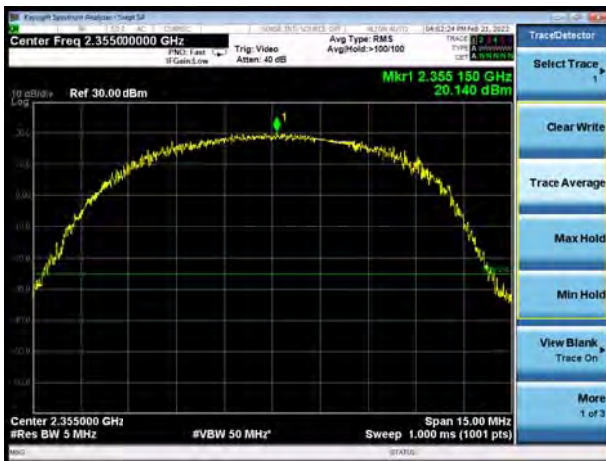

LTE Band 40 Subset 2 16QAM 5MHz CH-High





6.2 Occupied Bandwidth

LTE Band 7						
RB	Modulation	Bandwidth (MHz)	Channel	Frequency (MHz)	99% Power Bandwidth(MHz)	-26dBc Bandwidth(MHz)
100%	QPSK	5	20775	2502.5	4.516	4.964
			21100	2535	4.516	5.001
			21425	2567.5	4.509	5.022
		10	20800	2505	8.975	9.819
			21100	2535	8.945	9.702
			21400	2565	8.978	9.817
		15	20825	2507.5	13.461	14.463
			21100	2535	13.435	14.582
			21375	2562.5	13.422	14.584
		20	20850	2510	17.866	19.639
			21100	2535	17.859	19.467
			21350	2560	17.915	19.355
	16QAM	5	20775	2502.5	4.524	5.024
			21100	2535	4.506	4.945
			21425	2567.5	4.516	5.001
		10	20800	2505	8.979	9.875
			21100	2535	8.955	9.696
			21400	2565	8.974	9.678
		15	20825	2507.5	13.436	14.664
			21100	2535	13.424	14.598
			21375	2562.5	13.439	14.569
		20	20850	2510	17.918	19.341
			21100	2535	17.886	19.363
			21350	2560	17.877	19.155



LTE Band 40 Subset 1							
RB	Modulation	Bandwidth (MHz)	Channel	Frequency (MHz)	99% Power Bandwidth(MHz)	-26dBc Bandwidth(MHz)	
100%	QPSK	5	38725	2307.5	4.510	4.971	
			38750	2310	4.515	4.887	
			38775	2312.5	4.517	4.914	
	16QAM	10	5	38750	2310	8.966	10.000
				38725	2307.5	4.502	4.896
		5	38750	2310	4.492	4.969	
			38775	2312.5	4.494	4.955	
			10	38750	2310	8.973	9.732

LTE Band 40 Subset 2							
RB	Modulation	Bandwidth (MHz)	Channel	Frequency (MHz)	99% Power Bandwidth(MHz)	-26dBc Bandwidth(MHz)	
100%	QPSK	5	39175	2352.5	4.493	5.013	
			39200	2355	4.512	4.902	
			39225	2357.5	4.499	6.228	
	16QAM	10	5	39200	2355	8.950	10.279
				39175	2352.5	4.508	5.119
		5	39200	2355	4.498	4.957	
			39225	2357.5	4.504	4.891	
			10	39200	2355	8.983	9.845



LTE Band 7 QPSK 5MHz CH-Low

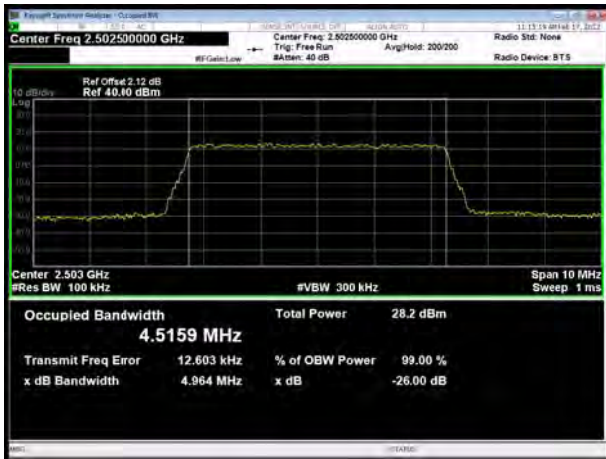

LTE Band 7 QPSK 10MHz CH-Low

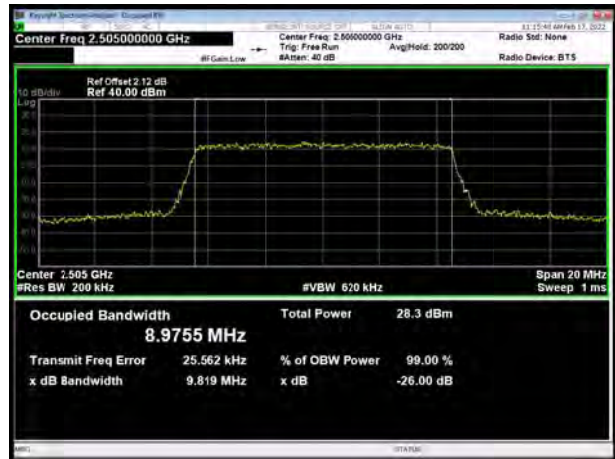

LTE Band 7 QPSK 5MHz CH-Middle



LTE Band 7 QPSK 10MHz CH-Middle

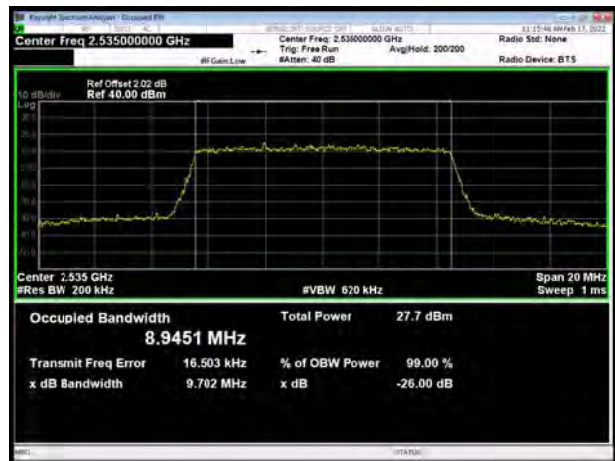

LTE Band 7 QPSK 5MHz CH-High

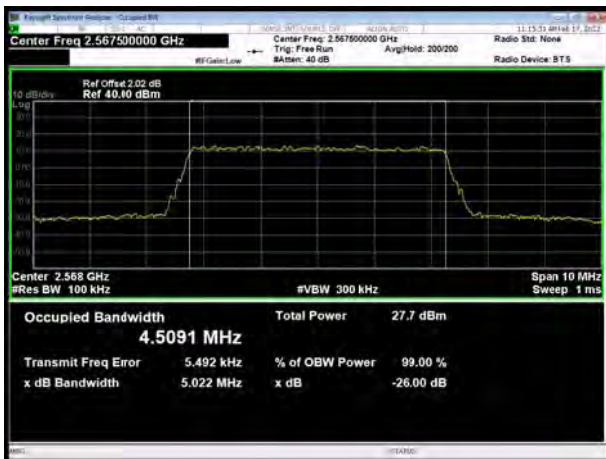

LTE Band 7 QPSK 10MHz CH-High

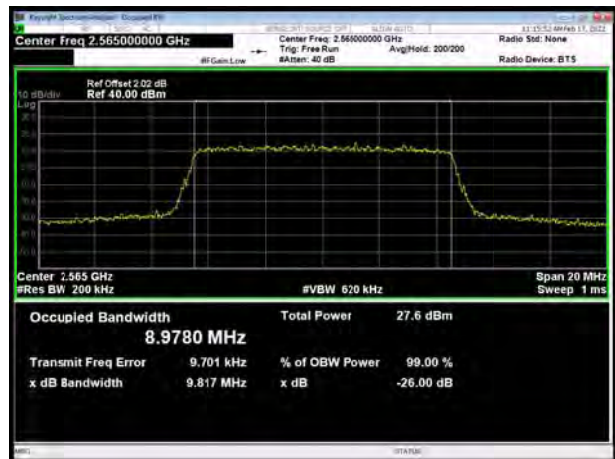



LTE Band 7 QPSK 15MHz CH-Low

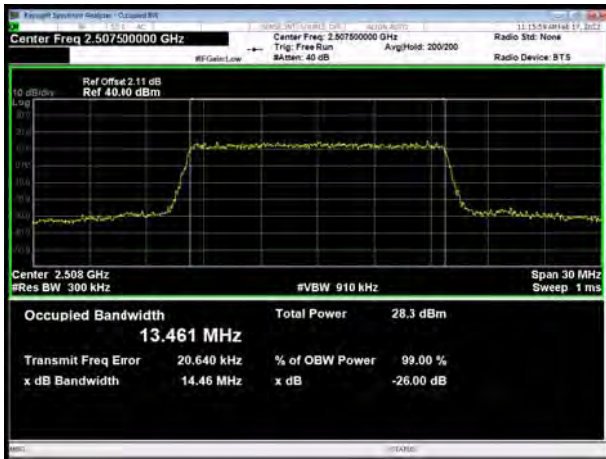

LTE Band 7 QPSK 20MHz CH-Low

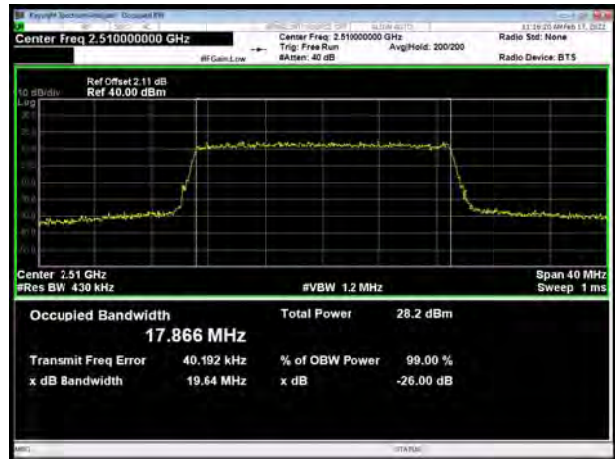

LTE Band 7 QPSK 15MHz CH-Middle

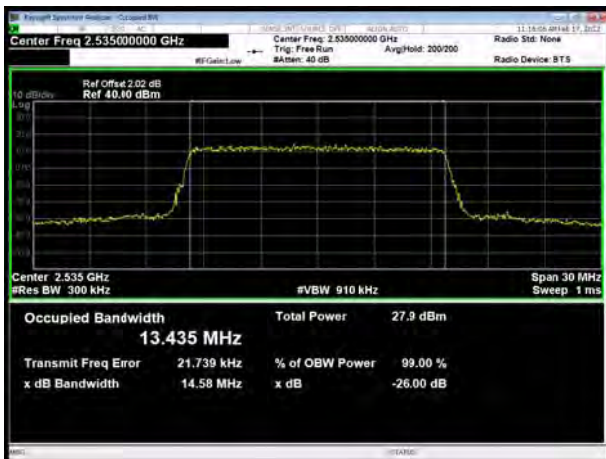

LTE Band 7 QPSK 20MHz CH-Middle

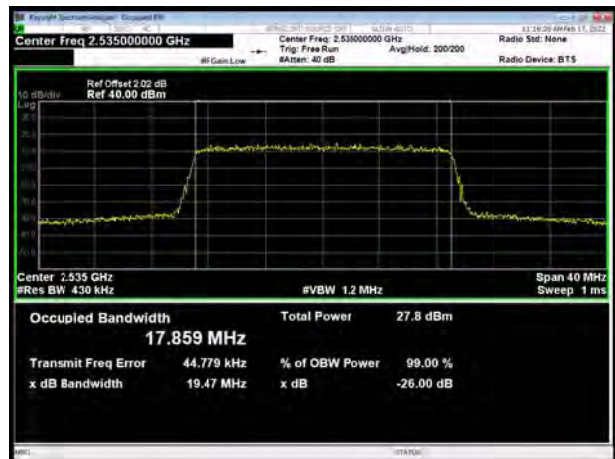

LTE Band 7 QPSK 15MHz CH-High

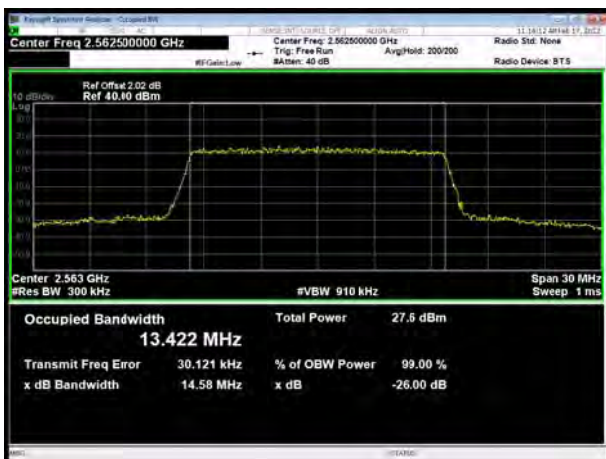

LTE Band 7 QPSK 20MHz CH-High

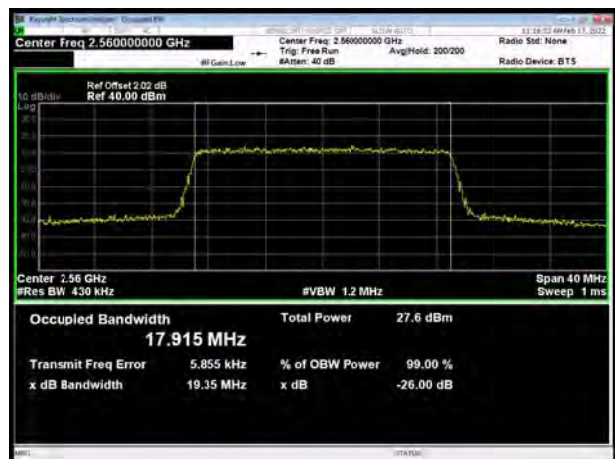



LTE Band 7 16QAM 5MHz CH-Low

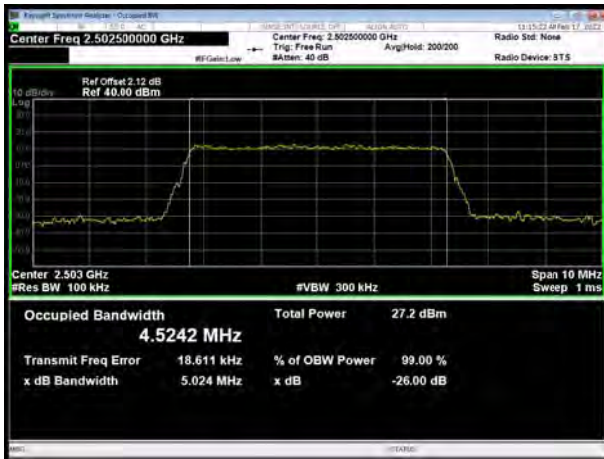

LTE Band 7 16QAM 10MHz CH-Low

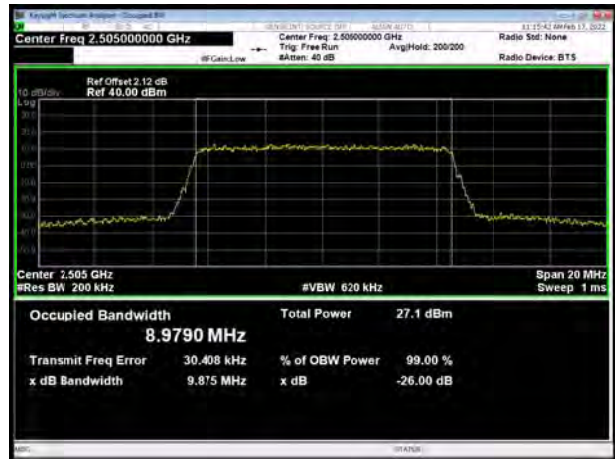

LTE Band 7 16QAM 5MHz CH-Middle

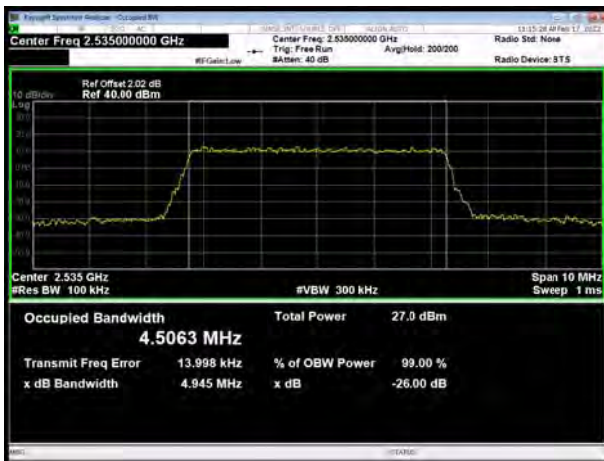

LTE Band 7 16QAM 10MHz CH-Middle



LTE Band 7 16QAM 5MHz CH-High

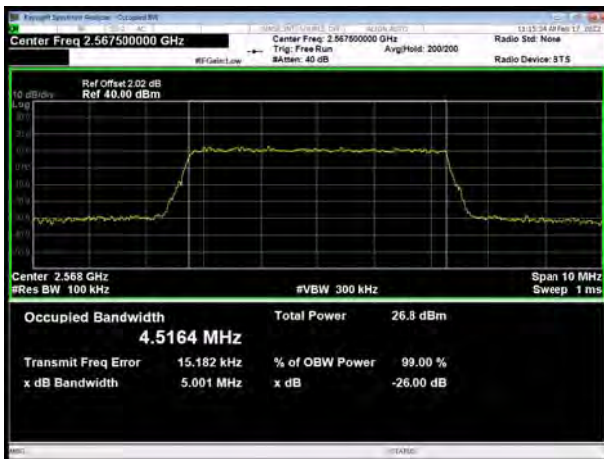

LTE Band 7 16QAM 10MHz CH-High

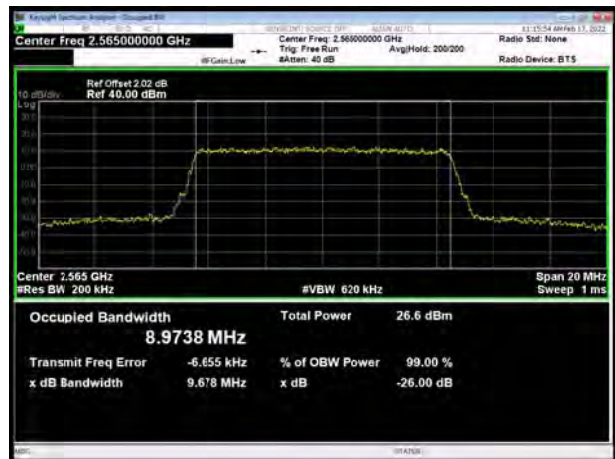



LTE Band 7 16QAM 15MHz CH-Low

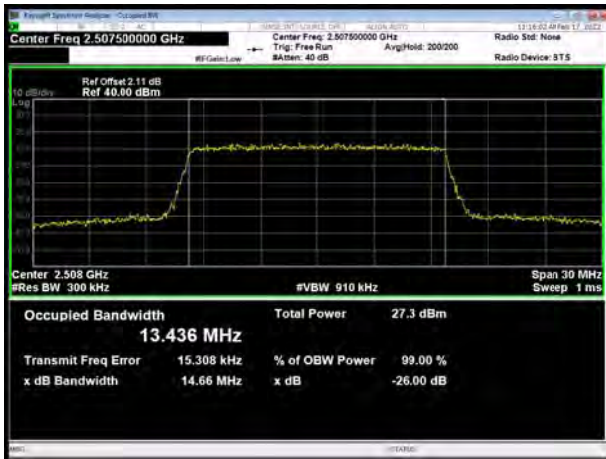

LTE Band 7 16QAM 20MHz CH-Low

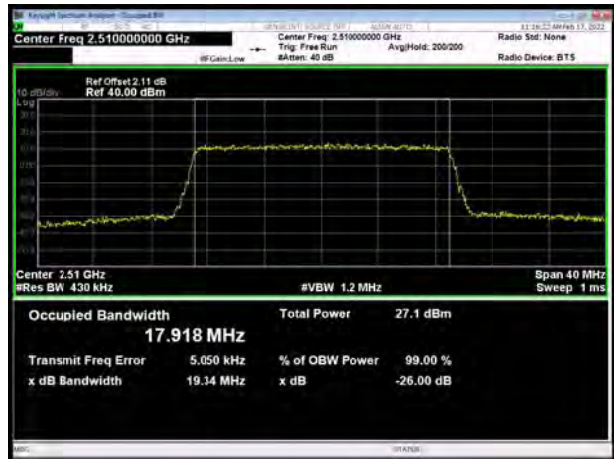

LTE Band 7 16QAM 15MHz CH-Middle

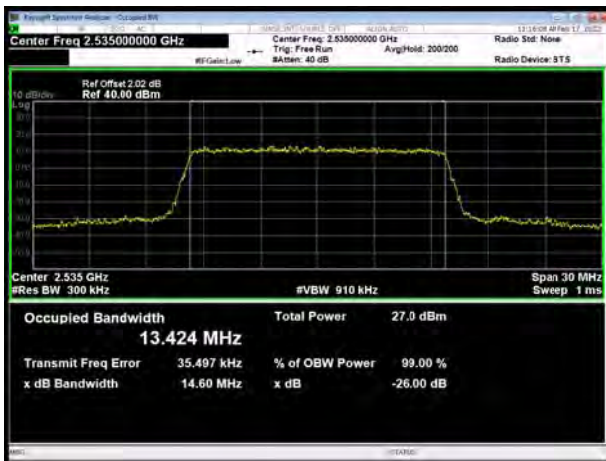

LTE Band 7 16QAM 20MHz CH-Middle

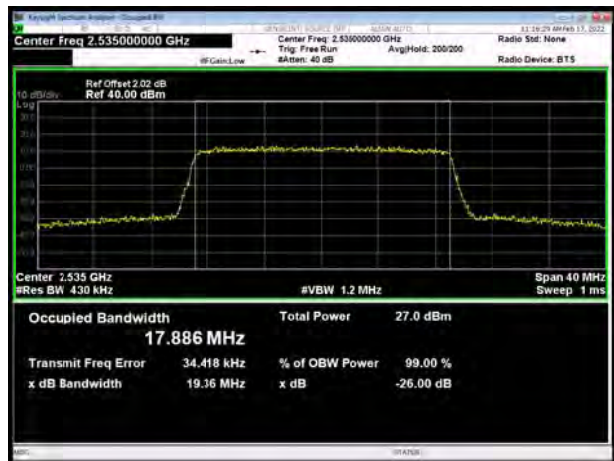

LTE Band 7 16QAM 15MHz CH-High

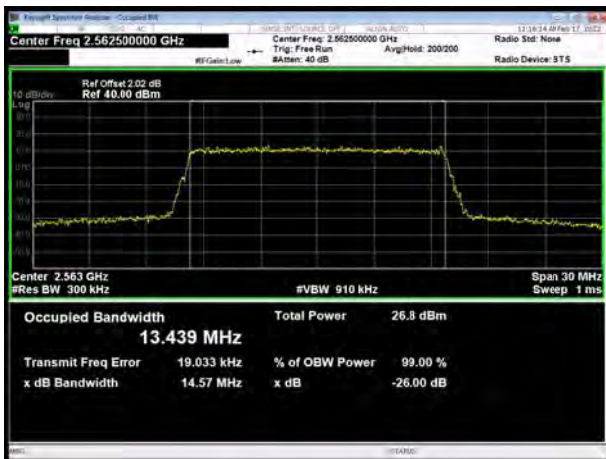

LTE Band 7 16QAM 20MHz CH-High

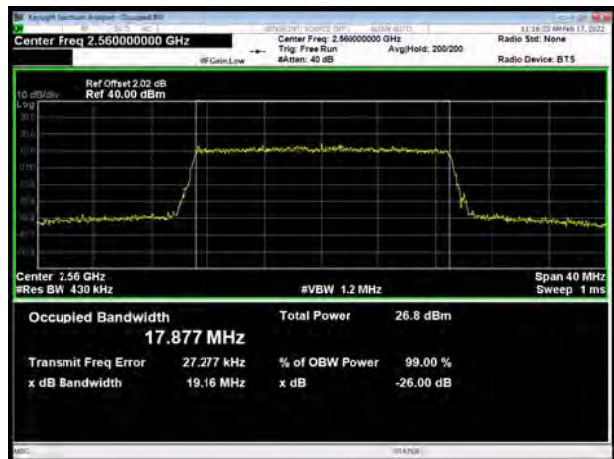



LTE Band 40 Subset 1 QPSK 5MHz CH-Low

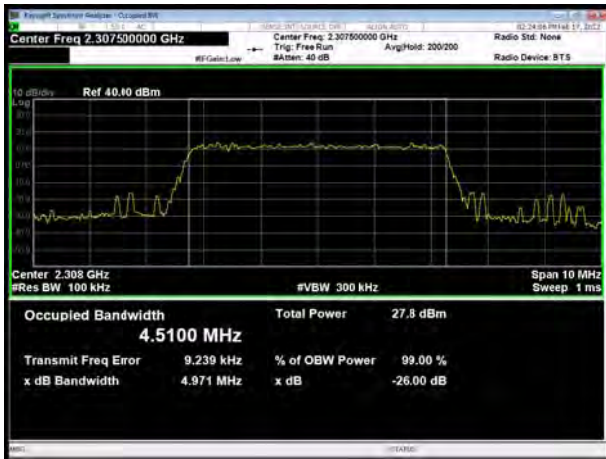

LTE Band 40 Subset 1 QPSK 10MHz

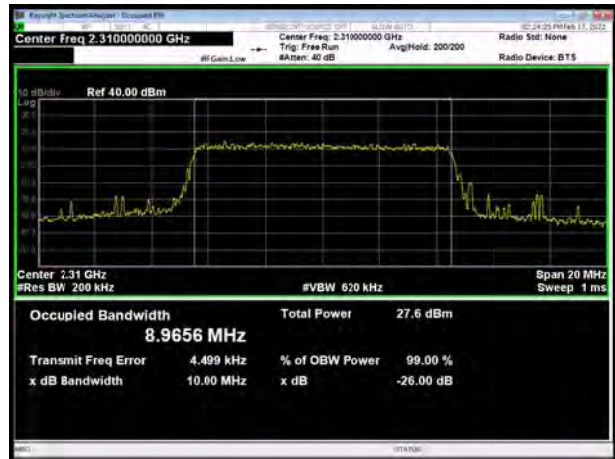

LTE Band 40 Subset 1 QPSK 5MHz CH-Middle

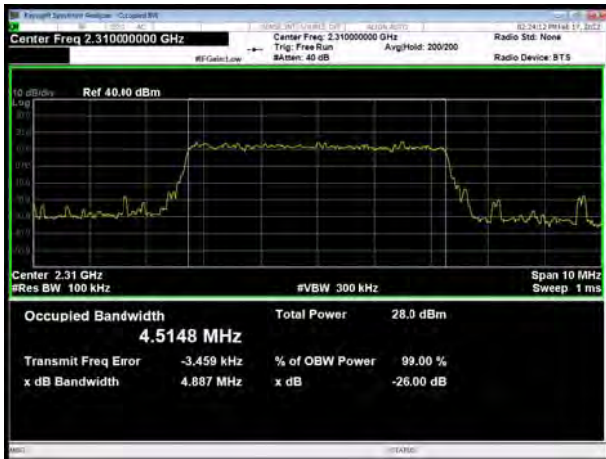

LTE Band 40 Subset 1 QPSK 5MHz CH-High

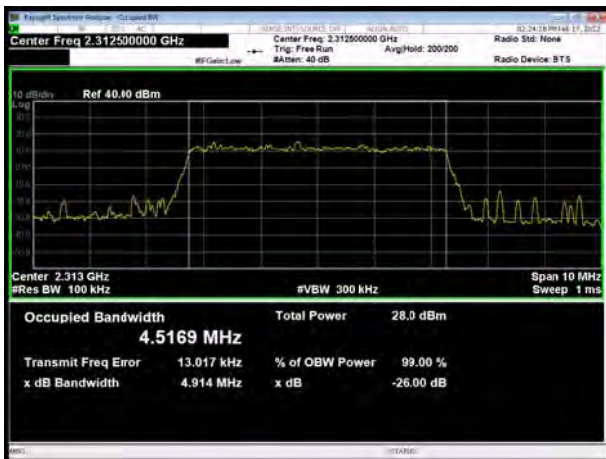

LTE Band 40 Subset 1 16QAM 5MHz CH-Low

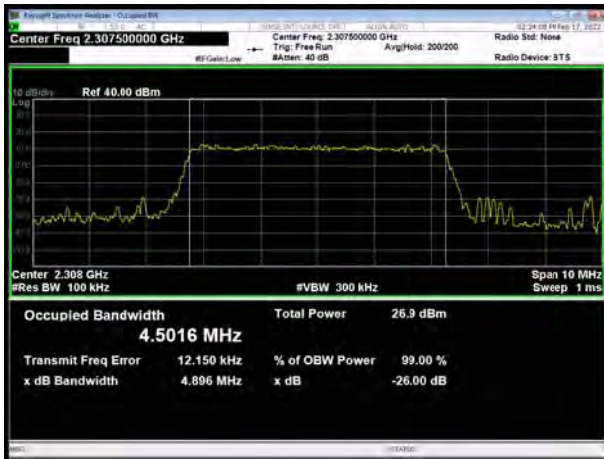

LTE Band 40 Subset 1 16QAM 10MHz

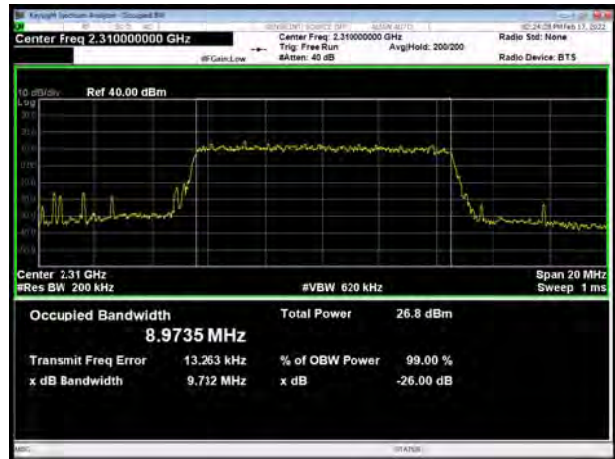

LTE Band 40 Subset 1 16QAM 5MHz CH-Middle

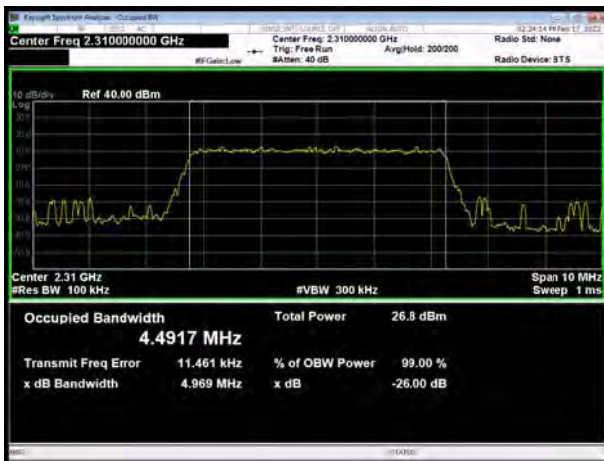

LTE Band 40 Subset 1 16QAM 5MHz CH-High

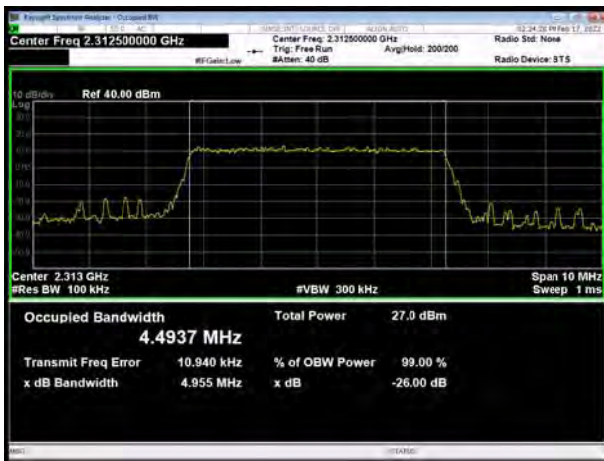



LTE Band 40 Subset 2 QPSK 5MHz CH-Low

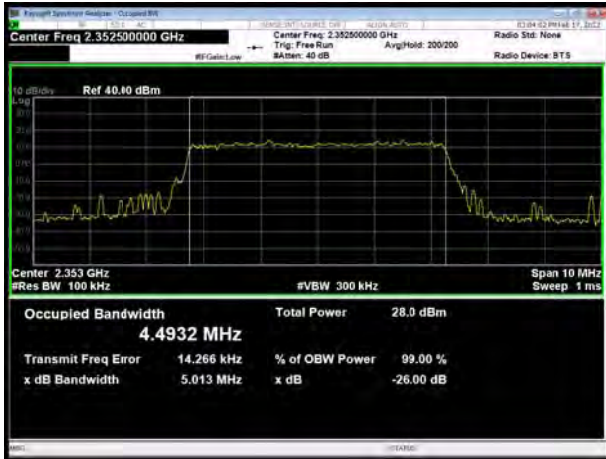

LTE Band 40 Subset 2 QPSK 10MHz

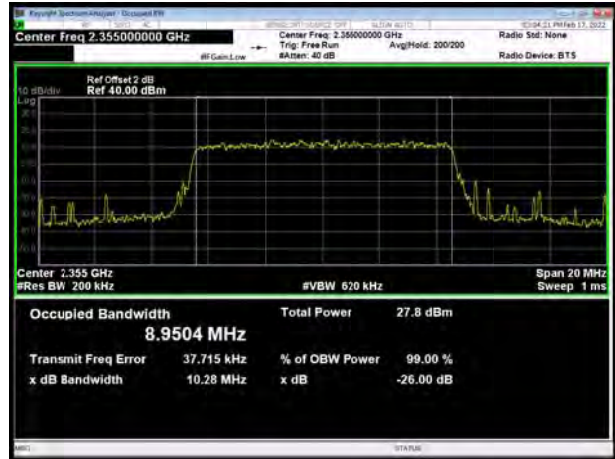

LTE Band 40 Subset 2 QPSK 5MHz CH-Middle

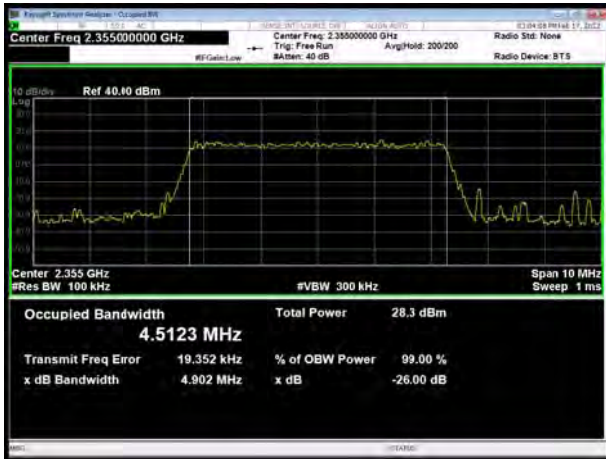

LTE Band 40 Subset 2 QPSK 5MHz CH-High

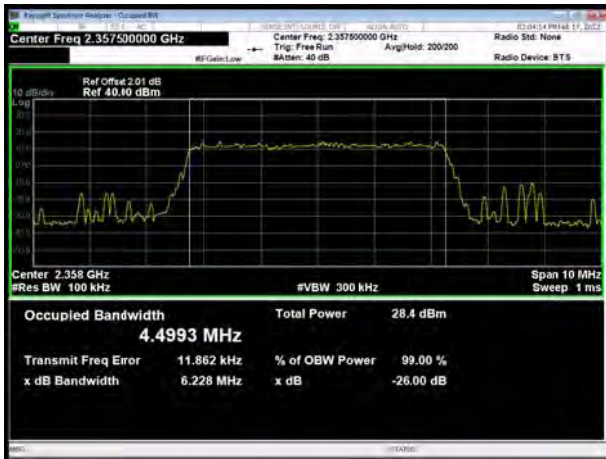



LTE Band 40 Subset 2 16QAM 5MHz CH-Low



LTE Band 40 Subset 2 16QAM 10MHz

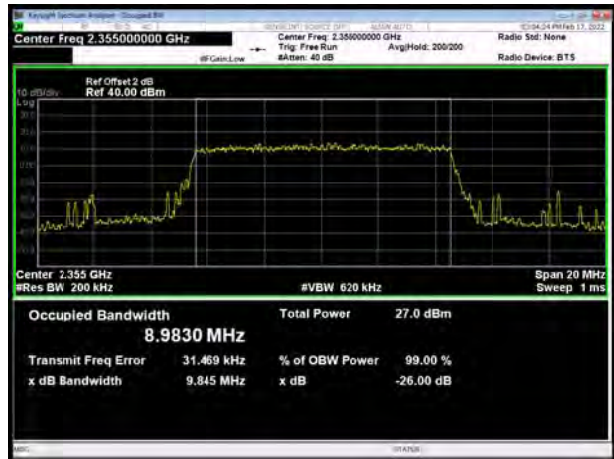

LTE Band 40 Subset 2 16QAM 5MHz CH-Middle

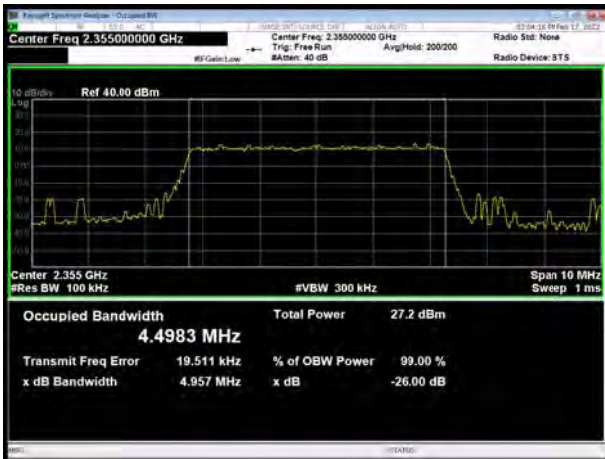

LTE Band 40 Subset 2 16QAM 5MHz CH-High



6.3 Band Edge Compliance

All the test traces in the plots shows the test results clearly.

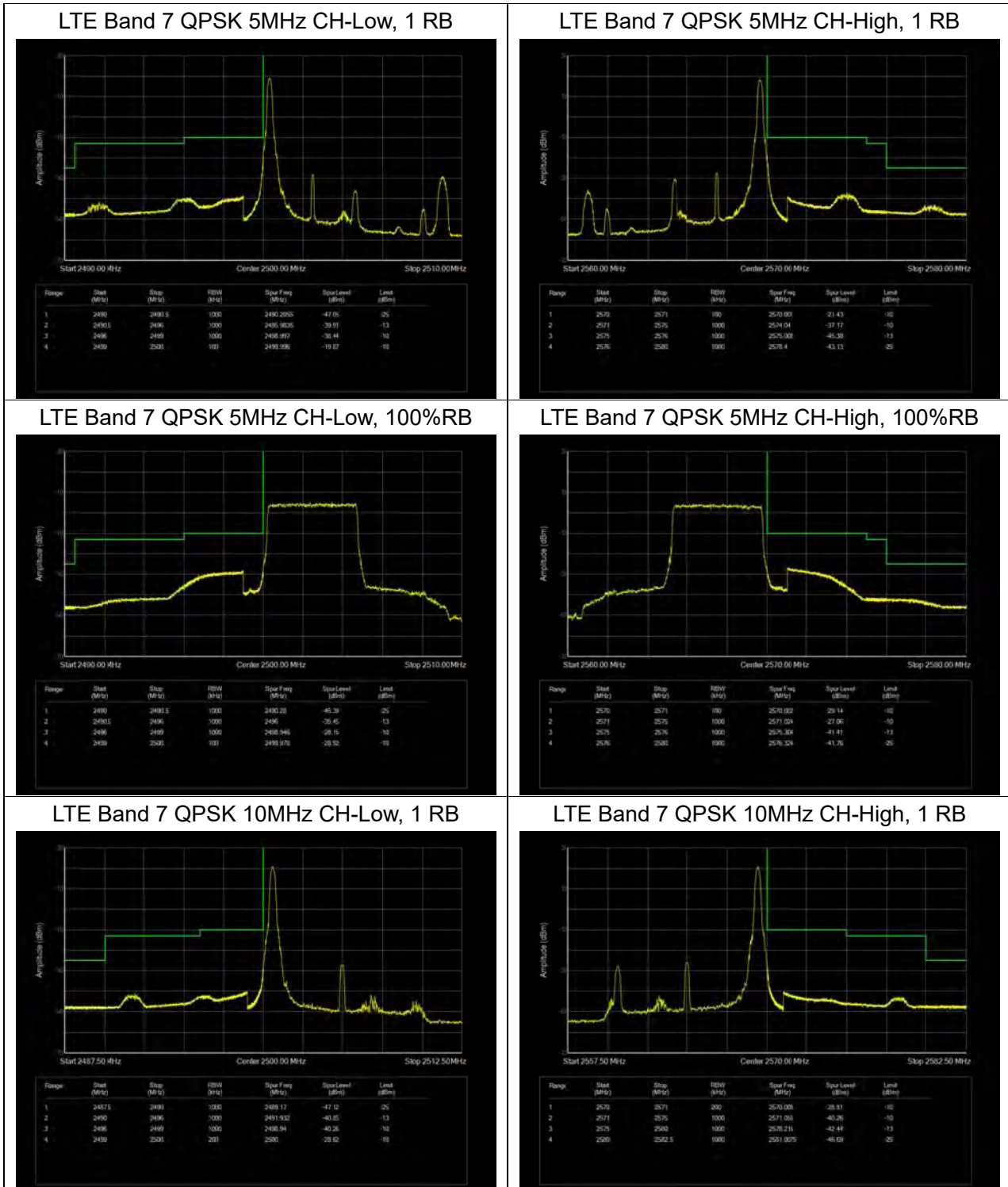



LTE Band 7 QPSK 10MHz CH-Low, 100%RB

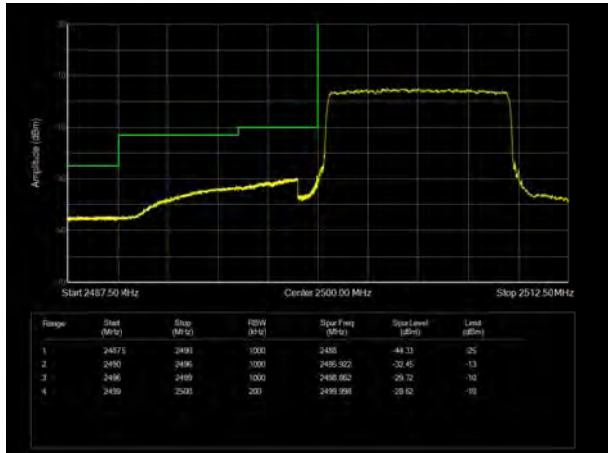

LTE Band 7 QPSK 10MHz CH-High, 100%RB

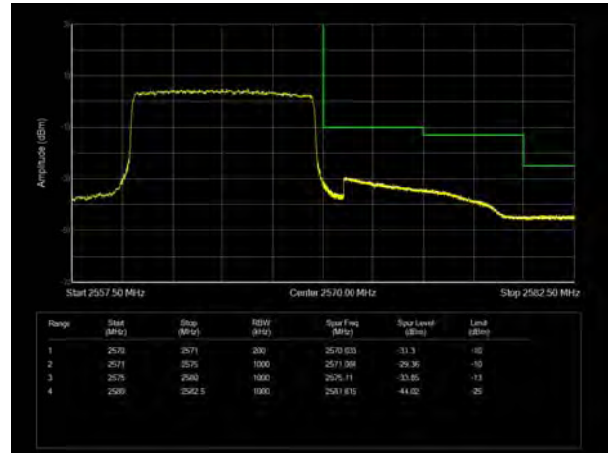

LTE Band 7 QPSK 15MHz CH-Low, 1 RB

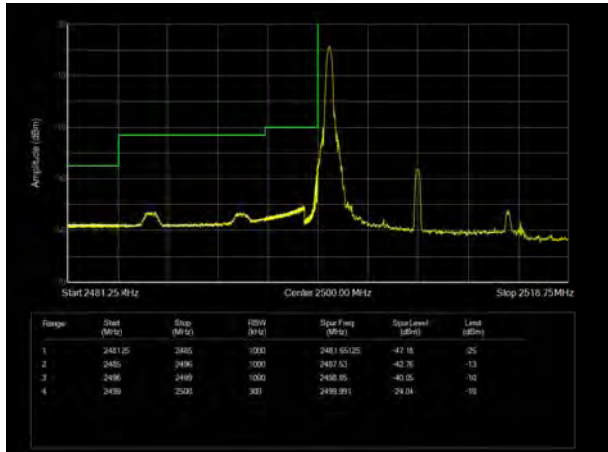

LTE Band 7 QPSK 15MHz CH-High, 1 RB

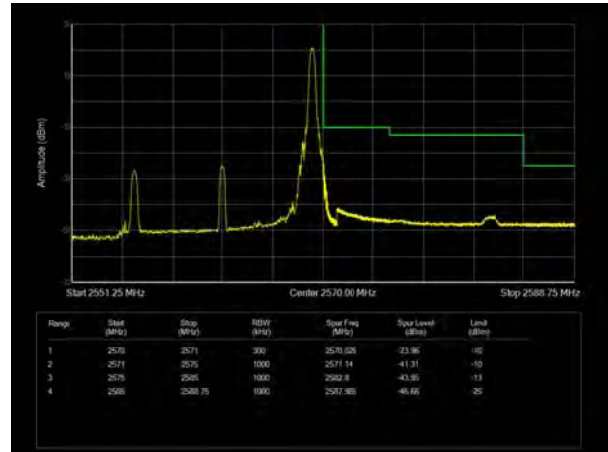

LTE Band 7 QPSK 15MHz CH-Low, 100%RB

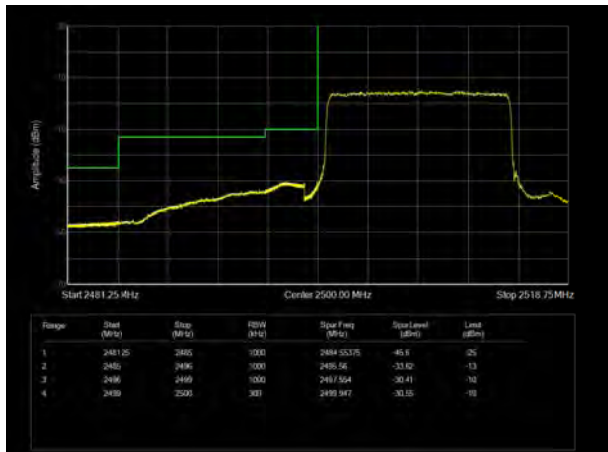

LTE Band 7 QPSK 15MHz CH-High, 100%RB

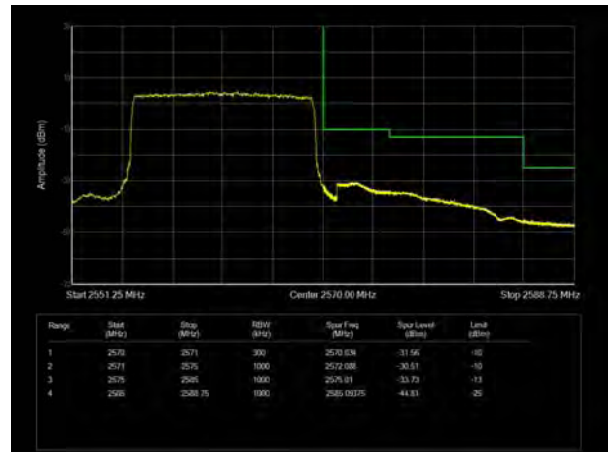



LTE Band 7 QPSK 20MHz CH-Low, 1 RB

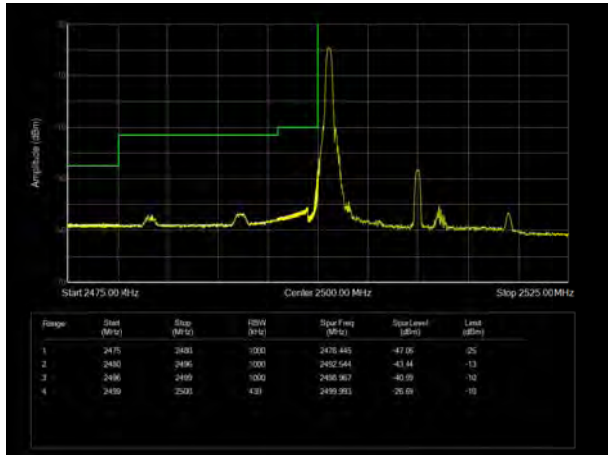

LTE Band 7 QPSK 20MHz CH-High, 1 RB

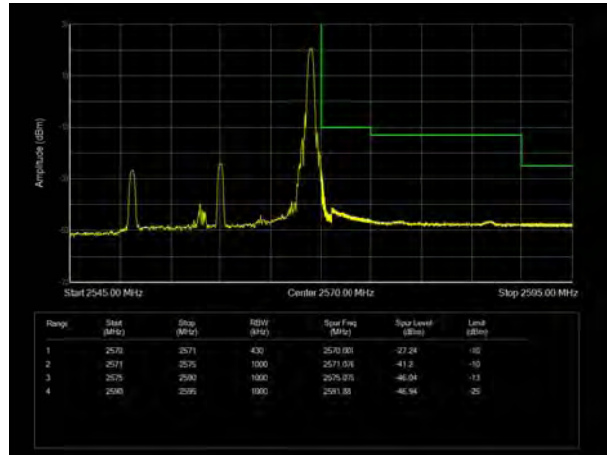

LTE Band 7 QPSK 20MHz CH-Low, 100%RB

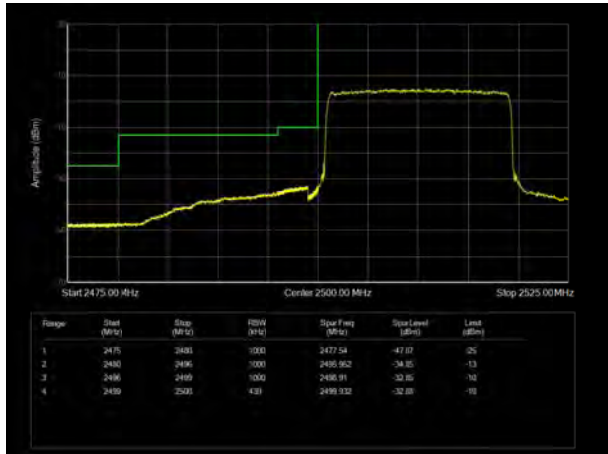

LTE Band 7 QPSK 20MHz CH-High, 100%RB

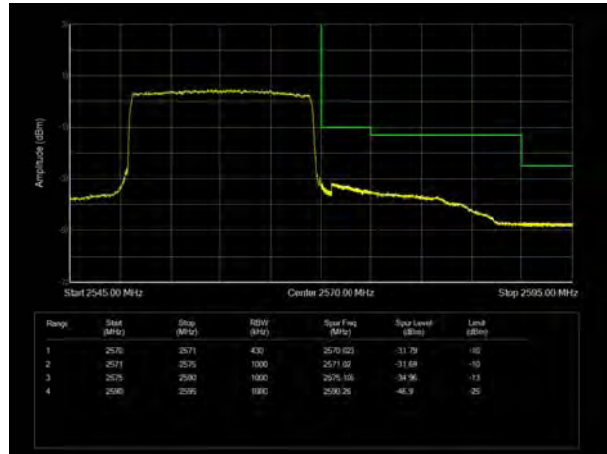

LTE Band 7 16QAM 5MHz CH-Low, 1 RB

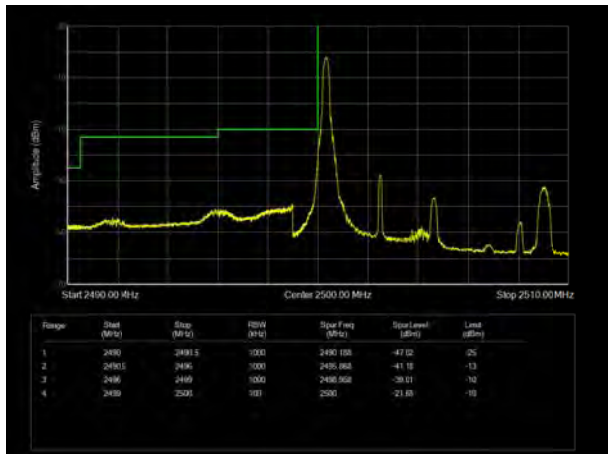

LTE Band 7 16QAM 5MHz CH-High, 1 RB

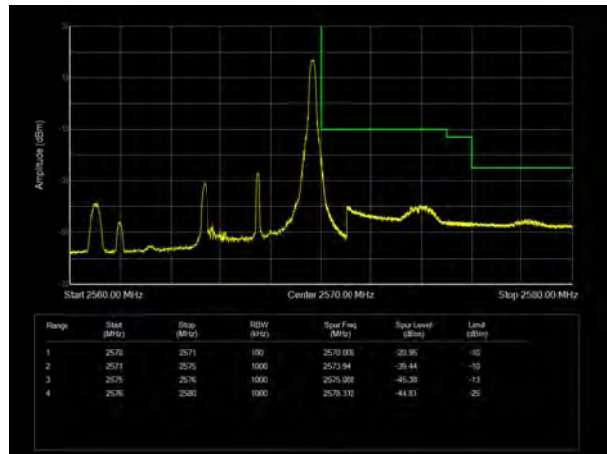



LTE Band 7 16QAM 5MHz CH-Low, 100%RB

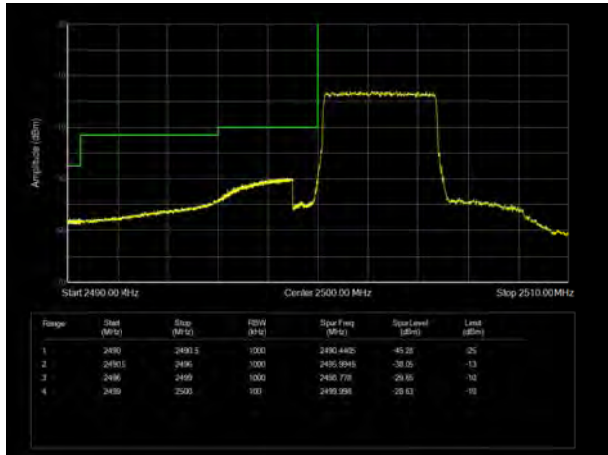

LTE Band 7 16QAM 5MHz CH-High, 100%RB

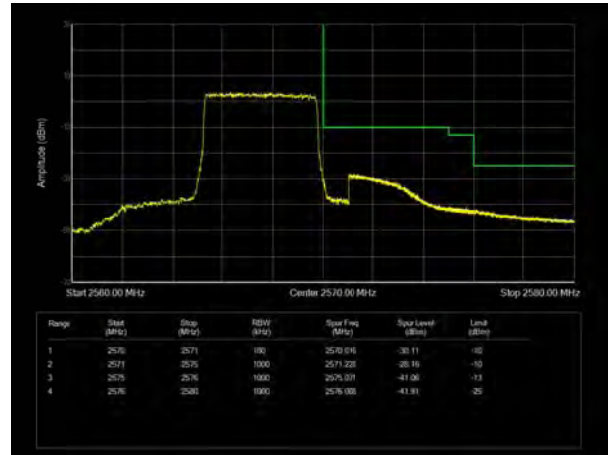

LTE Band 7 16QAM 10MHz CH-Low, 1 RB

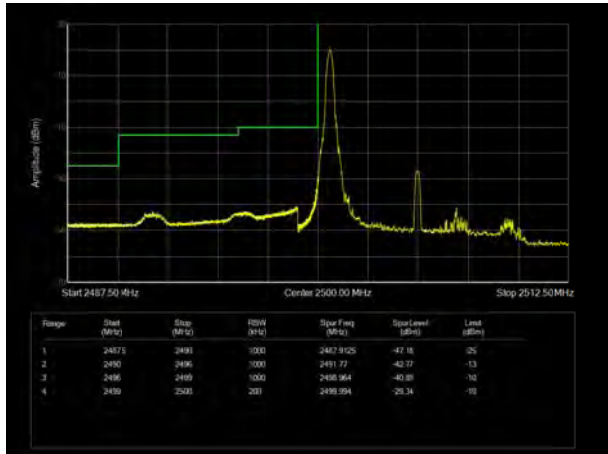

LTE Band 7 16QAM 10MHz CH-High, 1 RB

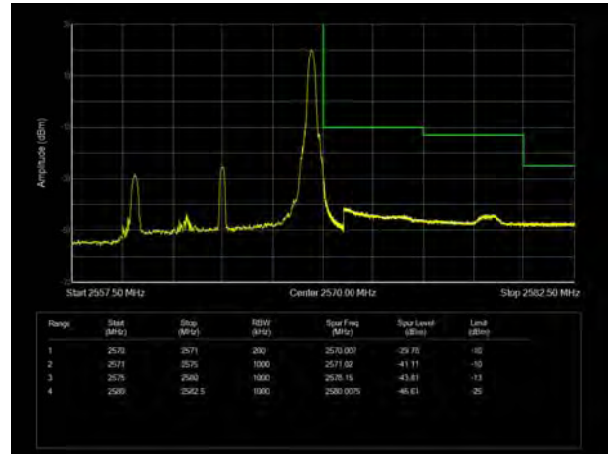

LTE Band 7 16QAM 10MHz CH-Low, 100%RB

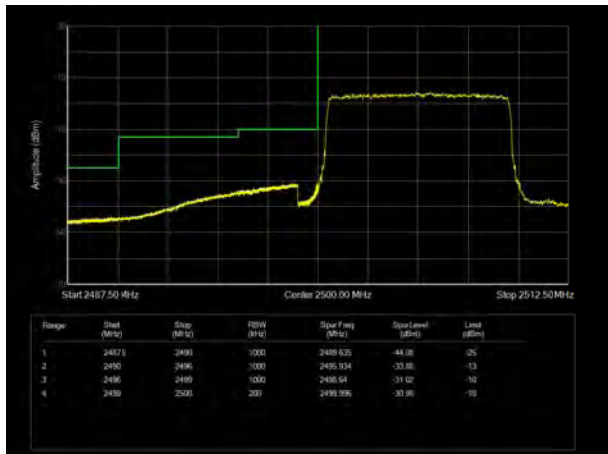

LTE Band 7 16QAM 10MHz CH-High, 100%RB

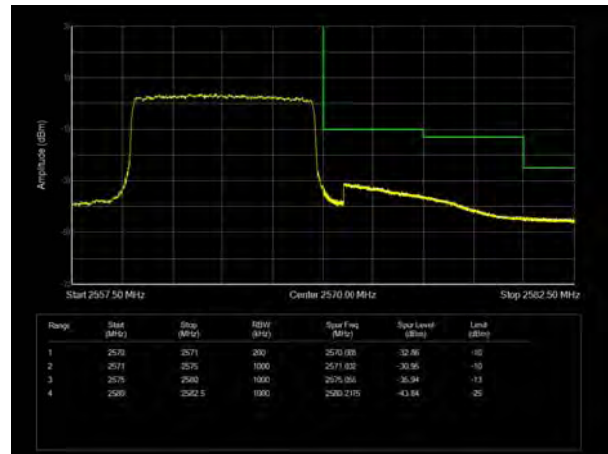



LTE Band 7 16QAM 15MHz CH-Low, 1 RB

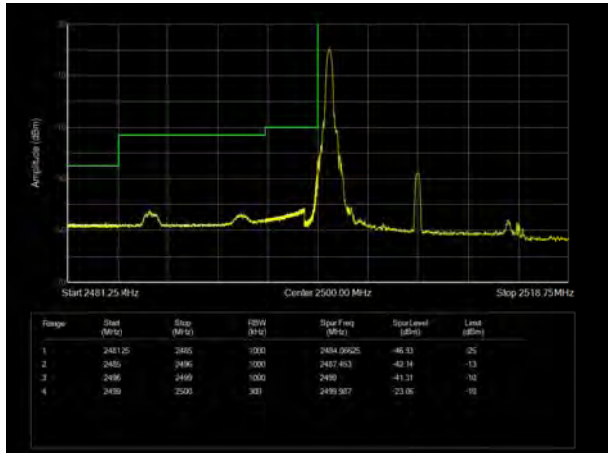

LTE Band 7 16QAM 15MHz CH-High, 1 RB

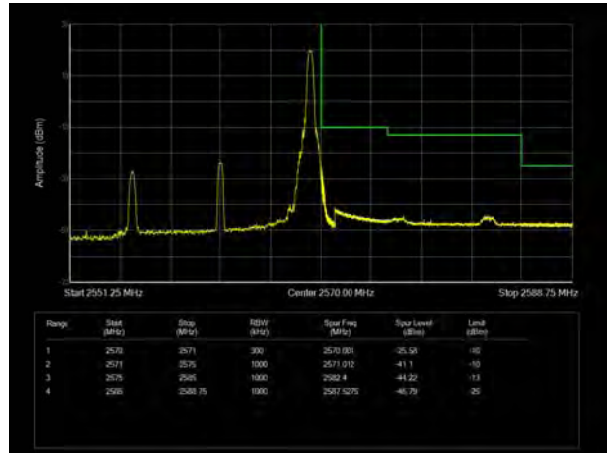

LTE Band 7 16QAM 15MHz CH-Low, 100%RB

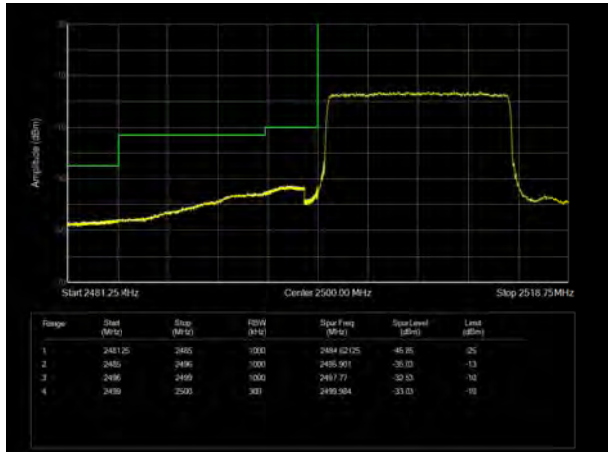

LTE Band 7 16QAM 15MHz CH-High, 100%RB

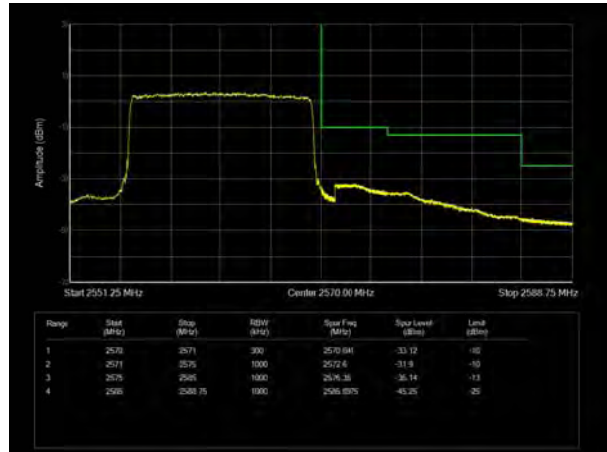

LTE Band 7 16QAM 20MHz CH-Low, 1 RB

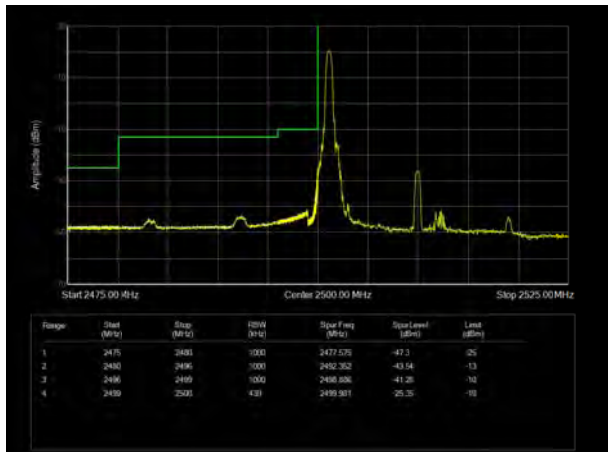

LTE Band 7 16QAM 20MHz CH-High, 1 RB

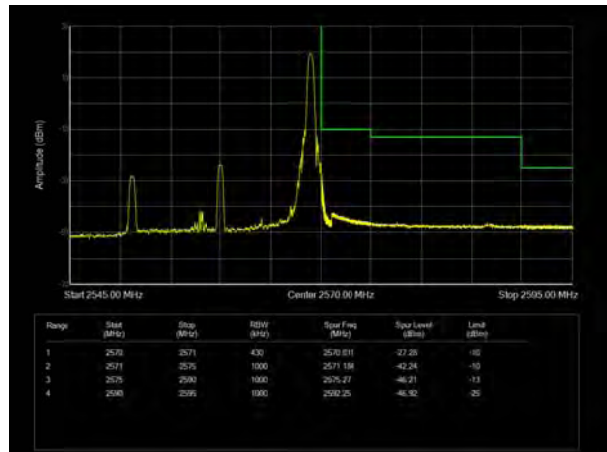



LTE Band 7 16QAM 20MHz CH-Low, 100%RB

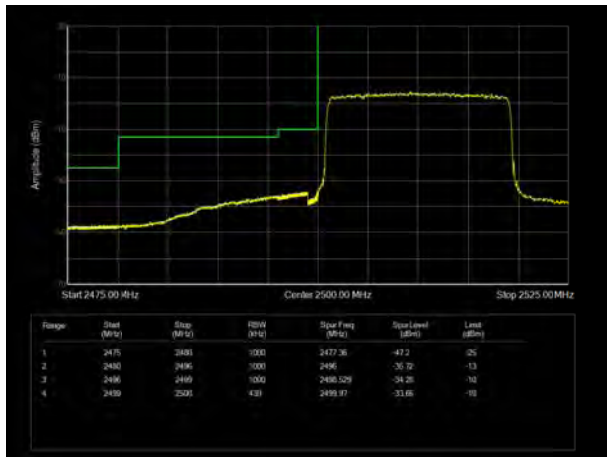

LTE Band 7 16QAM 20MHz CH-High, 100%RB

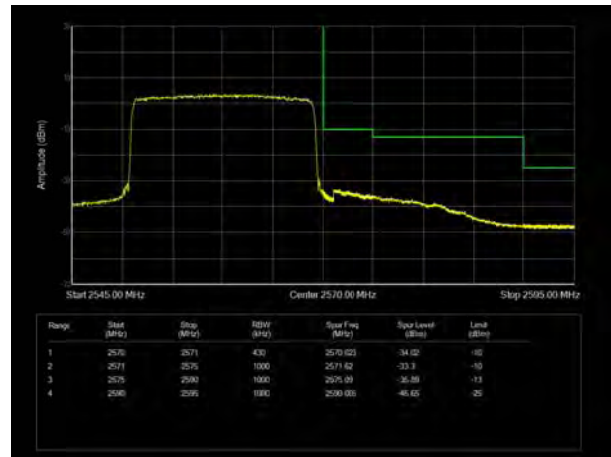

LTE Band 40 Subset 1 QPSK 5MHz CH-Low, 1 RB

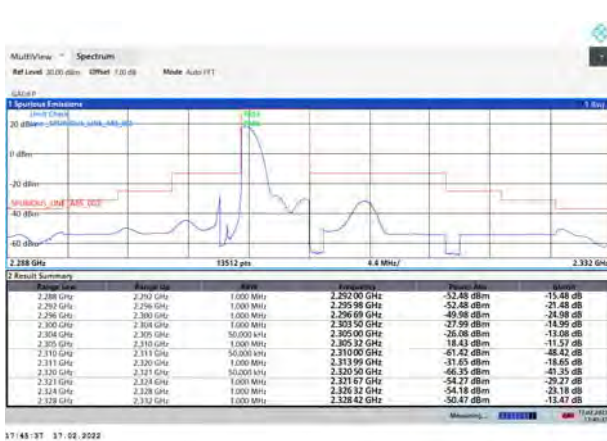

LTE Band 40 Subset 1 QPSK 5MHz CH-High, 1 RB

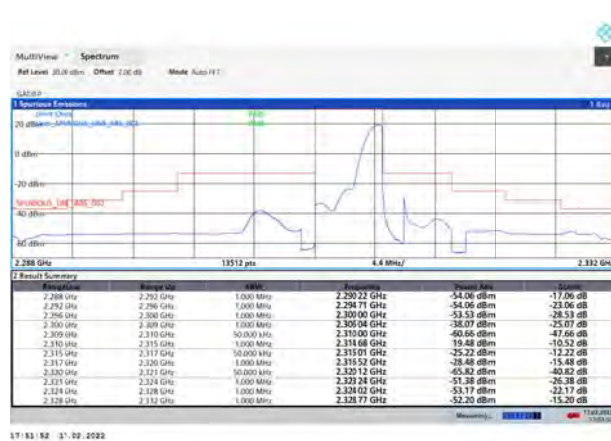

LTE Band 40 Subset 1 QPSK 5MHz CH-Low, 100%RB

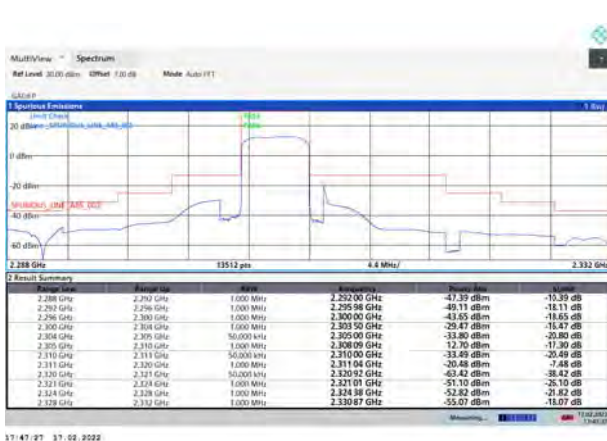

LTE Band 40 Subset 1 QPSK 5MHz CH-High, 100%RB

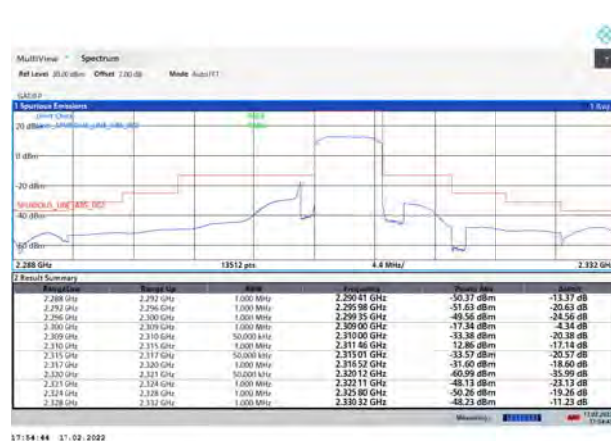



LTE Band 40 Subset 1 QPSK 10MHz CH-Low, 1 RB

LTE Band 40 Subset 1 QPSK 10MHz CH-High, 1 RB

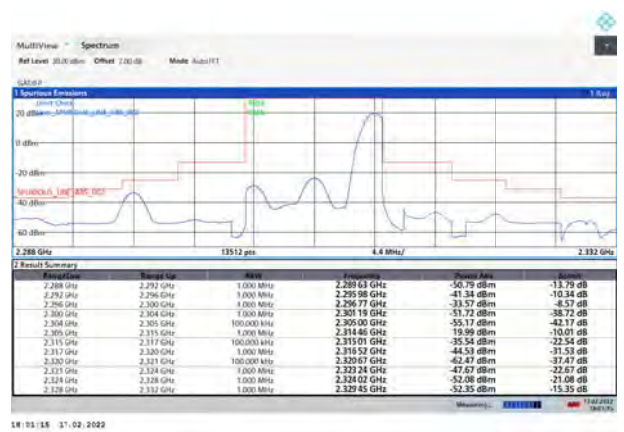
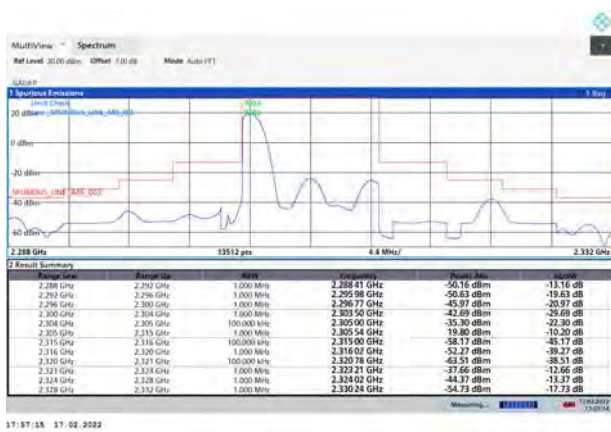

LTE Band 40 Subset 1 QPSK 10MHz CH-Low, 100%RB

LTE Band 40 Subset 1 QPSK 10MHz CH-High, 100%RB

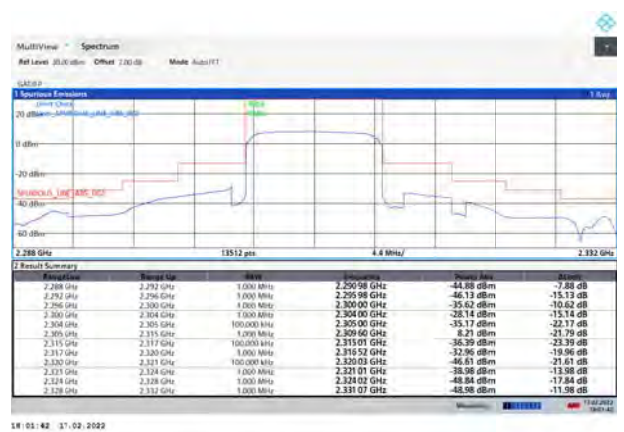
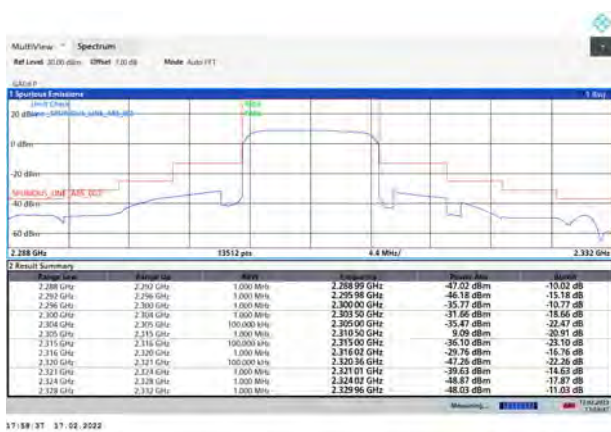

LTE Band 40 Subset 1 16QAM 5MHz CH-Low, 1 RB

LTE Band 40 Subset 1 16QAM 5MHz CH-High, 1 RB

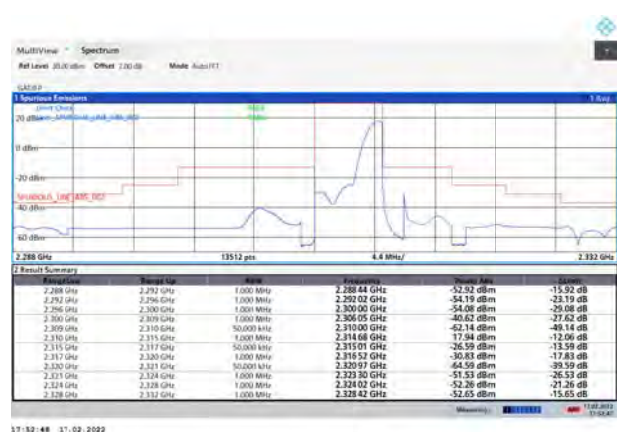
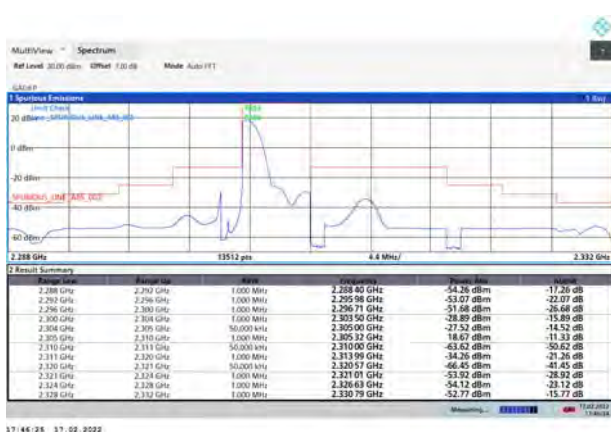



LTE Band 40 Subset 1 16QAM 5MHz CH-Low, 100%RB

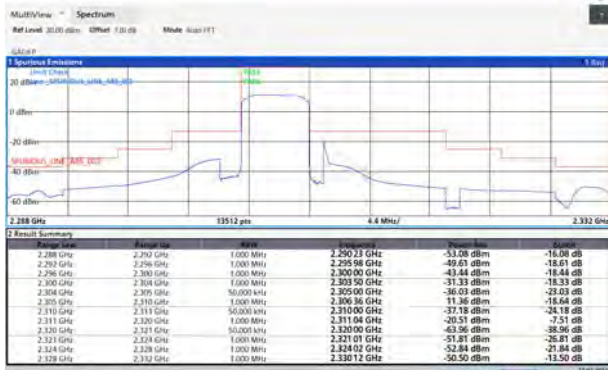

17:46:59 31.02.2022

LTE Band 40 Subset 1 16QAM 5MHz CH-High, 100%RB

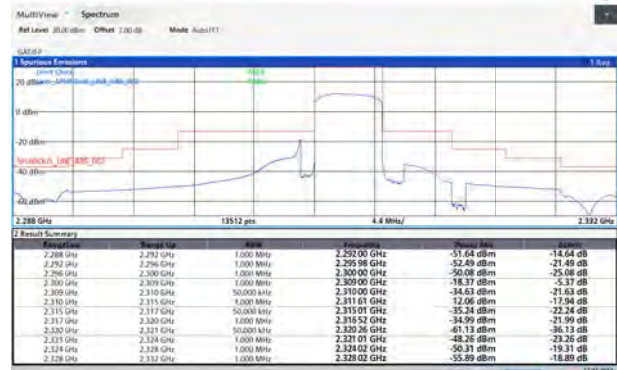

17:53:14 31.02.2022

LTE Band 40 Subset 1 16QAM 10MHz CH-Low, 1 RB

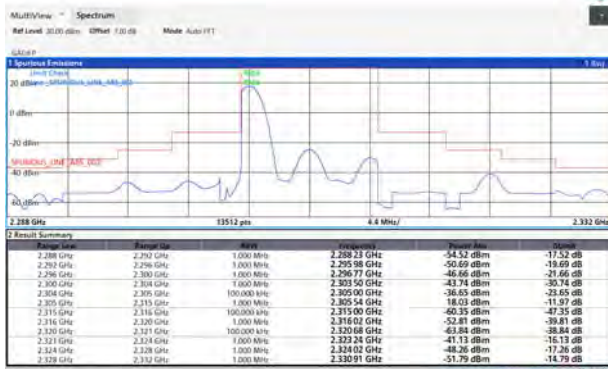

17:57:42 31.02.2022

LTE Band 40 Subset 1 16QAM 10MHz CH-High, 1 RB

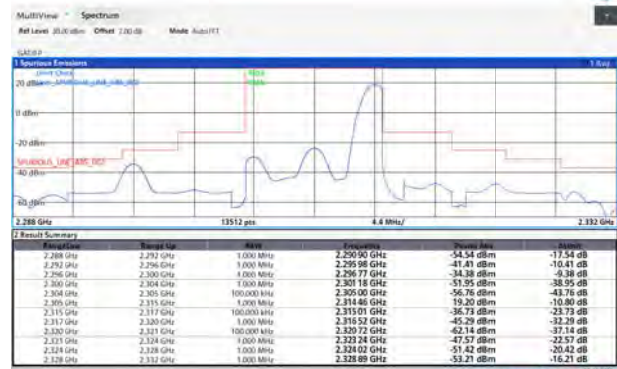

18:00:55 31.02.2022

LTE Band 40 Subset 1 16QAM 10MHz CH-Low, 100%RB

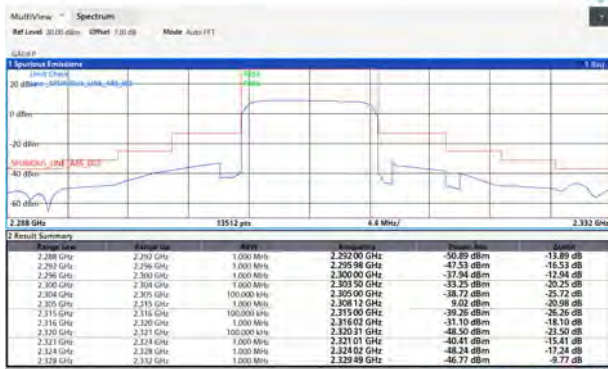

17:58:03 31.02.2022

LTE Band 40 Subset 1 16QAM 10MHz CH-High, 100%RB

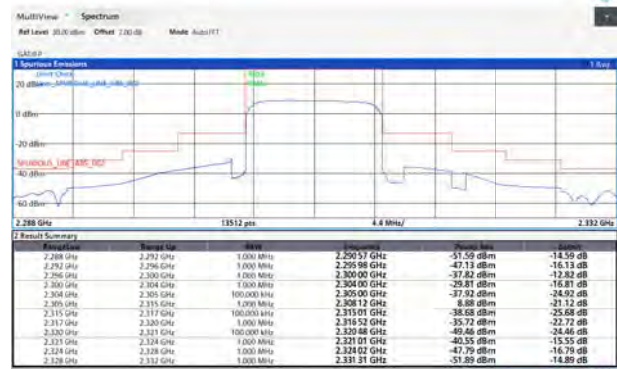

18:02:08 31.02.2022



LTE Band 40 Subset 2 QPSK 5MHz CH-Low, 1 RB

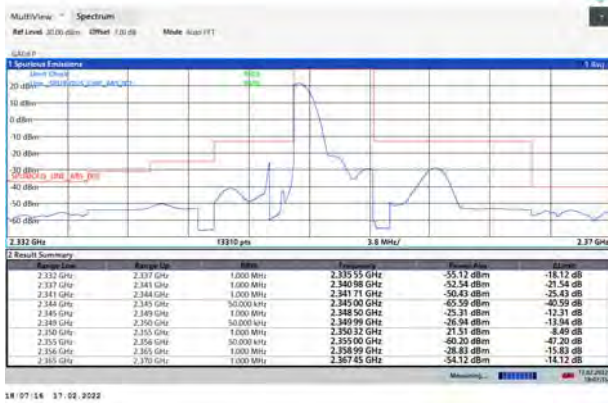

LTE Band 40 Subset 2 QPSK 5MHz CH-High, 1 RB

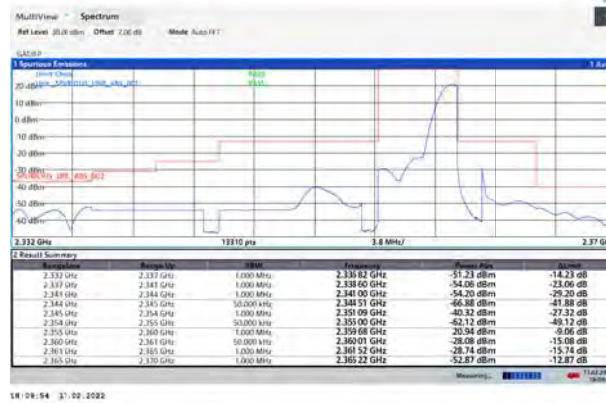

LTE Band 40 Subset 2 QPSK 5MHz CH-Low, 100%RB



LTE Band 40 Subset 2 QPSK 5MHz CH-High, 100%RB

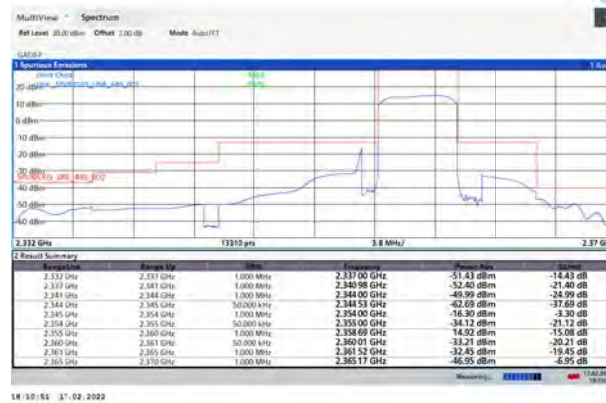

LTE Band 40 Subset 2 QPSK 10MHz CH-Low, 1 RB

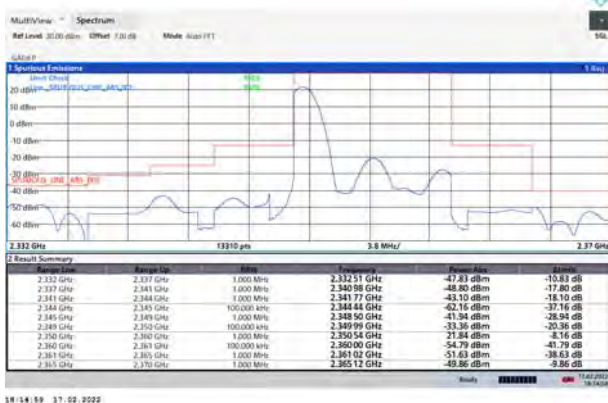

LTE Band 40 Subset 2 QPSK 10MHz CH-High, 1 RB

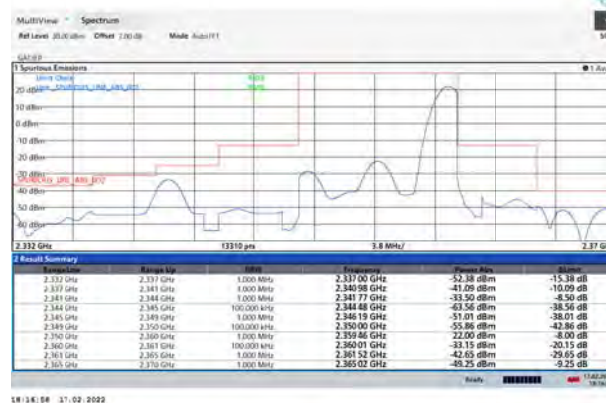



LTE Band 40 Subset 2 QPSK 10MHz CH-Low, 100%RB



LTE Band 40 Subset 2 QPSK 10MHz CH-High, 100%RB



LTE Band 40 Subset 2 16QAM 5MHz CH-Low, 1 RB

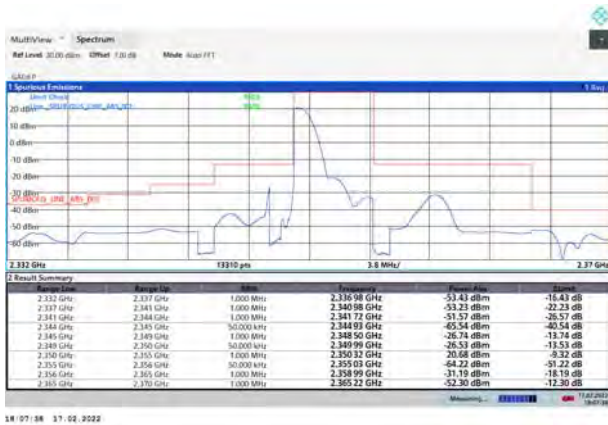

LTE Band 40 Subset 2 16QAM 5MHz CH-High, 1 RB

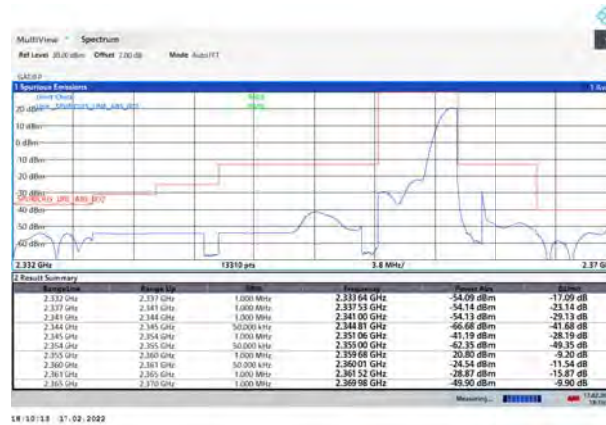

LTE Band 40 Subset 2 16QAM 5MHz CH-Low, 100%RB

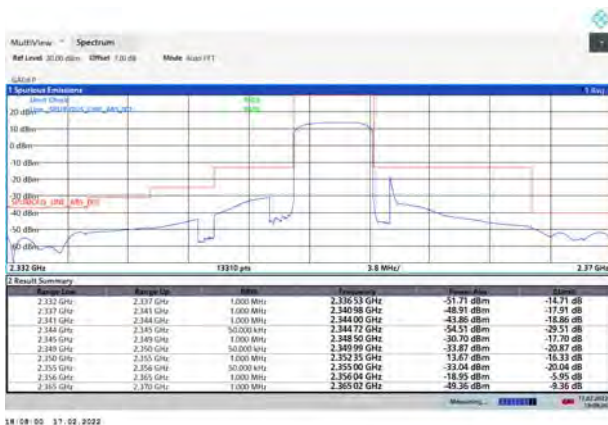

LTE Band 40 Subset 2 16QAM 5MHz CH-High, 100%RB

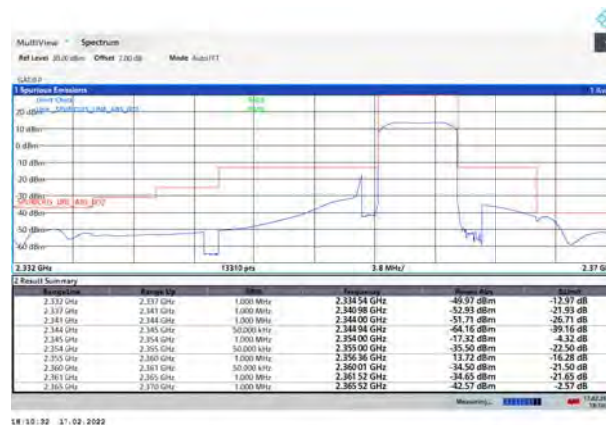



LTE Band 40 Subset 2 16QAM 10MHz CH-Low, 1 RB



LTE Band 40 Subset 2 16QAM 10MHz CH-High, 1 RB

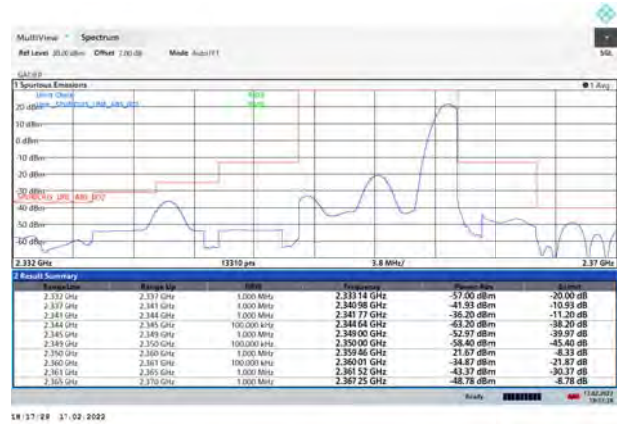

LTE Band 40 Subset 2 16QAM 10MHz CH-Low, 100%RB



LTE Band 40 Subset 2 16QAM 10MHz CH-High, 100%RB

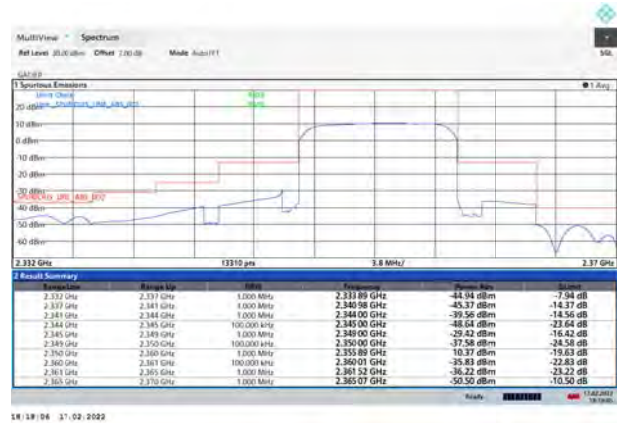



6.4 Peak-to-Average Power Ratio (PAPR)

LTE Band 7								
Modulation	Bandwidth (MHz)	Channel	Frequency (MHz)	Peak (dBm)	Avg (dBm)	PAPR (dB)	Limit (dB)	Conclusion
QPSK	5	20775	2502.5	25.31	20.40	4.91	≤13	PASS
		21100	2535	24.66	19.82	4.84	≤13	PASS
		21425	2567.5	24.70	19.80	4.90	≤13	PASS
	10	20800	2505	25.37	20.42	4.95	≤13	PASS
		21100	2535	24.73	19.92	4.81	≤13	PASS
		21400	2565	24.69	19.85	4.84	≤13	PASS
	15	20825	2507.5	25.60	20.45	5.15	≤13	PASS
		21100	2535	24.95	19.90	5.05	≤13	PASS
		21375	2562.5	24.80	19.73	5.07	≤13	PASS
	20	20850	2510	25.19	20.20	4.99	≤13	PASS
		21100	2535	24.72	19.84	4.88	≤13	PASS
		21350	2560	24.69	19.75	4.94	≤13	PASS
16QAM	5	20775	2502.5	25.19	19.46	5.73	≤13	PASS
		21100	2535	24.49	18.85	5.64	≤13	PASS
		21425	2567.5	24.43	18.71	5.72	≤13	PASS
	10	20800	2505	25.01	19.24	5.77	≤13	PASS
		21100	2535	24.49	18.84	5.65	≤13	PASS
		21400	2565	24.56	18.87	5.69	≤13	PASS
	15	20825	2507.5	25.19	19.31	5.88	≤13	PASS
		21100	2535	24.70	18.89	5.81	≤13	PASS
		21375	2562.5	24.56	18.76	5.80	≤13	PASS
	20	20850	2510	25.03	19.22	5.81	≤13	PASS
		21100	2535	24.54	18.83	5.71	≤13	PASS
		21350	2560	24.59	18.87	5.72	≤13	PASS



LTE Band 40 Subset 1								
Modulation	Bandwidth (MHz)	Channel	Frequency (MHz)	Peak (dBm)	Avg (dBm)	PAPR (dB)	Limit (dB)	Conclusion
QPSK	5	38725	2307.5	25.22	17.47	7.75	≤13	PASS
		38750	2310	25.06	15.68	9.38	≤13	PASS
		38775	2312.5	25.14	16.35	8.79	≤13	PASS
	10	38750	2310	25.08	16.11	8.97	≤13	PASS
16QAM	5	38725	2307.5	24.88	14.99	9.89	≤13	PASS
		38750	2310	24.99	15.55	9.44	≤13	PASS
		38775	2312.5	24.80	14.43	10.37	≤13	PASS
	10	38750	2310	25.10	16.15	8.95	≤13	PASS

LTE Band 40 Subset 2								
Modulation	Bandwidth (MHz)	Channel	Frequency (MHz)	Peak (dBm)	Avg (dBm)	PAPR (dB)	Limit (dB)	Conclusion
QPSK	5	39175	2352.5	25.68	17.84	7.84	≤13	PASS
		39200	2355	25.72	17.89	7.83	≤13	PASS
		39225	2357.5	25.77	17.30	8.47	≤13	PASS
	10	39200	2355	25.80	18.18	7.62	≤13	PASS
16QAM	5	39175	2352.5	25.50	15.85	9.65	≤13	PASS
		39200	2355	25.48	15.97	9.51	≤13	PASS
		39225	2357.5	25.47	16.06	9.41	≤13	PASS
	10	39200	2355	25.49	15.29	10.20	≤13	PASS



6.5 Frequency Stability

LTE Band 7						
Condition		Freq.Error (Hz)	Freq.Error (Hz)	Frequency Stability (ppm)	Frequency Stability (ppm)	Verdict
BANDWIDTH	5MHz					
Temperature	Voltage	16QAM	QPSK	16QAM	QPSK	
Normal (25°C)	Normal	13.15	15.17	0.00519	0.00598	PASS
Extreme (85°C)		6.22	6.29	0.00245	0.00248	PASS
Extreme (80°C)		10.88	3.03	0.00429	0.00119	PASS
Extreme (70°C)		10.13	4.55	0.00399	0.00179	PASS
Extreme (60°C)		5.09	8.90	0.00201	0.00351	PASS
Extreme (50°C)		2.75	16.95	0.00108	0.00669	PASS
Extreme (40°C)		15.75	17.68	0.00621	0.00698	PASS
Extreme (30°C)		15.65	12.83	0.00618	0.00506	PASS
Extreme (20°C)		13.88	7.92	0.00547	0.00312	PASS
Extreme (10°C)		11.87	15.51	0.00468	0.00612	PASS
Extreme (0°C)		16.56	4.72	0.00653	0.00186	PASS
Extreme (-10°C)		2.87	1.35	0.00113	0.00053	PASS
Extreme (-20°C)		7.04	7.58	0.00278	0.00299	PASS
Extreme (-30°C)		5.17	11.79	0.00204	0.00465	PASS
Extreme (-40°C)		7.34	4.71	0.00290	0.00186	PASS
25°C		LV	8.52	16.04	0.00336	0.00633
	HV	8.90	13.99	0.00351	0.00552	PASS
Condition		Freq.Error (Hz)	Freq.Error (Hz)	Frequency Stability (ppm)	Frequency Stability (ppm)	Verdict
BANDWIDTH	10MHz					
Temperature	Voltage	16QAM	QPSK	16QAM	QPSK	
Normal (25°C)	Normal	14.89	14.32	0.00587	0.00565	PASS
Extreme (85°C)		5.29	10.98	0.00209	0.00433	PASS
Extreme (80°C)		17.10	5.21	0.00675	0.00206	PASS
Extreme (70°C)		16.24	10.02	0.00641	0.00395	PASS
Extreme (60°C)		3.37	15.05	0.00133	0.00594	PASS
Extreme (50°C)		9.26	4.00	0.00365	0.00158	PASS
Extreme (40°C)		12.78	17.80	0.00504	0.00702	PASS
Extreme (30°C)		4.32	13.45	0.00170	0.00531	PASS
Extreme (20°C)		11.72	9.51	0.00462	0.00375	PASS
Extreme (10°C)		3.24	7.81	0.00128	0.00308	PASS
Extreme (0°C)		6.92	10.26	0.00273	0.00405	PASS
Extreme (-10°C)		3.21	6.40	0.00127	0.00252	PASS
Extreme (-20°C)		17.97	11.01	0.00709	0.00434	PASS



Extreme (-30°C)		16.69	4.49	0.00658	0.00177	PASS
Extreme (-40°C)		4.04	9.83	0.00159	0.00388	PASS
25°C	LV	9.20	4.36	0.00363	0.00172	PASS
	HV	16.25	3.72	0.00641	0.00147	PASS
Condition		Freq.Error (Hz)	Freq.Error (Hz)	Frequency Stability (ppm)	Frequency Stability (ppm)	Verdict
BANDWIDTH	15MHz					
Temperature	Voltage	16QAM	QPSK	16QAM	QPSK	
Normal (25°C)	Normal	10.36	3.19	0.00409	0.00126	
Extreme (85°C)		4.80	3.11	0.00189	0.00123	PASS
Extreme (80°C)		7.93	12.22	0.00313	0.00482	PASS
Extreme (70°C)		16.60	10.44	0.00655	0.00412	PASS
Extreme (60°C)		1.87	6.43	0.00074	0.00254	PASS
Extreme (50°C)		12.14	6.03	0.00479	0.00238	PASS
Extreme (40°C)		14.78	1.72	0.00583	0.00068	PASS
Extreme (30°C)		2.38	12.83	0.00094	0.00506	PASS
Extreme (20°C)		17.78	7.61	0.00702	0.00300	PASS
Extreme (10°C)		4.79	11.37	0.00189	0.00449	PASS
Extreme (0°C)		2.06	16.21	0.00081	0.00639	PASS
Extreme (-10°C)		14.14	11.40	0.00558	0.00450	PASS
Extreme (-20°C)		14.02	9.54	0.00553	0.00376	PASS
Extreme (-30°C)		10.77	8.03	0.00425	0.00317	PASS
Extreme (-40°C)		17.34	6.08	0.00684	0.00240	PASS
25°C		LV	13.52	6.29	0.00533	0.00248
	HV	10.74	17.15	0.00424	0.00677	PASS
Condition		Freq.Error (Hz)	Freq.Error (Hz)	Frequency Stability (ppm)	Frequency Stability (ppm)	Verdict
BANDWIDTH	20MHz					
Temperature	Voltage	16QAM	QPSK	16QAM	QPSK	
Normal (25°C)	Normal	13.65	11.07	0.00538	0.00437	
Extreme (85°C)		11.51	16.07	0.00454	0.00634	PASS
Extreme (80°C)		2.88	11.67	0.00114	0.00460	PASS
Extreme (70°C)		14.05	4.65	0.00554	0.00183	PASS
Extreme (60°C)		4.01	4.06	0.00158	0.00160	PASS
Extreme (50°C)		5.65	15.88	0.00223	0.00626	PASS
Extreme (40°C)		2.60	7.99	0.00103	0.00315	PASS
Extreme (30°C)		12.57	12.26	0.00496	0.00484	PASS
Extreme (20°C)		9.81	6.51	0.00387	0.00257	PASS
Extreme (10°C)		11.44	5.42	0.00451	0.00214	PASS
Extreme (0°C)		7.78	14.26	0.00307	0.00563	PASS
Extreme (-10°C)		14.65	6.95	0.00578	0.00274	PASS



Extreme (-20℃)		2.61	3.21	0.00103	0.00127	PASS
Extreme (-30℃)		5.23	5.36	0.00206	0.00211	PASS
Extreme (-40℃)		4.77	17.67	0.00188	0.00697	PASS
25℃	LV	14.93	10.36	0.00589	0.00409	PASS
	HV	7.89	12.80	0.00311	0.00505	PASS

LTE Band 40 Subset 1						
Condition		Freq.Error (Hz)	Freq.Error (Hz)	Frequency Stability (ppm)	Frequency Stability (ppm)	Verdict
BANDWIDTH	5MHz					
Temperature	Voltage	16QAM	QPSK	16QAM	QPSK	
Normal (25℃)	Normal	12.55	14.00	0.00543	0.00606	PASS
Extreme (85℃)		4.25	2.00	0.00184	0.00087	PASS
Extreme (80℃)		6.63	6.00	0.00287	0.00260	PASS
Extreme (70℃)		16.70	3.00	0.00723	0.00130	PASS
Extreme (60℃)		16.92	2.00	0.00733	0.00087	PASS
Extreme (50℃)		16.73	17.00	0.00724	0.00736	PASS
Extreme (40℃)		16.08	17.00	0.00696	0.00736	PASS
Extreme (30℃)		5.79	4.00	0.00251	0.00173	PASS
Extreme (20℃)		16.79	5.00	0.00727	0.00216	PASS
Extreme (10℃)		2.09	12.00	0.00091	0.00519	PASS
Extreme (0℃)		16.25	9.00	0.00704	0.00390	PASS
Extreme (-10℃)		8.80	14.00	0.00381	0.00606	PASS
Extreme (-20℃)		16.25	16.00	0.00704	0.00693	PASS
Extreme (-30℃)		17.06	13.00	0.00738	0.00563	PASS
Extreme (-40℃)		6.93	4.00	0.00300	0.00173	PASS
25℃		LV	1.40	12.00	0.00060	0.00519
	HV	12.10	9.00	0.00524	0.00390	PASS
Condition		Freq.Error (Hz)	Freq.Error (Hz)	Frequency Stability (ppm)	Frequency Stability (ppm)	Verdict
BANDWIDTH	10MHz					
Temperature	Voltage	16QAM	QPSK	16QAM	QPSK	
Normal (25℃)	Normal	12.46	7.00	0.00539	0.00303	PASS
Extreme (85℃)		2.07	11.00	0.00090	0.00476	PASS
Extreme (80℃)		17.87	4.00	0.00774	0.00173	PASS
Extreme (70℃)		14.91	10.00	0.00645	0.00433	PASS
Extreme (60℃)		8.73	10.00	0.00378	0.00433	PASS
Extreme (50℃)		12.73	12.00	0.00551	0.00519	PASS
Extreme (40℃)		1.74	7.00	0.00075	0.00303	PASS
Extreme (30℃)		5.87	2.00	0.00254	0.00087	PASS
Extreme (20℃)		8.57	10.00	0.00371	0.00433	PASS
Extreme (10℃)		15.21	6.00	0.00658	0.00260	PASS



Extreme (0°C)		4.80	11.00	0.00208	0.00476	PASS
Extreme (-10°C)		11.95	12.00	0.00517	0.00519	PASS
Extreme (-20°C)		13.51	6.00	0.00585	0.00260	PASS
Extreme (-30°C)		16.89	3.00	0.00731	0.00130	PASS
Extreme (-40°C)		1.38	6.00	0.00060	0.00260	PASS
25°C	LV	5.05	15.00	0.00218	0.00649	PASS
	HV	9.18	2.00	0.00397	0.00087	PASS

LTE Band 40 Subset 2						
Condition		Freq.Error (Hz)	Freq.Error (Hz)	Frequency Stability (ppm)	Frequency Stability (ppm)	Verdict
BANDWIDTH	5MHz					
Temperature	Voltage	16QAM	QPSK	16QAM	QPSK	
Normal (25°C)	Normal	5.70	10.00	0.00242	0.00425	PASS
Extreme (85°C)		1.04	4.00	0.00044	0.00170	PASS
Extreme (80°C)		15.97	10.00	0.00678	0.00425	PASS
Extreme (70°C)		5.92	6.00	0.00252	0.00255	PASS
Extreme (60°C)		12.89	8.00	0.00547	0.00340	PASS
Extreme (50°C)		11.97	6.00	0.00508	0.00255	PASS
Extreme (40°C)		8.40	5.00	0.00356	0.00212	PASS
Extreme (30°C)		17.69	12.00	0.00751	0.00510	PASS
Extreme (20°C)		15.63	3.00	0.00664	0.00127	PASS
Extreme (10°C)		7.86	3.00	0.00334	0.00127	PASS
Extreme (0°C)		12.10	4.00	0.00514	0.00170	PASS
Extreme (-10°C)		17.80	3.00	0.00756	0.00127	PASS
Extreme (-20°C)		12.02	16.00	0.00510	0.00679	PASS
Extreme (-30°C)		2.05	3.00	0.00087	0.00127	PASS
Extreme (-40°C)		2.13	6.00	0.00090	0.00255	PASS
25°C	LV	1.87	16.00	0.00079	0.00679	PASS
	HV	9.65	16.00	0.00410	0.00679	PASS
Condition		Freq.Error (Hz)	Freq.Error (Hz)	Frequency Stability (ppm)	Frequency Stability (ppm)	Verdict
BANDWIDTH	10MHz					
Temperature	Voltage	16QAM	QPSK	16QAM	QPSK	
Normal (25°C)	Normal	5.01	3.00	0.00213	0.00127	PASS
Extreme (85°C)		1.83	4.00	0.00078	0.00170	PASS
Extreme (80°C)		17.55	13.00	0.00745	0.00552	PASS
Extreme (70°C)		13.40	7.00	0.00569	0.00297	PASS
Extreme (60°C)		6.69	13.00	0.00284	0.00552	PASS
Extreme (50°C)		14.95	8.00	0.00635	0.00340	PASS
Extreme (40°C)		10.18	5.00	0.00432	0.00212	PASS
Extreme (30°C)		9.39	5.00	0.00399	0.00212	PASS



Extreme (20°C)		16.75	5.00	0.00711	0.00212	PASS
Extreme (10°C)		1.47	9.00	0.00062	0.00382	PASS
Extreme (0°C)		4.63	8.00	0.00197	0.00340	PASS
Extreme (-10°C)		5.96	12.00	0.00253	0.00510	PASS
Extreme (-20°C)		10.46	12.00	0.00444	0.00510	PASS
Extreme (-30°C)		3.79	17.00	0.00161	0.00722	PASS
Extreme (-40°C)		7.30	8.00	0.00310	0.00340	PASS
25°C	LV	9.49	13.00	0.00403	0.00552	PASS
	HV	13.84	8.00	0.00588	0.00340	PASS

6.6 Spurious Emissions at Antenna Terminals

Sweep the whole frequency band through the range from 9kHz to the 10th harmonic of the carrier, the emissions more than 20 dB below the limit are not reported.

The signal beyond the limit is carrier.

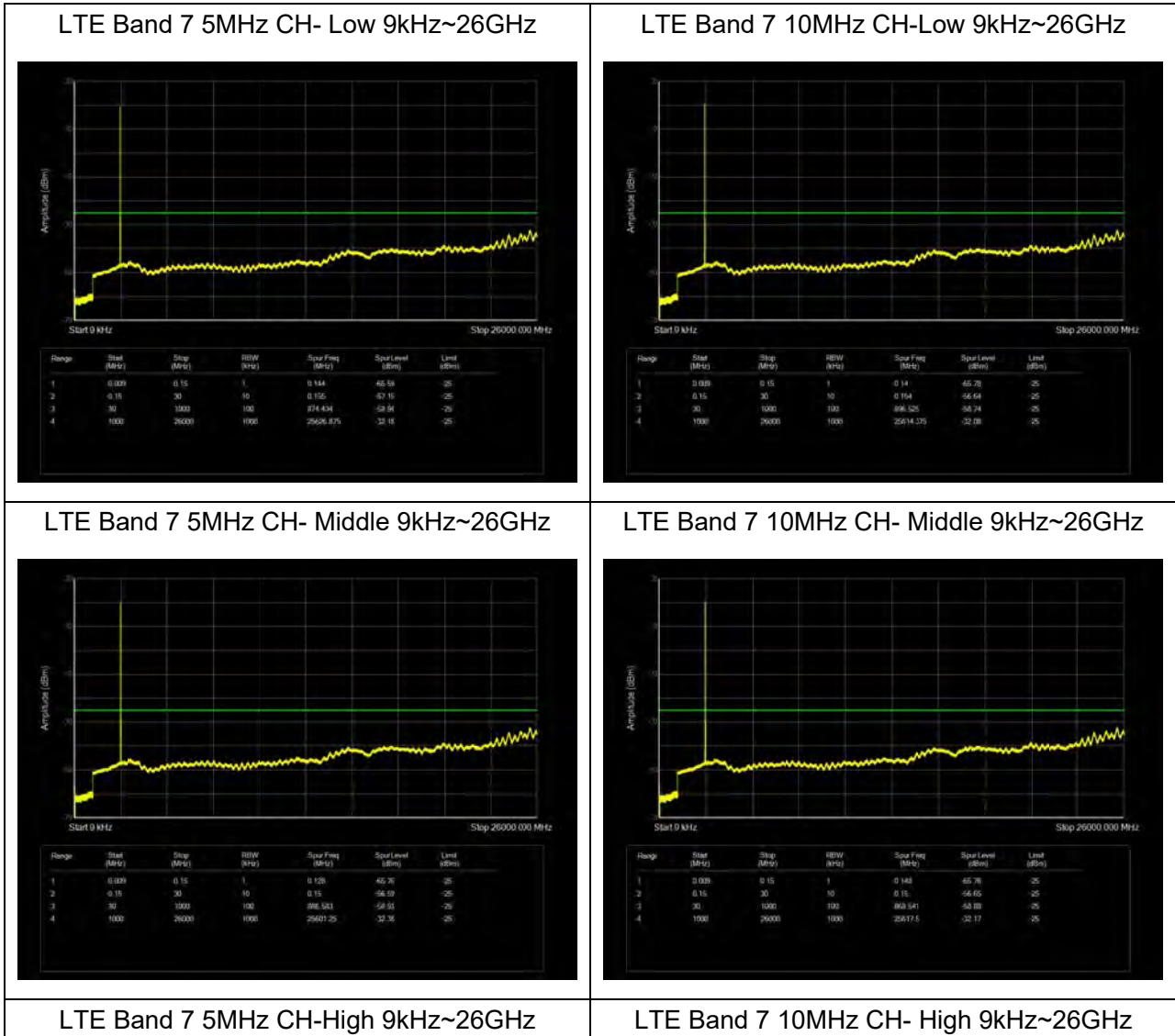

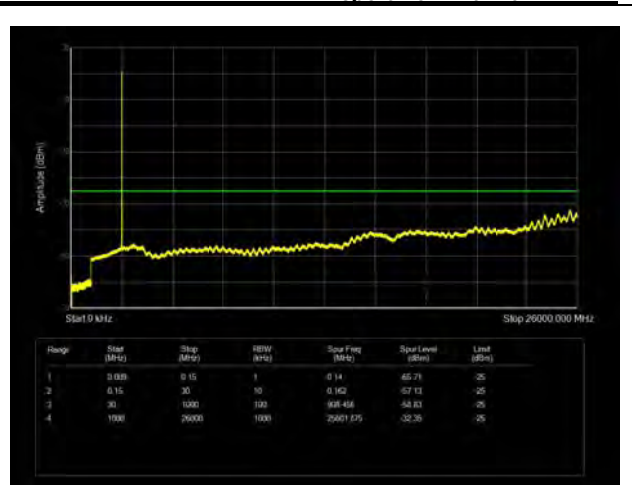
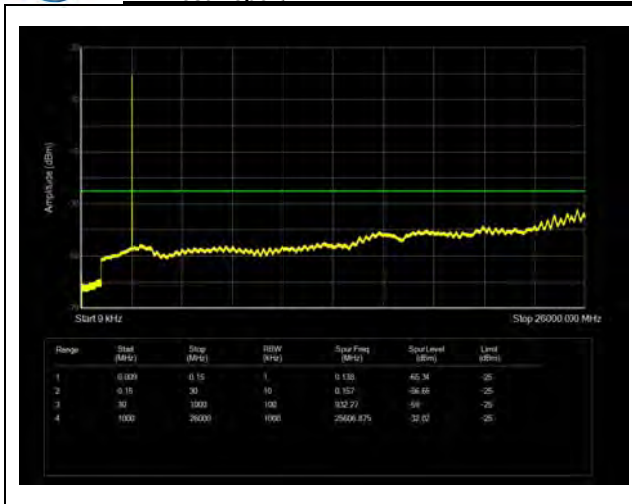

LTE Band 7 15MHz CH- Low 9kHz~26GHz

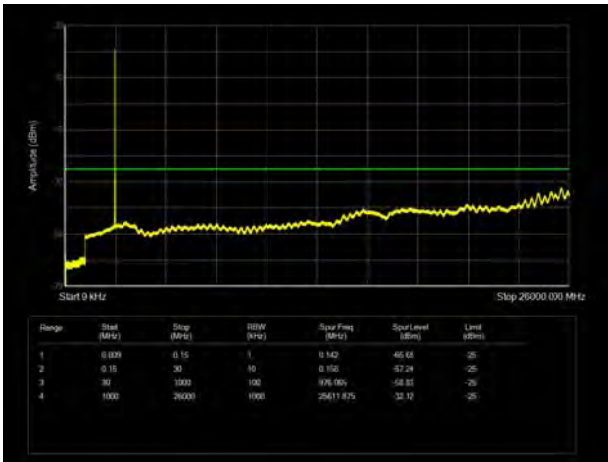

LTE Band 7 20MHz CH-Low 9kHz~26GHz

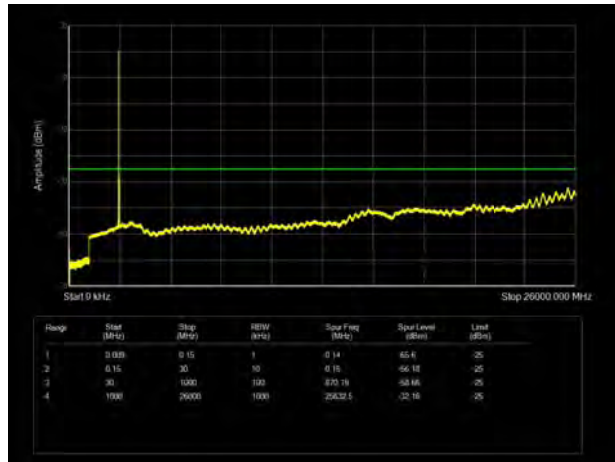

LTE Band 7 15MHz CH- Middle 9kHz~26GHz

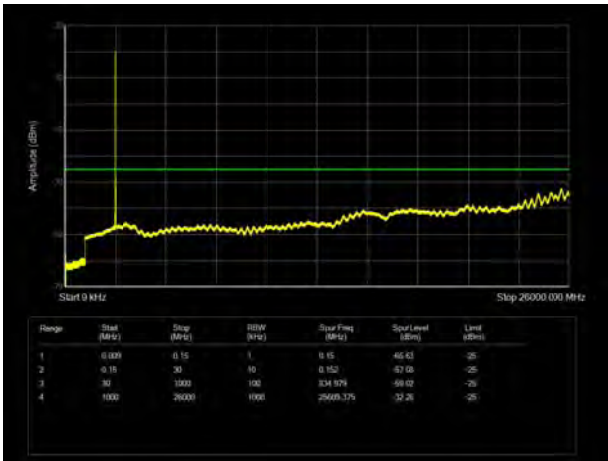

LTE Band 7 20MHz CH- Middle 9kHz~26GHz

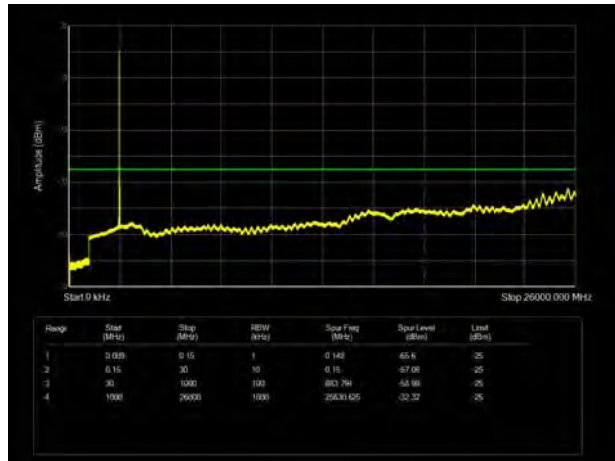

LTE Band 7 15MHz CH-High 9kHz~26GHz

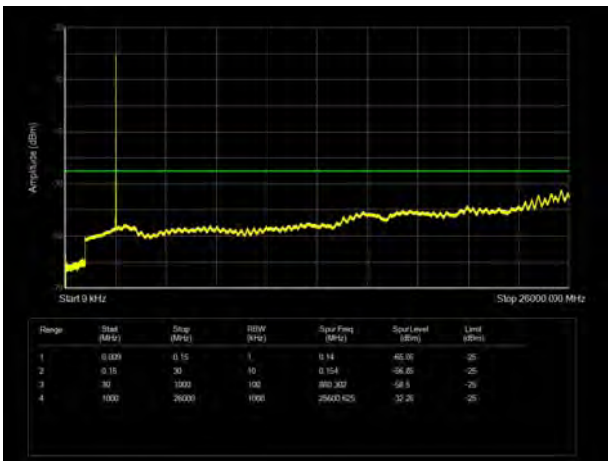

LTE Band 7 20MHz CH- High 9kHz~26GHz

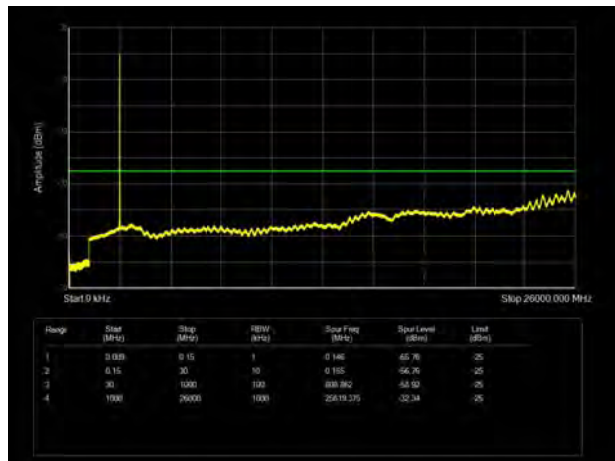



LTE Band 40 Subset 1 5MHz CH- Low 9kHz~30GHz

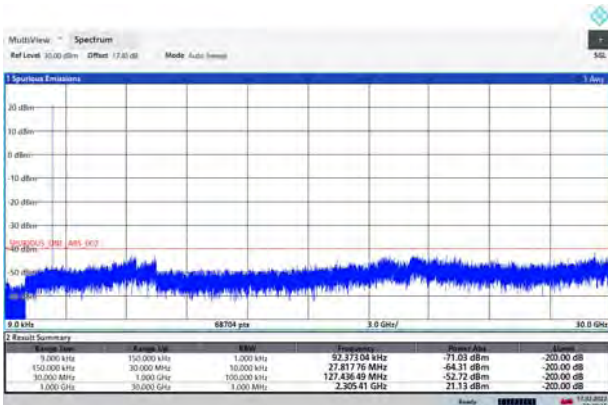

19:36:14 17.02.2022

LTE Band 40 Subset 1 10MHz 9kHz~30GHz

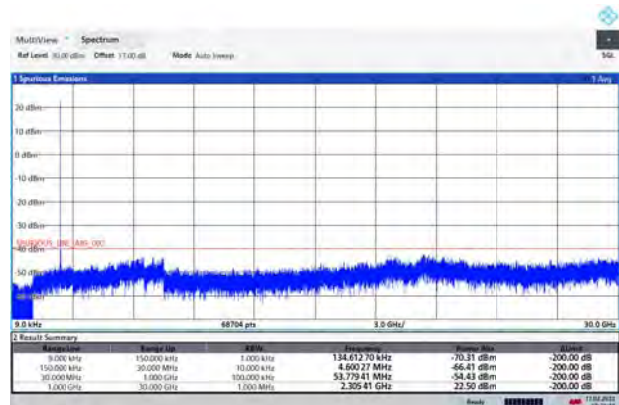

19:38:50 17.02.2022

LTE Band 40 Subset 1 5MHz CH- Middle 9kHz~30GHz



19:37:04 17.02.2022

LTE Band 40 Subset 1 5MHz CH-High 9kHz~30GHz

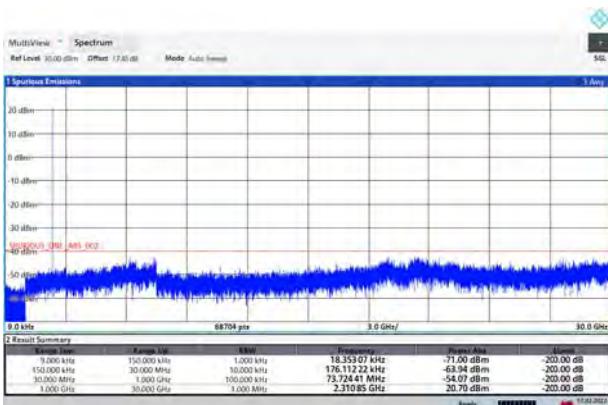

19:37:59 17.02.2022



LTE Band 40 Subset 2 5MHz CH- Low 9kHz~30GHz

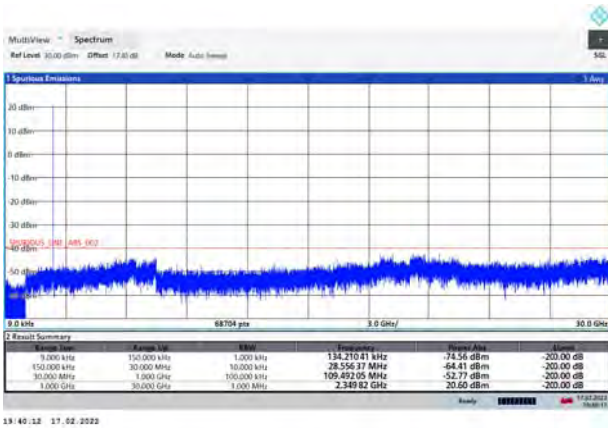

LTE Band 40 Subset 2 10MHz 9kHz~30GHz

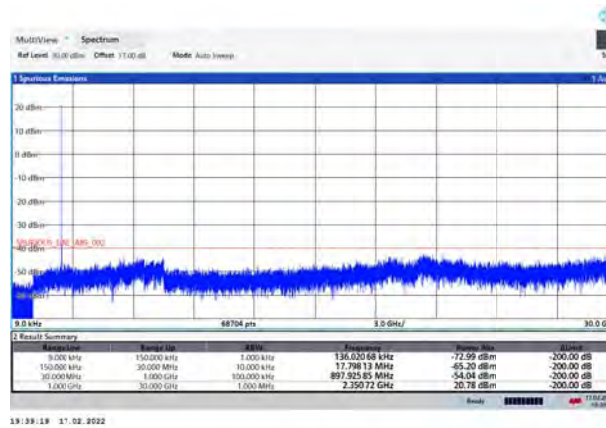

LTE Band 40 Subset 2 5MHz CH- Middle 9kHz~30GHz

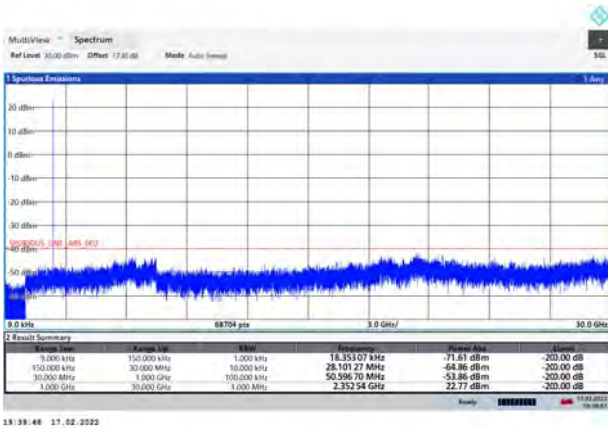

LTE Band 40 Subset 2 5MHz CH-High 9kHz~30GHz





6.7 Radiates Spurious Emission

Sweep the whole frequency band through the range from 9kHz to the 10th harmonic of the carrier, the emissions below the noise floor will not be recorded in the report.

LTE Band 7 QPSK 5MHz CH-Middle, RB 1

Harmonic	Frequency (MHz)	SG (dBm)	Cable Loss (dB)	Gain (dBi)	Antenna Polarization	EIRP Level (dBm)	Limit (dBm)	Margin (dB)	Azimuth (deg)
2	5070.0	-59.89	3.40	12.50	Vertical	-50.79	-25.00	25.79	45
3	7605.0	-59.23	4.40	12.20	Vertical	-51.43	-25.00	26.43	225
4	10140.0	-53.56	4.70	11.30	Vertical	-46.96	-25.00	21.96	0
5	12675.0	-55.02	5.40	13.20	Vertical	-47.22	-25.00	22.22	315
6	15210.0	-53.27	6.10	13.10	Vertical	-46.27	-25.00	21.27	180
7	17745.0	-52.35	6.10	14.20	Vertical	-44.25	-25.00	19.25	225
8	20280.0	--	--	--	--	--	--	--	--
9	22815.0	--	--	--	--	--	--	--	--
10	25350.0	--	--	--	--	--	--	--	--

Note: 1.The other Spurious RF Radiated emissions level is no more than noise floor.
2. The worst emission was found in the antenna is Vertical position.

LTE Band 7 QPSK 20MHz CH-Middle, RB 1

Harmonic	Frequency (MHz)	SG (dBm)	Cable Loss (dB)	Gain (dBi)	Antenna Polarization	EIRP Level (dBm)	Limit (dBm)	Margin (dB)	Azimuth (deg)
2	5070.0	-60.03	3.40	12.50	Vertical	-50.93	-25.00	25.93	135
3	7605.0	-59.59	4.40	12.20	Vertical	-51.79	-25.00	26.79	270
4	10140.0	-53.77	4.70	11.30	Vertical	-47.17	-25.00	22.17	45
5	12675.0	-54.57	5.40	13.20	Vertical	-46.77	-25.00	21.77	0
6	15210.0	-53.30	6.10	13.10	Vertical	-46.30	-25.00	21.30	225
7	17745.0	-53.44	6.10	14.20	Vertical	-45.34	-25.00	20.34	135
8	20280.0	--	--	--	--	--	--	--	--
9	22815.0	--	--	--	--	--	--	--	--
10	25350.0	--	--	--	--	--	--	--	--

Note: 1.The other Spurious RF Radiated emissions level is no more than noise floor.
2. The worst emission was found in the antenna is Vertical position.



LTE Band 40 Subset 1 QPSK 5MHz CH-Middle, RB 1

Harmonic	Frequency (MHz)	SG (dBm)	Cable Loss (dB)	Gain (dBi)	Antenna Polarization	EIRP Level (dBm)	Limit (dBm)	Margin (dB)	Azimuth (deg)
2	4615.00	-71.88	3.20	12.50	Vertical	-62.58	-40.00	22.58	45
3	6922.50	-70.01	4.40	12.30	Vertical	-62.11	-40.00	22.11	315
4	9230.00	-65.77	4.70	11.80	Vertical	-58.67	-40.00	18.67	90
5	11537.50	-64.15	5.40	14.00	Vertical	-55.55	-40.00	15.55	45
6	13845.00	-64.17	6.10	16.80	Vertical	-53.47	-40.00	13.47	315
7	16152.50	-64.88	5.70	14.15	Vertical	-56.43	-40.00	16.43	90
8	18460.00	--	--	--	--	--	--	--	--
9	20767.50	--	--	--	--	--	--	--	--
10	23075.00	--	--	--	--	--	--	--	--

Note: 1.The other Spurious RF Radiated emissions level is no more than noise floor.

2. The worst emission was found in the antenna is Vertical position.

LTE Band 40 Subset 2 QPSK 10MHz CH-Middle, RB 1

Harmonic	Frequency (MHz)	SG (dBm)	Cable Loss (dB)	Gain (dBi)	Antenna Polarization	EIRP Level (dBm)	Limit (dBm)	Margin (dB)	Azimuth (deg)
2	4610.00	-71.69	3.20	12.50	Vertical	-62.39	-40.00	37.39	180
3	6915.00	-70.50	4.40	12.30	Vertical	-62.60	-40.00	37.60	90
4	9220.00	-65.32	4.70	11.80	Vertical	-58.22	-40.00	33.22	315
5	11525.00	-64.46	5.40	14.00	Vertical	-55.86	-40.00	30.86	90
6	13830.00	-64.09	6.10	16.80	Vertical	-53.39	-40.00	28.39	45
7	16135.00	-65.48	5.70	14.15	Vertical	-57.03	-40.00	32.03	225
8	18440.00	--	--	--	--	--	--	--	--
9	20745.00	--	--	--	--	--	--	--	--
10	23050.00	--	--	--	--	--	--	--	--

Note: 1.The other Spurious RF Radiated emissions level is no more than noise floor.

2. The worst emission was found in the antenna is Vertical position.



LTE Band 40 Subset 1 QPSK 5MHz CH-Middle, RB 1

Harmonic	Frequency (MHz)	SG (dBm)	Cable Loss (dB)	Gain (dBi)	Antenna Polarization	EIRP Level (dBm)	Limit (dBm)	Margin (dB)	Azimuth (deg)
2	4705.00	-70.40	3.20	12.50	Vertical	-61.10	-40.00	21.10	135
3	7057.50	-67.68	4.40	12.30	Vertical	-59.78	-40.00	19.78	45
4	9410.00	-65.35	4.70	11.80	Vertical	-58.25	-40.00	18.25	270
5	11762.50	-64.11	5.40	14.00	Vertical	-55.51	-40.00	15.51	90
6	14115.00	-63.17	6.10	16.80	Vertical	-52.47	-40.00	12.47	45
7	16467.50	-63.65	5.70	14.15	Vertical	-55.20	-40.00	15.20	225
8	18820.00	--	--	--	--	--	--	--	--
9	21172.50	--	--	--	--	--	--	--	--
10	23525.00	--	--	--	--	--	--	--	--

Note: 1.The other Spurious RF Radiated emissions level is no more than noise floor.

2. The worst emission was found in the antenna is Vertical position.

LTE Band 40 Subset 2 QPSK 10MHz CH-Middle, RB 1

Harmonic	Frequency (MHz)	SG (dBm)	Cable Loss (dB)	Gain (dBi)	Antenna Polarization	EIRP Level (dBm)	Limit (dBm)	Margin (dB)	Azimuth (deg)
2	4700.00	-70.52	3.20	12.50	Vertical	-61.22	-40.00	36.22	135
3	7050.00	-66.89	4.40	12.30	Vertical	-58.99	-40.00	33.99	180
4	9400.00	-64.85	4.70	11.80	Vertical	-57.75	-40.00	32.75	315
5	11750.00	-64.04	5.40	14.00	Vertical	-55.44	-40.00	30.44	90
6	14100.00	-64.03	6.10	16.80	Vertical	-53.33	-40.00	28.33	45
7	16450.00	-64.63	5.70	14.15	Vertical	-56.18	-40.00	31.18	225
8	18800.00	--	--	--	--	--	--	--	--
9	21150.00	--	--	--	--	--	--	--	--
10	23500.00	--	--	--	--	--	--	--	--

Note: 1.The other Spurious RF Radiated emissions level is no more than noise floor.

2. The worst emission was found in the antenna is Vertical position.



7 Main Test Instruments

Name	Manufacturer	Type	Serial Number	Calibration Date	Expiration Date
Base Station Simulator	R&S	CMW500	113824	2021-05-15	2022-05-14
Climate Chamber	Weiss	VT4002	58226119450010	2021-05-15	2022-05-14
Spectrum Analyzer	Keysight	N9020A	MY52330084	2021-05-15	2022-05-14
Signal Analyzer	R&S	FSV3030	101411	2021-12-12	2022-12-11
Signal Analyzer	R&S	FSV30	104028	2021-05-15	2022-05-14
Horn Antenna	ETS-Lindgren	3160-09	00102643	2021-10-10	2024-10-09
Horn Antenna	Schwarzbeck	BBHA 9120D	1594	2020-12-17	2023-12-16
Software	R&S	EMC32	9.26.0	/	/

*****END OF REPORT *****



ANNEX A: The EUT Appearance

The EUT Appearance are submitted separately.



ANNEX B: Test Setup Photos

The Test Setup Photos are submitted separately.