



RF TEST REPORT

Applicant MeiG Smart Technology Co., Ltd
FCC ID 2APJ4-SLM750VA
Product SLM750
Brand MEIGLink
Model SLM750
Report No. R2208A0783-R2
Issue Date September 9, 2022

TA Technology (Shanghai) Co., Ltd. tested the above equipment in accordance with the requirements in **FCC CFR47 Part 2 (2021)/ FCC CFR 47 Part 24E (2021)**. The test results show that the equipment tested is capable of demonstrating compliance with the requirements as documented in this report.

Prepared by: Xu Ying

Approved by: Xu Kai

TA Technology (Shanghai) Co., Ltd.

Building 3, No.145, Jintang Rd, Tangzhen Industry Park, Pudong Shanghai, China

TEL: +86-021-50791141/2/3

FAX: +86-021-50791141/2/3-8000



TABLE OF CONTENT

1. Test Laboratory	4
1.1. Notes of the test report	4
1.2. Test facility	4
1.3. Testing Location	4
2. General Description of Equipment under Test	5
2.1. Applicant and Manufacturer Information	5
2.2. General information	5
3. Applied Standards	7
4. Test Configuration	8
5. Test Case	10
5.1. RF Power Output and Effective Isotropic Radiated Power	10
5.2. Occupied Bandwidth	11
5.3. Band Edge	12
5.4. Peak-to-Average Power Ratio (PAPR)	13
5.5. Frequency Stability	14
5.6. Spurious Emissions at Antenna Terminals	16
5.7. Radiates Spurious Emission	17
6. Test Results	20
6.1. RF Power Output and Effective Isotropic Radiated Power	20
6.2. Occupied Bandwidth	28
6.3. Band Edge	45
6.4. Peak-to-Average Power Ratio (PAPR)	63
6.5. Frequency Stability	66
6.6. Spurious Emissions at Antenna Terminals	70
6.7. Radiates Spurious Emission	84
7. Main Test Instruments	89
ANNEX A: The EUT Appearance	90
ANNEX B: Test Setup Photos	91
ANNEX C: Product Change Description	92



Summary of measurement results

No.	Test Case	Clause in FCC rules	Verdict
1	RF Power Output and Effective Isotropic Radiated Power	2.1046 24.232(c)	PASS
2	Occupied Bandwidth	2.1049	PASS
3	Band Edge	2.1051 / 24.238(a)	PASS
4	Peak-to-Average Power Ratio	24.232/KDB 971168 D01(5.7)	PASS
5	Frequency Stability	2.1055 / 24.235	PASS
6	Spurious Emissions at Antenna Terminals	2.1051 / 24.238(a)	PASS
7	Radiates Spurious Emission	2.1053 / 24.238(a)	PASS

Date of Testing: September 3, 2019 ~ September 24, 2019

Date of Sample Received: (R2208A0783): August 25, 2022

Note: 1. PASS: The EUT complies with the essential requirements in the standard.

FAIL: The EUT does not comply with the essential requirements in the standard.

All indications of Pass/Fail in this report are opinions expressed by TA Technology (Shanghai) Co., Ltd. based on interpretations and/or observations of test results. Measurement Uncertainties were not taken into account and are published for informational purposes only.

2. SLM750 (Report No.: R2208A0783-R2) is a variant model of SLM750 (Report No.: R1908A0527-R2V1). Test values all duplicated from Original for variant. There is no test for variant in this report.

The difference between model SLM750 (Variant) and SLM750 (Original) is show in the below table:

	Model	SLM750 (Variant)	SLM750 (Original)
Hardware	Hardware Version	SLM750-V_MB_V1.01	SLM750-V_MB_V1.00
Software	Software Version	SLM750-V_4.0.14_EQ101	SLM750-V_2.0.2D_EQ100
	Frequency band	Software opens B7 and b66 frequency bands	/
Others	The same		

Notes: The SLM750 (Variant) support LTE band 2/4/5/7/12/13/17/25/26/41/66, WCDMA B2/4/5, GSM 850/1900;

The SLM750 (Original) support LTE band 2/4/5/12/13/17/25/26/41, WCDMA B2/4/5, GSM 850/1900;

The detailed product change description please refers to the Difference Declaration Letter.



1. Test Laboratory

1.1. Notes of the test report

This report shall not be reproduced in full or partial, without the written approval of **TA technology (shanghai) co., Ltd.** The results documented in this report apply only to the tested sample, under the conditions and modes of operation as described herein. Measurement Uncertainties were not taken into account and are published for informational purposes only. This report is written to support regulatory compliance of the applicable standards stated above.

1.2. Test facility

FCC (Designation number: CN1179, Test Firm Registration Number: 446626)

TA Technology (Shanghai) Co., Ltd. has been listed on the US Federal Communications Commission list of test facilities recognized to perform measurements.

A2LA (Certificate Number: 3857.01)

TA Technology (Shanghai) Co., Ltd. has been listed by American Association for Laboratory Accreditation to perform measurement.

1.3. Testing Location

Company: TA Technology (Shanghai) Co., Ltd.
Address: Building 3, No.145, Jintang Rd, Tangzhen Industry Park, Pudong Shanghai, China
City: Shanghai
Post code: 201201
Country: P. R. China
Contact: Xu Kai
Telephone: +86-021-50791141/2/3
Fax: +86-021-50791141/2/3-8000
Website: <http://www.ta-shanghai.com>
E-mail: xukai@ta-shanghai.com

2. General Description of Equipment under Test

2.1. Applicant and Manufacturer Information

Applicant	MeiG Smart Technology Co., Ltd
Applicant address	2nd Floor,Office Building,No.5 Lingxia Road,Fenghuang,Fuyong Street,Bao'an District,Shenzhen
Manufacturer	MeiG Smart Technology Co., Ltd
Manufacturer address	2nd Floor,Office Building,No.5 Lingxia Road,Fenghuang,Fuyong Street,Bao'an District,Shenzhen

2.2. General information

EUT Description			
Model	SLM750		
IMEI	863879041726491		
Hardware Version	SLM750-V_MB_V1.01		
Software Version	SLM750-V_4.0.14_EQ101		
Power Supply	External Power Supply		
Antenna Type	The EUT don't have standard Antenna. The Antenna used for testing in this report is the after-market accessory.		
Antenna Gain	2.5dBi		
Test Mode(s)	GSM1900; WCDMA Band II; LTE Band 2/25;		
Test Modulation	(GSM)GMSK,8PSK; (WCDMA) BPSK, QPSK, 16QAM; (LTE)QPSK, 16QAM		
GPRS Multislot Class	12		
EGPRS Multislot Class	8		
HSDPA UE Category	8		
HSUPA UE Category	6		
LTE Category	4		
Maximum E.I.R.P	GSM 1900:	32.48dBm	
	WCDMA Band II:	25.31dBm	
	LTE Band 2:	25.35dBm	
	LTE Band 25:	24.87dBm	
Rated Power Supply Voltage	3.8V		
Operating Voltage	Minimum: 3.3V Maximum: 4.2V		
Operating Temperature	Lowest: -40°C Highest: +85°C		
Testing Temperature	Lowest: -40°C Highest: +90°C		
Operating Frequency Range(s)	Band	Tx (MHz)	Rx (MHz)
	GSM1900	1850 ~ 1910	1930 ~ 1990
	WCDMA Band II	1850 ~ 1910	1930 ~ 1990
	LTE Band 2	1850 ~ 1910	1930 ~ 1990



	LTE Band 25	1850 ~ 1915	1930 ~ 1995
Note: The EUT is sent from the applicant to TA and the information of the EUT is declared by the applicant.			

3. Applied Standards

According to the specifications of the manufacturer, it must comply with the requirements of the following standards:

Test standards:

FCC CFR 47 Part 24E (2021)

FCC CFR47 Part 2 (2021)

Reference standard:

ANSI C63.26-2015

KDB 971168 D01 Power Meas License Digital Systems v03r01

4. Test Configuration

Radiated measurements are performed by rotating the EUT in three different orthogonal test planes. EUT stand-up position (Z axis), lie-down position (X, Y axis). Receiver antenna polarization (horizontal and vertical), the worst emission was found in position (X axis, vertical polarization) and the worst case was recorded.

All mode and data rates and positions and RB size and modulations were investigated.

Subsequently, only the worst case emissions are reported.

The following testing in GSM/WCDMA/LTE is set based on the maximum RF Output Power.

Test modes are chosen to be reported as the worst case configuration below:

Test items	Modes/Modulation	
	GSM 1900	WCDMA Band II
RF power output	GSM GPRS EGPRS	RMC HSDPA/HSUPA DC-HSDPA
Effective Isotropic Radiated power	GSM GPRS(1Tx slot) EGPRS(1Tx slot)	RMC
Occupied Bandwidth	GSM GPRS(1Tx slot) EGPRS(1Tx slot)	RMC
Band Edge	GSM GPRS(1Tx slot) EGPRS(1Tx slot)	RMC
Peak-to-Average Power Ratio	GSM GPRS(1Tx slot) EGPRS(1Tx slot)	RMC
Frequency Stability	GSM GPRS(1Tx slot) EGPRS(1Tx slot)	RMC
Spurious Emissions at Antenna Terminals	GSM	RMC
Radiates Spurious Emission	GSM	RMC



Test modes are chosen to be reported as the worst case configuration below for LTE Band 2/25:

Test items	Bandwidth (MHz)						Modulation		RB			Test Channel		
	1.4	3	5	10	15	20	QPSK	16QAM	1	50%	100%	L	M	H
RF power output	O	O	O	O	O	O	O	O	O	O	O	O	O	O
Effective Isotropic Radiated power	O	O	O	O	O	O	O	O	O	O	O	O	O	O
Occupied Bandwidth	O	O	O	O	O	O	O	O	-	-	O	O	O	O
Band Edge	O	O	O	O	O	O	O	O	O	-	O	O	-	O
Peak-to-Average Power Ratio	O	O	O	O	O	O	O	O	-	-	O	O	O	O
Frequency Stability	O	O	O	O	O	O	O	O	O	O	O	O	O	O
Conducted Spurious Emissions	O	O	O	O	O	O	O	-	O	-	-	O	O	O
Radiates Spurious Emission	O	-	O	-	-	O	O	-	O	-	-	-	O	-
Note	1. The mark "O" means that this configuration is chosen for testing. 2. The mark "-" means that this configuration is not testing.													

5. Test Case

5.1.RF Power Output and Effective Isotropic Radiated Power

Ambient condition

Temperature	Relative humidity	Pressure
23°C ~25°C	45%~50%	101.5kPa

Methods of Measurement

During the process of the testing, The EUT was connected to the Base Station Simulator with a known loss. The EUT is controlled by the Base Station Simulator test set to ensure max power transmission with proper modulation.

ERP can then be calculated as follows:

$$\text{EIRP (dBm)} = \text{Output Power (dBm)} - \text{Losses (dB)} + \text{Antenna Gain (dBi)}$$

where:dBd refers to gain relative to an ideal dipole.

$$\text{EIRP (dBm)} = \text{ERP (dBm)} + 2.15 \text{ (dB.)}$$

Test Setup

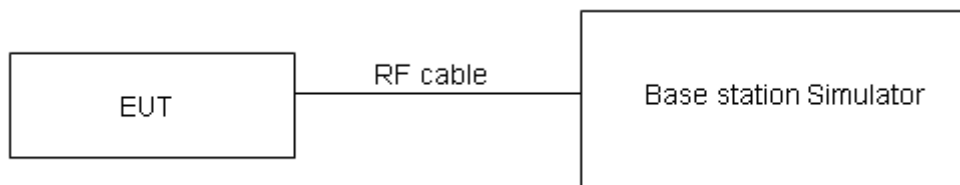

Limits

No specific RF power output requirements in part 2.1046.

Rule Part 24.232(c) Mobile and portable stations are limited to 2 watts EIRP.

Rule Part 24.232(e) Peak transmit power must be measured over any interval of continuous transmission using instrumentation calibrated in terms of an rms-equivalent voltage.

Limit	$\leq 2 \text{ W}$ (33 dBm)
-------	-----------------------------

Measurement Uncertainty

The assessed measurement uncertainty to ensure 95% confidence level for the normal distribution is with the coverage factor $k = 2$, $U = 0.4 \text{ dB}$ for RF power output, $k = 2$, $U = 1.19 \text{ dB}$ for EIRP.

Test Results

Refer to the section 6.1 of this report for test data.

5.2.Occupied Bandwidth

Ambient condition

Temperature	Relative humidity	Pressure
23°C ~25°C	45%~50%	101.5kPa

Method of Measurement

The EUT was connected to Spectrum Analyzer and Base Station Simulator via power Splitter. The occupied bandwidth is measured using spectrum analyzer.

RBW is set to $\geq 1\%EBW$, VBW is set to 3x RBW.

99% power and -26dBc occupied bandwidths are recorded. Spectrum analyzer plots are included on the following pages.

Test Setup

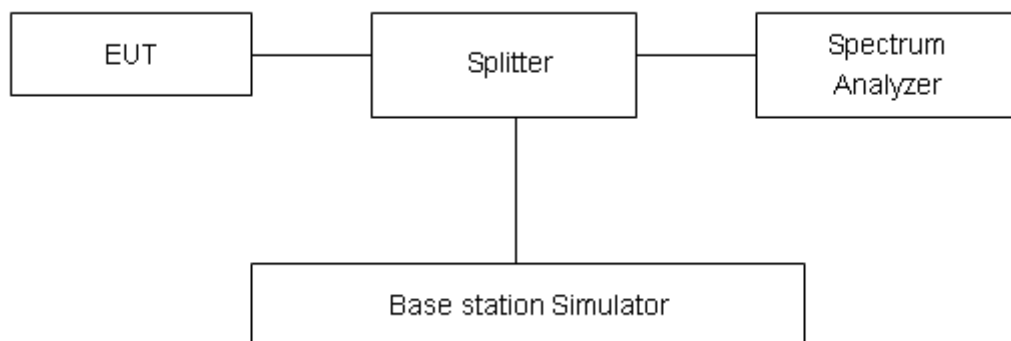

Limits

No specific occupied bandwidth requirements in part 2.1049.

Measurement Uncertainty

The assessed measurement uncertainty to ensure 95% confidence level for the normal distribution is with the coverage factor $k = 2$, $U = 624\text{Hz}$.

Test Results

Refer to the section 6.2 of this report for test data.

5.3. Band Edge

Ambient condition

Temperature	Relative humidity	Pressure
23°C ~25°C	45%~50%	101.5kPa

Method of Measurement

The EUT was connected to Spectrum Analyzer and Base Station Simulator via power Splitter. The band edge of the lowest and highest channels were measured. The Average detector is used and RBW is set to $\geq 1\%EBW$, VBW is set to 3x RBW.

Spectrum analyzer plots are included on the following pages.

Test Setup

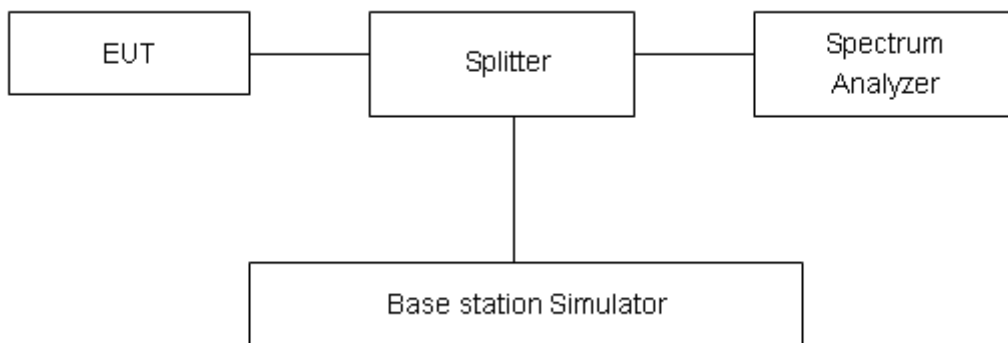

Limits

Rule Part 24.238(a) specifies that “on any frequency outside a licensee's frequency block, the power of any emission shall be attenuated below the transmitter power (P) by at least $43 + 10 \log_{10} (P)$ dB.”

Limit	-13 dBm
-------	---------

Measurement Uncertainty

The assessed measurement uncertainty to ensure 95% confidence level for the normal distribution is with the coverage factor $k = 1.96$, $U=0.684dB$.

Test Results

Refer to the section 6.3 of this report for test data.

5.4. Peak-to-Average Power Ratio (PAPR)

Ambient condition

Temperature	Relative humidity	Pressure
23°C ~25°C	45%~50%	101.5kPa

Methods of Measurement

Measure the total peak power and record as PPK. And measure the total average power and record as PAvg. Both the peak and average power levels must be expressed in the same logarithmic units (e.g., dBm). Determine the PAPR from:

$$PAPR (dB) = PPk (dBm) - PAvg (dBm).$$

Test Setup

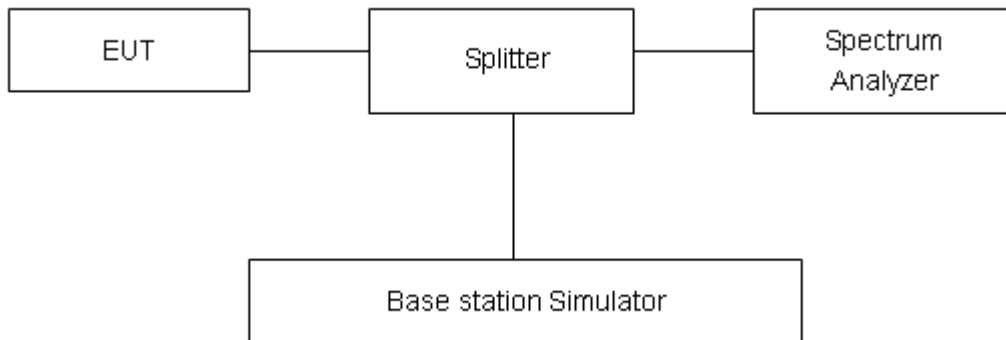

Limits

In measuring transmissions in this band using an average power technique, the peak-to-average ratio (PAR) of the transmission may not exceed 13 dB in 24.232(d).

Measurement Uncertainty

The assessed measurement uncertainty to ensure 95% confidence level for the normal distribution is with the coverage factor $k = 2$, $U = 0.4$ dB.

Test Results

Refer to the section 6.4 of this report for test data.

5.5. Frequency Stability

Ambient condition

Temperature	Relative humidity	Pressure
23°C ~25°C	45%~50%	101.5kPa

Method of Measurement

Frequency Stability (Temperature Variation)

The temperature inside the climate chamber is varied from -40°C to +85°C in 10°C step size,

(1) With all power removed, the temperature was decreased to 0°C and permitted to stabilize for three hours.

(2) Measure the carrier frequency with the test equipment in a “call mode”. These measurements should be made within 1 minute of powering up the mobile station, to prevent significant self warming.

(3) Repeat the above measurements at 10°C increments from -40°C to +85°C. Allow at least 1.5 hours at each temperature, un-powered, before making measurements.

Frequency Stability (Voltage Variation)

The frequency stability shall be measured with variation of primary supply voltage as follows:

Primary Supply Voltage: The primary supply voltage is varied from 85% to 115% of the nominal value for non hand-carried battery and AC powered equipment. For hand-carried, battery-powered equipment, primary supply voltage is reduced to the battery operating end point which shall be specified by the manufacturer.

This transceiver is specified to operate with an input voltage of between 3.3 V and 4.2 V, with a nominal voltage of 3.8V

Test setup

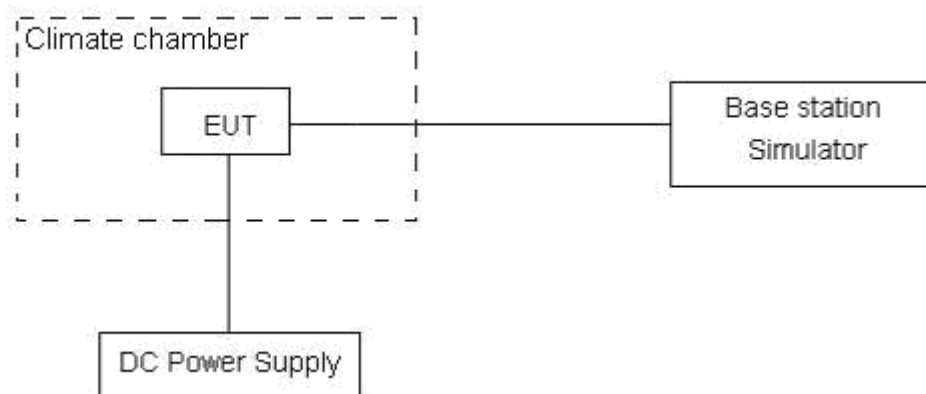

**Limits**

The frequency stability shall be sufficient to ensure that the fundamental emission stays within the authorized frequency block

Measurement Uncertainty

The assessed measurement uncertainty to ensure 99.75% confidence level for the normal distribution is with the coverage factor $k = 3$, $U = 0.01\text{ppm}$.

Test Results

Refer to the section 6.5 of this report for test data.

5.6. Spurious Emissions at Antenna Terminals

Ambient condition

Temperature	Relative humidity	Pressure
23°C ~25°C	45%~50%	101.5kPa

Method of Measurement

The EUT was connected to Spectrum Analyzer and Base Station Simulator via power Splitter. The measurement is carried out using a spectrum analyzer. The spectrum analyzer scans from 9kHz to the 10th harmonic of the carrier. The peak detector is used.

RBW is set to 100kHz, VBW is set to 300kHz for 30MHz~1GHz

RBW is set to 1MHz, VBW is set to 3MHz for above 1GHz, Sweep is set to ATUO.

The modulation mode and RB allocation refer to section 5.1, using the maximum output power configuration.

Test setup

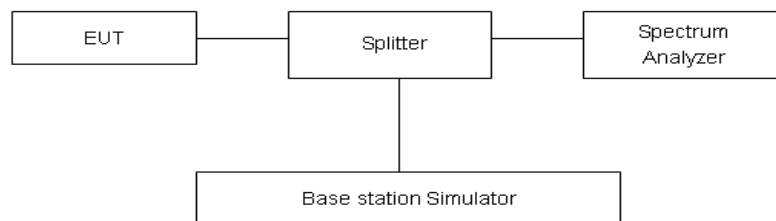

Limits

Rule Part 24.238(a) specifies that “on any frequency outside a licensee's frequency block, the power of any emission shall be attenuated below the transmitter power (P) by at least $43 + 10 \log_{10}(P)$ dB.”

Limit	-13 dBm

Measurement Uncertainty

The assessed measurement uncertainty to ensure 99.75% confidence level for the normal distribution is with the coverage factor $k = 1.96$.

Frequency	Uncertainty
9kHz-1GHz	0.684 dB
1GHz-20GHz	1.407 dB

Test Results

Refer to the section 6.6 of this report for test data.

5.7. Radiates Spurious Emission

Ambient condition

Temperature	Relative humidity	Pressure
23°C ~25°C	45%~50%	101.5kPa

Method of Measurement

1. The testing follows FCC KDB 971168 v03r01 Section 5.8 and ANSI C63.26-2015.
2. Below 1GHz: The EUT is placed on a turntable 0.8 meters above the ground in the chamber, 3 meter away from the antenna. The maximal emission value is acquired by adjusting the antenna height, polarisation and turntable azimuth. Normally, the height range of antenna is 1 m to 4 m, the azimuth range of turntable is 0° to 360°, and the receive antenna has two polarizations Vertical (V) and Horizontal (H). Above 1GHz: (Note: the FCC's permission to use 1.5m as an alternative per TCBC Conf call of Dec. 2, 2014.) The EUT is placed on a turntable 1.5 meters above the ground in the chamber, 3 meter away from the antenna. The maximal emission value is acquired by adjusting the antenna height, polarisation and turntable azimuth. Normally, the height range of antenna is 1 m to 4 m, the azimuth range of turntable is 0° to 360°, and the receive antenna has two polarizations Vertical (V) and Horizontal (H).
3. A loop antenna, A log-periodic antenna or horn antenna shall be substituted in place of the EUT. The log-periodic antenna will be driven by a signal generator and the level will be adjusted till the same power value on the spectrum analyzer or receiver. The level of the spurious emissions can be calculated through the level of the signal generator, cable loss, the gain of the substitution antenna and the reading of the spectrum analyzer or receiver.
4. The EUT is then put into continuously transmitting mode at its maximum power level during the test. Set Test Receiver or Spectrum RBW=1MHz, VBW=3MHz, and the maximum value of the receiver should be recorded as (Pr).
5. The EUT shall be replaced by a substitution antenna. In the chamber, an substitution antenna for the frequency band of interest is placed at the reference point of the chamber. An RF Signal source for the frequency band of interest is connected to the substitution antenna with a cable that has been constructed to not interfere with the radiation pattern of the antenna. A power (PMea) is applied to the input of the substitution antenna, and adjust the level of the signal generator output until the value of the receiver reach the previously recorded (Pr). The power of signal source (PMea) is recorded. The test should be performed by rotating the test item and adjusting the receiving antenna polarization.
6. A amplifier should be connected to the Signal Source output port. And the cable should be connect between the Amplifier and the Substitution Antenna. The cable loss (Pcl) ,the Substitution Antenna Gain (Ga) and the Amplifier Gain (PAg) should be recorded after test.
7. The measurement results are obtained as described below:
Power(EIRP)=PMea- PAg - Pcl + Ga
The measurement results are amend as described below:
Power(EIRP)=PMea- Pcl + Ga
8. This value is EIRP since the measurement is calibrated using an antenna of known gain (2.15 dB) and known input power. ERP can be calculated from EIRP by subtracting the gain of the dipole, ERP

= EIRP-2.15dB.

The modulation mode and RB allocation refer to section 5.1, using the maximum output power configuration.

Test setup

9KHz~ 30MHz

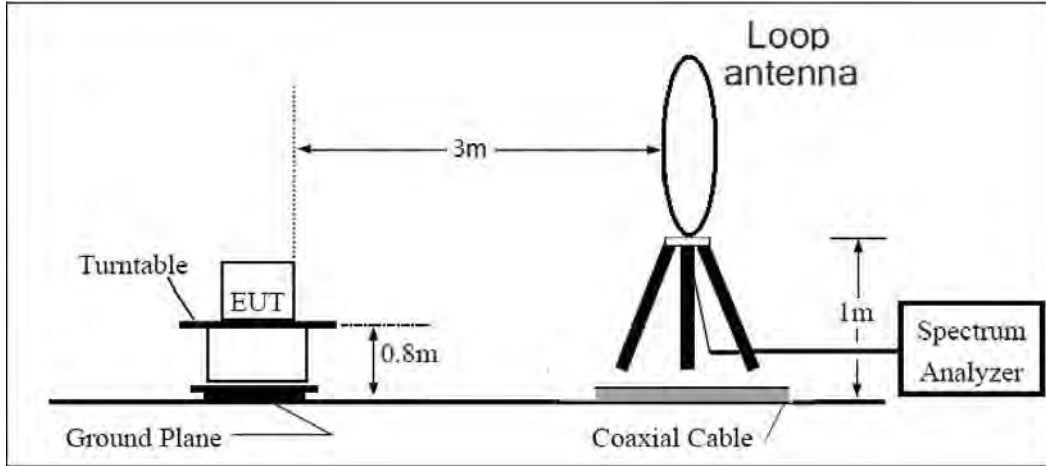

30MHz~ 1GHz

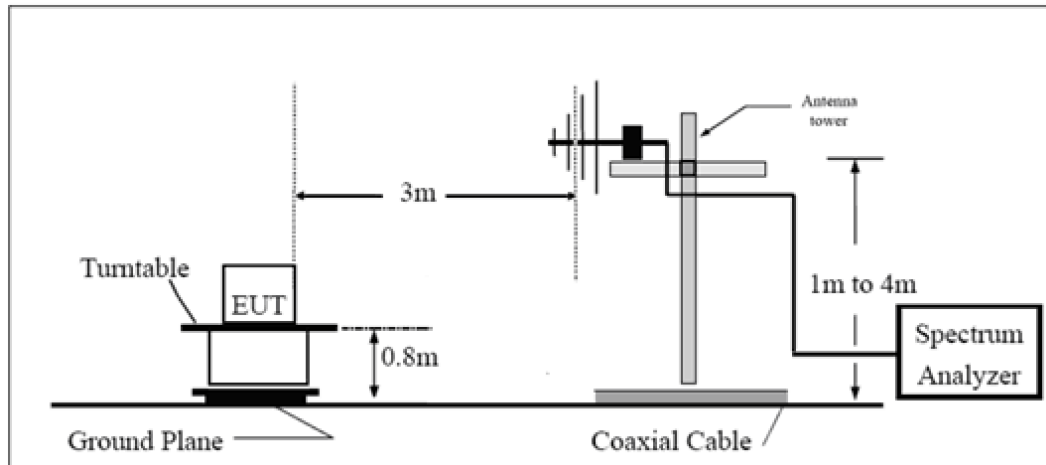

Above 1GHz

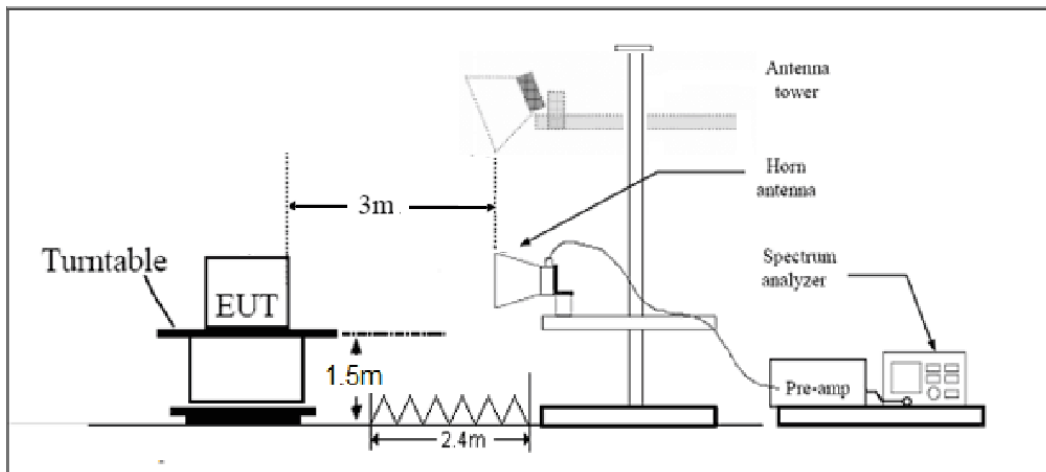

Note: Area side: 2.4mX3.6m

**Limits**

Rule Part 24.238(a) specifies that “on any frequency outside a licensee's frequency block, the power of any emission shall be attenuated below the transmitter power (P) by at least $43 + 10 \log_{10}(P)$ dB.”

Limit	-13 dBm
-------	---------

Measurement Uncertainty

The assessed measurement uncertainty to ensure 95% confidence level for the normal distribution is with the coverage factor $k = 1.96$, $U = 3.55$ dB.

Test Results

Refer to the section 6.7 of this report for test data.

6. Test Results

6.1. RF Power Output and Effective Isotropic Radiated Power

GSM 1900		Maximum Output Power (dBm)			EIRP (dBm)		
		Channel 512	Channel 661	Channel 810	Channel 512	Channel 661	Channel 810
		1850.2 (MHz)	1880 (MHz)	1909.8 (MHz)	1850.2 (MHz)	1880 (MHz)	1909.8 (MHz)
GSM(GMSK)	Results	29.07	29.15	29.20	31.57	31.65	31.70
GPRS (GMSK)	1TXslot	29.07	29.22	29.20	31.57	31.72	31.70
	2TXslots	29.01	29.15	29.14	31.51	31.65	31.64
	3TXslots	28.86	29.08	29.98	31.36	31.58	32.48
	4TXslots	28.71	29.83	29.26	31.21	32.33	31.76
EGPRS	1TXslot	24.90	25.02	24.92	27.40	27.52	27.42
	2TXslots	24.87	24.94	24.82	27.37	27.44	27.32
	3TXslots	24.62	24.72	24.74	27.12	27.22	27.24
	4TXslots	24.54	24.92	24.66	27.04	27.42	27.16



WCDMA Band II		Maximum Output Power (dBm)			EIRP (dBm)		
		Channel 9262	Channel 9400	Channel 9538	Channel 9262	Channel 9400	Channel 9538
		1852.4 (MHz)	1880 (MHz)	1907.6 (MHz)	1852.4 (MHz)	1880 (MHz)	1907.6 (MHz)
RMC		22.80	22.81	22.79	25.30	25.31	25.29
HSDPA	Sub - Test 1	22.26	22.23	22.23	24.76	24.73	24.73
	Sub - Test 2	22.25	22.25	22.20	24.75	24.75	24.70
	Sub - Test 3	21.72	21.75	21.72	24.22	24.25	24.22
	Sub - Test 4	21.73	21.76	21.70	24.23	24.26	24.20
HSUPA	Sub - Test 1	22.22	22.22	22.18	24.72	24.72	24.68
	Sub - Test 2	21.21	21.20	21.17	23.71	23.70	23.67
	Sub - Test 3	21.68	21.68	21.66	24.18	24.18	24.16
	Sub - Test 4	21.14	21.17	21.14	23.64	23.67	23.64
	Sub - Test 5	22.15	22.15	22.12	24.65	24.65	24.62
DC-HSDPA	Sub - Test 1	22.14	22.17	22.13	24.64	24.67	24.63
	Sub - Test 2	22.13	22.16	22.12	24.63	24.66	24.62
	Sub - Test 3	21.71	21.65	21.63	24.21	24.15	24.13
	Sub - Test 4	21.70	21.64	21.62	24.20	24.14	24.12



LTE Band 2				Maximum Output Power(dBm)			EIRP (dBm)		
BW	Modulation	RB size	RB offset	Channel/Frequency(MHz)					
				18607/1850.7	18900/1880	19193/1909.3	18607/1850.7	18900/1880	19193/1909.3
1.4MHz	QPSK	1	0	22.83	22.31	21.95	25.33	24.81	24.45
		1	2	22.49	22.30	22.31	24.99	24.80	24.81
		1	5	22.62	22.11	22.09	25.12	24.61	24.59
		3	0	21.13	21.11	21.20	23.63	23.61	23.70
		3	2	21.12	21.06	21.12	23.62	23.56	23.62
		3	3	21.20	21.04	20.96	23.70	23.54	23.46
		6	0	21.14	21.15	21.10	23.64	23.65	23.60
	16QAM	1	0	21.16	21.78	21.40	23.66	24.28	23.90
		1	2	21.11	21.82	21.50	23.61	24.32	24.00
		1	5	20.46	21.62	21.49	22.96	24.12	23.99
		3	0	20.05	20.07	20.00	22.55	22.57	22.50
		3	2	20.04	20.08	20.01	22.54	22.58	22.51
		3	3	20.01	20.17	19.96	22.51	22.67	22.46
		6	0	20.16	20.17	20.13	22.66	22.67	22.63
BW	Modulation	RB size	RB offset	Channel/Frequency(MHz)					
				18615/1851.5	18900/1880	19185/1908.5	18615/1851.5	18900/1880	19185/1908.5
3MHz	QPSK	1	0	22.85	22.35	21.98	25.35	24.85	24.48
		1	7	22.52	22.35	22.35	25.02	24.85	24.85
		1	14	22.65	22.16	22.13	25.15	24.66	24.63
		8	0	21.21	21.21	21.31	23.71	23.71	23.81
		8	4	21.22	21.14	21.22	23.72	23.64	23.72
		8	7	21.28	21.13	21.04	23.78	23.63	23.54
		15	0	21.17	21.19	21.13	23.67	23.69	23.63
	16QAM	1	0	21.19	21.80	21.43	23.69	24.30	23.93
		1	7	21.14	21.87	21.54	23.64	24.37	24.04
		1	14	20.48	21.66	21.52	22.98	24.16	24.02
		8	0	20.14	20.18	20.10	22.64	22.68	22.60
		8	4	20.13	20.19	20.11	22.63	22.69	22.61
		8	7	20.09	20.27	20.07	22.59	22.77	22.57
		15	0	20.19	20.21	20.16	22.69	22.71	22.66
BW	Modulation	RB	RB	Channel/Frequency(MHz)					



		size	offset	18625/ 1852.5	18900/ 1880	19175/ 1907.5	18625/ 1852.5	18900/ 1880	19175/ 1907.5
5MHz	QPSK	1	0	22.82	22.33	21.94	25.32	24.83	24.44
		1	13	22.50	22.31	22.32	25.00	24.81	24.82
		1	24	22.62	22.11	22.09	25.12	24.61	24.59
		12	0	21.18	21.16	21.27	23.68	23.66	23.77
		12	6	21.20	21.10	21.17	23.70	23.60	23.67
		12	13	21.26	21.11	21.00	23.76	23.61	23.50
		25	0	21.15	21.18	21.11	23.65	23.68	23.61
	16QAM	1	0	21.16	21.76	21.40	23.66	24.26	23.90
		1	13	21.11	21.85	21.51	23.61	24.35	24.01
		1	24	20.45	21.64	21.48	22.95	24.14	23.98
		12	0	20.12	20.14	20.07	22.62	22.64	22.57
		12	6	20.10	20.14	20.07	22.60	22.64	22.57
		12	13	20.06	20.22	20.03	22.56	22.72	22.53
		25	0	20.17	20.17	20.11	22.67	22.67	22.61
BW	Modulation	RB size	RB offset	Channel/Frequency(MHz)					
				18650/ 1855	18900/ 1880	19150/ 1905	18650/ 1855	18900/ 1880	19150/ 1905
10MHz	QPSK	1	0	22.84	22.34	21.97	25.34	24.84	24.47
		1	25	22.53	22.36	22.36	25.03	24.86	24.86
		1	49	22.64	22.15	22.12	25.14	24.65	24.62
		25	0	21.21	21.21	21.31	23.71	23.71	23.81
		25	13	21.23	21.15	21.21	23.73	23.65	23.71
		25	25	21.28	21.15	21.05	23.78	23.65	23.55
		50	0	21.23	21.20	21.15	23.73	23.70	23.65
	16QAM	1	0	21.18	21.79	21.42	23.68	24.29	23.92
		1	25	21.14	21.89	21.54	23.64	24.39	24.04
		1	49	20.48	21.66	21.51	22.98	24.16	24.01
		25	0	20.15	20.19	20.11	22.65	22.69	22.61
		25	13	20.12	20.18	20.10	22.62	22.68	22.60
		25	25	20.09	20.27	20.07	22.59	22.77	22.57
		50	0	20.20	20.22	20.15	22.70	22.72	22.65
BW	Modulation	RB size	RB offset	Channel/Frequency(MHz)					
				18675/ 1857.5	18900/ 1880	19125/ 1902.5	18675/ 1857.5	18900/ 1880	19125/ 1902.5
15MHz	QPSK	1	0	22.83	22.30	21.95	25.33	24.80	24.45
		1	38	22.51	22.35	22.33	25.01	24.85	24.83



		1	74	22.61	22.10	22.08	25.11	24.60	24.58
		36	0	21.19	21.17	21.28	23.69	23.67	23.78
		36	18	21.20	21.10	21.17	23.70	23.60	23.67
		36	39	21.25	21.12	21.01	23.75	23.62	23.51
		75	0	21.21	21.16	21.10	23.71	23.66	23.60
	16QAM	1	0	21.13	21.77	21.40	23.63	24.27	23.90
		1	38	21.12	21.86	21.52	23.62	24.36	24.02
		1	74	20.45	21.62	21.48	22.95	24.12	23.98
		36	0	20.12	20.17	20.08	22.62	22.67	22.58
		36	18	20.09	20.13	20.06	22.59	22.63	22.56
		36	39	20.07	20.23	20.04	22.57	22.73	22.54
		75	0	20.17	20.17	20.11	22.67	22.67	22.61
	BW	Modulation	RB size	RB offset	Channel/Frequency(MHz)				
18700/ 1860					18900/ 1880	19100/ 1900	18700/ 1860	18900/ 1880	19100/ 1900
20MHz	QPSK	1	0	22.80	22.26	21.92	25.30	24.76	24.42
		1	50	22.50	22.31	22.31	25.00	24.81	24.81
		1	99	22.59	22.09	22.05	25.09	24.59	24.55
		50	0	21.16	21.12	21.24	23.66	23.62	23.74
		50	25	21.18	21.06	21.14	23.68	23.56	23.64
		50	50	21.22	21.07	20.97	23.72	23.57	23.47
	16QAM	100	0	21.18	21.11	21.06	23.68	23.61	23.56
		1	0	21.11	21.73	21.35	23.61	24.23	23.85
		1	50	21.08	21.84	21.48	23.58	24.34	23.98
		1	99	20.43	21.59	21.46	22.93	24.09	23.96
		50	0	20.09	20.13	20.05	22.59	22.63	22.55
		50	25	20.06	20.11	20.03	22.56	22.61	22.53
		50	50	20.04	20.18	20.00	22.54	22.68	22.50
100	0	20.15	20.13	20.08	22.65	22.63	22.58		

LTE Band 25				Maximum Output Power(dBm)			EIRP (dBm)		
BW	Modulation	RB size	RB offset	Channel/Frequency(MHz)					
				26047/ 1850.7	26365/ 1882.5	26683/ 1914.3	26047/ 1850.7	26365/ 1882.5	26683/ 1914.3
1.4MHz	QPSK	1	0	22.11	22.19	22.08	24.61	24.69	24.58



		1	2	22.33	22.18	22.09	24.83	24.68	24.59
		1	5	22.08	21.71	21.57	24.58	24.21	24.07
		3	0	21.10	21.00	20.87	23.60	23.50	23.37
		3	2	21.02	20.97	20.86	23.52	23.47	23.36
		3	3	21.09	20.77	20.85	23.59	23.27	23.35
		6	0	21.10	20.95	20.92	23.60	23.45	23.42
	16QAM	1	0	21.00	21.87	21.50	23.50	24.37	24.00
		1	2	21.05	22.16	21.66	23.55	24.66	24.16
		1	5	20.56	21.69	21.18	23.06	24.19	23.68
		3	0	20.09	20.06	19.90	22.59	22.56	22.40
		3	2	20.16	20.03	19.89	22.66	22.53	22.39
		3	3	20.09	19.90	19.90	22.59	22.40	22.40
		6	0	20.26	20.04	20.02	22.76	22.54	22.52
BW	Modulation	RB size	RB offset	Channel/Frequency(MHz)					
				26055/ 1851.5	26365/ 1882.5	26675/ 1913.5	26055/ 1851.5	26365/ 1882.5	26675/ 1913.5
3MHz	QPSK	1	0	22.13	22.23	22.11	24.63	24.73	24.61
		1	7	22.36	22.23	22.13	24.86	24.73	24.63
		1	14	22.11	21.76	21.61	24.61	24.26	24.11
		8	0	21.18	21.10	20.98	23.68	23.60	23.48
		8	4	21.12	21.05	20.96	23.62	23.55	23.46
		8	7	21.17	20.86	20.93	23.67	23.36	23.43
		15	0	21.13	20.99	20.95	23.63	23.49	23.45
	16QAM	1	0	21.03	21.89	21.53	23.53	24.39	24.03
		1	7	21.08	22.21	21.70	23.58	24.71	24.20
		1	14	20.58	21.73	21.21	23.08	24.23	23.71
		8	0	20.18	20.17	20.00	22.68	22.67	22.50
		8	4	20.25	20.14	19.99	22.75	22.64	22.49
		8	7	20.17	20.00	20.01	22.67	22.50	22.51
		15	0	20.29	20.08	20.05	22.79	22.58	22.55
BW	Modulation	RB size	RB offset	Channel/Frequency(MHz)					
				26065/ 1852.5	26365/ 1882.5	26665/ 1912.5	26065/ 1852.5	26365/ 1882.5	26665/ 1912.5
5MHz	QPSK	1	0	22.10	22.21	22.07	24.60	24.71	24.57
		1	38	22.34	22.19	22.10	24.84	24.69	24.60
		1	74	22.08	21.71	21.57	24.58	24.21	24.07
		36	0	21.15	21.05	20.94	23.65	23.55	23.44



		36	18	21.10	21.01	20.91	23.60	23.51	23.41
		36	39	21.15	20.84	20.89	23.65	23.34	23.39
		75	0	21.11	20.98	20.93	23.61	23.48	23.43
	16QAM	1	0	21.00	21.85	21.50	23.50	24.35	24.00
		1	38	21.05	22.19	21.67	23.55	24.69	24.17
		1	74	20.55	21.71	21.17	23.05	24.21	23.67
		36	0	20.16	20.13	19.97	22.66	22.63	22.47
		36	18	20.22	20.09	19.95	22.72	22.59	22.45
		36	39	20.14	19.95	19.97	22.64	22.45	22.47
75	0	20.27	20.04	20.00	22.77	22.54	22.50		
BW	Modulation	RB size	RB offset	Channel/Frequency(MHz)					
				26090/ 1855	26365/ 1882.5	26640/ 1910	26090/ 1855	26365/ 1882.5	26640/ 1910
10MHz	QPSK	1	0	22.12	22.22	22.10	24.62	24.72	24.60
		1	25	22.37	22.24	22.14	24.87	24.74	24.64
		1	49	22.10	21.75	21.60	24.60	24.25	24.10
		25	0	21.18	21.10	20.98	23.68	23.60	23.48
		25	13	21.13	21.06	20.95	23.63	23.56	23.45
		25	25	21.17	20.88	20.94	23.67	23.38	23.44
	16QAM	50	0	21.19	21.00	20.97	23.69	23.50	23.47
		1	0	21.02	21.88	21.52	23.52	24.38	24.02
		1	25	21.08	22.23	21.70	23.58	24.73	24.20
		1	49	20.58	21.73	21.20	23.08	24.23	23.70
		25	0	20.19	20.18	20.01	22.69	22.68	22.51
		25	13	20.24	20.13	19.98	22.74	22.63	22.48
		25	25	20.17	20.00	20.01	22.67	22.50	22.51
50	0	20.30	20.09	20.04	22.80	22.59	22.54		
BW	Modulation	RB size	RB offset	Channel/Frequency(MHz)					
				26115/ 1857.5	26365/ 1882.5	26615/ 1907.5	26115/ 1857.5	26365/ 1882.5	26615/ 1907.5
15MHz	QPSK	1	0	22.11	22.18	22.08	24.61	24.68	24.58
		1	25	22.35	22.23	22.11	24.85	24.73	24.61
		1	49	22.07	21.70	21.56	24.57	24.20	24.06
		25	0	21.16	21.06	20.95	23.66	23.56	23.45
		25	13	21.10	21.01	20.91	23.60	23.51	23.41
		25	25	21.14	20.85	20.90	23.64	23.35	23.40
		50	0	21.17	20.96	20.92	23.67	23.46	23.42



	16QAM	1	0	20.97	21.86	21.50	23.47	24.36	24.00
		1	25	21.06	22.20	21.68	23.56	24.70	24.18
		1	49	20.55	21.69	21.17	23.05	24.19	23.67
		25	0	20.16	20.16	19.98	22.66	22.66	22.48
		25	13	20.21	20.08	19.94	22.71	22.58	22.44
		25	25	20.15	19.96	19.98	22.65	22.46	22.48
		50	0	20.27	20.04	20.00	22.77	22.54	22.50
BW	Modulation	RB size	RB offset	Channel/Frequency(MHz)					
				26140/ 1860	26365/ 1882.5	26590/ 1905	26140/ 1860	26365/ 1882.5	26590/ 1905
20MHz	QPSK	1	0	22.08	22.14	22.05	24.58	24.64	24.55
		1	50	22.34	22.19	22.09	24.84	24.69	24.59
		1	99	22.05	21.69	21.53	24.55	24.19	24.03
		50	0	21.13	21.01	20.91	23.63	23.51	23.41
		50	25	21.08	20.97	20.88	23.58	23.47	23.38
		50	50	21.11	20.80	20.86	23.61	23.30	23.36
		100	0	21.14	20.91	20.88	23.64	23.41	23.38
	16QAM	1	0	20.95	21.82	21.45	23.45	24.32	23.95
		1	50	21.02	22.18	21.64	23.52	24.68	24.14
		1	99	20.53	21.66	21.15	23.03	24.16	23.65
		50	0	20.13	20.12	19.95	22.63	22.62	22.45
		50	25	20.18	20.06	19.91	22.68	22.56	22.41
		50	50	20.12	19.91	19.94	22.62	22.41	22.44
		100	0	20.25	20.00	19.97	22.75	22.50	22.47



6.2.Occupied Bandwidth

Mode	Channel	Frequency (MHz)	99% Power Bandwidth (MHz)	-26dBc Bandwidth(MHz)
GSM 1900 (GSM)	512	1850.2	0.24216	0.3091
	661	1880.0	0.24695	0.3054
	810	1909.8	0.25094	0.3111
GPRS 1900 (GMSK)	512	1850.2	0.24430	0.3121
	661	1880.0	0.24563	0.3077
	810	1909.8	0.24648	0.3115
EGPRS 1900 (8-PSK)	512	1850.2	0.24656	0.3113
	661	1880.0	0.24676	0.3108
	810	1909.8	0.24759	0.3111
WCDMA Band II (RMC)	9262	1852.4	4.1289	4.701
	9400	1880	4.1228	4.676
	9538	1907.6	4.1297	4.676

LTE Band 2					
Modulation	Bandwidth (MHz)	Channel	Frequency (MHz)	99% Power Bandwidth(MHz)	-26dBc Bandwidth(MHz)
QPSK	1.4	18607	1850.7	1.1248	1.343
		18900	1880.0	1.1243	1.366
		19193	1909.3	1.1367	1.332
	3	18615	1851.5	2.7413	3.062
		18900	1880	2.7520	3.048
		19185	1908.5	2.7464	3.046
	5	18625	1852.5	4.5290	5.033
		18900	1880	4.5120	5.010
		19175	1907.5	4.5089	5.007
	10	18650	1855	9.0324	10.150
		18900	1880	9.0237	10.130
		19150	1905	9.0344	10.080
	15	18675	1857.5	13.3940	14.600
		18900	1880	13.4230	14.660



	20	19125	1902.5	13.4230	14.580
		18700	1860	17.8610	19.200
		18900	1880	17.8780	19.210
16QAM	1.4	19100	1900	17.8010	19.200
		18607	1850.7	1.1229	1.348
		18900	1880.0	1.1292	1.334
	3	19193	1909.3	1.1233	1.328
		18615	1851.5	2.7385	3.055
		18900	1880	2.7328	3.036
	5	19185	1908.5	2.7393	3.067
		18625	1852.5	4.5025	4.990
		18900	1880	4.5373	5.025
	10	19175	1907.5	4.5232	5.042
		18650	1855	9.0188	9.950
		18900	1880	9.0166	9.999
	15	19150	1905	9.0128	10.010
		18675	1857.5	13.4220	14.690
		18900	1880	13.4620	14.780
	20	19125	1902.5	13.4190	14.510
		18700	1860	17.8100	19.090
		18900	1880	17.8790	19.260
		19100	1900	17.8180	19.020

LTE Band 25					
Modulation	Bandwidth (MHz)	Channel	Frequency (MHz)	99% Power Bandwidth(MHz)	-26dBc Bandwidth(MHz)
QPSK	1.4	26047	1850.7	1.1292	1.362
		26365	1882.5	1.1241	1.318
		26683	1914.3	1.1153	1.370
	3	26055	1851.5	2.7432	3.072
		26365	1882.5	2.7549	3.053
		26675	1913.5	2.7378	3.062
	5	26065	1852.5	4.5224	5.019



		26365	1882.5	4.5142	5.002	
		26665	1912.5	4.5098	4.957	
	10	26090	1855	9.0007	10.060	
		26365	1882.5	8.9893	10.030	
		26640	1910	9.0440	9.996	
	15	26115	1857.5	13.4480	14.770	
		26365	1882.5	13.4110	14.650	
		26615	1907.5	13.4400	14.570	
	20	26140	1860	17.8410	19.250	
		26365	1882.5	17.8890	19.190	
		26590	1905	17.7960	19.210	
	16QAM	1.4	26047	1850.7	1.1084	1.333
			26365	1882.5	1.1188	1.334
			26683	1914.3	1.1195	1.332
		3	26055	1851.5	2.7350	3.055
26365			1882.5	2.7404	3.067	
26675			1913.5	2.7332	3.058	
5		26065	1852.5	4.5145	5.037	
		26365	1882.5	4.5131	5.003	
		26665	1912.5	4.5195	5.049	
10		26090	1855	9.0212	10.000	
		26365	1882.5	9.0051	9.963	
		26640	1910	9.0114	10.000	
15		26115	1857.5	13.4080	14.680	
		26365	1882.5	13.4620	14.660	
		26615	1907.5	13.4610	14.620	
20		26140	1860	17.8760	19.260	
		26365	1882.5	17.8860	19.370	
		26590	1905	17.8180	19.370	

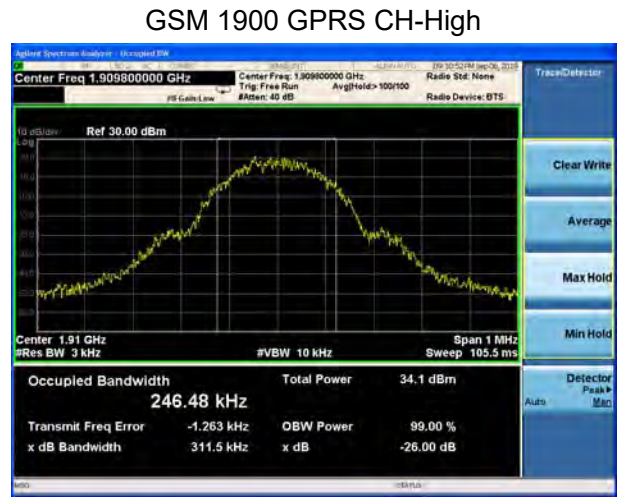
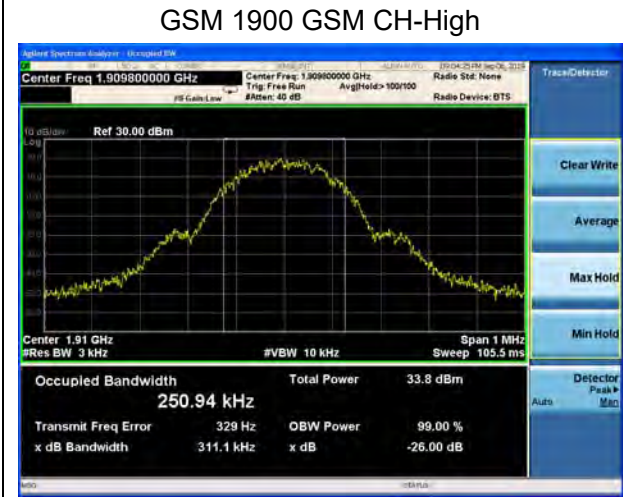
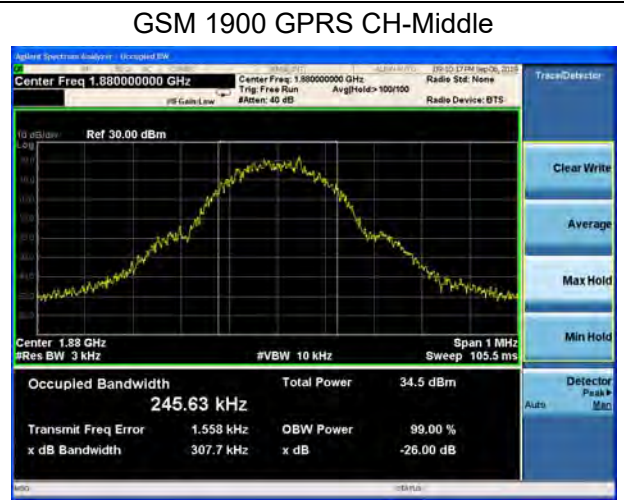
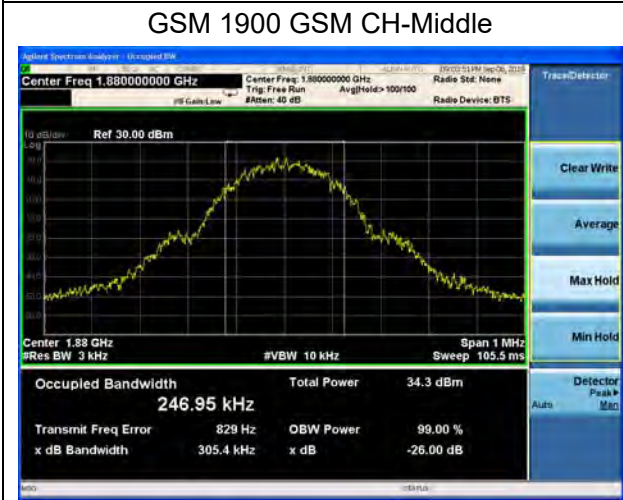
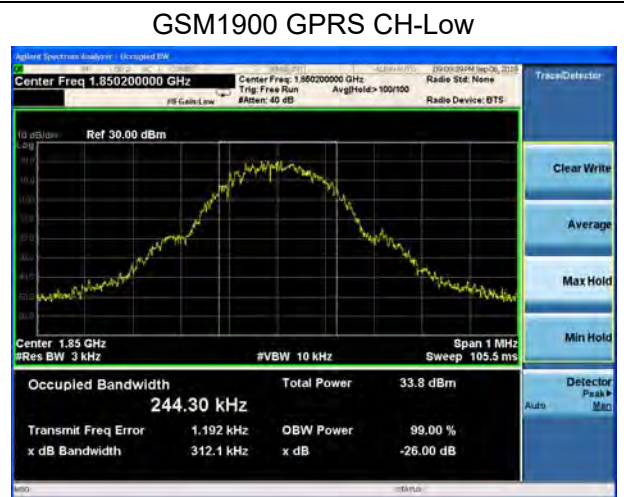
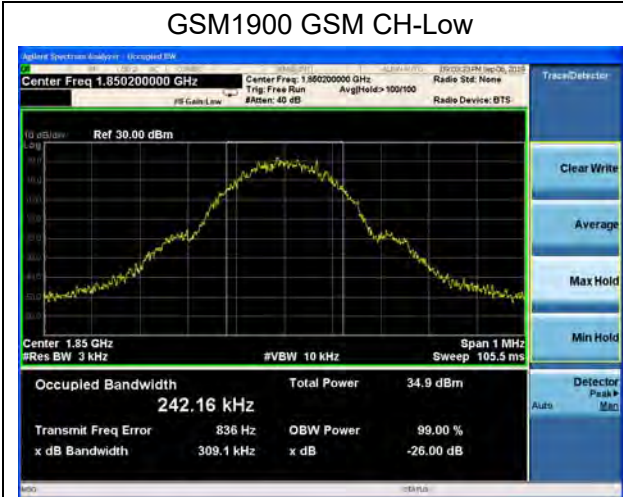

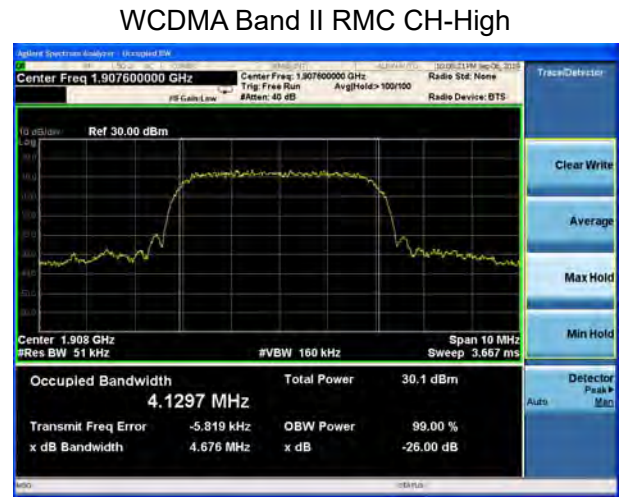
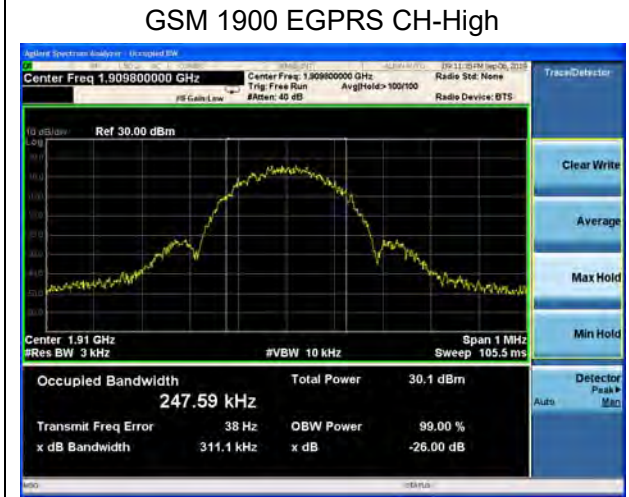
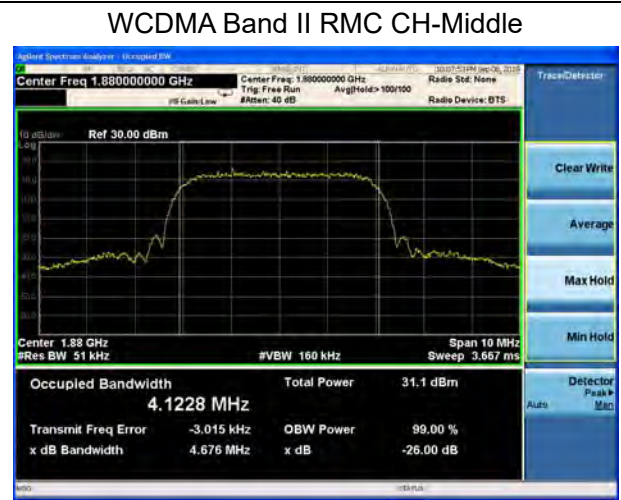
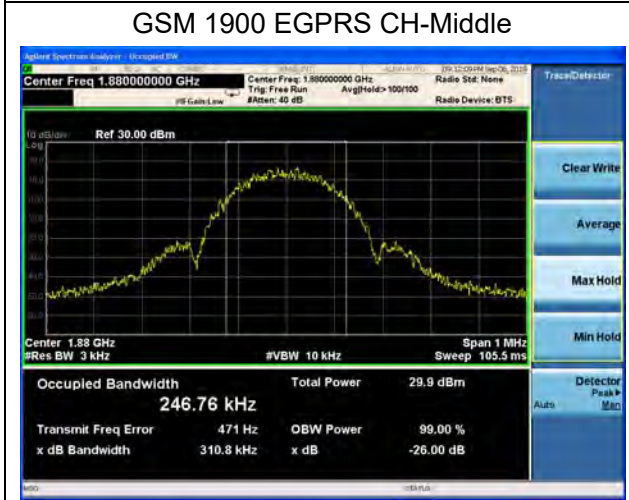
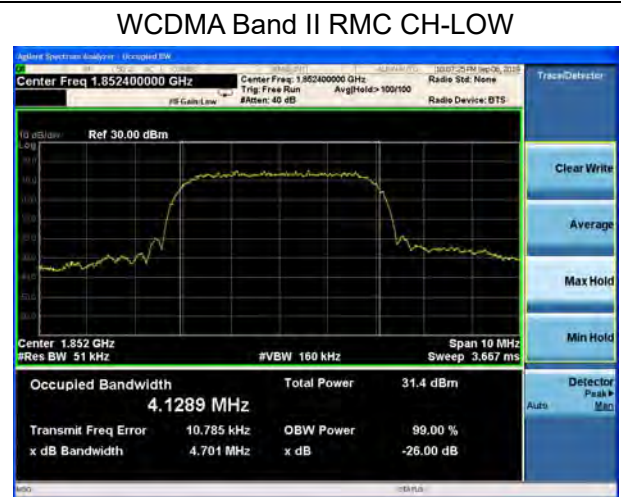
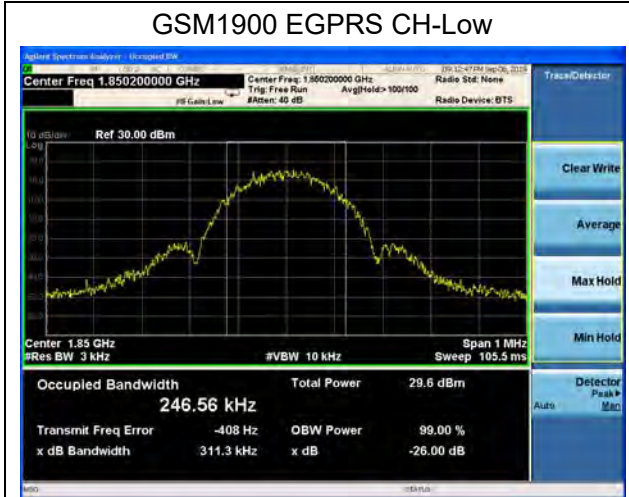

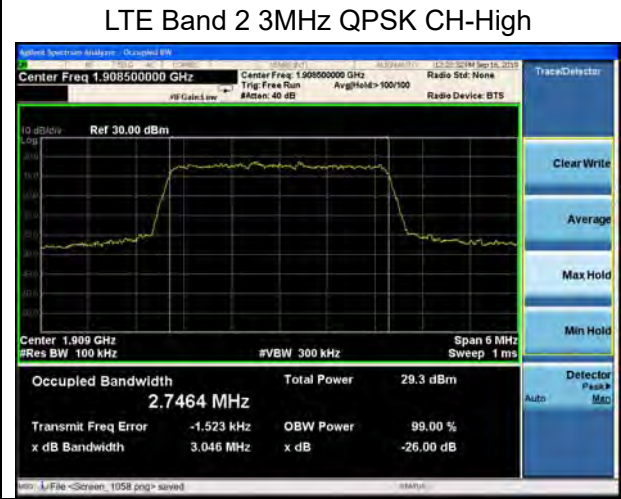
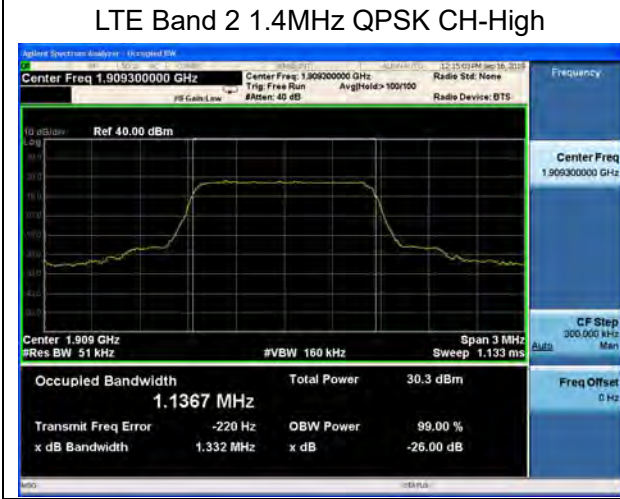
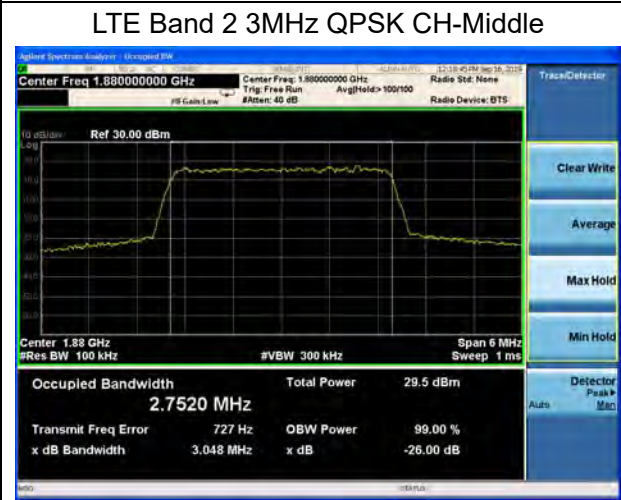
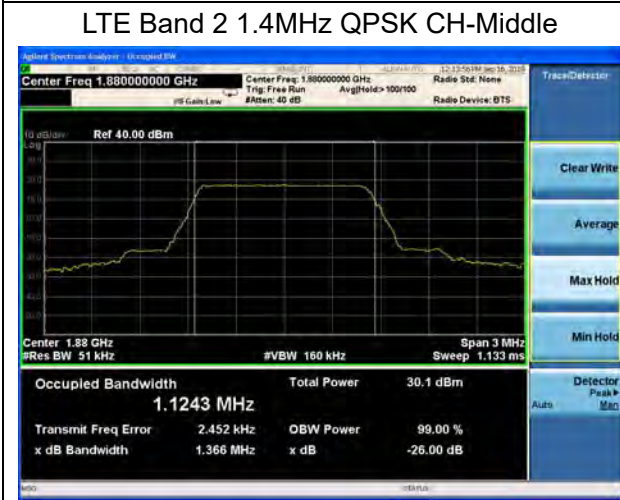
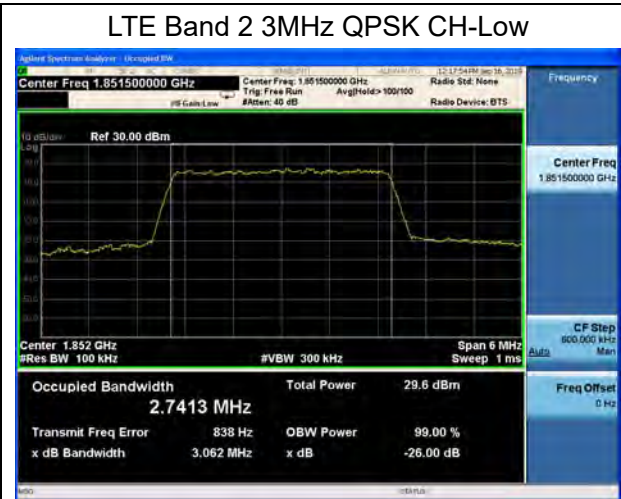
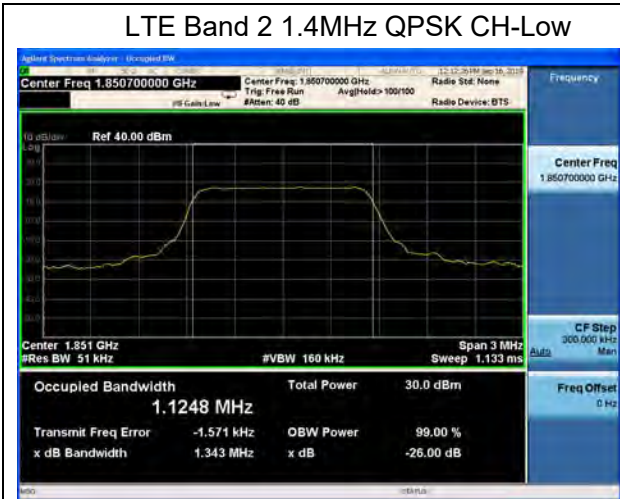

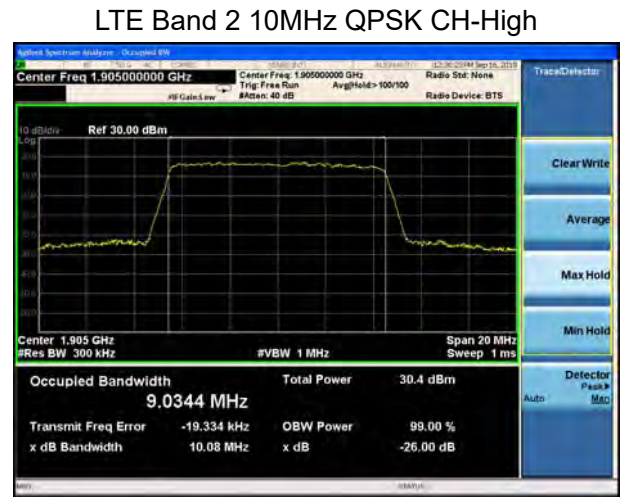
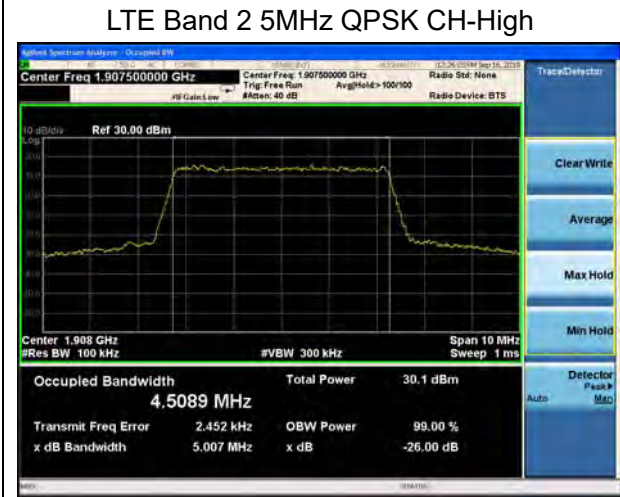
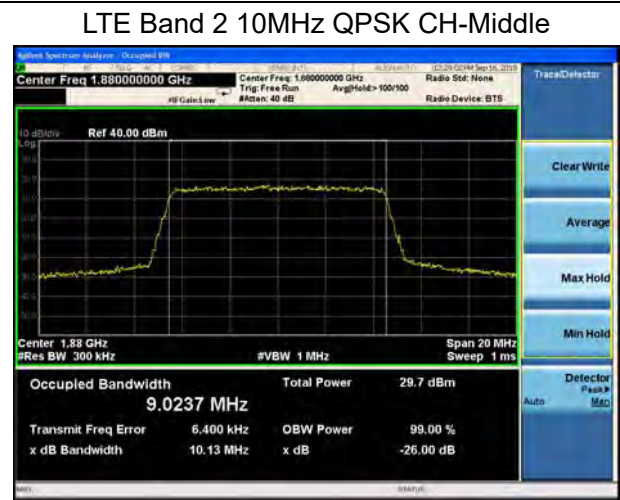
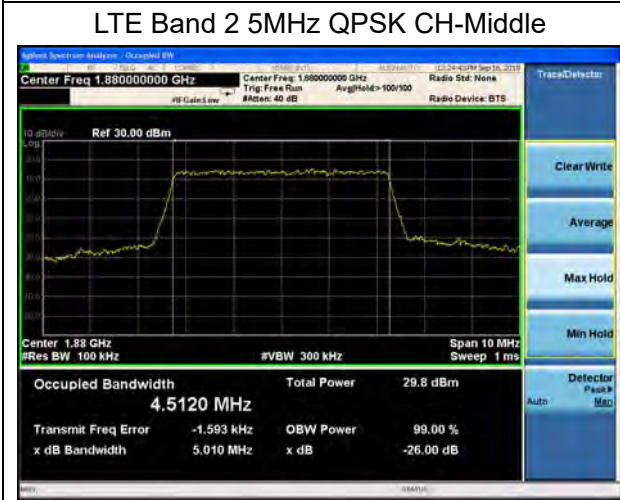
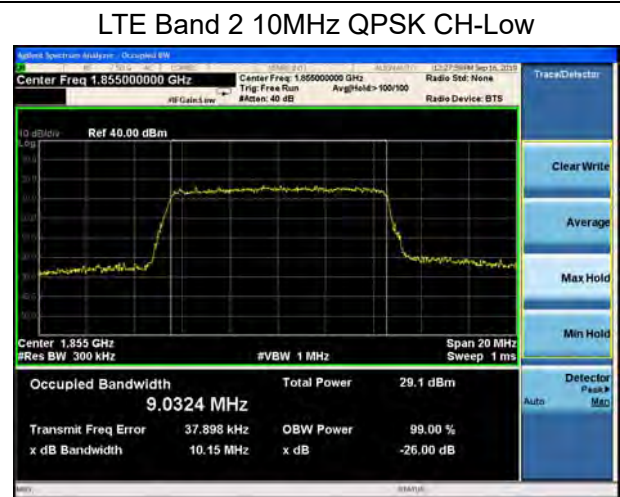
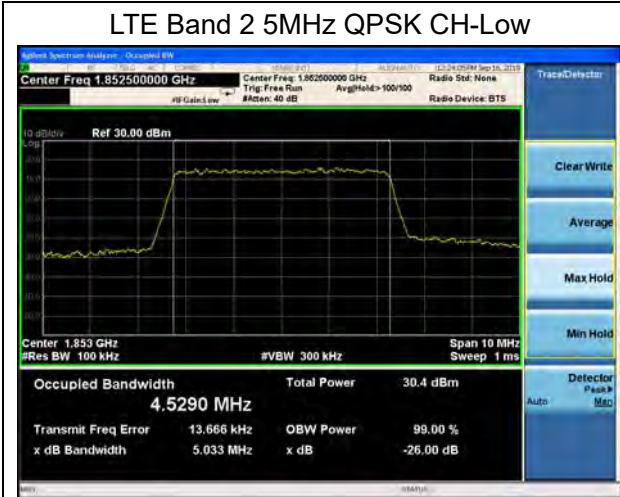

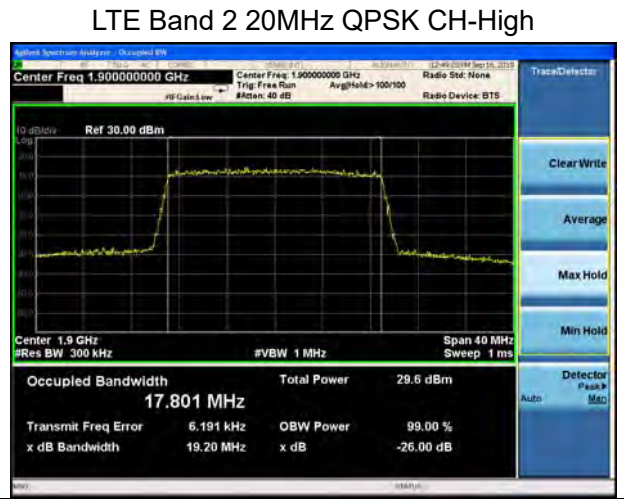
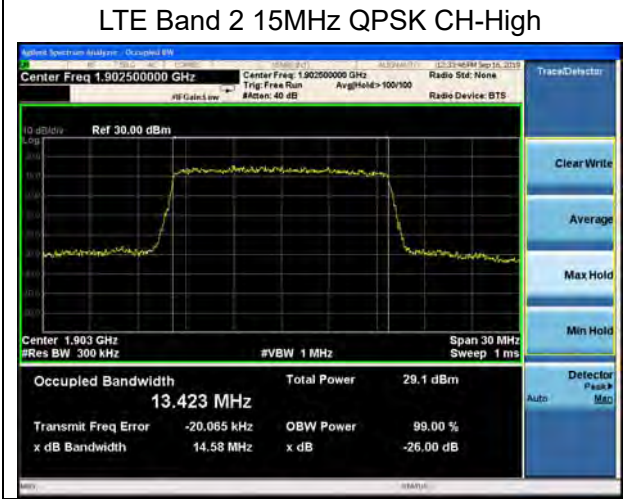
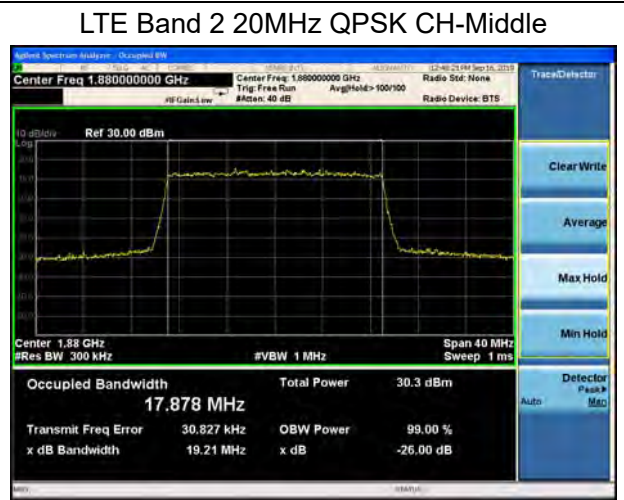
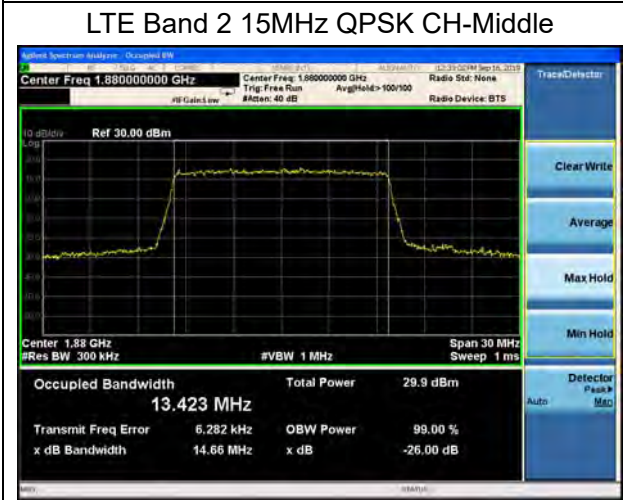
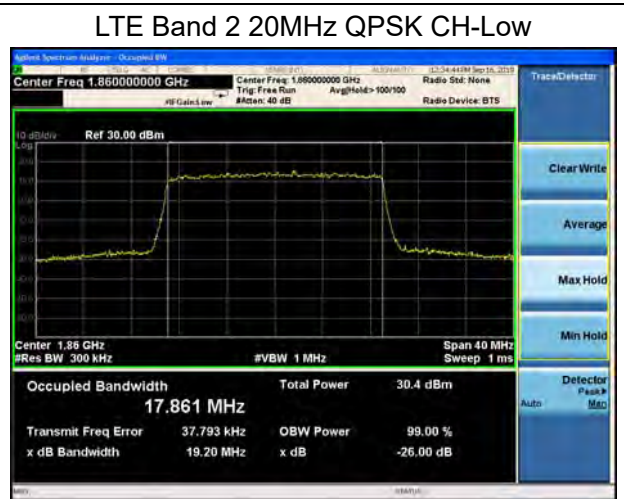
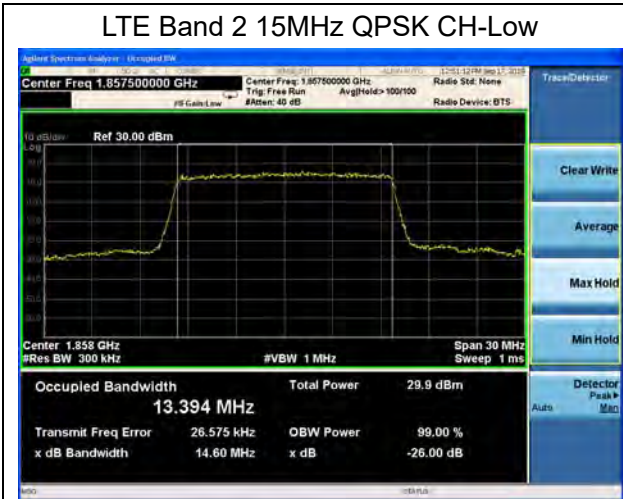

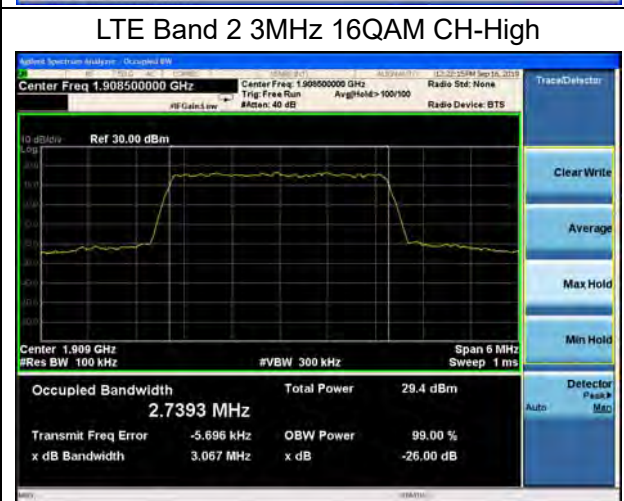
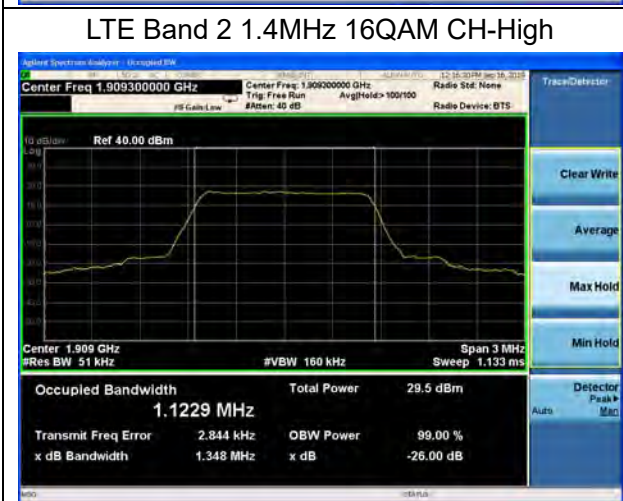
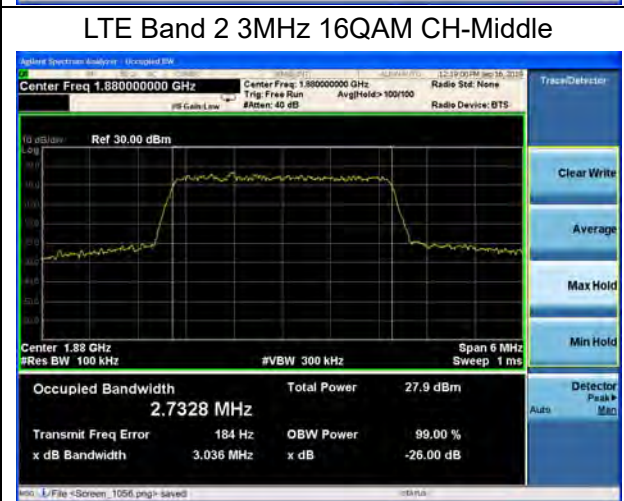
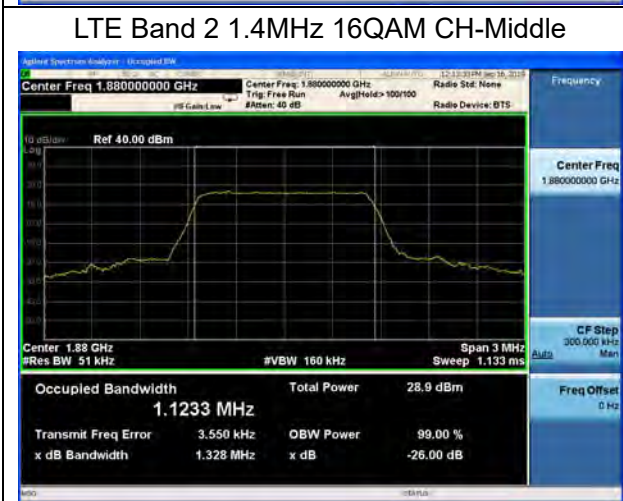
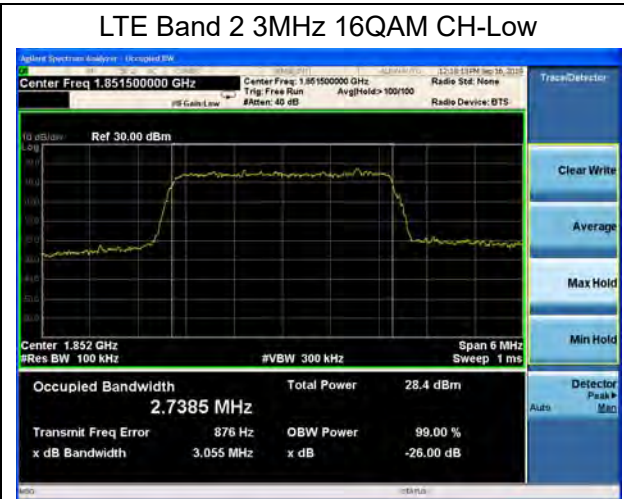
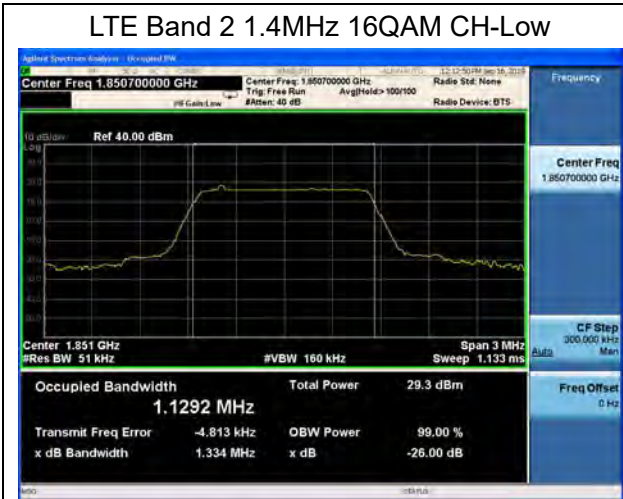

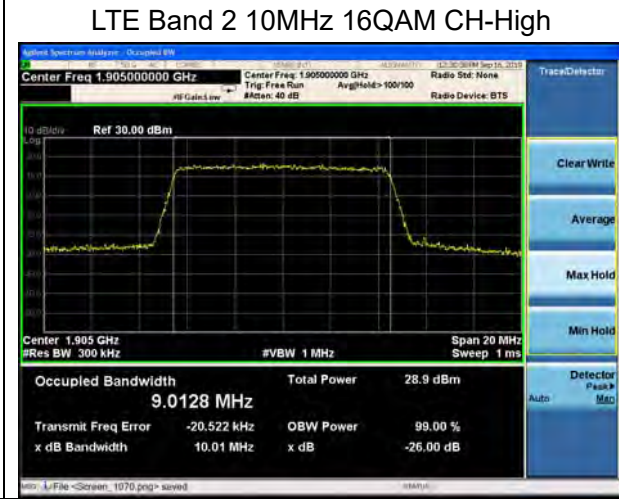
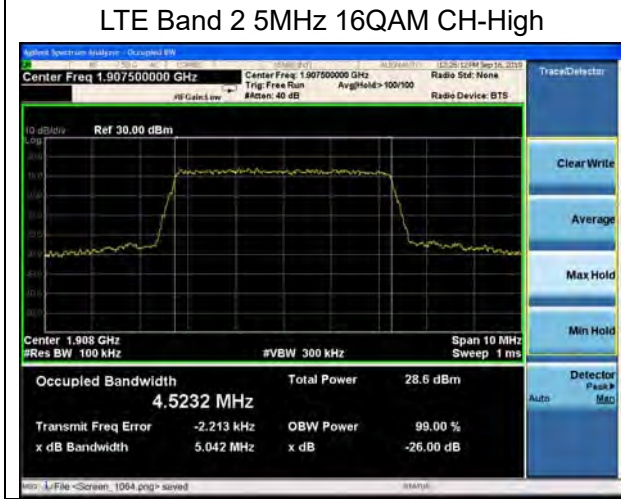
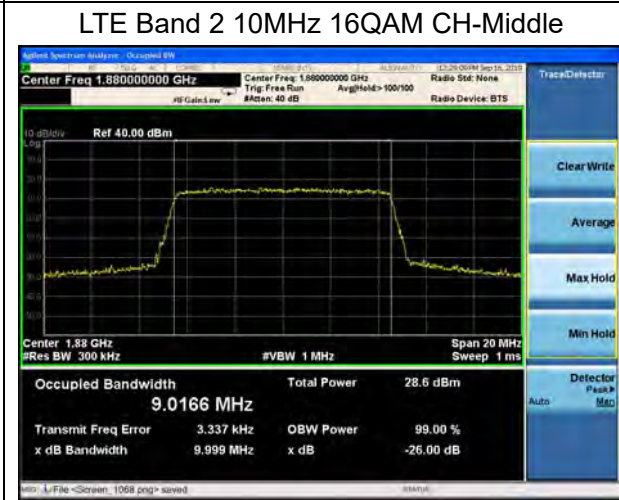
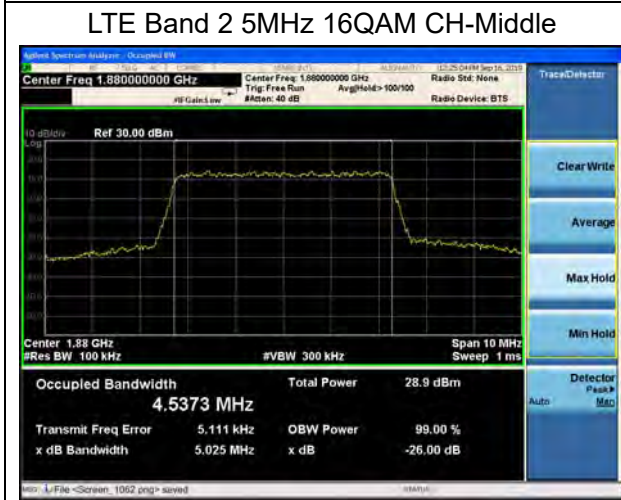
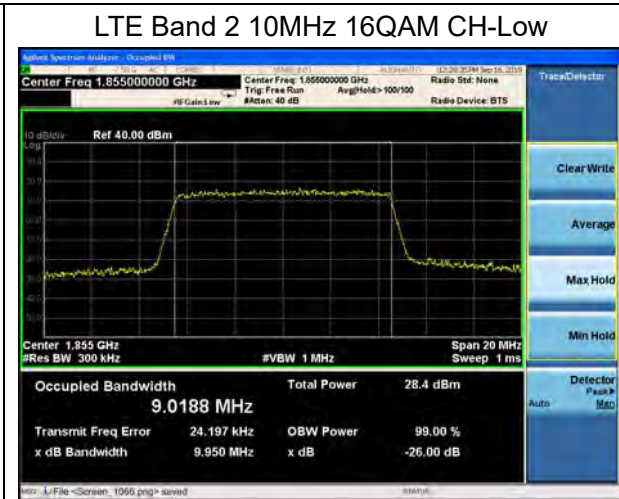
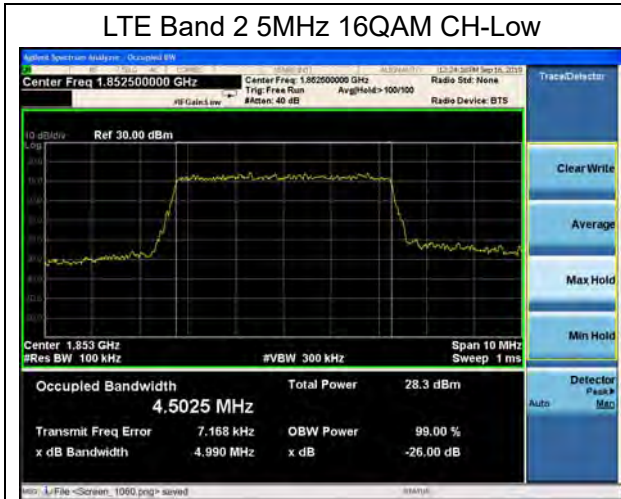

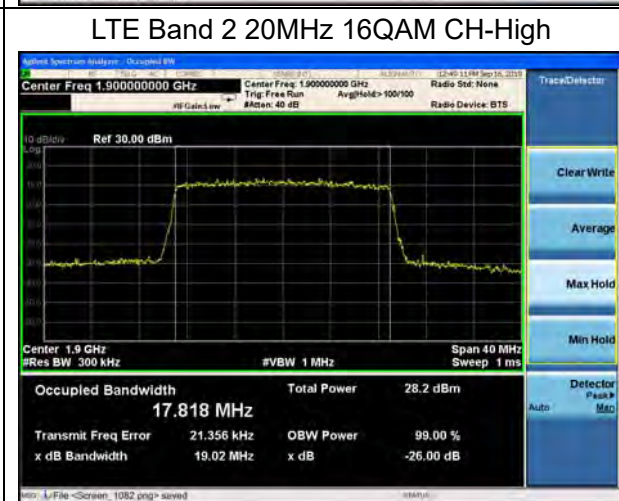
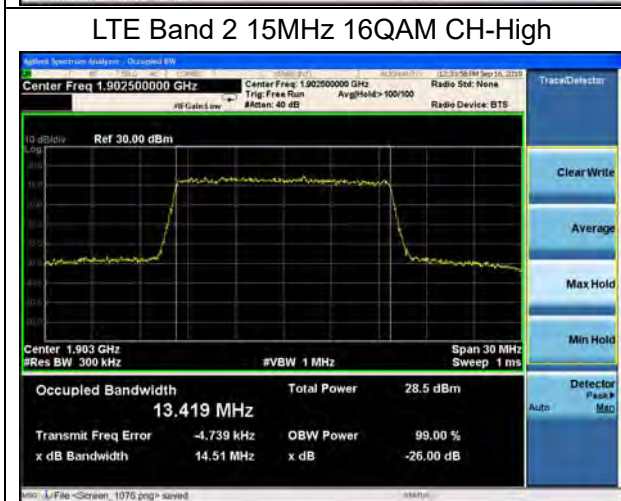
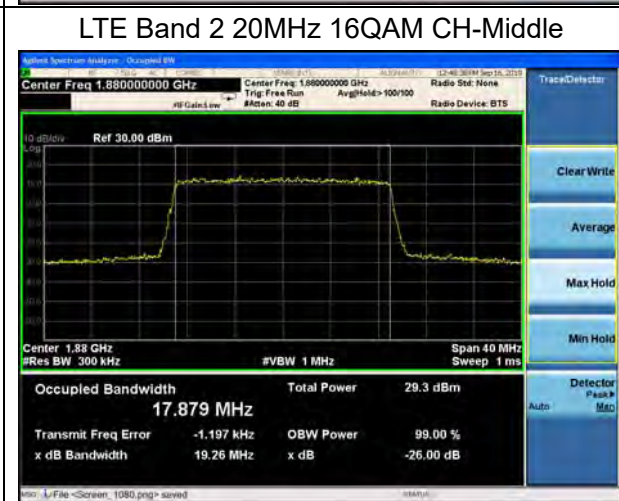
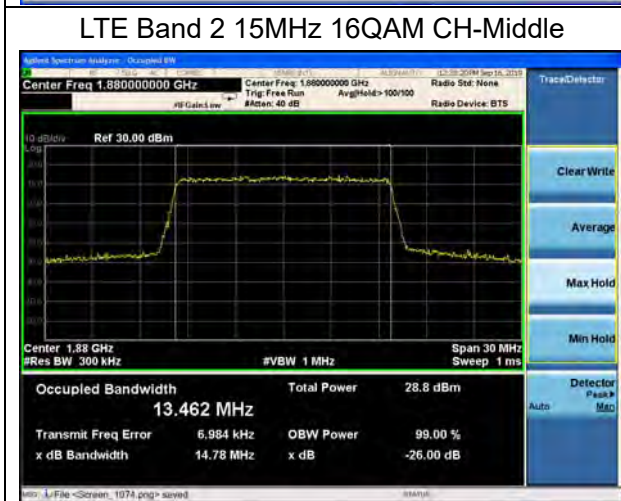
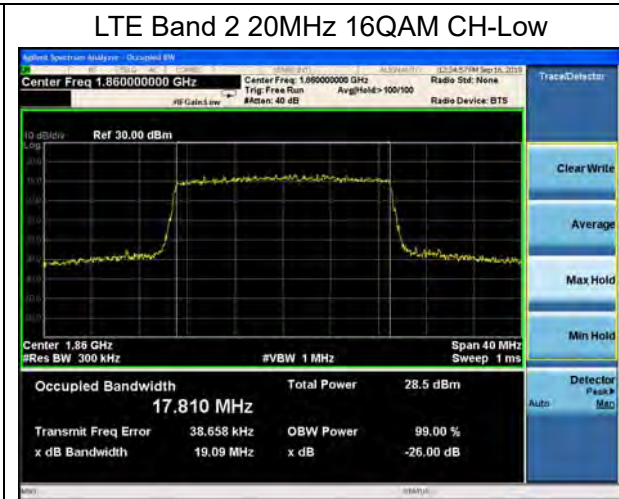
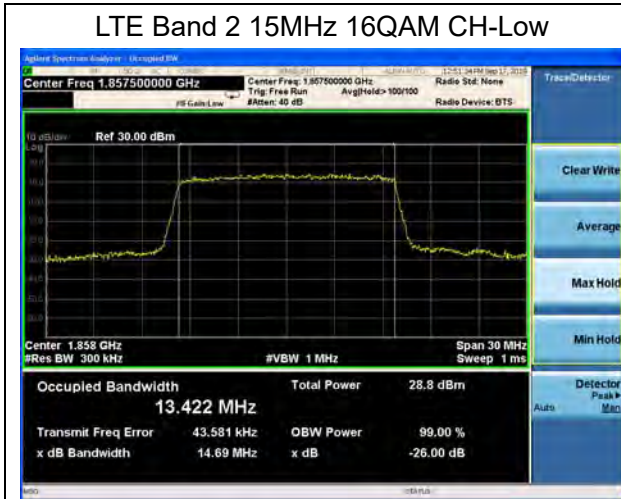

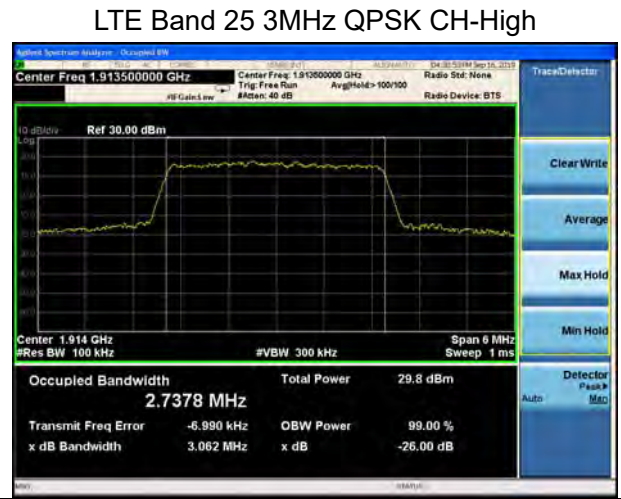
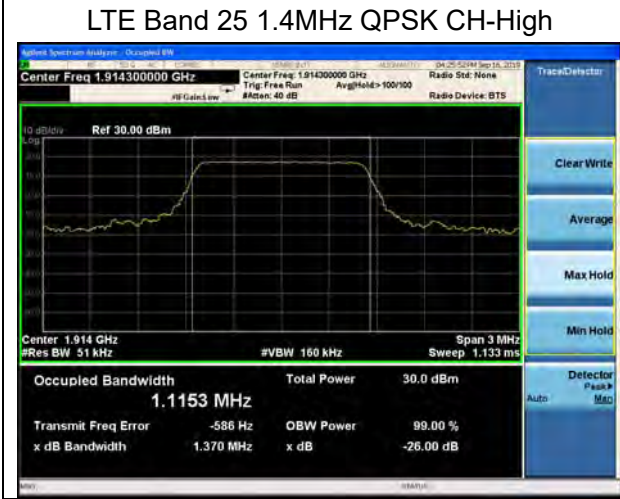
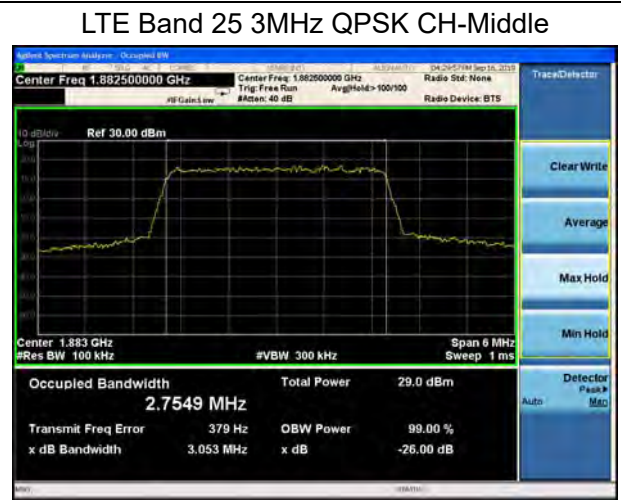
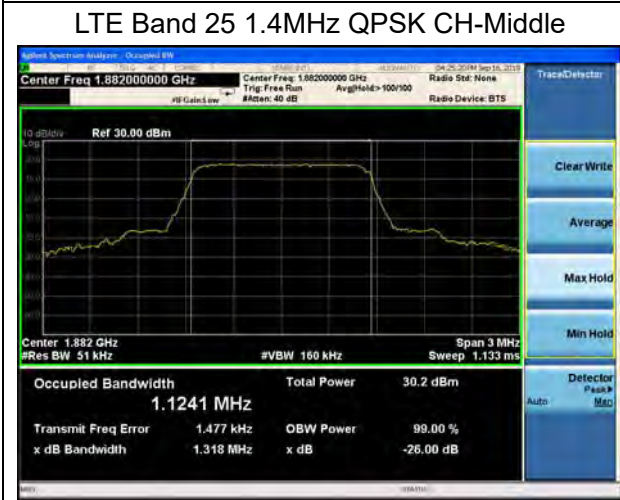
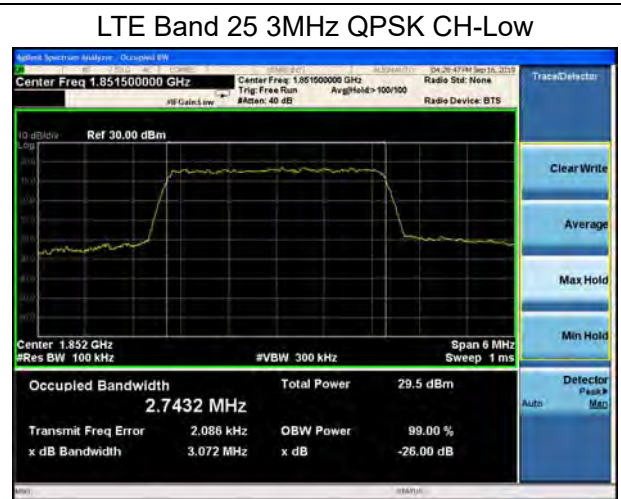
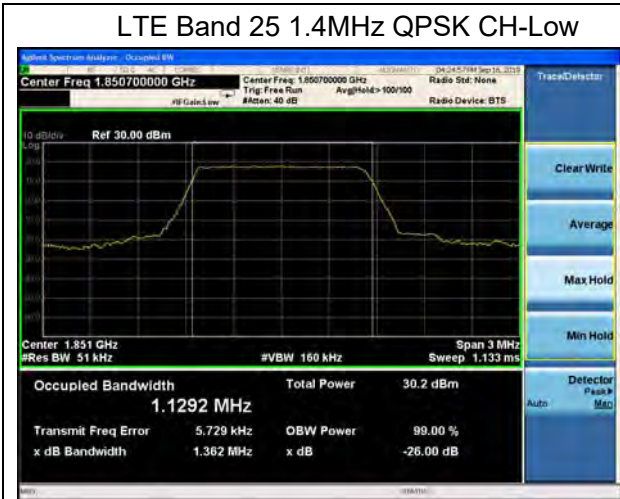

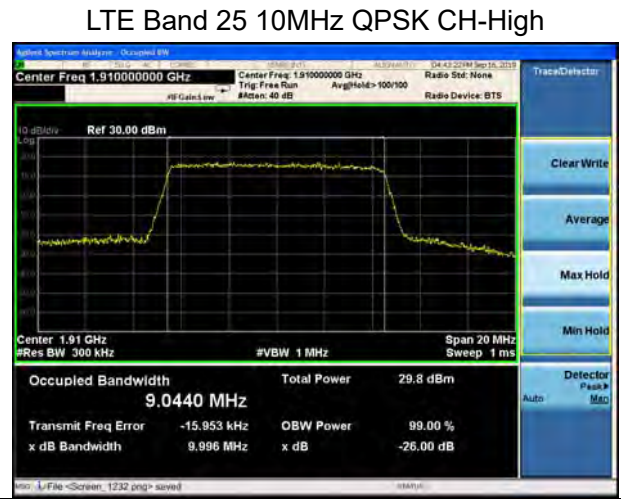
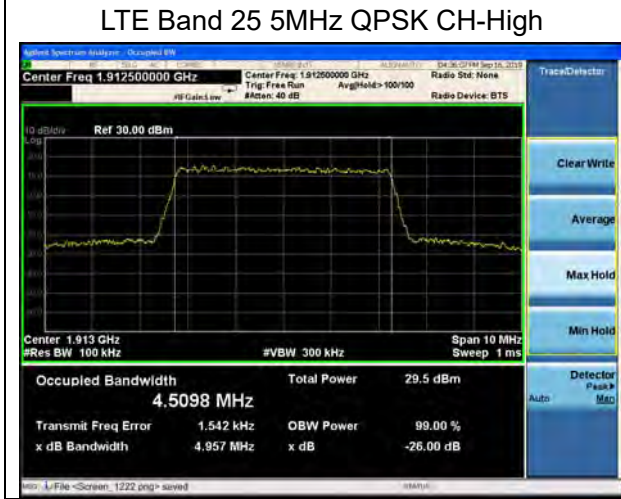
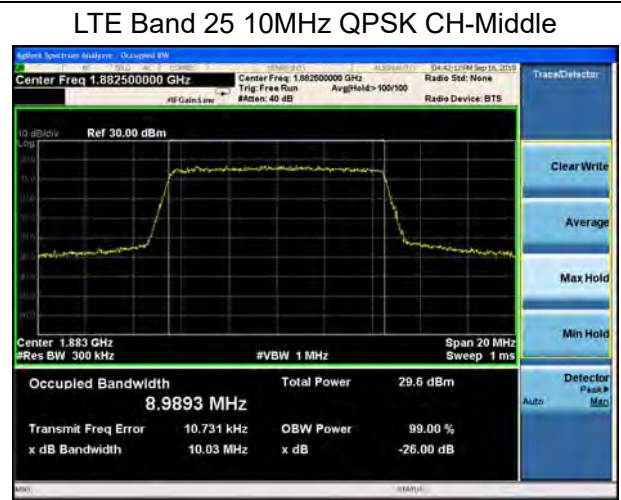
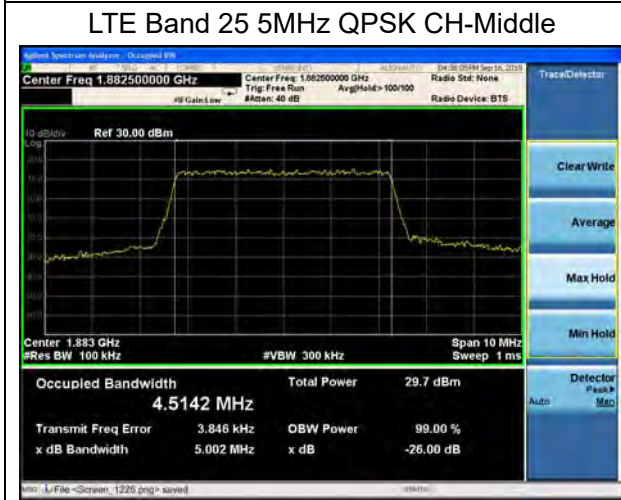
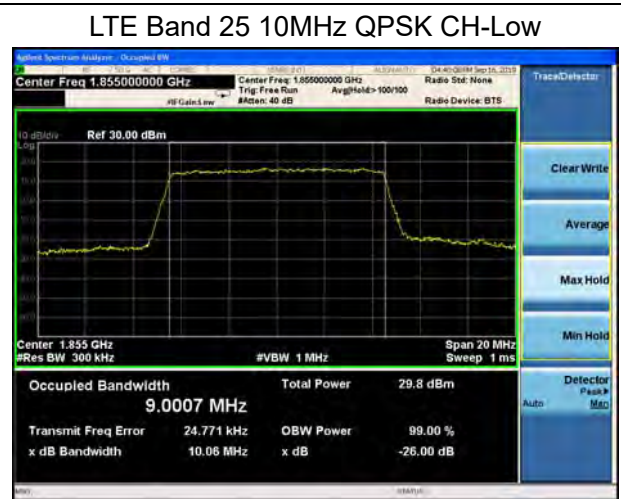
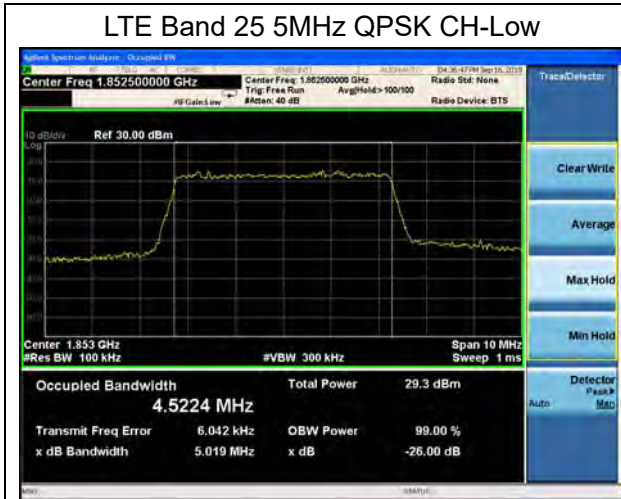

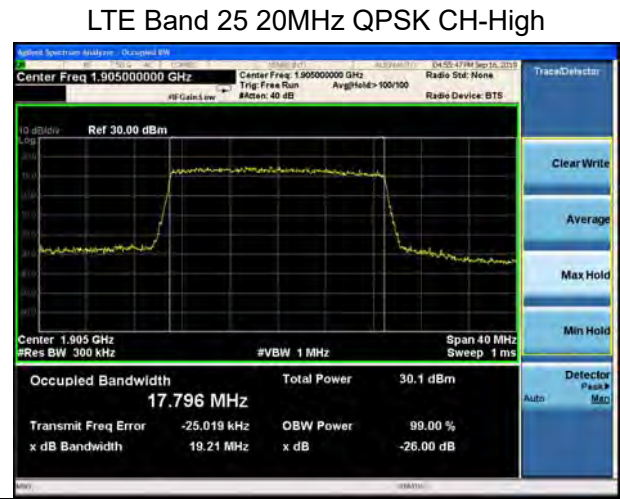
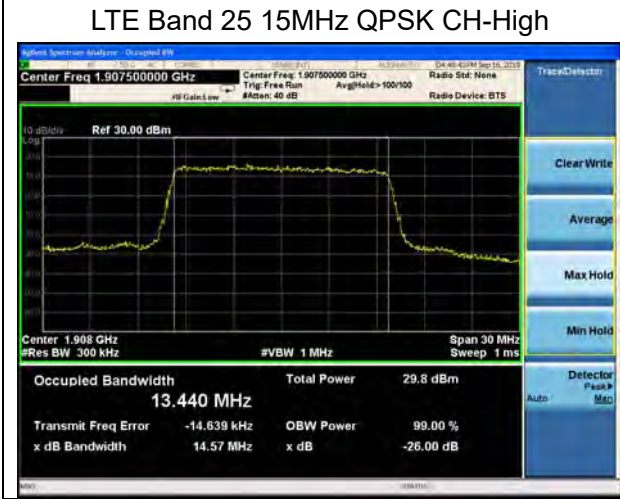
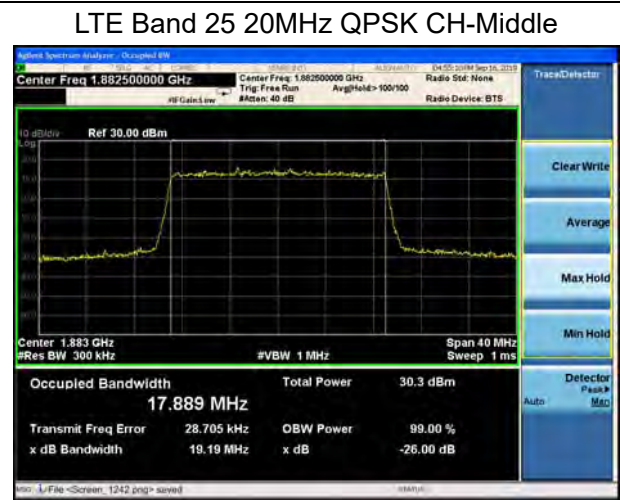
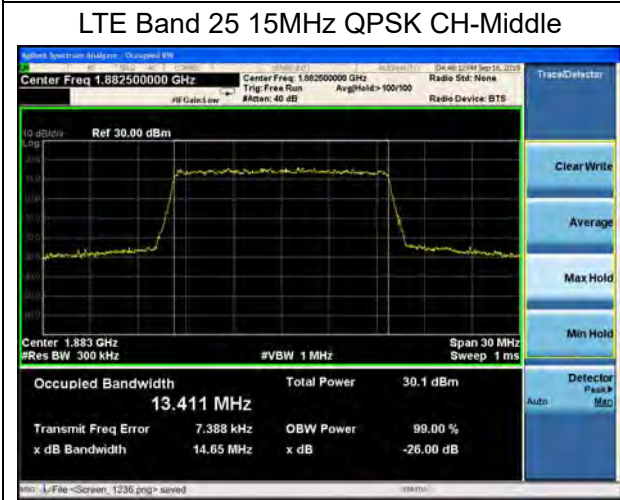
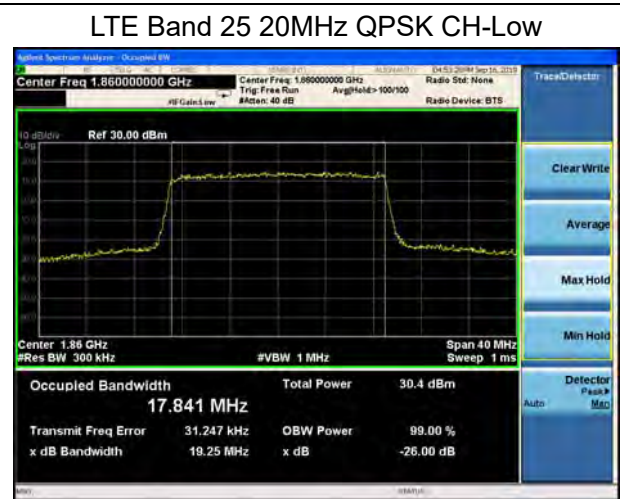
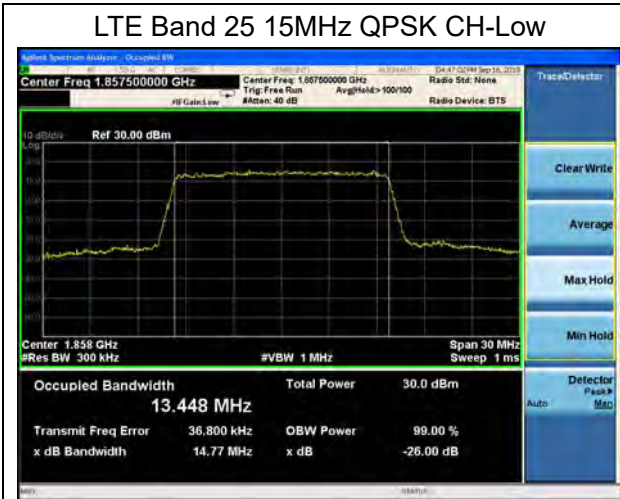



LTE Band 25 1.4MHz 16QAM CH-Low



LTE Band 25 3MHz 16QAM CH-Low



LTE Band 25 1.4MHz 16QAM CH-Middle



LTE Band 25 3MHz 16QAM CH-Middle



LTE Band 25 1.4MHz 16QAM CH-High



LTE Band 25 3MHz 16QAM CH-High





LTE Band 25 5MHz 16QAM CH-Low



LTE Band 25 10MHz 16QAM CH-Low



LTE Band 25 5MHz 16QAM CH-Middle



LTE Band 25 10MHz 16QAM CH-Middle

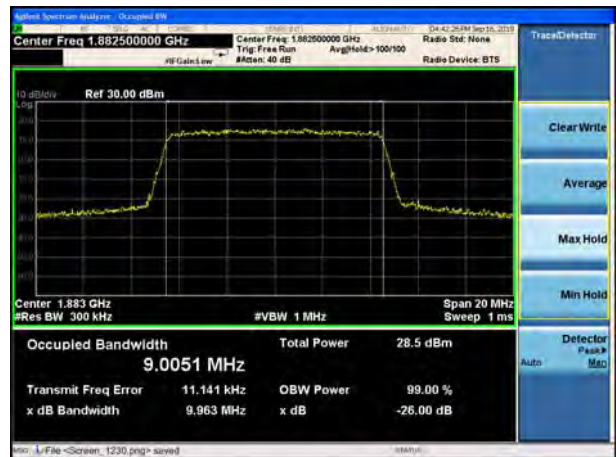

LTE Band 25 5MHz 16QAM CH-High



LTE Band 25 10MHz 16QAM CH-High

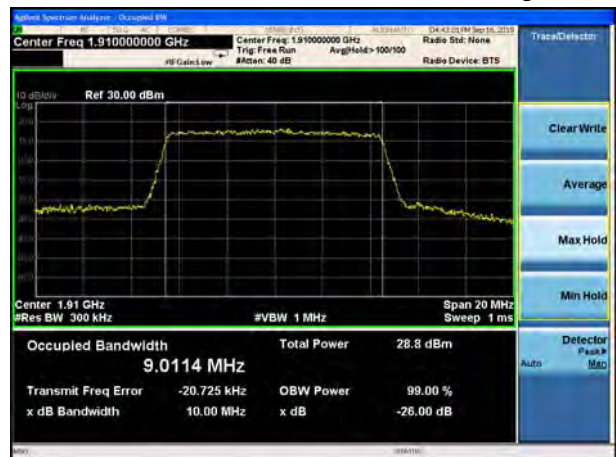

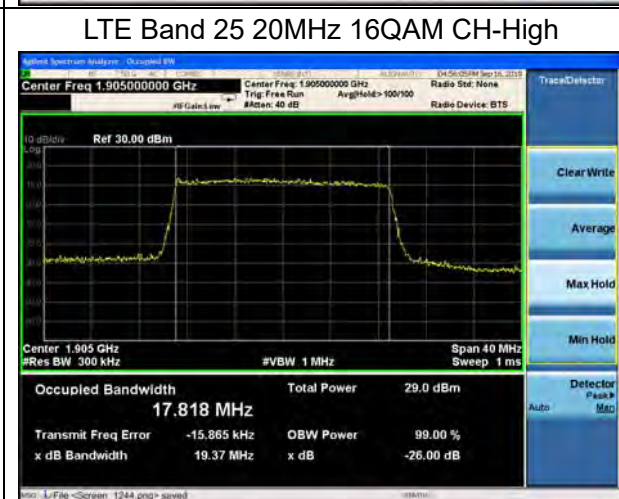
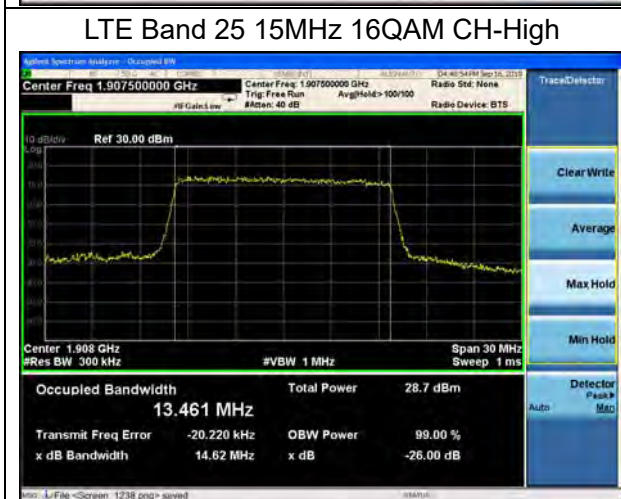
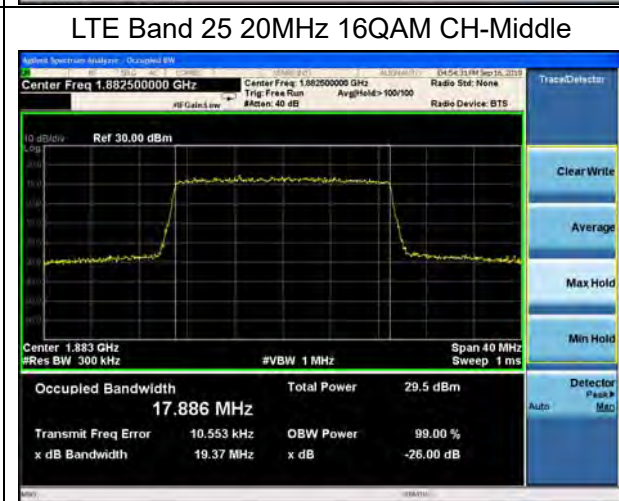
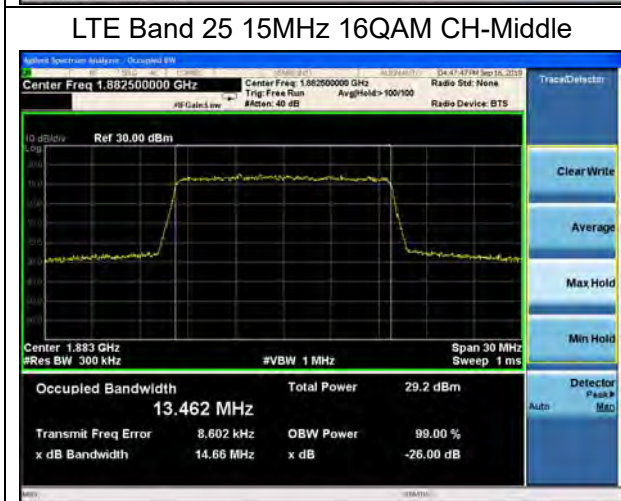
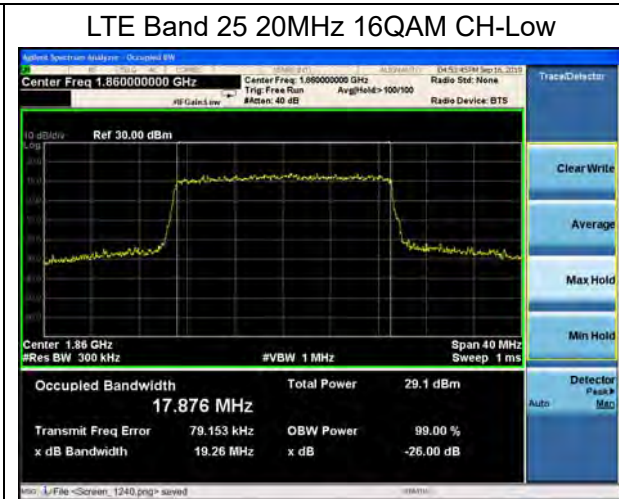
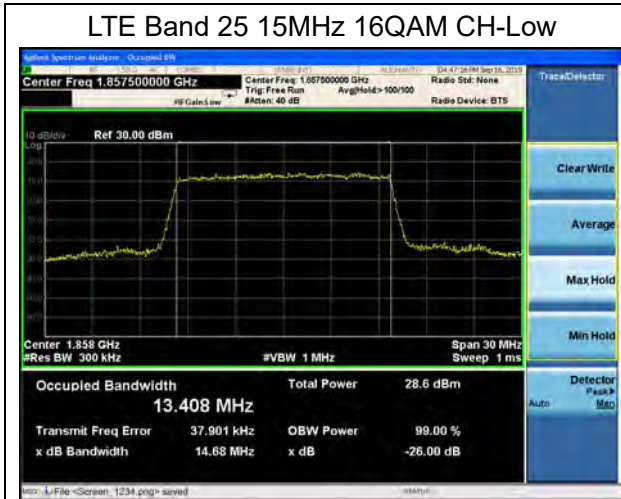

6.3. Band Edge

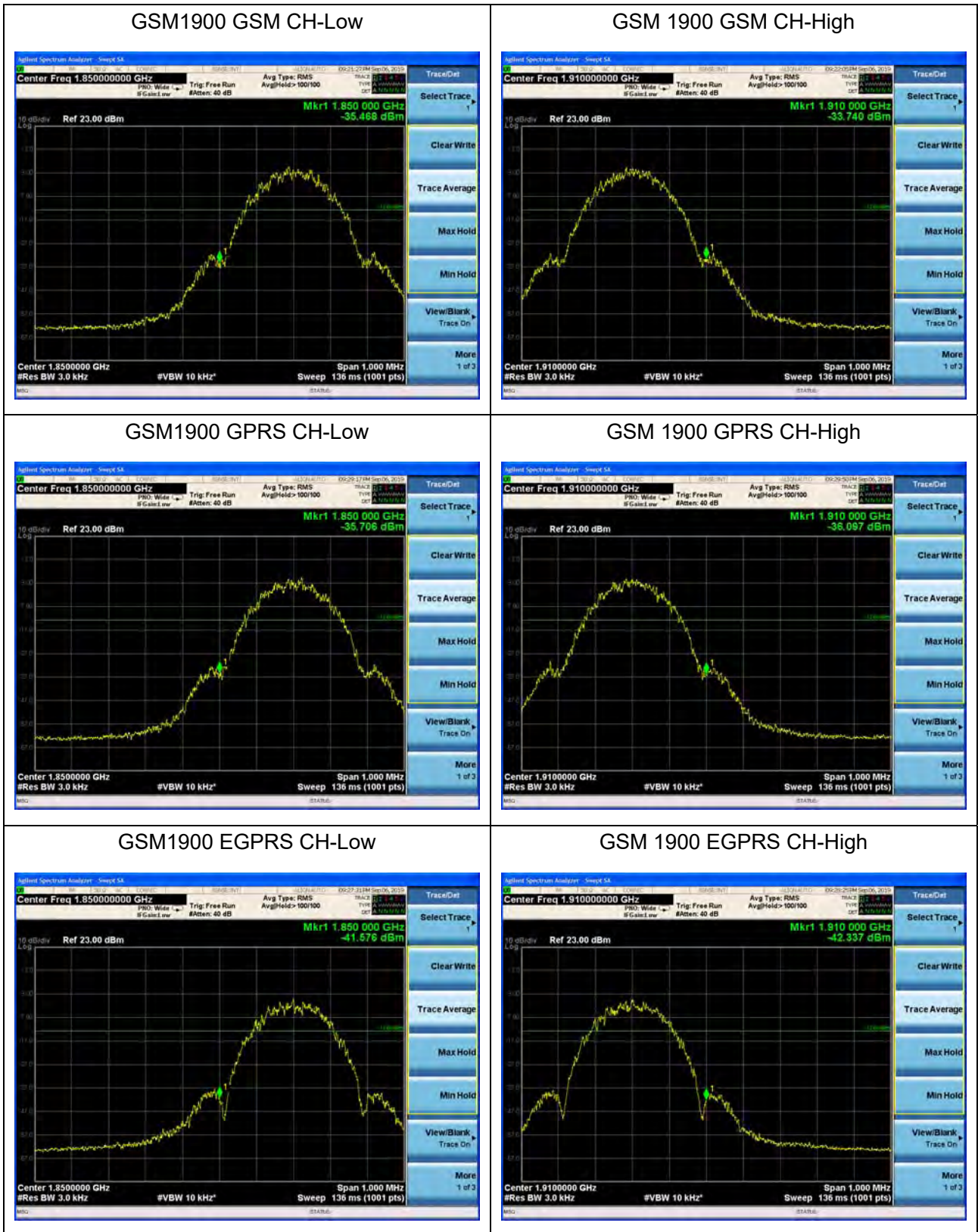



WCDMA Band II RMC CH-Low



WCDMA Band II RMC CH-High



LTE Band 2 1.4MHz QPSK 1RB CH-Low



LTE Band 2 1.4MHz QPSK 1RB CH-High





LTE Band 2 1.4MHz QPSK 100%RB CH-Low

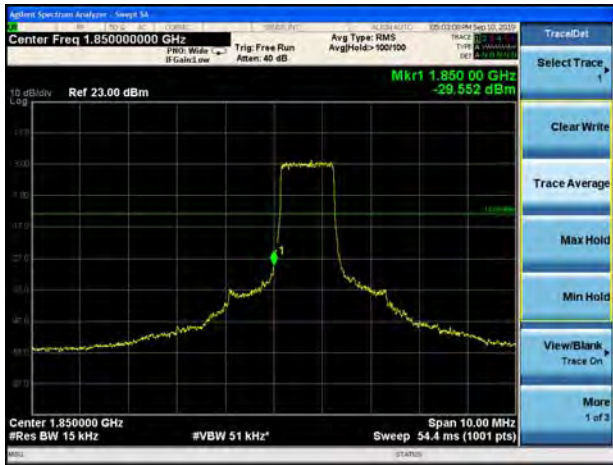

LTE Band 2 1.4MHz QPSK 100%RB CH-High

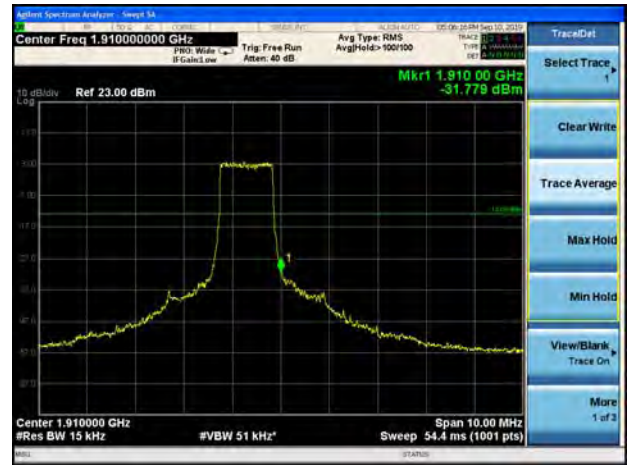

LTE Band 2 3MHz QPSK 1RB CH-Low



LTE Band 2 3MHz QPSK 1RB CH-High



LTE Band 2 3MHz QPSK 100%RB CH-Low

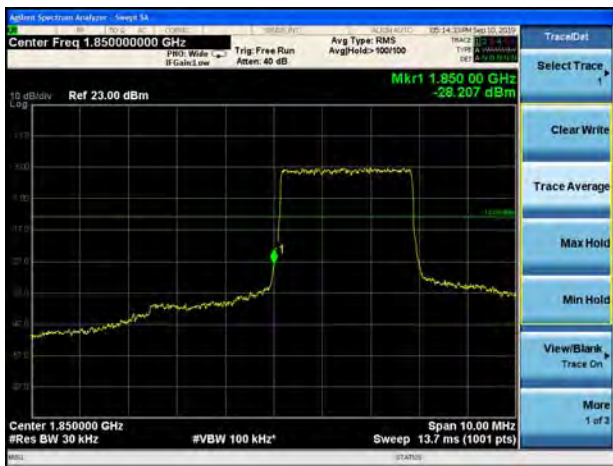

LTE Band 2 3MHz QPSK 100%RB CH-High





LTE Band 2 5MHz QPSK 1RB CH-Low

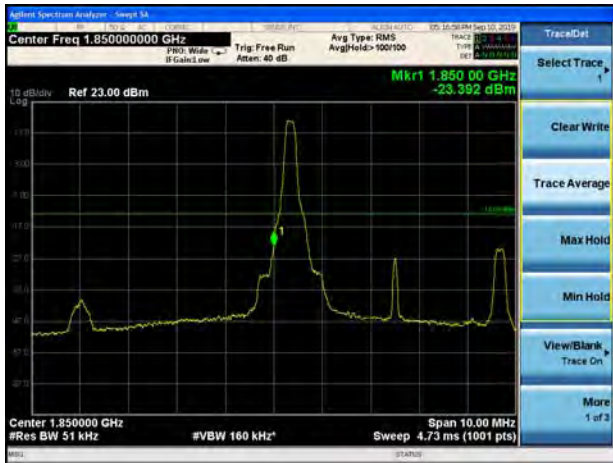

LTE Band 2 5MHz QPSK 1RB CH-High

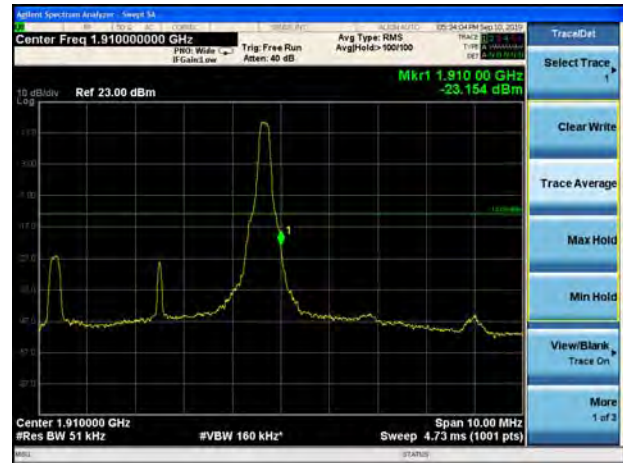

LTE Band 2 5MHz QPSK 100%RB CH-Low

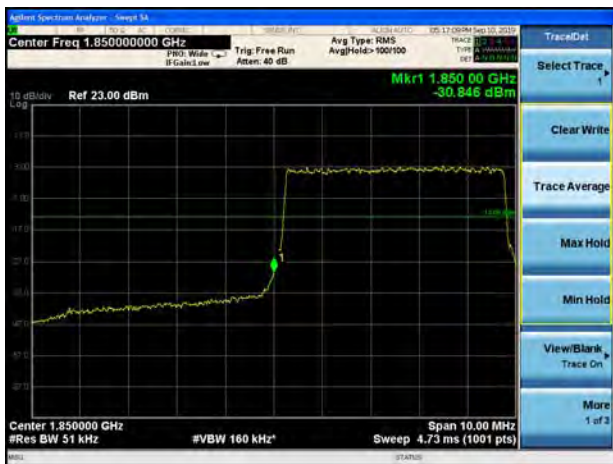

LTE Band 2 5MHz QPSK 100%RB CH-High

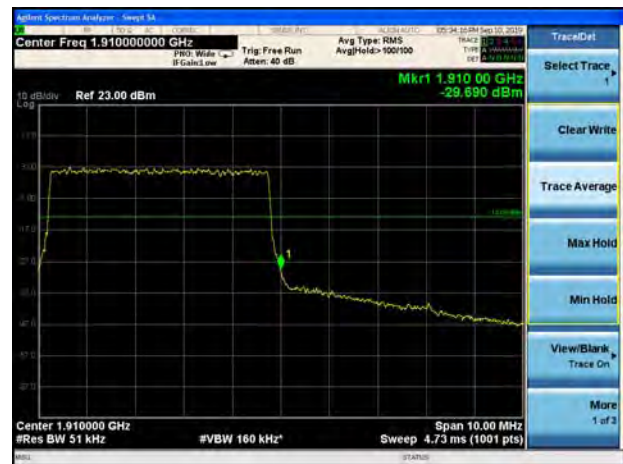

LTE Band 2 10MHz QPSK 1RB CH-Low

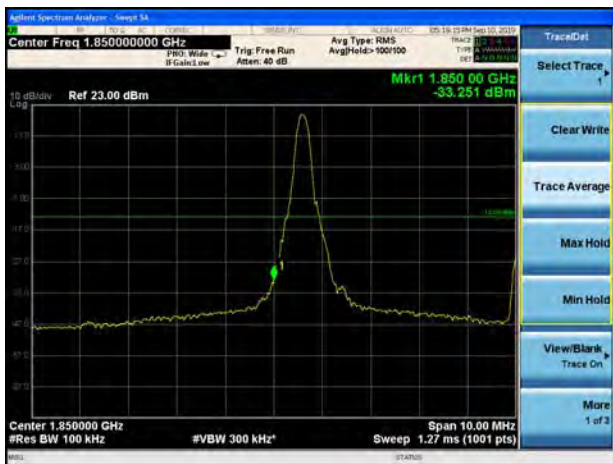

LTE Band 2 10MHz QPSK 1RB CH-High

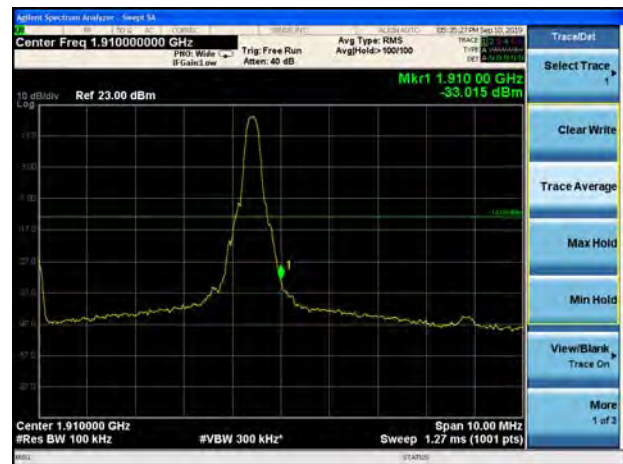



LTE Band 2 10MHz QPSK 100%RB CH-Low

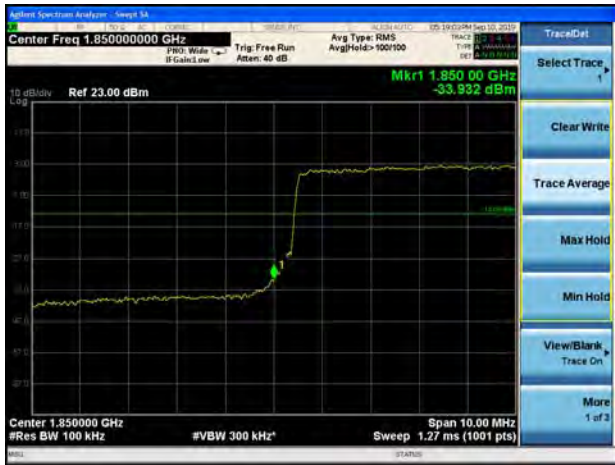

LTE Band 2 10MHz QPSK 100%RB CH-High



LTE Band 2 15MHz QPSK 1RB CH-Low

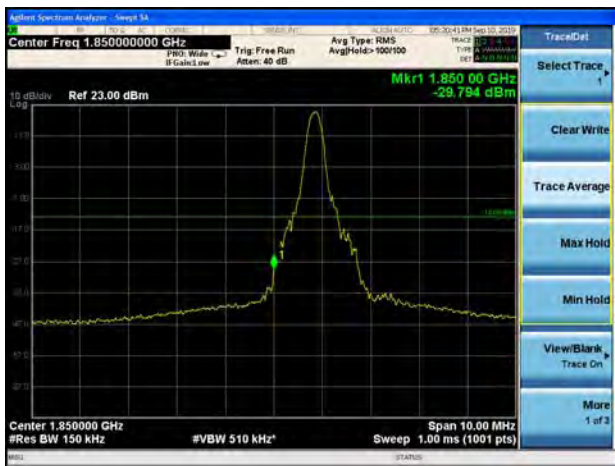

LTE Band 2 15MHz QPSK 1RB CH-High

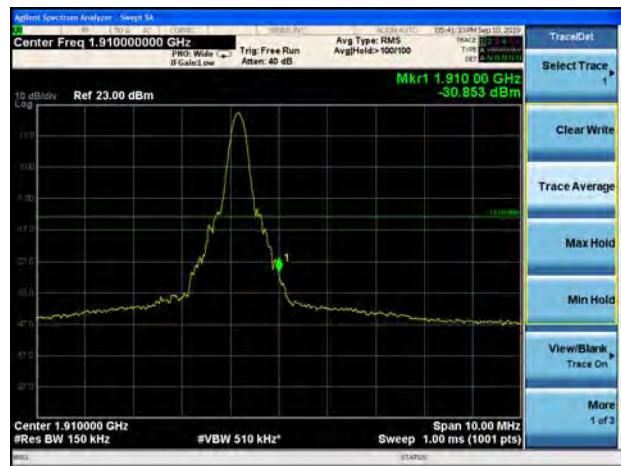

LTE Band 2 15MHz QPSK 100%RB CH-Low



LTE Band 2 15MHz QPSK 100%RB CH-High





LTE Band 2 20MHz QPSK 1RB CH-Low

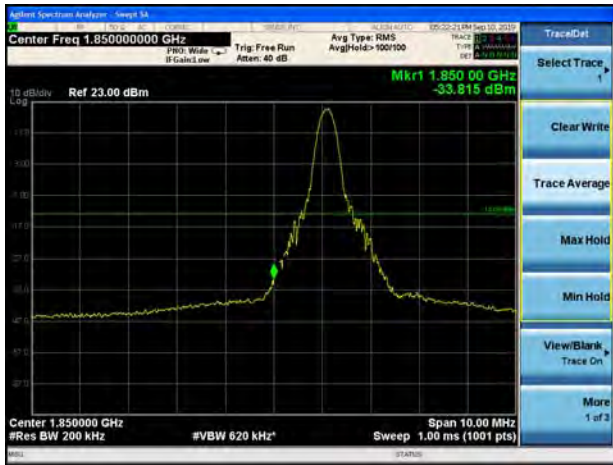

LTE Band 2 20MHz QPSK 1RB CH-High



LTE Band 2 20MHz QPSK 100%RB CH-Low

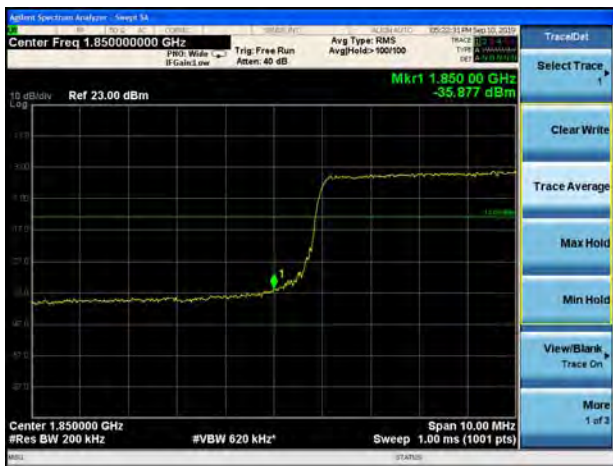

LTE Band 2 20MHz QPSK 100%RB CH-High



LTE Band 2 1.4MHz 16QAM 1RB CH-Low



LTE Band 2 1.4MHz 16QAM 1RB CH-High

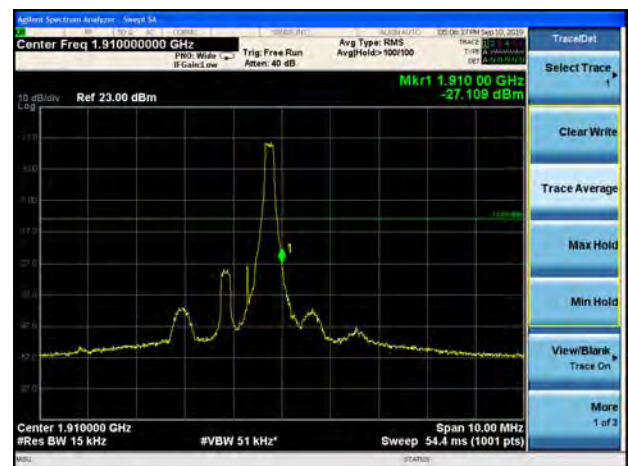



LTE Band 2 1.4MHz 16QAM 100%RB CH-Low

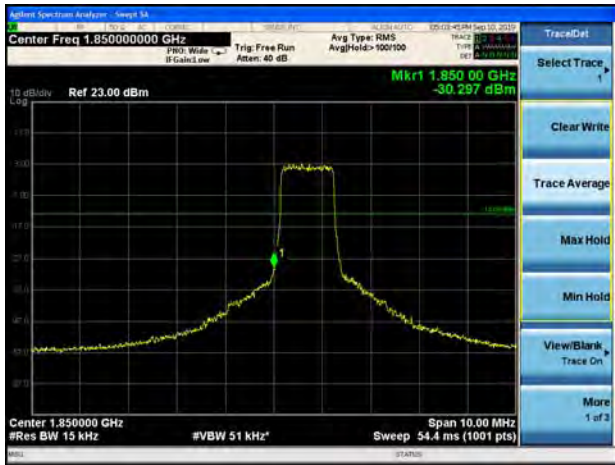

LTE Band 2 1.4MHz 16QAM 100%RB CH-High

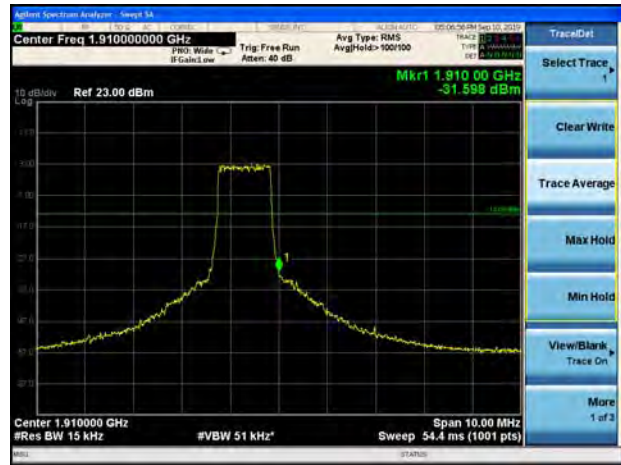

LTE Band 2 3MHz 16QAM 1RB CH-Low

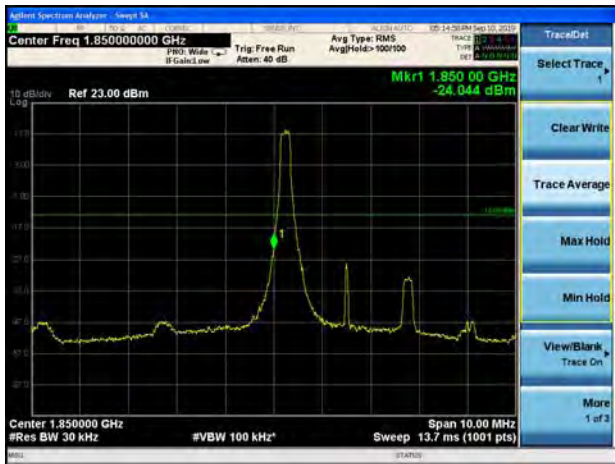

LTE Band 2 3MHz 16QAM 1RB CH-High



LTE Band 2 3MHz 16QAM 100%RB CH-Low



LTE Band 2 3MHz 16QAM 100%RB CH-High

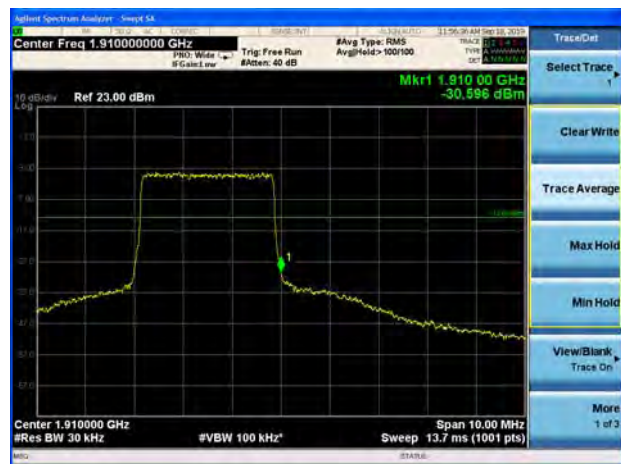



LTE Band 2 5MHz 16QAM 1RB CH-Low

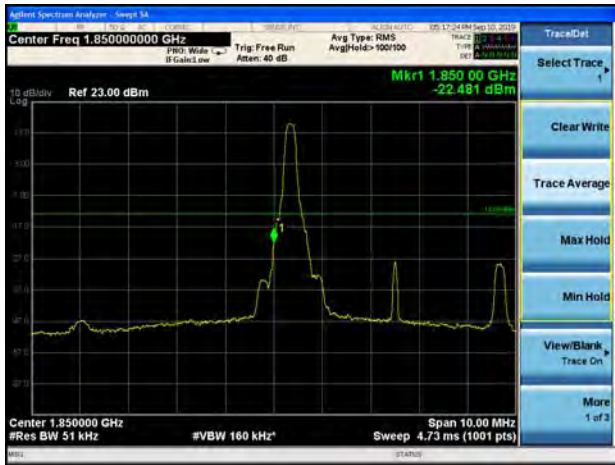

LTE Band 2 5MHz 16QAM 1RB CH-High

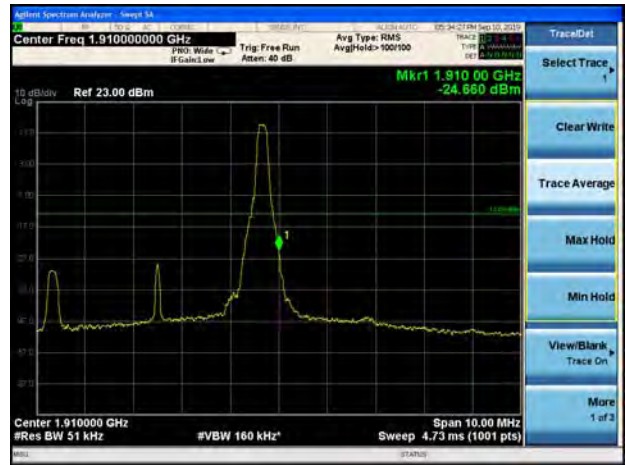

LTE Band 2 5MHz 16QAM 100%RB CH-Low

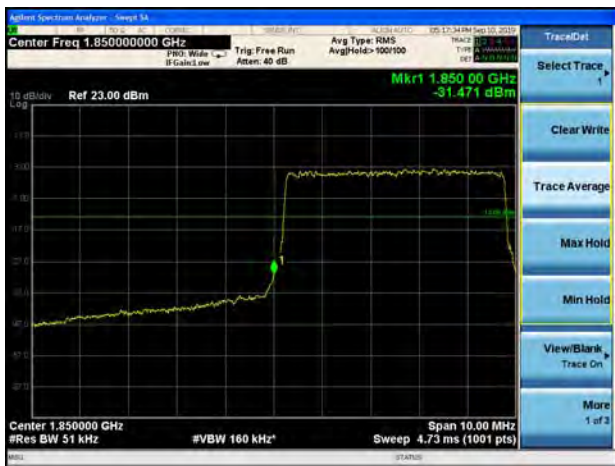

LTE Band 2 5MHz 16QAM 100%RB CH-High

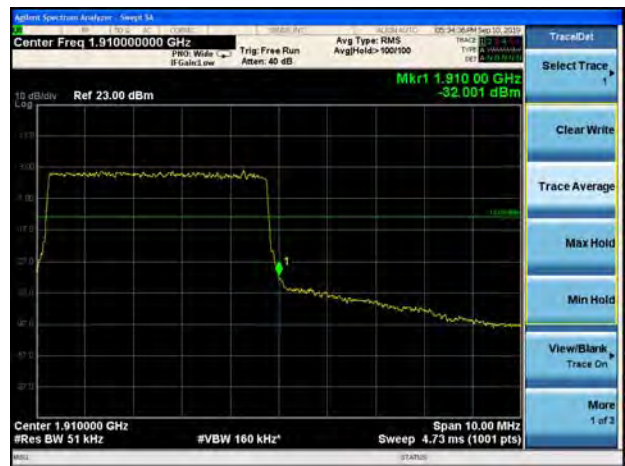

LTE Band 2 10MHz 16QAM 1RB CH-Low

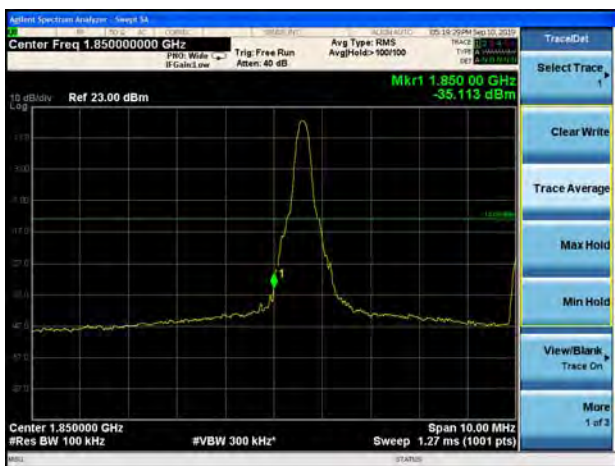

LTE Band 2 10MHz 16QAM 1RB CH-High

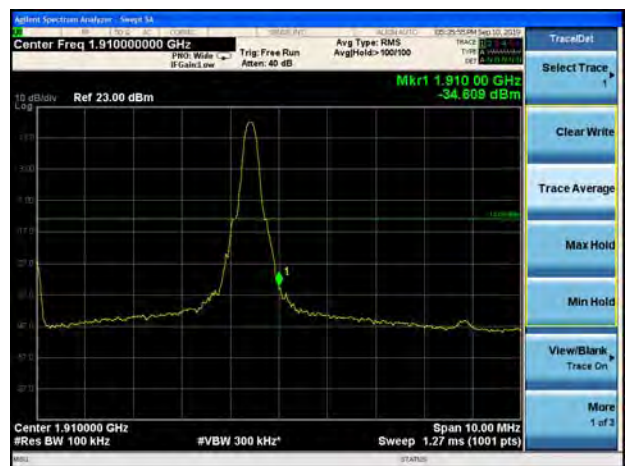



LTE Band 2 10MHz 16QAM 100%RB CH-Low

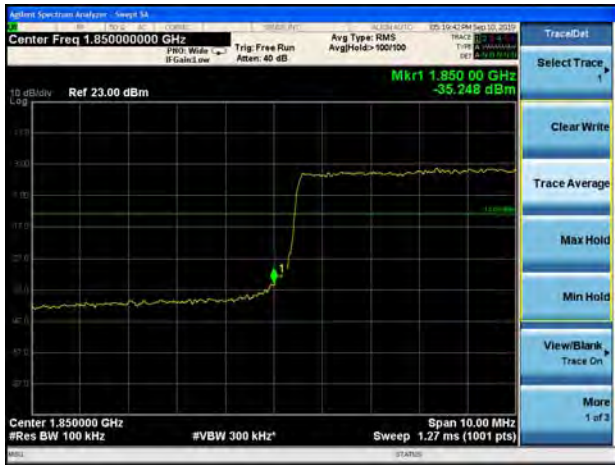

LTE Band 2 10MHz 16QAM 100%RB CH-High



LTE Band 2 15MHz 16QAM 1RB CH-Low

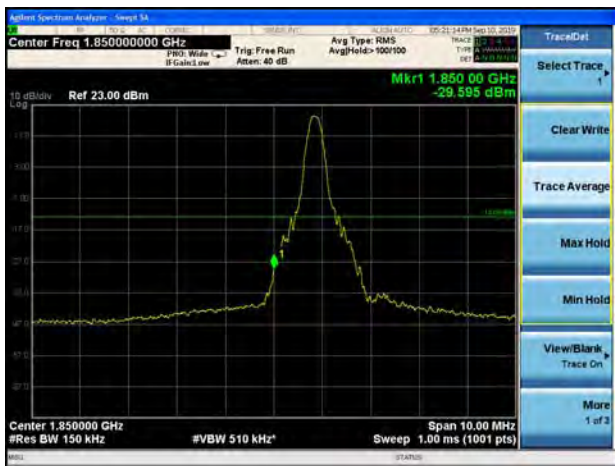

LTE Band 2 15MHz 16QAM 1RB CH-High



LTE Band 2 15MHz 16QAM 100%RB CH-Low

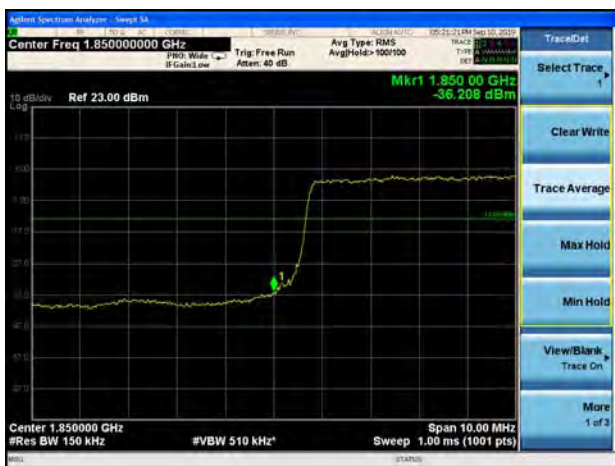

LTE Band 2 15MHz 16QAM 100%RB CH-High



LTE Band 2 20MHz 16QAM 1RB CH-Low



LTE Band 2 20MHz 16QAM 1RB CH-High



LTE Band 2 20MHz 16QAM 100%RB CH-Low

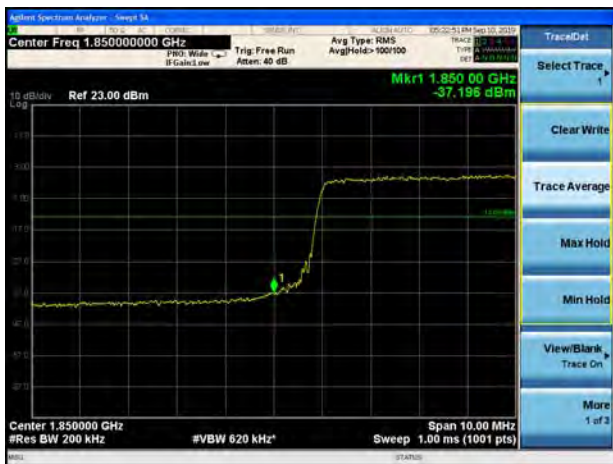

LTE Band 2 20MHz 16QAM 100%RB CH-High



LTE Band 25 1.4MHz QPSK 1RB CH-Low



LTE Band 25 1.4MHz QPSK 1RB CH-High





LTE Band 25 1.4MHz QPSK 100%RB CH-Low

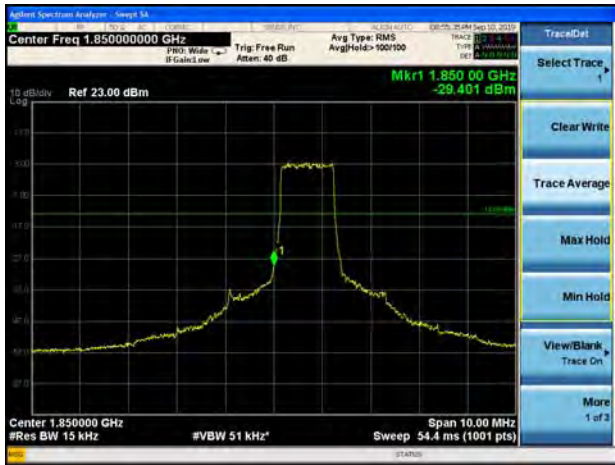

LTE Band 25 1.4MHz QPSK 100%RB CH-High



LTE Band 25 3MHz QPSK 1RB CH-Low

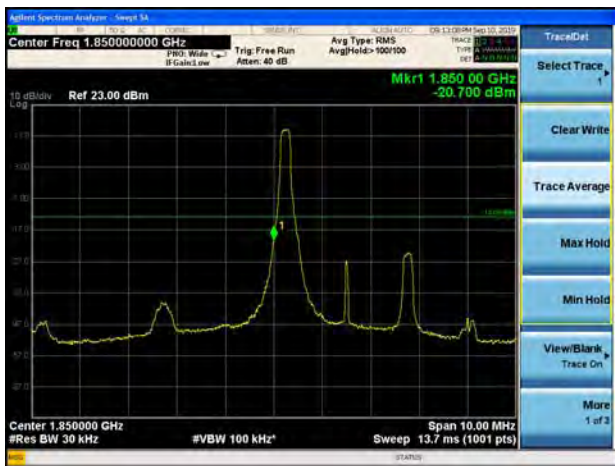

LTE Band 25 3MHz QPSK 1RB CH-High



LTE Band 25 3MHz QPSK 100%RB CH-Low

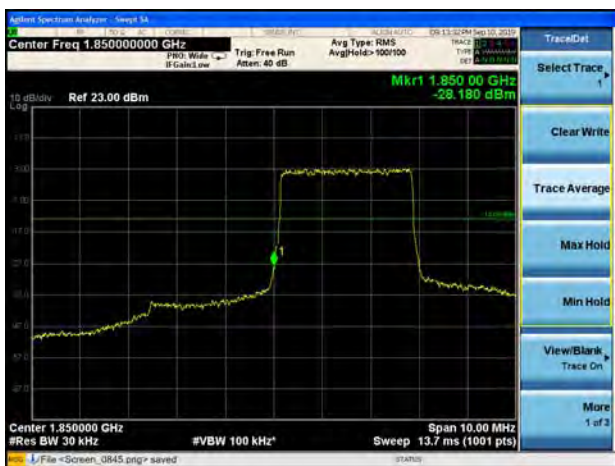

LTE Band 25 3MHz QPSK 100%RB CH-High

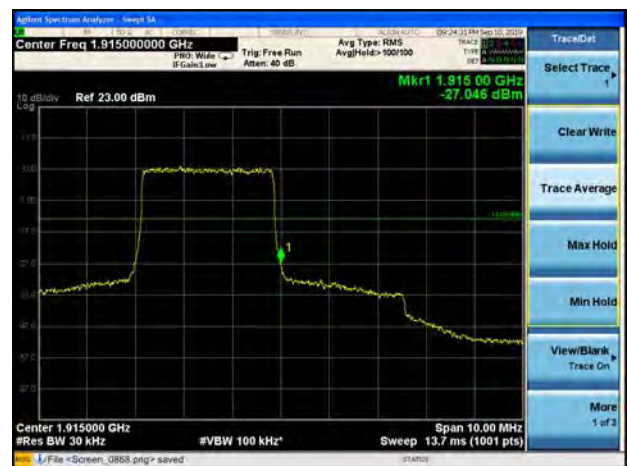



LTE Band 25 5MHz QPSK 1RB CH-Low

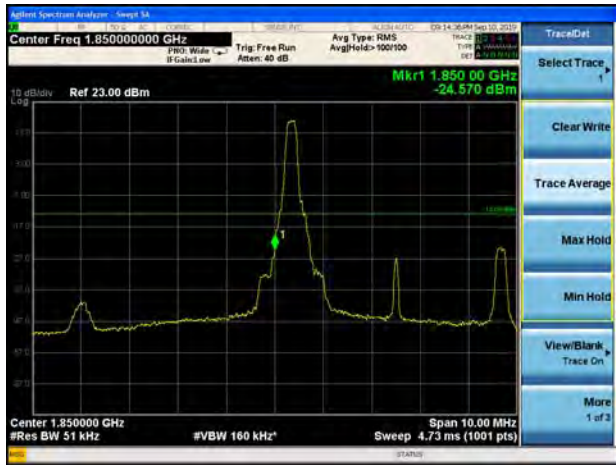

LTE Band 25 5MHz QPSK 1RB CH-High



LTE Band 25 5MHz QPSK 100%RB CH-Low

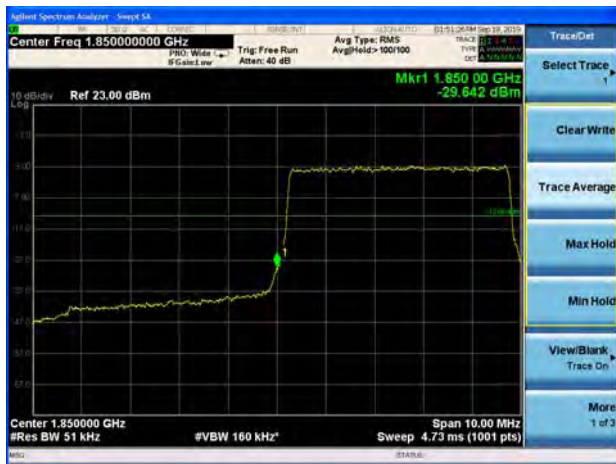

LTE Band 25 5MHz QPSK 100%RB CH-High



LTE Band 25 10MHz QPSK 1RB CH-Low

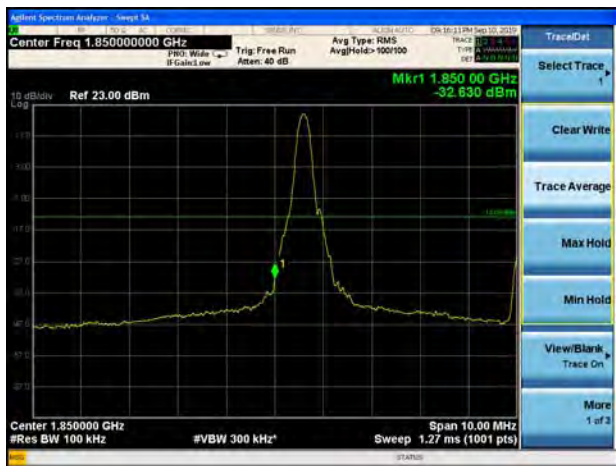

LTE Band 25 10MHz QPSK 1RB CH-High

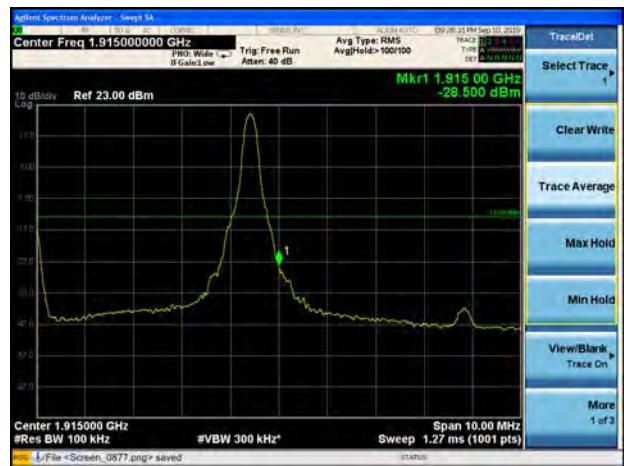



LTE Band 25 10MHz QPSK 100%RB CH-Low



LTE Band 25 10MHz QPSK 100%RB CH-High



LTE Band 25 15MHz QPSK 1RB CH-Low

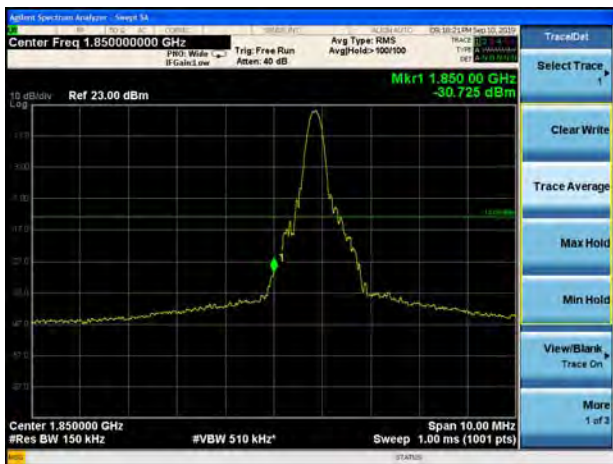

LTE Band 25 15MHz QPSK 1RB CH-High

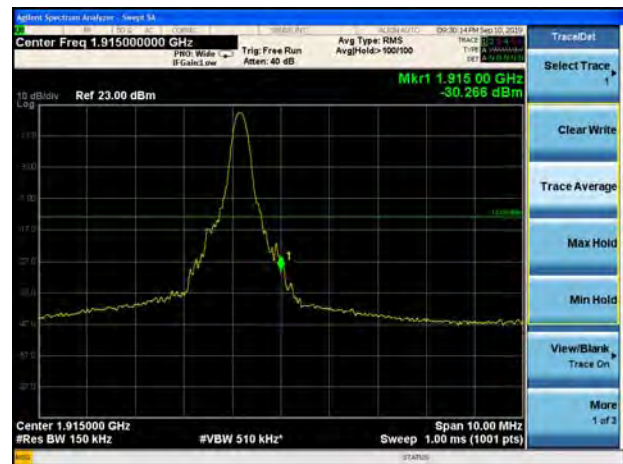

LTE Band 25 15MHz QPSK 100%RB CH-Low

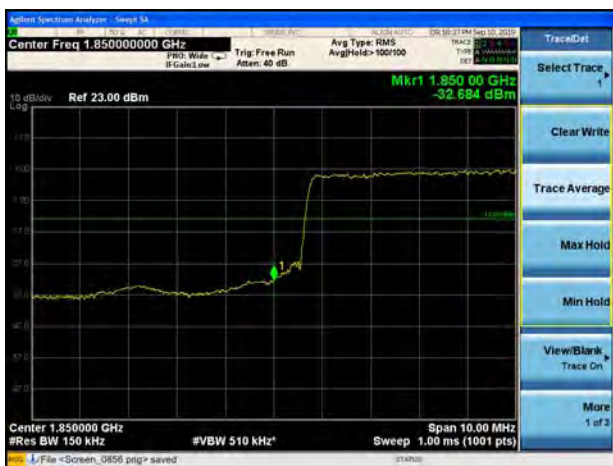

LTE Band 25 15MHz QPSK 100%RB CH-High





LTE Band 25 20MHz QPSK 1RB CH-Low

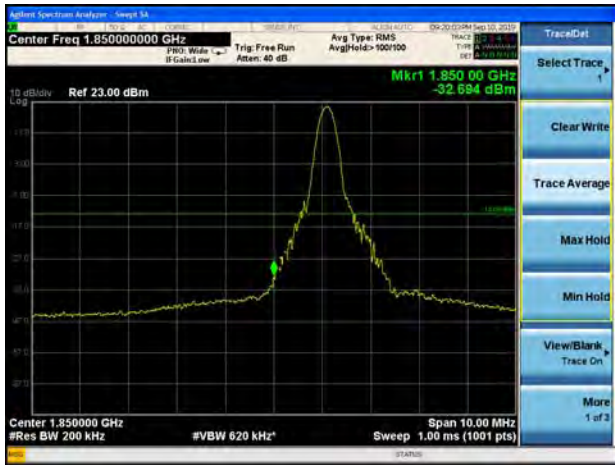

LTE Band 25 20MHz QPSK 1RB CH-High

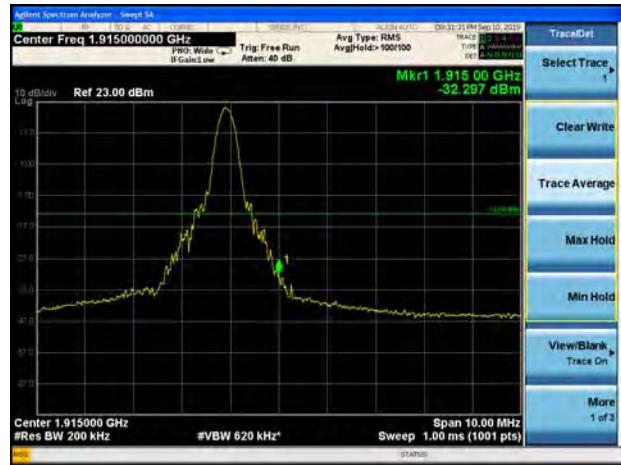

LTE Band 25 20MHz QPSK 100%RB CH-Low

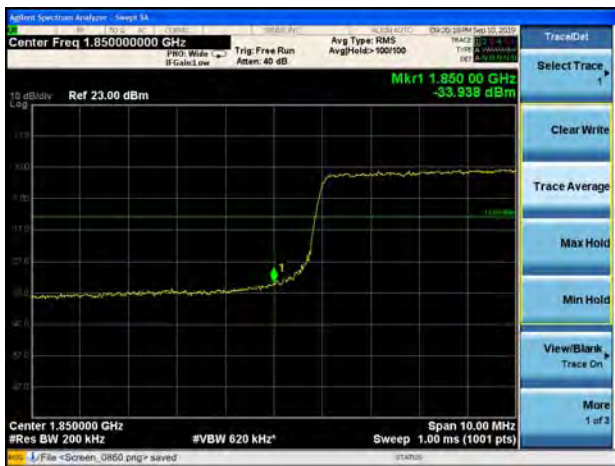

LTE Band 25 20MHz QPSK 100%RB CH-High



LTE Band 25 1.4MHz 16QAM 1RB CH-Low

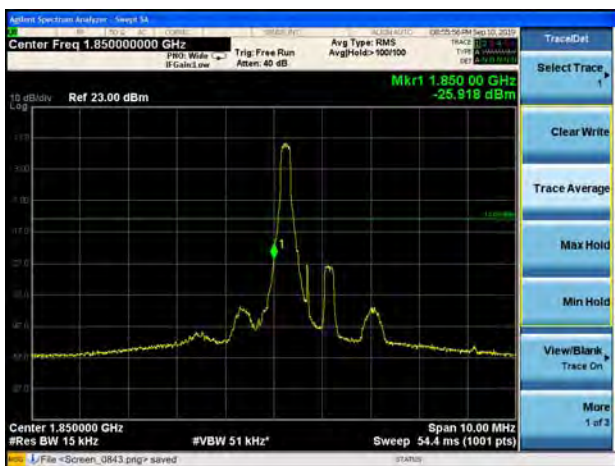

LTE Band 25 1.4MHz 16QAM 1RB CH-High





LTE Band 25 1.4MHz 16QAM 100%RB CH-Low

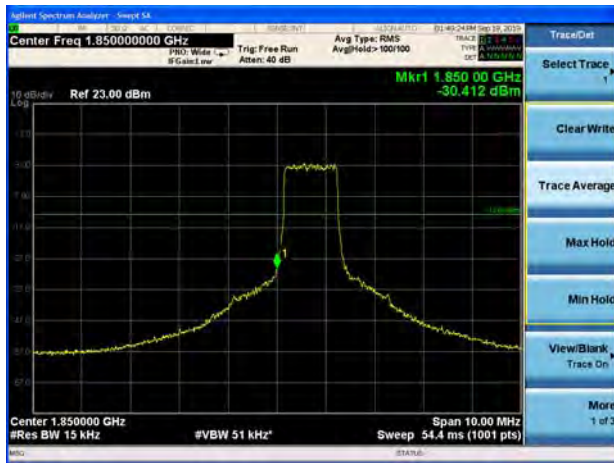

LTE Band 25 1.4MHz 16QAM 100%RB CH-High



LTE Band 25 3MHz 16QAM 1RB CH-Low

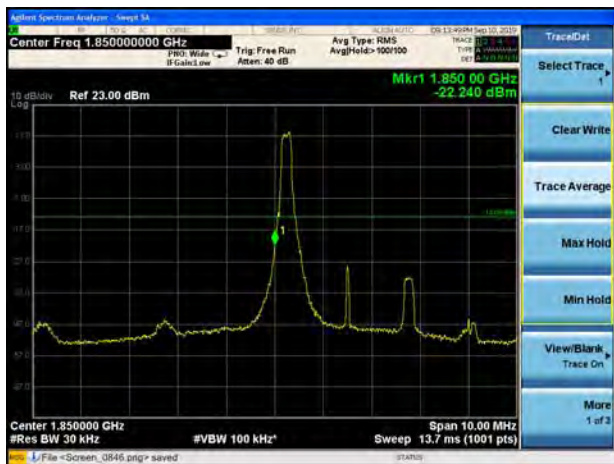

LTE Band 25 3MHz 16QAM 1RB CH-High



LTE Band 25 3MHz 16QAM 100%RB CH-Low



LTE Band 25 3MHz 16QAM 100%RB CH-High





LTE Band 25 5MHz 16QAM 1RB CH-Low

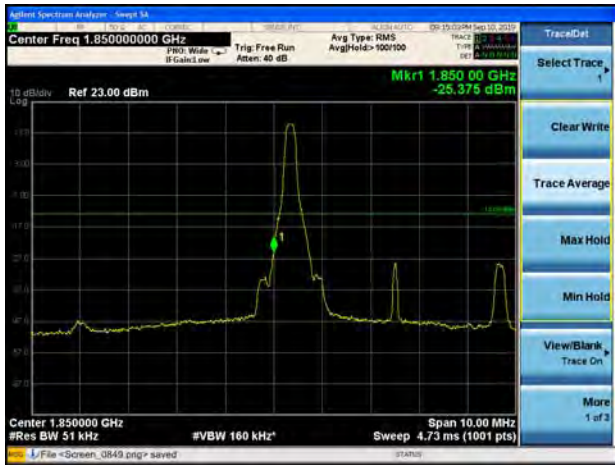

LTE Band 25 5MHz 16QAM 1RB CH-High



LTE Band 25 5MHz 16QAM 100%RB CH-Low

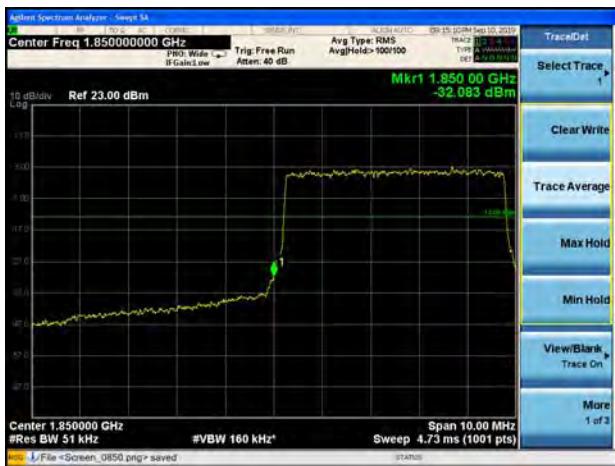

LTE Band 25 5MHz 16QAM 100%RB CH-High

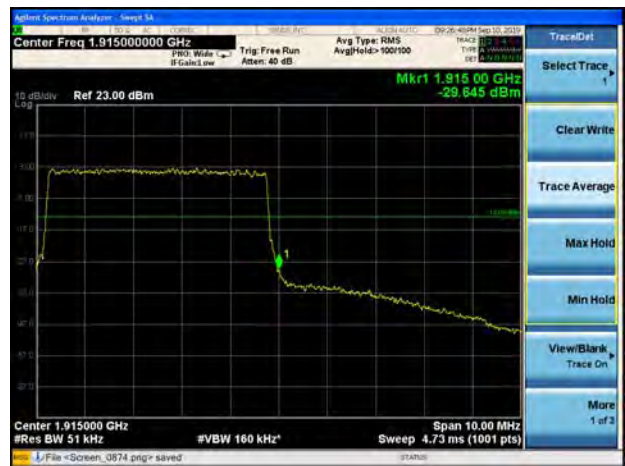

LTE Band 25 10MHz 16QAM 1RB CH-Low

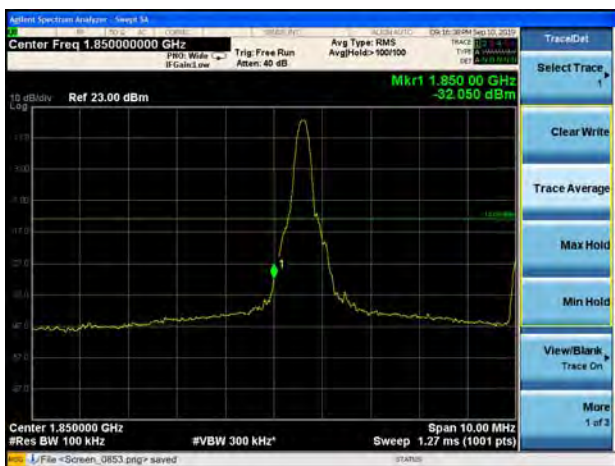

LTE Band 25 10MHz 16QAM 1RB CH-High

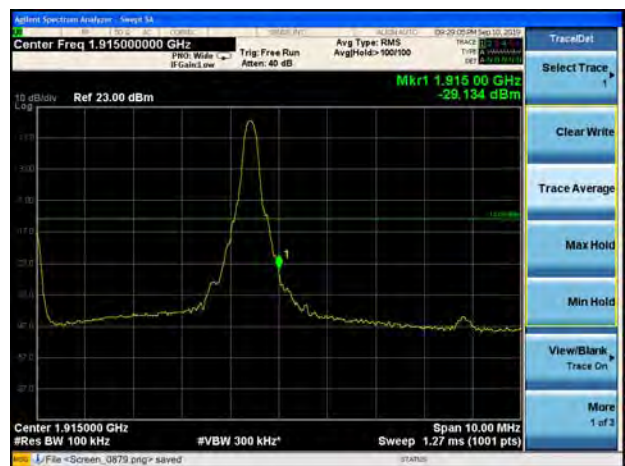



LTE Band 25 10MHz 16QAM 100%RB CH-Low

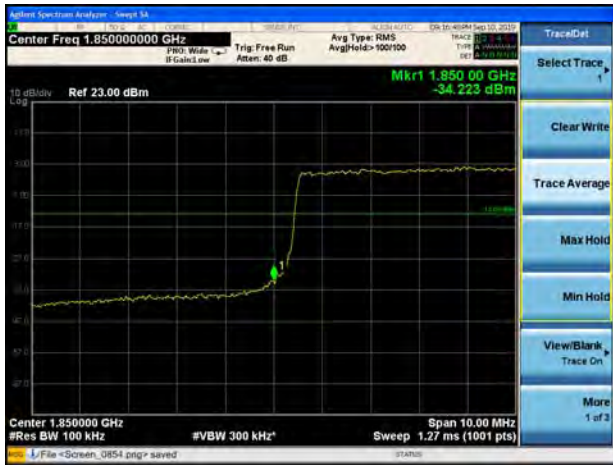

LTE Band 25 10MHz 16QAM 100%RB CH-High



LTE Band 25 15MHz 16QAM 1RB CH-Low

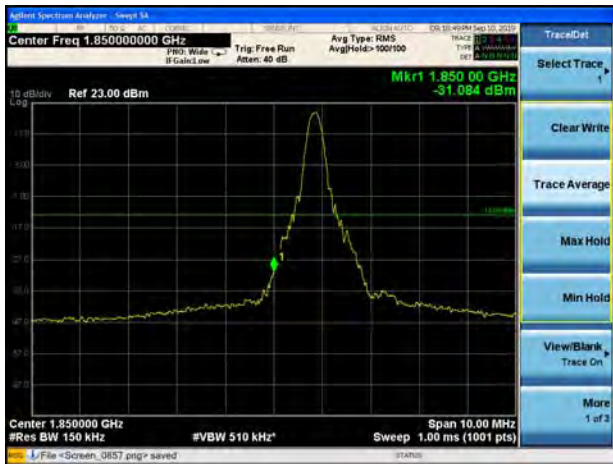

LTE Band 25 15MHz 16QAM 1RB CH-High

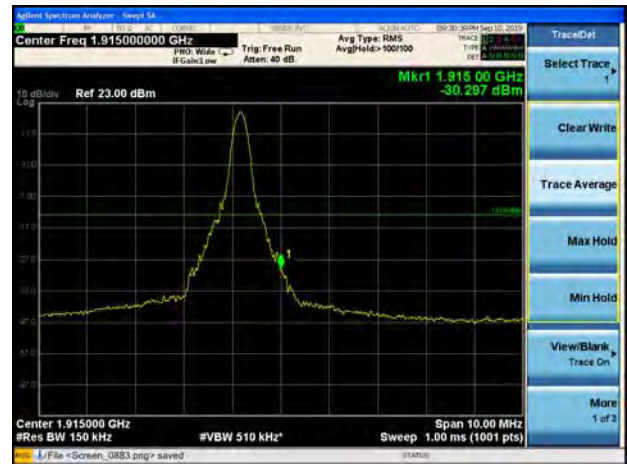

LTE Band 25 15MHz 16QAM 100%RB CH-Low



LTE Band 25 15MHz 16QAM 100%RB CH-High





LTE Band 25 20MHz 16QAM 1RB CH-Low

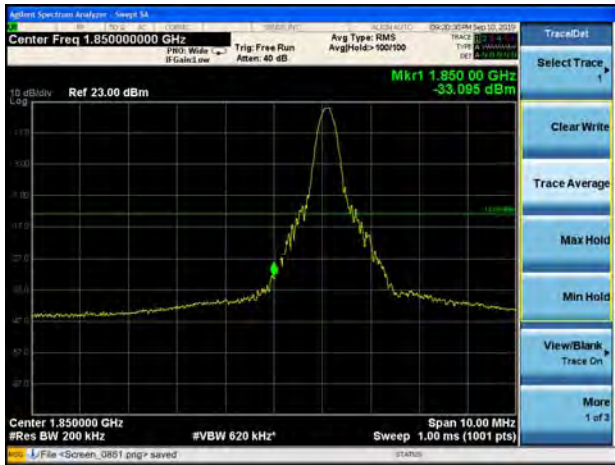

LTE Band 25 20MHz 16QAM 1RB CH-High



LTE Band 25 20MHz 16QAM 100%RB CH-Low

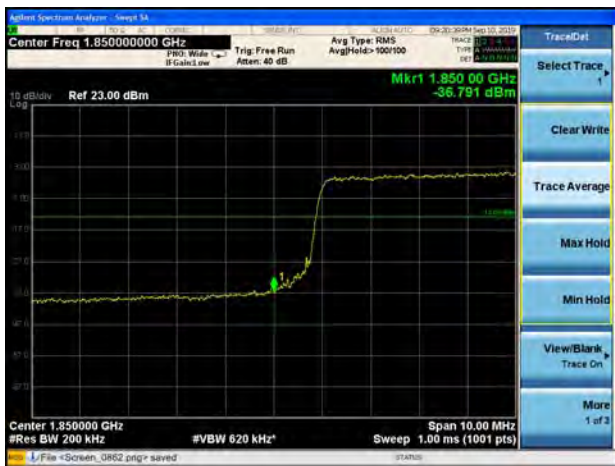

LTE Band 25 20MHz 16QAM 100%RB CH-High



6.4. Peak-to-Average Power Ratio (PAPR)

Mode	Channel	Frequency (MHz)	Peak(dBm)	Avg(dBm)	PAPR(dB)	Limit(dB)	Conclusion
GSM 1900 (GSM)	512	1850.2	31.18	29.07	2.11	≤13	PASS
	661	1880	31.23	29.15	2.08	≤13	PASS
	810	1909.8	31.33	29.2	2.13	≤13	PASS
GPRS 1900 (GMSK)	512	1850.2	31.23	29.07	2.16	≤13	PASS
	661	1880	31.45	29.22	2.23	≤13	PASS
	810	1909.8	31.37	29.2	2.17	≤13	PASS
EGPRS 1900 (8-PSK)	512	1850.2	27.79	24.9	2.89	≤13	PASS
	661	1880	27.78	25.02	2.76	≤13	PASS
	810	1909.8	27.86	24.92	2.94	≤13	PASS
WCDMA Band II (RMC)	9262	1852.4	24.83	21.89	2.94	≤13	PASS
	9400	1880	25.34	22.21	3.13	≤13	PASS
	9538	1907.6	24.91	21.91	3.00	≤13	PASS



LTE Band 2								
Modulation	Bandwidth (MHz)	Channel	Frequency (MHz)	Peak (dBm)	Avg (dBm)	PAPR (dB)	Limit (dB)	Conclusion
QPSK	1.4	18607	1850.7	26.20	22.44	3.76	≤13	PASS
		18900	1880.0	26.43	21.96	4.47	≤13	PASS
		19193	1909.3	26.20	22.03	4.17	≤13	PASS
	3	18615	1851.5	25.99	22.12	3.87	≤13	PASS
		18900	1880	26.45	21.99	4.46	≤13	PASS
		19185	1908.5	26.19	22.01	4.18	≤13	PASS
	5	18625	1852.5	25.94	21.86	4.08	≤13	PASS
		18900	1880	26.31	21.86	4.45	≤13	PASS
		19175	1907.5	26.03	21.91	4.12	≤13	PASS
	10	18650	1855	25.82	21.90	3.92	≤13	PASS
		18900	1880	26.32	21.97	4.35	≤13	PASS
		19150	1905	25.95	21.90	4.05	≤13	PASS
	15	18675	1857.5	25.93	22.01	3.92	≤13	PASS
		18900	1880	26.07	21.75	4.32	≤13	PASS
		19125	1902.5	25.92	21.71	4.21	≤13	PASS
	20	18700	1860	25.73	21.67	4.06	≤13	PASS
		18900	1880	26.08	21.87	4.21	≤13	PASS
		19100	1900	26.24	21.94	4.30	≤13	PASS
16QAM	1.4	18607	1850.7	26.19	21.54	4.65	≤13	PASS
		18900	1880.0	26.62	21.29	5.33	≤13	PASS
		19193	1909.3	26.04	20.83	5.21	≤13	PASS
	3	18615	1851.5	25.69	20.80	4.89	≤13	PASS
		18900	1880	26.68	21.39	5.29	≤13	PASS
		19185	1908.5	26.08	20.96	5.12	≤13	PASS
	5	18625	1852.5	25.64	20.63	5.01	≤13	PASS
		18900	1880	26.36	21.13	5.23	≤13	PASS
		19175	1907.5	25.77	20.67	5.10	≤13	PASS
	10	18650	1855	25.73	21.82	3.91	≤13	PASS
		18900	1880	26.65	21.50	5.15	≤13	PASS
		19150	1905	26.04	21.15	4.89	≤13	PASS
	15	18675	1857.5	25.63	20.66	4.97	≤13	PASS
		18900	1880	26.58	21.56	5.02	≤13	PASS
		19125	1902.5	25.72	20.52	5.20	≤13	PASS
	20	18700	1860	25.87	21.05	4.82	≤13	PASS
		18900	1880	25.93	20.74	5.19	≤13	PASS
		19100	1900	26.38	21.21	5.17	≤13	PASS



LTE Band 25								
Modulation	Bandwidth (MHz)	Channel	Frequency (MHz)	Peak (dBm)	Avg (dBm)	PAPR (dB)	Limit (dB)	Conclusion
QPSK	1.4	26047	1850.7	25.72	21.65	4.07	≤13	PASS
		26365	1882.5	26.54	22.05	4.49	≤13	PASS
		26683	1914.3	24.82	22.18	2.64	≤13	PASS
	3	26055	1851.5	25.95	21.99	3.96	≤13	PASS
		26365	1882.5	26.80	22.41	4.39	≤13	PASS
		26675	1913.5	25.68	22.24	3.44	≤13	PASS
	5	26065	1852.5	25.73	21.66	4.07	≤13	PASS
		26365	1882.5	26.40	21.89	4.51	≤13	PASS
		26665	1912.5	26.29	22.22	4.07	≤13	PASS
	10	26090	1855	25.99	22.03	3.96	≤13	PASS
		26365	1882.5	26.52	22.11	4.41	≤13	PASS
		26640	1910	26.26	22.25	4.01	≤13	PASS
	15	26115	1857.5	25.95	21.98	3.97	≤13	PASS
		26365	1882.5	26.48	22.05	4.43	≤13	PASS
		26615	1907.5	26.14	22.09	4.05	≤13	PASS
	20	26140	1860	25.82	21.74	4.08	≤13	PASS
		26365	1882.5	26.30	21.94	4.36	≤13	PASS
		26590	1905	26.24	22.13	4.11	≤13	PASS
16QAM	1.4	26047	1850.7	26.00	21.15	4.85	≤13	PASS
		26365	1882.5	26.43	20.98	5.45	≤13	PASS
		26683	1914.3	25.00	21.40	3.60	≤13	PASS
	3	26055	1851.5	25.68	20.74	4.94	≤13	PASS
		26365	1882.5	26.93	21.66	5.27	≤13	PASS
		26675	1913.5	25.63	21.09	4.54	≤13	PASS
	5	26065	1852.5	25.66	20.63	5.03	≤13	PASS
		26365	1882.5	26.48	21.21	5.27	≤13	PASS
		26665	1912.5	25.98	20.94	5.04	≤13	PASS
	10	26090	1855	25.73	20.80	4.93	≤13	PASS
		26365	1882.5	26.65	21.39	5.26	≤13	PASS
		26640	1910	26.21	21.17	5.04	≤13	PASS
	15	26115	1857.5	25.75	20.74	5.01	≤13	PASS
		26365	1882.5	26.54	21.30	5.24	≤13	PASS
		26615	1907.5	25.89	20.95	4.94	≤13	PASS
	20	26140	1860	25.81	20.97	4.84	≤13	PASS
		26365	1882.5	26.04	20.77	5.27	≤13	PASS
		26590	1905	26.45	21.55	4.90	≤13	PASS

6.5. Frequency Stability

GSM1900						
Condition		Freq.Error (Hz)	Freq.Error (Hz)	Frequency Stability (ppm)	Frequency Stability (ppm)	Verdict
Temperature	Voltage	GMSK	8PSK	GMSK	8PSK	
Normal (25°C)	Normal	7.90	7.18	0.00420	0.00382	PASS
Extreme (90°C)		9.82	5.58	0.00522	0.00297	PASS
Extreme (80°C)		12.06	7.30	0.00641	0.00388	PASS
Extreme (70°C)		6.90	11.27	0.00367	0.00600	PASS
Extreme (60°C)		6.03	16.50	0.00321	0.00878	PASS
Extreme (50°C)		8.62	6.95	0.00459	0.00370	PASS
Extreme (40°C)		15.92	3.81	0.00847	0.00203	PASS
Extreme (30°C)		10.47	14.10	0.00557	0.00750	PASS
Extreme (20°C)		12.01	1.91	0.00639	0.00101	PASS
Extreme (10°C)		15.96	11.82	0.00849	0.00629	PASS
Extreme (0°C)		4.14	17.14	0.00220	0.00912	PASS
Extreme (-10°C)		7.42	14.55	0.00394	0.00774	PASS
Extreme (-20°C)		15.61	11.72	0.00830	0.00623	PASS
Extreme (-30°C)		10.38	6.25	0.00552	0.00332	PASS
Extreme (-40°C)		15.38	9.13	0.00818	0.00486	PASS
25°C		LV	8.27	6.34	0.00440	0.00337
	HV	15.98	1.95	0.00850	0.00104	PASS

WCDMA Band 2						
Condition		Freq.Error (Hz)	Freq.Error (Hz)	Frequency Stability (ppm)	Frequency Stability (ppm)	Verdict
Temperature	Voltage	BPSK	QPSK	BPSK	QPSK	
Normal (25°C)	Normal	2.54	5.85	0.00135	0.00311	PASS
Extreme (90°C)		3.08	15.72	0.00164	0.00836	PASS
Extreme (80°C)		17.19	8.59	0.00914	0.00457	PASS
Extreme (70°C)		4.01	3.73	0.00214	0.00198	PASS
Extreme (60°C)		14.99	15.66	0.00798	0.00833	PASS
Extreme (50°C)		9.28	7.91	0.00494	0.00420	PASS
Extreme (40°C)		8.90	10.41	0.00474	0.00554	PASS
Extreme (30°C)		16.52	14.20	0.00879	0.00755	PASS
Extreme (20°C)		16.55	16.63	0.00880	0.00884	PASS
Extreme (10°C)		4.98	4.12	0.00265	0.00219	PASS
Extreme (0°C)		9.53	10.01	0.00507	0.00532	PASS
Extreme (-10°C)		12.84	9.42	0.00683	0.00501	PASS
Extreme (-20°C)		15.74	12.39	0.00837	0.00659	PASS
Extreme (-30°C)		8.96	10.76	0.00477	0.00572	PASS
Extreme (-40°C)		10.41	8.92	0.00554	0.00474	PASS
25°C	LV	2.59	11.22	0.00138	0.00597	PASS
	HV	15.19	15.03	0.00808	0.00799	PASS



LTE Band 2						
Condition		Freq.Error (Hz)	Freq.Error (Hz)	Frequency Stability (ppm)	Frequency Stability (ppm)	Verdict
BANDWIDTH	10MHz					
Temperature	Voltage	16QAM	QPSK	16QAM	QPSK	
Normal (25°C)	Normal	13.83	8.58	0.00735	0.00457	PASS
Extreme (90°C)		3.00	13.45	0.00159	0.00715	PASS
Extreme (80°C)		8.81	1.51	0.00469	0.00081	PASS
Extreme (70°C)		8.50	17.44	0.00452	0.00928	PASS
Extreme (60°C)		4.47	16.74	0.00238	0.00890	PASS
Extreme (50°C)		17.22	8.52	0.00916	0.00453	PASS
Extreme (40°C)		10.40	13.42	0.00553	0.00714	PASS
Extreme (30°C)		8.01	15.09	0.00426	0.00803	PASS
Extreme (20°C)		14.59	1.98	0.00776	0.00105	PASS
Extreme (10°C)		2.43	8.04	0.00129	0.00428	PASS
Extreme (0°C)		8.58	17.35	0.00456	0.00923	PASS
Extreme (-10°C)		8.42	4.46	0.00448	0.00237	PASS
Extreme (-20°C)		13.89	11.77	0.00739	0.00626	PASS
Extreme (-30°C)		3.72	12.22	0.00198	0.00650	PASS
Extreme (-40°C)		13.29	2.41	0.00707	0.00128	PASS
25°C		LV	6.03	7.50	0.00321	0.00399
	HV	8.60	14.63	0.00457	0.00778	PASS

LTE Band 25						
Condition		Freq.Error (Hz)	Freq.Error (Hz)	Frequency Stability (ppm)	Frequency Stability (ppm)	Verdict
BANDWIDTH	10MHz					
Temperature	Voltage	16QAM	QPSK	16QAM	QPSK	
Normal (25°C)	Normal	6.55	9.17	0.00348	0.00488	PASS
Extreme (90°C)		7.32	3.81	0.00389	0.00203	PASS
Extreme (80°C)		9.35	7.90	0.00498	0.00420	PASS
Extreme (70°C)		8.85	1.44	0.00471	0.00077	PASS
Extreme (60°C)		3.40	10.35	0.00181	0.00550	PASS
Extreme (50°C)		8.87	14.27	0.00472	0.00759	PASS
Extreme (40°C)		14.54	10.84	0.00774	0.00577	PASS
Extreme (30°C)		14.58	14.20	0.00776	0.00755	PASS
Extreme (20°C)		4.76	9.14	0.00253	0.00486	PASS
Extreme (10°C)		7.29	12.06	0.00388	0.00642	PASS
Extreme (0°C)		3.43	6.63	0.00183	0.00353	PASS
Extreme (-10°C)		14.69	14.69	0.00781	0.00781	PASS
Extreme (-20°C)		13.51	6.19	0.00719	0.00329	PASS
Extreme (-30°C)		11.93	7.61	0.00635	0.00405	PASS
Extreme (-40°C)		2.87	3.80	0.00153	0.00202	PASS
25°C		LV	4.29	15.37	0.00228	0.00817
	HV	1.98	7.58	0.00106	0.00403	PASS



6.6. Spurious Emissions at Antenna Terminals

Sweep the whole frequency band through the range from 9kHz to the 10th harmonic of the carrier, the emissions more than 20 dB below the limit are not reported.

The signal beyond the limit is carrier.

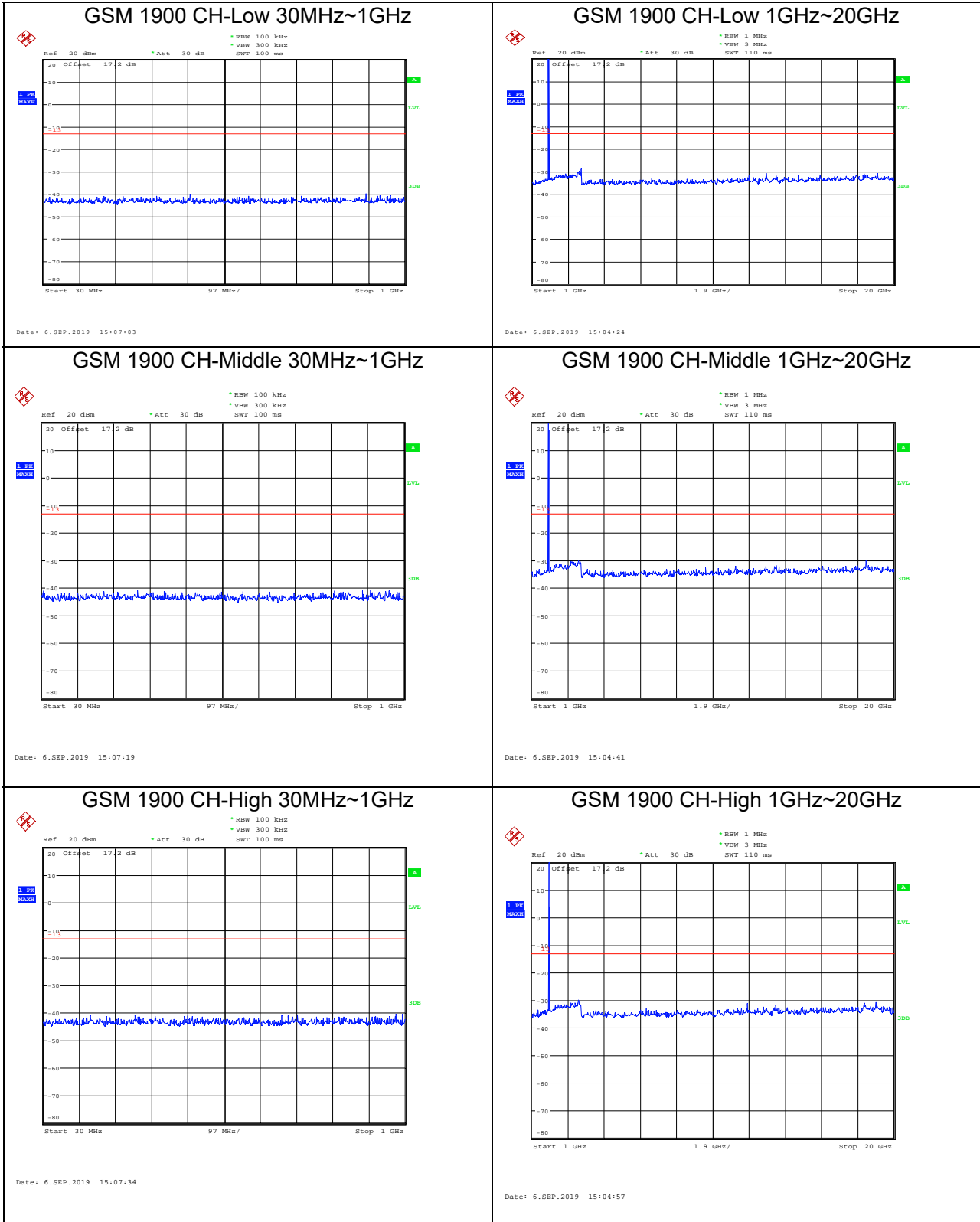



WCDMA Band II CH-Low 30MHz~1GHz

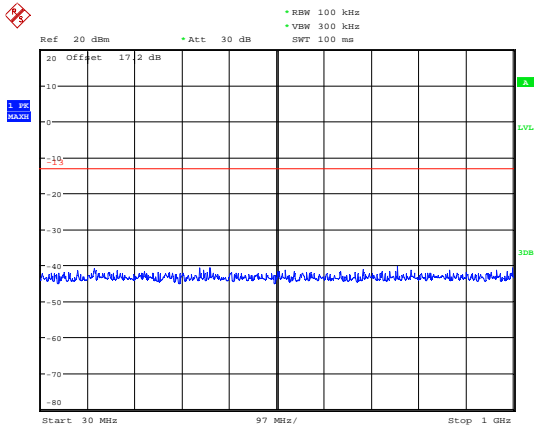

Date: 6.SEP.2019 13:31:41

WCDMA BAND II CH-Low 3GHz~20GHz

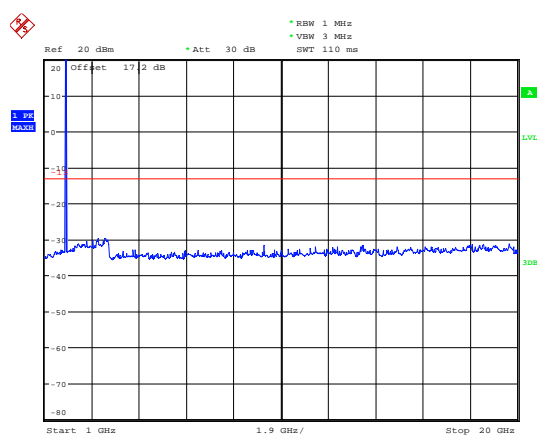

Date: 6.SEP.2019 13:23:15

WCDMA Band II CH- Middle 30MHz~1GHz

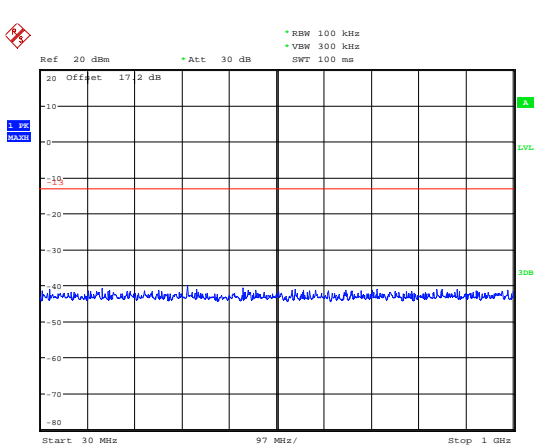

Date: 6.SEP.2019 13:32:03

WCDMA BAND II CH-Middle 1GHz~20GHz

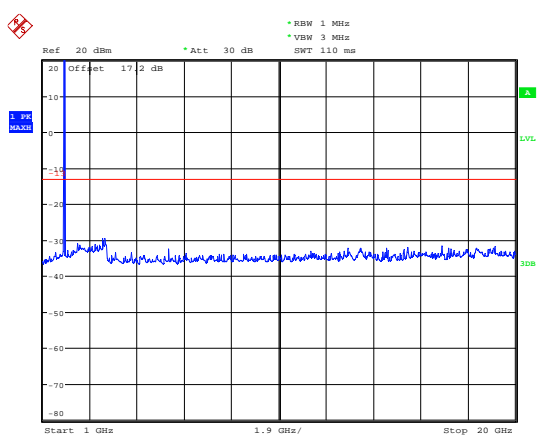

Date: 6.SEP.2019 13:23:38

WCDMA Band II CH- High 30MHz~1GHz

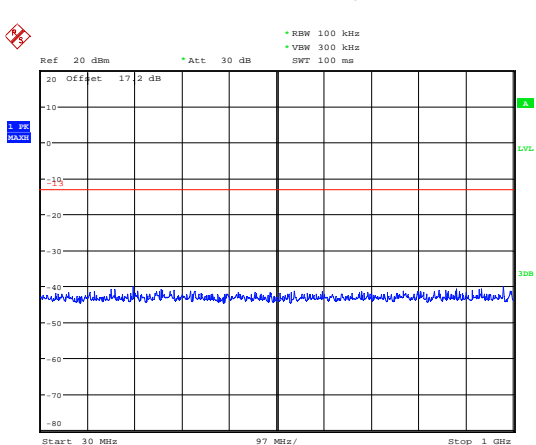

Date: 6.SEP.2019 13:32:24

WCDMA BAND II CH-High 1GHz~20GHz

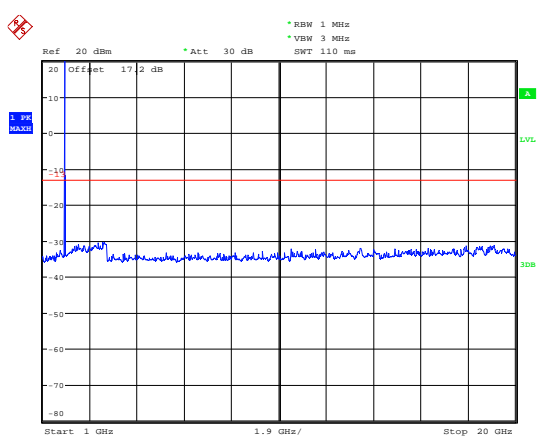

Date: 6.SEP.2019 13:24:03



LTE Band 2 1.4MHz CH-Low 30MHz~1GHz

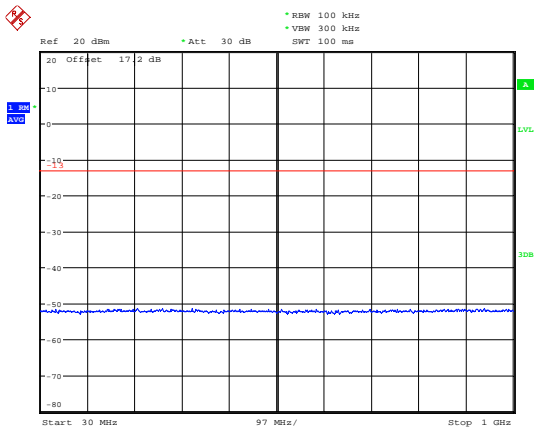

Date: 9.SEP.2019 18:51:57

LTE Band 2 1.4MHz CH-Low 1GHz~20GHz

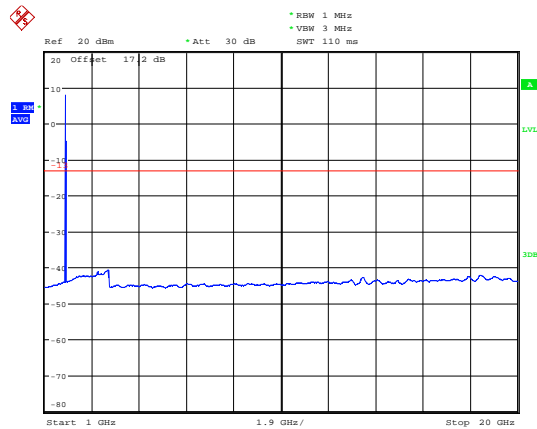

Date: 9.SEP.2019 19:05:14

LTE Band 2 1.4MHz CH-Middle 30MHz~1GHz

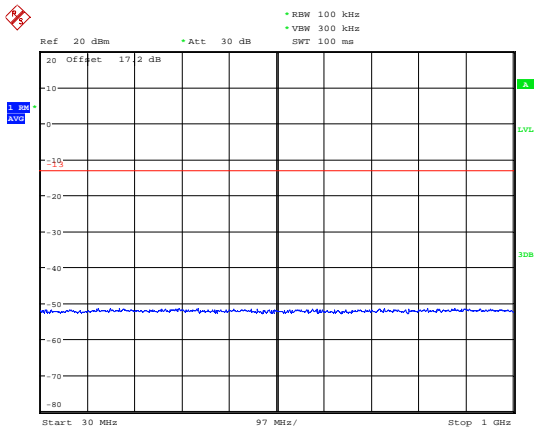

Date: 9.SEP.2019 18:52:17

LTE Band 2 1.4MHz CH-Middle 1GHz~20GHz

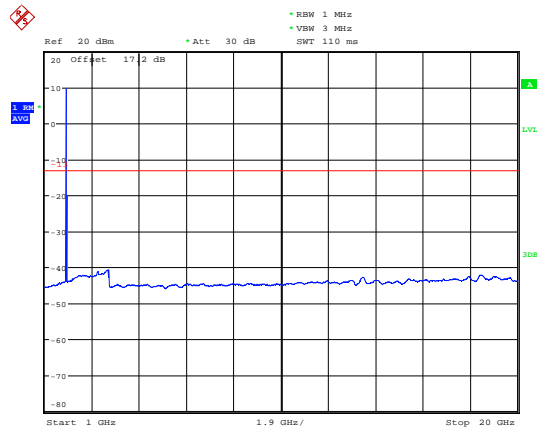

Date: 9.SEP.2019 19:05:32

LTE Band 2 1.4MHz CH-High 30MHz~1GHz

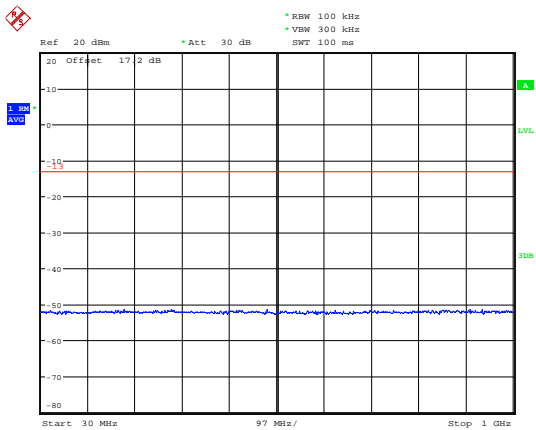

Date: 9.SEP.2019 18:52:23

LTE Band 2 1.4MHz CH-High 1GHz~20GHz

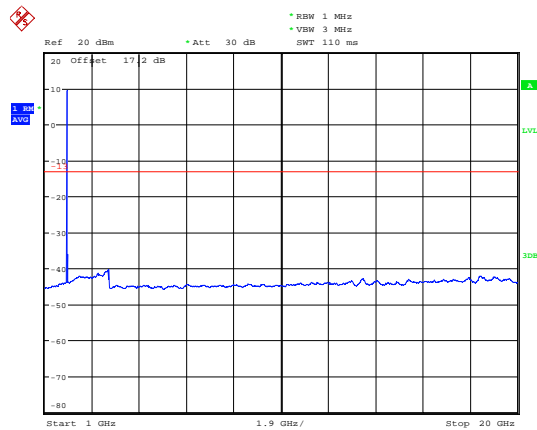

Date: 9.SEP.2019 19:05:53



LTE Band 2 3MHz CH-Low 30MHz~1GHz

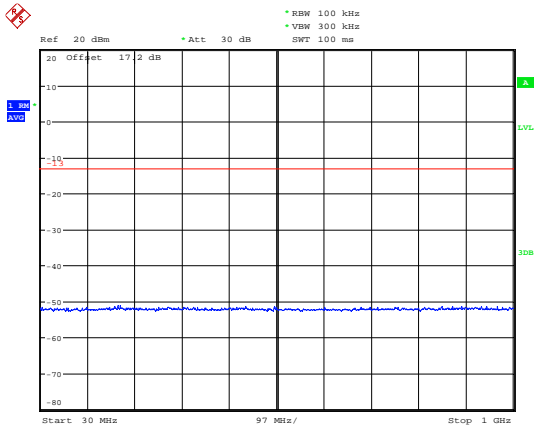

Date: 9.SEP.2019 18:52:50

LTE Band 2 3MHz CH-Low 1GHz~20GHz

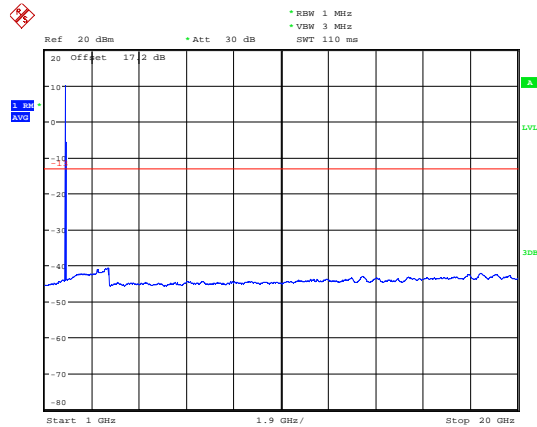

Date: 9.SEP.2019 19:06:15

LTE Band 2 3MHz CH-Middle 30MHz~1GHz

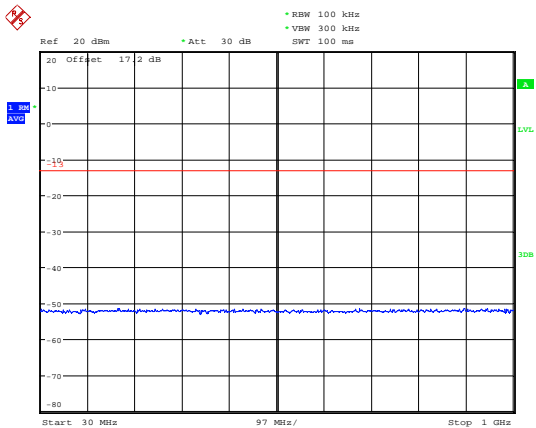

Date: 9.SEP.2019 18:53:01

LTE Band 2 3MHz CH-Middle 1GHz~20GHz

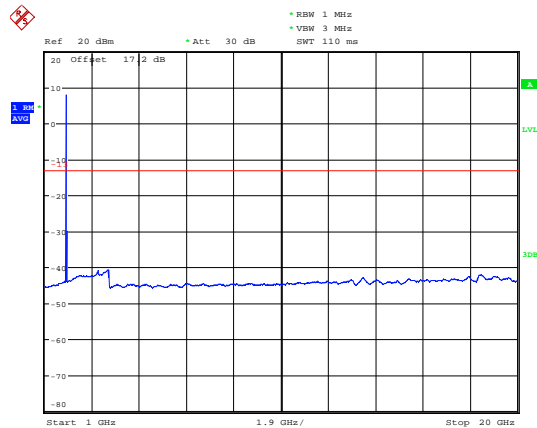

Date: 9.SEP.2019 19:06:35

LTE Band 2 3MHz CH-High 30MHz~1GHz

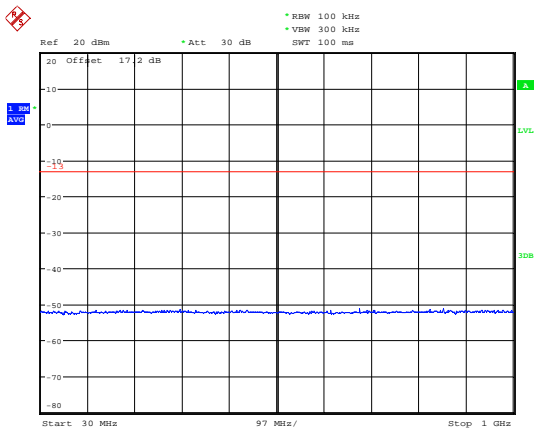

Date: 9.SEP.2019 18:53:09

LTE Band 23MHz CH-High 1GHz~20GHz

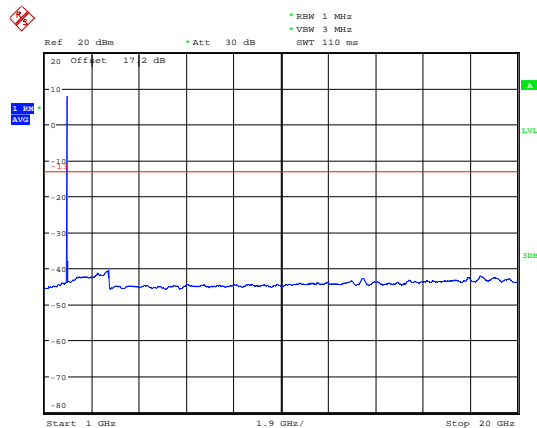

Date: 9.SEP.2019 19:06:53



LTE Band 2 5MHz CH-Low 30MHz~1GHz

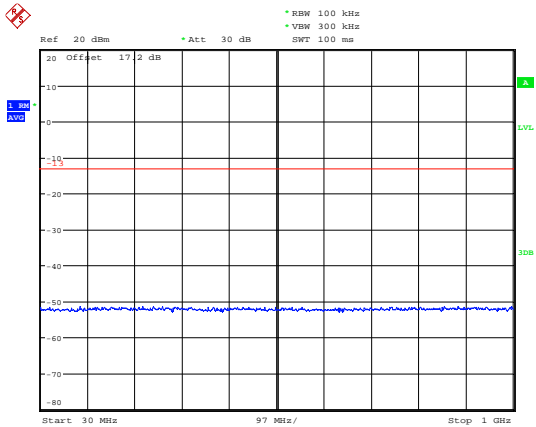

Date: 9.SEP.2019 18:53:26

LTE Band 2 5MHz CH-Low 1GHz~20GHz

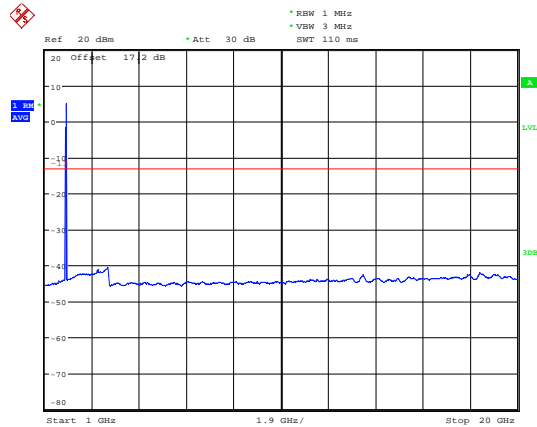

Date: 9.SEP.2019 19:07:11

LTE Band 2 5MHz CH-Middle 30MHz~1GHz

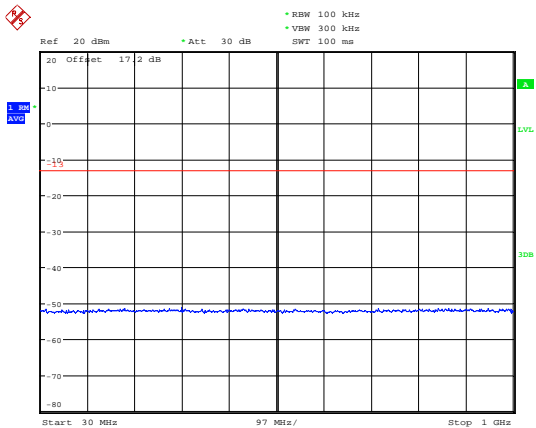

Date: 9.SEP.2019 18:53:34

LTE Band 2 5MHz CH-Middle 1GHz~20GHz

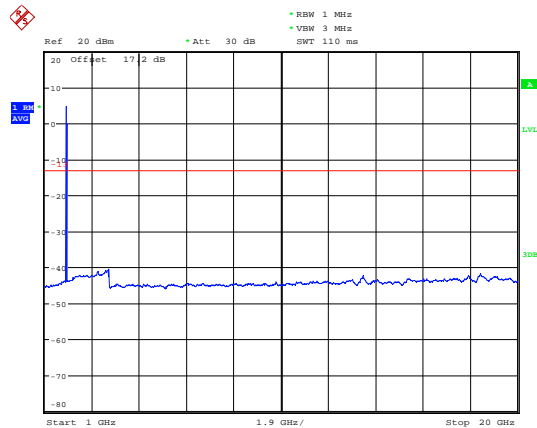

Date: 9.SEP.2019 19:07:29

LTE Band 2 5MHz CH-High 30MHz~1GHz

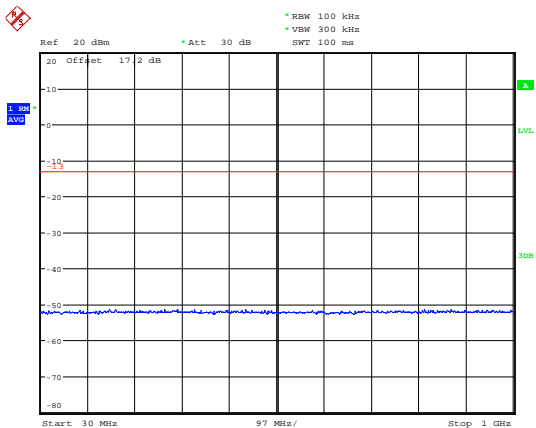

Date: 9.SEP.2019 18:53:39

LTE Band 2 5MHz CH-High 1GHz~20GHz

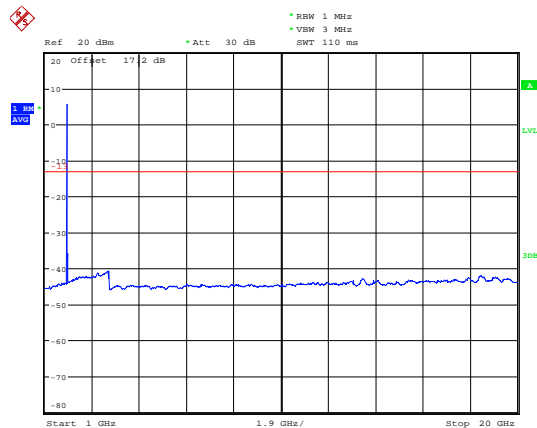

Date: 9.SEP.2019 19:07:42



LTE Band 2 10MHz CH-Low 30MHz~1GHz

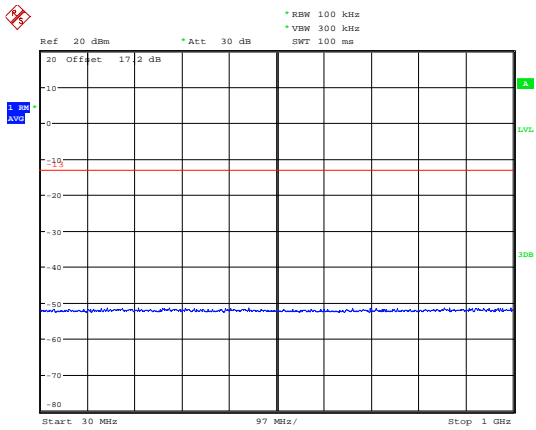

Date: 9.SEP.2019 18:53:56

LTE Band 2 10MHz CH-Low 1GHz~20GHz

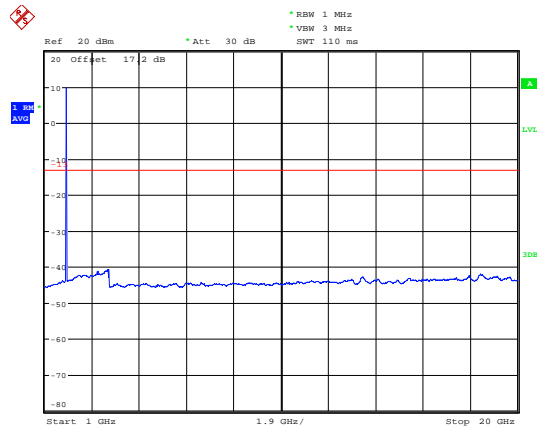

Date: 9.SEP.2019 19:08:02

LTE Band 2 10MHz CH-Middle 30MHz~1GHz

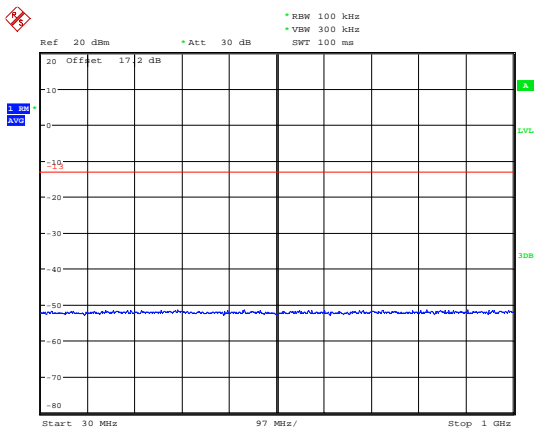

Date: 9.SEP.2019 18:54:03

LTE Band 2 10MHz CH-Middle 1GHz~20GHz

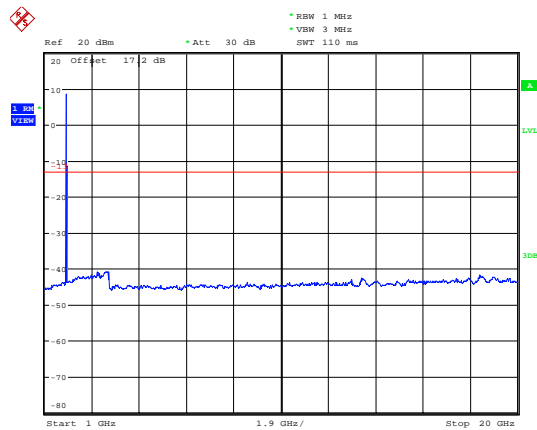

Date: 9.SEP.2019 19:08:19

LTE Band 2 10MHz CH-High 30MHz~1GHz

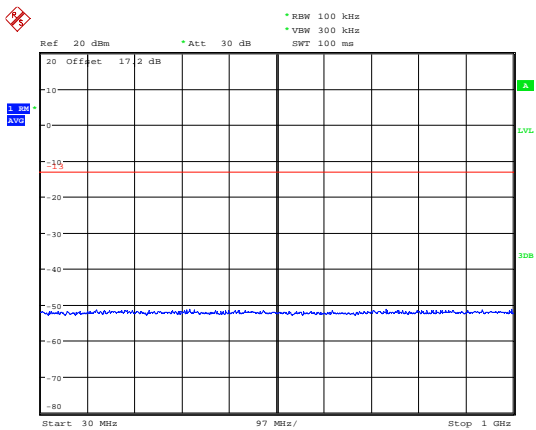

Date: 9.SEP.2019 18:54:19

LTE Band 2 10MHz CH-High 1GHz~20GHz

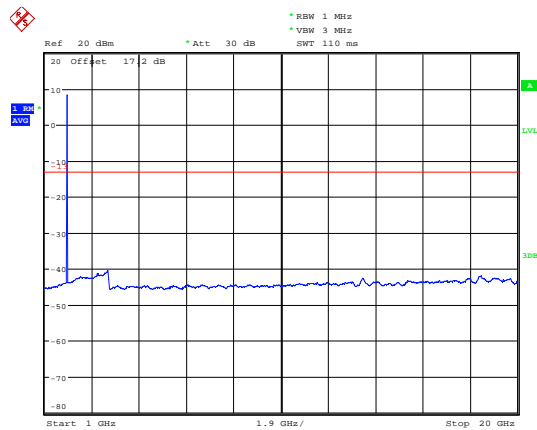

Date: 9.SEP.2019 19:08:34



LTE Band 2 15MHz CH-Low 30MHz~1GHz

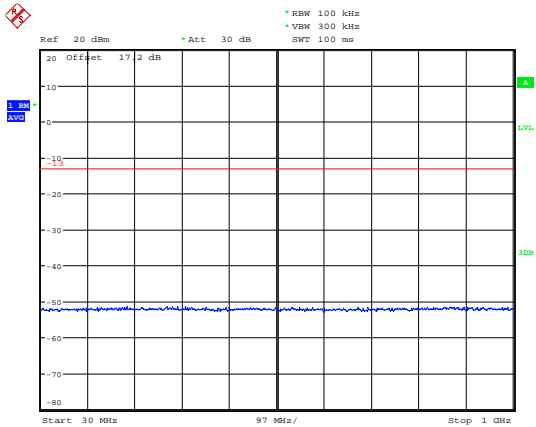

Date: 9.SEP.2019 18:54:51

LTE Band 2 15MHz CH-Low 1GHz~20GHz

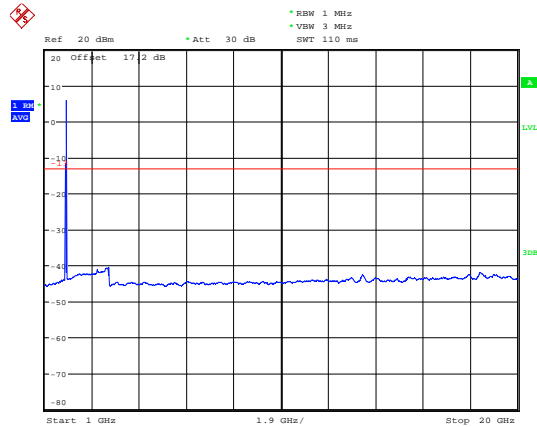

Date: 9.SEP.2019 19:08:58

LTE Band 2 15MHz CH-Middle 30MHz~1GHz

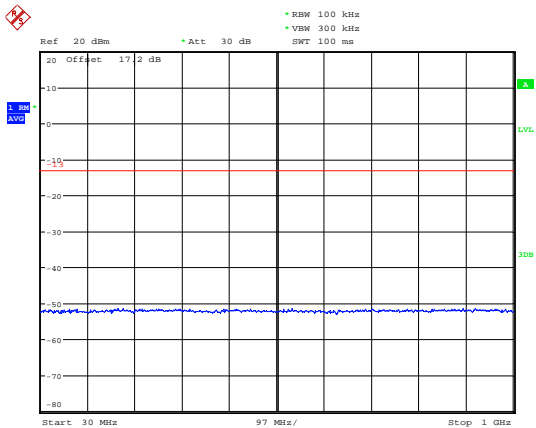

Date: 9.SEP.2019 18:54:59

LTE Band 2 15MHz CH-Middle 1GHz~20GHz

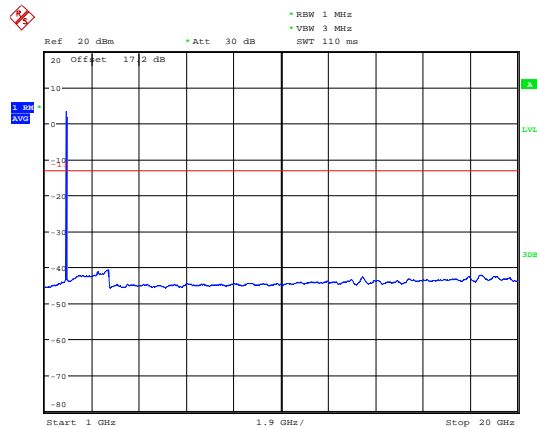

Date: 9.SEP.2019 19:09:15

LTE Band 2 15MHz CH-High 30MHz~1GHz

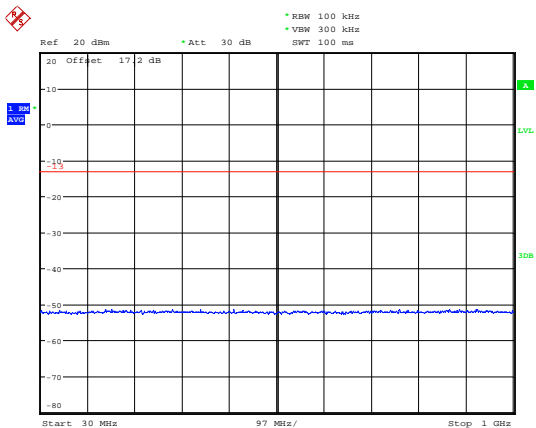

Date: 9.SEP.2019 18:55:16

LTE Band 2 15MHz CH-High 1GHz~20GHz

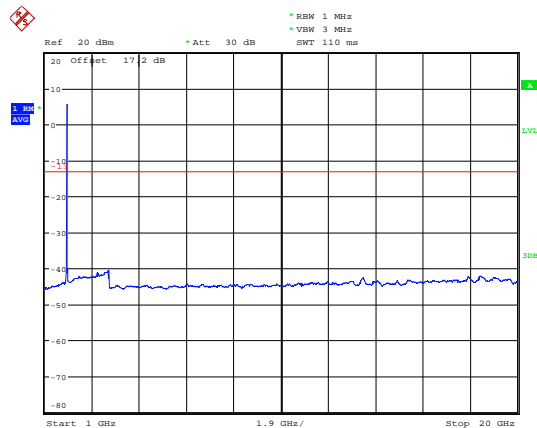

Date: 9.SEP.2019 19:10:09



LTE Band 2 20MHz CH-Low 30MHz~1GHz

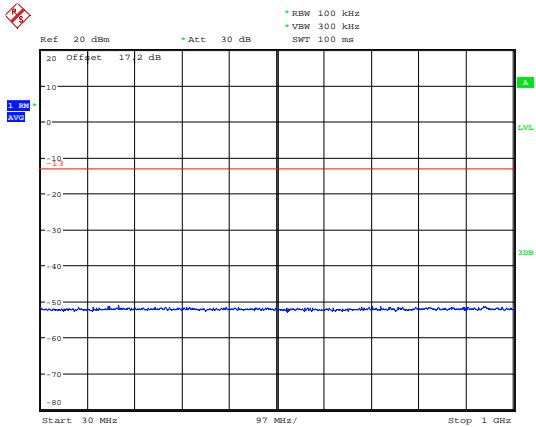

Date: 9.SEP.2019 18:55:29

LTE Band 2 20MHz CH-Low 1GHz~20GHz

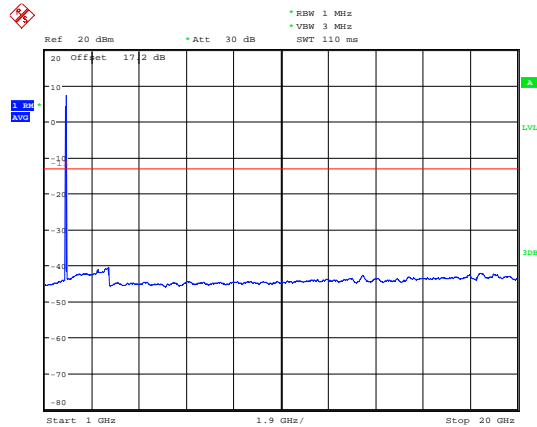

Date: 9.SEP.2019 19:10:28

LTE Band 2 20MHz CH-Middle 30MHz~1GHz

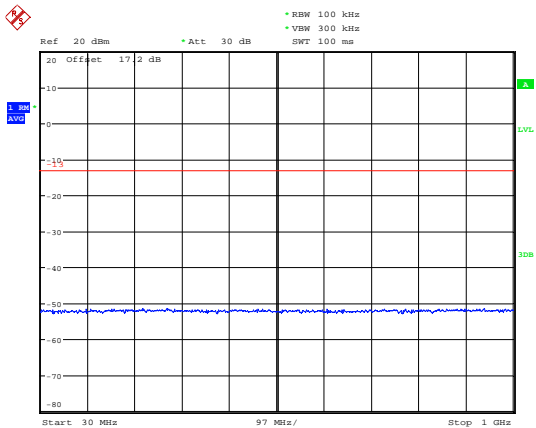

Date: 9.SEP.2019 18:55:36

LTE Band 2 20MHz CH-Middle 1GHz~20GHz

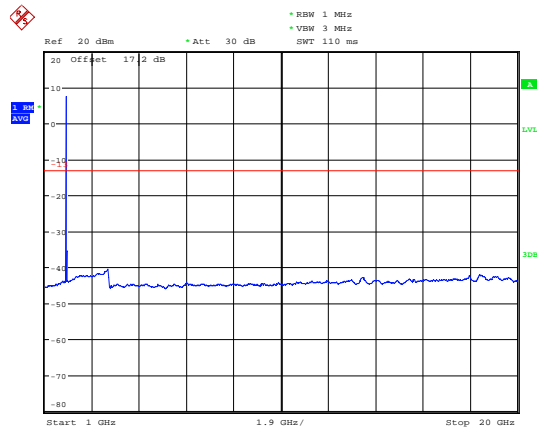

Date: 9.SEP.2019 19:10:43

LTE Band 2 20MHz CH-High 30MHz~1GHz

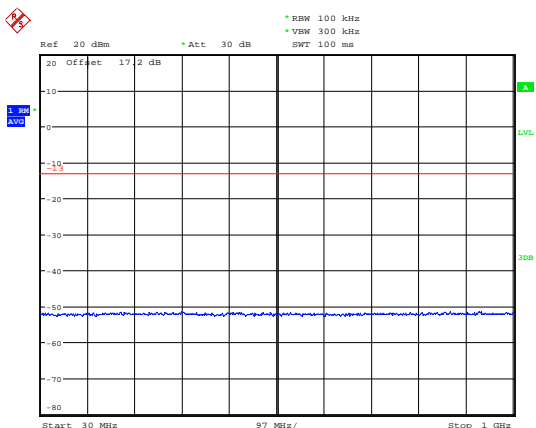

Date: 9.SEP.2019 18:55:41

LTE Band 2 20MHz CH-High 1GHz~20GHz

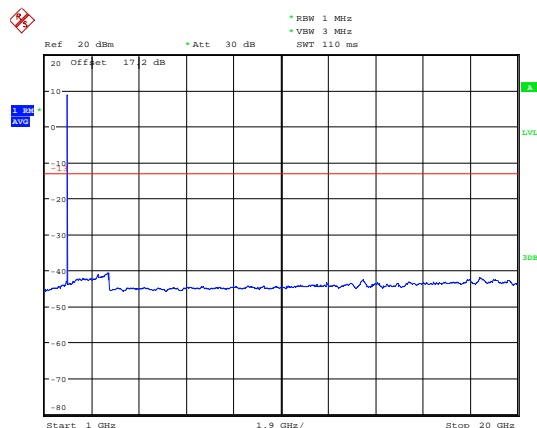

Date: 9.SEP.2019 19:10:53



LTE Band 25 1.4MHz CH-Low 30MHz~1GHz

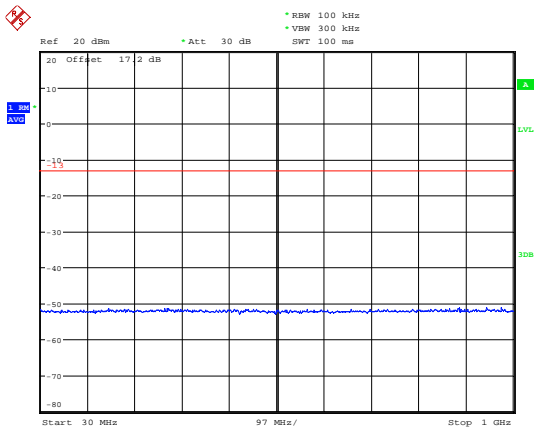

Date: 9.SEP.2019 20:21:33

LTE Band 25 1.4MHz CH-Low 1GHz~20GHz

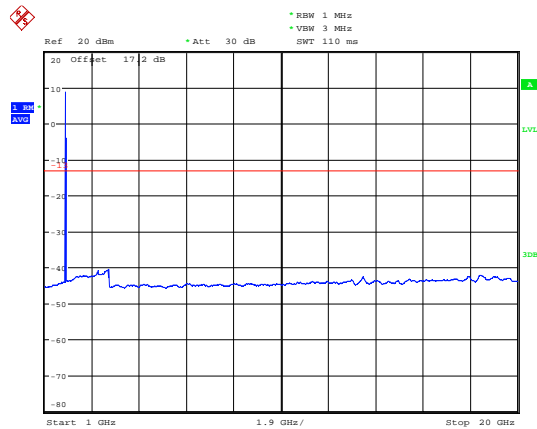

Date: 9.SEP.2019 20:42:24

LTE Band 25 1.4MHz CH-Middle 30MHz~1GHz

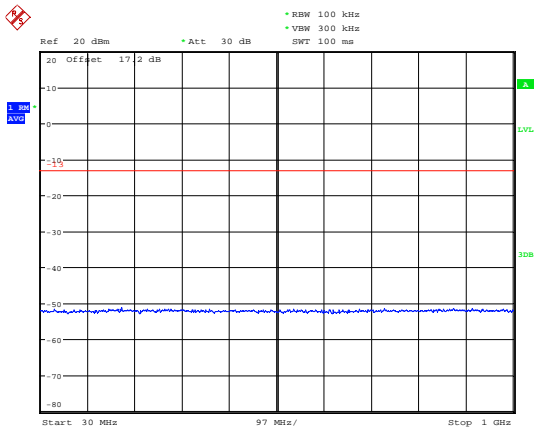

Date: 9.SEP.2019 20:21:56

LTE Band 25 1.4MHz CH-Middle 1GHz~20GHz

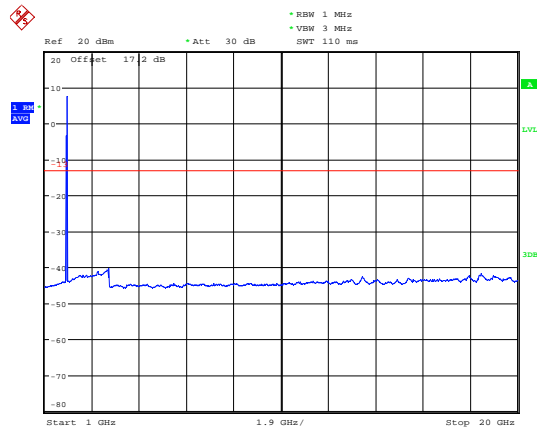

Date: 9.SEP.2019 20:42:44

LTE Band 25 1.4MHz CH-High 30MHz~1GHz

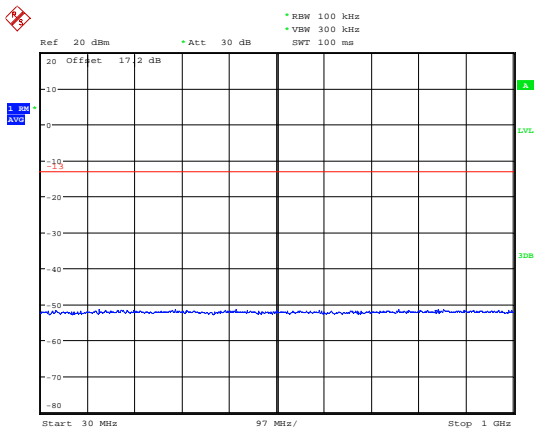

Date: 9.SEP.2019 20:22:29

LTE Band 25 1.4MHz CH-High 1GHz~20GHz

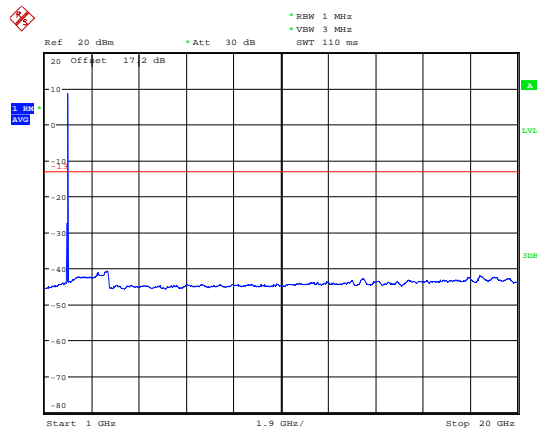

Date: 9.SEP.2019 20:43:00



LTE Band 25 3MHz CH-Low 30MHz~1GHz

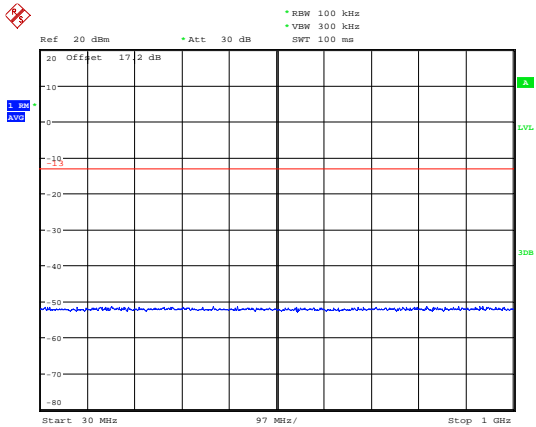

Date: 9.SEP.2019 20:22:51

LTE Band 25 3MHz CH-Low 1GHz~20GHz

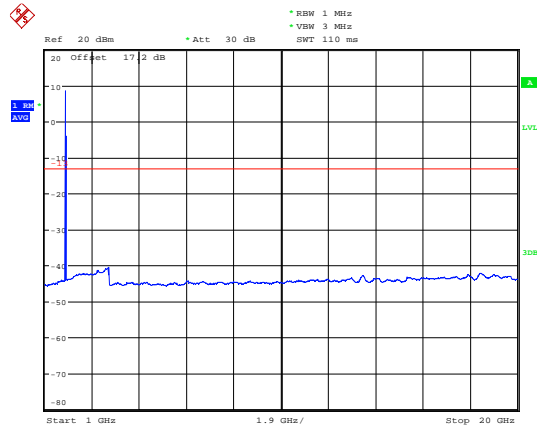

Date: 9.SEP.2019 20:43:17

LTE Band 25 3MHz CH-Middle 30MHz~1GHz

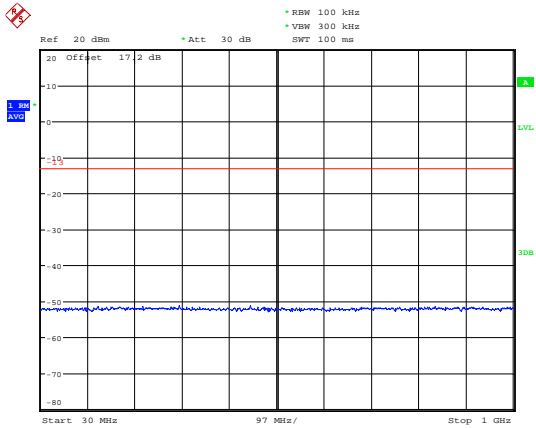

Date: 9.SEP.2019 20:23:15

LTE Band 25 3MHz CH-Middle 1GHz~20GHz

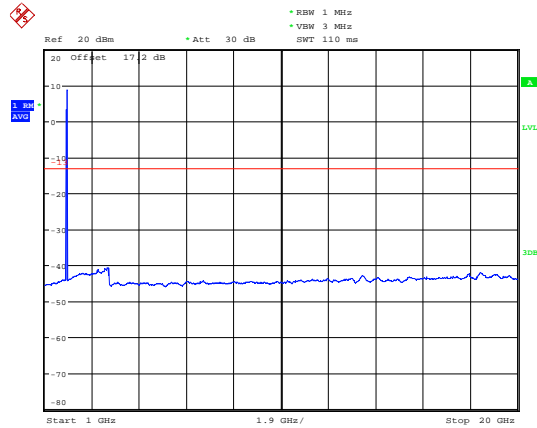

Date: 9.SEP.2019 20:43:44

LTE Band 25 3MHz CH-High 30MHz~1GHz

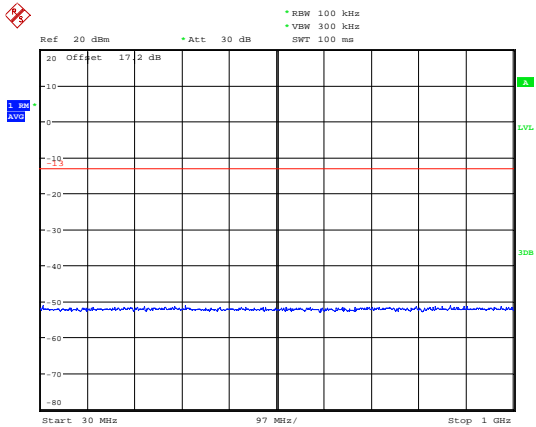

Date: 9.SEP.2019 20:23:29

LTE Band25 3MHz CH-High 1GHz~20GHz

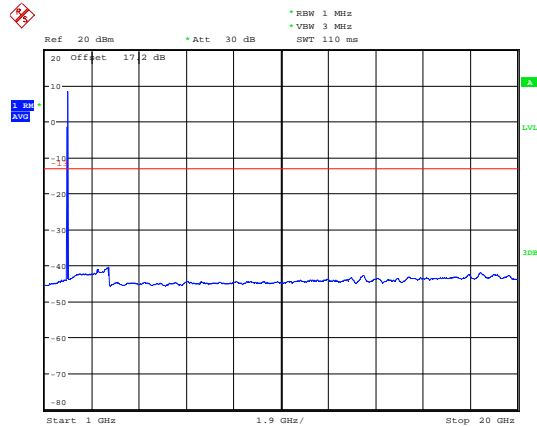

Date: 9.SEP.2019 20:43:59



LTE Band 25 5MHz CH-Low 30MHz~1GHz

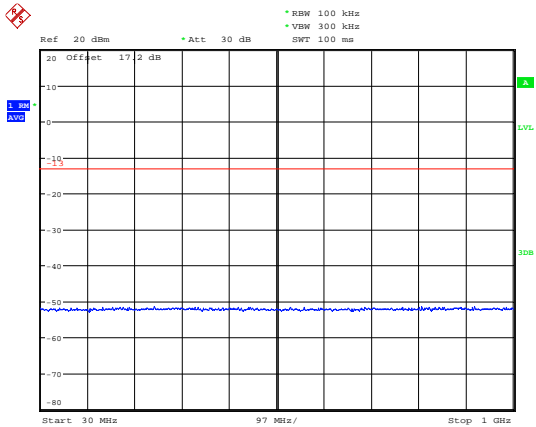

Date: 9.SEP.2019 20:24:41

LTE Band 25 5MHz CH-Low 1GHz~20GHz

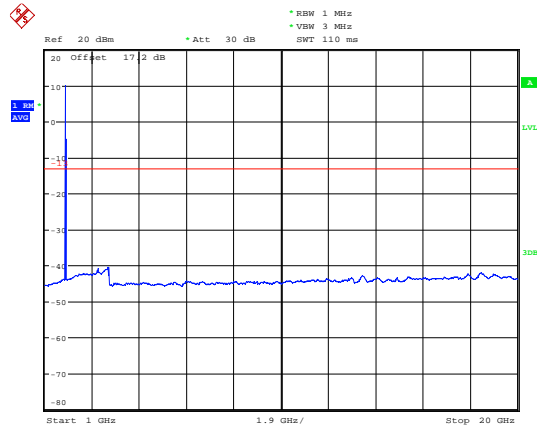

Date: 9.SEP.2019 20:44:16

LTE Band 25 5MHz CH-Middle 30MHz~1GHz

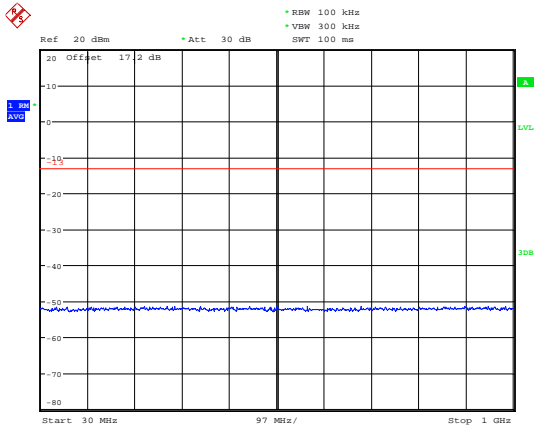

Date: 9.SEP.2019 20:24:56

LTE Band 25 5MHz CH-Middle 1GHz~20GHz

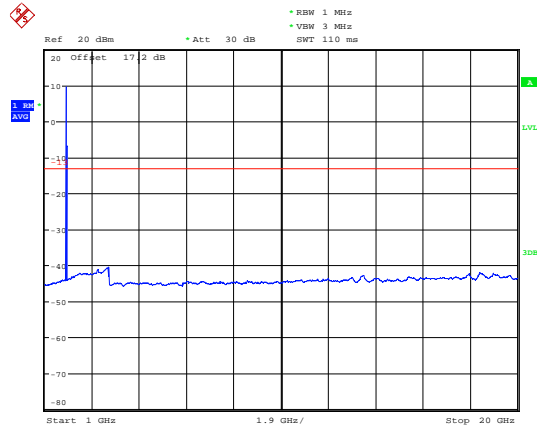

Date: 9.SEP.2019 20:44:36

LTE Band 25 5MHz CH-High 30MHz~1GHz

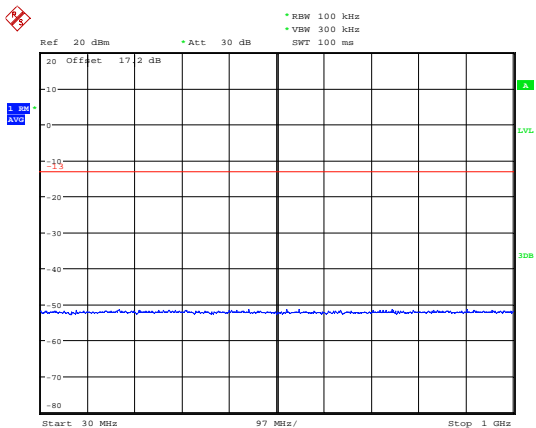

Date: 9.SEP.2019 20:25:14

LTE Band 25 5MHz CH-High 1GHz~20GHz

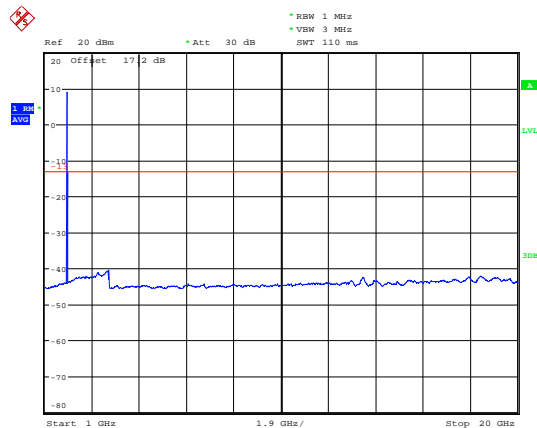

Date: 9.SEP.2019 20:44:51



LTE Band 25 10MHz CH-Low 30MHz~1GHz

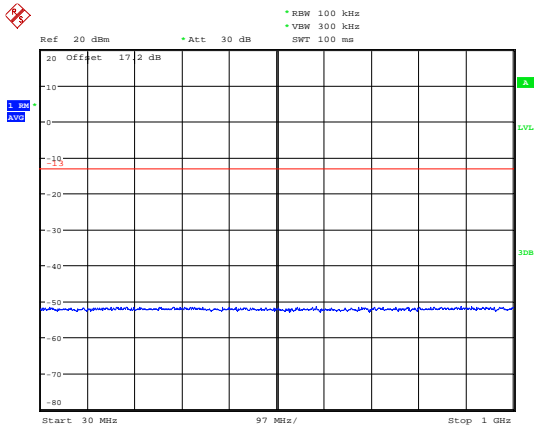

Date: 9.SEP.2019 20:26:15

LTE Band 25 10MHz CH-Low 1GHz~20GHz

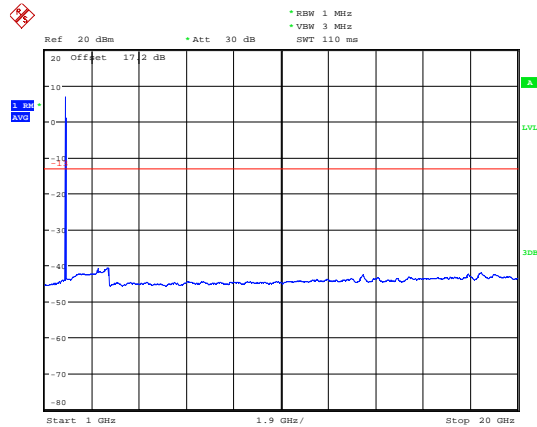

Date: 9.SEP.2019 20:45:08

LTE Band 25 10MHz CH-Middle 30MHz~1GHz

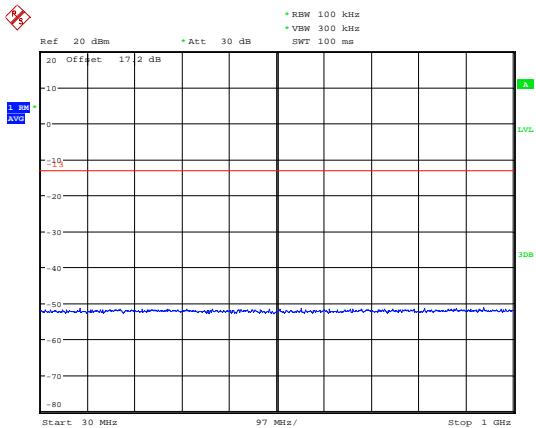

Date: 9.SEP.2019 20:26:29

LTE Band 25 10MHz CH-Middle 1GHz~20GHz

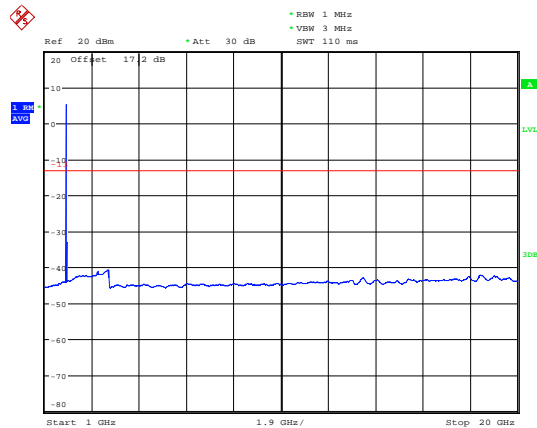

Date: 17.SEP.2019 11:38:22

LTE Band 25 10MHz CH-High 30MHz~1GHz

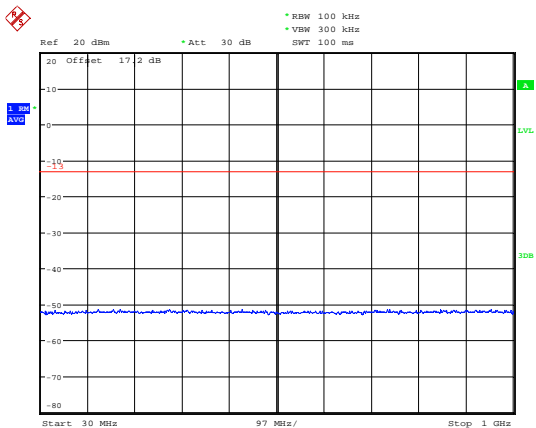

Date: 9.SEP.2019 20:26:43

LTE Band 25 10MHz CH-High 1GHz~20GHz

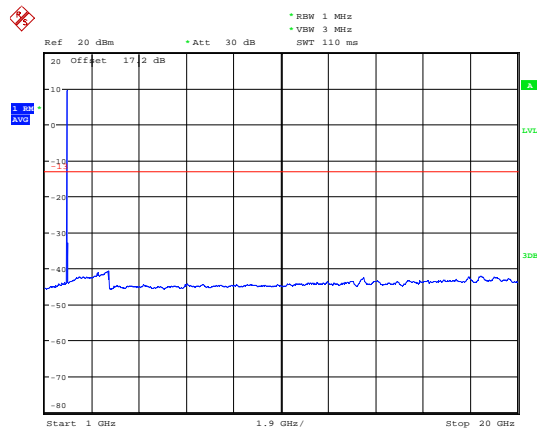

Date: 9.SEP.2019 20:45:42



LTE Band 25 15MHz CH-Low 30MHz~1GHz

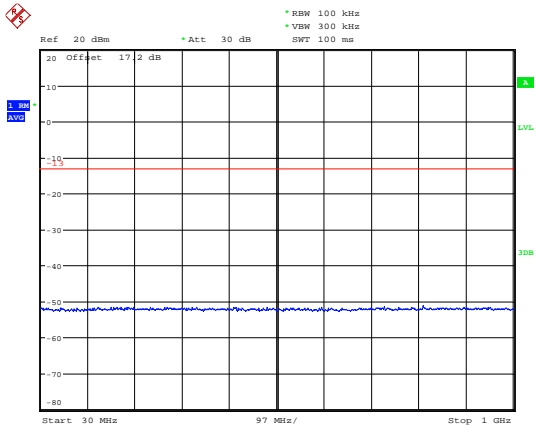

Date: 9.SEP.2019 20:27:13

LTE Band 25 15MHz CH-Low 1GHz~20GHz

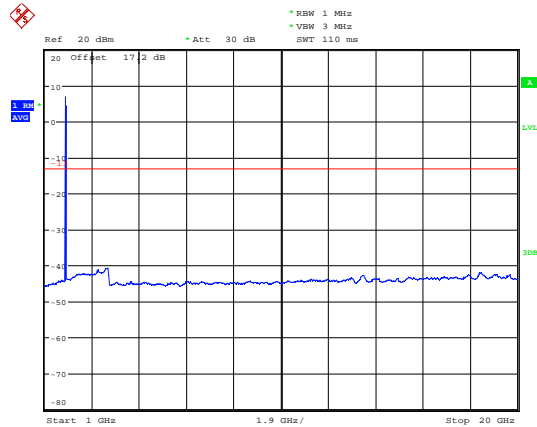

Date: 9.SEP.2019 20:46:02

LTE Band 25 15MHz CH-Middle 30MHz~1GHz

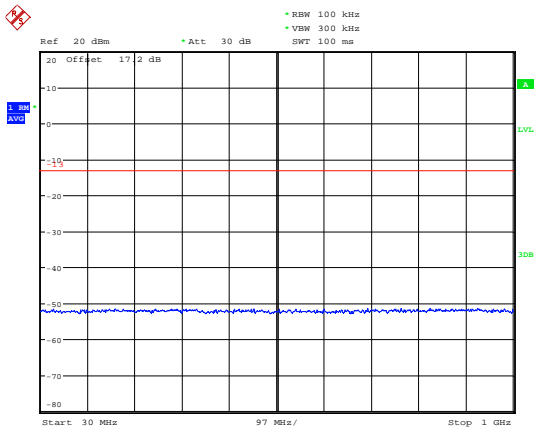

Date: 9.SEP.2019 20:27:34

LTE Band 25 15MHz CH-Middle 1GHz~20GHz

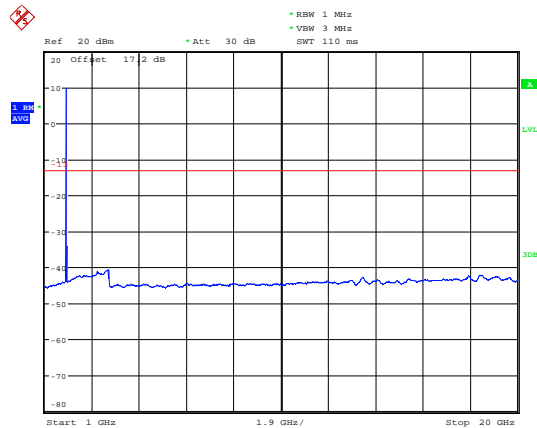

Date: 9.SEP.2019 20:46:21

LTE Band 25 15MHz CH-High 30MHz~1GHz

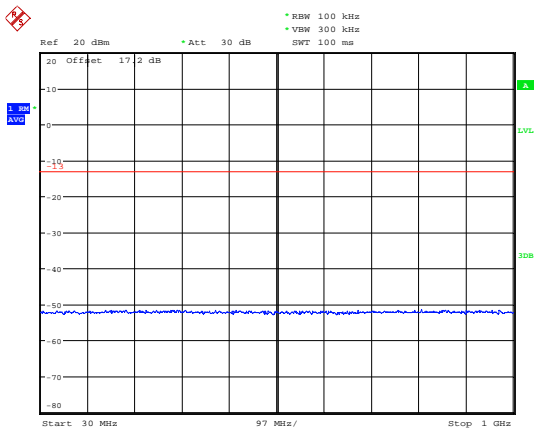

Date: 9.SEP.2019 20:27:46

LTE Band 25 15MHz CH-High 1GHz~20GHz

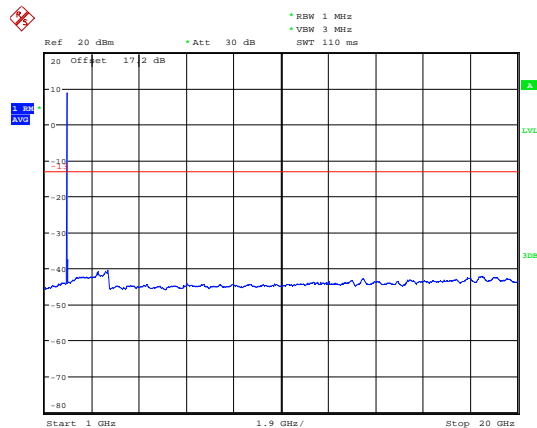

Date: 9.SEP.2019 20:46:34



LTE Band 25 20MHz CH-Low 30MHz~1GHz

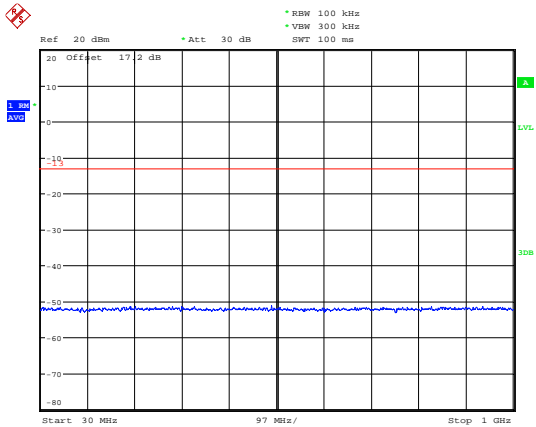

Date: 9.SEP.2019 20:28:02

LTE Band 25 20MHz CH-Low 1GHz~20GHz

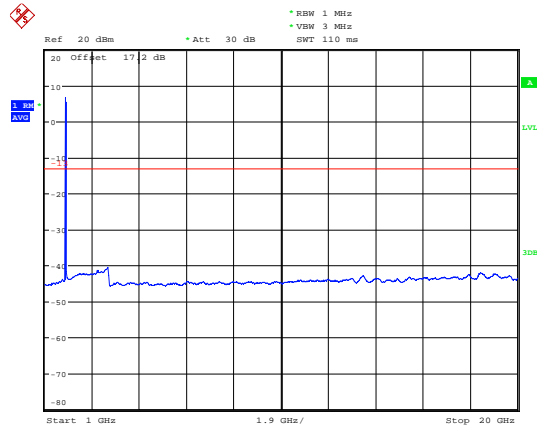

Date: 9.SEP.2019 20:46:52

LTE Band 25 20MHz CH-Middle 30MHz~1GHz

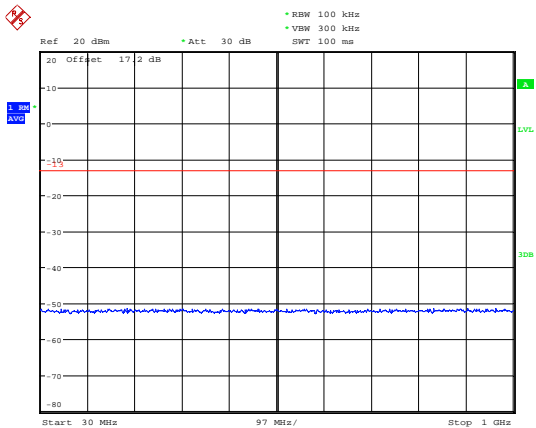

Date: 9.SEP.2019 20:28:17

LTE Band 25 20MHz CH-Middle 1GHz~20GHz

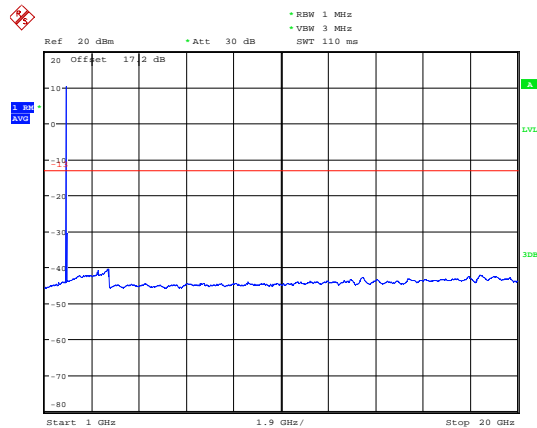

Date: 9.SEP.2019 20:47:11

LTE Band 25 20MHz CH-High 30MHz~1GHz

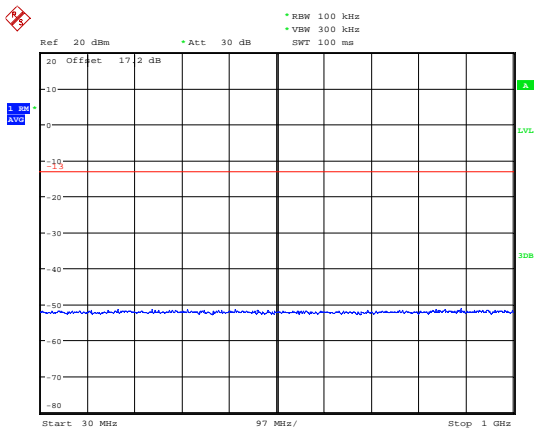

Date: 9.SEP.2019 20:28:27

LTE Band 25 20MHz CH-High 1GHz~20GHz

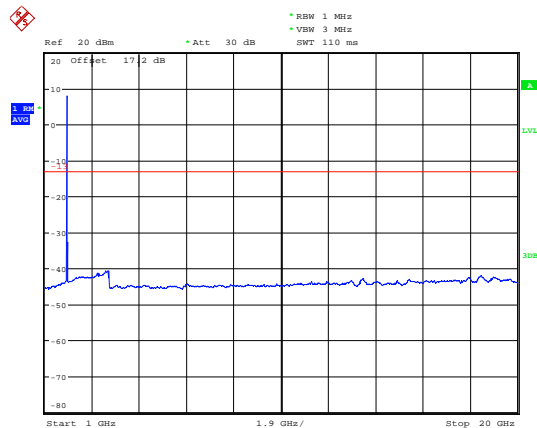

Date: 9.SEP.2019 20:47:23

6.7. Radiates Spurious Emission

Sweep the whole frequency band through the range from 9kHz to the 10th harmonic of the carrier, the emissions below the noise floor will not be recorded in the report.

GSM 1900 CH-Middle

Harmonic	Frequency (MHz)	SG (dBm)	Cable Loss (dB)	Gain (dBi)	Antenna Polarization	EIRP Level (dBm)	Limit (dBm)	Margin (dB)	Azimuth (deg)
2	3759.9	-48.35	5.10	11.05	Horizontal	-42.40	-13.00	29.40	135
3	5640.2	-56.43	5.42	12.65	Horizontal	-49.20	-13.00	36.20	45
4	7519.5	-53.75	6.70	13.85	Horizontal	-46.60	-13.00	33.60	0
5	9402.8	-53.04	7.01	14.75	Horizontal	-45.30	-13.00	32.30	90
6	11279.3	-51.57	7.48	15.95	Horizontal	-43.10	-13.00	30.10	180
7	13159.1	-50.14	7.51	16.55	Horizontal	-41.10	-13.00	28.10	225
8	15041.3	-48.71	8.24	15.35	Horizontal	-41.60	-13.00	28.60	315
9	16922.3	-43.34	8.41	14.95	Horizontal	-36.80	-13.00	23.80	135
10	18800.0	-	-	-	-	-	-	-	-

Note: 1. The other Spurious RF Radiated emissions level is no more than noise floor.
 2. The worst emission was found in the antenna is Horizontal position.



WCDMA Band II CH-Middle

Harmonic	Frequency (MHz)	SG (dBm)	Cable Loss (dB)	Gain (dBi)	Antenna Polarization	EIRP Level (dBm)	Limit (dBm)	Margin (dB)	Azimuth (deg)
2	3760.0	-57.45	5.10	11.05	Horizontal	-51.50	-13.00	38.50	45
3	5640.0	-61.37	5.42	12.65	Horizontal	-54.14	-13.00	41.14	90
4	7520.0	-58.04	6.70	13.85	Horizontal	-50.89	-13.00	37.89	0
5	9400.0	-56.42	7.01	14.75	Horizontal	-48.68	-13.00	35.68	180
6	11280.0	-54.58	7.48	15.95	Horizontal	-46.11	-13.00	33.11	225
7	13160.0	-55.24	7.51	16.55	Horizontal	-46.20	-13.00	33.20	315
8	15040.0	-52.98	8.24	15.35	Horizontal	-45.87	-13.00	32.87	270
9	16920.0	-48.95	8.41	14.95	Horizontal	-42.41	-13.00	29.41	0
10	18800.0	-	-	-	-	-	-	-	-

Note: 1. The other Spurious RF Radiated emissions level is no more than noise floor.

2. The worst emission was found in the antenna is Horizontal position.

LTE Band 2 1.4MHz CH-Middle

Harmonic	Frequency (MHz)	SG (dBm)	Cable Loss (dB)	Gain (dBi)	Antenna Polarization	EIRP Level (dBm)	Limit (dBm)	Margin (dB)	Azimuth (deg)
2	3759.0	-56.18	5.10	11.05	Horizontal	-50.23	-13.00	37.23	45
3	5638.9	-58.56	5.42	12.65	Horizontal	-51.33	-13.00	38.33	315
4	7520.0	-55.63	6.70	13.85	Horizontal	-48.48	-13.00	35.48	225
5	9400.0	-54.14	7.01	14.75	Horizontal	-46.40	-13.00	33.40	90
6	11280.0	-54.78	7.48	15.95	Horizontal	-46.31	-13.00	33.31	0
7	13160.0	-55.88	7.51	16.55	Horizontal	-46.84	-13.00	33.84	135
8	15040.0	-52.56	8.24	15.35	Horizontal	-45.45	-13.00	32.45	45
9	16920.0	-56.77	8.41	14.95	Horizontal	-50.23	-13.00	37.23	45
10	18800.0	-	-	-	-	-	-	-	-

Note: 1. The other Spurious RF Radiated emissions level is no more than noise floor.

2. The worst emission was found in the antenna is Horizontal position.

LTE Band 2 5MHz CH-Middle

Harmonic	Frequency (MHz)	SG (dBm)	Cable Loss (dB)	Gain (dBi)	Antenna Polarization	EIRP Level (dBm)	Limit (dBm)	Margin (dB)	Azimuth (deg)
2	3760.0	-53.49	5.10	11.05	Horizontal	-47.54	-13.00	34.54	225
3	5640.0	-58.17	5.42	12.65	Horizontal	-50.94	-13.00	37.94	45
4	7520.0	-59.57	6.70	13.85	Horizontal	-52.42	-13.00	39.42	315
5	9400.0	-56.49	7.01	14.75	Horizontal	-48.75	-13.00	35.75	90
6	11280.0	-55.25	7.48	15.95	Horizontal	-46.78	-13.00	33.78	45
7	13160.0	-54.08	7.51	16.55	Horizontal	-45.04	-13.00	32.04	180
8	15040.0	-53.08	8.24	15.35	Horizontal	-45.97	-13.00	32.97	45
9	16920.0	-51.11	8.41	14.95	Horizontal	-44.57	-13.00	31.57	135
10	18800.0	-	-	-	-	-	-	-	-

Note: 1.The other Spurious RF Radiated emissions level is no more than noise floor.
2. The worst emission was found in the antenna is Horizontal position.

LTE Band 2 20MHz CH-Middle

Harmonic	Frequency (MHz)	SG (dBm)	Cable Loss (dB)	Gain (dBi)	Antenna Polarization	EIRP Level (dBm)	Limit (dBm)	Margin (dB)	Azimuth (deg)
2	3760.0	-55.17	5.10	11.05	Horizontal	-49.22	-13.00	36.22	45
3	5640.0	-56.99	5.42	12.65	Horizontal	-49.76	-13.00	36.76	225
4	7520.0	-58.65	6.70	13.85	Horizontal	-51.50	-13.00	38.50	315
5	9400.0	-57.31	7.01	14.75	Horizontal	-49.57	-13.00	36.57	45
6	11280.0	-55.73	7.48	15.95	Horizontal	-47.26	-13.00	34.26	45
7	13160.0	-55.37	7.51	16.55	Horizontal	-46.33	-13.00	33.33	90
8	15040.0	-53.57	8.24	15.35	Horizontal	-46.46	-13.00	33.46	45
9	16920.0	-49.95	8.41	14.95	Horizontal	-43.41	-13.00	30.41	135
10	18800.0	-	-	-	-	-	-	-	-

Note: 1.The other Spurious RF Radiated emissions level is no more than noise floor.
2. The worst emission was found in the antenna is Horizontal position.



LTE Band 25 1.4MHz CH-Middle

Harmonic	Frequency (MHz)	SG (dBm)	Cable Loss (dB)	Gain (dBi)	Antenna Polarization	EIRP Level (dBm)	Limit (dBm)	Margin (dB)	Azimuth (deg)
2	3759.0	-55.72	5.10	11.05	Horizontal	-49.77	-13.00	36.77	135
3	5638.9	-57.25	5.42	12.65	Horizontal	-50.02	-13.00	37.02	45
4	7520.0	-59.36	6.70	13.85	Horizontal	-52.21	-13.00	39.21	90
5	9400.0	-57.05	7.01	14.75	Horizontal	-49.31	-13.00	36.31	225
6	11280.0	-54.94	7.48	15.95	Horizontal	-46.47	-13.00	33.47	135
7	13160.0	-54.85	7.51	16.55	Horizontal	-45.81	-13.00	32.81	315
8	15040.0	-52.86	8.24	15.35	Horizontal	-45.75	-13.00	32.75	225
9	16920.0	-51.45	8.41	14.95	Horizontal	-44.91	-13.00	31.91	180
10	18800.0	-	-	-	-	-	-	-	-

Note: 1.The other Spurious RF Radiated emissions level is no more than noise floor.

2. The worst emission was found in the antenna is Horizontal position.

LTE Band 25 5MHz CH-Middle

Harmonic	Frequency (MHz)	SG (dBm)	Cable Loss (dB)	Gain (dBi)	Antenna Polarization	EIRP Level (dBm)	Limit (dBm)	Margin (dB)	Azimuth (deg)
2	3760.0	-55.68	5.10	11.05	Horizontal	-49.73	-13.00	36.73	45
3	5640.0	-57.65	5.42	12.65	Horizontal	-50.42	-13.00	37.42	225
4	7520.0	-58.60	6.70	13.85	Horizontal	-51.45	-13.00	38.45	135
5	9400.0	-58.33	7.01	14.75	Horizontal	-50.59	-13.00	37.59	90
6	11280.0	-56.21	7.48	15.95	Horizontal	-47.74	-13.00	34.74	225
7	13160.0	-55.65	7.51	16.55	Horizontal	-46.61	-13.00	33.61	135
8	15040.0	-53.66	8.24	15.35	Horizontal	-46.55	-13.00	33.55	45
9	16920.0	-51.27	8.41	14.95	Horizontal	-44.73	-13.00	31.73	90
10	18800.0	-	-	-	-	-	-	-	-

Note: 1.The other Spurious RF Radiated emissions level is no more than noise floor.

2. The worst emission was found in the antenna is Horizontal position.



LTE Band 25 20MHz CH-Middle

Harmonic	Frequency (MHz)	SG (dBm)	Cable Loss (dB)	Gain (dBi)	Antenna Polarization	EIRP Level (dBm)	Limit (dBm)	Margin (dB)	Azimuth (deg)
2	3760.0	-56.54	5.10	11.05	Horizontal	-50.59	-13.00	37.59	0
3	5640.0	-58.38	5.42	12.65	Horizontal	-51.15	-13.00	38.15	180
4	7520.0	-59.50	6.70	13.85	Horizontal	-52.35	-13.00	39.35	135
5	9400.0	-57.05	7.01	14.75	Horizontal	-49.31	-13.00	36.31	45
6	11280.0	-56.43	7.48	15.95	Horizontal	-47.96	-13.00	34.96	225
7	13160.0	-56.33	7.51	16.55	Horizontal	-47.29	-13.00	34.29	315
8	15040.0	-53.07	8.24	15.35	Horizontal	-45.96	-13.00	32.96	45
9	16920.0	-51.39	8.41	14.95	Horizontal	-44.85	-13.00	31.85	90
10	18800.0	-	-	-	-	-	-	-	-

Note: 1. The other Spurious RF Radiated emissions level is no more than noise floor.

2. The worst emission was found in the antenna is Horizontal position.



7. Main Test Instruments

Name	Manufacturer	Type	Serial Number	Calibration Date	Expiration Date
Base Station Simulator	R&S	CMU200	118133	2019-05-19	2020-05-18
Base Station Simulator	R&S	CMW500	113824	2019-05-19	2020-05-18
Power Splitter	Hua Xiang	SHX-GF2-2-13	10120101	/	/
Spectrum Analyzer	Key sight	N9010A	MY50210259	2019-05-19	2020-05-18
Universal Radio Communication Tester	Key sight	E5515C	MY48367192	2019-05-19	2020-05-18
Signal Analyzer	R&S	FSV30	100815	2018-12-16	2019-12-15
Loop Antenna	SCHWARZBECK	FMZB1519	1519-047	2017-09-26	2019-09-25
Trilog Antenna	SCHWARZBECK	VUBL 9163	9163-201	2017-11-18	2019-11-17
Horn Antenna	R&S	HF907	100126	2018-07-07	2020-07-06
Horn Antenna	ETS-Lindgren	3160-09	00102643	2018-06-20	2020-06-19
Signal generator	R&S	SMB 100A	102594	2019-05-19	2020-05-18
Climatic Chamber	ESPEC	SU-242	93000506	2017-12-17	2020-12-16
Preamplifier	R&S	SCU18	102327	2019-05-19	2020-05-18
MOB COMMS DC SUPPLY	Keysight	66319D	MY43004105	2019-05-19	2020-05-18
RF Cable	Agilent	SMA 15cm	0001	2019-06-14	2019-09-13
Software	R&S	EMC32	9.26.0	/	/

*****END OF REPORT *****



ANNEX A: The EUT Appearance

The EUT Appearance is submitted separately.



ANNEX B: Test Setup Photos

The Test Setup Photos is submitted separately.



ANNEX C: Product Change Description

The Product Change Description are submitted separately.