



FCC RF Test Report

APPLICANT : MeiG Smart Technology Co., Ltd
EQUIPMENT : module
BRAND NAME : MEIGLink
MODEL NAME : SLM750
FCC ID : 2APJ4-SLM750
STANDARD : 47 CFR Part 2, 22(H), 24(E), 27(L), 27(F), 27(M), 27(H)
CLASSIFICATION : PCS Licensed Transmitter (PCB)

The product was received on Mar. 29, 2018 and completely tested on Apr. 20, 2018. We, Sporton International (Shenzhen) Inc., would like to declare that the tested sample has been evaluated in accordance with the procedures given in ANSI C63.26-2015 and shown compliance with the applicable technical standards.

The test results in this report apply exclusively to the tested model / sample. Without written approval of Sporton International (Shenzhen) Inc., the test report shall not be reproduced except in full.



Approved by: Eric Shih / Manager

Sporton International (Shenzhen) Inc.

**1/F, 2/F, Bldg 5, Shiling Industrial Zone, Xinwei Village, Xili, Nanshan Shenzhen City
Guangdong Province 518055 China**



TABLE OF CONTENTS

REVISION HISTORY..... 3
SUMMARY OF TEST RESULT 4
1 GENERAL DESCRIPTION 6
1.1 Applicant 6
1.2 Manufacturer 6
1.3 Product Feature of Equipment Under Test..... 6
1.4 Product Specification of Equipment Under Test..... 7
1.5 Modification of EUT 8
1.6 Maximum ERP/EIRP Power, Frequency Tolerance, and Emission Designator 8
1.7 Testing Location 11
1.8 Applicable Standards..... 11
2 TEST CONFIGURATION OF EQUIPMENT UNDER TEST 12
2.1 Test Mode 12
2.2 Connection Diagram of Test System 16
2.3 Support Unit used in test configuration and system 16
2.4 Measurement Results Explanation Example 16
2.5 Frequency List of Low/Middle/High Channels 17
3 CONDUCTED TEST ITEMS 21
3.1 Measuring Instruments 21
3.2 Test Setup 21
3.3 Test Result of Conducted Test 21
3.4 Conducted Output Power and ERP/EIRP 22
3.5 Peak-to-Average Ratio 23
3.6 Occupied Bandwidth 24
3.7 Conducted Band Edge 25
3.8 Conducted Spurious Emission 27
3.9 Frequency Stability 28
4 RADIATED TEST ITEMS 29
4.1 Measuring Instruments 29
4.2 Test Setup 29
4.3 Test Result of Radiated Test 29
4.4 Radiated Spurious Emission 30
5 LIST OF MEASURING EQUIPMENT 31
6 UNCERTAINTY OF EVALUATION 32
APPENDIX A. TEST RESULTS OF CONDUCTED TEST
APPENDIX B. TEST RESULTS OF RADIATED TEST
APPENDIX C. TEST SETUP PHOTOGRAPHS



SUMMARY OF TEST RESULT

Report Section	FCC Rule	Description	Limit	Result	Remark
3.4	§2.1046	Conducted Output Power	Reporting Only	PASS	-
	§22.913(a)(5)	Effective Radiated Power (Band 5) (Band 26)	ERP < 7 Watt	PASS	-
	§27.50(b)(10) §27.50(c)(10)	Effective Radiated Power (Band 12) (Band 13) (Band 17)	ERP < 3 Watt	PASS	-
	§24.232(c) §27.50(h)(2)	Equivalent Isotropic Radiated Power (Band 2) (Band 25) (Band 41)	EIRP < 2Watt	PASS	-
	§27.50(d)(4)	Equivalent Isotropic Radiated Power (Band 4)	EIRP < 1Watt	PASS	-
3.5	§24.232(d)	Peak-to-Average Ratio	<13 dB	PASS	-
3.6	§2.1049	Occupied Bandwidth	Reporting Only	PASS	-
3.7	§2.1051 §22.917(a) §24.238(a) §27.53(c)(2)(4) §27.53(g) §27.53(h)	Conducted Band Edge Measurement (Band 2) (Band 4) (Band 5) (Band 12) (Band 13) (Band 17) (Band 25) (Band 26)	< 43+10log ₁₀ (P[Watts])	PASS	-
	§27.53(m)(4)	Conducted Band Edge Measurement (Band 41)	§27.53(m)(4)		
3.8	§2.1051 §22.917(a) §24.238(a) §27.53(c)(2) §27.53(g) §27.53(h)	Conducted Spurious Emission (Band 2) (Band 4) (Band 5) (Band 12) (Band 13) (Band 17) (Band 25) (Band 26)	< 43+10log ₁₀ (P[Watts])	PASS	-
	§2.1051 §27.53(m)(4)	Conducted Spurious Emission (Band 41)	< 55+10log ₁₀ (P[Watts])		
3.9	§2.1055 §22.355	Frequency Stability Temperature & Voltage	< 2.5 ppm for Part 22H	PASS	-
	§2.1055 §24.235 §27.54		Within Authorized Band		



4.4	§2.1053 §22.917(a) §24.238(a) §27.53(c)(2) §27.53(f) §27.53(g) §27.53(h)	Radiated Spurious Emission (Band 2) (Band 4) (Band 5) (Band 12) (Band 13) (Band 17) (Band 25) (Band 26)	$< 43+10\log_{10}(P[\text{Watts}])$	PASS	Under limit 23.77 dB at 7846.500 MHz
	§2.1053 §27.53(m)(4)	Radiated Spurious Emission (Band 41)	$< 55+10\log_{10}(P[\text{Watts}])$		



1 General Description

1.1 Applicant

MeiG Smart Technology Co., Ltd

Floor 9, building 1, Digital China Xi'an Science Park, no. 20, Zhangbasi Road, Gaoxin District, xi 'an

1.2 Manufacturer

MeiG Smart Technology Co., Ltd

Floor 9, building 1, Digital China Xi'an Science Park, no. 20, Zhangbasi Road, Gaoxin District, xi 'an

1.3 Product Feature of Equipment Under Test

Product Feature	
Equipment	module
Brand Name	MEIGLink
Model Name	SLM750
FCC ID	2APJ4-SLM750
EUT supports Radios application	CDMA/EV-DO/GSM/GPRS/EGPRS/WCDMA/HSPA/HSPA+(16QAM uplink is not supported)/DC-HSDPA/LTE
HW Version	SLM750-T_MB_V1.02
SW Version	SLM750-TA_EQ102_00B.B8E980.B8A1B0_171218_202_C00_V02.B
EUT Stage	Identical Prototype



1.4 Product Specification of Equipment Under Test

Standards-related Product Specification	
Tx Frequency	LTE Band 2 : 1850.7 MHz ~ 1909.3 MHz LTE Band 4 : 1710.7 MHz ~ 1754.3 MHz LTE Band 5 : 824.7 MHz ~ 848.3 MHz LTE Band 12 : 699.7 MHz ~ 715.3 MHz LTE Band 13 : 779.5 MHz ~ 784.5 MHz LTE Band 17 : 706.5 MHz ~ 713.5 MHz LTE Band 25 : 1850.7MHz ~ 1914.3 MHz LTE Band 26 : 824.7MHz ~ 848.3 MHz LTE Band 41 : 2557.5 MHz ~ 2652.5 MHz
Rx Frequency	LTE Band 2 : 1930.7 MHz ~ 1989.3 MHz LTE Band 4 : 2110.7 MHz ~ 2154.3 MHz LTE Band 5 : 869.7 MHz ~ 893.3 MHz LTE Band 12 : 729.7 MHz ~ 745.3 MHz LTE Band 13 : 748.5 MHz ~ 753.5 MHz LTE Band 17 : 736.5 MHz ~ 743.5 MHz LTE Band 25 : 1930.7MHz ~ 1994.3 MHz LTE Band 26 : 869.7MHz ~ 893.3MHz LTE Band 41 : 2557.5 MHz ~ 2652.5 MHz
Bandwidth	LTE Band 2 : 1.4MHz / 3MHz / 5MHz / 10MHz / 15MHz / 20MHz LTE Band 4 : 1.4MHz / 3MHz / 5MHz / 10MHz / 15MHz / 20MHz LTE Band 5 : 1.4MHz / 3MHz / 5MHz / 10MHz LTE Band 12 : 1.4MHz / 3MHz / 5MHz / 10MHz LTE Band 13 : 5MHz / 10MHz LTE Band 17 : 5MHz / 10MHz LTE Band 25 : 1.4MHz / 3MHz / 5MHz / 10MHz / 15MHz / 20MHz LTE Band 26 : 1.4MHz / 3MHz / 5MHz / 10MHz / 15MHz LTE Band 41 : 5MHz / 10MHz / 15MHz / 20MHz
Antenna Type	Dipole Antenna
Maximum Output Power to Antenna	LTE Band 2 : 22.09 dBm LTE Band 4 : 22.12 dBm LTE Band 5 : 22.42 dBm LTE Band 12 : 22.35 dBm LTE Band 13 : 22.51 dBm LTE Band 17 : 22.50 dBm LTE Band 25 : 22.37 dBm LTE Band 26 : 22.35 dBm LTE Band 41 : 22.88 dBm
Antenna Gain	LTE Band 2 : 3.0 dBi LTE Band 4 : 3.0 dBi LTE Band 5 : 3.0 dBi LTE Band 12 : 3.0 dBi LTE Band 13 : 3.0 dBi LTE Band 17 : 3.0 dBi LTE Band 25 : 3.0 dBi LTE Band 26 : 3.0 dBi LTE Band 41 : 3.0 dBi
Type of Modulation	QPSK / 16QAM



1.5 Modification of EUT

No modifications are made to the EUT during all test items.

1.6 Maximum ERP/EIRP Power, Frequency Tolerance, and Emission Designator

LTE Band 2		QPSK			16QAM		
BW (MHz)	Frequency Range (MHz)	Emission Designator (99%OBW)	Frequency Tolerance (ppm)	Maximum EIRP(W)	Emission Designator (99%OBW)	Frequency Tolerance (ppm)	Maximum EIRP(W)
1.4	1850.7 ~ 1909.3	1M10G7D	-	0.3177	1M09W7D	-	0.2472
3	1851.5 ~ 1908.5	2M72G7D	-	0.2924	2M72W7D	-	0.2254
5	1852.5 ~ 1907.5	4M51G7D	-	0.3206	4M51W7D	-	0.2636
10	1855.0 ~ 1905.0	9M05G7D	0.0071	0.3083	9M03W7D	-	0.2460
15	1857.5 ~ 1902.5	13M5G7D	-	0.3214	13M4W7D	-	0.2388
20	1860.0 ~ 1900.0	18M3G7D	-	0.3228	18M3W7D	-	0.2296
LTE Band 25		QPSK			16QAM		
BW (MHz)	Frequency Range (MHz)	Emission Designator (99%OBW)	Frequency Tolerance (ppm)	Maximum EIRP(W)	Emission Designator (99%OBW)	Frequency Tolerance (ppm)	Maximum EIRP(W)
1.4	1850.7 ~ 1914.3	1M10G7D	-	0.3365	1M10W7D	-	0.2698
3	1851.5 ~ 1913.5	2M72G7D	-	0.3199	2M74W7D	-	0.2449
5	1852.5 ~ 1912.5	4M51G7D	-	0.3436	4M52W7D	-	0.2377
10	1855.0 ~ 1910.0	9M03G7D	0.0007	0.3236	9M07W7D	-	0.2483
15	1857.5 ~ 1907.5	13M4G7D	-	0.3097	13M5W7D	-	0.2399
20	1860.0 ~ 1905.0	18M5G7D	-	0.3443	18M4W7D	-	0.2421
LTE Band 4		QPSK			16QAM		
BW (MHz)	Frequency Range (MHz)	Emission Designator (99%OBW)	Frequency Tolerance (ppm)	Maximum EIRP(W)	Emission Designator (99%OBW)	Frequency Tolerance (ppm)	Maximum EIRP(W)
1.4	1710.7 ~ 1754.3	1M09G7D	-	0.3243	1M10W7D	-	0.2564
3	1711.5 ~ 1753.5	2M72G7D	-	0.3141	2M73W7D	-	0.2576
5	1712.5 ~ 1752.5	4M50G7D	-	0.3133	4M50W7D	-	0.2606
10	1715.0 ~ 1750.0	9M05G7D	0.0027	0.3105	9M01W7D	-	0.2355
15	1717.5 ~ 1747.5	13M5G7D	-	0.3162	13M4W7D	-	0.2350
20	1720.0 ~ 1745.0	18M3G7D	-	0.3251	18M4W7D	-	0.2333



LTE Band 5		QPSK			16QAM		
BW (MHz)	Frequency Range (MHz)	Emission Designator (99%OBW)	Frequency Tolerance (ppm)	Maximum ERP(W)	Emission Designator (99%OBW)	Frequency Tolerance (ppm)	Maximum ERP(W)
1.4	824.7 ~ 848.3	1M09G7D	-	0.2118	1M10W7D	-	0.1660
3	825.5 ~ 847.5	2M73G7D	-	0.2032	2M73W7D	-	0.1510
5	826.5 ~ 846.5	4M50G7D	-	0.1991	4M49W7D	-	0.1489
10	829.0 ~ 844.0	9M03G7D	0.0016	0.2123	9M01W7D	-	0.1472
LTE Band 12		QPSK			16QAM		
BW (MHz)	Frequency Range (MHz)	Emission Designator (99%OBW)	Frequency Tolerance (ppm)	Maximum ERP(W)	Emission Designator (99%OBW)	Frequency Tolerance (ppm)	Maximum ERP(W)
1.4	699.7 ~ 715.3	1M10G7D	-	0.2075	1M10W7D	-	0.1637
3	700.5 ~ 714.5	2M72G7D	-	0.1963	2M73W7D	-	0.1514
5	701.5 ~ 713.5	4M52G7D	-	0.1968	4M49W7D	-	0.1496
10	704.0 ~ 711.0	8M99G7D	0.0017	0.2089	9M03W7D	-	0.1545
LTE Band 13		QPSK			16QAM		
BW (MHz)	Frequency Range (MHz)	Emission Designator (99%OBW)	Frequency Tolerance (ppm)	Maximum ERP(W)	Emission Designator (99%OBW)	Frequency Tolerance (ppm)	Maximum ERP(W)
5	779.5 ~ 784.5	4M51G7D	-	0.2128	4M52W7D	-	0.1706
10	782.0	9M07G7D	0.0019	0.2168	9M03W7D	-	0.1633
LTE Band 17		QPSK			16QAM		
BW (MHz)	Frequency Range (MHz)	Emission Designator (99%OBW)	Frequency Tolerance (ppm)	Maximum ERP(W)	Emission Designator (99%OBW)	Frequency Tolerance (ppm)	Maximum ERP(W)
5	706.5 ~ 713.5	4M50G7D	-	0.2089	4M52W7D	-	0.1718
10	709.0 ~ 711.0	9M07G7D	0.0021	0.2163	9M05W7D	-	0.1667
LTE Band 26		QPSK			16QAM		
BW (MHz)	Frequency Range (MHz)	Emission Designator (99%OBW)	Frequency Tolerance (ppm)	Maximum EIRP(W)	Emission Designator (99%OBW)	Frequency Tolerance (ppm)	Maximum EIRP(W)
1.4	824.7 ~ 848.3	1M10G7D	-	0.1982	1M10W7D	-	0.1489
3	825.5 ~ 847.5	2M72G7D	-	0.1950	2M72W7D	-	0.1416
5	826.5 ~ 846.5	4M50G7D	-	0.2028	4M49W7D	-	0.1570
10	829.0 ~ 844.0	9M09G7D	0.0024	0.2037	9M01W7D	-	0.1507
15	831.5 ~ 841.5	13M5G7D	-	0.2089	13M5W7D	-	0.1500
CH26765	821.5	13M3G7D	-	0.2084	13M3W7D	-	0.1500



LTE Band 41		QPSK			16QAM		
BW (MHz)	Frequency Range (MHz)	Emission Designator (99%OBW)	Frequency Tolerance (ppm)	Maximum EIRP(W)	Emission Designator (99%OBW)	Frequency Tolerance (ppm)	Maximum EIRP(W)
5	2557.5 ~ 2652.5	4M48G7D		0.3846	4M52W7D		0.2999
10	2560.0 ~ 2650.0	9M05G7D	0.0054	0.3864	9M01W7D		0.2958
15	2562.5 ~ 2647.5	13M4G7D		0.3864	13M5W7D		0.2825
20	2565.0 ~ 2645.0	18M4G7D		0.3873	18M4W7D		0.2897



1.7 Testing Location

Sporton International (Shenzhen) Inc. is accredited to ISO 17025 by National Voluntary Laboratory Accreditation Program (NVLAP code: 600156-0) and the FCC designation No. are CN5018 and CN5019.

Test Site	Sporton International (Shenzhen) Inc.	
Test Site Location	1/F, 2/F, Bldg 5, Shiling Industrial Zone, Xinwei Village, Xili, Nanshan Shenzhen City Guangdong Province 518055 China TEL: +86-755-8637-9589 FAX: +86-755-8637-9595	
Test Site No.	Sporton Site No.	FCC Test Firm Registration No.
	TH01-SZ	251365

Test Site	Sporton International (Shenzhen) Inc.	
Test Site Location	No. 3 Bldg the third floor of south, Shahe River west, Fengzeyuan Warehouse, Nanshan District Shenzhen City Guangdong Province 518055 China TEL: +86-755-3320-2398	
Test Site No.	Sporton Site No.	FCC Test Firm Registration No.
	03CH01-SZ	577730

Note: The test site complies with ANSI C63.4 2014 requirement.

1.8 Applicable Standards

According to the specifications of the manufacturer, the EUT must comply with the requirements of the following standards:

- ♦ 47 CFR Part 2, 22(H), 24(E), 27(L), 27(F), 27(M), 27(H)
- ♦ ANSI C63.26-2015
- ♦ FCC KDB 971168 D01 Power Meas License Digital Systems v03r01
- ♦ FCC KDB 412172 D01 Determining ERP and EIRP v01r01

Remark:

1. All test items were verified and recorded according to the standards and without any deviation during the test.
2. This EUT has also been tested and complied with the requirements of FCC Part 15, Subpart B, recorded in a separate test report.



2 Test Configuration of Equipment Under Test

2.1 Test Mode

Antenna port conducted and radiated test items listed below are performed according to KDB 971168 D01 Power Meas License Digital Systems v03r01 with maximum output power.

Radiated measurements are performed by rotating the EUT in three different orthogonal test planes to find the maximum emission.

Test Items	Band	Bandwidth (MHz)						Modulation			RB #			Test Channel		
		1.4	3	5	10	15	20	QPSK	16QAM	64QAM	1	Half	Full	L	M	H
Max. Output Power	2	v	v	v	v	v	v	v	v	-	v	v	v	v	v	v
	4	v	v	v	v	v	v	v	v	-	v	v	v	v	v	v
	5	v	v	v	v	-	-	v	v	-	v	v	v	v	v	v
	12	v	v	v	v	-	-	v	v	-	v	v	v	v	v	v
	13	-	-	v		-	-	v	v	-	v	v	v	v	v	v
					v			v	v	-	v	v	v		v	
	17	-	-	v	v	-	-	v	v	-	v	v	v	v	v	v
	25	v	v	v	v	v	v	v	v	-	v	v	v	v	v	v
	26	v	v	v	v	v	-	v	v	-	v	v	v	v	v	v
41	-	-	v	v	v	v	v	v	-	v	v	v	v	v	v	
Peak-to-Average Ratio	2						v	v	v	-	v		v	v	v	v
	4						v	v	v	-	v		v	v	v	v
	5				v	-	-	v	v	-	v		v	v	v	v
	12				v	-	-	v	v	-	v		v	v	v	v
	13	-	-		v	-	-	v	v	-	v		v	-	v	-
	17	-	-		v	-	-	v	v	-	v		v	v	v	v
	25						v	v	v	-	v		v	v	v	v
	26				v		-	v	v	-	v		v	v	v	v
	41	-	-				v	v	v	-	v		v	v	v	v



Test Items	Band	Bandwidth (MHz)						Modulation			RB #			Test Channel		
		1.4	3	5	10	15	20	QPSK	16QAM	64QAM	1	Half	Full	L	M	H
26dB and 99% Bandwidth	2	v	v	v	v	v	v	v	v	-			v	v	v	v
	4	v	v	v	v	v	v	v	v	-			v	v	v	v
	5	v	v	v	v	-	-	v	v	-			v	v	v	v
	12	v	v	v	v	-	-	v	v	-			v	v	v	v
	13	-	-	v		-	-	v	v	-			v	v	v	v
					v	-	-	v	v	-			v		v	
	17	-	-	v	v	-	-	v	v	-			v	v	v	v
	25	v	v	v	v	v	v	v	v	-			v	v	v	v
	26	v	v	v	v	v	-	v	v	-			v	v	v	v
41	-	-	v	v	v	v	v	v	-			v	v	v	v	
Conducted Band Edge	2	v	v	v	v	v	v	v	v	-	v		v	v		v
	4	v	v	v	v	v	v	v	v	-	v		v	v		v
	5	v	v	v	v	-	-	v	v	-	v		v	v		v
	12	v	v	v	v	-	-	v	v	-	v		v	v		v
	13	-	-	v		-	-	v	v	-	v		v	v		v
					v			v	v	-	v		v		v	
	17	-	-	v	v	-	-	v	v	-	v		v	v		v
	25	v	v	v	v	v	v	v	v	-	v		v	v		v
	26	v	v	v	v	v	-	v	v	-	v		v	v		v
41	-	-	v	v	v	v	v	v	-	v		v	v		v	



Test Items	Band	Bandwidth (MHz)						Modulation			RB #			Test Channel		
		1.4	3	5	10	15	20	QPSK	16QAM	64QAM	1	Half	Full	L	M	H
Conducted Spurious Emission	2	v	v	v	v	v	v	v	v	-	v			v	v	v
	4	v	v	v	v	v	v	v	v	-	v			v	v	v
	5	v	v	v	v	-	-	v	v	-	v			v	v	v
	12	v	v	v	v	-	-	v	v	-	v			v	v	v
	13	-	-	v		-	-	v	v	-	v			v	v	v
					v			v	v	-	v				v	
	17	-	-	v	v	-	-	v	v	-	v			v	v	v
	25	v	v	v	v	v	v	v	v	-	v			v	v	v
	26	v	v	v	v	v	-	v	v	-	v			v	v	v
41	-	-	v	v	v	v	v	v	-	v			v	v	v	
Frequency Stability	2				v			v		-			v		v	
	4				v			v		-			v		v	
	5				v	-	-	v		-			v		v	
	12				v	-	-	v		-			v		v	
	13	-	-		v	-	-	v		-			v		v	
	17	-	-		v	-	-	v		-			v		v	
	25				v			v		-			v		v	
	26				v		-	v		-			v		v	
	41	-	-		v			v		-			v		v	



Test Items	Band	Bandwidth (MHz)						Modulation			RB #			Test Channel		
		1.4	3	5	10	15	20	QPSK	16QAM	64QAM	1	Half	Full	L	M	H
E.R.P / E.I.R.P	2	v	v	v	v	v	v	v	v	-	v			v	v	v
	4	v	v	v	v	v	v	v	v	-	v			v	v	v
	5	v	v	v	v	-	-	v	v	-	v			v	v	v
	12	v	v	v	v	-	-	v	v	-	v			v	v	v
	13	-	-	v		-	-	v	v	-	v			v	v	v
					v			v	v	-	v				v	
	17	-	-	v	v	-	-	v	v	-	v			v	v	v
	25	v	v	v	v	v	v	v	v	-	v			v	v	v
	26	v	v	v	v	v	-	v	v	-	v			v	v	v
41	-	-	v	v	v	v	v	v	-	v			v	v	v	
Radiated Spurious Emission	2	v	v	v	v	v	v	v	v	-	v				v	
	4	v	v	v	v	v	v	v	v	-	v				v	
	5	v	v	v	v	-	-	v	v	-	v				v	
	12	v	v	v	v	-	-	v	v	-	v				v	
	13	-	-	v	v	-	-	v	v	-	v				v	
	17	-	-	v	v	-	-	v	v	-	v				v	
	25	v	v	v	v	v	v	v	v	-	v				v	
	26	v	v	v	v	v	-	v	v	-	v				v	
	41	-	-	v	v	v	v	v	v	-	v				v	
Note	<ol style="list-style-type: none"> The mark "v " means that this configuration is chosen for testing The mark "- " means that this bandwidth is not supported. The device is investigated from 30MHz to 10 times of fundamental signal for radiated spurious emission test under different RB size/offset and modulations in exploratory test. Subsequently, only the worst case emissions are reported. 															

2.2 Connection Diagram of Test System

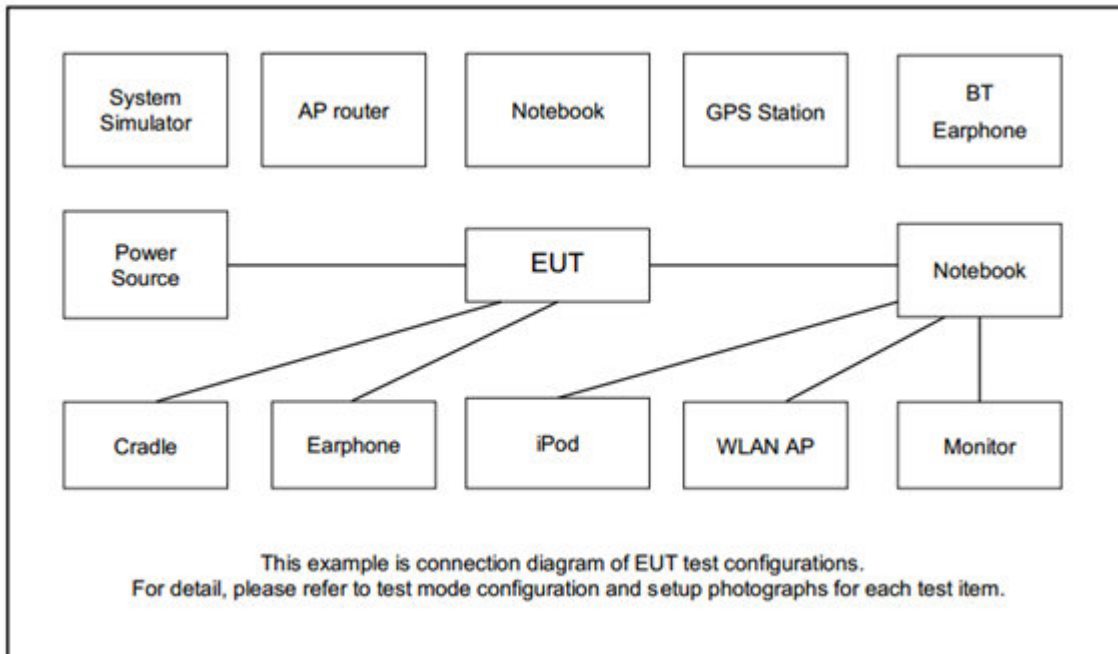

2.3 Support Unit used in test configuration and system

Item	Equipment	Trade Name	Model No.	FCC ID	Data Cable	Power Cord
1.	DC Power Supply	GW	GPS-3030D	N/A	N/A	Unshielded, 1.8 m
2.	LTE Base Station	Anritsu	MT8820C	N/A	N/A	Unshielded, 1.8 m
3.	WWAN Antenna	VLG Wireless	N/A	N/A	N/A	N/A

2.4 Measurement Results Explanation Example

For all conducted test items:

The offset level is set in the spectrum analyzer to compensate the RF cable loss and attenuator factor between EUT conducted output port and spectrum analyzer. With the offset compensation, the spectrum analyzer reading level is exactly the EUT RF output level.

The spectrum analyzer offset is derived from RF cable loss and attenuator factor.

Offset = RF cable loss + attenuator factor.

Following shows an offset computation example with cable loss 4.0 dB and 10dB attenuator.

Example :

$$\begin{aligned} \text{Offset(dB)} &= \text{RF cable loss(dB)} + \text{attenuator factor(dB)}. \\ &= 4.0 + 10 = 14.0 \text{ (dB)} \end{aligned}$$



2.5 Frequency List of Low/Middle/High Channels

LTE Band 2 Channel and Frequency List				
BW [MHz]	Channel/Frequency(MHz)	Lowest	Middle	Highest
20	Channel	18700	18900	19100
	Frequency	1860	1880	1900
15	Channel	18675	18900	19125
	Frequency	1857.5	1880	1902.5
10	Channel	18650	18900	19150
	Frequency	1855	1880	1905
5	Channel	18625	18900	19175
	Frequency	1852.5	1880	1907.5
3	Channel	18615	18900	19185
	Frequency	1851.5	1880	1908.5
1.4	Channel	18607	18900	19193
	Frequency	1850.7	1880	1909.3

LTE Band 4 Channel and Frequency List				
BW [MHz]	Channel/Frequency(MHz)	Lowest	Middle	Highest
20	Channel	20050	20175	20300
	Frequency	1720	1732.5	1745
15	Channel	20025	20175	20325
	Frequency	1717.5	1732.5	1747.5
10	Channel	20000	20175	20350
	Frequency	1715	1732.5	1750
5	Channel	19975	20175	20375
	Frequency	1712.5	1732.5	1752.5
3	Channel	19965	20175	20385
	Frequency	1711.5	1732.5	1753.5
1.4	Channel	19957	20175	20393
	Frequency	1710.7	1732.5	1754.3



LTE Band 5 Channel and Frequency List				
BW [MHz]	Channel/Frequency(MHz)	Lowest	Middle	Highest
10	Channel	20450	20525	20600
	Frequency	829	836.5	844
5	Channel	20425	20525	20625
	Frequency	826.5	836.5	846.5
3	Channel	20415	20525	20635
	Frequency	825.5	836.5	847.5
1.4	Channel	20407	20525	20643
	Frequency	824.7	836.5	848.3

LTE Band 12 Channel and Frequency List				
BW [MHz]	Channel/Frequency(MHz)	Lowest	Middle	Highest
10	Channel	23060	23095	23130
	Frequency	704	707.5	711
5	Channel	23035	23095	23155
	Frequency	701.5	707.5	713.5
3	Channel	23025	23095	23165
	Frequency	700.5	707.5	714.5
1.4	Channel	23017	23095	23173
	Frequency	699.7	707.5	715.3

LTE Band 13 Channel and Frequency List				
BW [MHz]	Channel/Frequency(MHz)	Lowest	Middle	Highest
10	Channel	-	23230	-
	Frequency	-	782	-
5	Channel	23205	23230	23255
	Frequency	779.5	782	784.5



LTE Band 17 Channel and Frequency List				
BW [MHz]	Channel/Frequency(MHz)	Lowest	Middle	Highest
10	Channel	23780	23790	23800
	Frequency	709	710	711
5	Channel	23755	23790	23825
	Frequency	706.5	710	713.5

LTE Band 25 Channel and Frequency List				
BW [MHz]	Channel/Frequency(MHz)	Lowest	Middle	Highest
20	Channel	26140	26340	26590
	Frequency	1860	1880	1905
15	Channel	26115	26340	26615
	Frequency	1857.5	1880	1907.5
10	Channel	26090	26340	26640
	Frequency	1855	1880	1910
5	Channel	26065	26340	26665
	Frequency	1852.5	1880	1912.5
3	Channel	26055	26340	26675
	Frequency	1851.5	1880	1913.5
1.4	Channel	26047	26340	26683
	Frequency	1850.7	1880	1914.3

LTE Band 26 Channel and Frequency List				
BW [MHz]	Channel/Frequency(MHz)	Lowest	Middle	Highest
15	Channel	26865	26915	26965
	Frequency	831.5	836.5	841.5
10	Channel	26840	26915	26990
	Frequency	829	836.5	844
5	Channel	26815	26915	27015
	Frequency	826.5	836.5	846.5
3	Channel	26805	26915	27025
	Frequency	825.5	836.5	847.5
1.4	Channel	26797	26915	27033
	Frequency	824.7	836.5	848.3



LTE Band 41 Channel and Frequency List				
BW [MHz]	Channel/Frequency(MHz)	Lowest	Middle	Highest
20	Channel	40340	40870	41140
	Frequency	2565	2618	2645
15	Channel	40315	40885	41165
	Frequency	2562.5	2619.5	2647.5
10	Channel	40290	40890	41190
	Frequency	2560	2620	2650
5	Channel	40265	40905	41215
	Frequency	2557.5	2621.5	2652.5

3 Conducted Test Items

3.1 Measuring Instruments

See list of measuring instruments of this test report.

3.2 Test Setup

3.2.1 Conducted Output Power

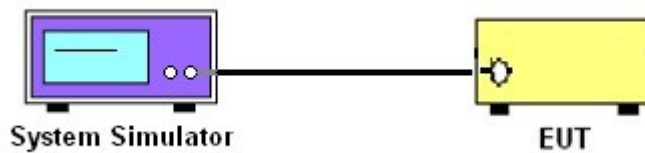

3.2.2 Peak-to-Average Ratio, Occupied Bandwidth ,Conducted Band-Edge and Conducted Spurious Emission

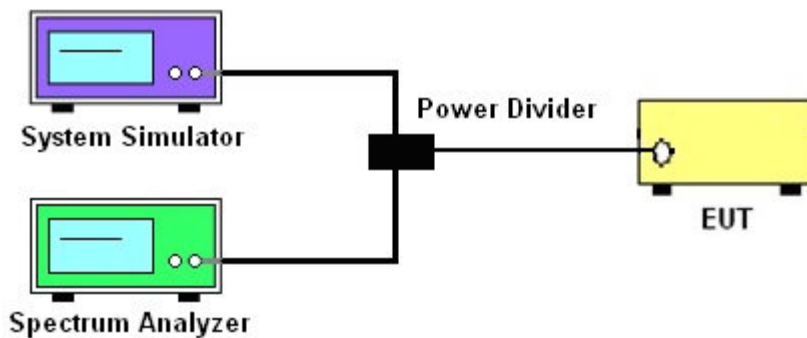

3.2.3 Frequency Stability

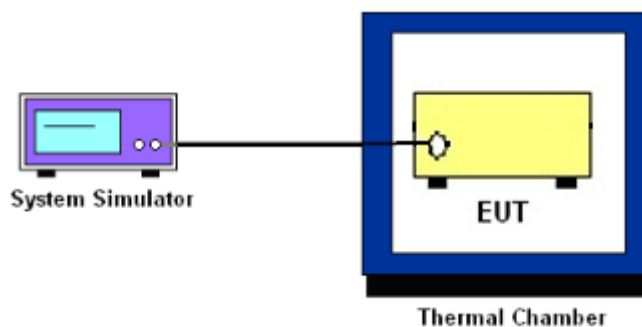

3.3 Test Result of Conducted Test

Please refer to Appendix A.



3.4 Conducted Output Power and ERP/EIRP

3.4.1 Description of the Conducted Output Power Measurement and ERP/EIRP Measurement

A system simulator was used to establish communication with the EUT. Its parameters were set to force the EUT transmitting at maximum output power. The measured power in the radio frequency on the transmitter output terminals shall be reported.

The ERP of mobile transmitters must not exceed 7 Watts for LTE Band 5 and Band 26.

The ERP of mobile transmitters must not exceed 3 Watts for LTE Band 12, Band 13 and Band 17.

The EIRP of mobile transmitters must not exceed 2 Watts for LTE Band 2 and Band 25 and Band 41.

The EIRP of mobile transmitters must not exceed 1 Watts for LTE Band 4.

According to KDB 412172 D01 Power Approach,

$EIRP = P_T + G_T - L_C$, $ERP = EIRP - 2.15$, where

P_T = transmitter output power in dBm

G_T = gain of the transmitting antenna in dBi

L_C = signal attenuation in the connecting cable between the transmitter and antenna in dB

3.4.2 Test Procedures

1. The testing follows ANSI C63.26 Section 5.2
2. The transmitter output port was connected to the system simulator.
3. Set EUT at maximum power through the system simulator.
4. Select lowest, middle, and highest channels for each band and different modulation.
5. Measure and record the power level from the system simulator.



3.5 Peak-to-Average Ratio

3.5.1 Description of the PAR Measurement

Power Complementary Cumulative Distribution Function (CCDF) curves provide a means for characterizing the power peaks of a digitally modulated signal on a statistical basis. A CCDF curve depicts the probability of the peak signal amplitude exceeding the average power level. Most contemporary measurement instrumentation include the capability to produce CCDF curves for an input signal provided that the instrument's resolution bandwidth can be set wide enough to accommodate the entire input signal bandwidth. In measuring transmissions in this band using an average power technique, the peak-to-average ratio (PAR) of the transmission may not exceed 13 dB.

3.5.2 Test Procedures

1. The testing follows ANSI C63.26 Section 5.2.3.4 (CCDF).
2. The EUT was connected to spectrum and system simulator via a power divider.
3. Set the CCDF (Complementary Cumulative Distribution Function) option in spectrum analyzer.
4. The highest RF powers were measured and recorded the maximum PAPR level associated with a probability of 0.1 %.
5. Record the deviation as Peak to Average Ratio.



3.6 Occupied Bandwidth

3.6.1 Description of Occupied Bandwidth Measurement

The occupied bandwidth is the width of a frequency band such that, below the lower and above the upper frequency limits, the mean powers emitted are each equal to a specified percentage 0.5% of the total mean transmitted power.

The 26 dB emission bandwidth is defined as the frequency range between two points, one above and one below the carrier frequency, at which the spectral density of the emission is attenuated 26 dB below the maximum in-band spectral density of the modulated signal. Spectral density (power per unit bandwidth) is to be measured with a detector of resolution bandwidth equal to approximately 1.0% of the emission bandwidth.

3.6.2 Test Procedures

1. The testing follows ANSI C63.26 Section 5.4
2. The EUT was connected to spectrum analyzer and system simulator via a power divider.
3. The spectrum analyzer center frequency is set to the nominal EUT channel center frequency. The span range for the spectrum analyzer shall be between two and five times the anticipated OBW.
4. The nominal resolution bandwidth (RBW) shall be in the range of 1 to 5 % of the anticipated OBW, and the VBW shall be at least 3 times the RBW.
5. Set the detection mode to peak, and the trace mode to max hold.
6. Determine the reference value: Set the EUT to transmit a modulated signal. Allow the trace to stabilize. Set the spectrum analyzer marker to the highest level of the displayed trace.
(this is the reference value)
7. Determine the “-26 dB down amplitude” as equal to (Reference Value – X).
8. Place two markers, one at the lowest and the other at the highest frequency of the envelope of the spectral display such that each marker is at or slightly below the “-X dB down amplitude” determined in step 6. If a marker is below this “-X dB down amplitude” value it shall be placed as close as possible to this value. The OBW is the positive frequency difference between the two markers.
9. Use the 99 % power bandwidth function of the spectrum analyzer and report the measured bandwidth.



3.7 Conducted Band Edge

3.7.1 Description of Conducted Band Edge Measurement

22.917(a)

For operations in the 824 – 849 MHz band, the FCC limit is $43 + 10\log_{10}(P[\text{Watts}])$ dB below the transmitter power P(Watts) in a 100kHz bandwidth. However, in the 1MHz bands immediately outside and adjacent to the licensee's frequency block, a resolution bandwidth of at least one percent of the emission bandwidth of the fundamental emission of the transmitter may be employed.

24.238 (a)

For operations in the 1850-1910 and 1930-1990 MHz band, the FCC limit is $43 + 10\log_{10}(P[\text{Watts}])$ dB below the transmitter power P(Watts) in a 1MHz bandwidth. However, in the 1 MHz bands immediately outside and adjacent to the frequency block a resolution bandwidth of at least one percent of the emission bandwidth of the fundamental emission of the transmitter may be employed.

27.53 (c)

For operations in the 776-788 MHz band, the FCC limit is $43 + 10\log_{10}(P[\text{Watts}])$ dB below the transmitter power P(Watts) in a 100 kHz bandwidth. However, in the 100 kHz bands immediately outside and adjacent to the frequency block, a resolution bandwidth of at least 30 kHz may be employed. In addition, the power of any unwanted emissions in any 6.25 kHz bandwidth for all frequencies between 763-775 MHz and 793-806 MHz shall be attenuated below the transmitter power, P (dBW), by at least $65 + 10 \log_{10} p(\text{watts})$, dB, for mobile and portable equipment.

27.53 (g)

For operations in the 600MHz band and 698 -746 MHz band, the FCC limit is $43 + 10\log_{10}(P[\text{Watts}])$ dB below the transmitter power P(Watts) in a 100 kHz bandwidth. However, in the 100 kilohertz bands immediately outside and adjacent to a licensee's frequency block, a resolution bandwidth of at least 30 kHz may be employed.

27.53 (h)

For operations in the 1710 – 1755 MHz band, the FCC limit is $43 + 10\log_{10}(P[\text{Watts}])$ dB below the transmitter power P(Watts) in a 1 MHz bandwidth. However, in the 1MHz bands immediately outside and adjacent to the licensee's frequency block, a resolution bandwidth of at least one percent of the emission bandwidth of the fundamental emission of the transmitter may be employed.



27.53(m)(4)

For mobile digital stations, the attenuation factor shall be not less than $40 + 10 \log (P)$ dB on all frequencies between the channel edge and 5 megahertz from the channel edge, $43 + 10 \log (P)$ dB on all frequencies between 5 megahertz and X megahertz from the channel edge, and $55 + 10 \log (P)$ dB on all frequencies more than X megahertz from the channel edge, where X is the greater of 6 megahertz or the actual emission bandwidth as defined in paragraph (m)(6) of this section. In addition, the attenuation factor shall not be less that $43 + 10 \log (P)$ dB on all frequencies between 2490.5 MHz and 2496 MHz and $55 + 10 \log (P)$ dB at or below 2490.5 MHz. Mobile Satellite Service licensees operating on frequencies below 2495 MHz may also submit a documented interference complaint against BRS licensees operating on channel BRS Channel 1 on the same terms and conditions as adjacent channel BRS or EBS licensees.

3.7.2 Test Procedures

1. The testing follows ANSI C63.26 section 5.7
2. The EUT was connected to spectrum analyzer and system simulator via a power divider.
3. The band edges of low and high channels for the highest RF powers were measured.
4. Set RBW $\geq 1\%$ EBW in the 1MHz band immediately outside and adjacent to the band edge.
5. Beyond the 1 MHz band from the band edge, RBW=1MHz was used.
6. Set spectrum analyzer with RMS detector.
7. Offset has included the duty factor for LTE Band 41. Duty factor = $10 \log (1/x)$, where x is the measured duty cycle.
8. The RF fundamental frequency should be excluded against the limit line in the operating frequency band.
9. Checked that all the results comply with the emission limit line.

Example:

The limit line is derived from $43 + 10\log(P)$ dB below the transmitter power P(Watts)
= $P(W) - [43 + 10\log(P)]$ (dB)
= $[30 + 10\log(P)]$ (dBm) - $[43 + 10\log(P)]$ (dB) = -13dBm.

10. For LTE Band 41, the other 40 dB, and 55 dB have additionally applied same calculation above.



3.8 Conducted Spurious Emission

3.8.1 Description of Conducted Spurious Emission Measurement

The power of any emission outside of the authorized operating frequency ranges must be lower than the transmitter power (P) by a factor of at least $43 + 10 \log (P)$ dB.

For Band 41:

The power of any emission outside of the authorized operating frequency ranges must be lower than the transmitter power (P) by a factor of at least $55 + 10 \log (P)$ dB.

It is measured by means of a calibrated spectrum analyzer and scanned from 30 MHz up to a frequency including its 10th harmonic.

3.8.2 Test Procedures

1. The testing follows ANSI C63.26 section 5.7
2. The EUT was connected to spectrum analyzer and system simulator via a power divider.
3. The RF output of EUT was connected to the spectrum analyzer by RF cable and attenuator. The path loss was compensated to the results for each measurement.
4. The middle channel for the highest RF power within the transmitting frequency was measured.
5. The conducted spurious emission for the whole frequency range was taken.
6. Make the measurement with the spectrum analyzer's RBW = 1MHz, VBW = 3MHz.
7. Set spectrum analyzer with RMS detector.
8. Offset has included the duty factor for LTE Band 41. Duty factor = $10 \log (1/x)$, where x is the measured duty cycle
9. Taking the record of maximum spurious emission.
10. The RF fundamental frequency should be excluded against the limit line in the operating frequency band.
11. The limit line is derived from $43 + 10 \log(P)$ dB below the transmitter power P(Watts)
= $P(W) - [43 + 10 \log(P)]$ (dB)
= $[30 + 10 \log(P)]$ (dBm) - $[43 + 10 \log(P)]$ (dB)
= -13dBm.
12. For Band 41
The limit line is derived from $55 + 10 \log(P)$ dB below the transmitter power P(Watts)
= $P(W) - [55 + 10 \log(P)]$ (dB)
= $[30 + 10 \log(P)]$ (dBm) - $[55 + 10 \log(P)]$ (dB)
= -25dBm.



3.9 Frequency Stability

3.9.1 Description of Frequency Stability Measurement

The frequency stability shall be measured by variation of ambient temperature and variation of primary supply voltage to ensure that the fundamental emission stays within the authorized frequency block. The frequency stability of the transmitter shall be maintained within $\pm 0.00025\%$ ($\pm 2.5\text{ppm}$) of the center frequency.

3.9.2 Test Procedures for Temperature Variation

1. The testing follows ANSI C63.26 section 5.6.4
2. The EUT was set up in the thermal chamber and connected with the system simulator.
3. With power OFF, the temperature was decreased to -30°C and the EUT was stabilized before testing. Power was applied and the maximum change in frequency was recorded within one minute.
4. With power OFF, the temperature was raised in 10°C step up to 50°C . The EUT was stabilized at each step for at least half an hour. Power was applied and the maximum frequency change was recorded within one minute.

3.9.3 Test Procedures for Voltage Variation

1. The testing follows ANSI C63.26 section 5.6.5
2. The EUT was placed in a temperature chamber at $20\pm 5^{\circ}\text{C}$ and connected with the system simulator.
3. The power supply voltage to the EUT was varied from 85% to 115% of the nominal value for other than hand carried battery equipment.
4. For hand carried, battery powered equipment, reduce the primary ac or dc supply voltage to the battery operating end point, which shall be specified by the manufacturer.
5. The variation in frequency was measured for the worst case.

4 Radiated Test Items

4.1 Measuring Instruments

See list of measuring instruments of this test report.

4.2 Test Setup

4.2.1 For radiated test from 30MHz to 1GHz

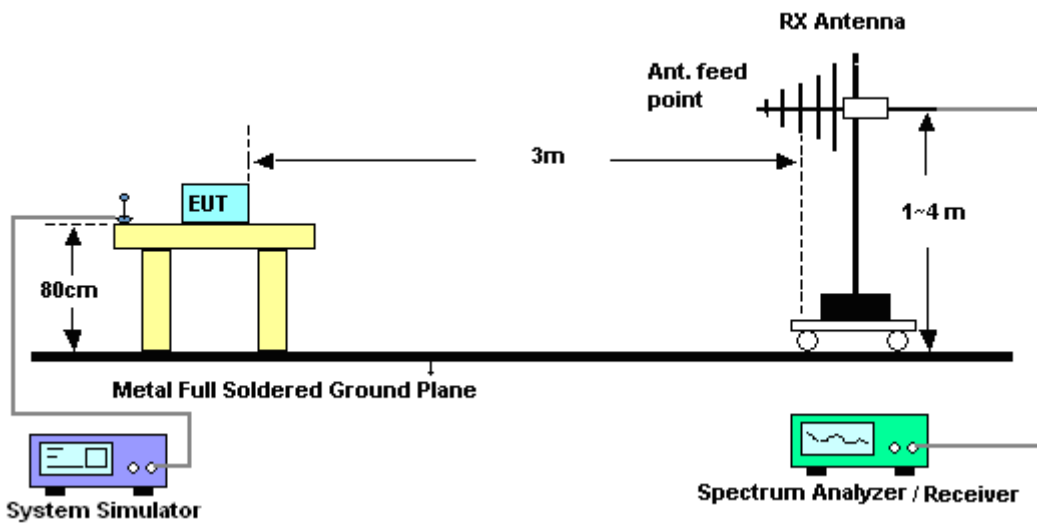

4.2.2 For radiated test above 1GHz

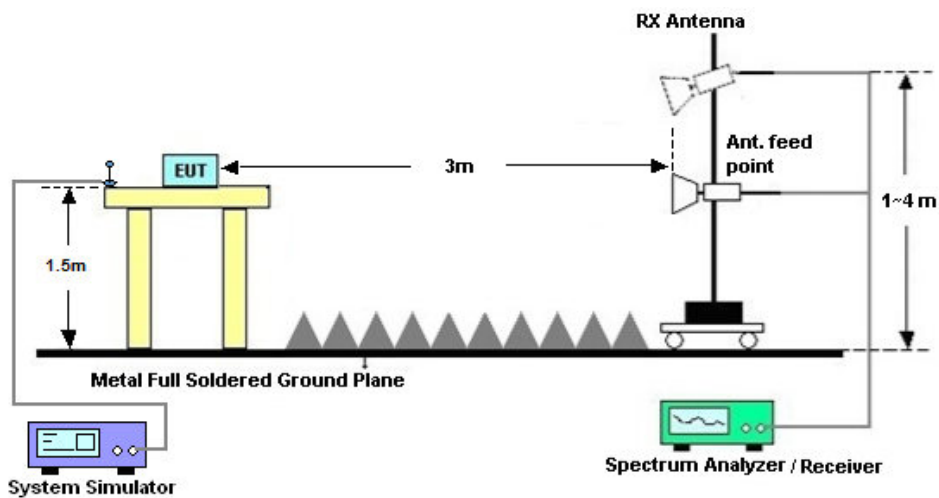

4.3 Test Result of Radiated Test

Please refer to Appendix B.



4.4 Radiated Spurious Emission

4.4.1 Description of Radiated Spurious Emission

The radiated spurious emission was measured by substitution method according to ANSI C63.26. The power of any emission outside of the authorized operating frequency ranges must be attenuated below the transmitter power (P) by a factor of at least $43 + 10 \log (P)$ dB.

For Band 41

The power of any emission outside of the authorized operating frequency ranges must be attenuated below the transmitter power (P) by a factor of at least $55 + 10 \log (P)$ dB.

For LTE Band 13

For operations in the 746-758 MHz, 775-788 MHz, and 805-806 MHz bands, emissions in the band 1559-1610 MHz shall be limited to -70 dBW/MHz equivalent isotropically radiated power (EIRP) for wideband signals, and -80 dBW EIRP for discrete emissions of less than 700 Hz bandwidth

4.4.2 Test Procedures

1. The testing follows ANSI C63.26 Section 5.5
2. The EUT was placed on a turntable with 0.8 meter height for frequency below 1GHz and 1.5 meter height for frequency above 1GHz respectively above ground.
3. The EUT was set 3 meters from the receiving antenna mounted on the antenna tower.
4. The table was rotated 360 degrees to determine the position of the highest spurious emission.
5. The height of the receiving antenna is varied between 1m to 4m to search the maximum spurious emission for both horizontal and vertical polarizations.
6. During the measurement, the system simulator parameters were set to force the EUT transmitting at maximum output power.
7. Make the measurement with the spectrum analyzer's RBW = 1MHz, VBW = 3MHz, taking the record of maximum spurious emission.
8. A horn antenna was substituted in place of the EUT and was driven by a signal generator.
9. Tune the output power of signal generator to the same emission level with EUT maximum spurious emission.
10. $EIRP (dBm) = S.G. Power - Tx Cable Loss + Tx Antenna Gain$
11. $ERP (dBm) = EIRP - 2.15$
12. The RF fundamental frequency should be excluded against the limit line in the operating frequency band.
The limit line is derived from $43 + 10\log(P)$ dB below the transmitter power P(Watts)
 $= P(W) - [43 + 10\log(P)] (dB)$
 $= [30 + 10\log(P)] (dBm) - [43 + 10\log(P)] (dB)$
 $= -13dBm.$
13. For Band 41:
The limit line is derived from $55 + 10\log(P)$ dB below the transmitter power P(Watts)



5 List of Measuring Equipment

Instrument	Manufacturer	Model No.	Serial No.	Characteristics	Calibration Date	Test Date	Due Date	Remark
Spectrum Analyzer	R&S	FSV40	101078	9kHz~40GHz	Apr. 22, 2017	Apr. 09, 2018~ Apr. 20, 2018	Apr. 21, 2018	Conducted (TH01-SZ)
Radio Communicatio	Anritsu	MT8820C	6201563777	2G/3G/4G (CDMA)	Jan. 03, 2018	Apr. 09, 2018~ Apr. 20, 2018	Jan. 02, 2019	Conducted (TH01-SZ)
Thermal Chamber	Ten Billion Hongzhangroup	LP-150U	H2014081803	-40~+150°C	Jul. 20, 2017	Apr. 09, 2018~ Apr. 20, 2018	Jul. 19, 2018	Conducted (TH01-SZ)
EMI Test Receiver&SA	Agilent	N9038A	MY52260185	20Hz~26.5GHz	Apr. 22, 2017	Apr. 12, 2018~ Apr. 19, 2018	Apr. 21, 2018	Radiation (03CH01-SZ)
Bilog Antenna	TeseQ	CBL6112D	35407	30MHz-2GHz	May 10, 2017	Apr. 12, 2018~ Apr. 19, 2018	May 09, 2018	Radiation (03CH01-SZ)
Double Ridge Horn Antenna	ETS Lindgren	3117	119436	1GHz~18GHz	Jul. 28, 2017	Apr. 12, 2018~ Apr. 19, 2018	Jul. 27, 2018	Radiation (03CH01-SZ)
SHF-EHF Horn	com-power	AH-840	101071	18Ghz-40GHz	Jun. 16, 2017	Apr. 12, 2018~ Apr. 19, 2018	Jun. 15, 2018	Radiation (03CH01-SZ)
LF Amplifier	Burgeon	BPA-530	102209	0.01~3000Mhz	Apr. 22, 2017	Apr. 12, 2018~ Apr. 19, 2018	Apr. 21, 2018	Radiation (03CH01-SZ)
HF Amplifier	KEYSIGHT	83017A	MY53270104	0.5GHz~26.5Ghz	Oct. 19, 2017	Apr. 12, 2018~ Apr. 19, 2018	Oct 18, 2018	Radiation (03CH01-SZ)
HF Amplifier	MITEQ	TTA1840-35-HG	1871923	18GHz~40GHz	Jul. 18, 2017	Apr. 12, 2018~ Apr. 19, 2018	Jul. 17, 2018	Radiation (03CH01-SZ)
AC Power Source	Chroma	61601	616010001985	N/A	NCR	Apr. 12, 2018~ Apr. 19, 2018	NCR	Radiation (03CH01-SZ)
Turn Table	EM	EM1000	N/A	0~360 degree	NCR	Apr. 12, 2018~ Apr. 19, 2018	NCR	Radiation (03CH01-SZ)
Antenna Mast	EM	EM1000	N/A	1 m~4 m	NCR	Apr. 12, 2018~ Apr. 19, 2018	NCR	Radiation (03CH01-SZ)

NCR: No Calibration Required



6 Uncertainty of Evaluation

Uncertainty of Radiated Emission Measurement (30 MHz ~ 1000 MHz)

Measuring Uncertainty for a Level of Confidence of 95% ($U = 2Uc(y)$)	2.5dB
---	-------

Uncertainty of Radiated Emission Measurement (1 GHz ~ 18 GHz)

Measuring Uncertainty for a Level of Confidence of 95% ($U = 2Uc(y)$)	3.5dB
---	-------

Uncertainty of Radiated Emission Measurement (18 GHz ~ 40 GHz)

Measuring Uncertainty for a Level of Confidence of 95% ($U = 2Uc(y)$)	4.0dB
---	-------



Appendix A. Test Results of Conducted Test

Conducted Output Power(Average power)

LTE Band 2 Maximum Average Power [dBm]						
BW [MHz]	RB Size	RB Offset	Mod	Lowest	Middle	Highest
20	1	0	QPSK	21.42	21.46	21.41
20	1	49		22.08	21.53	22.09
20	1	99		21.60	21.34	21.20
20	50	0		20.80	20.85	20.83
20	50	24		20.75	20.72	20.73
20	50	50		20.77	20.64	20.66
20	100	0		20.73	20.72	20.77
20	1	0	16-QAM	20.54	20.61	20.51
20	1	49		20.53	20.46	20.48
20	1	99		20.41	20.42	20.41
20	50	0		19.82	19.78	19.72
20	50	24		19.68	19.74	19.71
20	50	50		19.78	19.48	19.66
20	100	0		19.73	19.71	19.65
15	1	0	QPSK	21.73	21.69	21.87
15	1	37		21.87	21.83	22.07
15	1	74		21.49	21.69	21.61
15	36	0		20.87	20.96	20.95
15	36	20		20.81	20.65	20.83
15	36	39		20.74	20.73	20.87
15	75	0		20.79	20.86	20.87
15	1	0	16-QAM	20.73	20.72	20.78
15	1	37		20.71	20.59	20.75
15	1	74		20.43	20.53	20.49
15	36	0		19.74	19.86	19.91
15	36	20		19.79	19.65	19.80
15	36	39		19.72	19.72	19.68
15	75	0		19.76	19.77	19.75



LTE Band 2 Maximum Average Power [dBm]						
BW [MHz]	RB Size	RB Offset	Mod	Lowest	Middle	Highest
10	1	0	QPSK	21.67	21.77	21.70
10	1	25		21.89	21.86	21.78
10	1	49		21.61	21.47	21.56
10	25	0		20.93	20.99	20.95
10	25	12		20.94	20.93	20.92
10	25	25		20.87	20.86	20.88
10	50	0		20.94	20.99	20.85
10	1	0	16-QAM	20.74	20.81	20.70
10	1	25		20.83	20.75	20.91
10	1	49		20.63	20.74	20.60
10	25	0		19.99	20.15	20.02
10	25	12		20.01	19.89	20.00
10	25	25		19.84	19.86	19.87
10	50	0		19.94	19.80	19.75
5	1	0	QPSK	21.89	21.77	22.06
5	1	12		21.97	21.82	22.06
5	1	24		21.60	21.51	21.75
5	12	0		20.98	20.97	21.11
5	12	7		21.03	20.93	21.10
5	12	13		20.91	20.80	21.10
5	25	0		20.99	20.85	21.09
5	1	0	16-QAM	20.73	20.62	20.75
5	1	12		20.85	20.76	21.21
5	1	24		20.74	20.68	20.66
5	12	0		20.04	20.11	19.98
5	12	7		19.96	20.09	19.98
5	12	13		19.80	19.89	19.93
5	25	0		19.96	19.94	20.07



LTE Band 2 Maximum Average Power [dBm]						
BW [MHz]	RB Size	RB Offset	Mod	Lowest	Middle	Highest
3	1	0	QPSK	21.57	21.45	21.66
3	1	8		21.46	21.20	21.46
3	1	14		21.48	21.30	21.38
3	8	0		20.70	20.70	20.79
3	8	4		20.81	20.57	20.75
3	8	7		20.75	20.54	20.69
3	15	0		20.75	20.55	20.74
3	1	0	16-QAM	20.35	20.34	20.53
3	1	8		20.38	20.27	20.42
3	1	14		20.44	20.28	20.50
3	8	0		19.66	19.58	19.84
3	8	4		19.61	19.72	19.79
3	8	7		19.73	19.63	19.75
3	15	0		19.71	19.49	19.75
1.4	1	0	QPSK	21.78	21.78	21.96
1.4	1	3		21.88	21.78	21.98
1.4	1	5		21.74	21.74	21.92
1.4	3	0		21.84	21.78	21.94
1.4	3	1		21.96	21.80	22.01
1.4	3	3		21.85	21.79	22.02
1.4	6	0		20.92	20.80	21.03
1.4	1	0	16-QAM	20.85	20.58	20.81
1.4	1	3		20.87	20.73	20.84
1.4	1	5		20.71	20.46	20.63
1.4	3	0		20.76	20.70	20.86
1.4	3	1		20.81	20.66	20.88
1.4	3	3		20.77	20.80	20.93
1.4	6	0		19.80	19.86	19.89



LTE Band 25 Maximum Average Power [dBm]						
BW [MHz]	RB Size	RB Offset	Mod	Lowest	Middle	Highest
20	1	0	QPSK	21.66	21.76	21.84
20	1	49		21.99	22.37	22.05
20	1	99		21.89	21.41	21.64
20	50	0		20.97	21.03	21.04
20	50	24		20.94	20.88	20.90
20	50	50		20.90	20.79	20.92
20	100	0		20.95	20.93	21.05
20	1	0	16-QAM	20.71	20.74	20.84
20	1	49		20.72	20.65	20.75
20	1	99		20.46	20.55	20.83
20	50	0		20.05	20.10	20.11
20	50	24		20.09	19.86	20.14
20	50	50		19.99	19.88	19.92
20	100	0		19.91	19.83	20.04
15	1	0	QPSK	21.37	21.79	21.86
15	1	37		21.78	21.64	21.91
15	1	74		21.49	21.51	21.85
15	36	0		20.63	20.95	20.97
15	36	20		20.72	20.81	21.00
15	36	39		20.71	20.74	20.90
15	75	0		20.74	20.84	20.94
15	1	0	16-QAM	20.60	20.78	20.80
15	1	37		20.46	20.63	20.74
15	1	74		20.38	20.50	20.80
15	36	0		19.73	20.05	20.08
15	36	20		19.74	19.82	20.01
15	36	39		19.73	19.82	19.99
15	75	0		19.85	19.82	20.04



LTE Band 25 Maximum Average Power [dBm]						
BW [MHz]	RB Size	RB Offset	Mod	Lowest	Middle	Highest
10	1	0	QPSK	21.56	22.04	21.82
10	1	25		21.74	21.89	22.10
10	1	49		21.35	21.41	21.73
10	25	0		20.75	21.00	21.04
10	25	12		20.56	20.81	21.08
10	25	25		20.66	20.75	21.03
10	50	0		20.77	20.80	21.00
10	1	0	16-QAM	20.52	20.72	20.84
10	1	25		20.55	20.71	20.95
10	1	49		20.46	20.53	20.85
10	25	0		20.00	20.18	20.27
10	25	12		19.67	20.01	20.36
10	25	25		19.59	19.85	20.12
10	50	0		19.89	19.72	20.09
5	1	0	QPSK	21.54	21.91	21.86
5	1	12		21.70	21.61	22.36
5	1	24		21.26	21.28	21.90
5	12	0		20.73	20.88	20.91
5	12	7		20.69	20.72	21.09
5	12	13		20.59	20.71	21.04
5	25	0		20.63	20.75	20.96
5	1	0	16-QAM	20.32	20.59	20.66
5	1	12		20.53	20.22	20.60
5	1	24		20.24	20.53	20.76
5	12	0		19.57	19.73	20.09
5	12	7		19.73	19.67	20.08
5	12	13		19.73	19.60	20.15
5	25	0		19.76	19.61	20.23



LTE Band 25 Maximum Average Power [dBm]						
BW [MHz]	RB Size	RB Offset	Mod	Lowest	Middle	Highest
3	1	0	QPSK	21.63	22.00	21.87
3	1	8		21.62	21.79	22.05
3	1	14		21.53	21.48	21.86
3	8	0		20.70	20.83	21.26
3	8	4		20.73	20.80	21.21
3	8	7		20.68	20.95	21.09
3	15	0		20.78	20.86	21.13
3	1	0	16-QAM	20.64	20.80	20.89
3	1	8		20.54	20.59	20.81
3	1	14		20.53	20.50	20.84
3	8	0		19.85	19.90	20.30
3	8	4		19.92	19.79	20.26
3	8	7		19.83	20.02	20.19
3	15	0		19.82	19.72	20.07
1.4	1	0	QPSK	21.82	22.09	22.13
1.4	1	3		21.96	21.99	22.08
1.4	1	5		21.84	21.79	21.95
1.4	3	0		21.86	21.99	22.13
1.4	3	1		22.16	22.10	22.22
1.4	3	3		21.99	22.02	22.27
1.4	6	0		20.88	20.89	21.09
1.4	1	0	16-QAM	20.69	20.76	20.96
1.4	1	3		20.84	20.91	21.31
1.4	1	5		20.73	20.61	20.99
1.4	3	0		20.80	21.08	21.15
1.4	3	1		20.93	21.23	21.23
1.4	3	3		20.90	21.06	21.09
1.4	6	0		19.95	20.01	20.30



LTE Band 4 Maximum Average Power [dBm]						
BW [MHz]	RB Size	RB Offset	Mod	Lowest	Middle	Highest
20	1	0	QPSK	21.47	21.51	21.57
20	1	49		21.91	22.12	22.05
20	1	99		21.44	21.40	21.39
20	50	0		20.63	20.83	20.69
20	50	24		20.69	20.62	20.72
20	50	50		20.64	20.58	20.55
20	100	0		20.48	20.60	20.68
20	1	0	16-QAM	20.35	20.58	20.68
20	1	49		20.30	20.62	20.42
20	1	99		20.12	20.22	20.33
20	50	0		19.54	19.74	19.68
20	50	24		19.47	19.50	19.59
20	50	50		19.64	19.56	19.34
20	100	0		19.56	19.55	19.52
15	1	0	QPSK	21.70	21.75	21.82
15	1	37		22.00	21.93	21.71
15	1	74		21.67	21.66	21.69
15	36	0		20.73	20.89	20.66
15	36	20		20.70	20.73	20.73
15	36	39		20.86	20.68	20.56
15	75	0		20.78	20.77	20.70
15	1	0	16-QAM	20.71	20.52	20.41
15	1	37		20.53	20.66	20.54
15	1	74		20.58	20.24	20.29
15	36	0		19.60	19.72	19.60
15	36	20		19.67	19.47	19.58
15	36	39		19.74	19.53	19.44
15	75	0		19.72	19.57	19.58



LTE Band 4 Maximum Average Power [dBm]						
BW [MHz]	RB Size	RB Offset	Mod	Lowest	Middle	Highest
10	1	0	QPSK	21.52	21.51	21.68
10	1	25		21.91	21.75	21.92
10	1	49		21.33	21.54	21.85
10	25	0		20.83	20.86	20.79
10	25	12		20.76	20.78	20.91
10	25	25		20.69	20.84	20.86
10	50	0		20.72	20.68	20.84
10	1	0	16-QAM	20.59	20.24	20.63
10	1	25		20.58	20.70	20.72
10	1	49		20.31	20.37	20.60
10	25	0		19.79	20.02	19.84
10	25	12		19.67	19.98	19.86
10	25	25		19.55	19.67	19.75
10	50	0		19.72	19.74	19.82
5	1	0	QPSK	21.73	21.87	21.58
5	1	12		21.80	21.77	21.96
5	1	24		21.67	21.60	21.80
5	12	0		20.89	20.85	20.83
5	12	7		20.86	20.81	20.84
5	12	13		20.75	20.84	20.79
5	25	0		20.82	20.86	20.83
5	1	0	16-QAM	20.67	20.65	20.60
5	1	12		20.67	20.44	21.16
5	1	24		20.57	20.59	20.82
5	12	0		19.89	19.71	19.71
5	12	7		19.96	19.67	19.80
5	12	13		19.75	19.62	19.76
5	25	0		19.93	19.70	19.69



LTE Band 4 Maximum Average Power [dBm]						
BW [MHz]	RB Size	RB Offset	Mod	Lowest	Middle	Highest
3	1	0	QPSK	21.82	21.96	21.65
3	1	8		21.83	21.94	21.87
3	1	14		21.97	21.95	21.82
3	8	0		20.99	21.20	20.94
3	8	4		21.00	21.03	21.00
3	8	7		20.92	21.14	21.03
3	15	0		21.05	21.09	20.88
3	1	0	16-QAM	21.11	20.95	20.66
3	1	8		20.64	20.87	20.66
3	1	14		20.78	20.92	21.02
3	8	0		20.11	19.89	19.82
3	8	4		20.12	19.96	19.79
3	8	7		19.96	20.10	19.90
3	15	0		19.95	20.13	19.65
1.4	1	0	QPSK	21.83	21.94	21.77
1.4	1	3		21.70	21.83	21.80
1.4	1	5		21.79	21.81	21.72
1.4	3	0		21.85	22.06	21.77
1.4	3	1		21.88	22.11	21.90
1.4	3	3		21.92	21.79	21.95
1.4	6	0		20.83	20.77	20.67
1.4	1	0	16-QAM	20.60	20.73	20.48
1.4	1	3		20.74	20.68	20.75
1.4	1	5		20.67	20.58	20.75
1.4	3	0		20.82	20.62	20.31
1.4	3	1		21.09	20.89	20.88
1.4	3	3		20.92	20.85	20.90
1.4	6	0		19.80	19.69	19.60



LTE Band 5 Maximum Average Power [dBm]						
BW [MHz]	RB Size	RB Offset	Mod	Lowest	Middle	Highest
10	1	0	QPSK	21.79	21.67	21.77
10	1	25		22.12	21.94	22.42
10	1	49		21.80	21.68	21.59
10	25	0		21.03	21.05	20.94
10	25	12		21.06	21.00	21.14
10	25	25		20.98	20.98	21.02
10	50	0		21.02	20.93	21.10
10	1	0	16-QAM	20.67	20.43	20.71
10	1	25		20.83	20.78	20.79
10	1	49		20.66	20.74	20.58
10	25	0		20.08	20.20	20.03
10	25	12		19.99	20.01	20.18
10	25	25		20.08	20.06	20.03
10	50	0		20.04	20.22	20.11
5	1	0	QPSK	21.72	21.90	22.04
5	1	12		22.14	22.00	21.96
5	1	24		21.85	21.90	21.51
5	12	0		21.09	21.03	20.96
5	12	7		21.13	20.98	20.93
5	12	13		21.13	21.03	20.87
5	25	0		21.06	21.09	20.95
5	1	0	16-QAM	20.78	20.72	20.70
5	1	12		20.64	20.75	20.88
5	1	24		20.61	20.61	19.92
5	12	0		20.09	20.14	20.09
5	12	7		20.15	20.13	19.98
5	12	13		20.05	20.13	19.91
5	25	0		20.07	20.09	19.97



LTE Band 5 Maximum Average Power [dBm]						
BW [MHz]	RB Size	RB Offset	Mod	Lowest	Middle	Highest
3	1	0	QPSK	21.97	22.14	22.17
3	1	8		22.14	22.23	22.16
3	1	14		22.22	21.94	21.63
3	8	0		21.20	21.11	21.24
3	8	4		21.22	21.14	21.08
3	8	7		21.20	21.16	20.98
3	15	0		21.27	21.20	21.07
3	1	0	16-QAM	20.94	20.92	20.88
3	1	8		20.94	20.71	20.81
3	1	14		20.87	20.83	20.73
3	8	0		20.29	20.21	20.13
3	8	4		20.27	20.50	20.05
3	8	7		20.36	20.42	20.11
3	15	0		20.21	20.23	20.21
1.4	1	0	QPSK	22.11	22.31	22.07
1.4	1	3		22.21	22.28	22.15
1.4	1	5		22.02	22.25	21.95
1.4	3	0		22.30	22.29	22.20
1.4	3	1		22.41	22.25	22.25
1.4	3	3		22.34	22.25	22.05
1.4	6	0		21.23	21.24	21.00
1.4	1	0	16-QAM	21.09	20.91	20.90
1.4	1	3		21.20	21.04	21.01
1.4	1	5		20.97	20.93	20.86
1.4	3	0		21.35	21.09	21.09
1.4	3	1		21.26	21.14	21.17
1.4	3	3		21.15	21.15	21.09
1.4	6	0		20.32	20.17	20.09



LTE Band 26 Maximum Average Power [dBm]						
BW [MHz]	RB Size	RB Offset	Mod	Lowest	Middle	Highest
15	1	0	QPSK	21.94	21.61	21.92
15	1	37		22.34	22.35	22.35
15	1	74		22.05	21.92	21.98
15	36	0		21.15	21.12	20.95
15	36	20		21.17	21.07	21.15
15	36	39		21.05	21.19	21.02
15	75	0		21.14	21.07	21.15
15	1	0	16-QAM	20.91	20.69	20.88
15	1	37		20.84	20.63	20.82
15	1	74		20.87	20.71	20.70
15	36	0		20.25	20.12	19.94
15	36	20		20.17	20.06	20.06
15	36	39		20.03	20.20	20.13
15	75	0		20.11	20.17	20.08
10	1	0	QPSK	21.85	21.77	21.87
10	1	25		22.05	22.12	22.24
10	1	49		21.68	21.75	21.68
10	25	0		20.93	20.94	21.12
10	25	12		21.11	20.99	21.16
10	25	25		21.02	21.04	20.88
10	50	0		21.03	20.93	21.01
10	1	0	16-QAM	20.79	20.65	20.62
10	1	25		20.82	20.67	20.93
10	1	49		20.64	20.85	20.59
10	25	0		20.03	20.17	20.31
10	25	12		20.11	19.98	20.24
10	25	25		20.01	20.14	19.96
10	50	0		20.13	20.03	20.02



LTE Band 26 Maximum Average Power [dBm]						
BW [MHz]	RB Size	RB Offset	Mod	Lowest	Middle	Highest
5	1	0	QPSK	22.20	21.86	21.90
5	1	12		22.22	22.07	21.90
5	1	24		21.71	21.73	21.47
5	12	0		20.97	20.91	20.94
5	12	7		21.02	20.89	20.92
5	12	13		21.01	21.03	20.77
5	25	0		21.01	20.93	21.00
5	1	0	16-QAM	20.93	21.11	20.63
5	1	12		20.66	20.88	20.41
5	1	24		20.58	20.61	20.56
5	12	0		19.90	19.81	19.98
5	12	7		20.22	20.11	19.77
5	12	13		20.12	20.07	19.83
5	25	0		20.19	19.92	20.02
3	1	0	QPSK	21.82	21.73	22.05
3	1	8		21.81	21.76	21.62
3	1	14		21.78	21.66	21.54
3	8	0		20.91	20.96	21.07
3	8	4		21.03	20.90	20.91
3	8	7		20.93	20.97	20.90
3	15	0		20.98	20.86	20.90
3	1	0	16-QAM	20.60	20.50	20.66
3	1	8		20.57	20.65	20.55
3	1	14		20.65	20.64	20.59
3	8	0		19.97	20.00	20.10
3	8	4		20.09	19.96	19.86
3	8	7		20.09	20.02	20.00
3	15	0		20.09	19.97	20.03



LTE Band 26 Maximum Average Power [dBm]						
BW [MHz]	RB Size	RB Offset	Mod	Lowest	Middle	Highest
1.4	1	0	QPSK	21.82	21.73	21.77
1.4	1	3		21.81	21.76	22.12
1.4	1	5		21.78	21.66	21.75
1.4	3	0		20.91	21.07	20.94
1.4	3	1		21.03	20.96	20.99
1.4	3	3		20.93	20.90	21.04
1.4	6	0		20.98	20.90	20.93
1.4	1	0	16-QAM	20.60	20.66	20.88
1.4	1	3		20.57	20.65	20.82
1.4	1	5		20.65	20.44	20.70
1.4	3	0		19.97	20.00	19.94
1.4	3	1		20.09	19.96	20.06
1.4	3	3		20.09	20.02	20.13
1.4	6	0		20.09	19.97	20.08



LTE Band 12 Maximum Average Power [dBm]						
BW [MHz]	RB Size	RB Offset	Mod	Lowest	Middle	Highest
10	1	0	QPSK	21.74	21.88	21.84
10	1	25		22.15	22.35	22.11
10	1	49		21.82	21.97	21.53
10	25	0		20.96	21.06	21.07
10	25	12		21.00	20.98	21.08
10	25	25		20.97	21.05	21.02
10	50	0		21.03	20.97	20.99
10	1	0	16-QAM	20.62	20.69	20.80
10	1	25		20.95	21.04	20.92
10	1	49		20.81	20.69	20.63
10	25	0		20.05	20.05	20.17
10	25	12		20.11	20.09	20.09
10	25	25		20.08	20.15	20.12
10	50	0		20.14	20.08	20.10
5	1	0	QPSK	21.88	21.79	21.77
5	1	12		21.99	22.09	21.92
5	1	24		21.59	21.98	21.58
5	12	0		20.95	20.98	20.85
5	12	7		20.99	21.15	20.95
5	12	13		20.85	21.02	20.75
5	25	0		20.93	20.92	20.92
5	1	0	16-QAM	20.77	20.80	20.49
5	1	12		20.90	20.81	20.42
5	1	24		20.67	20.57	20.43
5	12	0		19.78	20.11	19.88
5	12	7		19.92	20.27	20.17
5	12	13		19.96	20.09	19.89
5	25	0		20.12	20.03	19.94



LTE Band 12 Maximum Average Power [dBm]						
BW [MHz]	RB Size	RB Offset	Mod	Lowest	Middle	Highest
3	1	0	QPSK	22.08	21.84	22.04
3	1	8		21.97	21.91	21.62
3	1	14		22.03	21.89	21.49
3	8	0		20.95	20.90	21.10
3	8	4		20.91	21.10	20.84
3	8	7		21.06	21.04	20.82
3	15	0		21.07	21.11	20.83
3	1	0	16-QAM	20.66	20.76	20.60
3	1	8		20.69	20.95	20.57
3	1	14		20.93	20.70	20.63
3	8	0		20.10	20.07	20.02
3	8	4		20.24	20.02	19.93
3	8	7		20.10	20.12	19.72
3	15	0		20.10	20.16	19.81
1.4	1	0	QPSK	22.16	22.07	21.67
1.4	1	3		22.14	22.11	21.89
1.4	1	5		22.15	22.10	21.70
1.4	3	0		22.12	22.11	22.06
1.4	3	1		22.29	22.22	22.04
1.4	3	3		22.24	22.32	21.93
1.4	6	0		21.01	21.25	20.90
1.4	1	0	16-QAM	20.97	20.85	20.74
1.4	1	3		21.06	21.03	20.85
1.4	1	5		20.92	20.91	20.71
1.4	3	0		21.05	21.14	20.84
1.4	3	1		20.96	21.16	20.89
1.4	3	3		21.15	21.29	20.84
1.4	6	0		20.08	20.20	19.85



LTE Band 13 Maximum Average Power [dBm]						
BW [MHz]	RB Size	RB Offset	Mod	Lowest	Middle	Highest
10	1	0	QPSK		22.18	
10	1	25			22.51	
10	1	49			22.24	
10	25	0			21.21	
10	25	12			21.42	
10	25	25			21.40	
10	50	0			21.34	
10	1	0	16-QAM		21.07	
10	1	25			21.28	
10	1	49			21.10	
10	25	0			20.60	
10	25	12			20.70	
10	25	25			20.48	
10	50	0			20.45	
5	1	0	QPSK	21.74	22.24	22.15
5	1	12		22.19	22.33	22.41
5	1	24		22.16	22.43	22.40
5	12	0		21.27	21.36	21.36
5	12	7		21.24	21.43	21.52
5	12	13		21.36	21.35	21.25
5	25	0		21.23	21.36	21.17
5	1	0	16-QAM	20.78	21.20	21.45
5	1	12		20.82	21.43	21.47
5	1	24		21.00	21.10	21.13
5	12	0		20.37	20.39	20.42
5	12	7		20.30	20.53	20.60
5	12	13		20.48	20.54	20.32
5	25	0		20.33	20.47	20.52



LTE Band 17 Maximum Average Power [dBm]						
BW [MHz]	RB Size	RB Offset	Mod	Lowest	Middle	Highest
10	1	0	QPSK	22.50	22.21	22.05
10	1	25		22.27	22.36	22.40
10	1	49		22.34	21.92	21.93
10	25	0		21.44	21.36	21.28
10	25	12		21.50	21.23	21.27
10	25	25		21.32	21.40	21.22
10	50	0		21.51	21.15	21.37
10	1	0	16-QAM	21.25	21.01	20.85
10	1	25		21.37	21.10	21.20
10	1	49		21.21	21.00	21.01
10	25	0		20.53	20.41	20.39
10	25	12		20.51	20.33	20.37
10	25	25		20.53	20.37	20.44
10	50	0		20.60	20.25	20.43
5	1	0	QPSK	22.25	21.92	21.98
5	1	12		22.26	22.24	22.24
5	1	24		21.87	22.35	22.16
5	12	0		21.30	21.24	21.25
5	12	7		21.29	21.19	21.17
5	12	13		21.36	21.25	21.07
5	25	0		21.46	21.16	21.15
5	1	0	16-QAM	21.50	20.98	20.86
5	1	12		21.02	21.30	20.93
5	1	24		20.94	20.79	20.86
5	12	0		20.54	20.28	20.18
5	12	7		20.43	20.47	20.12
5	12	13		20.49	20.32	20.05
5	25	0		20.38	20.27	20.19



LTE Band 41 Maximum Average Power [dBm]						
BW [MHz]	RB Size	RB Offset	Mod	Lowest	Middle	Highest
20	1	0	QPSK	22.25	22.34	22.53
20	1	49		22.88	22.57	22.56
20	1	99		22.54	22.50	22.63
20	50	0		21.71	21.77	21.67
20	50	24		21.74	21.86	21.74
20	50	50		21.73	21.86	21.75
20	100	0		21.68	21.81	21.70
20	1	0	16-QAM	21.20	21.28	21.20
20	1	49		21.49	21.62	21.59
20	1	99		21.28	21.34	21.37
20	50	0		20.69	20.65	20.67
20	50	24		20.73	20.77	20.86
20	50	50		20.81	20.88	20.78
20	100	0		20.76	20.82	20.74
15	1	0	QPSK	22.28	22.36	22.37
15	1	37		22.76	22.87	22.85
15	1	74		22.53	22.69	22.60
15	36	0		21.63	21.74	21.63
15	36	20		21.75	21.94	21.83
15	36	39		21.68	21.86	21.76
15	75	0		21.74	21.82	21.77
15	1	0	16-QAM	21.26	21.41	21.37
15	1	37		21.35	21.48	21.51
15	1	74		21.30	21.40	21.43
15	36	0		20.62	20.70	20.68
15	36	20		20.72	20.99	20.84
15	36	39		20.73	20.93	20.69
15	75	0		20.74	20.83	20.71



LTE Band 41 Maximum Average Power [dBm]						
BW [MHz]	RB Size	RB Offset	Mod	Lowest	Middle	Highest
10	1	0	QPSK	22.28	22.53	22.52
10	1	25		22.27	22.87	22.85
10	1	49		22.44	22.67	22.59
10	25	0		21.46	21.93	21.94
10	25	12		21.46	21.95	21.96
10	25	25		21.64	21.90	21.87
10	50	0		21.59	21.95	21.85
10	1	0	16-QAM	21.16	21.47	21.49
10	1	25		21.33	21.70	21.71
10	1	49		21.19	21.52	21.54
10	25	0		20.77	20.87	20.88
10	25	12		20.68	21.17	21.08
10	25	25		20.84	20.92	21.11
10	50	0		20.57	20.96	20.98
5	1	0	QPSK	22.37	22.73	22.72
5	1	12		22.68	22.78	22.85
5	1	24		22.42	22.82	22.85
5	12	0		21.75	22.11	22.15
5	12	7		21.81	22.09	22.11
5	12	13		21.82	22.18	22.37
5	25	0		21.79	22.11	22.28
5	1	0	16-QAM	21.32	21.59	21.54
5	1	12		21.47	21.67	21.77
5	1	24		21.31	21.62	21.64
5	12	0		20.69	21.15	21.20
5	12	7		20.72	21.04	21.20
5	12	13		20.72	21.00	20.99
5	25	0		20.83	21.06	21.02



ERP/EIRP

LTE Band 2 (GT - LC = 3.0 dBi) QPSK									
Bandwidth	1.4M			3M			5M		
Channel	18607	18900	19193	18615	18900	19185	18625	18900	19175
	(Low)	(Mid)	(High)	(Low)	(Mid)	(High)	(Low)	(Mid)	(High)
Frequency	1850.7	1880	1909.3	1851.5	1880	1908.5	1852.5	1880	1907.5
(MHz)									
Conducted Power (dBm)	21.85	21.79	22.02	21.57	21.45	21.66	21.97	21.82	22.06
Conducted Power (Watts)	0.1531	0.1510	0.1592	0.1435	0.1396	0.1466	0.1574	0.1521	0.1607
EIRP(dBm)	24.85	24.79	25.02	24.57	24.45	24.66	24.97	24.82	25.06
EIRP(Watts)	0.3055	0.3013	0.3177	0.2864	0.2786	0.2924	0.3141	0.3034	0.3206

LTE Band 2 (GT - LC = 3.0 dBi) QPSK									
Bandwidth	10M			15M			20M		
Channel	18650	18900	19150	18675	18900	19125	18650	18900	19100
	(Low)	(Mid)	(High)	(Low)	(Mid)	(High)	(Low)	(Mid)	(High)
Frequency	1855	1880	1905	1857.5	1880	1902.5	1860	1880	1900
(MHz)									
Conducted Power (dBm)	21.89	21.86	21.78	21.87	21.83	22.07	22.08	21.53	22.09
Conducted Power (Watts)	0.1545	0.1535	0.1507	0.1538	0.1524	0.1611	0.1614	0.1422	0.1618
EIRP(dBm)	24.89	24.86	24.78	24.87	24.83	25.07	25.08	24.53	25.09
EIRP(Watts)	0.3083	0.3062	0.3006	0.3069	0.3041	0.3214	0.3221	0.2838	0.3228



LTE Band 2 (GT - LC = 3.0 dBi) 16QAM									
Bandwidth	1.4M			3M			5M		
Channel	18607	18900	19193	18615	18900	19185	18625	18900	19175
	(Low)	(Mid)	(High)	(Low)	(Mid)	(High)	(Low)	(Mid)	(High)
Frequency (MHz)	1850.7	1880	1909.3	1851.5	1880	1908.5	1852.5	1880	1907.5
Conducted Power (dBm)	20.77	20.80	20.93	20.35	20.34	20.53	20.85	20.76	21.21
Conducted Power (Watts)	0.1194	0.1202	0.1239	0.1084	0.1081	0.1130	0.1216	0.1191	0.1321
EIRP(dBm)	23.77	23.80	23.93	23.35	23.34	23.53	23.85	23.76	24.21
EIRP(Watts)	0.2382	0.2399	0.2472	0.2163	0.2158	0.2254	0.2427	0.2377	0.2636

LTE Band 2 (GT - LC = 3.0 dBi) 16QAM									
Bandwidth	10M			15M			20M		
Channel	18650	18900	19150	18675	18900	19125	18650	18900	19100
	(Low)	(Mid)	(High)	(Low)	(Mid)	(High)	(Low)	(Mid)	(High)
Frequency (MHz)	1855	1880	1905	1857.5	1880	1902.5	1860	1880	1900
Conducted Power (dBm)	20.83	20.75	20.91	20.73	20.72	20.78	20.54	20.61	20.51
Conducted Power (Watts)	0.1211	0.1189	0.1233	0.1183	0.1180	0.1197	0.1132	0.1151	0.1125
EIRP(dBm)	23.83	23.75	23.91	23.73	23.72	23.78	23.54	23.61	23.51
EIRP(Watts)	0.2415	0.2371	0.2460	0.2360	0.2355	0.2388	0.2259	0.2296	0.2244



LTE Band 4 (GT - LC = 3.0 dBi) QPSK									
Bandwidth	1.4M			3M			5M		
Channel	19957	20175	20393	19965	20175	20385	19975	20175	20375
	(Low)	(Mid)	(High)	(Low)	(Mid)	(High)	(Low)	(Mid)	(High)
Frequency (MHz)	1710.7	1732.5	1754.3	1711.5	1732.5	1753.5	1712.5	1732.5	1752.5
Conducted Power (dBm)	21.88	22.11	21.90	21.97	21.95	21.82	21.80	21.77	21.96
Conducted Power (Watts)	0.1542	0.1626	0.1549	0.1574	0.1567	0.1521	0.1514	0.1503	0.1570
EIRP(dBm)	24.88	25.11	24.90	24.97	24.95	24.82	24.80	24.77	24.96
EIRP(Watts)	0.3076	0.3243	0.3090	0.3141	0.3126	0.3034	0.3020	0.2999	0.3133

LTE Band 4 (GT - LC = 3.0 dBi) QPSK									
Bandwidth	10M			15M			20M		
Channel	20000	20175	20350	20025	20175	20325	20050	20175	20300
	(Low)	(Mid)	(High)	(Low)	(Mid)	(High)	(Low)	(Mid)	(High)
Frequency (MHz)	1715	1732.5	1750	1717.5	1732.5	1747.5	1720	1732.5	1745
Conducted Power (dBm)	21.91	21.75	21.92	22.00	21.93	21.71	21.91	22.12	22.05
Conducted Power (Watts)	0.1552	0.1496	0.1556	0.1585	0.1560	0.1483	0.1552	0.1629	0.1603
EIRP(dBm)	24.91	24.75	24.92	25.00	24.93	24.71	24.91	25.12	25.05
EIRP(Watts)	0.3097	0.2985	0.3105	0.3162	0.3112	0.2958	0.3097	0.3251	0.3199



LTE Band 4 (GT - LC = 3.0 dBi) 16QAM									
Bandwidth	1.4M			3M			5M		
Channel	19957	20175	20393	19965	20175	20385	19975	20175	20375
	(Low)	(Mid)	(High)	(Low)	(Mid)	(High)	(Low)	(Mid)	(High)
Frequency (MHz)	1710.7	1732.5	1754.3	1711.5	1732.5	1753.5	1712.5	1732.5	1752.5
Conducted Power (dBm)	21.09	20.89	20.88	21.11	20.95	20.66	20.67	20.44	21.16
Conducted Power (Watts)	0.1285	0.1227	0.1225	0.1291	0.1245	0.1164	0.1167	0.1107	0.1306
EIRP(dBm)	24.09	23.89	23.88	24.11	23.95	23.66	23.67	23.44	24.16
EIRP(Watts)	0.2564	0.2449	0.2443	0.2576	0.2483	0.2323	0.2328	0.2208	0.2606

LTE Band 4 (GT - LC = 3.0 dBi) 16QAM									
Bandwidth	10M			15M			20M		
Channel	20000	20175	20350	20025	20175	20325	20050	20175	20300
	(Low)	(Mid)	(High)	(Low)	(Mid)	(High)	(Low)	(Mid)	(High)
Frequency (MHz)	1715	1732.5	1750	1717.5	1732.5	1747.5	1720	1732.5	1745
Conducted Power (dBm)	20.58	20.70	20.72	20.71	20.52	20.41	20.35	20.58	20.68
Conducted Power (Watts)	0.1143	0.1175	0.1180	0.1178	0.1127	0.1099	0.1084	0.1143	0.1169
EIRP(dBm)	23.58	23.70	23.72	23.71	23.52	23.41	23.35	23.58	23.68
EIRP(Watts)	0.2280	0.2344	0.2355	0.2350	0.2249	0.2193	0.2163	0.2280	0.2333



LTE Band 5 (GT - LC = 3.0 dBi) QPSK									
Bandwidth	1.4M			3M			5M		
Channel	20407	20525	20643	20415	20525	20635	20425	20525	20625
	(Low)	(Mid)	(High)	(Low)	(Mid)	(High)	(Low)	(Mid)	(High)
Frequency (MHz)	824.7	836.5	848.3	825.5	836.5	847.5	826.5	836.5	846.5
Conducted Power (dBm)	22.41	22.25	22.25	22.14	22.23	22.16	22.14	22.00	21.96
Conducted Power (Watts)	0.1742	0.1679	0.1679	0.1637	0.1671	0.1644	0.1637	0.1585	0.1570
ERP(dBm)	23.26	23.10	23.10	22.99	23.08	23.01	22.99	22.85	22.81
ERP(Watts)	0.2118	0.2042	0.2042	0.1991	0.2032	0.2000	0.1991	0.1928	0.1910

LTE Band 5 (GT - LC = 3.0 dBi) QPSK			
Bandwidth	10M		
Channel	20450	20525	20600
	(Low)	(Mid)	(High)
Frequency (MHz)	829	836.5	844
Conducted Power (dBm)	22.12	21.94	22.42
Conducted Power (Watts)	0.1629	0.1563	0.1746
ERP(dBm)	22.97	22.79	23.27
ERP(Watts)	0.1982	0.1901	0.2123



LTE Band 5 (GT - LC = 3.0 dBi) 16QAM									
Bandwidth	1.4M			3M			5M		
Channel	20407	20525	20643	20415	20525	20635	20425	20525	20625
	(Low)	(Mid)	(High)	(Low)	(Mid)	(High)	(Low)	(Mid)	(High)
Frequency (MHz)	824.7	836.5	848.3	825.5	836.5	847.5	826.5	836.5	846.5
Conducted Power (dBm)	21.35	21.09	21.09	20.94	20.92	20.88	20.64	20.75	20.88
Conducted Power (Watts)	0.1365	0.1285	0.1285	0.1242	0.1236	0.1225	0.1159	0.1189	0.1225
ERP(dBm)	22.20	21.94	21.94	21.79	21.77	21.73	21.49	21.60	21.73
ERP(Watts)	0.1660	0.1563	0.1563	0.1510	0.1503	0.1489	0.1409	0.1445	0.1489

LTE Band 5 (GT - LC = 3.0 dBi) 16QAM			
Bandwidth	10M		
Channel	20450	20525	20600
	(Low)	(Mid)	(High)
Frequency (MHz)	829	836.5	844
Conducted Power (dBm)	20.83	20.78	20.79
Conducted Power (Watts)	0.1211	0.1197	0.1199
ERP(dBm)	21.68	21.63	21.64
ERP(Watts)	0.1472	0.1455	0.1459



LTE Band 12 (GT - LC = 3.0 dBi) QPSK									
Bandwidth	1.4M			3M			5M		
Channel	23017	23095	23173	23025	23095	23165	23035	23095	23155
	(Low)	(Mid)	(High)	(Low)	(Mid)	(High)	(Low)	(Mid)	(High)
Frequency (MHz)	699.7	707.5	715.3	700.5	707.5	714.5	701.5	707.5	713.5
Conducted Power (dBm)	22.24	22.32	21.93	22.08	21.84	22.04	21.99	22.09	21.92
Conducted Power (Watts)	0.1675	0.1706	0.1560	0.1614	0.1528	0.1600	0.1581	0.1618	0.1556
ERP(dBm)	23.09	23.17	22.78	22.93	22.69	22.89	22.84	22.94	22.77
ERP(Watts)	0.2037	0.2075	0.1897	0.1963	0.1858	0.1945	0.1923	0.1968	0.1892

LTE Band 12 (GT - LC = 3.0 dBi) QPSK			
Bandwidth	10M		
Channel	23060	23095	23130
	(Low)	(Mid)	(High)
Frequency (MHz)	704	707.5	711
Conducted Power (dBm)	22.15	22.35	22.11
Conducted Power (Watts)	0.1641	0.1718	0.1626
ERP(dBm)	23.00	23.20	22.96
ERP(Watts)	0.1995	0.2089	0.1977



LTE Band 12 (GT - LC = 3.0 dBi) 16QAM									
Bandwidth	1.4M			3M			5M		
Channel	23017	23095	23173	23025	23095	23165	23035	23095	23155
	(Low)	(Mid)	(High)	(Low)	(Mid)	(High)	(Low)	(Mid)	(High)
Frequency (MHz)	699.7	707.5	715.3	700.5	707.5	714.5	701.5	707.5	713.5
Conducted Power (dBm)	21.15	21.29	20.84	20.69	20.95	20.57	20.90	20.81	20.42
Conducted Power (Watts)	0.1303	0.1346	0.1213	0.1172	0.1245	0.1140	0.1230	0.1205	0.1102
ERP(dBm)	22.00	22.14	21.69	21.54	21.80	21.42	21.75	21.66	21.27
ERP(Watts)	0.1585	0.1637	0.1476	0.1426	0.1514	0.1387	0.1496	0.1466	0.1340

LTE Band 12 (GT - LC = 3.0 dBi) 16QAM			
Bandwidth	10M		
Channel	23060	23095	23130
	(Low)	(Mid)	(High)
Frequency (MHz)	704	707.5	711
Conducted Power (dBm)	20.95	21.04	20.92
Conducted Power (Watts)	0.1245	0.1271	0.1236
ERP(dBm)	21.80	21.89	21.77
ERP(Watts)	0.1514	0.1545	0.1503



LTE Band 13 (GT - LC = 3.0 dBi) QPSK						
Bandwidth	5M			10M		
Channel	23205	23230	23255	23230		
	(Low)	(Mid)	(High)	-	(Mid)	-
Frequency	779.5	782	784.5	-	782	-
(MHz)						
Conducted Power (dBm)	22.16	22.43	22.40	-	22.51	-
Conducted Power (Watts)	0.1644	0.1750	0.1738	-	0.1782	-
ERP(dBm)	23.01	23.28	23.25	-	23.36	-
ERP(Watts)	0.2000	0.2128	0.2113	-	0.2168	-

LTE Band 13 (GT - LC = 3.0 dBi) 16QAM						
Bandwidth	5M			10M		
Channel	23205	23230	23255	23230		
	(Low)	(Mid)	(High)	-	(Mid)	-
Frequency	779.5	782	784.5	-	782	-
(MHz)						
Conducted Power (dBm)	20.82	21.43	21.47	-	21.28	-
Conducted Power (Watts)	0.1208	0.1390	0.1403	-	0.1343	-
ERP(dBm)	21.67	22.28	22.32	-	22.13	-
ERP(Watts)	0.1469	0.1690	0.1706	-	0.1633	-



LTE Band 17 (GT - LC = 3.0 dBi) QPSK						
Bandwidth	5M			10M		
Channel	23755	23790	23825	23780	23790	23800
	(Low)	(Mid)	(High)	(Low)	(Mid)	(High)
Frequency	706.5	710	713.5	709	710	711
(MHz)						
Conducted Power (dBm)	21.87	22.35	22.16	22.50	22.21	22.05
Conducted Power (Watts)	0.1538	0.1718	0.1644	0.1778	0.1663	0.1603
ERP(dBm)	22.72	23.20	23.01	23.35	23.06	22.90
ERP(Watts)	0.1871	0.2089	0.2000	0.2163	0.2023	0.1950

LTE Band 17 (GT - LC = 3.0 dBi) 16QAM						
Bandwidth	5M			10M		
Channel	23755	23790	23825	23780	23790	23800
	(Low)	(Mid)	(High)	(Low)	(Mid)	(High)
Frequency	706.5	710	713.5	709	710	711
(MHz)						
Conducted Power (dBm)	21.50	20.98	20.86	21.37	21.10	21.20
Conducted Power (Watts)	0.1413	0.1253	0.1219	0.1371	0.1288	0.1318
ERP(dBm)	22.35	21.83	21.71	22.22	21.95	22.05
ERP(Watts)	0.1718	0.1524	0.1483	0.1667	0.1567	0.1603



LTE Band 25 (GT - LC = 3.0 dBi) QPSK									
Bandwidth	1.4M			3M			5M		
Channel	26407	26340	26683	26055	26340	26675	26065	26340	26665
	(Low)	(Mid)	(High)	(Low)	(Mid)	(High)	(Low)	(Mid)	(High)
Frequency (MHz)	1850.7	1880	1914.3	1851.5	1880	1913.5	1852.5	1880	1912.5
Conducted Power (dBm)	21.99	22.02	22.27	21.62	21.79	22.05	21.70	21.61	22.36
Conducted Power (Watts)	0.1581	0.1592	0.1687	0.1452	0.1510	0.1603	0.1479	0.1449	0.1722
EIRP(dBm)	24.99	25.02	25.27	24.62	24.79	25.05	24.70	24.61	25.36
EIRP(Watts)	0.3155	0.3177	0.3365	0.2897	0.3013	0.3199	0.2951	0.2891	0.3436

LTE Band 25 (GT - LC = 3.0 dBi) QPSK									
Bandwidth	10M			15M			20M		
Channel	26090	26340	26640	26115	26340	26615	26140	26340	26590
	(Low)	(Mid)	(High)	(Low)	(Mid)	(High)	(Low)	(Mid)	(High)
Frequency (MHz)	1855	1880	1910	1857.5	1880	1907.5	1860	1880	1905
Conducted Power (dBm)	21.74	21.89	22.10	21.78	21.64	21.91	21.99	22.37	22.05
Conducted Power (Watts)	0.1493	0.1545	0.1622	0.1507	0.1459	0.1552	0.1581	0.1726	0.1603
EIRP(dBm)	24.74	24.89	25.10	24.78	24.64	24.91	24.99	25.37	25.05
EIRP(Watts)	0.2979	0.3083	0.3236	0.3006	0.2911	0.3097	0.3155	0.3443	0.3199



LTE Band 25 (GT - LC = 3.0 dBi) 16QAM									
Bandwidth	1.4M			3M			5M		
Channel	26407	26340	26683	26055	26340	26675	26065	26340	26665
	(Low)	(Mid)	(High)	(Low)	(Mid)	(High)	(Low)	(Mid)	(High)
Frequency (MHz)	1850.7	1880	1914.3	1851.5	1880	1913.5	1852.5	1880	1912.5
Conducted Power (dBm)	20.84	20.91	21.31	20.64	20.80	20.89	20.24	20.53	20.76
Conducted Power (Watts)	0.1213	0.1233	0.1352	0.1159	0.1202	0.1227	0.1057	0.1130	0.1191
EIRP(dBm)	23.84	23.91	24.31	23.64	23.80	23.89	23.24	23.53	23.76
EIRP(Watts)	0.2421	0.2460	0.2698	0.2312	0.2399	0.2449	0.2109	0.2254	0.2377

LTE Band 25 (GT - LC = 3.0 dBi) 16QAM									
Bandwidth	10M			15M			20M		
Channel	26090	26340	26640	26115	26340	26615	26140	26340	26590
	(Low)	(Mid)	(High)	(Low)	(Mid)	(High)	(Low)	(Mid)	(High)
Frequency (MHz)	1855	1880	1910	1857.5	1880	1907.5	1860	1880	1905
Conducted Power (dBm)	20.55	20.71	20.95	20.60	20.78	20.80	20.71	20.74	20.84
Conducted Power (Watts)	0.1135	0.1178	0.1245	0.1148	0.1197	0.1202	0.1178	0.1186	0.1213
EIRP(dBm)	23.55	23.71	23.95	23.60	23.78	23.80	23.71	23.74	23.84
EIRP(Watts)	0.2265	0.2350	0.2483	0.2291	0.2388	0.2399	0.2350	0.2366	0.2421



LTE Band 26 (GT - LC = 3.0 dBi) QPSK									
Bandwidth	1.4M			3M			5M		
Channel	26797	26915	27033	26805	26915	27025	26815	26915	27015
	(Low)	(Mid)	(High)	(Low)	(Mid)	(High)	(Low)	(Mid)	(High)
Frequency	824.7	836.5	848.3	825.5	836.5	847.5	826.5	836.5	846.5
(MHz)									
Conducted Power (dBm)	21.81	21.76	22.12	21.82	21.73	22.05	22.22	22.07	21.90
Conducted Power (Watts)	0.1517	0.1500	0.1629	0.1521	0.1489	0.1603	0.1667	0.1611	0.1549
ERP(dBm)	22.66	22.61	22.97	22.67	22.58	22.90	23.07	22.92	22.75
ERP(Watts)	0.1845	0.1824	0.1982	0.1849	0.1811	0.1950	0.2028	0.1959	0.1884

LTE Band 26 (GT - LC = 3.0 dBi) QPSK							
Bandwidth	10M			15M			15M
Channel	26840	26915	26990	26865	26915	26965	26765
	(Low)	(Mid)	(High)	(Low)	(Mid)	(High)	(Low)
Frequency	829	836.5	844	831.5	836.5	841.5	821.5
(MHz)							
Conducted Power (dBm)	22.05	22.12	22.24	22.34	22.35	22.35	22.34
Conducted Power (Watts)	0.1603	0.1629	0.1675	0.1714	0.1718	0.1718	0.1714
ERP(dBm)	22.90	22.97	23.09	23.19	23.20	23.20	23.19
ERP(Watts)	0.1950	0.1982	0.2037	0.2084	0.2089	0.2089	0.2084



LTE Band 26 (GT - LC = 3.0 dBi) 16QAM									
Bandwidth	1.4M			3M			5M		
Channel	26797	26915	27033	26805	26915	27025	26815	26915	27015
	(Low)	(Mid)	(High)	(Low)	(Mid)	(High)	(Low)	(Mid)	(High)
Frequency	824.7	836.5	848.3	825.5	836.5	847.5	826.5	836.5	846.5
(MHz)									
Conducted Power (dBm)	20.60	20.66	20.88	20.60	20.50	20.66	20.93	21.11	20.63
Conducted Power (Watts)	0.1148	0.1164	0.1225	0.1148	0.1122	0.1164	0.1239	0.1291	0.1156
ERP(dBm)	21.45	21.51	21.73	21.45	21.35	21.51	21.78	21.96	21.48
ERP(Watts)	0.1396	0.1416	0.1489	0.1396	0.1365	0.1416	0.1507	0.1570	0.1406

LTE Band 26 (GT - LC = 3.0 dBi) 16QAM							
Bandwidth	10M			15M			15M
Channel	26840	26915	26990	26865	26915	26965	26765
	(Low)	(Mid)	(High)	(Low)	(Mid)	(High)	(Low)
Frequency	829	836.5	844	831.5	836.5	841.5	821.5
(MHz)							
Conducted Power (dBm)	20.82	20.67	20.93	20.91	20.69	20.88	20.91
Conducted Power (Watts)	0.1208	0.1167	0.1239	0.1233	0.1172	0.1225	0.1233
ERP(dBm)	21.67	21.52	21.78	21.76	21.54	21.73	21.76
ERP(Watts)	0.1469	0.1419	0.1507	0.1500	0.1426	0.1489	0.1500



LTE Band 41 (G _T - L _C = 3.0 dBi) QPSK									
Bandwidth	5M			10M			15M		
Channel	40265	40905	41215	40290	40890	41190	40315	40885	41165
	(Low)	(Mid)	(High)	(Low)	(Mid)	(High)	(Low)	(Mid)	(High)
Frequency	2557.5	2621.5	2652.5	2560	2620	2650	2562.5	2619.5	2647.5
(MHz)									
Conducted Power (dBm)	22.68	22.78	22.85	22.27	22.87	22.85	22.76	22.87	22.85
Conducted Power (Watts)	0.1854	0.1897	0.1928	0.1687	0.1936	0.1928	0.1888	0.1936	0.1928
EIRP(dBm)	25.68	25.78	25.85	25.27	25.87	25.85	25.76	25.87	25.85
EIRP(Watts)	0.3698	0.3784	0.3846	0.3365	0.3864	0.3846	0.3767	0.3864	0.3846

LTE Band 41 (G _T - L _C = 3.0 dBi) QPSK			
Bandwidth	20M		
Channel	40340	40870	41140
	(Low)	(Mid)	(High)
Frequency	2565	2618	2645
(MHz)			
Conducted Power (dBm)	22.88	22.57	22.56
Conducted Power (Watts)	0.1941	0.1807	0.1803
EIRP(dBm)	25.88	25.57	25.56
EIRP(Watts)	0.3873	0.3606	0.3597



LTE Band 41 (G _T - L _C = 3.0 dBi) 16QAM									
Bandwidth	5M			10M			15M		
Channel	40265	40905	41215	40290	40890	41190	40315	40885	41165
	(Low)	(Mid)	(High)	(Low)	(Mid)	(High)	(Low)	(Mid)	(High)
Frequency (MHz)	2557.5	2621.5	2652.5	2560	2620	2650	2562.5	2619.5	2647.5
Conducted Power (dBm)	21.47	21.67	21.77	21.33	21.70	21.71	21.35	21.48	21.51
Conducted Power (Watts)	0.1403	0.1469	0.1503	0.1358	0.1479	0.1483	0.1365	0.1406	0.1416
EIRP(dBm)	24.47	24.67	24.77	24.33	24.70	24.71	24.35	24.48	24.51
EIRP(Watts)	0.2799	0.2931	0.2999	0.2710	0.2951	0.2958	0.2723	0.2805	0.2825

LTE Band 41 (G _T - L _C = 3.0 dBi) 16QAM			
Bandwidth	20M		
Channel	40340	40870	41140
	(Low)	(Mid)	(High)
Frequency (MHz)	2565	2618	2645
Conducted Power (dBm)	21.49	21.62	21.59
Conducted Power (Watts)	0.1409	0.1452	0.1442
EIRP(dBm)	24.49	24.62	24.59
EIRP(Watts)	0.2812	0.2897	0.2877



Peak-to-Average Ratio

Mode	LTE Band 2 / 20MHz				
Mod.	QPSK		16QAM		Limit: 13dB
RB Size	1RB	Full RB	1RB	Full RB	Result
Lowest CH	4.20	4.90	5.13	5.83	PASS
Middle CH	4.64	4.72	5.36	5.86	
Highest CH	4.49	4.78	5.25	5.86	

Mode	LTE Band 4 / 20MHz				
Mod.	QPSK		16QAM		Limit: 13dB
RB Size	1RB	Full RB	1RB	Full RB	Result
Lowest CH	4.32	4.96	4.90	5.97	PASS
Middle CH	4.64	4.99	5.39	6.00	
Highest CH	4.46	4.81	5.16	5.86	

Mode	LTE Band 5 / 10MHz				
Mod.	QPSK		16QAM		Limit: 13dB
RB Size	1RB	Full RB	1RB	Full RB	Result
Lowest CH	4.67	5.13	5.48	5.88	PASS
Middle CH	4.78	5.01	5.42	5.86	
Highest CH	4.75	4.93	5.59	5.83	

Mode	LTE Band 12 / 10MHz				
Mod.	QPSK		16QAM		Limit: 13dB
RB Size	1RB	Full RB	1RB	Full RB	Result
Lowest CH	4.52	4.72	5.16	5.65	PASS
Middle CH	4.29	4.90	4.96	5.74	
Highest CH	4.46	4.78	5.07	5.77	

Mode	LTE Band 13 / 10MHz				
Mod.	QPSK		16QAM		Limit: 13dB
RB Size	1RB	Full RB	1RB	Full RB	Result
Lowest CH	-	-	-	-	PASS
Middle CH	3.80	4.75	4.78	5.42	
Highest CH	-	-	-	-	



Mode	LTE Band 17 / 10MHz				
Mod.	QPSK		16QAM		Limit: 13dB
RB Size	1RB	Full RB	1RB	Full RB	Result
Lowest CH	4.29	4.96	4.87	5.71	PASS
Middle CH	4.46	4.84	5.36	5.83	
Highest CH	4.46	4.75	5.45	5.65	

Mode	LTE Band 25 / 20MHz				
Mod.	QPSK		16QAM		Limit: 13dB
RB Size	1RB	Full RB	1RB	Full RB	Result
Lowest CH	4.09	4.81	4.81	5.77	PASS
Middle CH	4.41	4.58	5.33	5.71	
Highest CH	4.41	4.75	5.16	5.74	

Mode	LTE Band 26 / 15MHz				
Mod.	QPSK		16QAM		Limit: 13dB
RB Size	1RB	Full RB	1RB	Full RB	Result
Lowest CH	4.49	5.07	5.48	5.94	PASS
Middle CH	4.61	4.99	5.51	5.88	
Highest CH	4.67	5.01	5.57	5.91	

Mode	LTE Band 41 / 20MHz				
Mod.	QPSK		16QAM		Limit: 13dB
RB Size	1RB	Full RB	1RB	Full RB	Result
Lowest CH	5.19	5.77	5.28	7.22	PASS
Middle CH	5.59	5.01	5.13	6.12	
Highest CH	5.22	5.36	5.30	5.71	



LTE Band 2 / 20MHz / QPSK

Lowest Channel / 1RB

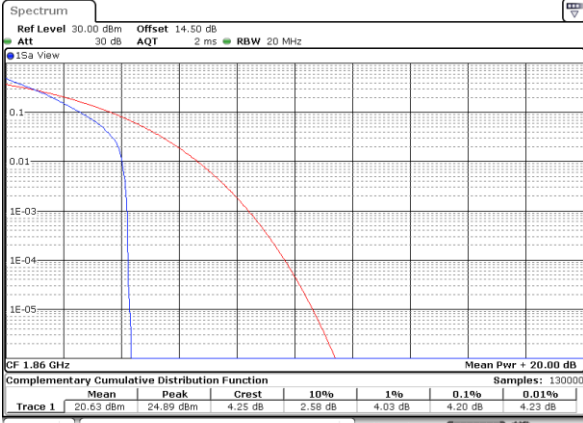

Date: 10.APR.2018 08:51:26

Lowest Channel / Full RB

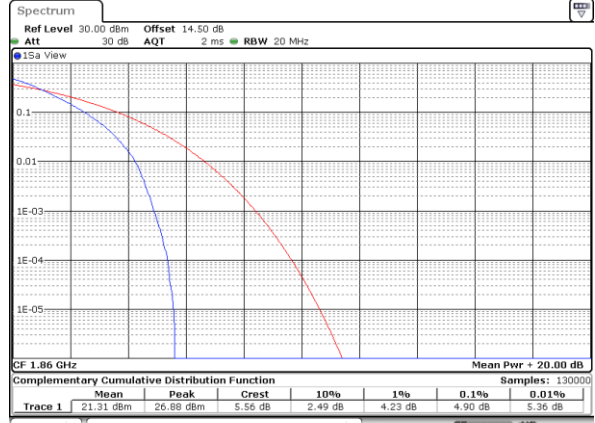

Date: 10.APR.2018 08:51:35

Middle Channel / 1RB

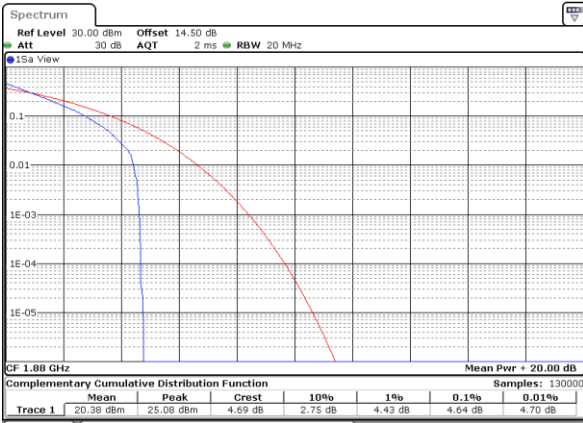

Date: 10.APR.2018 08:51:44

Middle Channel / Full RB

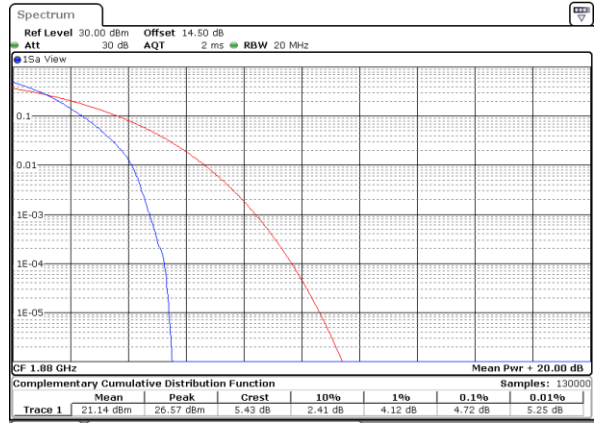

Date: 10.APR.2018 08:51:53

Highest Channel / 1RB

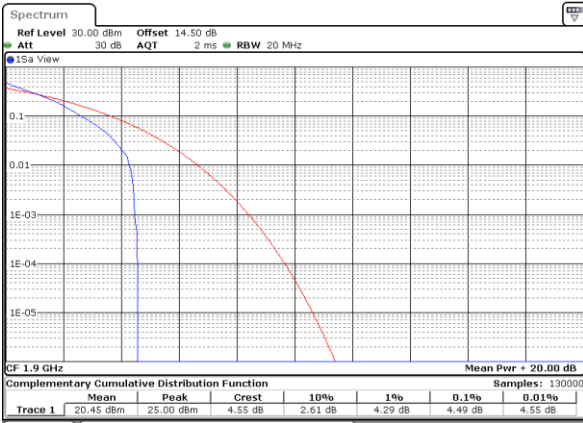

Date: 10.APR.2018 08:52:02

Highest Channel / Full RB

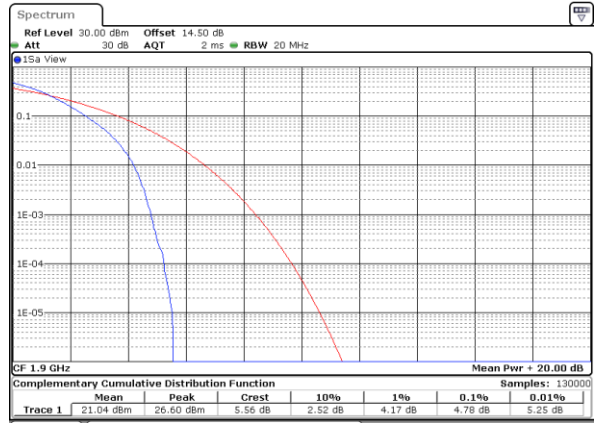

Date: 10.APR.2018 08:52:29



LTE Band 2 / 20MHz / 16QAM

Lowest Channel / 1RB

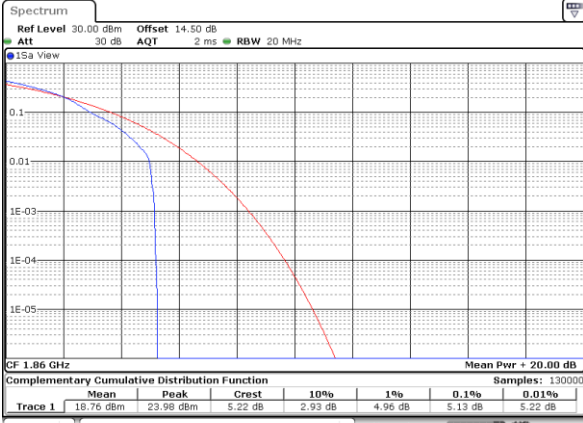

Date: 10.APR.2018 08:53:00

Lowest Channel / Full RB

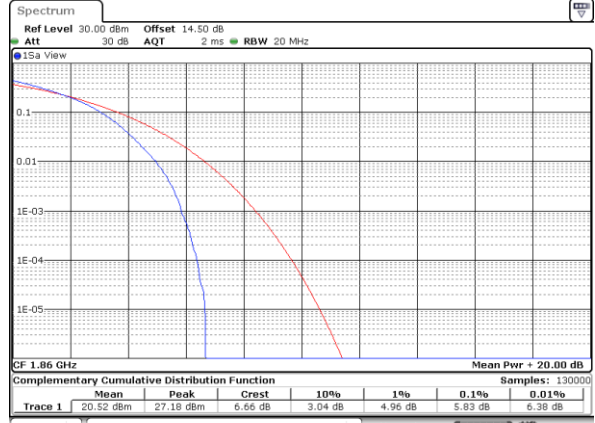

Date: 10.APR.2018 08:50:39

Middle Channel / 1RB

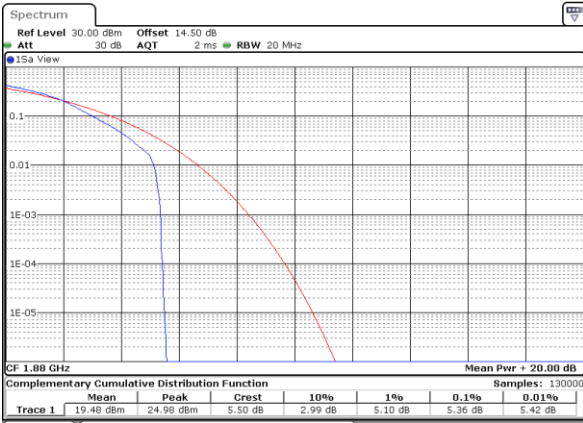

Date: 10.APR.2018 08:50:49

Middle Channel / Full RB

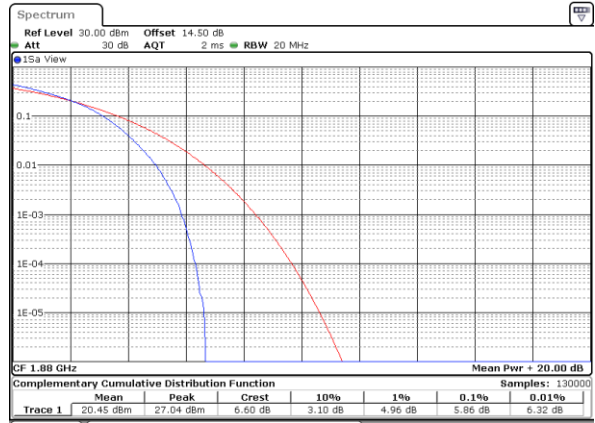

Date: 10.APR.2018 08:50:58

Highest Channel / 1RB

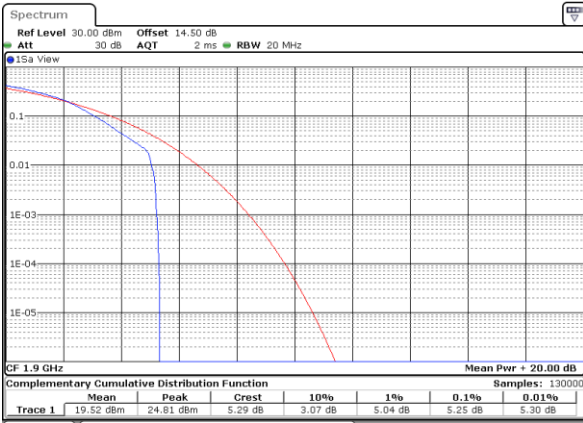

Date: 10.APR.2018 08:51:07

Highest Channel / Full RB

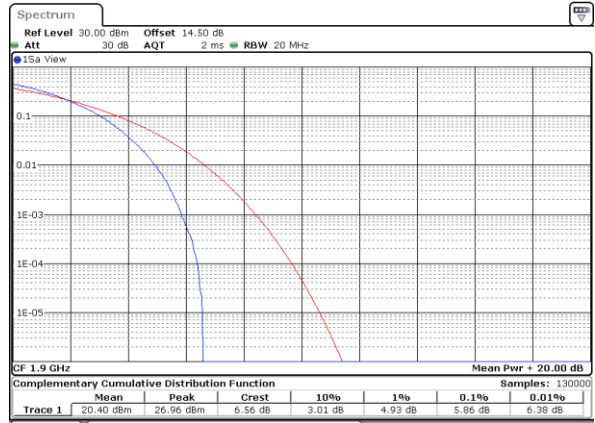

Date: 10.APR.2018 08:51:16



LTE Band 4 / 20MHz / QPSK

Lowest Channel / 1RB

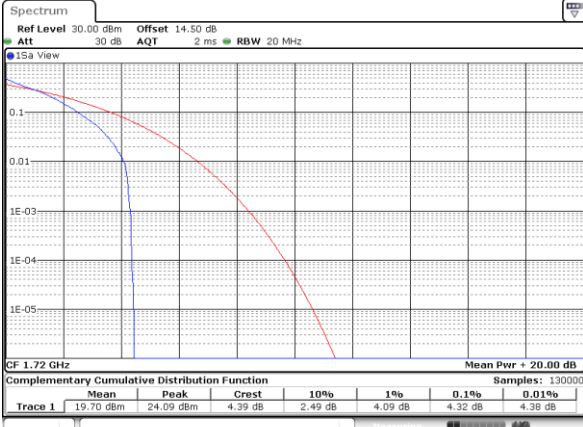

Date: 10.APR.2018 13:37:57

Lowest Channel / Full RB

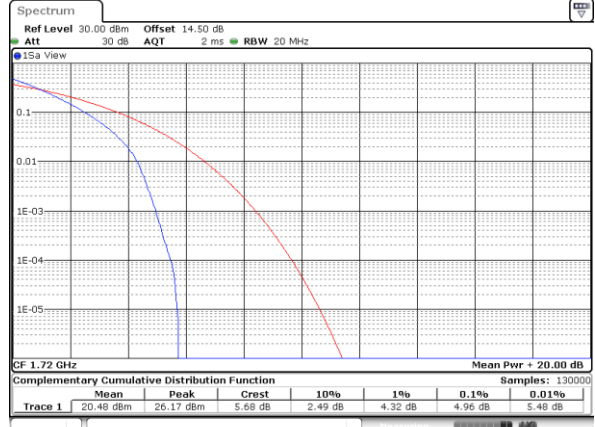

Date: 10.APR.2018 13:38:07

Middle Channel / 1RB

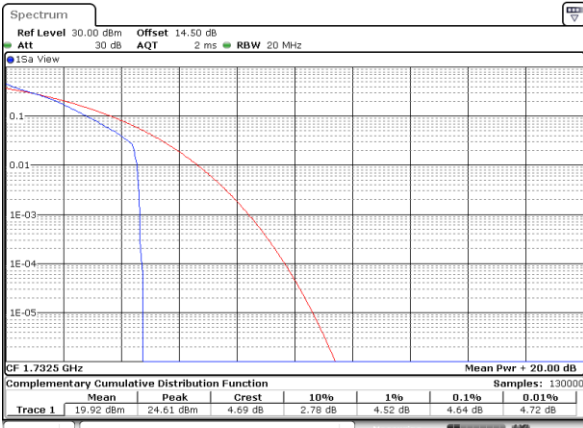

Date: 10.APR.2018 13:38:17

Middle Channel / Full RB

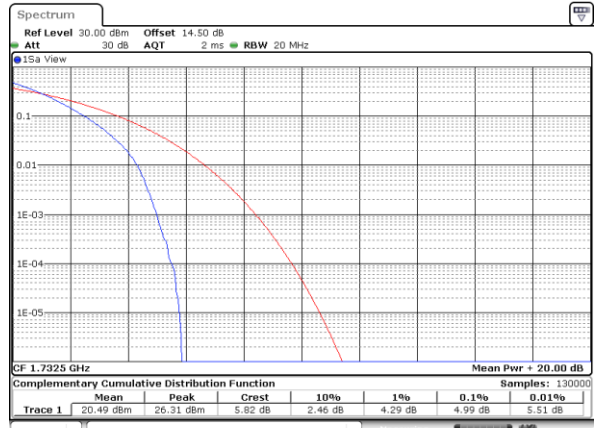

Date: 10.APR.2018 13:38:26

Highest Channel / 1RB

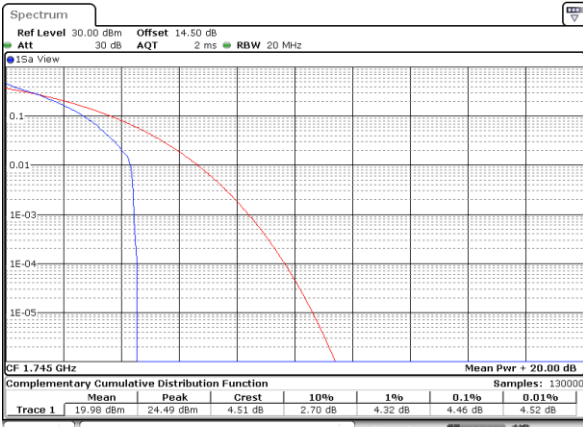

Date: 10.APR.2018 13:41:10

Highest Channel / Full RB

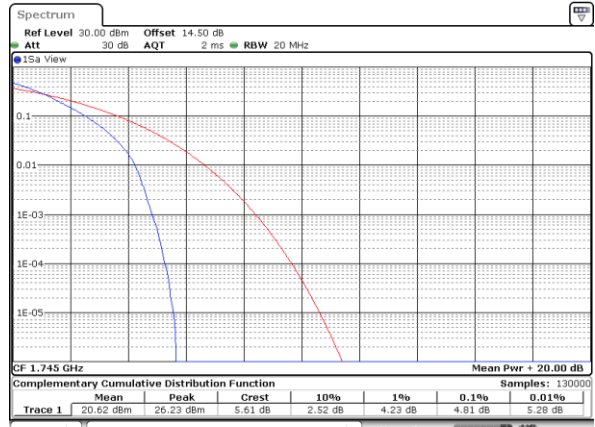

Date: 10.APR.2018 13:41:19



LTE Band 4 / 20MHz / 16QAM

Lowest Channel / 1RB

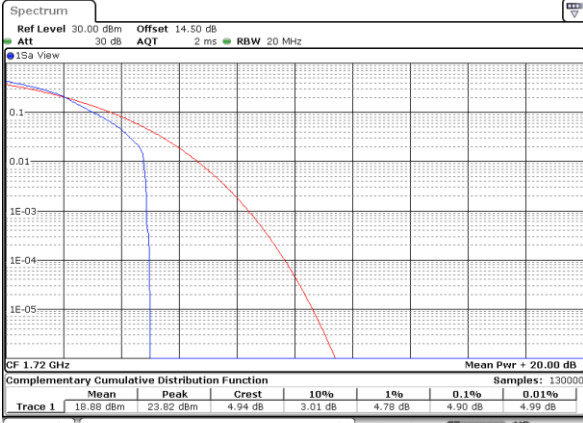

Date: 10.APR.2018 14:36:49

Lowest Channel / Full RB

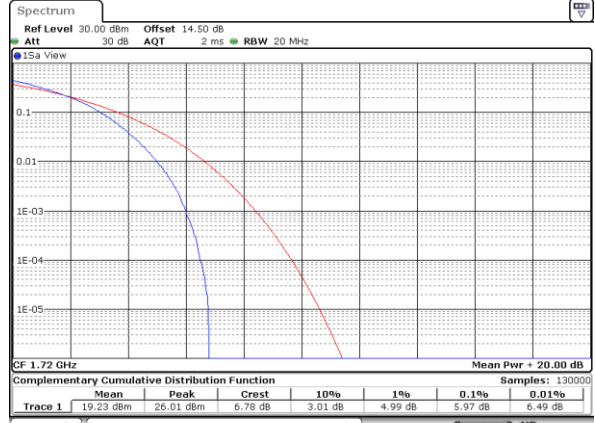

Date: 10.APR.2018 13:57:06

Middle Channel / 1RB

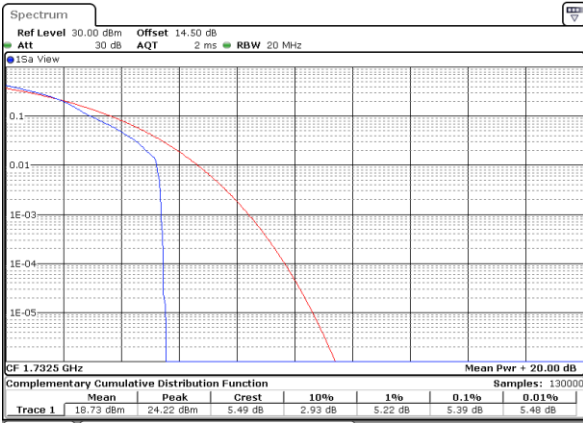

Date: 10.APR.2018 14:39:02

Middle Channel / Full RB

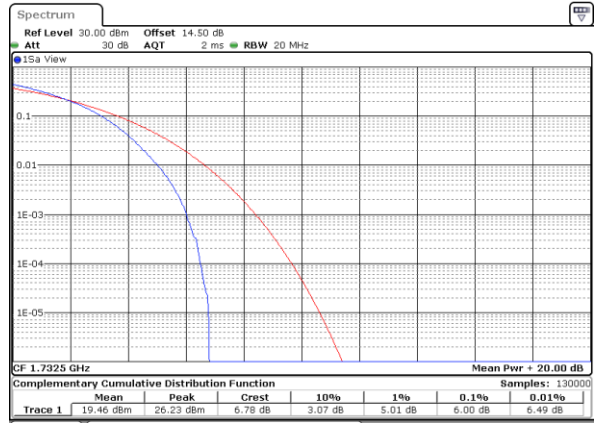

Date: 10.APR.2018 13:57:29

Highest Channel / 1RB

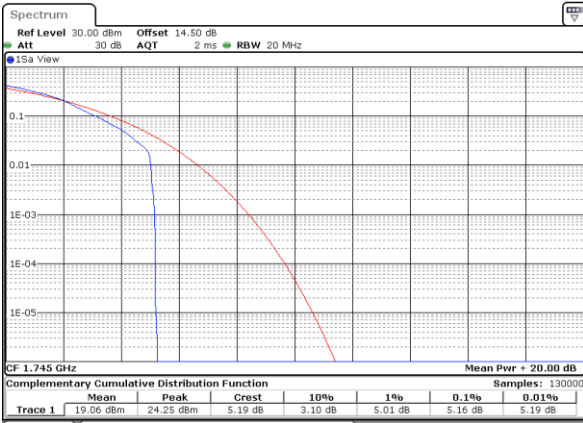

Date: 10.APR.2018 14:39:37

Highest Channel / Full RB

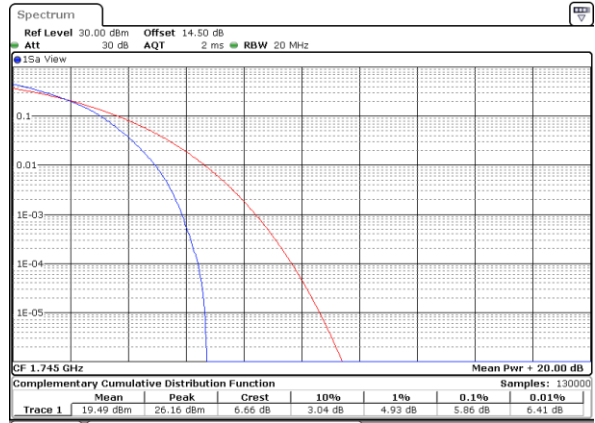

Date: 10.APR.2018 13:57:47



LTE Band 5 / 10MHz / QPSK

Lowest Channel / 1RB

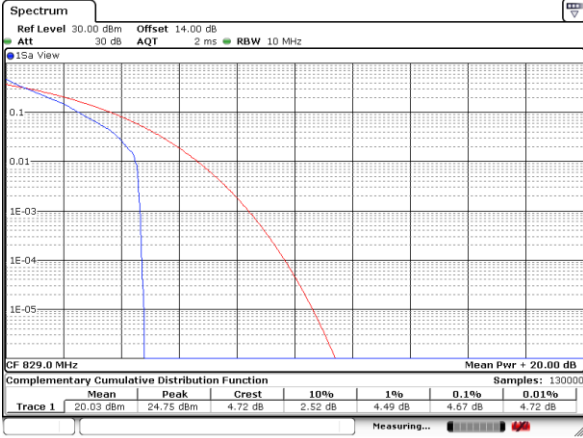

Date: 10.APR.2018 10:31:20

Lowest Channel / Full RB

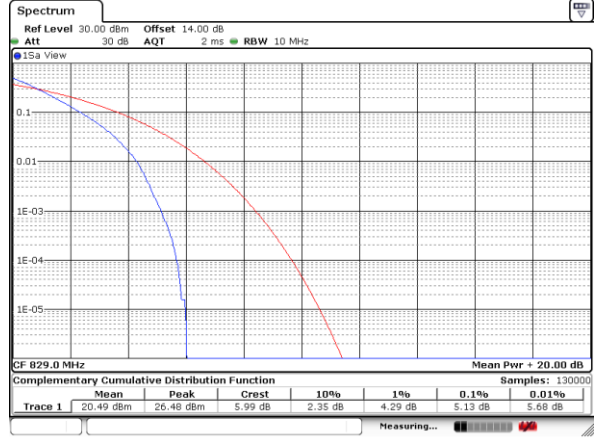

Date: 10.APR.2018 10:31:31

Middle Channel / 1RB

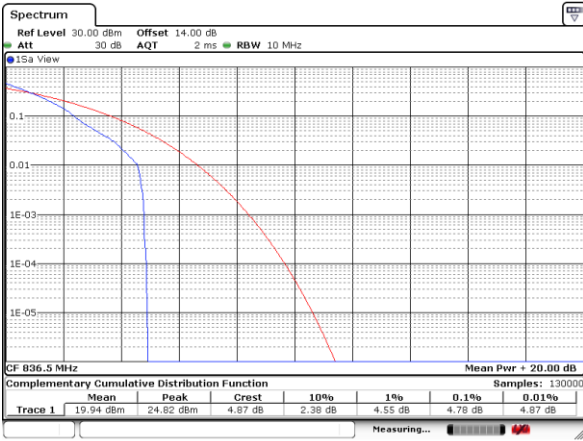

Date: 10.APR.2018 10:31:42

Middle Channel / Full RB

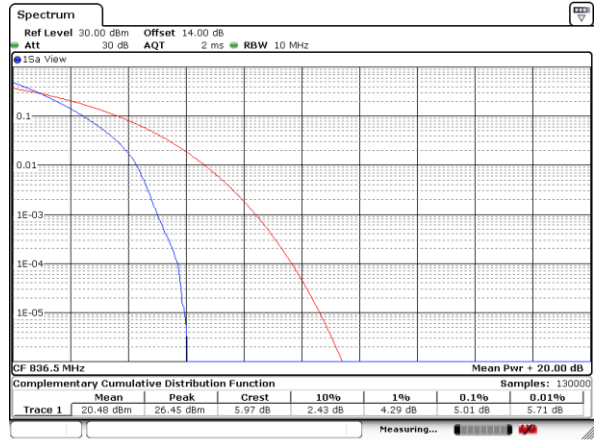

Date: 10.APR.2018 10:31:51

Highest Channel / 1RB

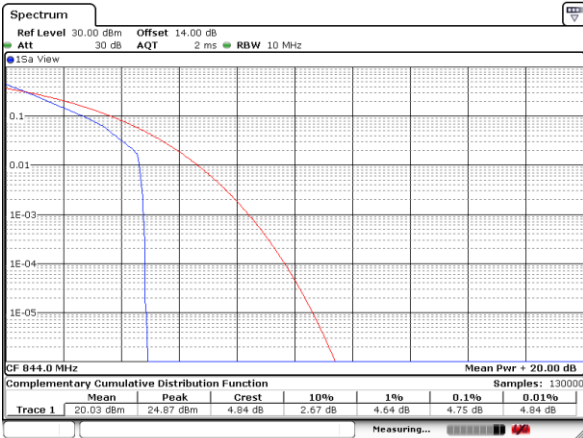

Date: 10.APR.2018 10:32:01

Highest Channel / Full RB

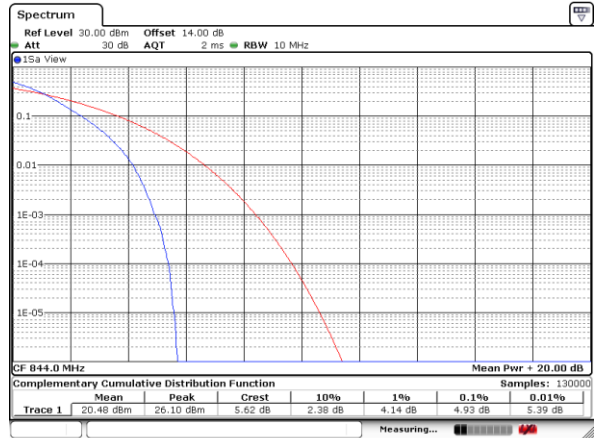

Date: 10.APR.2018 10:32:11



LTE Band 5 / 10MHz / 16QAM

Lowest Channel / 1RB

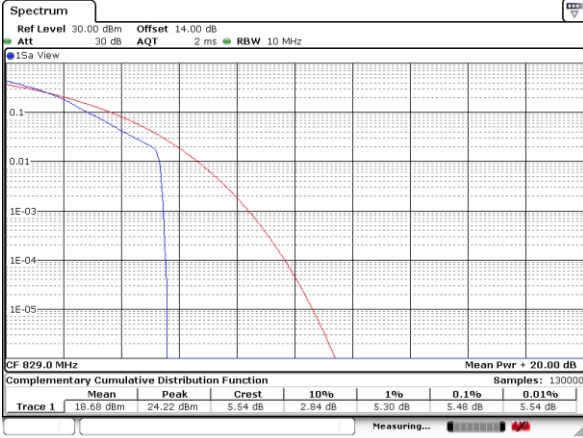

Date: 10.APR.2018 10:30:19

Lowest Channel / Full RB

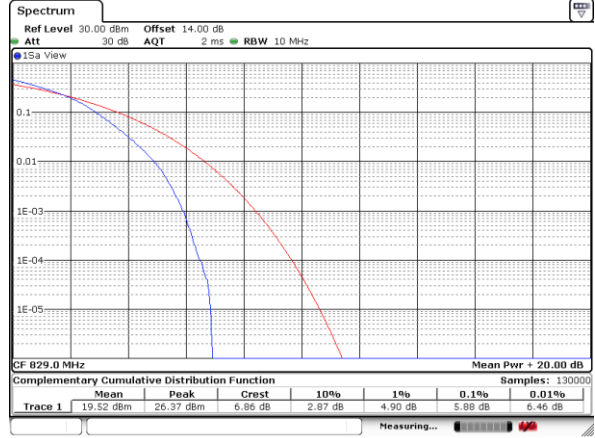

Date: 10.APR.2018 10:30:31

Middle Channel / 1RB

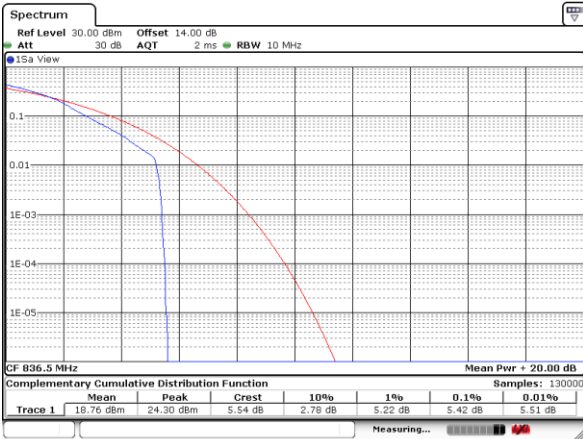

Date: 10.APR.2018 10:30:42

Middle Channel / Full RB

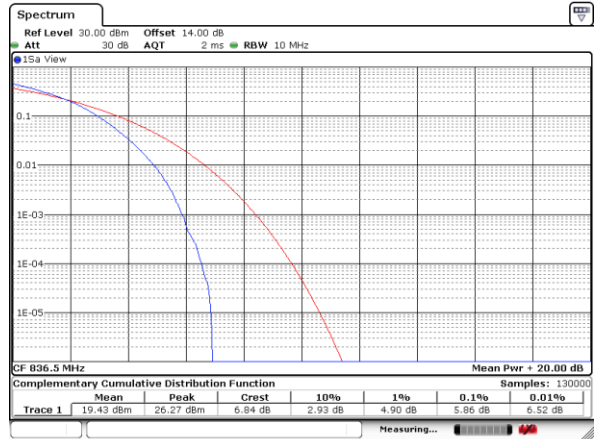

Date: 10.APR.2018 10:30:51

Highest Channel / 1RB

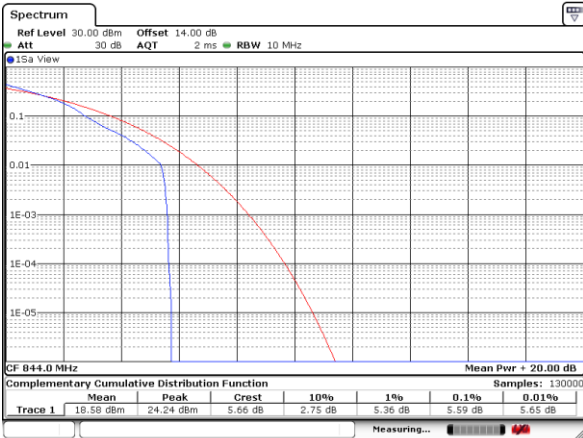

Date: 10.APR.2018 10:31:00

Highest Channel / Full RB

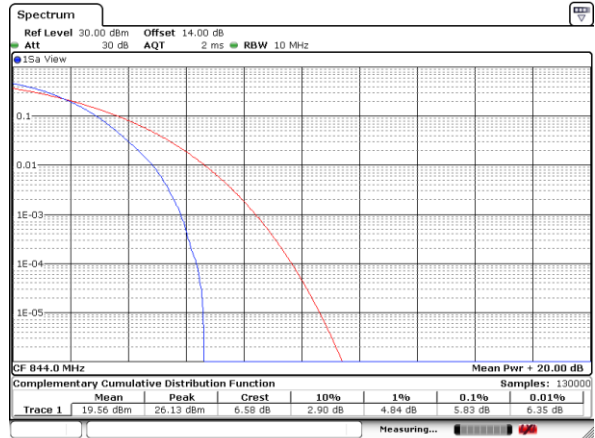

Date: 10.APR.2018 10:31:10



LTE Band 12 / 10MHz / QPSK

Lowest Channel / 1RB

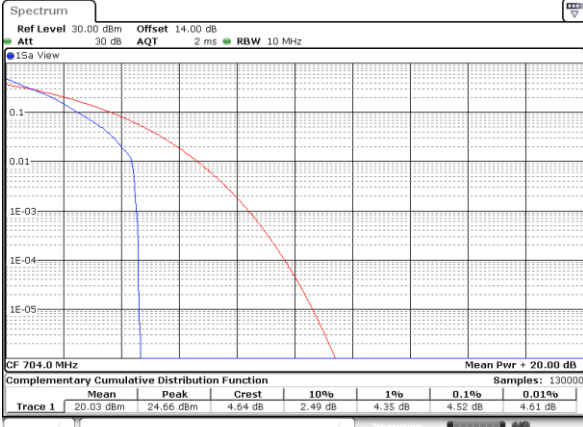

Date: 14.APR.2018 11:07:09

Lowest Channel / Full RB

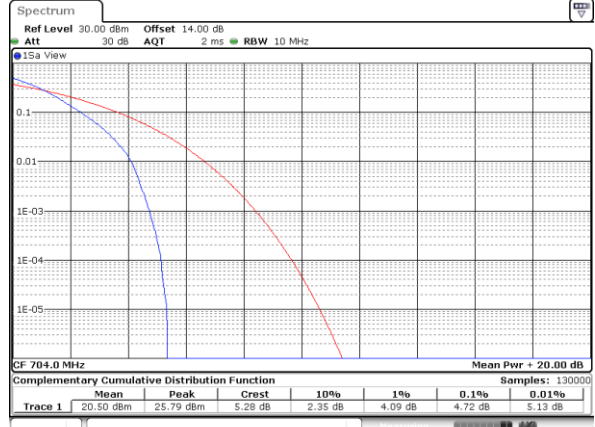

Date: 14.APR.2018 11:07:18

Middle Channel / 1RB

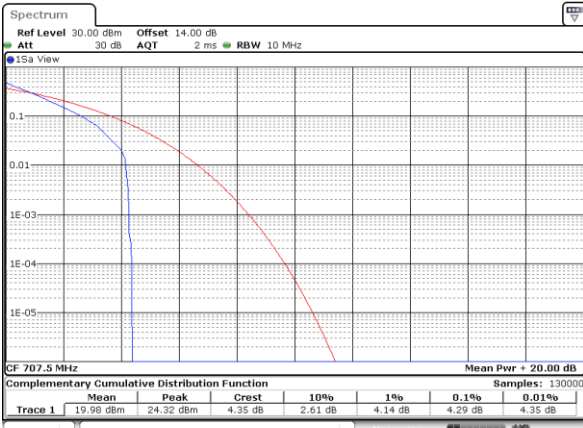

Date: 14.APR.2018 11:07:28

Middle Channel / Full RB

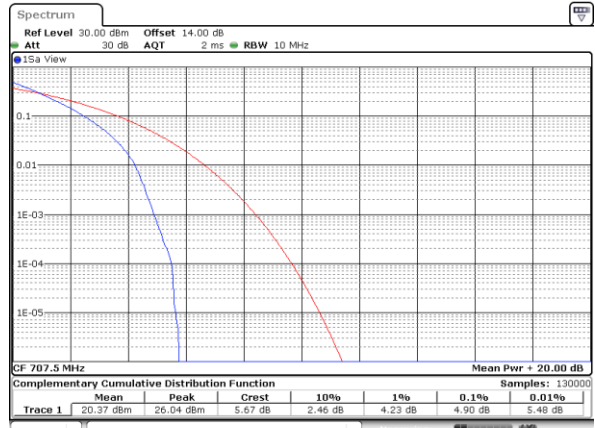

Date: 14.APR.2018 11:07:53

Highest Channel / 1RB

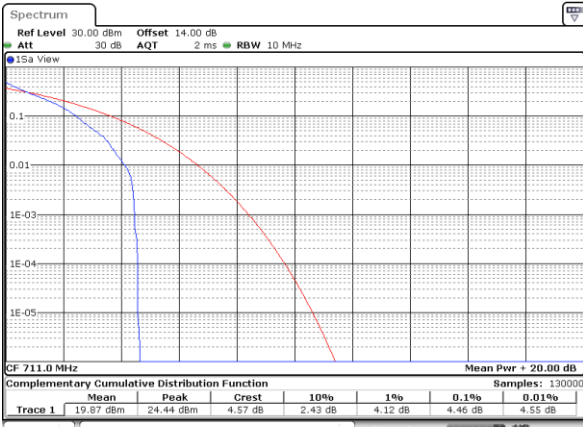

Date: 14.APR.2018 11:08:02

Highest Channel / Full RB

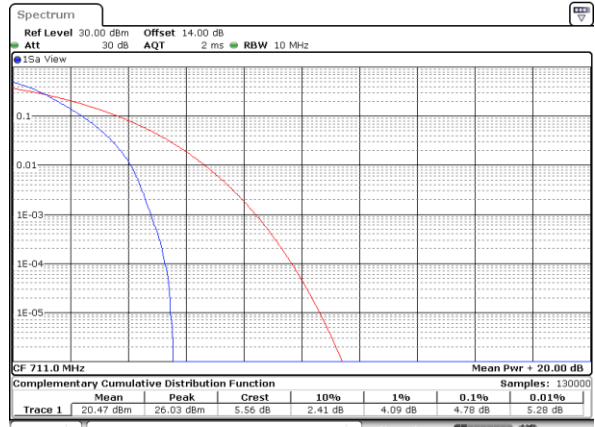

Date: 14.APR.2018 11:08:12



LTE Band 12 / 10MHz / 16QAM

Lowest Channel / 1RB

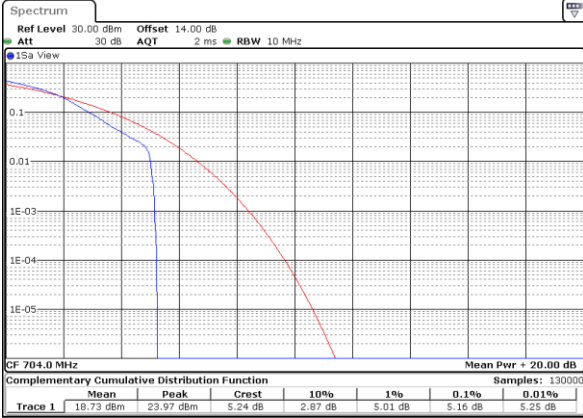

Date: 14.APR.2018 11:21:26

Lowest Channel / Full RB

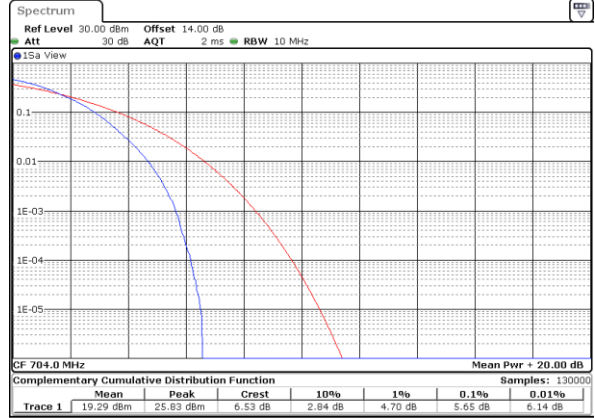

Date: 14.APR.2018 11:06:120

Middle Channel / 1RB

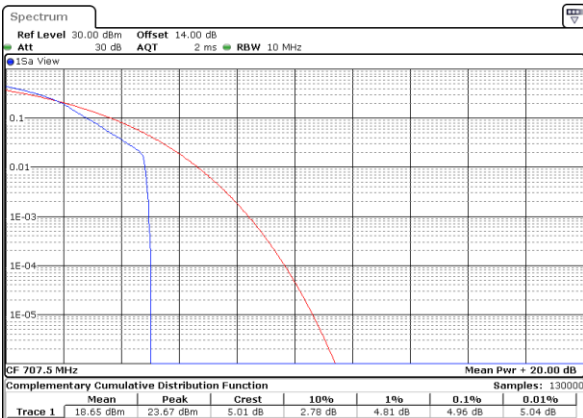

Date: 14.APR.2018 11:22:05

Middle Channel / Full RB

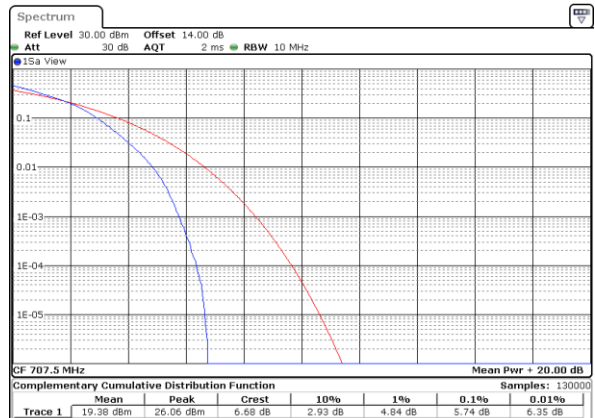

Date: 14.APR.2018 11:06:441

Highest Channel / 1RB

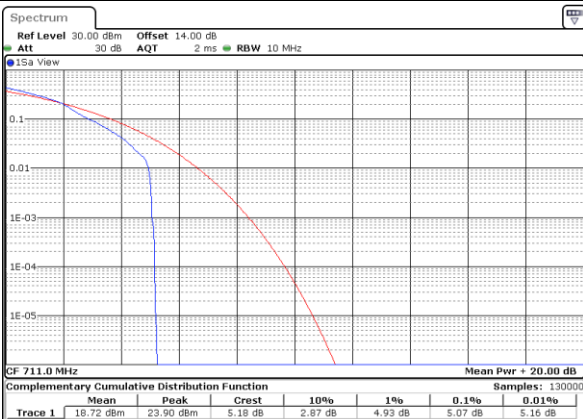

Date: 14.APR.2018 11:06:51

Highest Channel / Full RB



Date: 14.APR.2018 11:07:00



LTE Band 13 / 10MHz / QPSK

Middle Channel/ 1RB

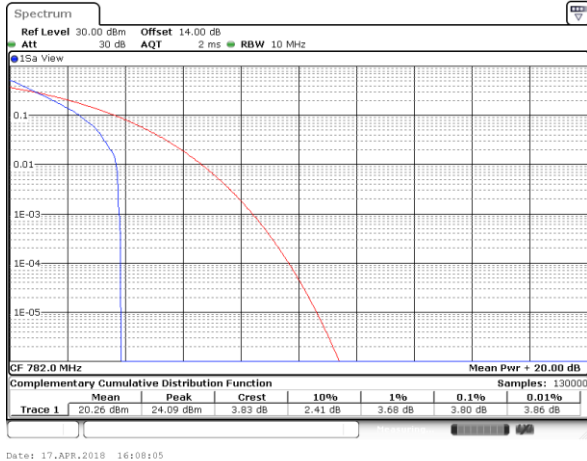

Date: 17.APR.2018 16:08:05

Middle Channel / Full RB

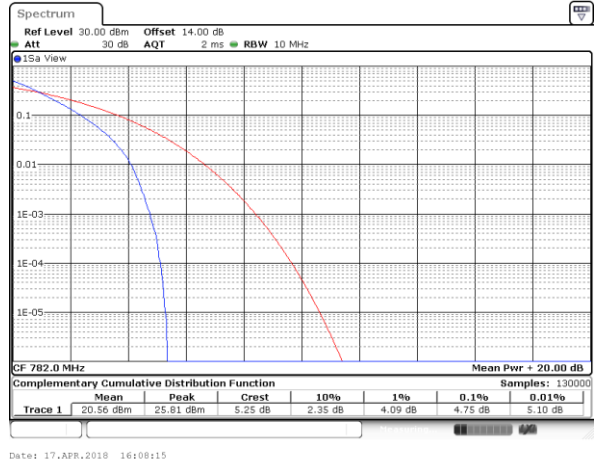

Date: 17.APR.2018 16:08:15

LTE Band 13 / 10MHz / 16QAM

Middle Channel/ 1RB

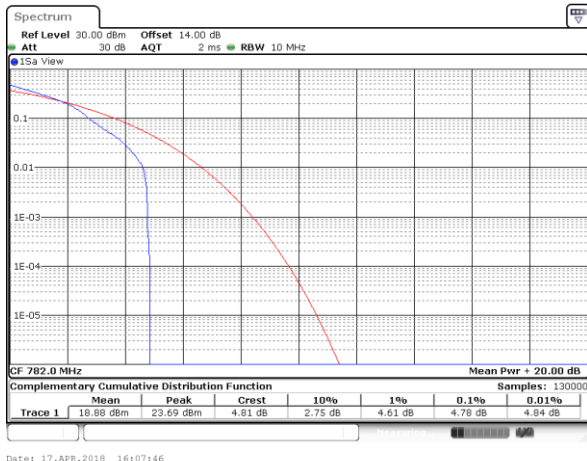

Date: 17.APR.2018 16:07:46

Middle Channel / Full RB

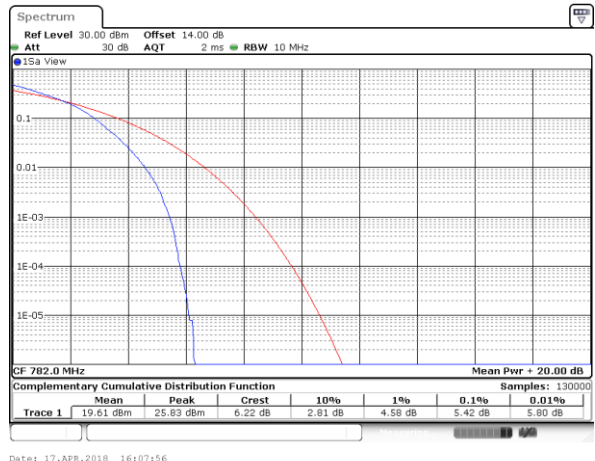

Date: 17.APR.2018 16:07:56



LTE Band 17 / 10MHz / QPSK

Lowest Channel / 1RB

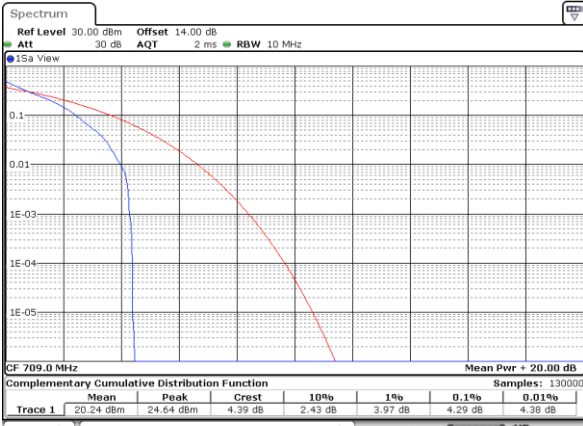

Date: 14.APR.2018 15:44:52

Lowest Channel / Full RB

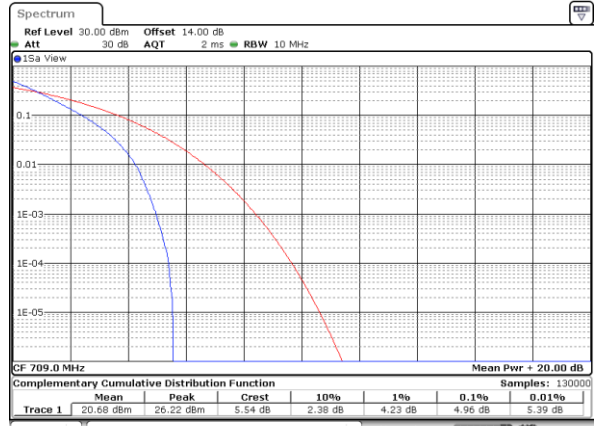

Date: 14.APR.2018 15:45:02

Middle Channel / 1RB

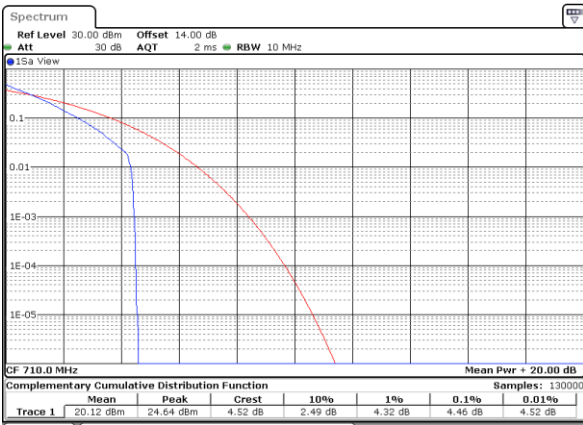

Date: 14.APR.2018 15:45:14

Middle Channel / Full RB

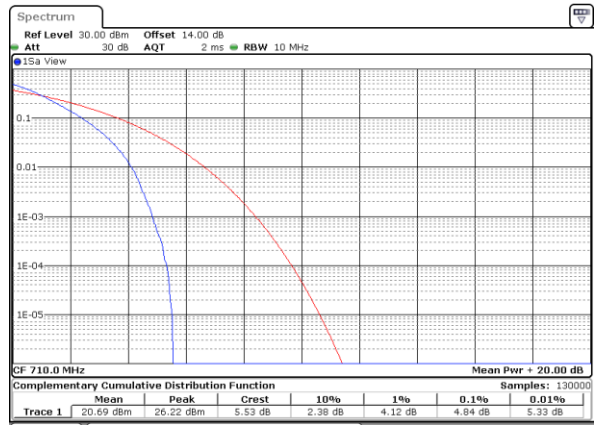

Date: 14.APR.2018 15:45:27

Highest Channel / 1RB

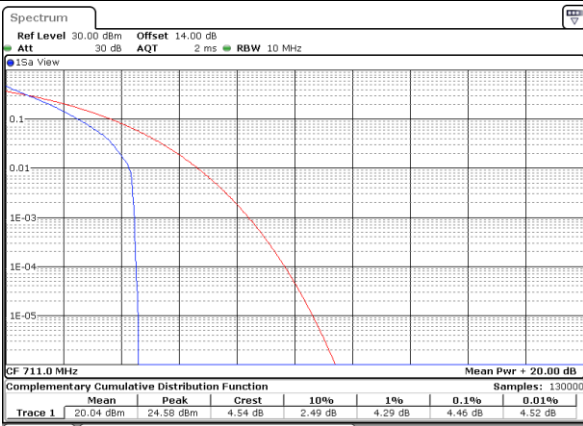

Date: 14.APR.2018 15:45:36

Highest Channel / Full RB

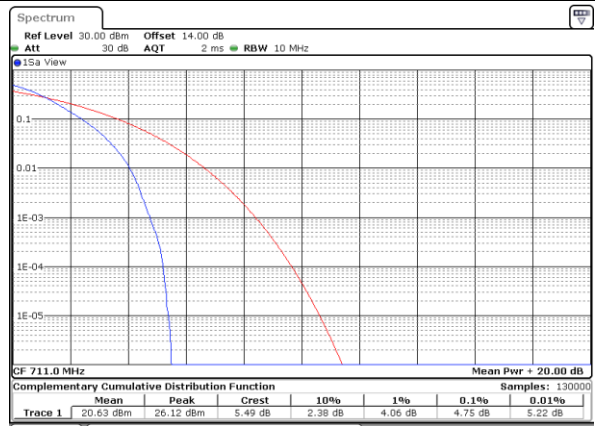

Date: 14.APR.2018 15:45:45



LTE Band 17 / 10MHz / 16QAM

Lowest Channel / 1RB

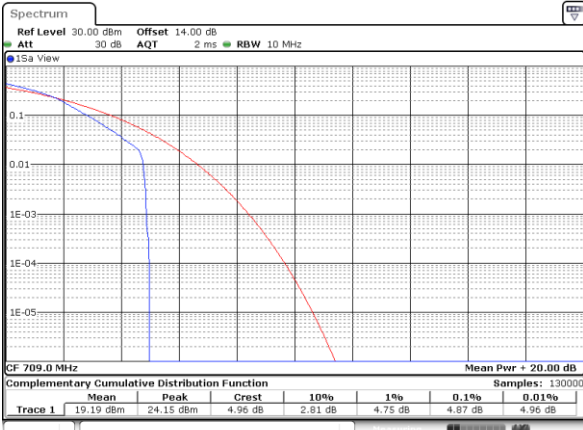

Date: 14.APR.2018 15:43:40

Lowest Channel / Full RB

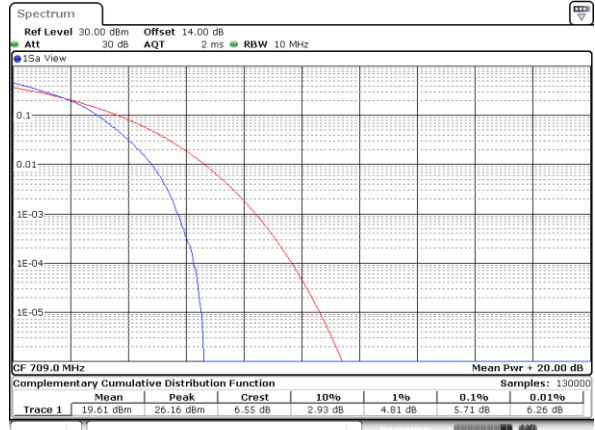

Date: 14.APR.2018 15:43:57

Middle Channel / 1RB

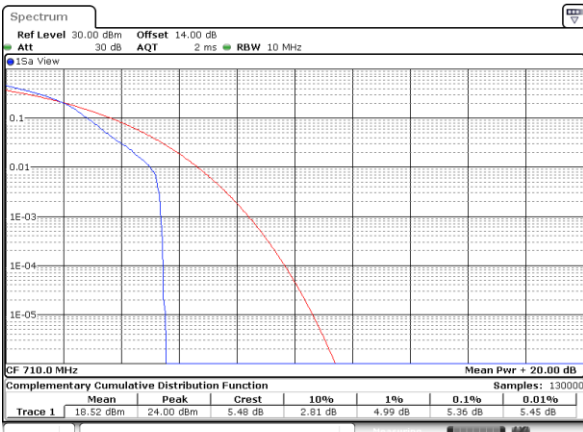

Date: 14.APR.2018 15:44:08

Middle Channel / Full RB

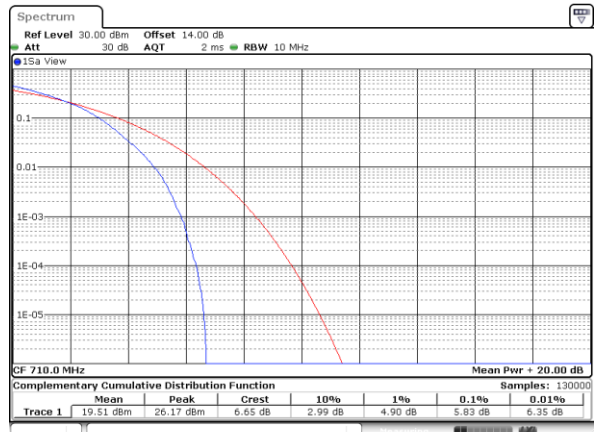

Date: 14.APR.2018 15:44:22

Highest Channel / 1RB

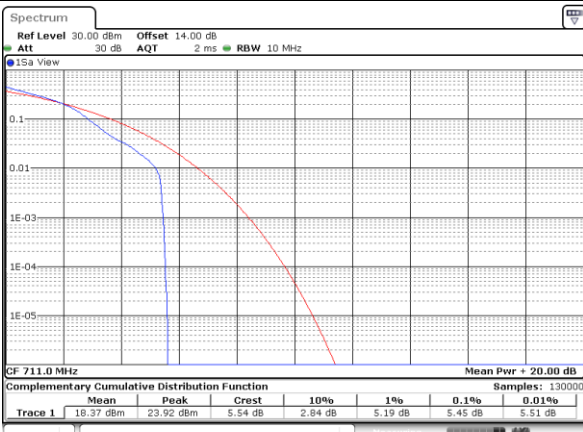

Date: 14.APR.2018 15:44:32

Highest Channel / Full RB

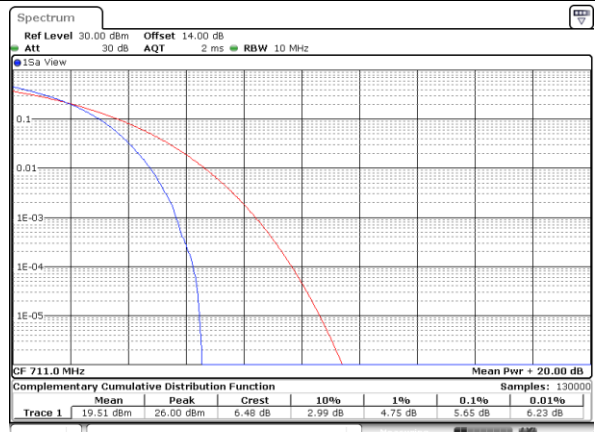

Date: 14.APR.2018 15:44:41



LTE Band 25 / 20MHz / QPSK

Lowest Channel / 1RB

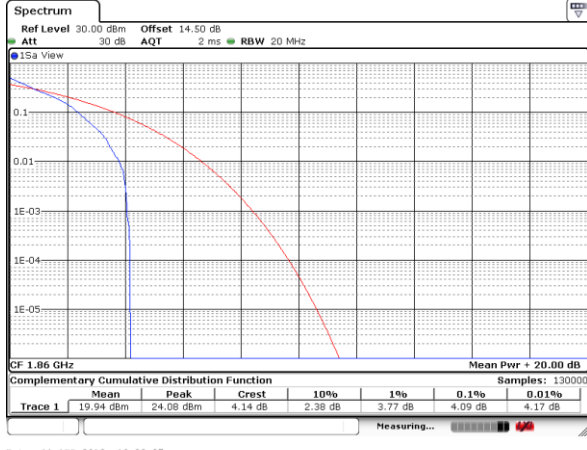

Date: 11.APR.2018 10:32:37

Lowest Channel / Full RB

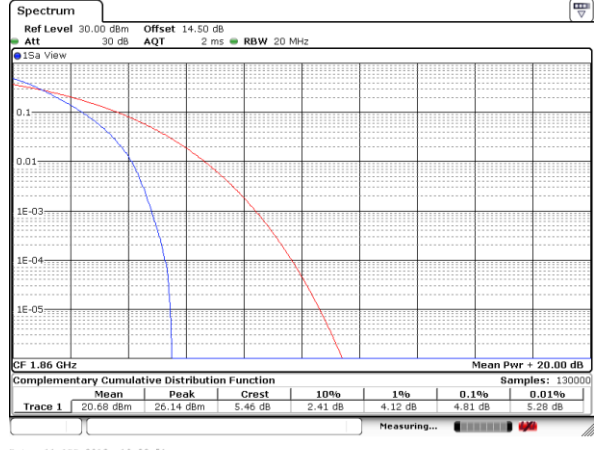

Date: 11.APR.2018 10:32:51

Middle Channel / 1RB

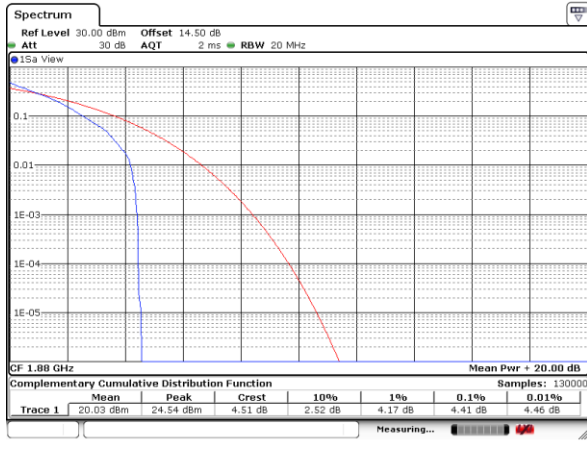

Date: 11.APR.2018 10:33:03

Middle Channel / Full RB

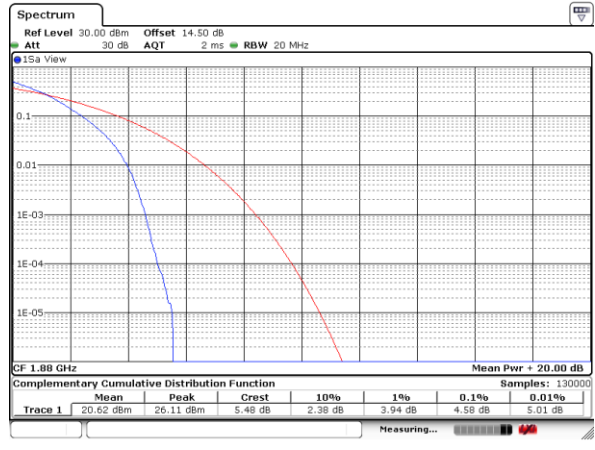

Date: 11.APR.2018 10:33:12

Highest Channel / 1RB

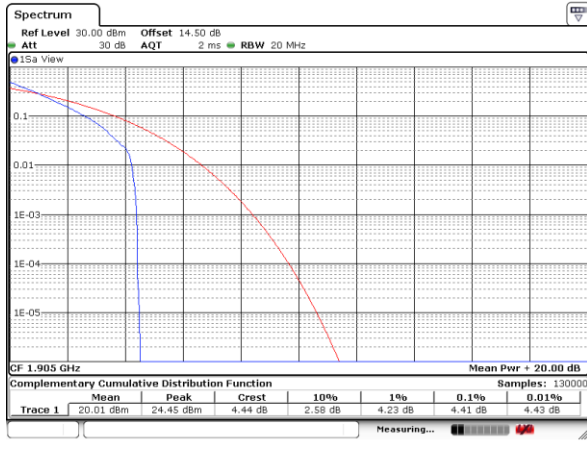

Date: 11.APR.2018 10:33:26

Highest Channel / Full RB

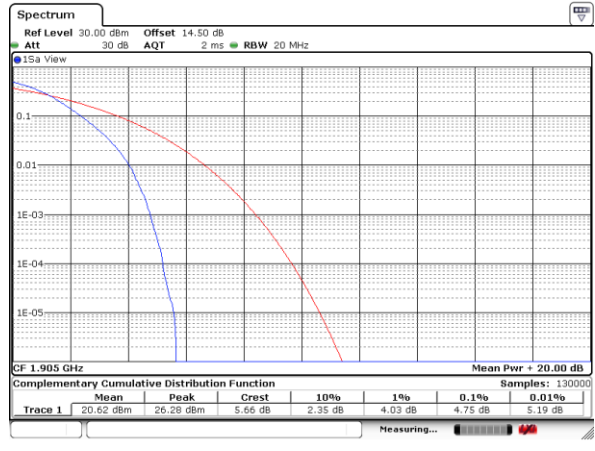

Date: 11.APR.2018 10:33:35



LTE Band 25 / 20MHz / 16QAM

Lowest Channel / 1RB

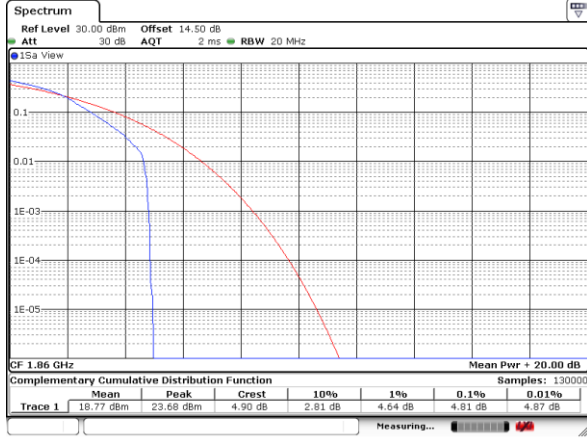

Date: 11.APR.2018 10:40:33

Lowest Channel / Full RB

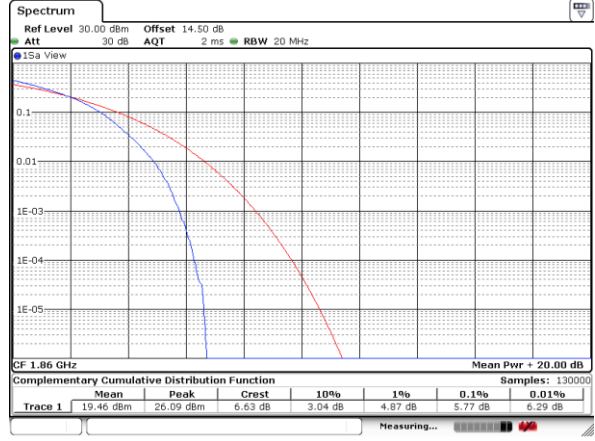

Date: 11.APR.2018 10:31:39

Middle Channel / 1RB

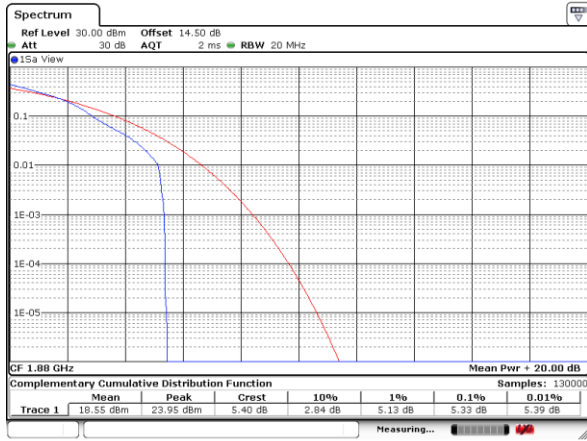

Date: 11.APR.2018 10:41:55

Middle Channel / Full RB

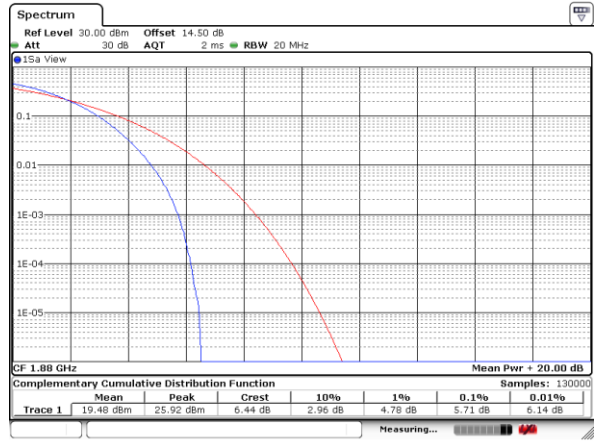

Date: 11.APR.2018 10:32:06

Highest Channel / 1RB

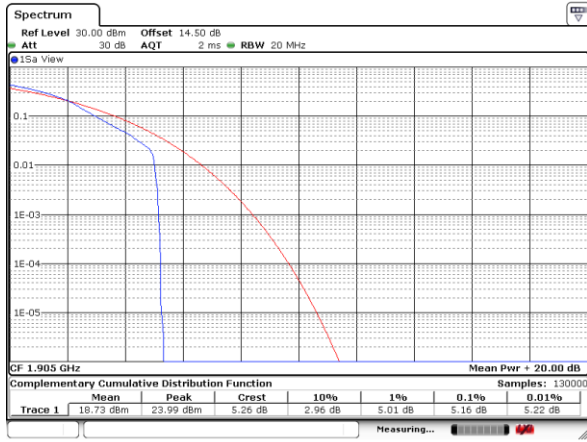

Date: 11.APR.2018 10:32:17

Highest Channel / Full RB

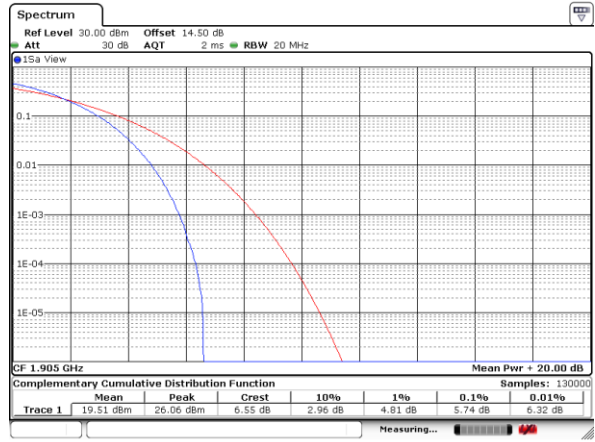

Date: 11.APR.2018 10:32:26



LTE Band 26 / 15MHz / QPSK

Lowest Channel / 1RB

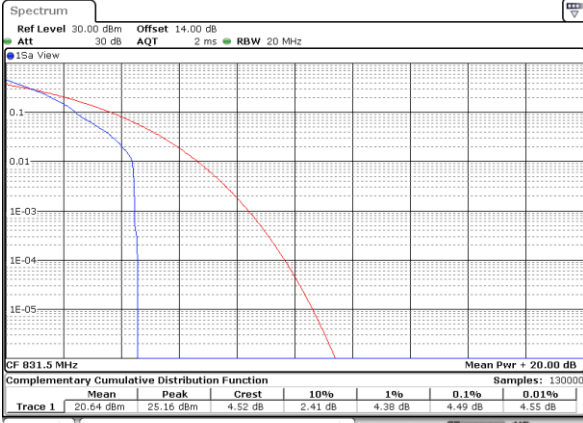

Date: 16.APR.2018 15:14:53

Lowest Channel / Full RB

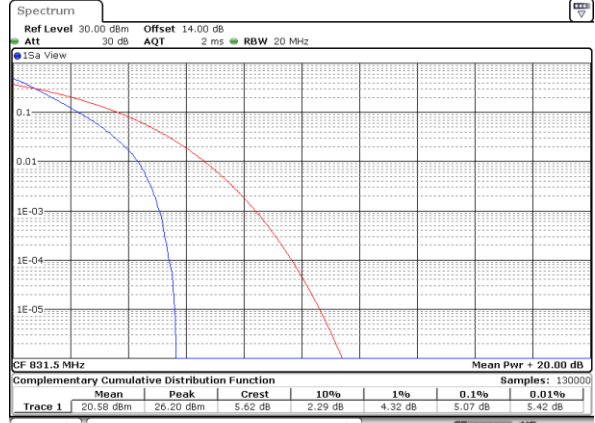

Date: 16.APR.2018 15:15:04

Middle Channel / 1RB

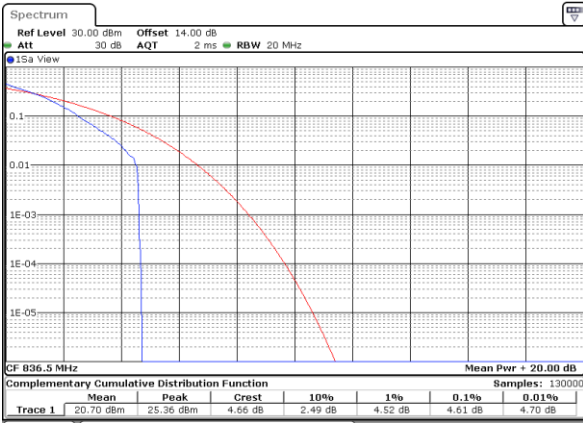

Date: 16.APR.2018 15:15:14

Middle Channel / Full RB

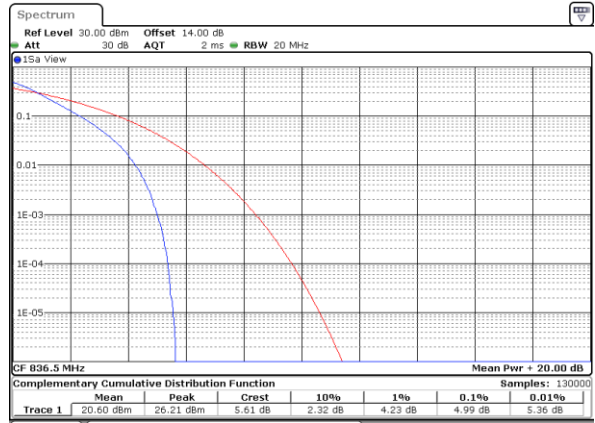

Date: 16.APR.2018 15:15:27

Highest Channel / 1RB

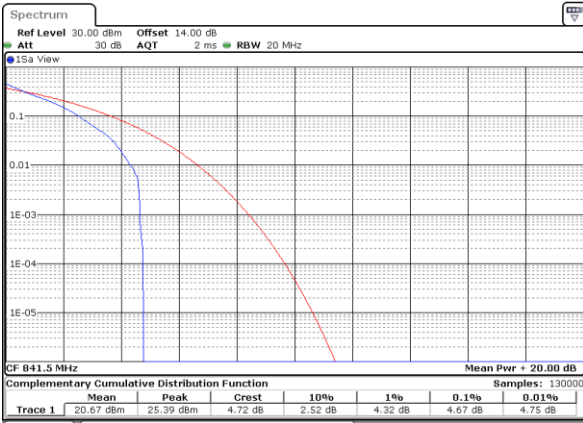

Date: 16.APR.2018 15:15:37

Highest Channel / Full RB

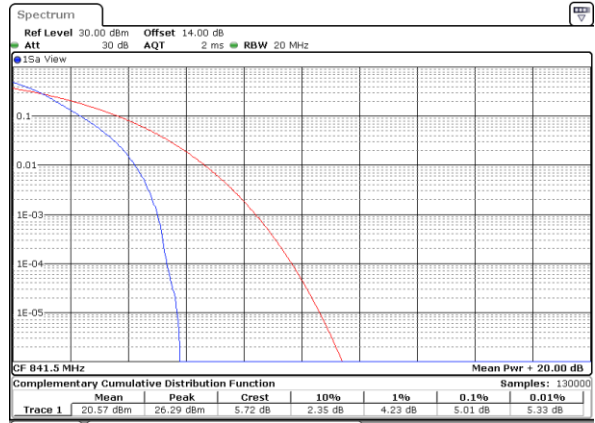

Date: 16.APR.2018 15:15:47



LTE Band 26 / 15MHz / 16QAM

Lowest Channel / 1RB

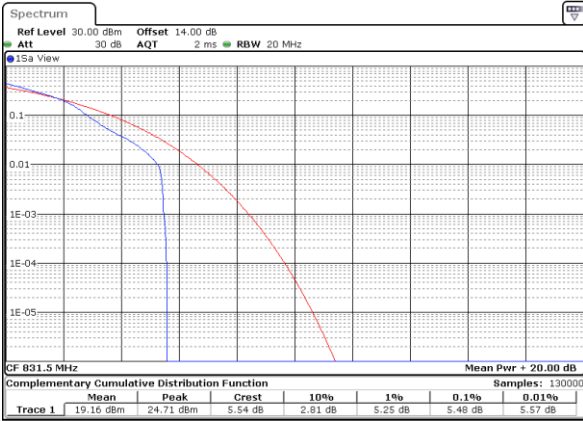

Date: 16.APR.2018 15:13:31

Lowest Channel / Full RB

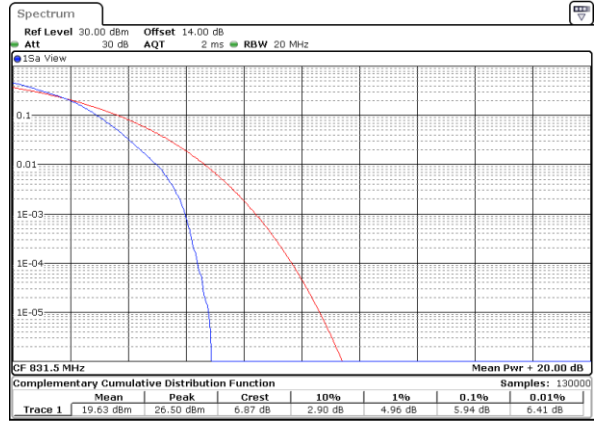

Date: 16.APR.2018 15:13:42

Middle Channel / 1RB

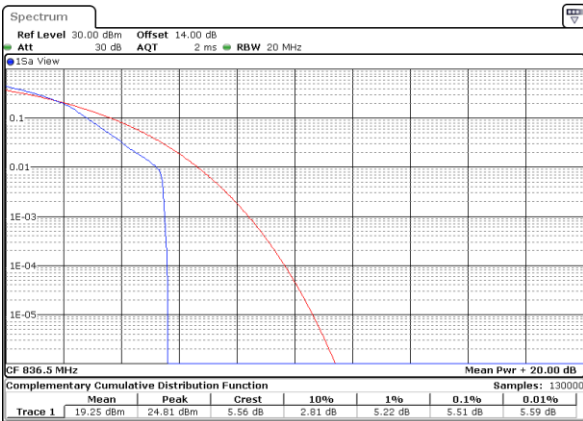

Date: 16.APR.2018 15:13:51

Middle Channel / Full RB

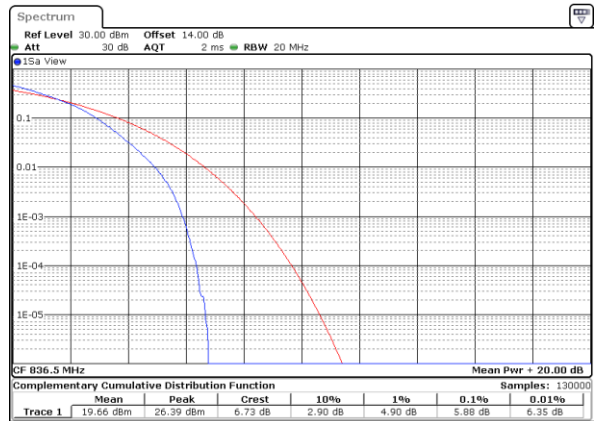

Date: 16.APR.2018 15:14:01

Highest Channel / 1RB



Date: 16.APR.2018 15:14:29

Highest Channel / Full RB

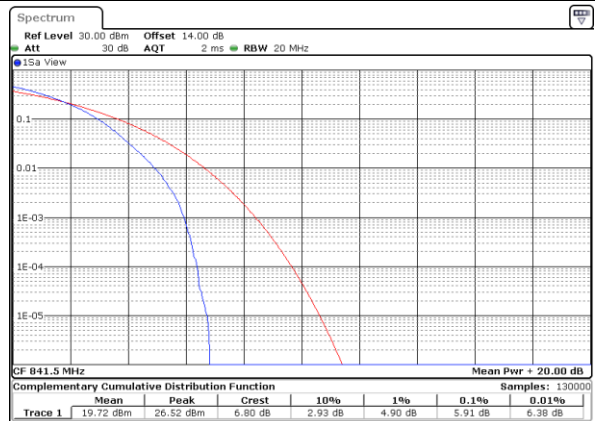

Date: 16.APR.2018 15:14:42



LTE Band 41 / 20MHz / QPSK

Lowest Channel / 1RB

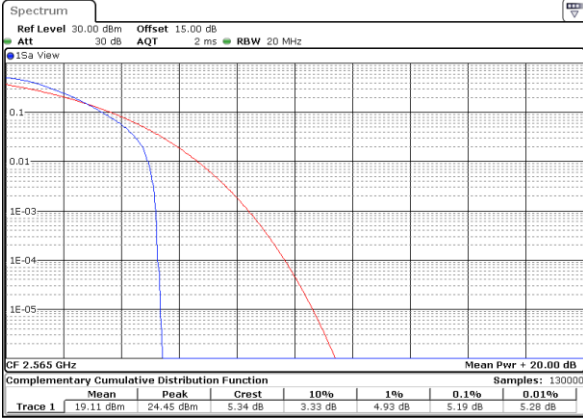

Date: 19.APR.2018 15:52:44

Lowest Channel / Full RB

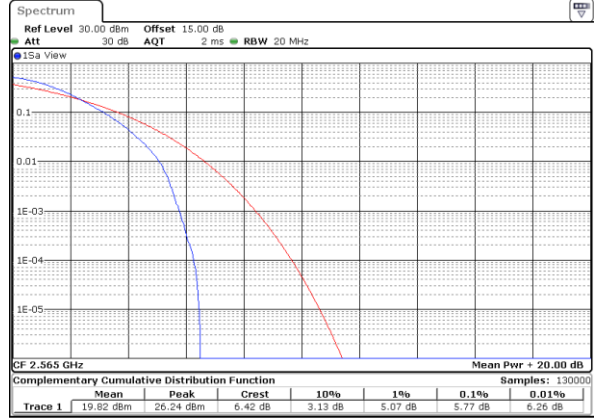

Date: 19.APR.2018 15:40:44

Middle Channel / 1RB

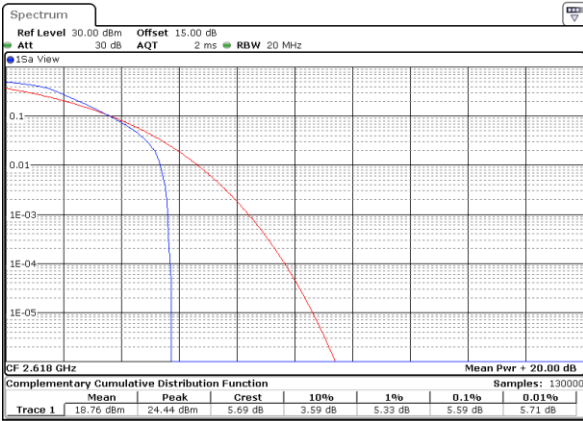

Date: 19.APR.2018 15:43:50

Middle Channel / Full RB

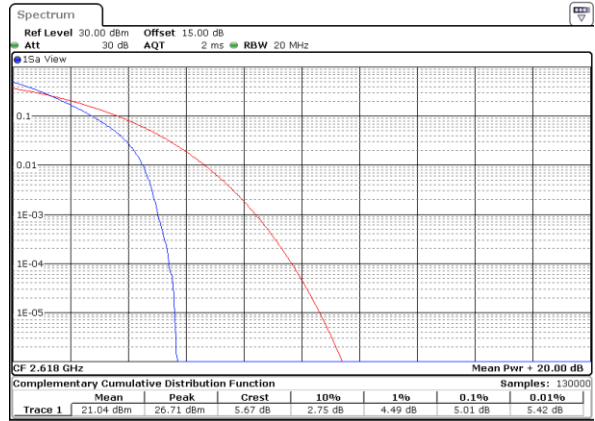

Date: 19.APR.2018 15:43:01

Highest Channel / 1RB



Date: 20.APR.2018 15:56:21

Highest Channel / Full RB



Date: 19.APR.2018 15:46:03