

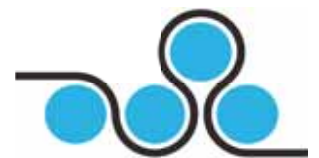

Operator Manual

S10 Nanographic Printing Press®

Version 1.02



Copyright

© 2018 Landa Corporation Ltd. All rights reserved. Landa, Landa Digital Printing, Nanographic Printing, Landa Nanographic Printing, Nanography, Landa Nanography, NanoInk, Landa NanoInk and the related logos and slogans are trademarks and trade names of Landa Corporation Ltd or registered marks thereof in at least one country. All other trademarks are the property of their respective owners. This information is subject to change without notice. This presentation may contain forward-looking statements that involve risks, uncertainties and assumptions and such statements should be viewed with according caution.

Landa Corporation Ltd. shall under no circumstance be liable for technical or editorial omissions or errors.

www.landanano.com

Table of Contents

Introduction.....	5
Disclaimer - Statement of Liability.....	5
Changes	5
Landa Customer Care Center.....	5
Specifications.....	6
Views	8
Front and Rear View	9
Front of Press.....	9
Rear of Press.....	9
Doors	10
Front Doors and Panels.....	10
Rear Doors and Panels	11
Side Doors and Panels	12
Coating Unit Panels.....	13
Safety Information.....	14
Use of the Equipment.....	15
Disclaimer - Statement of Liability.....	15
Changes	15
Landa Customer Care Center.....	15
Landa Certified Operators	16
Personal Protection	16
Using the Safety Devices.....	17
Safety During Daily Work.....	18
Safety Data Sheet	18
Safety During Maintenance, Inspection, and Adjustment	19
Residual Current Device.....	20
Fire Extinguishing Equipment	20
PQC Safety Precautions	20
Steps and Hand Grips	21
Corrective Measures	21
Periodic Inspection	21
Noise Emissions	21
Safety Cleaning of the Press and Equipment	22

Cleaning Solvent	22
Cockpit Monitors	24
LCD Control Panels	24
Handling of Accessory Devices	24
FCC Compliance	25
Precautions on Press Installation and Movement	25
Coating Unit Safety	26
Action to be Taken in Case of Hazards	26
Hoses and Pipes.....	26
Ink and Coating.....	26
Coating Unit Dryer Safety	27
Cabinet Cooling	30
Lamp Head Cleaning	30
U.V. Radiation	30
First Aid.....	31
Ozone Gas.....	31
Mercury	32
Lamp Disposal	32
Safety Alert Labels	33
Safety Device Locations	42
Emergency Stop Buttons.....	42

Control Panels45

Feeder Unit.....	46
Feeder Unit Panel	47
Feeder Unit Side Panel	49
LIA Monitor.....	52
Coating Unit Control Panels.....	53
Bypass Operation Panel.....	55
PQC Panel	57
Hand Held Controllers	58
Delivery Unit Panel	60

Landa Interface Application.....81

About the Landa Interface Application	82
LIA Monitors	82

Video Feeds	83
Tank Status	84
Landa NanoInk Farm Status	84
Press Status	84
Coating Unit Status	84
Alert Flag	85
Main Menu	86
Alerts	88
Job Card Views	88
Shortcuts and Favorites	89
Control Panel	90
Start printing	90
Printing Timeline	92
Job Cards	93
Job Properties	93
General Tab.....	94
Output Tab	95
Image Position Tab	96
Color & Quality Tab	97
Checklists.....	98
Maintenance Checklists.....	99
Checklist Procedures	103
Error Messages.....	104
Paper Transport System Procedures	104
Ink Printing System Procedures.....	106
Blanket Cooling Unit Procedures.....	115
Cold Water System Procedures	116
Waste Procedures	117
Coating Procedures	118
Ventilation Procedures	120

Dryers/Image Pinning Unit Procedures121

Basic Printing Procedures122

Final Check Before Printing..... 123

Checklist123

Start the Printing Press..... 124

Prepare the Paper.....126

Adjust the Sucker Settings127

Adjust the Register Settings.....128

Prepare the Delivery Unit..... 129

Final Procedures Before Printing..... 130

Printing..... 131

Finishing Procedures.....132

Press Procedures 133

Printing System Procedures.....134

Blanket Conveyor System Procedures 134

Paper Transport System Procedures.....137

Feeder and Register Unit Procedures143

Coating Unit Procedures.....148

Operating the Press154

Troubleshooting164

Resolving Error Messages.....165

Ink Delivery System Troubleshooting.....168

Alerts 169

Observation Deck Alerts.....170

Introduction

The Landa S10 Nanographic Printing® Press Operator Manual introduces Landa certified print operators to the concepts and procedures required to operate the printing press.

Disclaimer - Statement of Liability

This publication has been compiled with care. The information contained herein is provided solely as a site preparation guide for the Landa S10 Nanographic Printing Press; and its distributors are not liable, nor do they assume any responsibility, for any errors, accidents, personal injuries, consequential or incidental damages, loss of profits, loss of use, or any other damages that may result from the misuse or misrepresentation of any information contained in this publication.

Changes

The information included in the manual is subject to change without notice.

Landa Customer Care Center

The Landa Customer Care Center is at your service to answer any calls, queries, or questions regarding the press, safety issues and correct use of Landa equipment and related consumables. Landa Customer Care Center phone number: +49 211 95986707

Specifications

Description	Sheetfed Nanographic Printing® press
Segment(s)	Folding carton, POP/POS
Print speed	6,500 13,000 SPH*
Colors	CMYK + OBG + additional color
No.of colors	4-8
Resolution	1200 dpi
Screening	AM, FM
Max. sheet size	750 x 1050 mm (29.5 x 41.3 in.)
Min. sheet size	360 x 520 mm (14 x 20.4 in.)
Max. print area	730 x 1032 mm (28.7 x 40.6 in.)
Media thickness	60-800 µm (2.4-3.2 pt.)
Pile input/output	1150 mm (45.3 in.)
Press length	14.1 m (45.9 ft.)
Press length inc. coating unit and dryers	17.1 m (56.1 ft.)
Press width	4.8 m (15.7 ft.)
Press height	2.4 m (7.9 ft.)
Weight (press only)	22 tonnes (24.25 US tons)
Weight (press + coating unit)	32 tonnes (35.3 US tons)
Total length (inc. working area + cabinets)	19.1 m (62.6 ft.)
Total width (inc. working area + cabinets)	6.8 m (22.3 ft.)
Total height (inc. working are + cabinets)	3.5 m (11.5 ft.)
Supported substrates	All types of off-the-shelf carton board: virgin & recycled, two-side coated & one-side coated, metalized
Coatings	UV, aqueous
Operator interfaces	Cockpit touchscreen, feeder console, Landa tablet
Active Quality Management (standard)	<ul style="list-style-type: none"> • Closed-loop quality control with automatic correction • 100% defect inspection
Color matching	Match: ISO standard 12647-2, Fogra, GRACoL <ul style="list-style-type: none"> • CMYK covering 84% of Pantone® colors • CMYK + OBG covering 96% of Pantone® colors
Electronics & machinery certifications	CE Mark • Machinery Directive 2006/42/EC (including annex) • UL775 (or Field Inspection) • EN ISO 12100: 2010 • EN 60204-1: 2006+A1:2009 • EN 1010-1 : 2004+A1:2010; EN 1010-2: 2006+A1:2010 • ISO 12643-1: 2009; ISO 12643-2: 2010

Ink certifications	European framework regulation (1935/2004); European GMP regulation (2023/2006); European PIM regulation (10/2011) • FDA Packaging & Food Contact Substances (FCS) / FDA CFR 21 • Swiss ordinance 817.023.21 (Annex 6) • BfR Recommendations on Food Contact Materials (formerly “Plastics Recommendations”) • Nestle guidance note on packaging inks • Listing in appropriate inventories (national) – EINECS, TSCA, DSL etc. • Compliance with REACH, Calif. Prop. 65
Digital Front End	Landa DFE Standard / Performance / Premium
Press options	Full range of options for workflow, Active Quality Management and press operation.

* High-speed option.

Chapter 1

Views

Front and Rear View

Front of Press

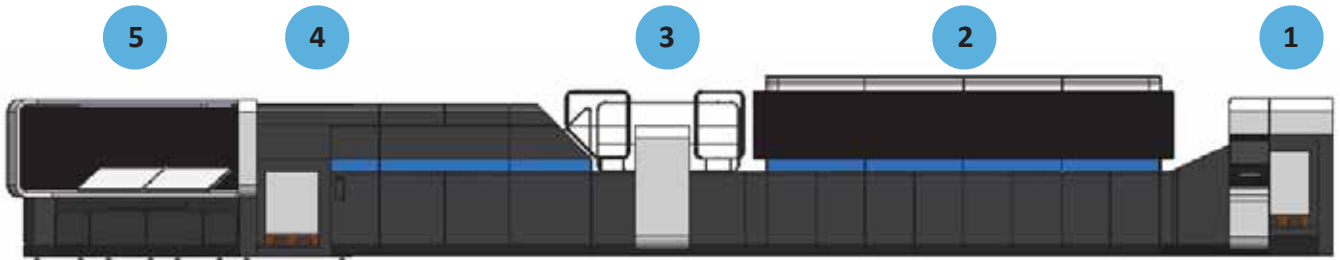

Rear of Press

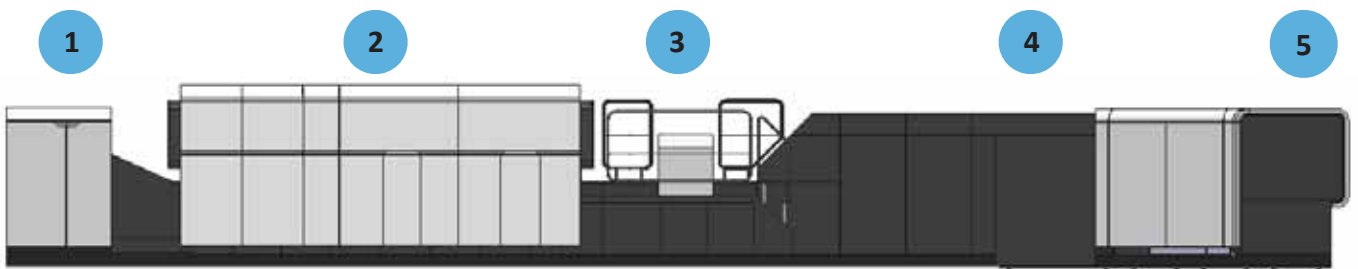

No.	Name
1	Feeder Unit
2	Nanographic Printing Engine
3	Coating Unit
4	Delivery Unit
5	Landa Operator Cockpit

Doors

Front Doors and Panels

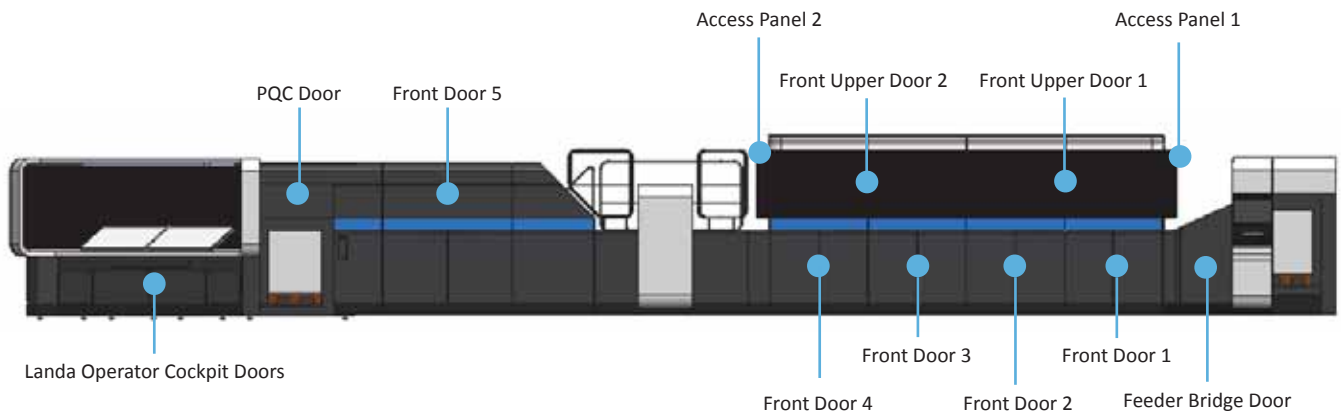

Name	Access
Feeder Bridge Door	Feeder bridge
Front Upper Door 1	Dryers
Front Upper Door 2	Image pinning units
Access Panel 1	Blanket
Access Panel 2	Fly offs
Front Door 1	Substrate transport system cylinders
Front Door 2	Substrate transport system cylinders
Front Door 3	Blanket cleaning unit
Front Door 4	Reject tray
Front Door 5	UV/IR lamps
PQC Door	PQC console
Landa Operator Cockpit Doors	Operator press controller, data path controller

Rear Doors and Panels

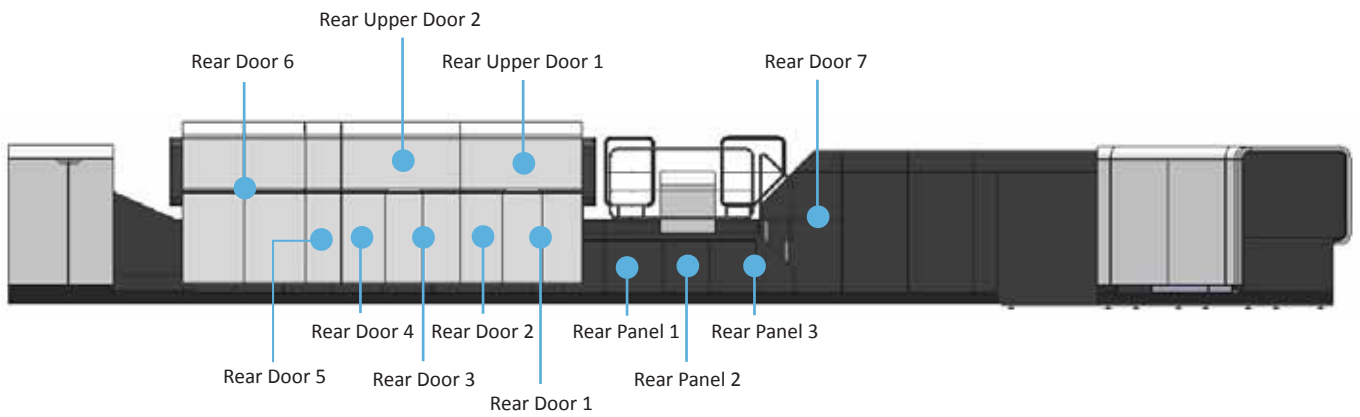

Name	Access
Rear Upper Door 1	Print bars 1-4
Rear Upper Door 2	Print bars 5-8
Rear Door 1	Ink delivery system 1
Rear Door 2	Ink delivery system 1 - electrical cabinet
Rear Door 3	Ink delivery system 2
Rear Door 4	Ink delivery system 2 - electrical cabinet
Rear Door 5	UPS
Rear Door 6	Ventilation
Rear Door 7	Transport system oil pump, powder unit, UV/IR lamps
Rear Panel 1	Transport system impression cylinder cleaning unit
Rear Panel 2	Transport system access
Rear Panel 3	Coating unit impression cylinder cleaning unit

Side Doors and Panels

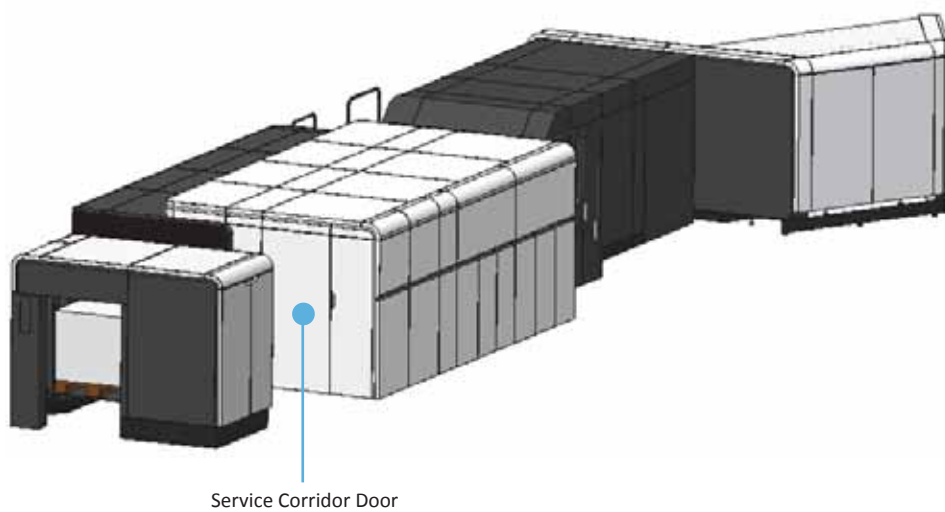
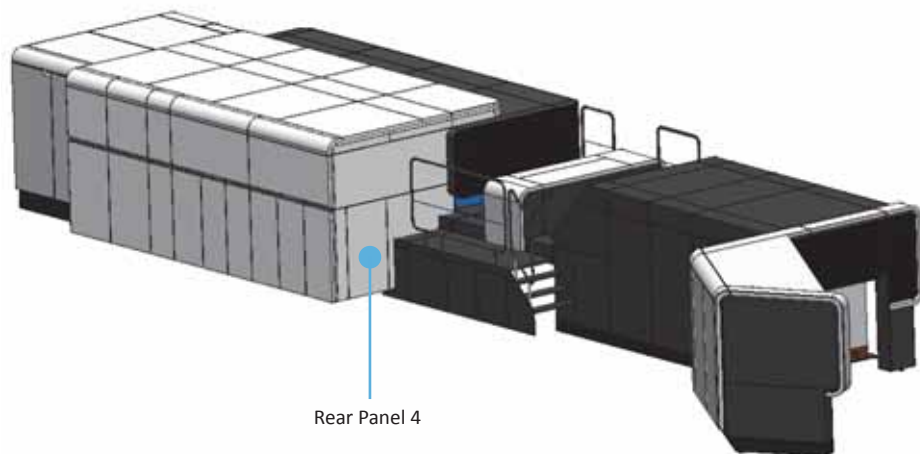

Name	Access
Service Corridor Door	Service corridor
Rear Panel 4	Ink delivery system pneumatics panel

Coating Unit Panels

View from front of press

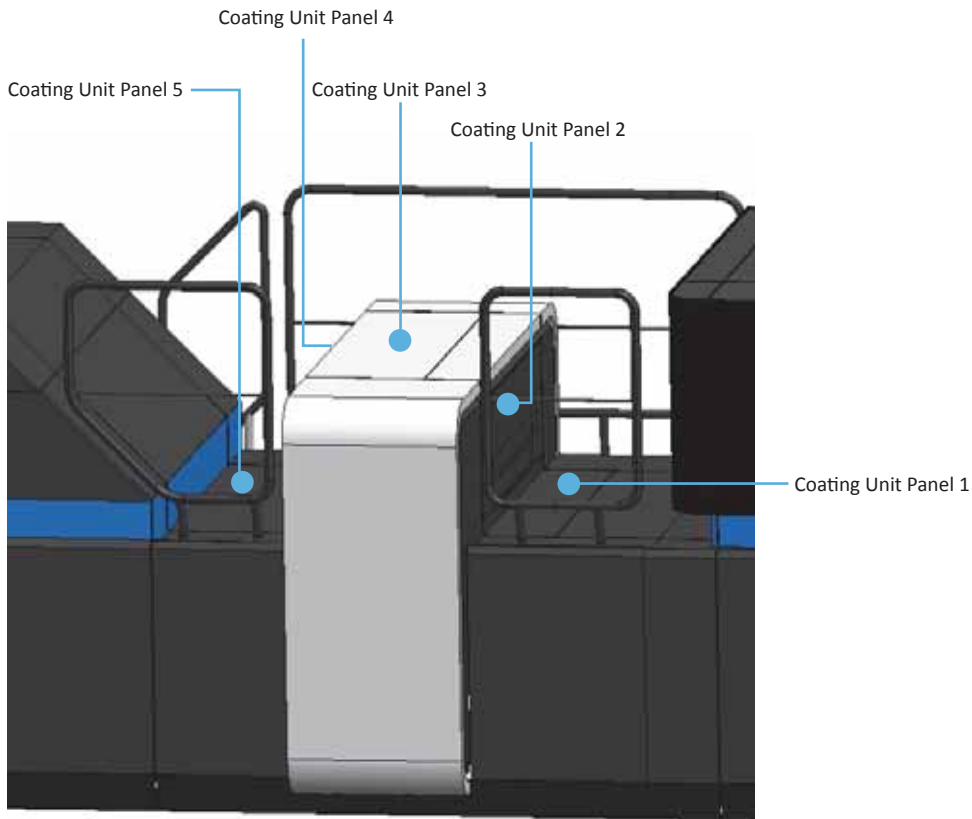

Name	Access
Coating Unit Panel 1	Coating unit blanket cleaning unit
Coating Unit Panel 2	Coating unit chamber system
Coating Unit Panel 3	Anilox roll
Coating Unit Panel 4	Coating unit impression cylinder
Coating Unit Panel 5	Coating unit impression cylinder

Chapter 2

Safety Information

Use of the Equipment



WARNING

Cautions concerning safety are important for safe use of the Landa Nanographic Printing Press. Be sure to read and fully understand all safety precautions before using the Press.

The Landa S10 Nanographic Printing Press (the “Press”) is a digital offset printing press for general printing. Do not use it for any other operations and do not use any materials other than general offset printing materials. Doing so may compromise safety.

The Press is equipped with two types of safety devices: those which protect the safety of the operator and those which maintain optimum Press performance. The Press has been designed and manufactured with full consideration for safety. To ensure maximum safety, verify the location and functions of the safety devices, and be familiar with the safety devices before operating or performing maintenance on the Press.

When special devices have been installed for other specific purposes, be sure to comply with the instructions in the special device's manual and maintain/operate the Press safely.



WARNING

The Landa Nanographic Printing Press contains high-voltage power supplies. There is no danger to persons or equipment when the system is operated in accordance with the directions provided by Landa in this and other publications. All high-voltage power supplies are located behind protective covers. Do not remove protective covers (warning labels are attached to each protective cover).

Disclaimer - Statement of Liability

This publication has been compiled with care. Landa and its distributors are not liable, nor do they assume any responsibility, for any errors, accidents, personal injuries, consequential or incidental damages, loss of profits, loss of use, or any other damages that may result from the misuse or misrepresentation of any information contained in this publication.

Changes

The information included in this document is subject to change.

Landa Customer Care Center

The Landa Customer Care Center is at your service to answer any calls, queries, or questions regarding the safe and correct use of the Press and other Landa equipment and related consumables.

Landa Customer Care Center phone numbers:

- Germany: +49 211 95986707
- Israel: +972-3-9786444

Landa Certified Operators

Only those people who are 'Landa certified' are permitted to perform activities relating to the Press, including cleaning, training, demonstrating etc.; Certification is per the type of Press.

The Landa Operational Program mandates that all Press operators must be Landa Certified Operators who have successfully completed the relevant system operation courses.

- The level or grade of the operator's certification is determined by courses attended and successful completion of such courses
- Certification is only issued after completing the appropriate course and successfully passing the certification examination, as determined by Landa at its discretion
- Landa Certificates are valid for 18 months. A refresher training course shall be required to maintain the Operator Certificate in full force and effect.
- All Certified Operators will be registered by Landa Corporation, including their qualification level and type of Press. Certification is personal and a Certified Operator may be disqualified in certain events.

Personal Protection

1. Loose articles of clothing, rings, dangling jewelry, wiping rags, tools, or long hair can easily become entangled in moving machinery. To avoid serious personal injury, never operate equipment with loosely fitting clothes, exposed shirt-tails, dangling ties or similar loose fitting clothes. Wearing clothes properly suited to the operations is essential for safe operation. All jewelry should be removed and kept away from machinery. Great care should be taken when using wiping rags to avoid contact with moving machine parts. Tools should be kept away from machinery when they are not being used. Long hair can be a serious hazard if not properly restrained or covered.
2. Personal protective equipment can reduce the possibility of injury. Injuries in the Press room can be reduced by wearing proper eye, ear, head, foot and other protective gear.

Using the Safety Devices

1. The Press is equipped with many safety covers, safety bars, footboards, and other safety devices for the operator's protection.

Be sure to familiarize yourself with all the safety instructions contained in this manual and all warning labels and safety features on the Press and related equipment.

Know the location and function of all safety covers, safety bars, footboards, and other safety devices, interlock switches and emergency stop devices.

2. Never remove a safety cover, safety bar, footboard or other safety device or bypass a safety device or interlock switch.

Ignoring safety precautions, failing to inspect safety signals, valves and switches, or intentionally bypassing safety devices may invite unnecessary risk of serious injury to you and co-workers who may be unaware of the dangers.

Any removal or alterations to a safety cover, safety bar, footboard or other safety device may disable the device or cause it to malfunction.

3. Safety covers, safety bars, footboards or other safety devices and systems should be frequently inspected to ensure that they are functioning properly.

Always check that the safety devices are in place and working correctly before operating the Press each day.

Do not operate or maintain the Press with a safety cover, safety bar, footboard or other safety device that has been removed or bypassed.

Report any missing, bypassed, broken or defective safety covers, safety bars, footboards or other safety devices or systems promptly to your supervisor.

Safety During Daily Work

1. Only one Certified Operator should operate switches at any given time. If more than one Certified Operator operates the switches, the Press may operate in unexpected ways, resulting in accidents.
2. Warn other nearby operators and persons and check for safety before operating the Press.
3. A warning horn is sounded to warn that the Press is about to start operating. For your safety, move away from operating parts or the Press itself whenever you hear the horn.
4. To ensure safe footing, promptly wipe up any oil or water spilled on the footboards or floor. Always keep the Press working environment clean.
5. Before making adjustments which require the opening of guards, safety covers, or footboards, first stop the Press and other involved equipment. Press the Tune Up button then open the covers. If adjustment or maintenance is required where contact with moving machine parts are possible, stop the Press and involved equipment and refer to Safety During Maintenance, Inspection, and Adjustment.
6. If any safety covers or footboards protecting the operator from rotators or mechanical operating parts are opened to perform adjustments etc., be sure to set them back to their original position promptly after completing the adjustment.
7. Do not leave any tools or cleaning implements on any part of the Press, as operators may trip over them and be injured, and the tool or cleaning implement may fall inside the Press, causing the Press to stop or be damaged.
8. Be sure to store tools and cleaning implements in their proper place after using them.
9. When removing samples at the delivery unit, never insert your hands further than the front lay. Doing so may result in touching rotators or mechanical operating parts, causing fingers or hands to get caught and seriously injured.
10. When wedges are required for better piling at the delivery, use utmost caution and never touch moving parts. Touching moving parts may cause fingers or hands to get caught and may lead to serious injury.

Safety Data Sheet

Safety Data Sheet (SDS) information (including the instructions for the safe use and potential hazards associated with specific consumables), is available for viewing, downloading, and printing via the Landa Customer Portal, a designated site or the Landa Customer Care Center.

Safety During Maintenance, Inspection, and Adjustment

1. Before entering inside a safety guard, cover, footboard or working under the Press for maintenance, inspection, or adjustment, first press and lock the emergency stop button, turn off the main power disconnect switch on the main switchboard, place your lock and identification tag on the disconnect switch and lock the power off to avoid the danger of serious injury to yourself and other workers. After locking off all the electrical power, bleed off all hydraulic and pneumatic systems, secure all parts that can fall and take other specific precautions required for the job being performed. Warn operators and others in the proximity that you are working on the Press.

	<p>CAUTION</p> <p>Maintenance that requires a door equipped with a safety lock to be opened, is only permitted if the door remains open and is within the Certified Operator's direct vision during the entire time required to complete the maintenance.</p>
---	--

2. Before performing any electrical maintenance, inspection or adjustment in which the terminal box, switchboard may be opened and terminals and wires can be touched, turn off the main power disconnect switch on the main switchboard or turn off power from the site's power supply to the Press, and lock and tag the switch in the off position. Bleed or discharge all capacitors, and always test for the absence of electricity before contacting electrical parts. All electrical wiring should be considered live until it is tested by a qualified worker.

	<p>CAUTION</p> <p>Because of the potential of an electrical shock, never use a wet rag when cleaning around electrical equipment.</p> <p>Do not permit fluids of any kind to leak into electrical circuits or devices.</p>
---	---

3. Power supplied to the Press may in some cases be supplied not only to the Press main switchboard but also to accessory devices. In addition, in some cases console signals are also input to such devices from the Press switchboard, so turn off both the main power switch on the Press switchboard and the power supply from the site to these devices when performing maintenance and inspections on these devices.
4. In some cases console signals are also input to such to the main switchboard in from the accessory devices, so turn off both the main power switch on the Press switchboard and the power supply from the site to these devices when performing maintenance and inspections on the main switchboard.
5. Never make any modifications to the control devices or inside the switchboards. Doing so is dangerous as this may disable the device or result in malfunction, leading to accidents and serious injuries.
6. Maintenance and inspection operations should be carried out only by experienced mechanics and electricians who are properly trained with respect to the Press and equipment and familiar with the instructions and precautions in this manual.

Residual Current Device

The Press environment is equipped with an industrial residual-current device (RCD) - also referred to as a residual-current circuit breaker (RCCB) or ground-fault circuit-interrupter (GFCI).

The RCD disconnects a circuit whenever it detects that the current is not balanced between the energized conductor and the return neutral conductor.

- Landa will initially set the RCD to the environment's requirements, and supply the customer with the correct settings
- It is the site owner's responsibility to periodically check the RCD to make sure the settings have not been changed or modified. It is also incumbent upon the site owner to test the RCD periodically.
- The response time of the RCD will not exceed 0.15 seconds

Fire Extinguishing Equipment

At least one suitable fire extinguisher (ABC* powder extinguisher) with at least ten extinguishing units (LE) must be kept near to the Press during service. References must be made to the location of the extinguisher in accordance with local accident prevention regulations. Depending on the site's size, more fire extinguishers may be required.

* ABC type: Mono-ammonium phosphate, ABC dry chemical, ABE powder, triclass, or multipurpose dry chemical is a dry chemical extinguishing agent used on Class A, B, and C fires. It uses a specially fluidized and siliconized mono-ammonium phosphate powder.

PQC Safety Precautions

- To ensure operator safety, never touch the operation keys or icons when your hands are wet. Also if a sheet key (any key on the PQC control panel covered with plastic film) is torn open, do not touch it directly with your bare hands.
- Do not place objects or foreign matter on the sheet keys. Also do not attempt to operate the sheet keys using a pen, tool, or other instrument. This could tear or deform the sheet keys.
- If a sheet key is dirty, wipe it off using a soft cloth dipped in either water or a neutral detergent. If a sheet key is torn, contact Landa Customer Care Center, and do not wipe the sheet key with a wet cloth.
- Use your fingers to operate the keys on the touch panel. Do not use a pen, a tool, or other such implement for this purpose.
- Never remove the front or rear panels of any electrical device. Doing so may result in electric shock or cause the device to malfunction.
- Be sure to turn off the power before cleaning the exhaust vents on the rear of any electrical device. Never clean the exhaust vents with power left on
- Do not insert foreign objects, fingers or other items into the exhaust vents on the rear of any electrical device
- When moving any electrical device, be careful not to allow hands, feet or other object get caught in the gap below the device or the casters

Steps and Hand Grips

- Hold a grip at a side cover, face the Press, and place your feet on the steps to get on or get off a printing unit. Do not hold any adjusting knob.
- Do not stand on any place other than steps.
Check the steps and the grips for oil before and after each use. Clean the steps and grips of any oil. If any grip or step is damaged, discontinue use and contact Landa Customer Care Center.
- Secure the steps and the grips on the Press body. If any bolt or screw is loosened, tighten it immediately.

Corrective Measures

- If you should discover any irregularity in the press, stop operation immediately, correct the cause for the irregularity, and restore the press to its normal operating status as described in this manual or in the manuals of the accessory devices.
- Never restart the press before it has been restored to its normal operating status. If it cannot be restored to its normal operating status, contact Landa Support immediately.

Periodic Inspection

- Be sure to perform periodic inspections for items related to the Press functioning according to the maintenance procedures. Operating the Press when any irregularities in the function of the safety devices and other parts are present could lead to accidents and serious injuries.
- Be sure to periodically inspect items requiring replacement, such as consumable or wearable parts, lubricating oils, etc., according to the maintenance procedures. If replacement is necessary, do so promptly to restore the Press to its normal operating status. Failure to replace parts promptly may lead to damage to the Press.
- Be sure to periodically check the RCD to make sure the settings have not been changed or modified, and also test the RCD on occasion to make sure it is working as required.

Noise Emissions

The A-weighted emission sound pressure level at workstation (cockpit) < 82.6 dBA.

The measured* values of sound pressure level (SPL) dB(A) emitted from the product are as follows:

- Feeder – 92 dB
- Delivery – 87 dB

Please act according to the local laws regarding the measurements of the actual acoustic noise in the entire site and the use of personal ear protection.

*Measured in printing mode, 1 m from the envelope, h=1.6 m

Safety Cleaning of the Press and Equipment

Cleaning Solvent

Only use the cleaning solvents with the following properties • Flash point in excess of 55° C (131° F)

- Benzene content below 0.1%
 - Toluene and xylol content below 1 %
 - Content of aromatic compounds (> C9) below 1 %
 - Cleaning solvent free of halogenated hydrocarbons, terpenes, n-hexane, secondary amines and amides and nonylphenoles
 - Cleaning solvent free of other hazardous contents
- Observe safety precautions on the solvent container and comply with the Safety Data Sheet. Place cleaning solvent's hoses so that a person cannot fall or stumble over them. When running them on the floor, protect them with covers.
 - Do not place cleaning solvent near the drying system. Remove all sources of ignition from the Press room



CAUTION

Do not attempt to clean the Press or equipment unless you have received proper training and have read and understand the precautions and procedures in this manual.

Do not clean the Press or equipment whilst it is moving. Moving machinery is dangerous. Serious injuries can result if you omit steps from the operating procedures. Be sure to always stop the Press, and perform the cleaning work by inching the Press, checking for safety, and then cleaning as follows:

- a. Stop the Press with the emergency stop/safe button and verify that the button is in the locked position.
- b. Open the cover at the area that the service is to be performed.
- c. Push in the Tune Up button to release the safety lock, and inch the Press to the work area. Lock the emergency stop/safety button immediately. If two or more operators are going to perform maintenance functions, they must each operate their own emergency stop button. The Press should be inched by the lead operator only. Covers can be opened only when the operators are performing these essential maintenance functions.
- d. Upon completion of the service, repeat the above steps for the next area maintained or serviced.



CAUTION

Close attention must be paid when running the Press by reverse inching since the Press will run in the opposite direction from that of normal operation, and the operator's hands may become caught or some other serious accident may occur as a result.

- When two or more people are cleaning, the lead operator should inch the Press only after he is sure all pressmen, helpers, etc. are clear of moving parts.
- Do not clean moving rollers by hand. Do not hand-pick hickies from moving rollers.
- When using compressed air for cleaning, use only a nozzle that complies with local and national regulations.
- For safe and proper cleaning, select the right chemical for the cleaning application. Read the label to learn safety precautions for each chemical you will be using, and consult the Safety Data Sheet (SDS) for that chemical. Do not use strongly volatile solvents (e.g., benzene, thinner, gasoline, etc.) as cleaning solvents as their use could damage the Press and equipment and could also lead to serious injuries such as lead poisoning and also increase the risks of fire.
- Use extreme caution when pouring or mixing chemicals to prevent splashing in face or eyes. Always wear gloves and eye protection when handling hazardous chemicals or materials.
- Store toxic or flammable liquids away from the work area of the Press room in properly labeled and approved containers.
- Mark area containers containing toxic or flammable liquids or materials with a caution or hazard sign.
- Keep hazardous area free of paper, rags or other combustible materials. Always dispose of solvent soaked rags in safety containers.
- Do not store flammable, combustible or volatile substances near the Press and specifically near heaters, motors, or in direct sunlight.
- Do not store toxic or corrosive substances on a high shelf where it could spill or drop on some- body.
- Do not transfer chemicals or solutions from original containers with warnings and emergency procedures, except where the transfer containers are marked with similar warnings/procedures labels.
- Use only solvents with a flash point of 55° C (131° F) or greater to lessen the possibility of fires. Always use water when cleaning the coater so that the dryer unit does not ignite.
- Wipe away any solvents that adhere to the Press immediately using a cloth or rag. Otherwise the surfaces of the covers and footboards of the Press may peel or become discolored.
- When using cleaning solvents, verify with local authorities if any other safety measures are required when using flammable liquids in the vicinity of the Press.

Cockpit Monitors

The Cockpit monitors are made of glass; strong impacts may break it.

- If a monitor is dirty, clean it lightly, wiping it with a soft, dry cloth that contains a little ethanol.
- Never let the monitors contact with water, neutral detergent, common window polish or organic solvent directly as this may damage the touch panel.
- Do not press on the monitors with a pen, screwdriver, or other pointed object. Doing so could scratch or damage the monitor. Do not subject the monitors to any force or press any harder than is necessary. Doing so could damage the monitors. The system trouble caused by dis- regarding the above is out of the scope of guarantee.
- Always turn off the main power (or the power of the device) before cleaning the monitors to prevent operating the Press inadvertently.
- The monitors should always be operated by finger touch. Do not use hard or sharp objects to operate the monitor.
- Avoid extended display of fixed patterns, as this may result in residual images appearing for long periods.

LCD Control Panels

The LCD control panels are made of glass; strong impacts may break it.

- If a control panel is dirty, clean it lightly, wiping it with a soft, dry cloth that contains a little ethanol.
- Never let the control panels contact with water, neutral detergent, common window polish or organic solvent directly as this may damage the touch panel.
- Do not press on the control panels with a pen, screwdriver, or other pointed object. Doing so could scratch or damage the monitor. Do not subject the control panels to any force or press any harder than is necessary. Doing so could damage the panels. The system trouble caused by disregarding the above is out of the scope of guarantee.
- Always turn off the main power (or the power of the device) before cleaning the control panels to prevent operating the Press inadvertently.
- The control panels should always be operated by finger touch. Do not use hard or sharp objects to operate the panels.
- Avoid extended display of fixed patterns, as this may result in residual images appearing for long periods.

Handling of Accessory Devices

Always refer to the operation manual provided by the manufacturer of each accessory device, and then consult or receive instruction from the manufacturer before handling or maintaining the device.

FCC Compliance

This equipment has been tested and found to comply with the limits for a Class A digital device, pursuant to part 15 of the FCC Rules. These limits are designed to provide reasonable protection against harmful interference when the equipment is operated in a commercial environment. This equipment generates, uses, and can radiate radio frequency energy and, if not installed and used in accordance with the instruction manual, may cause harmful interference to radio communications. Operation of this equipment in a residential area is likely to cause harmful interference in which case the user will be required to correct the interference at his own expense.

The following statement is relevant for BIB station

FCC and Industry Canada Compliance Statements

This device complies with FCC Rules Part 15 and with Industry Canada's licence-exempt RSSs. Operation is subject to the following two conditions:

- (1) This device may not cause harmful interference
- (2) this device must accept any interference received including interference that may cause undesired operation.

Le présent appareil est conforme aux CNR d'Industrie Canada applicables aux appareils radio exempts de licence. L'exploitation est autorisée aux deux conditions suivantes :

- (1) l'appareil ne doit pas produire de brouillage;
- (2) l'utilisateur de l'appareil doit accepter tout brouillage radioélectrique subi, même si le brouillage est susceptible d'en compromettre le fonctionnement.

Note: This equipment has been tested and found to comply with the limits for a Class B digital device, pursuant to part 15 of the FCC Rules. These limits are designed to provide reasonable protection against harmful interference in a residential installation. This equipment generates, uses and can radiate radio frequency energy and, if not installed and used in accordance with the instructions, may cause harmful interference to radio communications. However, there is no guarantee that interference will not occur in a particular installation. If this equipment does cause harmful interference to radio or television reception, which can be determined by turning the equipment off and on, the user is encouraged to try to correct the interference by one or more of the following measures:

- Reorient or relocate the receiving antenna.
- Increase the separation between the equipment and receiver.
- Connect the equipment into an outlet on a circuit different from that to which the receiver is connected.
- Consult the dealer or an experienced radio/TV technician for help.
- This Class B digital apparatus complies with Canadian ICES-003.
- Cet appareil numérique de la classe B est conforme à la norme NMB-003 du Canada.

Changes or modifications to this equipment not expressly approved by the party responsible for compliance (Landa Digital Printing corp.) could void the user's authority to operate the equipment.

Precautions on Press Installation and Movement

Press installation and movement must be performed only by specialists or persons having specialized knowledge.

Coating Unit Safety



CAUTION

- When handling blades always wear cut resistant gloves.
- When manually cleaning, be careful of the razor sharp doctor blades when wiping off the application chamber to the doctor blades.

Action to be Taken in Case of Hazards

- Ask for help and inform all persons in the Press room of hazardous situations.
- If a part of your body is caught between rollers or cylinders, press the Emergency stop push button, and call for emergency medical attention. If caught between rollers, remove the rollers. If electrical shock occurs, immediately turn off the main switch of the Press.
Do not touch the person who has been shocked.
- In the event of a fire, use fire extinguishers and try to put out the fire if possible.
- If a person is wounded or burned, give him or her first aid and seek immediate medical attention. If hazardous chemicals contact an eye or skin, are inhaled, or are ingested, seek immediate medical attention

Hoses and Pipes

Hoses and pipes used for combustible materials should be conductive and electrically grounded.

Ink and Coating

- Only use the ink intended for the Press, as certified by Landa
- Use the coating with a flash point over 55°C (131°F)

Coating Unit Dryer Safety

	<p>WARNING</p> <p>Up to 480* volts</p> <p>High voltage inside the Coating Unit's IR Dryer electrical enclosure can cause severe personal injury or death</p>
---	--

*Voltage depending on actual mains supply voltage.

Although every precaution has been taken to make the IR dryer safe to operate, certain situations may arise that could endanger or cause serious injury to personnel working with or operating the dryer.

Please read and follow all of the safety messages in this manual. Obey all safety labels on the equipment. All pressroom personnel should be made aware of each safety message and be instructed on the proper usage the IR dryer.

	<p>WARNING</p> <p>Up to 480* volts</p> <p>Before working on the dryer:</p> <ol style="list-style-type: none">1. Turn the rotary power switch OFF.2. Disconnect main power into dryer cabinet.3. Use lock-out/tag-out safety devices at the main circuit cabinet.4. Test power inside electrical enclosure using a voltmeter at the rotary power switch terminals.
---	--

*Voltage depending on actual mains supply voltage.

	<p>WARNING</p> <p>IR Lamp Intensity</p> <p>High intensity IR lamps inside IR Drying Head assembly. Do not look directly at lamps while IR Dryer is on. Can cause eye damage.</p>
---	--

	<p>WARNING</p> <p>IR Lamp Temperature</p> <p>IR lamp temperature will exceed 600°C (1,000°F)</p>
---	--

**WARNING****Do not touch lamps after running**

Allow at least 10 minutes for hot lamps to cool down.
Touching a hot IR lamp will cause severe burn and injury.

**WARNING****Pressurised steam in cooling may operate at 115°C (240°F)**

Do not disconnect any part of cooling system until temperature has dropped below safe limits.
Severe burn will result if hot fluid contacts skin

**CAUTION****Do not touch lamps**

Do not touch IR lamps directly with your hand.

- Always take care when working close to moving parts in the Press.
- Never touch hot surfaces in the areas around the IR Drying head.
- Never look directly in to the IR lamps.
- Always keep solvents, washing materials and other inflammable liquids away from the areas around the IR drying head.
- Washing liquids for manual cleaning must have a flash point over 55°C (131°F). Make sure that the liquid does not come near the dryer or any other heated surfaces. Make sure that the dryer is cooled down to room temperature before cleaning.
- Always observe and follow current safety regulations issued by business organizations or the authorities. Follow the safety data sheet's information for the ink and/or the varnish.
- Ensure that approved fire fighting equipment is located in the immediate vicinity of the IR dryer equipment. We recommend Carbon dioxide extinguishers.
- Only ink and varnish with no lower explosion limit (LEL) expressed in the safety data sheet may be used together with the dryer. This means that during heating up in the dryer there is no risk for an explosive atmosphere.
- Always keep the IR drying head clean from small particles such as paper, dust and ink.
- Never clean IR drying head or IR lamps above room temp.
- When using washing and cleaning solvents the safety information given by the solvent manufacturer must be observed.
- The dryer must be connected to the Press emergency stop circuit

All equipment is designed and manufactured to International Safety Standards to ensure that the health and safety of the operator is protected at all times. This is conditional to equipment being installed correctly by qualified personnel and operating instructions are strictly adhered to.

Everyone who is required to work with the drying equipment in any way, i.e. installers, operators, service engineers etc., must be made familiar with these safety instructions.

- The equipment is designed for the accelerated drying of UV or aqueous inks and coatings. No attempt should be made to dry alternative materials unless these have been cleared by the supplier for this drying technique.
- This equipment is not designed for use in hazardous areas (i.e. it is not flameproof)
- UV and IR reflector systems generally run at extremely high temperatures. It is therefore necessary to check that any exposed parts which may be touched by an operator or personnel are kept below a temperature of 60°C (140°F), dependent on the material type.
- If you find that any surface is above 60°C (140°F), please contact Landa Customer Care Center

The UV and IR curing equipment works at high voltages. It is therefore essential that should any fault develop, the operator is made aware that he should do the following:

- Switch the equipment off immediately. make no attempt to service the equipment himself, but call a qualified electrician, trained to service this type of equipment.

With lamps running at up to 800°C, there is always a risk of fire should any paper or materials get jammed under or in the lamp vicinity, or in the event of build-up of fluff, dirt or powder within the lamp housing.

Should such a situation occur, the operator must do the following:

- Switch off the equipment immediately.
- If a fire extinguisher is to be used, make sure it is of a type which is suitable for use with electrical equipment.
- A suitable fire extinguisher should be available near the unit.

This equipment is fitted with high temperature lamps. It is not designed to operate close to low flash point materials (solvents, etc.).

Cabinet Cooling

The cabinet cooling fan should be checked weekly and kept clear of any material which might clog or stop its operation.

- The cabinet filters should be cleaned every two months and replaced yearly.

Lamp Head Cleaning

The air inlets in the reflector head should be regularly checked, so that it is ensured that they have not become blocked with dust or powder and that the air passages are clear.

It should be noted that the reflector head runs at very high temperatures and the inside components become very hot during operation of the machine and the equipment. Therefore, when maintaining the equipment, a reasonable time should be allowed before access is attempted. Alternatively, precautions should be taken.

U.V. Radiation

UV radiation is generated from UV lamps and can be harmful if operator exposure exceeds recommended levels, (see U.V. Permissible Exposure Levels in this section).

- All equipment is adequately guarded, shielded and interlocked to prevent accidental operator exposure.
- Equipment should be annually checked for UV radiation levels. Please contact Landa Support for availability and cost.
- Radiation is in the wavelength bands A B and C

Exposure to UV radiation can result in:

- Reddening of skin
- Headaches
- Sore eyes

If any symptoms appear, investigations should be carried out.

First Aid

- On skin no treatment can immediately be made, however, soothing cream can be applied to the affected area
- For exposure to eyes medical attention should be sought immediately

Ozone Gas

Ozone is generated by reaction of short-wave UV radiation on air and is a gas which readily reverts to oxygen when mixed with atmospheric air as it is removed from the source of UV radiation. Quantity of ozone produced equates to 0.001 cu.ft/kW hr.

- Ozone checks using a Dräger measuring device should be carried out every 6 months, or immediately, if an operator can smell ozone. Please contact our service department for availability and cost.
- Outlet duct concentration is 0.3 PPM in a typical system. Threshold limit value is 0.1 PPM in a working atmosphere.

Symptoms of ozone present in the working environment.

Ozone has an irritant action on the mouth and throat and the Factory Inspectorate recommendation is that the level of ozone in the atmosphere of a factory should not exceed 0.1 PPM (TLV). Most people can smell ozone at about one third of the TLV. If there is any doubt as to whether the TLV is being exceeded, the company should take measurements to check whether the extraction system is adequate to keep the atmosphere well below 0.1 PPM.

If detected:

- a. Shutdown system.
- b. Check ducting for leaks. (where applicable)
- c. Before starting check working area with ozone meter.

If a person is overcome by ozone, the following precautions should be adopted:

- a. Remove the patient to a warm uncontaminated atmosphere and loosen tight clothing at the neck and waist.
- b. Keep the patient at rest.
- c. If the patient has difficulty in breathing, oxygen may be administered provided that suitable apparatus and a trained operator are available.
- d. If breathing is weak or has ceased, artificial respiration should be started. The mouth-to-mouth or mouth-to-nose methods are recommended.
- e. Seek medical aid.

Ozone poisoning should be treated symptomatically. This may include bed rest, analgesics to relieve pain, and antibiotics as may be prescribed by a medical practitioner.

Mercury

- Mercury is a silver colored liquid which is contained in the dryers' medium pressure mercury arc lamps. In the case of Prim-arc lamps this is typically 0.5 - 2g.
- Under normal operating conditions mercury presents no hazard as it is contained in the dryers' quartz tube of the lamp.
- Mercury is toxic and must not be consumed or handled directly on the skin.
It is recommended that protective gloves and eye protection is worn when handling UV or IR lamps.

In the event of spillage:

- a. Use personal protective equipment to protect the eyes, the skin, ingestion and inhalation.
- b. Contain the spill with wet sand and recover by vacuum suction. Do not use a vacuum cleaner as it will become contaminated and be a source of mercury vapor.
- c. Spread a 50/50 mix of calcium hydroxide and flowers of sulphur over the affected area and allow to dry. Repeat until there is no visible trace of mercury. Special attention should be given to cracks and imperfections in the affected surface.

Lamp Disposal

Sensible precautions should be followed when disposing of mercury arc lamps.

- a. Wrap lamp in a plastic bag, seal and repack in the box provided.
- b. Dispose of the lamp using an approved waste management company or refer to your local authority

Safety Alert Labels



Locations of high power voltage and rotators or other mechanical operating parts are indicated by safety alert labels.





Pay careful attention when performing operations at these locations.

Also make sure that these safety alert labels are always visible. If a label should peel off or become dirty or damaged, replace it.

	<p>WARNING</p> <p>The safety alert labels are provided for operator and service personnel safety</p> <p>Always comply with the warnings depicted on the safety alert labels.</p>
---	--

The following safety alert labels are affixed to the S10 Nanographic Printing Press.





Safety Alert Label	Details	
 <p>Category: Warning Standard: ISO 7010:W017</p>	<p>Title/Meaning/Referent</p> <p>Function:</p> <p>Hazard:</p> <p>Human behavior that is intended to be caused after understanding the safety sign's meaning:</p>	<p>Warning; Hot surface</p> <p>To warn of a hot surface</p> <p>Hot surface</p> <p>Taking care to avoid coming into contact with a hot surface</p>
 <p>Category: Warning Standard: ISO 7010:W024</p>	<p>Title/Meaning/Referent</p> <p>Function:</p> <p>Hazard:</p> <p>Human behavior that is intended to be caused after understanding the safety sign's meaning:</p>	<p>Warning; Crushing of hands</p> <p>To warn of a closing motion of mechanical parts of equipment</p> <p>Closing mechanical parts of equipments</p> <p>Taking care to avoid injury to hands when in the vicinity of equipment with closing mechanical parts</p>
 <p>Category: Warning Standard: ISO 7010:W012</p>	<p>Title/Meaning/Referent</p> <p>Function:</p> <p>Hazard:</p> <p>Human behavior that is intended to be caused after understanding the safety sign's meaning:</p>	<p>Warning; Electricity</p> <p>To warn of electricity</p> <p>Electricity</p> <p>Taking care to avoid coming into contact with electricity</p>



Safety Alert Label	Details	
 <p>Category: Warning Standard: ISO 7010:W022</p>	<p>Title/Meaning/Referent</p> <p>Function:</p> <p>Hazard:</p> <p>Human behavior that is intended to be caused after understanding the safety sign's meaning:</p>	<p>Warning; Sharp element</p> <p>To warn of a sharp element</p> <p>Sharp elements</p> <p>Taking care to avoid injury from sharp elements (e.g. needles, blades)</p>
 <p>Category: Warning Standard: ISO 7010:W025</p>	<p>Title/Meaning/Referent</p> <p>Function:</p> <p>Hazard:</p> <p>Human behavior that is intended to be caused after understanding the safety sign's meaning:</p>	<p>Warning; Counterrotating rollers</p> <p>To warn of counterrotating rollers</p> <p>Drawing-in movement</p> <p>Taking care when in the vicinity of counterrotating rollers</p>
 <p>Category: Warning Standard: ISO 7010:W018</p>	<p>Title/Meaning/Referent</p> <p>Function:</p> <p>Hazard:</p> <p>Human behavior that is intended to be caused after understanding the safety sign's meaning:</p>	<p>Warning; Automatic start-up</p> <p>To warn of automatic activation</p> <p>Automatically moving mechanical parts</p> <p>Taking care when in the vicinity of machinery with moving mechanical parts which may start automatically and thus unexpectedly</p>
 <p>Category: Warning Standard: ISO 7010:W020</p>	<p>Title/Meaning/Referent</p> <p>Function:</p> <p>Hazard:</p> <p>Human behavior that is intended to be caused after understanding the safety sign's meaning:</p>	<p>Warning; Overhead obstacle</p> <p>To warn of an overhead obstacle</p> <p>Overhead obstacle</p> <p>Taking care to avoid being struck by or walking into an overhead obstacle</p>



Safety Alert Label	Details	
 <p>Category: Warning Standard: ISO 7010:W027</p>	<p>Title/Meaning/Referent</p> <p>Function:</p> <p>Hazard:</p> <p>Human behavior that is intended to be caused after understanding the safety sign's meaning:</p>	<p>Warning; Optical radiation</p> <p>To warn of optical radiation</p> <p>Optical radiation (such as UV, visible radiation, IR)</p> <p>Taking care to avoid injury to eyes and skin when in the vicinity of optical radiation</p>
 <p>Category: Warning Standard: ISO 7010:W038</p>	<p>Title/Meaning/Referent</p> <p>Function:</p> <p>Hazard:</p> <p>Human behavior that is intended to be caused after understanding the safety sign's meaning:</p>	<p>Warning; Sudden loud noise</p> <p>To warn of sudden loud noise</p> <p>Sudden loud noise</p> <p>Taking care in areas where there can be sudden loud noise</p>
 <p>Category: Warning Standard: ISO 7010:W007</p>	<p>Title/Meaning/Referent</p> <p>Function:</p> <p>Hazard:</p> <p>Human behavior that is intended to be caused after understanding the safety sign's meaning:</p>	<p>Warning; Floor-level obstacle</p> <p>To warn of a floor-level obstacle</p> <p>Floor-level obstacle</p> <p>Taking care when in the vicinity of a floor-level obstacle</p>
 <p>Category: Warning Standard: ISO 7010:W041</p>	<p>Title/Meaning/Referent</p> <p>Function</p> <p>Hazard:</p> <p>Human behavior that is intended to be caused after understanding the safety sign's meaning:</p>	<p>Warning; Asphyxiating atmosphere</p> <p>To warn of asphyxiation</p> <p>Asphyxiation due to exposure to asphyxiating atmosphere</p> <p>Taking care to avoid exposure to asphyxiating atmosphere</p>



Safety Alert Label	Details	
 <p>Category: Warning Standard: ISO 7010 ref.</p>	<p>Title/Meaning/Referent</p> <p>Function</p> <p>Hazard:</p> <p>Human behavior that is intended to be caused after understanding the safety sign's meaning:</p>	<p>Warning; Contents under pressure</p> <p>To warn that contents remain pressurized even when power is disconnected. Pressurized ink can squirt out. Unplug from power source and release pressure before opening</p> <p>Pressurized contents</p> <p>To warn that contents remain pressurized even when power is disconnected.</p>
 <p>Category: Warning Standard: ISO 7010:W026</p>	<p>Title/Meaning/Referent</p> <p>Function</p> <p>Hazard:</p> <p>Human behavior that is intended to be caused after understanding the safety sign's meaning:</p>	<p>Warning; Battery charging</p> <p>To warn of batteries being charged</p> <p>Explosive atmosphere and acid</p> <p>Ensure adequate ventilation around the charging area and take care to avoid coming into contact with acid</p>
 <p>Category: Prohibition Standard: ISO 7010:P010</p>	<p>Title/Meaning/Referent</p> <p>Function:</p> <p>Hazard:</p> <p>Human behavior that is intended to be caused after understanding the safety sign's meaning:</p>	<p>Do not touch</p> <p>To prohibit touching objects/parts of an object</p> <p>Dangerous surfaces</p> <p>Not touching objects or parts of an object</p>

Safety Alert Label	Details	
 <p>Category: Prohibition Standard: ISO 7010:P015</p>	<p>Title/Meaning/Referent</p> <p>Function:</p> <p>Hazard:</p> <p>Human behavior that is intended to be caused after understanding the safety sign's meaning:</p>	<p>No reaching in</p> <p>To prohibit people putting hands into openings</p> <p>Injury to hands</p> <p>Not putting hands into designated openings</p>
 <p>Category: Prohibition Standard: ISO 7010:P024</p>	<p>Title/Meaning/Referent</p> <p>Function:</p> <p>Hazard:</p> <p>Human behavior that is intended to be caused after understanding the safety sign's meaning:</p>	<p>Do not walk or stand here</p> <p>To prohibit walking or standing on a designated area</p> <p>Areas which are unsafe for people to walk or stand on</p> <p>Keeping off a designated area</p>
 <p>Category: Prohibition Standard: ISO 7010:P019</p>	<p>Title/Meaning/Referent</p> <p>Function:</p> <p>Hazard:</p> <p>Human behavior that is intended to be caused after understanding the safety sign's meaning:</p>	<p>No stepping on surface</p> <p>To prohibit stepping onto a surface</p> <p>Surface unsuitable for stepping onto</p> <p>Not stepping onto an unsuitable surface</p>
 <p>Category: Prohibition Standard: ISO 7010:P012</p>	<p>Title/Meaning/Referent</p> <p>Function:</p> <p>Hazard:</p> <p>Human behavior that is intended to be caused after understanding the safety sign's meaning:</p>	<p>No heavy load</p> <p>To prohibit the placing of heavy objects on a surface</p> <p>Breakage due to heavy load</p> <p>Not placing any heavy objects on a surface</p>

Safety Alert Label	Details	
 <p>Category: Prohibition Standard: ISO 7010:P031</p>	<p>Title/Meaning/Referent</p> <p>Function:</p> <p>Hazard:</p> <p>Human behavior that is intended to be caused after understanding the safety sign's meaning:</p>	<p>Do not alter the state of the switch</p> <p>To prohibit any change of the current energetic or mechanical state of a machine or equipment</p> <p>Change of the current energetic or mechanical state of a machine or equipment</p> <p>Not switching</p>
 <p>Category: Prohibition Standard: ISO 7010 Not referenced</p>	<p>Title/Meaning/Referent</p> <p>Function:</p> <p>Hazard:</p> <p>Human behavior that is intended to be caused after understanding the safety sign's meaning:</p>	<p>Do not operate without guards</p> <p>To prohibit operating the equipment without guards</p> <p>Exposure to moving parts</p> <p>Operate with guards in place</p>
 <p>Category: Mandatory action Standard: ISO 7010:M007</p>	<p>Title/Meaning/Referent</p> <p>Function:</p> <p>Hazard:</p> <p>Human behavior that is intended to be caused after understanding the safety sign's meaning:</p>	<p>Opaque eye protection must be worn</p> <p>To signify that opaque eye protection must be worn</p> <p>Visible or invisible rays</p> <p>Ensuring that the people undergoing treatment by visible or invisible rays are wearing opaque eye protection</p>
 <p>Category: Mandatory action Standard: ISO 7010:M004</p>	<p>Title/Meaning/Referent</p> <p>Function:</p> <p>Hazard:</p> <p>Human behavior that is intended to be caused after understanding the safety sign's meaning:</p>	<p>Wear eye protection</p> <p>To signify that eye protection must be used</p> <p>Flying objects/particles</p> <p>Wearing eye protection</p>

Safety Alert Label	Details	
 <p>Category: Mandatory action Standard: ISO 7010:M003</p>	<p>Title/Meaning/Referent</p> <p>Function:</p> <p>Hazard:</p> <p>Human behavior that is intended to be caused after understanding the safety sign's meaning:</p>	<p>Wear ear protection</p> <p>To signify that ear protection must be used</p> <p>Noise</p> <p>Wearing ear protection</p>
 <p>Category: Mandatory action Standard: ISO 7010:M009</p>	<p>Title/Meaning/Referent</p> <p>Function:</p> <p>Hazard:</p> <p>Human behavior that is intended to be caused after understanding the safety sign's meaning:</p>	<p>Wear protective gloves</p> <p>To signify that protective gloves must be worn</p> <p>Hands striking or being struck by objects or being in contact with thermal or chemical materials</p> <p>Wearing protective gloves</p>
 <p>Category: Mandatory action Standard: ISO 7010:M002</p>	<p>Title/Meaning/Referent</p> <p>Function:</p> <p>Hazard:</p> <p>Human behavior that is intended to be caused after understanding the safety sign's meaning:</p>	<p>Refer to instruction manual/booklet</p> <p>To signify that the instruction manual/booklet must be read</p> <p>Not reading the instruction manual/booklet before starting work or before operating equipment or machinery</p> <p>Reading the instruction manual/booklet before starting work or before operating equipment or machinery</p>

Safety Alert Label	Details	
 <p>Category: Mandatory action Standard: ISO 7010:M021</p>	<p>Title/Meaning/Referent</p> <p>Function:</p> <p>Hazard:</p> <p>Human behavior that is intended to be caused after understanding the safety sign's meaning:</p>	<p>Disconnect before carrying out maintenance or repair</p> <p>To signify that the machine or the equipment, which is not connected to mains by a plug, has to be disconnected from all sources of power before carrying out maintenance or repair</p> <p>Machine or equipment running during maintenance or repair</p> <p>Disconnecting the machine or equipment before carrying out maintenance or repair</p>
 <p>Category: Mandatory action Standard: ISO 7010:M016</p>	<p>Title/Meaning/Referent</p> <p>Function:</p> <p>Hazard:</p> <p>Human behavior that is intended to be caused after understanding the safety sign's meaning:</p>	<p>Wear a mask</p> <p>To signify that a face mask must be worn</p> <p>Particulates in the air</p> <p>Wearing a face mask</p>
 <p>Category: Mandatory action Standard: ISO 7010:M023</p>	<p>Title/Meaning/Referent</p> <p>Function:</p> <p>Hazard:</p> <p>Human behavior that is intended to be caused after understanding the safety sign's meaning:</p>	<p>Use footbridge</p> <p>To signify that a footbridge must be used</p> <p>Moving vehicles, obstructions, or tripping or falling</p> <p>Using the footbridge to avoid dangerous areas</p>

Safety Alert Label	Details	
 <p>Category: Mandatory action Standard: ISO 7010:M012</p>	<p>Title/Meaning/Referent</p> <p>Function:</p> <p>Hazard:</p> <p>Human behavior that is intended to be caused after understanding the safety sign's meaning:</p>	<p>Use handrail</p> <p>To signify that the handrail must be used</p> <p>Falling, slipping or tripping</p> <p>Holding the handrail when using stairs, escalators or moving walkways</p>
 <p>Category: Mandatory action Standard: ISO 7010:M028</p>	<p>Title/Meaning/Referent</p> <p>Function:</p> <p>Hazard:</p> <p>Human behavior that is intended to be caused after understanding the safety sign's meaning:</p>	<p>Keep locked</p> <p>To signify that a cabinet or facility must be kept locked</p> <p>Accessing harmful substances or equipment are kept locked</p> <p>Ensures cabinets or facilities containing harmful substances or equipment are kept locked</p>

Safety Device Locations

Emergency Stop Buttons

There are ten emergency stop buttons located around the press:

- Four of the emergency stop buttons are located on the hand held controllers
- Six of the emergency stop buttons are physically located on the press

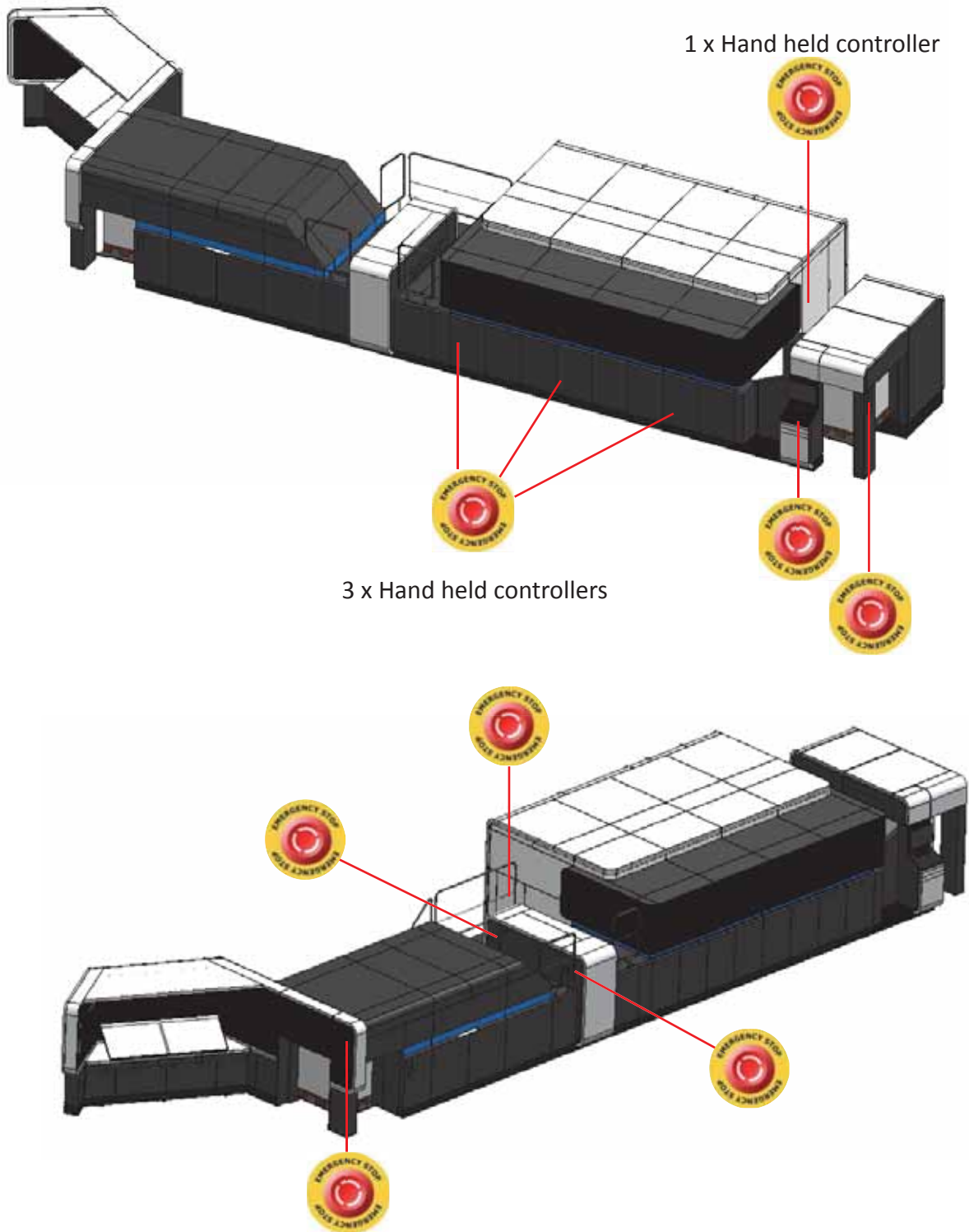

Safety Device	Activation Conditions
Feeder main panel emergency stop button	
Feeder main panel stop button	Normal stop. When this button is pressed during fast speed operation, the press slows down to slow speed and then stops
Handheld controller (front side) emergency stop button	Emergency stop
Handheld controller (service corridor) emergency stop button	
Delivery panel emergency stop button	
Delivery panel stop button	Normal stop. When this button is pressed during fast speed operation, the press slows down to slow speed and then stops.
LCD safety monitor	Emergency stop button, safety bar, and safety cover Indicators Motor overload indicators
Register unit acrylic cover	The press stops when this cover is opened during operation. Inching operation (25 mm) is possible by pressing the Tune Up button with a cover open. Be sure to lock the emergency stop button before performing operations under these conditions.
Feeder bottom door	
Delivery feeder side safety cover	The press stops when a cover, door or footboard is opened during operation. Forward or reverse inching operation (25 mm) is possible by pressing the Tune Up button with this cover, door or footboard open (forward inching (25 mm) only for the delivery front acrylic cover). Be sure to lock the emergency stop button before performing operations under these conditions.
Delivery front acrylic cover	
Press manual handle	When the manual handle is pulled, the press cannot be operated except with manual rotation. Be sure to stop the press and release the motor brake before using the manual handle. Never pull the manual handle when the press is running.
Main power	
High-pressure air source valve	Be sure to stop the press before operating the valve. When the valve is pressed down, the high-pressure air supply to the press machine is cut off and the residual air pressure inside the press machine is vented.
Feeder sucker section drive shaft universal joint cover	

Safety Device	Activation Conditions
Feeder sucker section forwarding sucker cover	
Feeder pile hoist chain sprocket cover (Operation and drive sides)	
Feeder drive chain cover	
Delivery sampling section cover	Emergency stop - refer to delivery area sensor
Delivery area sensor	
Feeder board open/close	In the feeder board lifted up condition, the press can be rotated. Forward and reverse inching operations (25 mm) are possible by pressing the Tune Up button. Be sure to lock the emergency stop button before performing operations under these conditions.
Sheet transport operation side cover	
Sheet transport drive side cover	
Delivery operation side cover	The press stops when this cover is opened during operation. At the same time, the paper size preset operations in each part become not possible.
Delivery drive side cover	

Chapter 3

Control Panels

Feeder Unit

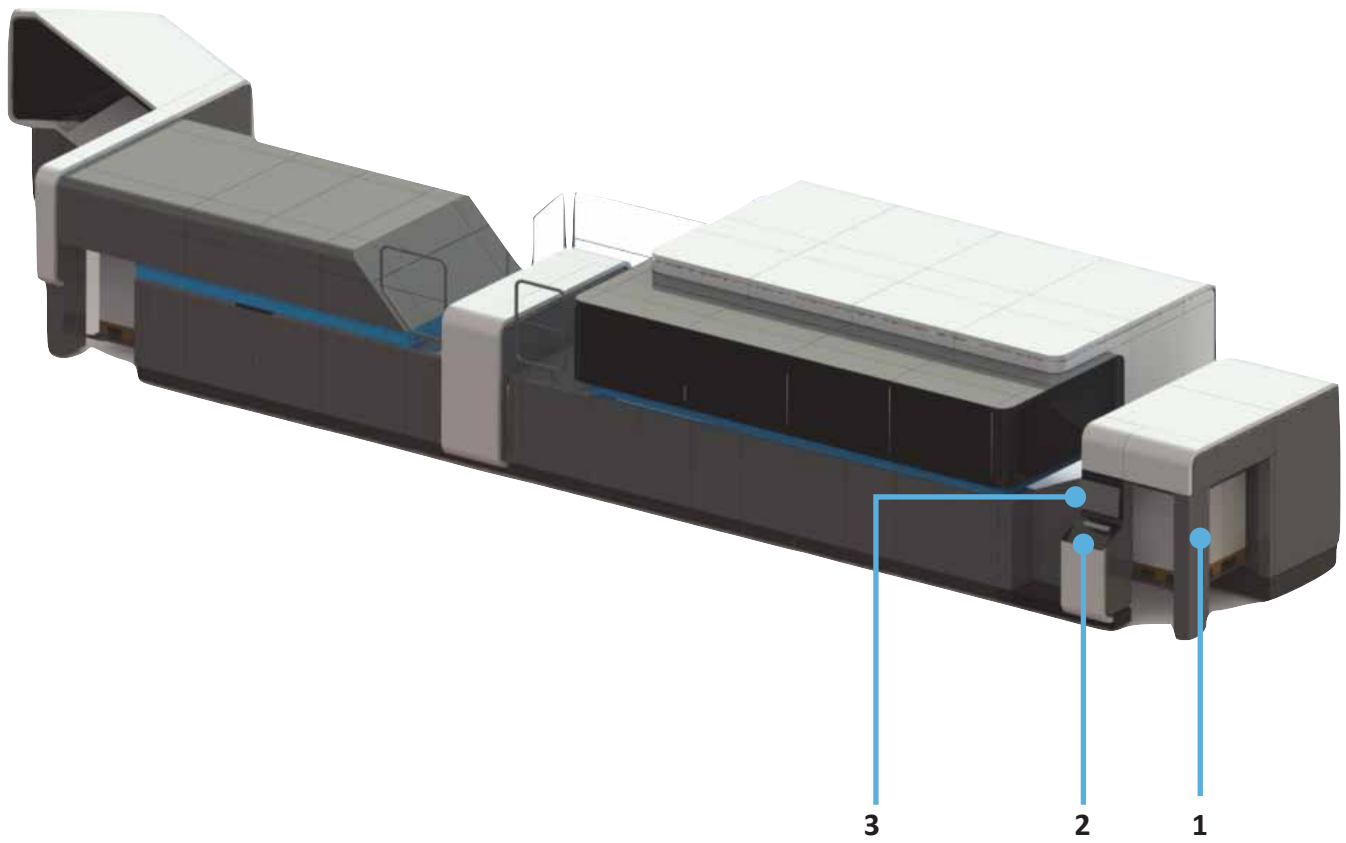

1. Feeder Unit Panel
2. Feeder Unit Side Panel
3. LIA Monitor

Feeder Unit Panel

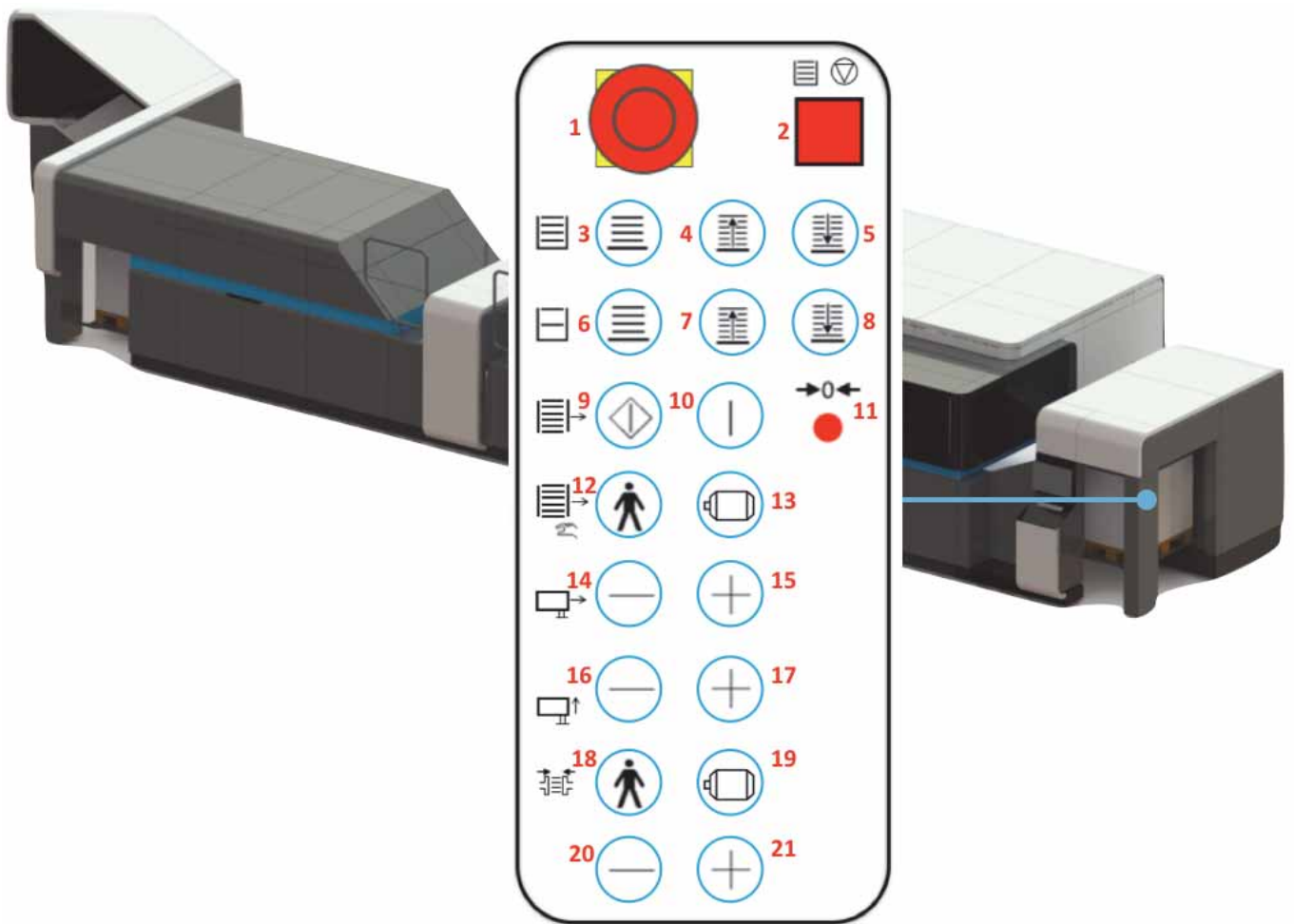

- 1. Emergency Stop button
- 2. Main Pile Stop button
- 3. Main Pile Hoist button
- 4. Main Pile Up button
- 5. Main Pile Down button
- 6. Auxiliary Pile Hoist button
- 7. Auxiliary Pile Up button
- 8. Auxiliary Pile Down button
- 9. Pile Sideways Control Start/Stop button
- 10. Sideways Control Pile Reset button
- 11. Home Position Return Indicator

- 12. Sideways Control Manual Operation button
- 13. Sideways Control Manual Operation button
- 14. Sucker Circumferential Adjustment button
- 15. Sucker Circumferential Adjustment button
- 16. Sucker Height Adjustment button
- 17. Sucker Height Adjustment button
- 18. Side Separator Switching button
- 19. Side Separator Switching button
- 20. Side Separator Adjustment button
- 21. Side Separator Adjustment button

- 1. Emergency Stop Button**
Stops the press in an emergency situation.
- 2. Main Pile Stop Button**
Stops the feeder main pile during descent.
- 3. Main Pile Hoist Button**
Enables the feeder pile to be lowered and raised.
- 4. Main Pile Up Button**
Raises the feeder main pile.
- 5. Main Pile Down Button**
Lowers the feeder main pile.
- 6. Auxiliary Pile Hoist Button**
Enables the auxiliary pile to be lowered and raised.
- 7. Auxiliary Pile Up Button**
Raises the auxiliary pile.
- 8. Auxiliary Pile Down Button**
Lowers the auxiliary pile.
- 9. Pile Sideways Control Start/Stop Button**
Activates the photoelectric sensor for automatic sideways control of the sheet pile board.
- 10. Sideways Control Pile Reset Button**
Resets the sideways control pile.
- 11. Home Position Return Indicator**
Shows when the 0 point recovery has been completed.
- 12., 13. Sideways Control Manual Operation Buttons**
Moves the sheet pile board.
- 14., 15. Sucker Circumferential Adjustment Buttons**
Moves the sucker box toward and away from the feeder.
- 16., 17. Sucker Height Adjustment Buttons**
Raises or lowers the height of the sucker box.
- 18., 19. Side Separator Switching Buttons**
Determines which direction the side separator moves.
- 20., 21. Side Separator Adjustment Buttons**
Moves the side separator toward and away from the sheet pile.

Feeder Unit Side Panel

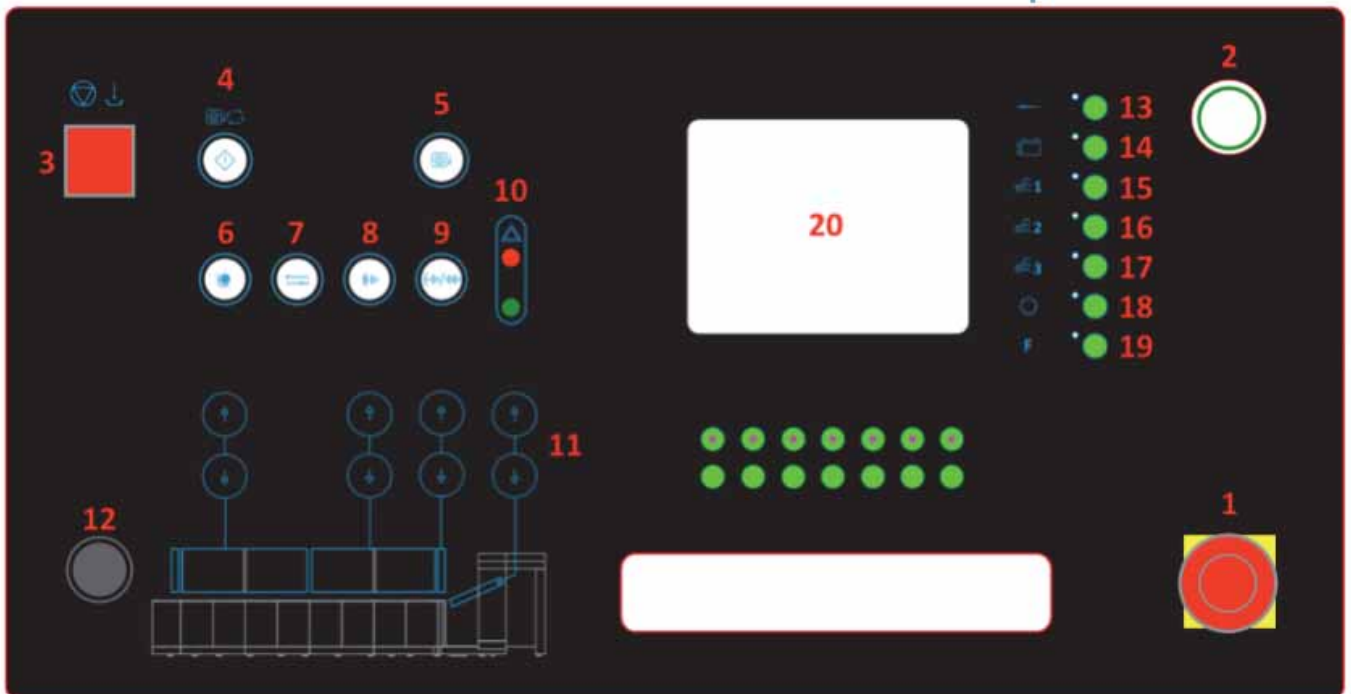
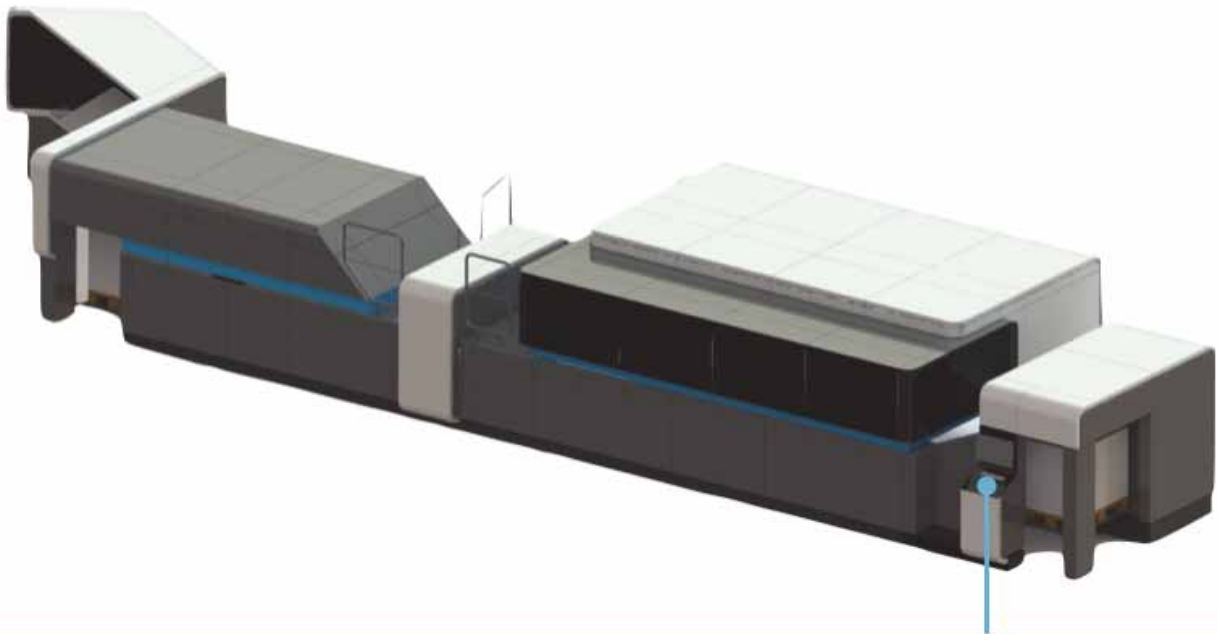

- | | |
|---|---|
| <ul style="list-style-type: none"> 1. Emergency Stop button 2. Enable Substrate Transport button 3. Stop button 4. Automatic Sheet Feeding button 5. Emergency Trip button 6. Tune Up button 7. Inch button 8. Slower button 9. Slow/Fast button 10. Safety indicator | <ul style="list-style-type: none"> 11. Doors/Panel Enable button 12. Open/Close Upper Doors/Panel 13. Print key 14. Sheet Size key 15. Air #1 key 16. Air #2 key 17. Air #3 key 18. Setting key 19. Monitor key 20. Touch Panel Monitor |
|---|---|

1. Emergency Stop Button

Stops the press in an emergency situation.

2. Enable Substrate Transport Button

Enables the substrate transport system cylinders to rotate after the Prepare to Print software button has been pressed.

3. Stop Button

This button, which uses a turn-locking system, immediately stops the press when it is running at slow or slower speeds. However, if the Stop button is pressed and the cylinders are engaged at slow or fast speed, the press runs at slow speed and only stops after the last sheet exits the delivery unit.

4. Automatic Sheet Feeding Button

Starts the automatic sheet feeding.

5. Emergency Trip Button

When pressed, the feeder stops and all the cylinders of all units disengage.

6. Tune Up Button

Prevents the press from running at slow or higher speed.

7. Inch Button

Used for inching the press.

8. Slower Button

Used for operating the press at a slower speed.

9. Slow/Fast Button

Used for running the press at slow and fast speeds.

10. Safety Indicator

This indicator illuminates when the press cannot run, for example, when the Stop button (3) is locked, the manual handle is inserted, or there is a malfunction of the main motor.

11. Doors/Panel Enable Button

Enables the Upper Doors and Access Panel 1 to be opened/closed or raised/lowered.

12. Open/Close Upper Doors/Panel Buttons

Open/Close the Upper Doors and raise/lower Access Panel 1

13. Print Key

Displays the status of the safety devices. The sheet feed operating switch is installed on the feeder.

14. Sheet Size Key

Perform fine tuning on the installed sheet size.

15. Air #1 Key

Adjust the feeder/delivery air volume.

16. Air #2 Key

Adjust the feeder/delivery air volume.

17. Air #3 Key

Adjust the feeder/delivery air volume.

18. Setting Key

Adjust the settings for the following:

Feeder unit side panel

- Feeder drive and safety device settings

Delivery unit front side panel

- Delivery raise and lower settings

19. Monitor Key

Displays the safety device operating status for both the feeder and delivery.

20. Touch Panel Monitor

See Touch Panel Monitor.

LIA Monitor

The operator can access a fully functional version of the Landa Interface Application via the LIA Monitor. The only difference between the LIA displayed on the LIA Monitor and the LIA displayed on the Landa Operator Cockpit is the size of the display.



Coating Unit Control Panels

There are two control panels located on either side of the coating unit.

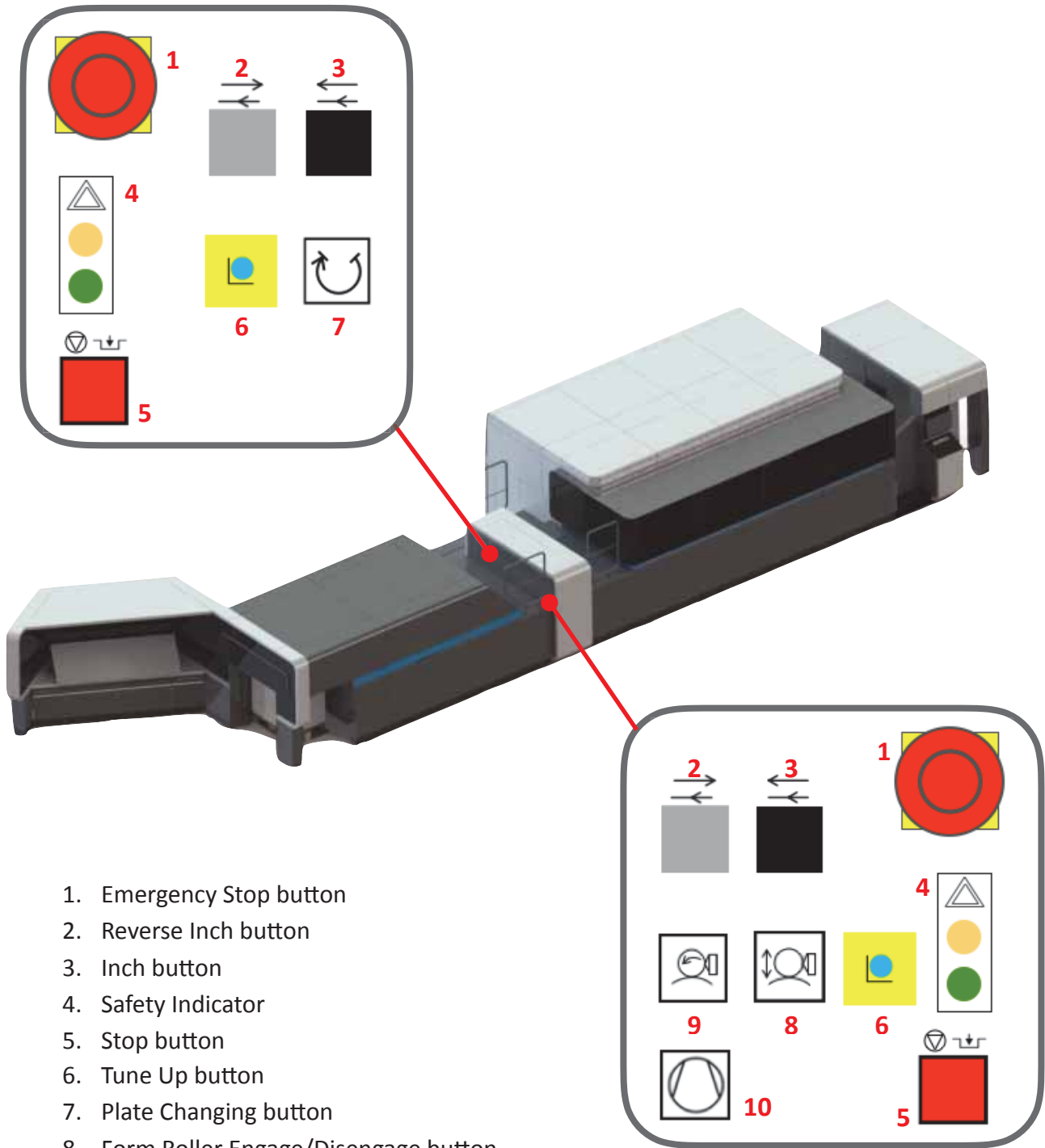

1. Emergency Stop button
2. Reverse Inch button
3. Inch button
4. Safety Indicator
5. Stop button
6. Tune Up button
7. Plate Changing button
8. Form Roller Engage/Disengage button
9. Form Roller Drive button
10. Varnish Pump button

- 1. Emergency Stop Button**
Stops the press in an emergency situation.
- 2. Reverse Inch Button**
Inches the coating unit cylinder in reverse.
- 3. Inch Button**
Inch the coating unit cylinder.
- 4. Safety Indicator**
These lights indicate whether it is okay and safe to run the coating unit.
- 5. Stop Button**
When pressed, the coating unit stops immediately.
- 6. Tune Up Button**
Prevents the press from running at slow or higher speed.
- 7. Plate Changing Button**
Press to perform plate changing.
- 8. Form Roller Engage/Disengage Button**
When this button is pressed it becomes illuminated and the applying roller is engaged.
Releasing the button disengages the applying roller.
- 9. Form Roller Drive Button**
When this button is pressed it becomes illuminated and the form roller begins to rotate.
Releasing the button stops the form roller from rotating.
- 10. Varnish Pump Button**
Press this button to start the varnish circulation pump.

Bypass Operation Panel

There are two bypass operation panels:

1. Front side of press
2. Delivery panels (front side)

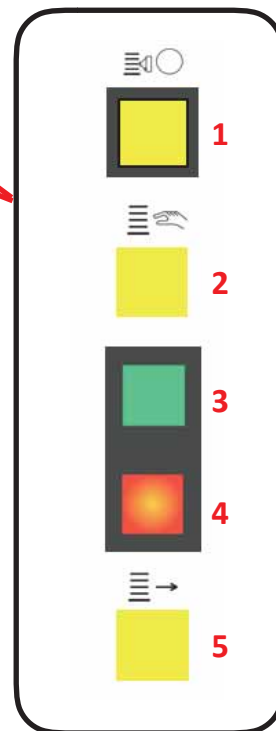
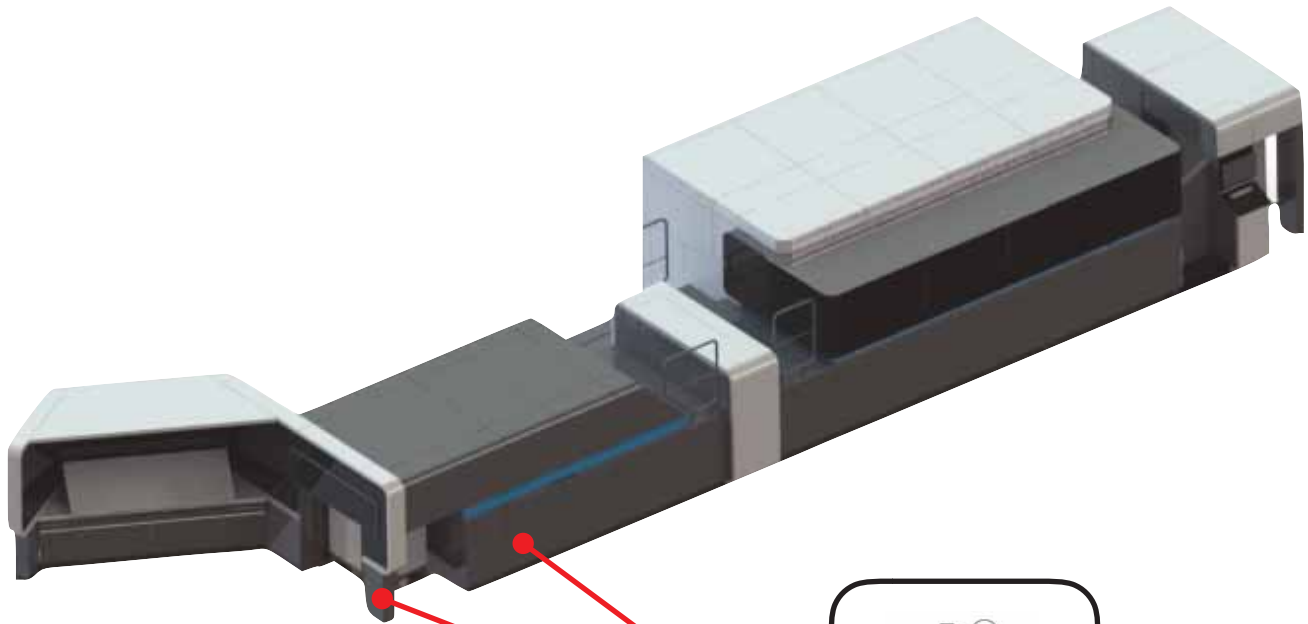

1. Bypassing Indicator Lamp
2. Top Sensor Bypassing button
3. Sensor Normal Operation Indicator Lamp
4. Sensor Detection Indicator Lamp
5. Bottom Sensor Bypassing button

1. Bypassing Indicator Lamp

Yellow light is illuminated when a sensor is bypassed.

2. Top Sensor Bypassing Button

When this button is pressed it becomes illuminated and the top sensor on the side where the button was pressed is bypassed.

3. Sensor Normal Operation Indicator Lamp

This green lamp illuminates when all the sensors located on the same side as this lamp are operating properly.

4. Sensor Detection Indicator Lamp

This red lamp illuminates when a sensor located on the same side as this lamp detects a person or object.

5. Bottom Sensor Bypassing Button

When this button is pressed it becomes illuminated and the bottom sensor on the side where the button was pressed is bypassed.

PQC Panel

The PQC panel contains the paper transport system's settings and controls, which directly influence the final print quality.

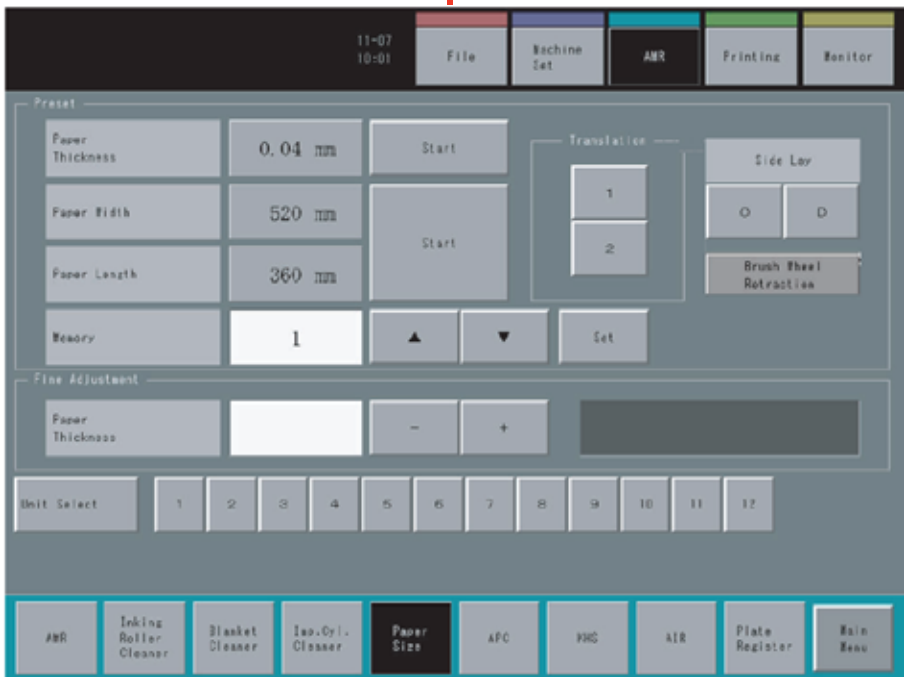
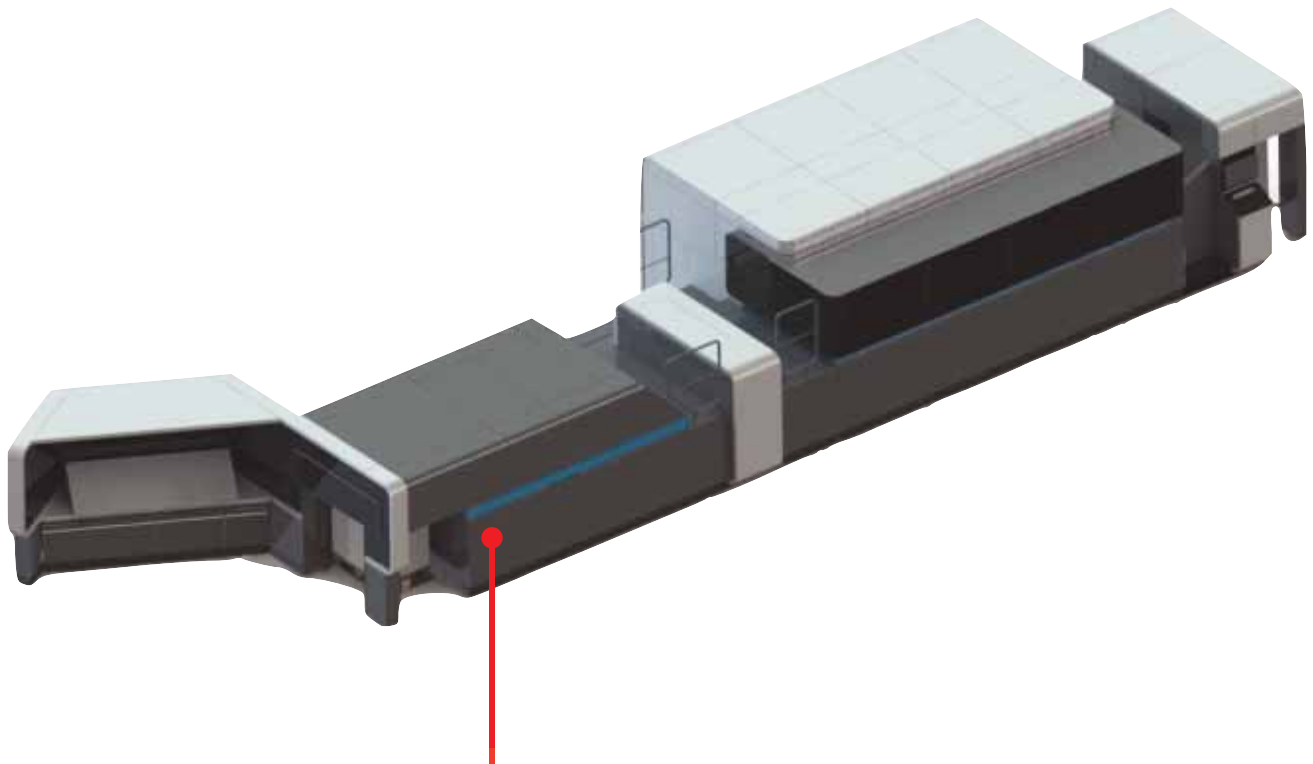

Hand Held Controllers

There are four hand held controllers located on the substrate transport system. Three of the hand held controllers can be accessed by opening the Front Doors 1-4, and the fourth hand held controller is located inside the service corridor (accessible by opening the Service Corridor door).

The operator can inch the press from the hand held controllers and stop the press in an emergency situation.

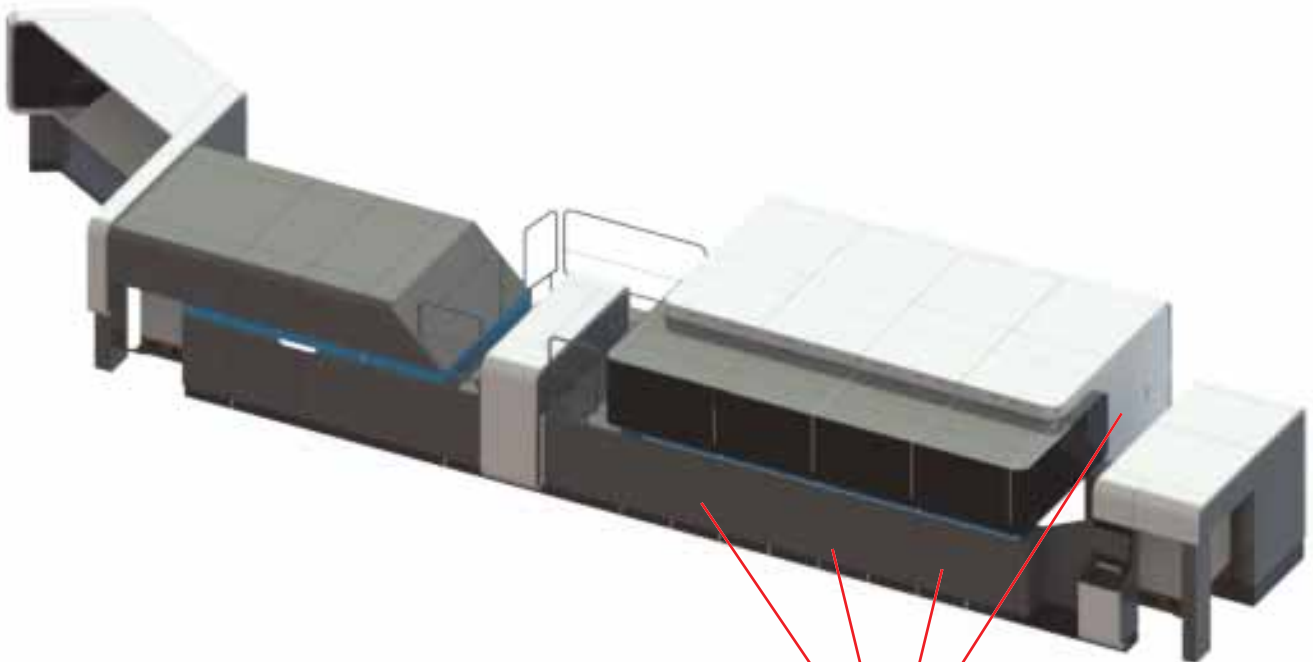

- 1. Tune Up button
- 2. Safety Indicator
- 3. Stop button
- 4. Emergency Stop button
- 5. Inch button
- 6. Reverse Inch button

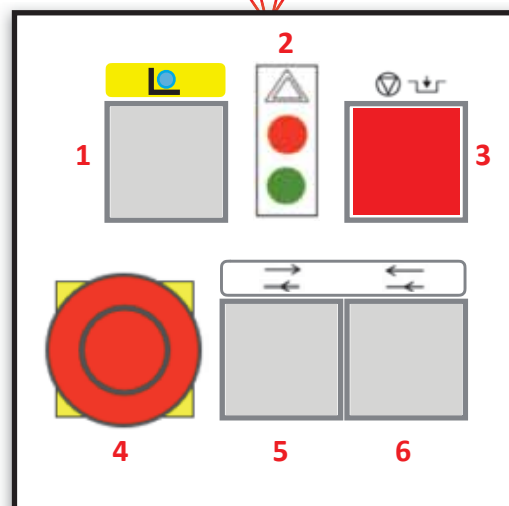

4 x Hand held controllers

1. Tune Up Button

Prevents the press from running at slow or higher speed

2. Safety Indicator

These lights indicate whether it is okay and safe to run the coating unit.

3. Stop Button

When pressed, the coating unit stops immediately.

4. Emergency Stop Button

Stops the press in an emergency situation.

5. Inch Button

Inch the coating unit cylinder.

6. Reverse Inch Button

Inches the coating unit cylinder in reverse.

Delivery Unit Panel

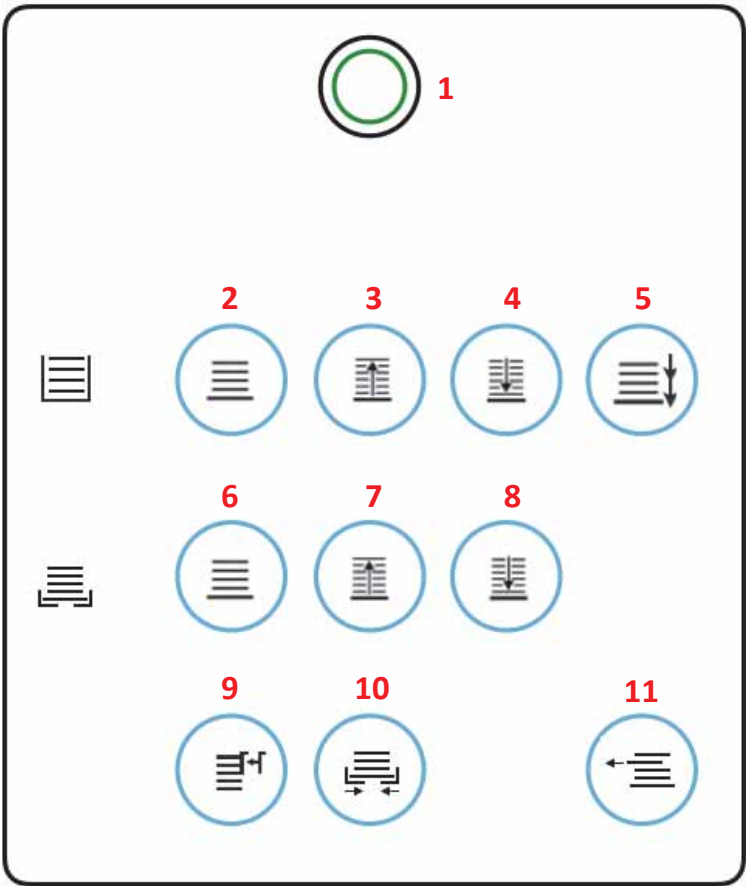
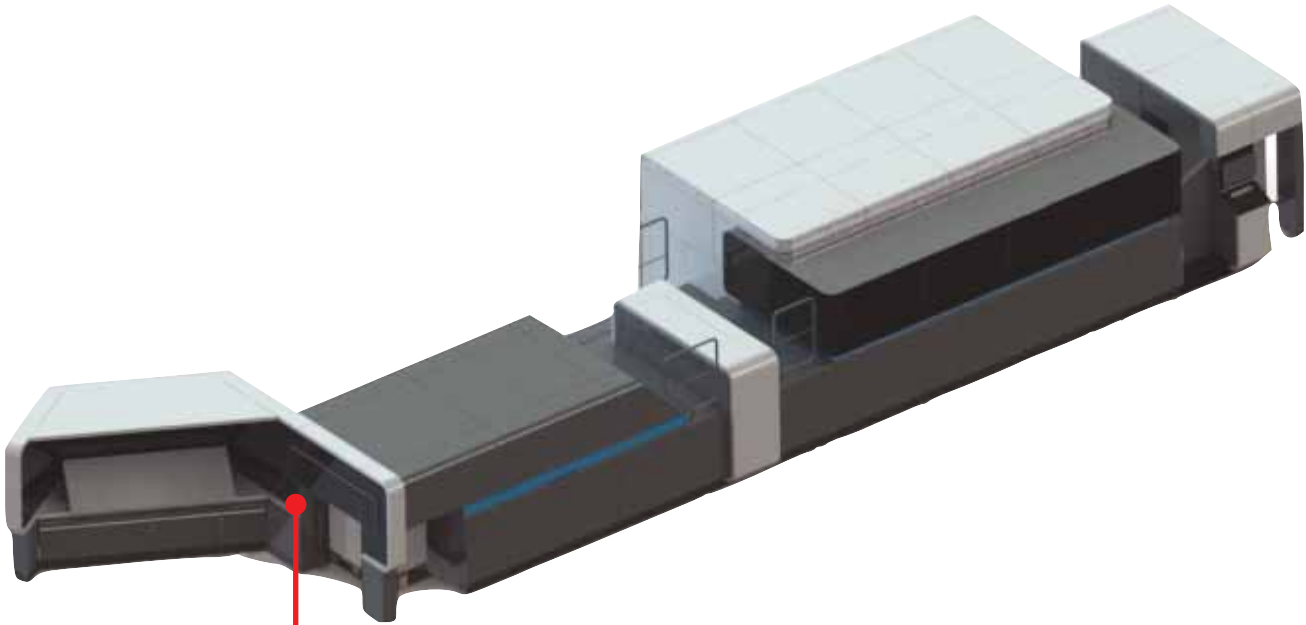

1. Enable Paper Transport button
2. Main Pile Hoist button
3. Main Pile Up button
4. Main Pile Down button
5. Main Pile Constant Lower button
6. Pile Board Guide Hoist button
7. Pile Board Guide Up button
8. Pile Board Guide Down button
9. Tail Edge Guide On/Off button
10. Pile Board Guide Open/Close button
11. Sampling On/Off button

1. Enable Substrate Transport Button

Enables the substrate transport system cylinders to rotate after the Prepare to Print software button has been pressed.

2. Main Pile Hoist Button

When this button is pressed, it illuminates and the pile can be manually lowered or raised.

3. Main Pile Up Button

Press this button to raise the pile.

4. Main Pile Down Button

Press this button to lower the pile.

5. Main Pile Constant Lower Button

Used for inserting the pile board. When pressed, the pile lowers by a preset amount.

6. Pile Board Guide Hoist Button

When this button is pressed, it illuminates and the pile can be manually lowered or raised.

7. Pile Board Guide Up Button

When pressed, the pile board guide rises, and stops, when the button is released.

8. Pile Board Guide Down Button

When pressed, the pile board guide lowers, and stops, when the button is released.

9. Tail Edge Guide On/Off Button

When this button is pressed, the lamp illuminates and the tail edge guide device moves to the sheet trailing edge.

10. Pile Board Guide Open/Close Button

When this button is pressed, the lamp illuminates and the pile board guide closes.

11. Sampling On/Off Button

When pressed, the lamp illuminates and the sheet lays fall forward, enabling sampling.

Touch Panel Monitor

There are two touch panel monitors:

1. Feeder unit side panel
2. Delivery unit front panel

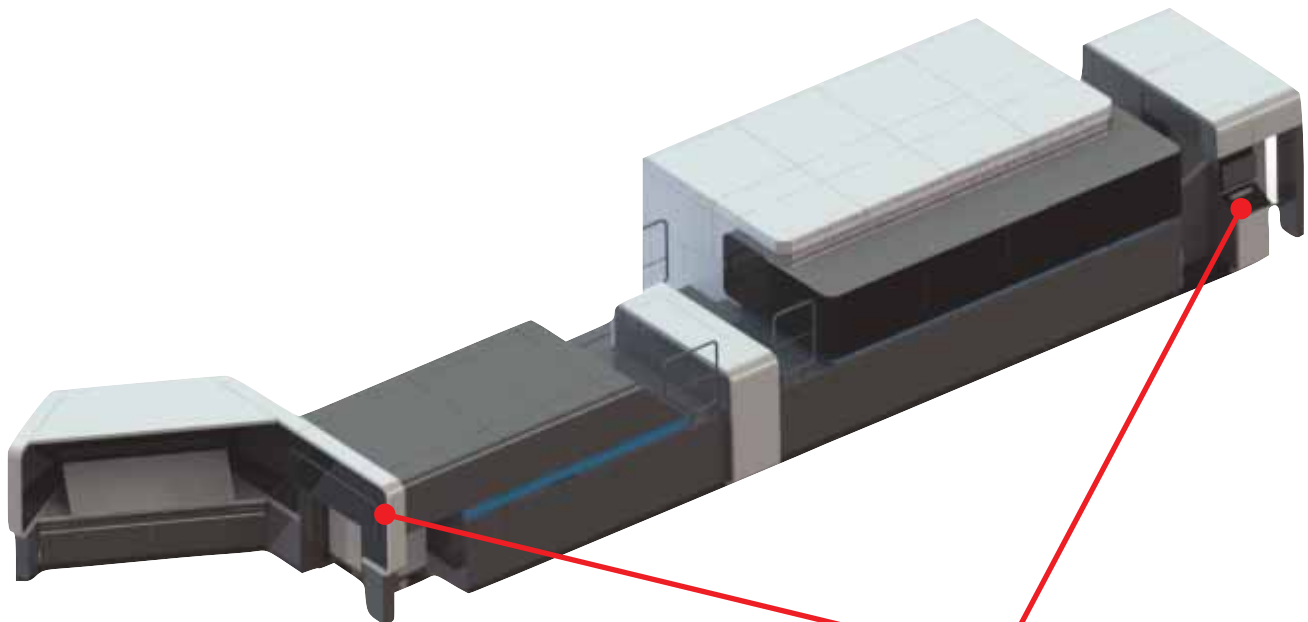

1. Safety Indicator
2. Automatic Sheet Feeding button
3. Delivery Area Sensor Reset button
4. Tune Up button
5. Inch button
6. Slower button
7. Slow/Fast button
8. Stop button
9. Print key
10. Sheet Size key
11. Air #1 key
12. Air #2 key
13. Air #3 key
14. Setting key
15. Monitor key
16. Emergency Stop button
17. Sampling On/Off button
18. Touch PanelMonitor
19. Touch Panel Buttons

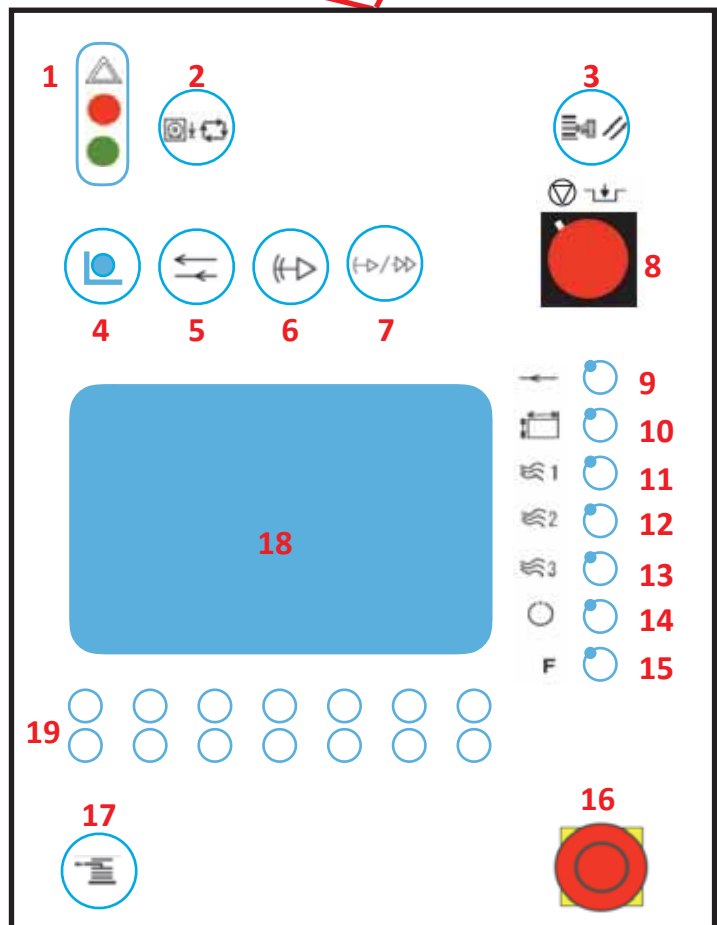

1. Safety Indicator

These lights indicate whether it is okay and safe to run the coating unit.

2. Automatic Sheet Feeding Button

Starts the automatic sheet feeding.

3. Delivery Area Sensor Reset Button

This button resets the delivery area sensors.

4. Tune Up Button

Prevents the press from running at slow or higher speed.

5. Inch Button

Used for inching the press.

6. Slower Button

Used for operating the press at a slower speed.

7. Slow/Fast Button

Used for running the press at slow and fast speeds.

8. Stop Button

This button, which uses a turn-locking system, immediately stops the press when it is running at slow or slower speeds. However, if the Stop button is pressed and the cylinders are engaged at slow or fast speed, the press runs at slow speed and only stops after the last sheet exits the delivery unit.

9. Print Key

Displays the status of the safety devices. The sheet feed operating switch is installed on the feeder.

10. Sheet Size Key

Perform fine tuning on the installed sheet size.

11. Air #1 Key

Adjust the feeder/delivery air volume.

12. Air #2 Key

Adjust the feeder/delivery air volume.

13. Air #3 Key

Adjust the feeder/delivery air volume.

14. Setting Key

Adjust the settings for the following:

Feeder unit side panel

- Feeder drive and safety device settings

Delivery unit front side panel

- Delivery raise and lower settings

15. Monitor Key

Displays the safety device operating status for both the feeder and delivery.

16. Emergency Stop Button

Stops the press in an emergency situation.

17. Sampling On/Off Button

When pressed, the lamp illuminates and the sheet lays fall forward, enabling sampling.

18. Touch Panel Monitor

Displays various print settings.

19. Touch Panel Buttons

Press the buttons to access the functions.

Operator Status Display

When the Touch Panel Monitor function key is pressed, the area displaying the operating status changes appearance.

The area displaying the operating status does not change appearance when the other function keys are pressed.

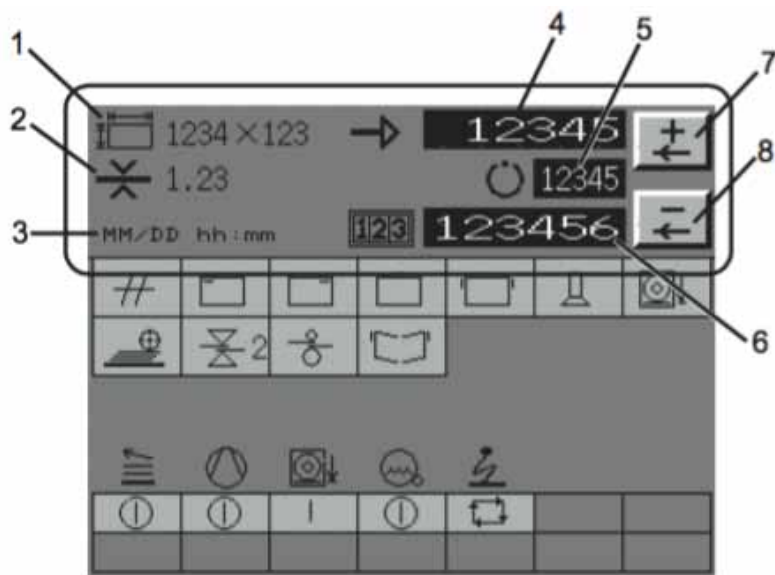

1. Paper Size Display
2. Paper Thickness Display
3. Calendar Display
4. Drive Speed Display (rph)
5. Drive Speed Setting Display (rph)
6. Sheet Counter Display
7. Operator Speed Setting Increase Button
8. Operator Speed Setting Decrease Button

1. Paper Size Display

Displays the paper size (width x length) set by the PQC.

2. Paper Thickness Display

The paper thickness set by the PQC is displayed.

3. Calendar Display

Displays the current date and time.

4. Drive Speed Display (rph)

Displays the press operating speed

5. Drive Speed Setting Display (rph)

Displays the speed when the press is operating at fast speed.

6. Sheet Counter Display

Displays the speed when the press is operating at fast speed.

7. Sheet Counter Display

Displays the speed when the press is operating at fast speed.

8. Operator Speed Setting Decrease Button

Displays the safety device operating status for both the feeder and delivery.

Panel Buttons

The touch panel icons (A) display the functions that can be performed when the panel buttons (B) are pressed.



The touch panel icons do not operate the press

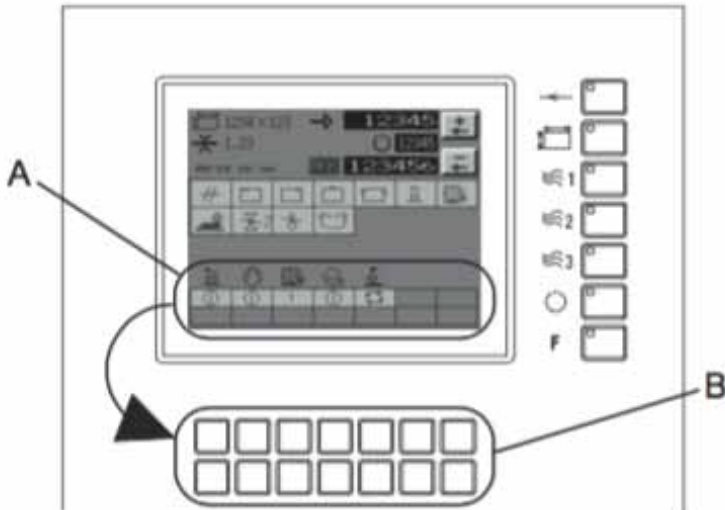

- A. Touch panel icons
- B. Touch panel buttons

Print Key

Sheet feeding indicators

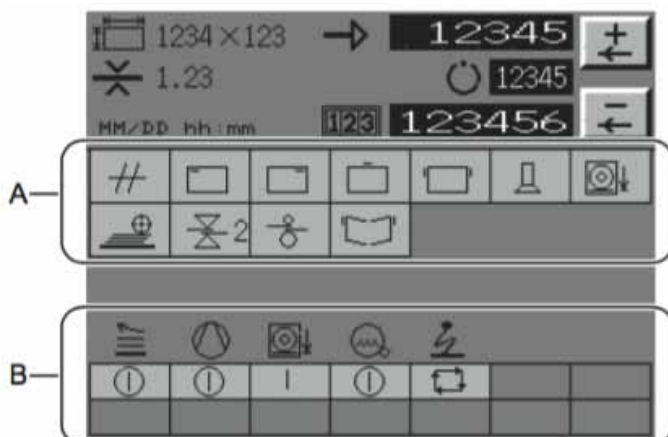

- A. Touch panel icons displayed on both feeder unit side panel and delivery unit front panel
- B. Touch panel icons unique to the delivery unit front side panel

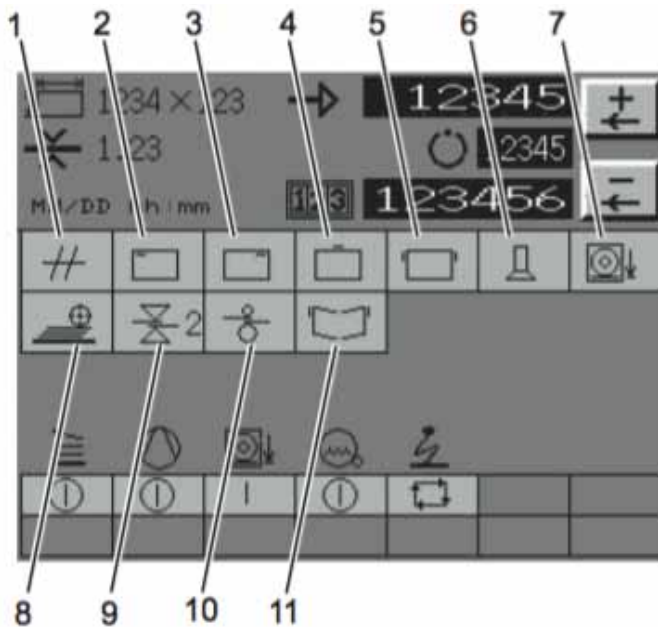

Icons appearing on feeder unit side panel and the delivery unit front panel

1. Sensor Error
2. Registration O
3. Registration D
4. Overshoot Detector
5. Side Lay Detector
6. Sucker Overshoot Detector
7. Impression ON Detector
8. Sheet Accumulation on Feeder Board Detector
9. Double Sheet Detector
10. Displacement Mechanical Double Sheet Detector
11. Late Arrival Detector

1. Sensor Error

Illuminated when the register operation side and drive side sensors are dirty.

2. Registration O

Illuminated if the registration front side sensor is activated.

3. Registration D

Illuminated if the registration rear side sensor is activated.

4. Overshoot Detector

Illuminated when the overshoot detector is activated.

5. Side Lay Detector

Illuminated when side lay sensor is activated.

6. Sucker Overshoot Detector

- Illuminated if the sucker reaches the upper limit
- Dimmed when the sucker is returned to the normal position

7. Impression ON Detector

- Illuminated when a sheet is automatically detected at the feeder board
- Remains illuminated during normal operation

8. Sheet Accumulation on Feeder Board Detector

Detects the accumulated amount of sheets on the board. When the specified number of sheets has been supplied after sheet supply is started, the feeder automatically switches off if the sheets do not reach the front lay.

9. Double Sheet Detector

Illuminated when the ultrasonic double sheet detector detects two or more sheets.

10. Displacement Mechanical Double Sheet Detector

When the displacement mechanical double sheet detector (located in the feeder unit) is activated, the following occurs:

- The icon is illuminated
- Feeder stops

11. Late Arrival Detector

When the late arrival detector (located in the feeder unit) is activated, the following occurs:

- The icon is illuminated
- Feeder stops

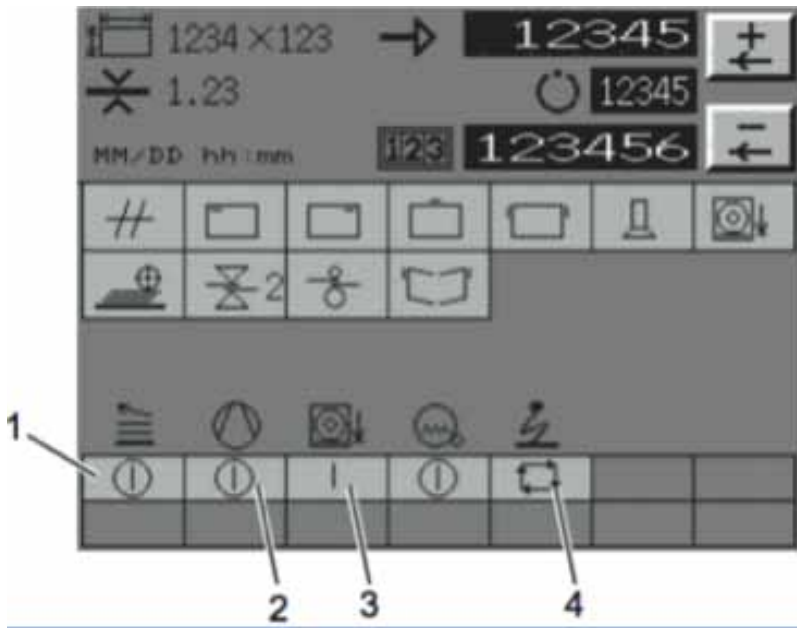

1. Feeder ON/Impression OFF
2. Feeder Pump ON/OFF
3. Impression-On ON
4. Selection of Linkage with Antistatic Equipment

Sheet feed operating switch (feeder section main panel)

1. Feeder ON/Impression OFF

If the panel button corresponding to this icon is pressed during press revolution, the following occurs:

1. The icon flashes.
2. Touch panel icon is illuminated at the set timing.
3. Feeder turns on.

If this button is pressed during feeder operation (while the icon is illuminated), the following occurs:

1. Feeder stops after the set timing.
2. Register unit swing grippers open.
3. Front lay stops.

When this button is pressed while the cylinders are engaged, the following occurs:

- Cylinders disengage at the set timing in conjunction with the feeder stop operation

2. Feeder Pump ON/OFF

If the panel button corresponding to this icon is pressed during press revolution, the following occurs:

1. The icon flashes.
2. Touch panel icon is illuminated at the set timing.
3. Feeder turns on.

If this button is pressed during feeder operation (while the icon is illuminated), the following occurs:

1. Feeder stops after the set timing.
2. Register unit swing grippers open.
3. Front lay stops.

When this button is pressed while the cylinders are engaged, the following occurs:

- Cylinders disengage at the set timing in conjunction with the feeder stop operation

3. Impression-On ON

When the Impression-on button, (located on the PQC touch panel) is ON; and the corresponding touch panel icon is pressed while the press is running at slow speed, the following occurs:

- Impression on starts for the units that have the impression on switch set to ON - in line with the press timing
- The icon dims when cylinder disengage is performed

4. Selection of Linkage with Antistatic Equipment

Use the antistatic device on the feeder.

Press the physical button corresponding to this icon.

- The power switches on in connection with the feeder power

Sheet Size Key

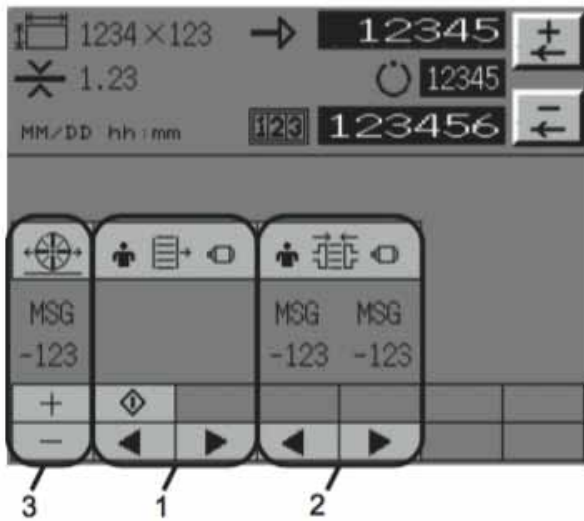

1. Feeder Pile Sideways Control
2. Translating Side Separator Positions
3. Brush Wheel Movement

Sheet size key - feeder main panel

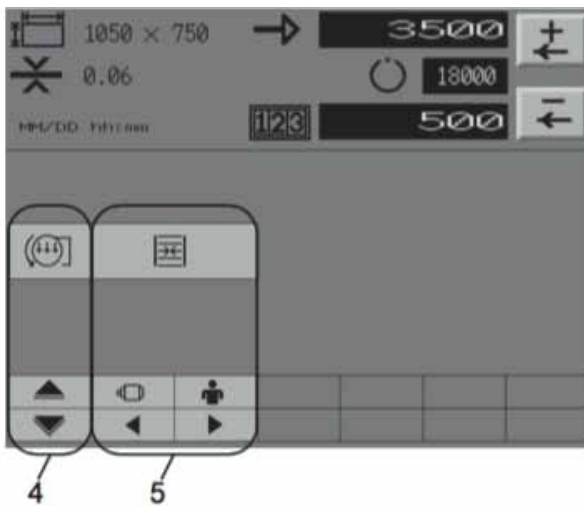

4. Delivery Suction Wheel
5. Delivery Side Jogger

Sheet size key - delivery front side

1. Feeder Pile Sideways Control

Press the forward arrow:

- The icon momentarily turns blue
- The sheet pile board is automatically controlled from side to side

2. Translating Side Separator Positions

Press the backward arrow:

- The icon momentarily turns blue
- Entire side separator moves toward the front side

This function is only available when the feeder pile sideways control is set to automatic mode.

3. Brush Wheel Movement

Press the plus + button:

- The icon momentarily turns blue
- Entire side separator moves toward the front side

This function is only available when the feeder pile sideways control is set to automatic mode.

4. Delivery Suction Wheel

Perform fine adjustments to the circumferential position of the suction wheel

Move the suction wheel toward the sheet trailing edge:

- Press the up arrow button

Move the suction wheel toward the sheet trailing edge:

- Press the down arrow button

Release the button to stop moving the suction wheel

5. Delivery Side Jogger

Press the button corresponding to the rear (drive) side of the press

- The icon momentarily turns blue
- The side jogger on the rear side can now be moved

Press the button corresponding to the front (operation) side of the press

- The icon momentarily turns blue
- The side jogger on the front side can now be moved

Press an arrow key to move in the direction of the arrow.

Release the key to stop further movement.

If both front side buttons and rear side buttons are selected and illuminated blue, the appearance of the arrow keys change.

Simultaneously move the side joggers on the front and rear sides to the outside:

- Press the two outward facing arrows

Simultaneously move the side joggers on the front and rear sides inwards:

- Press the two inward facing arrows

Air Key

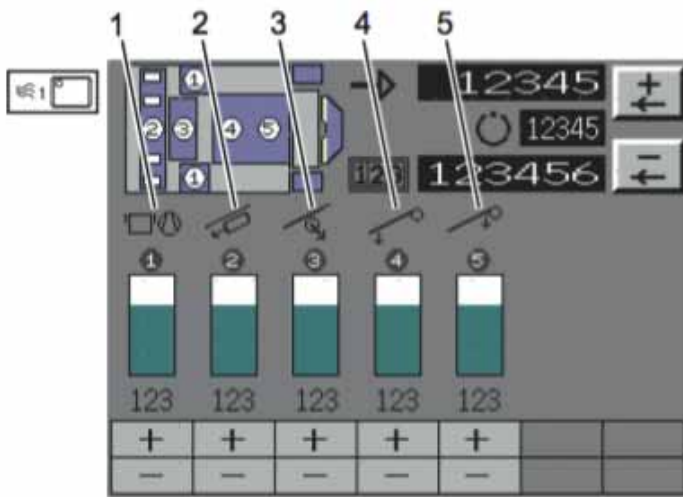

1. Side Lay Air Volume
2. Feed Board Air Volume
3. Feed Roller Air Volume
4. Suction Board Downstream Side Air Volume
5. Suction Board Upstream Side Air Volume

Air key - feeder main panel

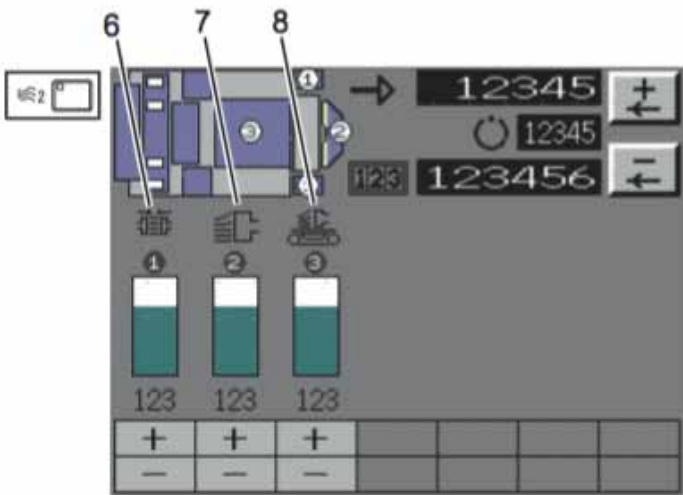

6. Side Separator Air Volume
7. Sucker Blow Air Volume
8. Feeder Board Sheet Trailing Edge Air Volume (option)

Air key - feeder main panel



8. Feeder Board Sheet Trailing Edge Air Volume (option)

Air key - feeder main panel

1. Side Lay Air Volume

Adjusts the suction air volume for the feed roller.

2. Feed Board Air Volume

Adjusts the suction air volume for the feed roller.

3. Feed Board Air Volume

Adjusts the suction air volume for the feed roller.

4. Suction Board Downstream Side Air Volume

Adjusts the suction air volume for the suction board downstream side.

5. Suction Board Upstream Side Air Volume

Adjusts the suction air volume for the suction board upstream side.

6. Side Separator Air Volume

Adjusts the volume of the side separator air blower.

7. Sucker Blow Air Volume

Adjusts the total volume of the sucker air blower.

Use the valves on the sucker units to perform individual air volume adjustments.

8. Feeder Board Sheet Trailing Edge Air Volume (Option)

Adjusts the volume of the feeder board sheet trailing edge air blower.

Use the valves on the air blower nozzle units to perform individual air volume adjustments.

To switch the air blower ON/OFF:

- Press the ON icon (round circle)

To stop the operations linked to the running of the press:

- Press the Stop icon (four arrows in a square)

Delivery Front Side Panel

Air 1 Key - feeder main panel

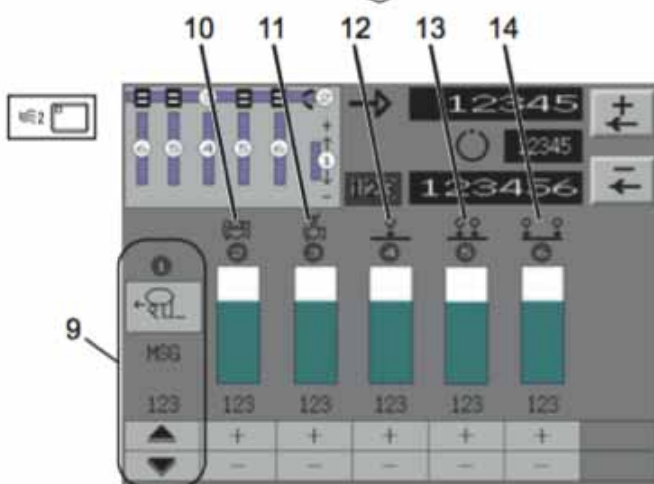
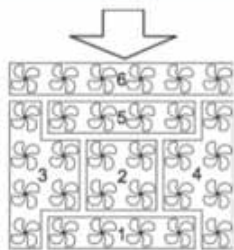
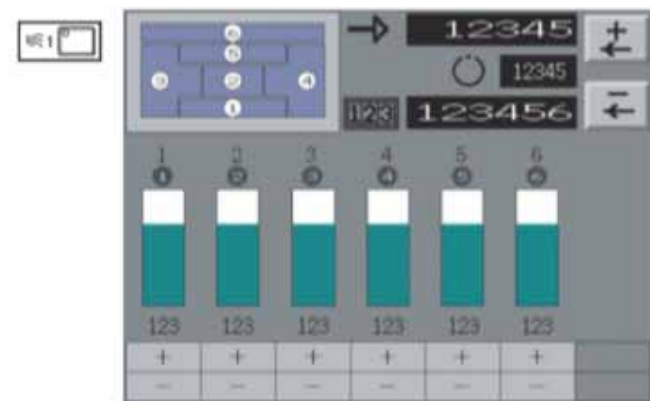

- 9. Release Cam Position Fine Adjustments
- 10. Suction Wheel Rotating Speed
- 11. Suction Wheel Upper Air Blow
- 12. Pile Upper Section Air Blow 1 (central) Air Volume
- 13. Pile Upper Section Air Blow 1 (inner) Air Volume
- 14. Pile Upper Section Air Blow 1 (outer) Air Volume

9. Release Cam Position Fine Adjustments

Adjusts the suction air volume for the feed roller.

To move the cam further away from the sheet lay (sheet release speeds up):

- Press and hold the up arrow

To move the cam toward the sheet lay (sheet release slows down):

- Press and hold the down arrow

10. Suction Wheel Rotating Speed

Adjusts the rotating speed of the suction wheel. The suction wheel starts and stops in connection with the operation of the delivery pump.

11. Suction Wheel Upper Air Blow

Adjusts the blow air volume for the sheet direction from the upper section of the suction wheel.

12. Pile Upper Section Air Blow 1 (central) Air Volume

Adjusts the blow air volume for the air bar that is arranged in the vertical direction on the upper section of the delivery pile (central section 1 bar).

13. Pile Upper Section Air Blow 2 (inner) Air Volume

Adjusts the blow air volume for the air bar that is arranged in the vertical direction on the upper section of the delivery pile (inner section 2 bars).

14. Pile Upper Section Air Blow 3 (outer) Air Volume

Adjusts the blow air volume for the air bar that is arranged in the vertical direction on the upper section of the delivery pile (outer section 2 bars).

Function Keys

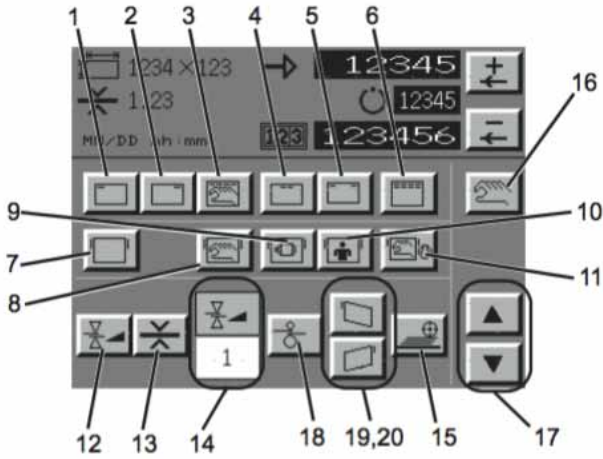

Function Keys - Feeder Main Panel

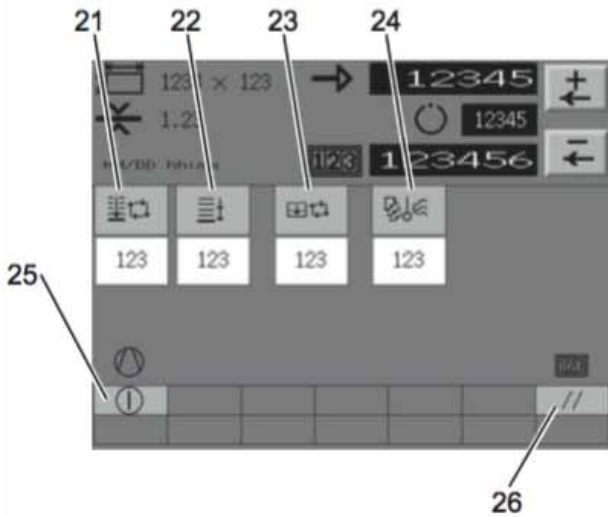

Function Keys - Delivery Front Side Panel

1. Registration O ON/OFF
2. Registration D ON/OFF
3. Manual Selection of Registration Detection
4. Registration Manual Inside
5. Registration Manual Outside
6. Registration Double Detection
7. Side Lay Detector Selection
8. Side Lay Detector Manual Selection
9. Manual DriveSide Lays (D)
10. Manual Operation Side Lays (O)
11. Manual Air Side Lay Pump
12. Double Sheet Detector ON
13. Double-Sheet Detection Special Sheet
14. Double-Sheet Detection Sensitivity Adjustment
15. Sheet Accumulation Detection ON
16. Test Mode
17. Page Switching
18. Displacement Double Sheet Detector ON
19. Late Arrival Detection Operation Side ON
20. Late Arrival Detection Drive Side ON
21. Registration O ON/OFF
22. Registration D ON/OFF
23. Manual Selection of Registration Detection
24. Registration Manual Inside
25. Registration Manual Outside
26. Registration Double Detection

Edit the data

1. Tap the monitor
 - An input screen opens



2. Enter the data and tap ENTER
 - The previous screen appears
3. Make sure the data has changed.

1. Registration O ON/OFF

Sets the front side registration sensor ON/OFF.

- The icon turns blue when set to ON
- Even if this icon is set to OFF, it automatically turns ON after the power is turned off and on

2. Registration D ON/OFF

Sets the rear side registration sensor ON/OFF.

- The icon turns blue when set to ON
- Even if this icon is set to OFF, it automatically turns ON after the power is turned off and on

3. Manual Selection of Registration Detection

Selection of inner/outer registration sensor is set automatically when the PQC paper size is entered.

To manually perform the settings:

Set the icon to ON

- The icon turns blue

4. Registration Manual Inside

This icon is only used for making manual selections.

- Only the inner registration sensor is enabled
- The outer sensor is disabled

5. Registration Manual Outside

This icon is only used for making manual selections.

- Only the inner registration sensor is enabled
- The outer sensor is disabled

6. Registration Double Detection

Sets the registration double detection function ON/OFF

- The icon turns blue when set to ON
- Even if this icon is set to OFF, it automatically turns ON after the power is turned off and on

7. Side Lay Detector Selection

Sets the side lay sensor ON/OFF.

- The icon turns blue when set to ON
- Even if this icon is set to OFF, it automatically turns ON after the power is turned off and on

8. Side Lay Detector Manual Selection

Normally, the side lay sensor is set automatically.

To manually perform the settings:

Set the icon to ON.

- The icon turns blue

This icon is only used for making manual selections.

- Only the rear side side-lay sensor is enabled
- The front side sensor is disabled

9. Manual Drive Side Lays (D)

This icon is only used for making manual selections.

- Only the rear side side-lay sensor is enabled
- The front side sensor is disabled

10. Manual Operation Side Lays (O)

This icon is only used for making manual selections.

- Only the front side side-lay sensor is enabled
- The rear side sensor is disabled

11. Manual Air Side Lay Pump

- When tapped, this icon illuminates blue, and the air side lay pumps can be operated individually.
- When tapped again, the icon is dimmed and the pumps stop

12. Double Sheet Detector ON

Sets the ultrasonic double-sheet detector sensor ON/OFF

- The icon turns blue when set to ON
- Even if this icon is set to OFF, it automatically turns ON after the power is turned off and on

13. Double-Sheet Detection Special Sheet

Switch this on when printing onto special sheets. The icon is illuminated blue when set to ON.

14. Double-Sheet Detection Sensitivity Adjustment

Sets the sensor threshold.

15. Sheet Accumulation Detection ON

Sets the sheet accumulation detection function ON/OFF.

- The icon turns blue when set to ON
- Even if this icon is set to OFF, it automatically turns ON after the power is turned off and on

16. Test Mode

Used to test whether the sheet you intend to print on can be detected by each of the sensors in the register unit.

To test the sheet:

1. Stop the press at a 290° detection timing.
 - This icon turns blue
2. Place and retrieve a sheet in front of each sensor.
3. Check the response of each sensor using the display buttons on the function "Print" screen.
4. Normally, set it to OFF.

17. Page Switching

Performs page switching.

18. Displacement Double Sheet Detector ON

Sets the displacement double-sheet detector function ON/OFF.

- The icon turns blue when set to ON
- Even if this icon is set to OFF, it automatically turns ON after the power is turned off and on

19. Late Arrival Detection Operation Side ON

Sets the late arrival detection front side ON/OFF.

- The icon turns blue when set to ON
- Even if this icon is set to OFF, it automatically turns ON after the power is turned off and on

20. Late Arrival Detection Drive Side ON

Sets the late arrival detection rear side ON/OFF.

- The icon turns blue when set to ON
- Even if this icon is set to OFF, it automatically turns ON after the power is turned off and on

21. Delivery Main Pile Automatic Lowering Time

Adjust the amount the main pile inches downwards during printing.

Note: The initial value is 30

22. Main Pile Determined Lowering Time

Adjust the amount the main pile inches downwards during printing.

Note: The initial value is 100

23. Auxiliary Pile Automatic Lower

Adjust the amount the main pile inches downwards during printing.

Note: The initial value is 100

24. Sheet Drop Air Purge (Option)

Sets the discharge time for the air used to clean the sheet drop detection sensor (heat resistant specifications).

Note: The initial value is 500

25. Delivery Pump ON

- If the appropriate panel button for this icon is pressed, the icon is illuminated, and the delivery pump, suction wheel, and upper fan operate individually. If the button is pressed again, the icon is dimmed, and each device stops operating.
- When the icon is dimmed, the devices are linked to the press. When the last cylinder of the press is turned on, the icon is illuminated, and the delivery pump, suction wheel, and upper fans operate.
- When cylinder disengagement is performed, the button's icon is dimmed for five seconds after the last cylinder is disengaged, and the delivery pump, suction wheel, and upper fans stop

26. Counter Reset

The counter number reverts to 0.

Chapter 4

Landa Interface Application

About the Landa Interface Application

The press operator commands and controls the printing press via the Landa Interface Application (LIA). The LIA can be either accessed from the Landa Operator Cockpit, the Feeder or the Landa digital tablet.

- The LIA version on the Landa Operator Cockpit is for operating and servicing the press
- The LIA version on the digital tablet is for servicing the press only

LIA Monitors



1. Prepress Monitor
2. Observation Deck
3. Job Management Monitor

Prepress Monitor

The touch-screen Prepress monitor displays the following:

- Landa Digital Front End, management information system
- Email, internet
- Desktop

Observation Deck

The Observation Deck is a view-only monitor which displays vital press statistics and live video feeds from inside the press.

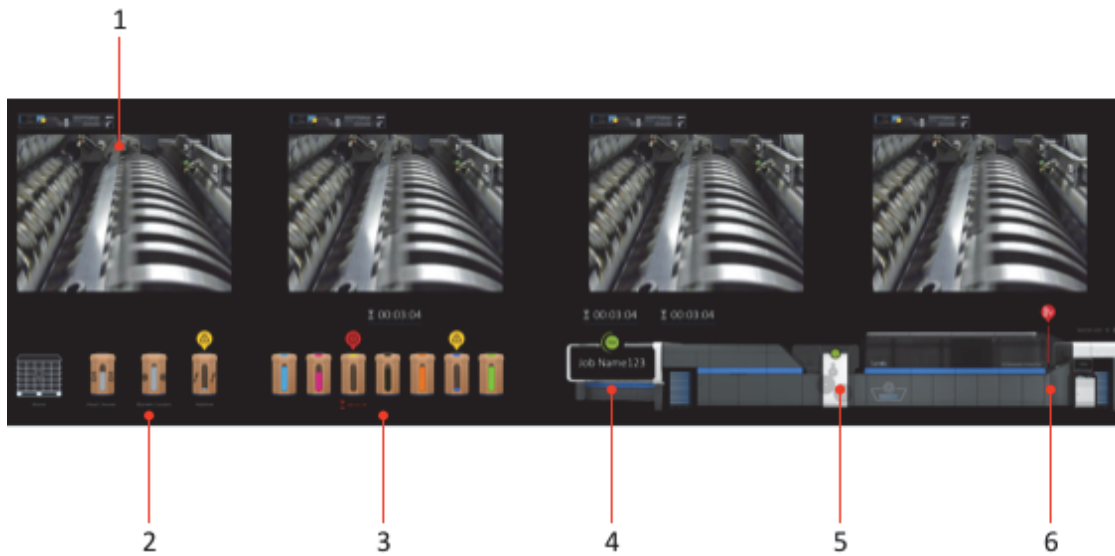

1. Video feeds
2. Tank status
3. Landa NanoInk Farm status
4. Press status
5. Coating unit status
6. Alert flag

Video Feeds

There are ten video cameras strategically located inside the press.

- The video cameras stream live feeds in real time
- Up to four video feeds can be viewed simultaneously

View real-time video feeds from inside the press

The real-time videos can be viewed on the Observation Deck

Change the video feeds displayed on the Observation Deck

1. Tap the Main Menu.
2. Choose Settings > Camera Settings.
3. Select four videos feeds to display on the Observation Deck.

Tank Status

The Tank Status enables you to monitor the levels of the following tanks:

- Waste
- Print head cleaning solution
- Blanket coolant
- Blanket coolant additive starter

View the tank levels

View the status of the tank levels on the Observation Deck.

- When a tank reaches a critical level, an alert is displayed on the tank's icon

Landa NanoInk Farm Status

The Landa NanoInk Farm Status enables you to monitor the levels of ink inside the ink farm tanks.

Monitor the ink farm tank levels

View the status of the Landa NanoInk Farm tank levels on the Observation Deck.

The ink farm status can be viewed on the Observation Deck.

- When a tank reaches a critical level, an alert is displayed on the tank's icon

Press Status

The name of the job being printed and the status of the press can be viewed from a distance.

View the status of the press and the name of the job being printed

View the status of the press and the name of the job being printed on the Observation Deck.

- The press status can also be viewed on the Job Management monitor and the Feeder Control Panel

Coating Unit Status

The coating unit can be used to apply either an aqueous coating or an ultraviolet coating to printed images.

View the status of the coating unit

The coating unit status can be viewed on the Observation Deck.

- A green circle denotes when the coating unit is in use

Alert Flag

When an alert or error occurs on the press, an alert flag denotes the location of the error.

View the location of an alert

Alert notification flags (denoting the location of an alert or error), can be viewed on the Observation Deck.

Job Management

The Job Management display is an interactive touch-screen monitor. The operator can perform many tasks from the Job Management monitor, such as select a job for printing, change the press settings, and move jobs from the Print Queue.



1. Access the Main Menu
2. View automatically generated alerts
3. View automatically generated alerts per each subsystem
4. View the jobs in either a stacked, optimized or detailed views
5. Shortcuts and Favorites Bar
6. Print, proof, and stop the press via the Control Panel icons
7. View the printing timeline
8. View the jobs in the print queue and modify their properties
9. View the status of the jobs

Main Menu

The Main Menu contains sub menus which allow the operator to perform many tasks including the following:

- Change the LIA default language
- Change the video feeds displayed on the Observation Deck
- Enter the properties of the substrate loaded on the press
- Shutdown and restart the press

Change the LIA default language

1. Tap the Main Menu located on the Job Management monitor.
2. Choose Settings > Press Settings > Localization.
3. Select the default language.

Change the LIA default measurements

1. Tap the Main Menu located on the Job Management monitor.
2. Choose Settings > Press Settings > Localization.
3. Select Metric or Imperial.

Change the LIA color scheme

1. Tap the Main Menu located on the Job Management monitor.
2. Choose Settings > Press Settings > Appearance.
3. Select up to four videos feeds to display on the Observation Deck.

Bypass a print job requiring a different substrate

When the press is in Continuous Printing mode, jobs that have different substrate properties can be skipped or bypassed. This feature enables the press to continuously print without having to stop to change substrates.

1. Tap the Main Menu located on the Job Management monitor.
2. Choose Settings > Press Settings > Job Management.
3. Select Bypass jobs with missing resources for continuous printing.

Change the video feeds displayed on the Observation Deck

1. Tap the Main Menu located on the Job Management monitor.
2. Choose Settings > Camera Settings.
3. Select up to four videos feeds to display on the Observation Deck.

Login as a different operator

1. Tap the Main Menu located on the Job Management monitor.
2. Choose Power > Switch User.
3. Logout the current operator and login a new operator.

Shut down the Landa Interface Application

1. Tap the Main Menu located on the Job Management monitor.
2. Choose Power > Shut Down.

Restart the Landa Interface Application

1. Tap the Main Menu located on the Job Management monitor.
2. Choose Power > Application > Restart.

Exit the Landa Interface Application

1. Tap the Main Menu located on the Job Management monitor.
2. Choose Power > Application > Exit.

Define the properties of the substrate loaded on the press

1. Tap the Main Menu located on the Job Management monitor.
2. Choose Substrate > Substrate Handling.
3. In the Substrate Handling dialog, define the properties of the substrate loaded on the press.

Minimize the Landa Interface Application

1. Tap the Main Menu located on the Job Management monitor.
2. Choose View > Minimize.

View the substrate catalog

The subject catalog contains the range of substrates available.

1. Tap the Main Menu located on the Job Management monitor.
2. Choose Substrate > Substrate Catalog.
3. In the Substrate Catalog dialog, view the properties of available substrates.

Replace the image transfer blanket

Refer to the Blanket Installation Procedure document.

Replace a print head

1. Tap the Main Menu located on the Job Management monitor.
2. Choose Tools > Replace Print Head, and follow the on-screen instructions.

Alerts

Alerts are automatically generated. The alerts messages can be viewed for the entire system or filtered according to subsystems.

View all press alerts

Tap the Show all icon located on the Job Management monitor.

- All the press alerts are displayed
- Tap the Show all icon again to hide the displayed alerts

Filter the press alerts according to subsystems

Tap a subsystem alerts icon, located on the Job Management monitor.

- The press alerts relating to the subsystem are displayed
- Tap the subsystem alerts icon again to hide the displayed alerts

Job Card Views

The operator can change the job card view on the Job Management monitor. The cards can be viewed as a carousel, compact view, or in a list format.

Change the job card view

1. Tap the Job Card View icon located on the Job Management monitor.
2. Choose between carousel, compact or list view.

Shortcuts and Favorites

The operator can add and remove Main Menu items to and from the Shortcuts and Favorites Bar (5); viewable on the Job Management monitor.

Add a submenu or item to the Shortcuts and Favorites Bar

1. Tap the Main Menu icon located on the Job Management monitor.
2. Navigate to a submenu or item you wish to create a shortcut for.
3. Tap and hold the submenu or item icon.
4. Tap Add to favorite. The submenu or item appears in the Shortcuts and Favorites Bar.
 - Only seven items can be viewed simultaneously in the Shortcuts and Favorites Bar. When the bar contains more than seven items, the additional items can be viewed by tapping the reveal arrow.

Remove a submenu or item from the Shortcuts and Favorites Bar

1. In the Shortcuts and Favorites Bar, tap and hold the submenu or item you wish to remove
2. Tap Remove. The submenu or item is removed from the Shortcuts and Favorites Bar.
 - Some of the shortcut and favorite items, such as Substrate Handling and Configuration, are predefined and cannot be removed from the Shortcuts and Favorites Bar.

Control Panel

The operator can control various printing options and view the printing status from the Control Panel (6).

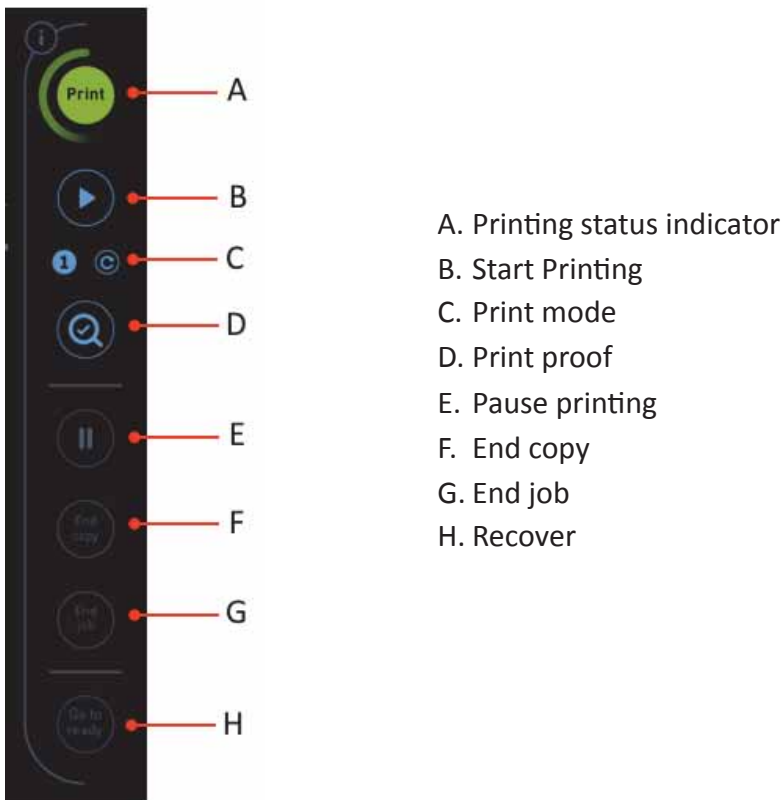

View the printing status

To monitor the printing status of the press, check the Printing Status Indicator (A), located on the Control Bar.

Start printing

1. Complete the Maintenance Checklists.
2. Select the job to print.
3. Tap the Start Printing button located on the Control Bar.

Print in single mode

The operator can choose to print each job as a separate entity. On the Control Bar, tap the Single Mode icon .

- The press stops after the job has been printed and returns to Ready status

Print in continuous mode

The operator can choose to print jobs continuously - meaning the press does not pause in between printing jobs.

On the Control Bar, tap the Continuous Mode button (C).

- The press only stops after the jobs have been printed

Print a proof

The operator can choose to print a proof as part of the make ready process. On the Control Bar, tap the Print Proof button (D).

- A single impression (print) or booklet of the first job in the Printing Queue is printed

Pause printing

The operator can choose to pause the printing.

On the Control Bar, tap the Pause button (E).

- The press pauses printing immediately
- The job remains in the Print Queue until it has been printed

Stop printing after a copy has been printed

The operator can stop printing after a copy or booklet has finished printing. On the Control Bar, tap the End Copy button (F).

- The press stops after the next impression or booklet has finished printing
- The job remains in the Print Queue until it has been printed in its entirety

Stop printing after a job has been printed

The operator can stop printing after a job or booklet has finished printing. On the Control Bar, tap the End Job button (G).

- The press stops after the job has finished printing
- The printed job card moves to the Completed folder

Recover the printing press from error state

The printing press is occasionally in an error state.

Tap the Recover button (H) to retrieve the printing press from an error state.

Printing Timeline

The printing timeline (7) displays the following information:

- The precise time each job is scheduled to print
- The time required to print each job
- Forewarns the press operator when their intervention is required, for example a job in the print queue requires a change of substrate

Check when a job will start to print

On the printing timeline, a white duration bar is associated with each print job. The beginning of the duration bar denotes the time when the press will begin to print the job.

Check when a job will stop printing

On the printing timeline, a white duration bar is associated with each print job. The end of the duration bar denotes the time when the job will have been printed.

Check how long it takes to print a job

On the printing timeline, a white duration bar is associated with each print job.

The length of the duration bar denotes the time it takes to print the job.

The time it takes to print a job can also be viewed on the job's card.

Check when operator intervention is required

A red alert flag on the printing timeline denotes the precise time an operator's intervention is required to print a job. For example, the upcoming job in the queue may require the operator to change the substrate loaded on the press.

Job Cards

Each job card represents a job that requires printing. The cards contain information related to the print job parameters, for example the substrate, the length of the print run, the job name etc.



- I. The job's number in the print queue
- J. Proof indicator
- K. The CMYK colors required to print the job
- L. Other colors required to print the job
- M. The time it takes to print the job
- N. The name of the substrate
- O. The substrate's format
- P. Job selection checkbox
- Q. Job name
- R. Date and time job was submitted
- S. Thumbnail of the job
- T. Length of print job
- U. Type of substrate

Job Properties

The job properties are mostly configured during the prepress stage, but the operator on occasion may want to edit the properties of a job.

Edit a job's properties

Double-tap the job card's thumbnail. A dialog opens displaying four tabs:

- General - change the number of impressions, priority, specify if a proof is required etc.
- Output - change a job's substrate size, print to the proofing tray, mirror print etc.
- Image Position - change how the image is centered on the substrate, change the margins etc.
- Color & Quality - Apply coating, choose a screening etc.

General Tab

Edit a job's priority

Edit a job's priority to change its order in the print queue.

1. Double-tap the job card's thumbnail.
2. In the General tab change the priority of the job.

Edit the proof properties

Choose if a proof needs to be printed and select the quantity of proofs required.

1. Double-tap the job card's thumbnail.
2. In the General tab change the proof properties.

Edit the die line properties

Edit the job's die line properties and determine how the die line appears.

1. Double-tap the job card's thumbnail.
2. In the General tab change the die line properties.

Change the print range

Change the print range and the number of impressions.

1. Double-tap the job card's thumbnail.
2. In the General tab change the print range properties.

Change the run number

Change the number of impressions in the run.

1. Double-tap the job card's thumbnail.
2. In the General tab change the number of copies.

Output Tab

Choose the output destination

Choose to send the prints to the delivery pile or the proof tray.

1. Double-tap the job card's thumbnail.
2. In the Output tab change the output tray properties.

Edit the printing options

Choose to print collated or uncollated, mirrored, or reverse print order

1. Double-tap the job card's thumbnail.
2. In the Output tab change the printing properties.

Select a different substrate

Choose to a different substrate from the substrate catalog

1. Double-tap the job card's thumbnail.
2. In the Output tab choose a different substrate from the Substrate list.

Choose a different substrate size

1. Double-tap the job card's thumbnail.
2. In the Output tab choose a different substrate size from the Substrate size list.

Choose a different print order

1. Double-tap the job card's thumbnail.
2. In the Output tab select the Reverse print order checkbox.

Image Position Tab

Choose how to position the image on the substrate

Center the image to the substrate, printable area, or center of custom printable area.

1. Double-tap the job card's thumbnail.
2. In the Image Position tab choose how to center the image from the Center image to list.

Slightly adjust the image position

Adjust the image position on the substrate.

1. Double-tap the job card's thumbnail.
2. In the Image Position tab tap the arrows to slightly adjust the image position on the substrate.

Color & Quality Tab

View the amount of colors required to print the job

1. Double-tap the job card's thumbnail.
2. In the Color & Quality tab, the Job Separations list displays the colors required to print the job.

Apply a coating

1. Double-tap the job card's thumbnail.
2. In the Color & Quality tab, select the Coating checkbox and choose a coating from the list.

Apply a screening

1. Double-tap the job card's thumbnail.
2. In the Color & Quality tab, select either an image screening, graphics screening, or text screening option.

Define the Automatic Quality Manager inspection level

The Automatic Quality Manager (AQM) , by default, inspects the quality of the printed image according to the predefined inspection level. The inspection level can be a 'deep' inspection for quality prints, or a 'light' inspection for low quality prints etc. The inspection also checks the registration, the position of the image in relation to the substrate, and any color discrepancies. Images that fail the AQM criteria are automatically diverted to the Reject Tray.

1. Double-tap the job card's thumbnail.
2. In the Color & Quality tab, select the AQM sensitivity from the Sensitivity drop down list
 - To override the AQM, select None from the Sensitivity drop down list

Apply print marks to the printed substrate

Inspection marks are utilized by the spectrometer to verify the colors of the printed image. Prints displaying color degradation are automatically diverted to the Reject Tray. By default the inspection marks are always printed but the operator can override the default:

1. Double-tap the job card's thumbnail.
2. To print an image without inspection marks, in the Color & Quality tab, clear the Inspection Marks checkbox.

Chapter 5

Checklists

Maintenance Checklists

Complete the maintenance checklists before printing

For a detailed explanation on how to complete the maintenance checklists, see Checklists Procedures.

Substrate Transport System Checklist

Task	Frequency
Clean the press environment	Daily
Clean the footboards	Daily
Clean the impression and blanket cylinders	Daily
Check the drainage and dirtiness of the main air filter	Daily
Clean the photoelectric sensors	Daily
Clean side lay	Monthly
Clean registration table	Monthly
Clean delivery grippers shafts	Monthly
Clean delivery suction wheels	Monthly
Clean pump filters	Monthly
Clean grippers and gripper shafts	Monthly
Clean motor filter	Monthly
Add oil/grease to automatic grease system	Monthly
Check and adjust the feeder drive chain	Monthly
Check and adjust the V-belt main motor tension	Monthly
Check and refill the automatic lubrication pumps	Monthly
Check all safety buttons and indicators	Monthly
Grease the subsystems	Quarterly
Replace the feeder suction cups	Quarterly

Ink Printing System Checklist

Task	Frequency
Check the LIA for error messages	Daily
Verify the four pressure sensors on the pneumatics panel, are within tolerance (LED is green)	Daily
Vacuum and purge filters are clean of ink	Daily
Make sure there are no leaks or spillages in the ink delivery system	Daily
Make sure the print bar door cooling chiller is ON, and the water level is full. Temperature set point: 30° C	Daily
Make sure the ink cooling chiller is ON, and the water level is full. Temperature set point: 19° C	Daily
Make sure the print heads are not dripping	Daily
Check all the print bar cleaning units and then test the cleaning nozzles	Daily
Prime and blot each print bar with print head cleaning fluid	Daily
Clean in between the print heads	Daily
Clean the print heads	Daily
Clean the start page sensor	Daily
Check the cleaning fluid level in the capping bath	Daily
Make sure the print bars are in capping position	Daily
If end of day/week: Set the print bar chiller to 24° C	Daily

Blanket Cooling Unit Checklist

Task	Frequency
Clean the blanket cooling unit environment	Daily
Make sure the polishing rollers are working correctly	Daily
Make sure the revolver knives are clean	Daily
Make sure the blanket coolant additive spray nozzles and water nozzles are working correctly	Daily
Make sure the fly-off sensor is clean	Daily
Refresh the blanket coolant solution (200 l)	Every 2 Wks

Cold Water System Checklist

Task	Frequency
Replace the cold water system filter	Daily
Wash the cold water system filter	Weekly
Manually clean the line filter	Weekly

Ventilation Checklist

Task	Frequency
Replace the air filters	Monthly

Dryers/Image Pinning Unit Checklist

Task	Frequency
Clean the dryer and image pinning unit blower filters	Weekly

Waste Checklist

Task	Frequency
Empty the waste containers	Daily
Empty the water in the air filters	Daily

Consumables

Task	Frequency
Make sure the print head cleaning fluid tank is full	Daily
Make sure the external ink tanks (KCMY) are full	Daily
Make sure the feeder pile is full	Daily
Make sure the delivery pile is empty	Daily
Make sure the full inventory consumable parts is full	Daily

Chapter 6

Checklist Procedures

Error Messages

Check for Error Messages

Before printing, check the LIA Job Management monitor to make sure there are no error messages or alerts.



CAUTION

Before printing, resolve all error messages as described in the Troubleshooting chapter.

Paper Transport System Procedures



CAUTION

Do not operate the press unless you have read and fully understood the Safety Information. Make sure the Stop button is locked before making any adjustments.

Clean the impression cylinder

1. TBD

Check the drainage and dirtiness of the main air filter

1. Discharge the drainage from the compressor tank.
2. If the filters are dirty, replace them or clean them. Always use white kerosene to clean the filters. After cleaning, wait until the filters are dry before returning them to the filter cases.

Clean the photoelectric sensors

There are two photoelectric sensors located in the side separator and sucker box movement sections.

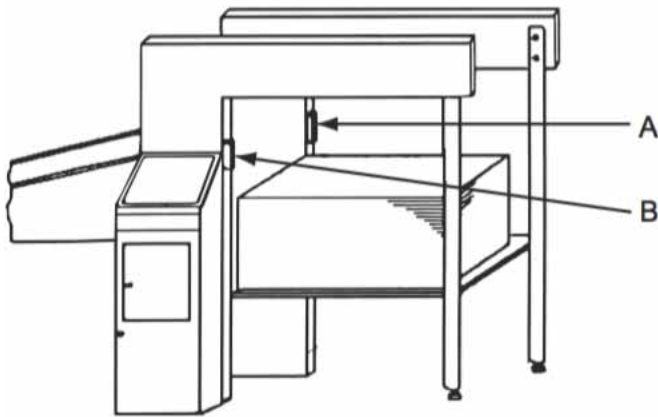

A: Photo sensor

B: Photo emitter

The function of the sensors is to detect obstructions, therefore it is important that they are cleaned on a daily basis.

Use a brush or dry cloth and wipe away any powder, dust or other dirt adhering to the detection surfaces (the surfaces facing each other) of the photo sensor and photo emitter.

Clean pump filters

1. Remove the filter case lid and pull out the filter.
2. Clean the filter from the inside with compressed air.

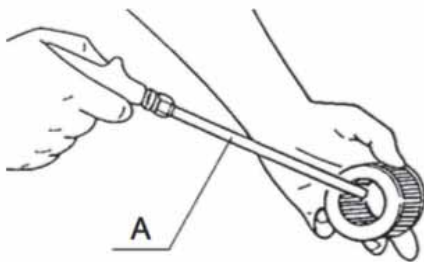

A: Air gun

3. After cleaning, replace the filters and filter lids in the reverse order of removing.
4. Press the Feeder Pump On/Off button, located on the operation panel, and check that the correct suction is applied to the sheets.

Ink Printing System Procedures



CAUTION

Do not operate the press unless you have read and fully understood the Safety Information. Make sure the Stop button is locked before making any adjustments.

Make sure the circulation is ON

If the ink is not circulating correctly an error message is displayed on the LIA. See Troubleshooting.

Make sure the print bars are in capping position

If the print bars do not reach capping position an error message is displayed on the LIA. See Troubleshooting.

Make sure the four pressure sensors are within working range

There are four pressure sensors located on the ink printing system's pneumatics panel:

- High pressure sensor
 - Low pressure sensor
 - Purge pressure sensor
 - Vacuum pressure sensor
1. Open Rear Panel 4 (concealing the ink delivery system's pneumatics panel).
 2. Make sure the four pressure sensor readings are lit green (indicating they are within working range). If a pressure reading is lit red an error message is displayed on the LIA. See Troubleshooting.

Make sure the vacuum filter does not contain ink or liquid

1. Open Rear Panel 4 (concealing the ink delivery system's pneumatics panel).
2. Check the vacuum filter and make sure it is clean of ink. If there is ink or liquid inside the vacuum filter refer to Troubleshooting.

Make sure the purge filter contains no ink

1. Open the Rear Upper Doors.
2. Press the Service button located on the print bar and pull out the print bar to service position.
3. Visually inspect the purge filter cap via the designated viewing slot located on the print bar. If the purge filter cap is full of ink, refer to Troubleshooting.

Make sure there is sufficient print head cleaning fluid in the capping bath

If the capping bath is low on print head cleaning fluid an error message is displayed on the LIA. See Troubleshooting.

Make sure there is no ink dripping in the ink delivery system

1. Open Rear Door 1 and access the ink delivery system.
2. Visually check to make sure no ink is dripping inside the system.
If ink is dripping, refer to Troubleshooting

Make sure there is no ink dripping from the print heads

1. Open the Rear Upper Doors.
2. Press the Service button located on the print bar and pull out the print bar to service position.
3. Visually check the underside of the print heads (the nozzle plates) and make sure there is no dripping ink.
If ink is dripping, refer to Troubleshooting.

Make sure the print heads are clean

When to perform this procedure

Perform this procedure before moving the print bars to capping position.

Duration

15 minutes

Required equipment

- Bottle of CS3 fluid
- Lint free cleaning wipes (not rice paper)
- Protective gloves

Procedure



IMPORTANT

Do not attempt to forcefully remove dry ink residue from the print head nozzle plates
Do not drag a cleaning wipe over dry ink as it may damage the print head nozzle plates

1. Perform an automatic purge sequence and then perform an automatic cleaning cycle.

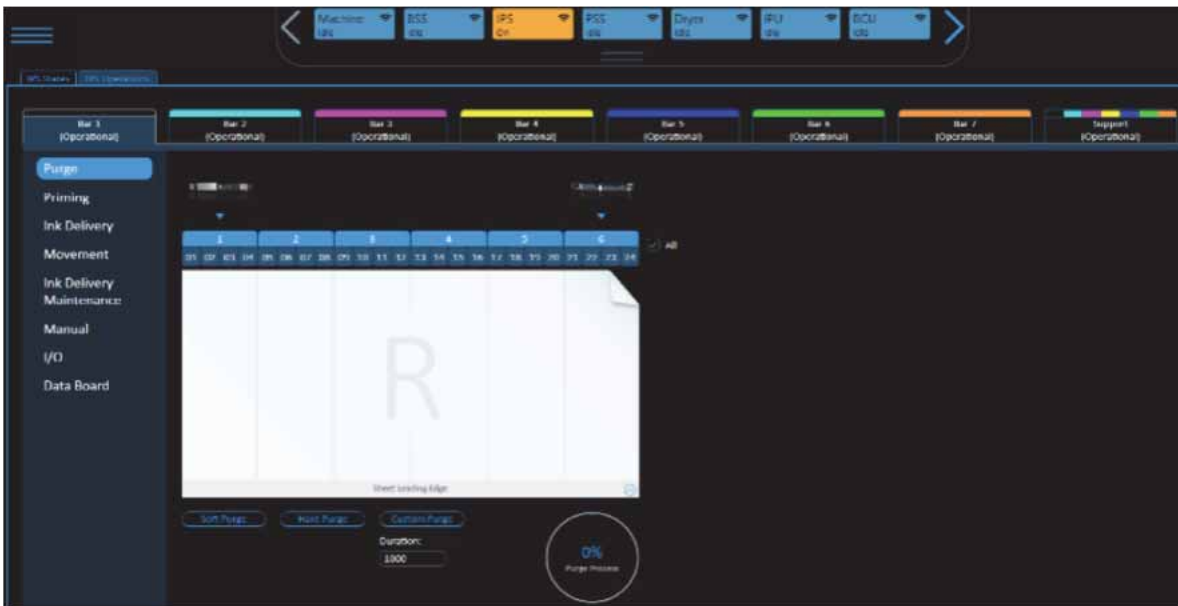

2. Pull out the print bar to service position.



3. Spray CS3 fluid from the bottle onto the seam where two print heads meet. This action dissolves any dry ink that may have accumulated between the print heads.

Leave the CS3 fluid on the seam for 30 seconds before proceeding to the next step



4. Fold the lint free wipe several times. Soak it with CS3 fluid. Wrap the wipe around your finger.

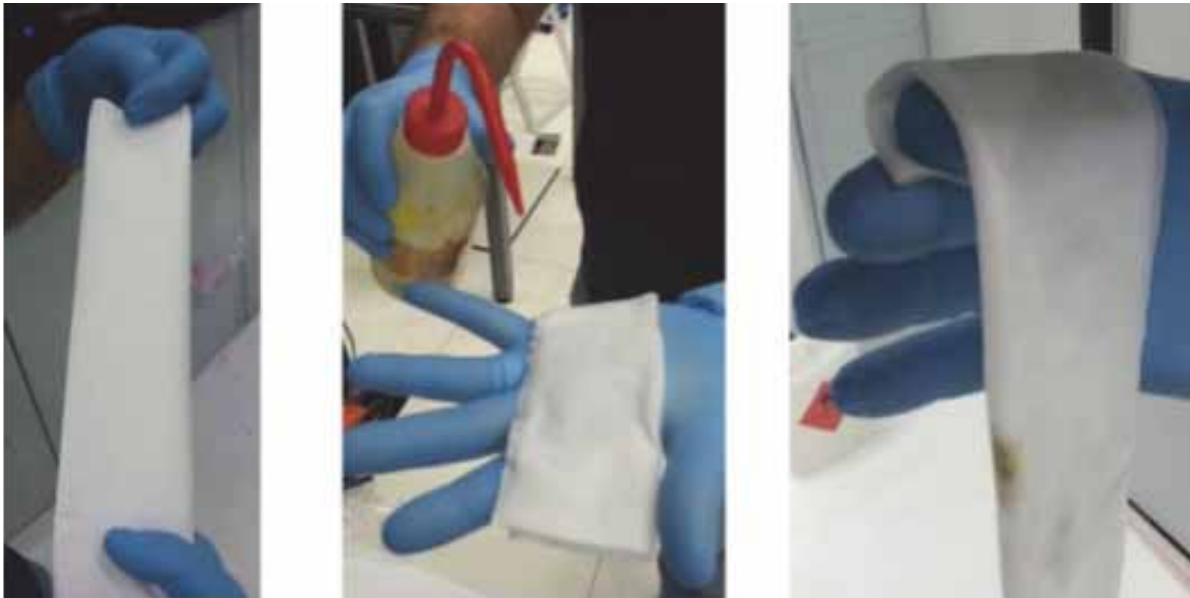

5. Use the cloth to wipe clean the ceramic section of the plate head. Do not touch or clean the nozzle plate with the cloth.



6. Use a clean area of the wipe to clean the next print head.

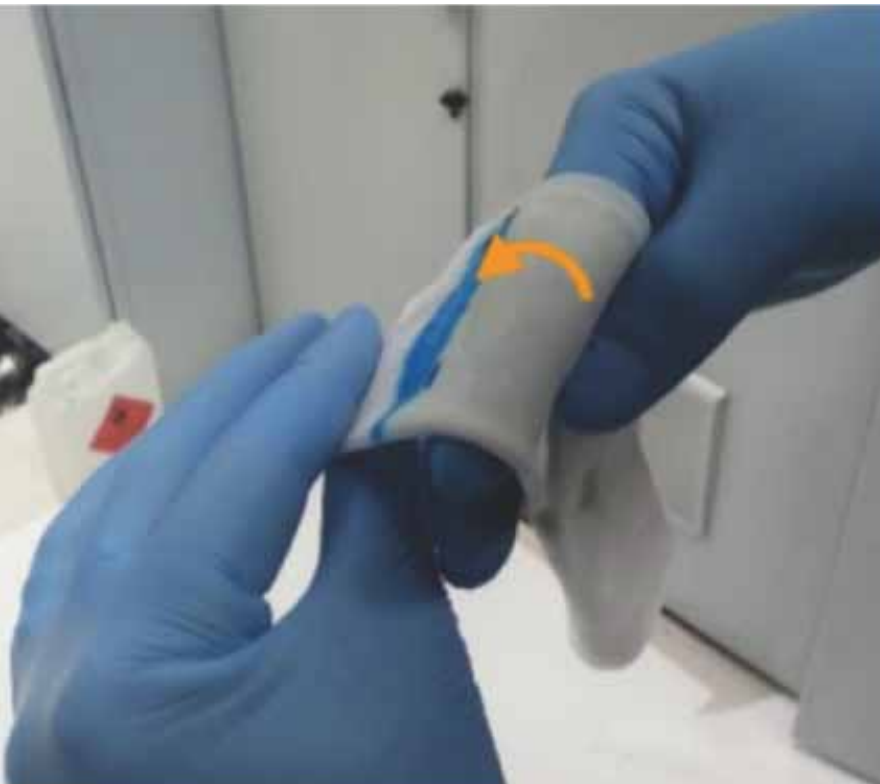
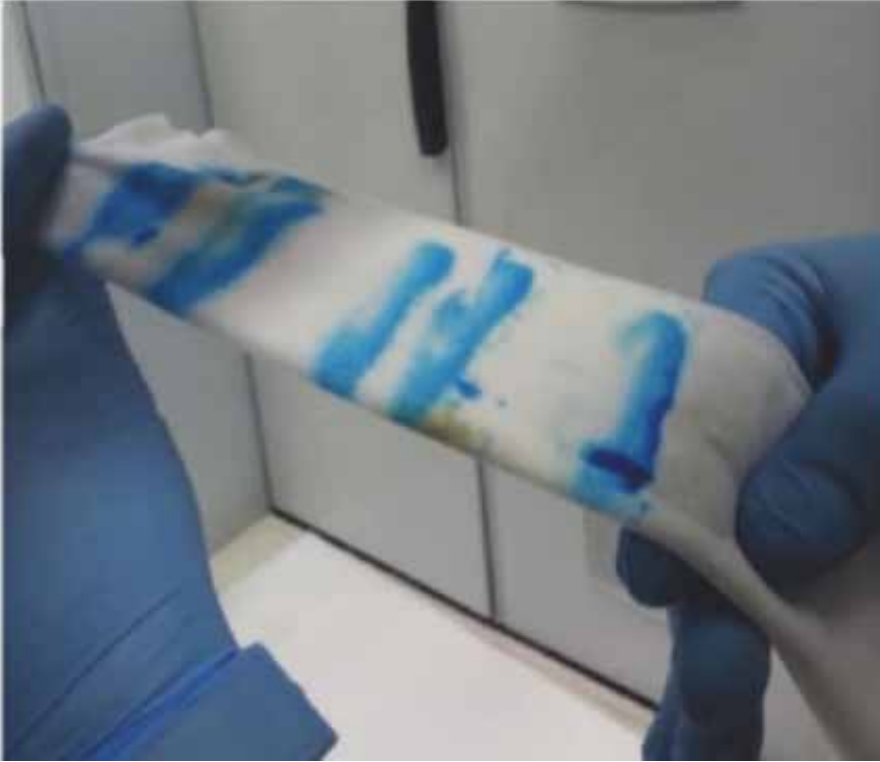

7. After all the ceramics have been cleaned, start cleaning the print head nozzle plates. When cleaning the nozzle, it is important to move the wipe in one direction only - from the front of the press toward the rear of the press.

Do not apply force when attempting to clean dry ink residue from the print heads.

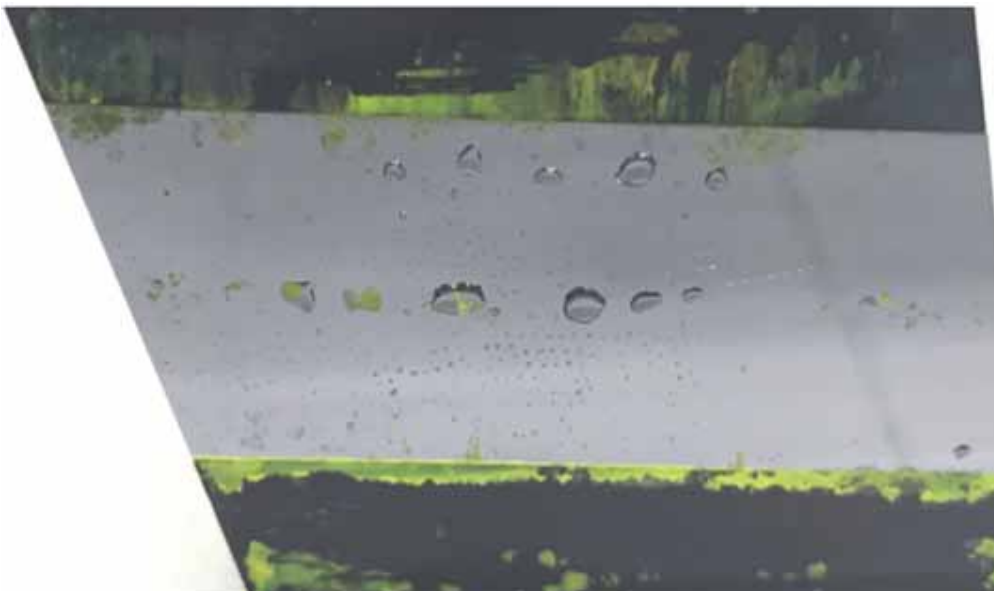
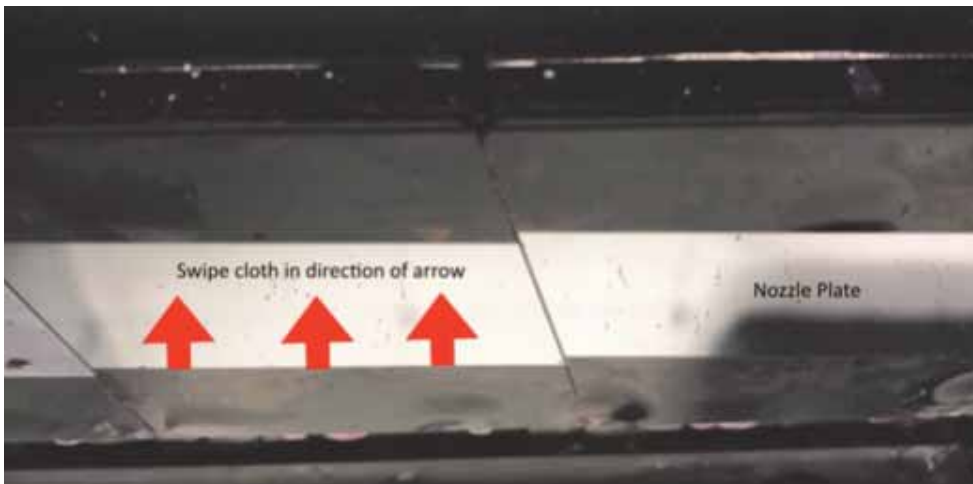

8. Make sure the entire nozzle plate area is clean of ink and residue.



9. Send the print bar to capping position.

Make sure the gap between adjacent print heads is clean

1. Open the Rear Upper Doors.
2. Press the Service button located on the print bar and pull out the print bar to service position.
3. Visually check the underside of the print heads (the nozzle plates) and make sure there is no dry ink collecting in the gap between two adjacent print heads.
If the gap between the print heads is dirty proceed to the next step.
4. Spray print head cleaning solution on to the sides of the print heads.
 - Spray from the top and underside of the print bar - this method of spraying prevents damaging dirty print head nozzle plates.

Make sure the print head cleaning unit is clean

1. Open the Rear Upper Doors.
2. Press the blue button on the print bar and pull out the print bar to service position.
3. Pull out the capping baths.
4. Open the service corridor door and approach the print head cleaning unit.
5. Visually check the print head cleaning unit and make sure it is clean.
If it is dirty, proceed to the next step.
6. Spray print head cleaning solution onto a clean cloth.
7. Gently wipe the surface of the print head cleaning unit (the two vacuum vents and the spraying unit).
8. Exit the service corridor and close the door.
9. Push the capping baths back into position.
10. Push back the print bar and press the blue print bar button.
11. Close the Rear Upper Doors.

Make sure the ink cooling chiller is functioning correctly

1. Visually check the ink cooling chiller and verify that it is ON.
2. Verify the water level in the chiller is between half-full and full.
3. Make sure the chiller reaches the correct temperature:
 - Start of shift temperature: 19°C
 - End of shift and weekend temperature: 24°C

If required use the chiller's keypad arrows to raise or lower the temperature.

If the ink cooling chiller emits a beep, or if does not reach the correct temperature set point, refer to Troubleshooting.

Make sure the print bar door cooling chiller is functioning correctly

The print bar door cooling chiller is responsible for cooling the print bar data boards.

1. Visually check the print bar door cooling chiller and verify it is ON.
2. Make sure the water level in the chiller is between half-full and full.
3. Make sure the chiller reaches the 24°C temperature set point.

If required use the chiller's keypad arrows to raise or lower the temperature.

If the print bar door cooling chiller emits a beep, or if does not reach the correct temperature set point, refer to Troubleshooting.

Clean the start page sensor

The start page sensor is located on the underside of the print bar, close to the print bar ink tank.

1. Open the Rear Upper Doors.
2. Press the blue button on the print bar and pull out the print bar to service position.
3. Carefully clean the sensor with a cloth and print head cleaning fluid.

Priming and blotting

- Priming is a process that removes trapped air bubbles from the ink manifold and ink tubes
- Blotting absorbs excess liquid

Tap Tools > Priming on the LIA.

When the priming process has terminated, perform blotting:

1. Open the Rear Upper Doors.
2. Press the Service button located on the print bar, and pull out the print bar to service position.
3. Fold a clean-room wipe along its long side.
 - The wipe should be made from 100% polyester (part number PCBTX609)
 - Use fabric wiper if clean room wipes are unavailable
4. Apply printing head cleaning fluid to the wipe.
5. Wrap the wipe around your index finger.
6. Gently press the wipe on the print head nozzle plate.

This blotting action absorbs any excess liquid that has accumulated on the plate head nozzle.

Blanket Cooling Unit Procedures



CAUTION

Do not operate the press unless you have read and fully understood the Safety Information. Make sure the Stop button is locked before making any adjustments.

Access the blanket cooling unit tray

1. Open Front Door 4.
2. Open Front Upper Door 2.
3. Rotate the blanket cooling unit handle 90° clockwise.
4. Pull out the blanket cooling unit tray.

Clean the blanket cooling unit environment

1. Access the blanket cooling unit tray.
2. If required, clean the tray and surrounding area with a cloth and hot water.

Make sure the polishing rollers are working correctly

1. Access the blanket cooling unit tray.
2. If required, clean the polishing rollers with a cloth and hot water.

Make sure the revolver knives are clean

1. Access the blanket cooling unit tray.
2. If required, clean the revolver knives with hot water.

Make sure the blanket coolant additive spray nozzles and water nozzles are working correctly

1. From the LIA...
2. Access the blanket cooling unit tray.
3. ...

Make sure the fly-off sensor is clean

1. Clean the fly-off sensor

Cold Water System Procedures

Replace the cold water system filter

1. Open the cold water system cabinet doors.
2. Place a small cup (200 ml) underneath the filter drain valve.
3. Open the valve and drain off the liquid.
4. Close the valve
5. Unscrew the filter cap.
6. Replace the filter and close the filter cap.
7. Close the chilled water system cabinet doors.

Wash the cold water system filters

1. Open the press blower cabinet doors.
2. Close the filter valve, located to the bottom right of the cabinet.
3. Unscrew the filter cap.
4. Clean the filter and close the filter cap.
5. Open the filter valve.
6. Close the press blower cabinet doors.

Wash the cold water system line filter

1. Open the press blower cabinet doors.
2. Rotate the line filter handle in a clockwise direction, and then rotate it in a counter clockwise direction.
3. Close the press blower cabinet doors.

Waste Procedures



CAUTION

Do not operate the press unless you have read and fully understood the Safety Information. Make sure the Stop button is locked before making any adjustments.

Drain the water from the printing system air filter

1. Open Rear Panel 4 (concealing the ink delivery system's pneumatics panel).
2. Place a small cup (200 ml) underneath the printing system air filter's drain valve.
3. Open the drain valve and drain the water into the cup.
4. Close the valve.
5. Close Rear Panel 4.

Drain the water from the paper transport system air filter

The paper transport system air filter is located on the rear side of the feeder board.

1. Place a small cup (200 ml) underneath the air filter's drain valve.
2. Open the drain valve and drain the water into the cup.
3. Close the drain valve.

Drain the water from the cold water system's air filter

1. Place a small cup (200 ml) underneath the cold water system's air filter drain valve.
2. Open the drain valve and drain the water into the cup.
3. Close the drain valve.

Drain the water from the anti condensation pressure regulator's air filter

The anti condensation pressure regulator's air filter is located on the support panel

1. Open the Service Corridor Door and go to the support panel.
2. Place a small cup (200 ml) underneath the anti condensation pressure regulator's air filter drain valve.
3. Open the drain valve and drain the water into the cup.
4. Close the drain valve.
5. Close the Service Corridor Door.

Coating Procedures



CAUTION

Do not operate the press unless you have read and fully understood the Safety Information. Make sure the Stop button is locked before making any adjustments.

Clean the anilox roll



WARNING

Wear chemical resistant gloves to protect your hands from injury and chemicals

1. Raise Coating Unit Panel 3.
2. Apply cleaning solution to a clean cloth:
 - For water based coating:
Apply hot water to a clean cloth
 - For UV based coating:
Apply the manufacturer's recommended cleaning solution to a clean cloth
3. Using the cloth, start at either end of the roll and begin cleaning.
4. Manually rotate the roll until all its surface is clean.
5. To perform a more thorough clean, use an anilox cleaning brush and begin lightly scrubbing in a circular motion while applying light pressure and rotating the roll.
6. Repeat steps 4 and 5 until the entire roll has been completely scrubbed.
7. Lower Coating Unit Panel 3.

Clean the coating unit blanket cylinder



WARNING

Before beginning this procedure, make sure the press cannot be activated via the LIA

1. Open the delivery Coating Unit Panel 1, to gain access to the blanket cylinder.
2. Press the Tune Up button located on the coating unit control panel.
3. Apply cleaning solution to a clean cloth:
 - For water based coating:
Apply hot water to a clean cloth
 - For UV based coating:
Apply the manufacturer's recommended cleaning solution to a clean cloth
4. Using the cloth, start at either end of the blanket and begin cleaning.
5. Press the inch buttons, located on the coating unit control panel, to reveal more of the cylinder's surface.
6. Clean the blanket and keep inching it forward until the entire surface is clean.
7. Close Coating Unit Panel 1.
8. Press the Tune Up button.

Ventilation Procedures



CAUTION

Do not operate the press unless you have read and fully understood the Safety Information. Make sure the Stop button is locked before making any adjustments.

Replace the air filters

1. Open Rear Door 6 (concealing the ventilation cabinet).
2. Release the latches securing the ventilation cabinet, and open the hermetically sealed double-doors.
3. Release the latches securing each of the four air filters.
4. Extract the dirty air filters.
5. Install the replacement ventilation filters.
6. Close and lock the ventilation cabinet's double-doors.
7. Close Rear Door 6.

Dryers/Image Pinning Unit Procedures



CAUTION

Do not operate the press unless you have read and fully understood the Safety Information. Make sure the Stop button is locked before making any adjustments.

Clean the dryer and image pinning unit blower filters

1. From the LIA Control Panel, put the printing press in Standby mode.



WARNING

The units are extremely hot, therefore it is recommended to perform this procedure when the press is 'cold'. If you do perform this procedure and the press is not cold, then make sure to use appropriate protection (thermal gloves etc.) before attempting to replace the filters.

2. Open Front Upper Doors and the Service Corridor Door.
3. Remove the (grey) thermal isolation covers from the dryer/image pinning unit.
4. Remove the dryer/image pinning unit protective cover.
5. Loosen the two captive screws.
6. Remove the blower filter.
7. Clean the blower filter with hot water.
8. Reinstall the blower filter.
9. Tighten the two captive screws.
10. Reinstall the dryer/image pinning unit protective cover.
11. Reinstall the thermal isolation covers.
12. Close the Front Upper Doors and Service Corridor Door.

Chapter 7

Basic Printing Procedures

Final Check Before Printing



CAUTION

Do not operate the press unless you have read and fully understood the Safety Information. Make sure the Stop button is locked before making any adjustments.

Before starting the printing press, make sure it is in good condition and ready for operation.

Only begin to operate the printing press after you have checked all of the items described in the checklist below.

Checklist

- Maintenance checklist has been performed
- Press been lubricated as specified
- All the Stop buttons are in the OFF position
- All footboards and safety covers are closed
- Safety Monitor indicators have been checked
- Oil level at each lubrication point has been checked
- Make sure there are no tools or rags left on the footboards
- Make sure there is no oil or water on the footboards
- Make sure there aren't any tools, rags, or other items left on feeder or delivery sheet piles
- Make sure nobody is working inside the press
- Make sure the double sheet detectors have been correctly adjusted
- Make sure the feeder unit photoelectric sensor is working correctly
- Check that all adjustments, settings, maintenance and preservation work, and replacement or refilling of consumables have been performed, and retighten or assemble any loose or missing lock bolts and nut covers, etc.
- Check that the exhaust ports (drive motor and blowers) are not blocked



CAUTION

Go through the above checklist every day before starting the press. Also read and fully understand the Safety Information and perform all maintenance as described in the Maintenance Checklists.

Start the Printing Press



CAUTION

Do not operate the press unless you have read and fully understood the Safety Information. Make sure the Stop button is locked before making any adjustments.

1. Turn the Main Power Switch to ON.

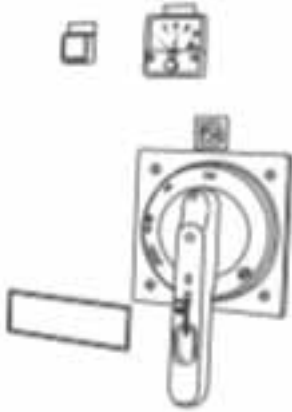

2. Make sure the compressed air pressure has risen sufficiently. The standard regulator air pressure setting is 0.6 bar.

A: Compressor

B: Regulator

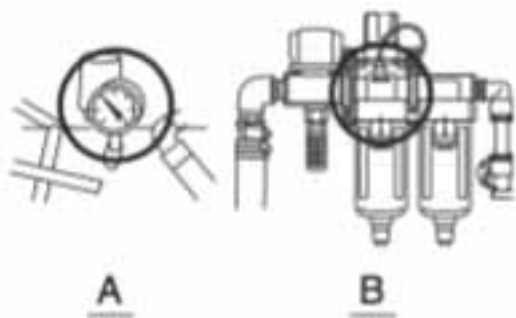

3. Make sure there are no objects between the cylinders or on the feeder board.



4. Make sure the Landa Digital Front End (DFE) computer is turned on.
5. Open the Landa Operator Cockpit doors, located beneath the inspection table.
6. Turn on the Operator Press Controller (OPC) computer.
7. Turn on the Data Path Computer (DPC).
8. Tap the Initialize button on the LIA Control Panel.
 - The printing press status changes to Move to Standby
9. Tap the Move to Standby button on the Landa Control Panel.
 - The printing press status changes to Move to Ready.
10. Close the Landa Operator Cockpit doors.

Prepare the Paper



CAUTION

Do not operate the press unless you have read and fully understood the Safety Information. Make sure the Stop button is locked before making any adjustments.

Load the paper into the feeder.

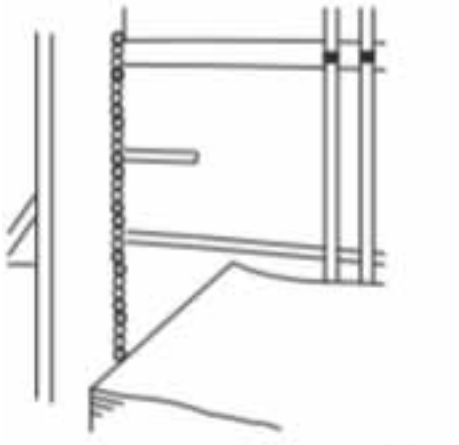

Load the paper carefully. The registration accuracy is greatly affected by how the paper is loaded onto a sheet pile.

Adjust the Sucker Settings



CAUTION

Do not operate the press unless you have read and fully understood the Safety Information. Make sure the Stop button is locked before making any adjustments.

1. Adjust the front-to-back position of the suckers according to the size of the paper.
2. Adjust the settings of the sucker parts (pickup suckers, forwarding suckers, separator, spring steel separators, and weights) according to the size of the paper.

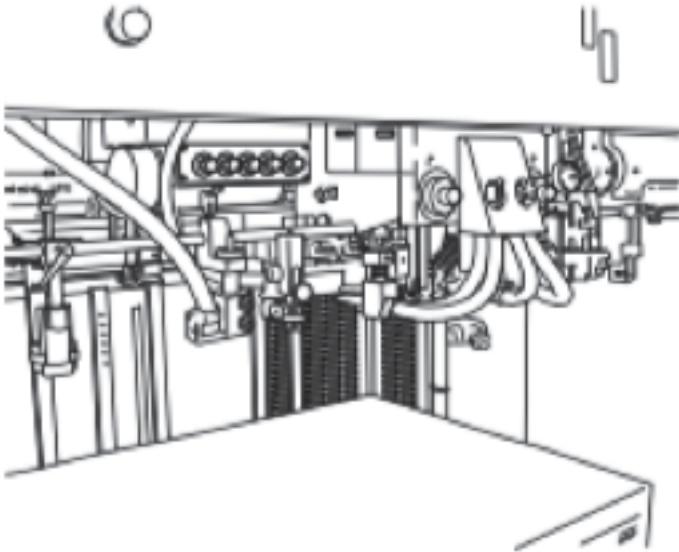

3. Adjust the settings of the air valves and the pumps according to the size of the paper.

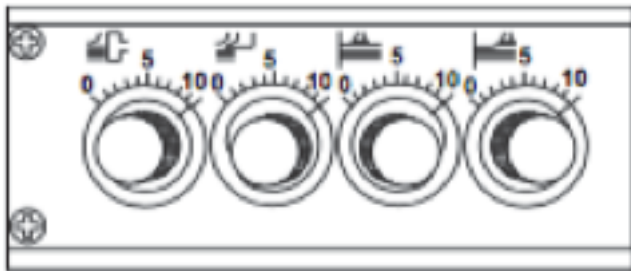

Adjust the Register Settings



CAUTION

Do not operate the press unless you have read and fully understood the Safety Information. Make sure the Stop button is locked before making any adjustments.

1. Adjust the height of the upper plate of the side lays according to the paper thickness. In addition, adjust the lateral position of the side lay as necessary.
See Check the sheet contact timing.
2. Check the height of the A transfer cylinder gripper pad. Adjust if necessary.
See Adjust the A transfer cylinder gripper pads.
3. Adjust the front lay one touch guide according to the paper thickness.
See Adjust the front lay one touch guide.
4. Check and set the register front lay sensors.

Prepare the Delivery Unit



CAUTION

Do not operate the press unless you have read and fully understood the Safety Information. Make sure the Stop button is locked before making any adjustments.

1. Insert the pile board to delivery and prepare for sheet delivery.



2. Adjust the suction wheel and paper jogger positions according to the paper size.
3. Make sure that the upper surface of the delivery pile is raised as high as the sheet lay. Make sure the delivery panel Main Pile Hoist button is not lit.

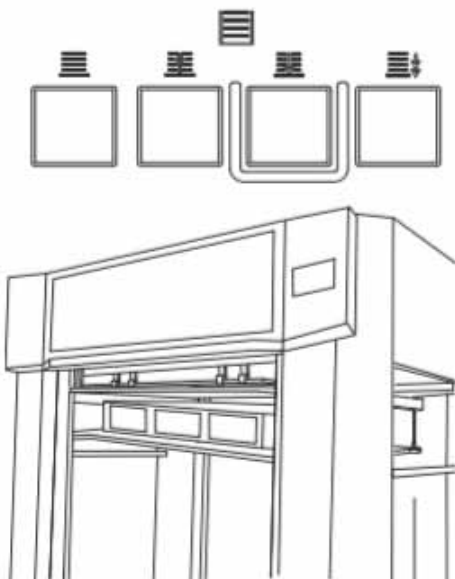

Final Procedures Before Printing



CAUTION

Do not operate the press unless you have read and fully understood the Safety Information. Make sure the Stop button is locked before making any adjustments.

Check the following before starting to print:



When checking the items below make sure the press is stopped

- Check that all covers are closed
- Check that no tools, printing materials, or other items have been left on the press
- Check that no errors are displayed on the LIA
- Check that there are no other abnormalities that could prevent printing

Printing



CAUTION

Do not operate the press unless you have read and fully understood the Safety Information. Make sure the Stop button is locked before making any adjustments.

1. On the LIA, select the job to print.
2. Tap the Start Printing button.

Finishing Procedures



CAUTION

Do not operate the press unless you have read and fully understood the Safety Information. Make sure the Stop button is locked before making any adjustments.

1. Clean the printing press according to the Maintenance Checklist.
2. Stop the printing press and turn the Main Power Switch to OFF.

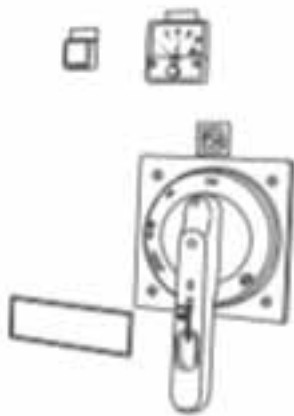

Chapter 8

Press Procedures

**CAUTION**

Do not perform any procedures on the press unless you have read and fully understood the Safety Information.

Make sure the Stop button is locked before making any adjustments.

Printing System Procedures

Replace an ink farm tank

1. Go to the ink farm and raise the docking handle of the tank you wish to replace.
2. Wheel out the ink tank from its bay.
3. Remove the ink tank from the spill tray.
4. Install a replacement ink tank into the spill tray.
5. Wheel the ink tank back into its designated bay.
6. Lower the ink tank docking handle.

Blanket Conveyor System Procedures

Install an image transfer blanket

Safety equipment

The following safety equipment is needed to perform the image transfer blanket installation procedure:

- Thermal gloves (1234567890)
- Latex gloves (1234567890)

Prerequisites checklist

1. Make sure the press is in Standby mode.
2. Make sure Ctrl+Shift has been implemented (in order to pass the controls to 'local' control panels).
3. Make sure the paper transport system cylinder is positioned at the open angle.
4. Make sure the fly-off has been disengaged.
5. Make sure the impression vacuum has been switched off.

Procedure



WARNING

Wait for the press to cool down before performing this procedure.

1. Open the Feeder Bridge Door (1) and raise the Access Panel (2)
2. Slide out the blanket protection plate.
3. Raise the feeder bridge (3).

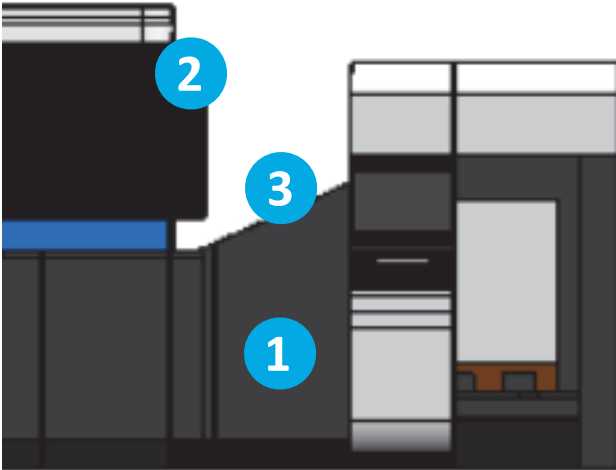

WARNING

Wear thermal gloves (1234567890)

4. Use a knife to cut the blanket.
5. Remove the image transfer blanket.

Clean components

Make sure the following are clean:

- BCD rollers
- BTD rollers
- Printing (encoder) rollers
- Image pinning unit slits
- Dryer slits
- Dancer roller
- Dryer rollers
- Idler rollers
- Receptacles beneath the blanket path
- Floor underneath the impression drum

Install the image transfer blanket onto the press

1. Place the blanket box next to the blanket insertion area.
2. Grip the leading edge of the image transfer blanket, and pull it from the box.
3. Connect the leading edge to the chain.
4. Rotate the manual lever and wait for the blanket leading edge to arrive.
5. Remove the protective cover from the blanket.
6. Secure both blanket edges to the clamps.
7. Join the seams together using glue and the blanket patch.
8. Use glue to fill in the remaining cracks.
9. Turn on the blanket heating plate.
10. Wait 20 minutes.
11. Make sure the fly-off sensor is working.
12. Move the fly-off to the engage position.
13. Release the blanket from the clamps.
14. Apply glue to the figure-eight shaped teeth.
15. Apply hot melt.

Paper Transport System Procedures

Install a paper transport system blanket



CAUTION

- Make sure you have read and understood the Safety Information before operation
- Make sure to lock the Stop button before making any adjustments



WARNING

Wait for the blanket to cool down before performing this procedure.

Note: Two certified Landa Operators are required to perform this procedure

1. Open the following doors:
 - Front Upper Door 1
 - Front Door 1
 - Service Corridor Door
2. Position one person inside the Service Corridor and one person at the front of the press
3. Locate the Hand Held Controller inside the Service Corridor and press the Inch button to inch the press to a position where the blanket can be installed on the gripper side.

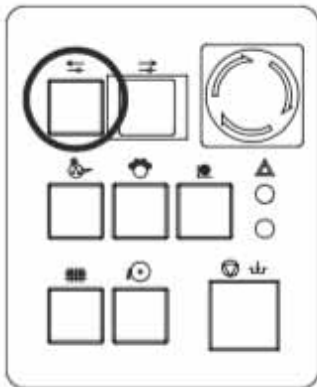

4. Insert your finger into the hole in the gap cover of the blanket cylinder, press and hold the leaf spring, and push the gap cover toward the drive side to remove it.



CAUTION

Make sure to lock the Stop button before making any adjustments

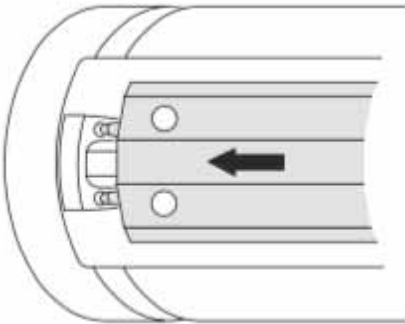

5. Use a T-socket wrench to move the rubber winding bars to a position suitable for blanket mounting, and then use the wrench to adjust the bar locking bolt so that they are parallel.

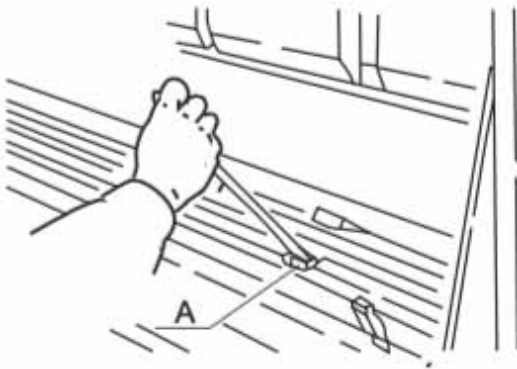

A: Bar lock bolt



CAUTION

Make sure to lock the Stop button before making any adjustments

6. Make sure the packing clamp is already attached to the packing.

7. Insert the packing - align the clamps with the leaf spring holes.

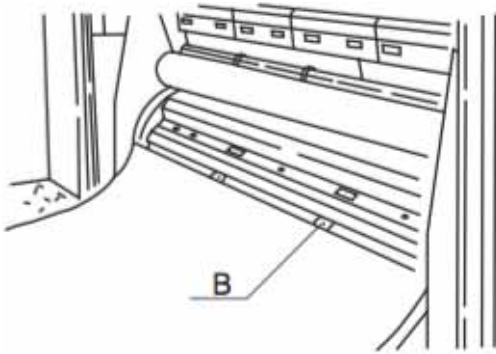

B: Leaf spring



CAUTION

Make sure to lock the Stop button before making any adjustments

8. Push the blanket in to insert it into the winding bar and check that the left and right clearances are equal. Use the wrench to turn the locking bolt. Make sure the blanket has been installed correctly onto the rubber winding bar.

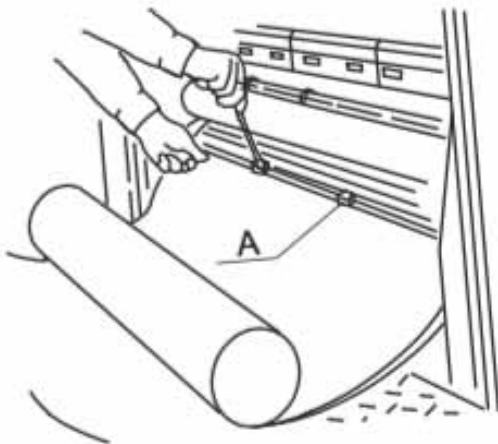

A: Bar lock bolt

9. Use a T-socket wrench to wind the blankets as required.



10. Using the Inch button, run the press to a position where the bracket for the blanket of the trailing edge can be installed.

Fit the bracket into the rubber winding bar, and lock the fixing bolt.

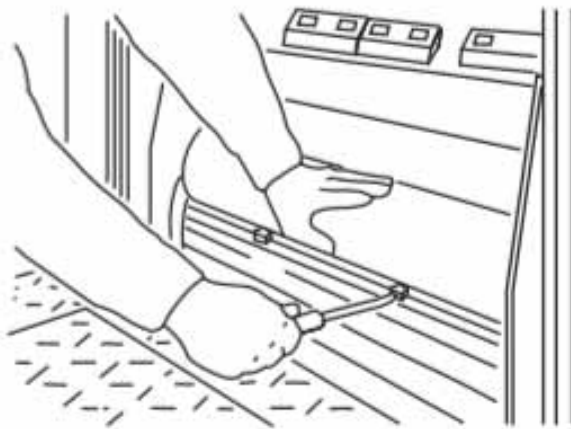

11. Make sure the installation on the rubber winding bar is perfect.

Use the T-socket wrench to apply sufficient tension. When using a torque wrench, set it to 58.8 to 63.7 N m (600 to 650 kgf cm).

Retighten after engaging the cylinders and printing 50 impressions, then retighten again after printing 500 impressions.

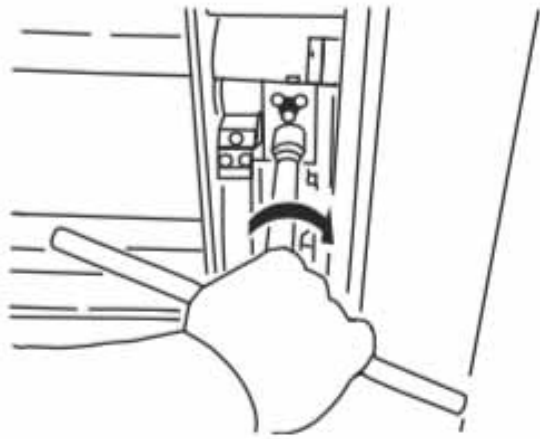

- After the blanket has been installed, inch the press and check by hand that the packing is properly positioned and that no foreign matter is present.
- When winding the blanket on the cylinder, do not allow foreign matters to get in.
- Protect the cylinder printing area from corrosion.

12. After installing the blanket, return the blanket cylinder gap cover to its original position.

13. Align the pins on the drive side of the blanket cylinder gap cover with the holes in the securing block. Insert your finger into the hole in the gap cover, press and hold the leaf spring, and push the gap cover toward the drive side. Insert the pins on the operation side into the holes in the block.

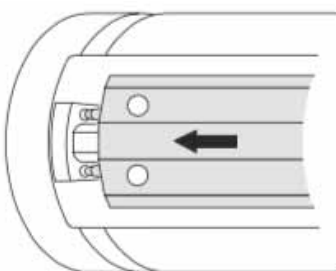
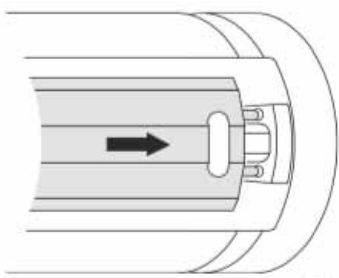

14. Check that the pins on the operation side are inserted into the holes in the block. In addition, check that the pins on the drive side are inserted into the holes in the block up to the red line on the pins.

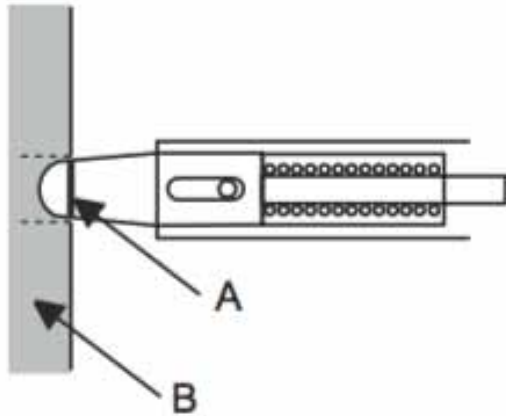

A: Red line

B: Block



CAUTION

- Do not operate the press with the gap cover removed except when replacing a blanket
- Make sure the left and right pins are correctly inserted before rotating the cylinder

Blanket Cylinder Finishing

After a blanket is replaced by a new one and several hundred sheets are printed, the blanket is flattened out by the printing pressure, and this results in a small amount of slack. It is important to tighten the blanket since slack can cause double printing, slurs, dot-shaped imperfections, and other printing defects. When tightening in some cases, the amount of protrusion may be slightly negative when you measure it using a cylinder gauge. If it is negative, use a cylinder expansion sheet or other tool to adjust the amount of protrusion.

Also, if it worsens as printing continues, fatigue may have occurred in the blanket. Measure the amount of protrusion at regular intervals, and then perform finishing again.

Normal amounts of fatigue for the blanket:

- Hard blanket 0.03 mm
- Air blanket 0.05 mm

15. Close the following doors:

- Front Upper Door 1
- Front Door 1
- Service Corridor Door

Feeder and Register Unit Procedures

Adjust the A transfer cylinder gripper pads

This setting must be changed based on the paper thickness.

1. Inch the press and stop at the position where the adjustment part is visible.

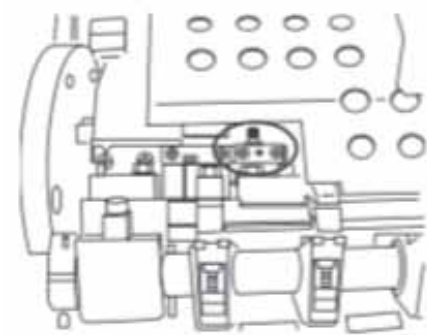

2. Remove the safety cover in front of the A transfer cylinder.
3. Use a 2.5 mm hex key to loosen, but do not remove, the set screw in the adjustment part.

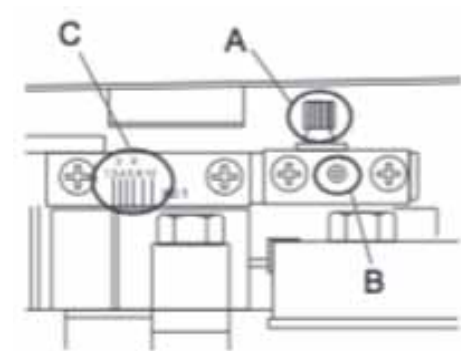

A: Adjustment bolt
B: Set screw
C: Scale

4. Turn the adjustment bolt (12 x 14 hex key) to align the scale with the paper thickness.
 - Set the scale to 0.6 for a paper thickness of 0.2 -0.8 mm
 - If the paper thickness is less than 0.2 mm, set the scale to 0.3
5. After completing the adjustments, firmly tighten the set screw and lock the adjustment bolt.

Adjust the front lay one touch guide

This setting must be changed based on the paper thickness.

Turn the adjustment bolt (A), located on the operation side of the paper guide (rotate the entire guide), to set it so that the gap between the paper guide and feed board is 0.5 - 1.0 mm.

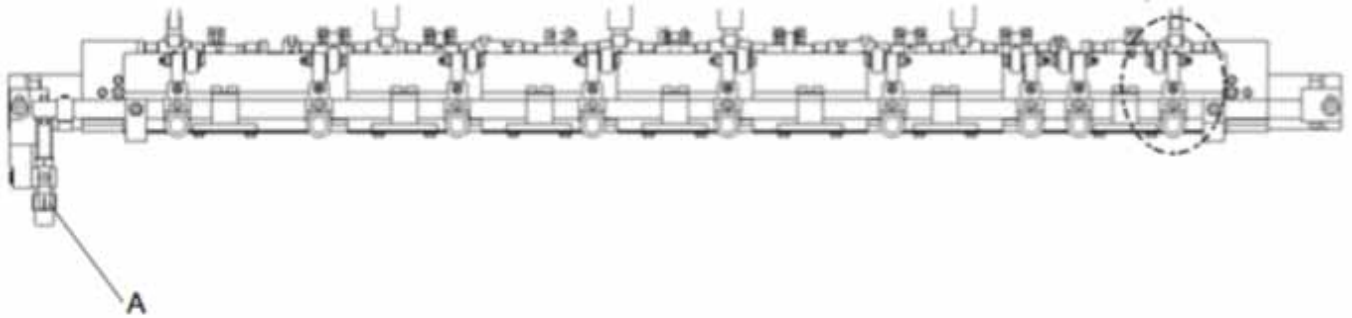

A: Adjustment bolt

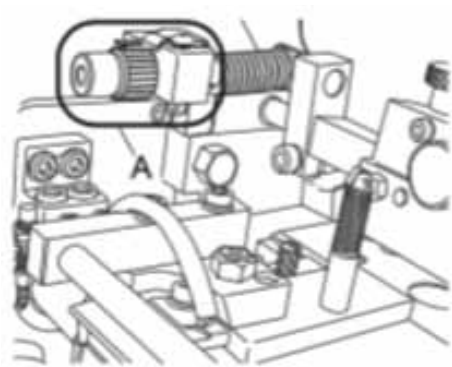

Adjust the height of an individual steel plate guide

1. Loosen the two lock bolts (B).
2. Adjust the height of the steel plate guide.
3. Retighten the lock bolts.
 - Upon installation, the height of the steel plate guides has been adjusted so that the feeder board and the steel plate guide become parallel when the clearance between them is 0.4 mm.

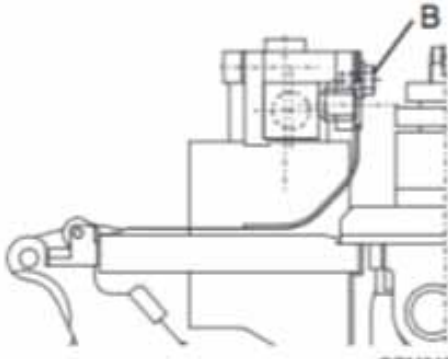

B: Lock bolt

Adjust the height of an individual wheel guide

1. Loosen the bolt lock nut (D).
2. Turn the individual wheel height adjusting bolt (C).

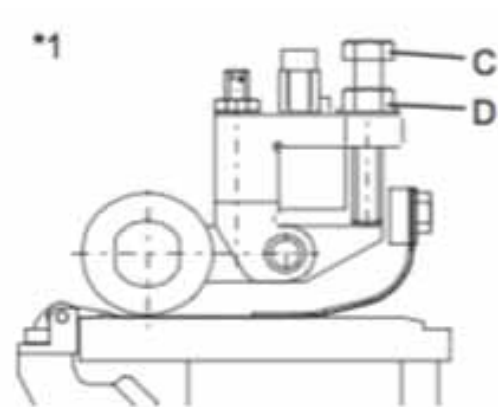

C: Hexagonal nut

D: M8 nut

Remove a steel plate guide

1. Loosen the lock bolt (E).
2. After reinstalling the steel plate guide, lightly tighten the lock bolt (E) first and check that the steel plate guide is securely attached.
3. If required, re tighten the lock bolt (E).

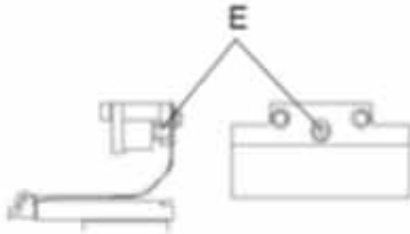

E: Lock bolt

Remove a wheel guide

1. Remove the lock bolt (F) and block (G).
2. After reinstalling the steel plate guide, lightly tighten the lock bolt (F) first and check that the steel plate guide is securely attached.
3. If required, retighten the lock bolt (F).

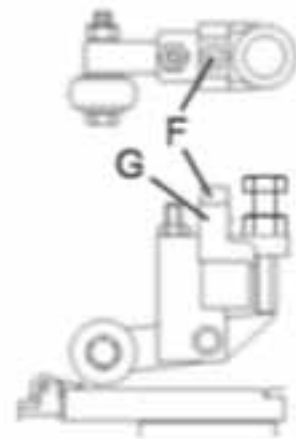

F: Lock bolt

G: Block

If wrinkling occurs on the thin paper with thickness of less than 0.3 mm, use only the steel plate guides. (For paper with thickness of 0.3 mm or more, use only the wheel guides.)

The above-mentioned paper thickness must be used as a guide. Select either the steel plate guides or roller guides, according to the quality of paper.

Check the sheet contact timing



CAUTION

Do not operate the press unless you have read and fully understood the Safety Information. Make sure the Stop button is locked before making any adjustments.

1. Remove one sheet by using inching.
2. Read the press timing display in the feeder operation panel for the timing of the sheets from the 2nd sheet as the front edge of the sheet hits the front lay, and then compare the difference with the reference timing.
As this timing is adjusted before shipment from the factory, basically the adjustment is not necessary. However, if the timing is running fast or slow, call Landa Support.

Coating Unit Procedures

Replacing the plate/blanket with the tool-less clamp



CAUTION

Do not operate the press unless you have read and fully understood the Safety Information.

Cylinder Gap Cover

- When replacing the plate/blanket, the cylinder gap cover must also be removed and mounted.
- Be sure to lock the Emergency Stop/Safe button before performing this procedure.

Installation

1. Align the movable taper pin with the drive side locking block hole, and push the cover toward the drive side while depressing the leaf spring from the cover hole (A in the illustration below) so that the operation side locking straight pins enter the block holes.

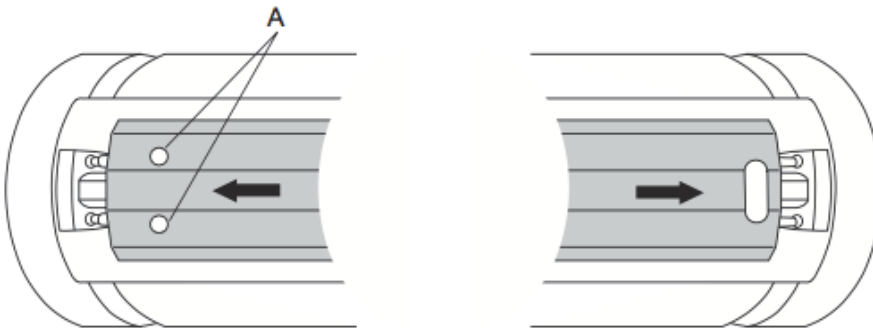

2. Check that the straight portions of the locking straight pins are completely inserted into the block holes. Check that the movable taper pin is inserted into the block up to the red line.

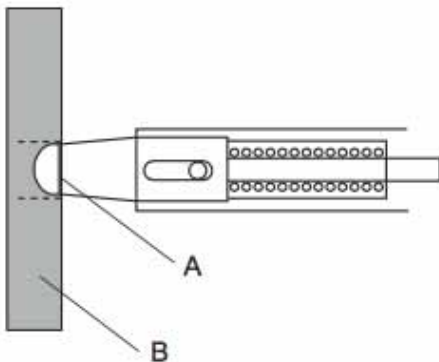

A: Red line

B: Block

Removal

Push the cover toward the drive side while depressing the leaf spring from the cover hole, and pull out the locking straight pins.

Plate changing



CAUTION

This is an important safety cover, so do not operate the press with the cover removed other than when replacing the plate or the blanket.

Be sure to check the left and right pin insertion amounts when the cover is mounted, and only operate the press after making sure there are no problems.

1. On the touch screen monitor of the delivery unit front panel, select APC on the AMR screen and coater unit C.



2. On the touch screen monitor, use the coater plate selection button to select Flexo.

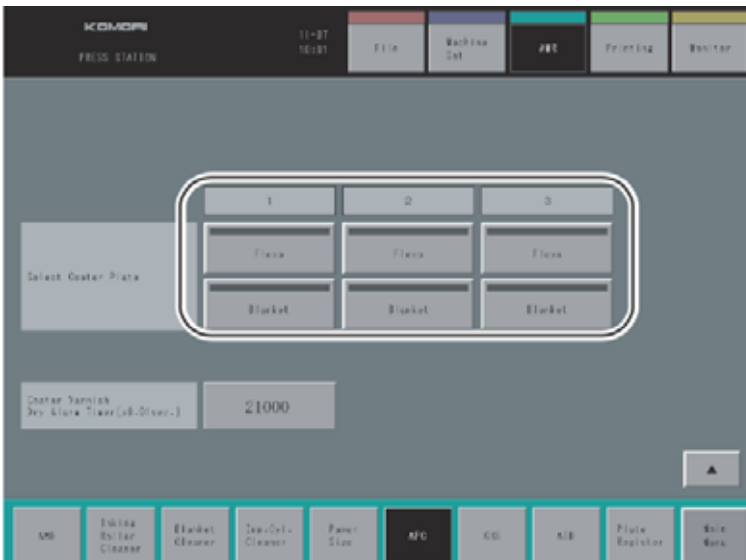

3. Press the “AMR” button. The coater plate changing starts.



Plate changing (resin plate)



CAUTION

Do not operate the press unless you have read and fully understood the Safety Information. If the blanket is installed beforehand, coater plate exchange must be set independently and the plate clamp setting must be reset to its home position on the AMR beforehand. If plate exchange is performed without resetting the plate clamp to its home position, a malfunction or a failure may occur.

1. On the PQC touch panel, select plate changing.
2. Press the AMR button. When the alarm stops, press the AMR button again.
3. When the coater plate exchange is ready, move to the coating unit.
The press rotates and stops at the reference position.
 - The leading edge plate clamp loosens, the press turns and stops, and the trailing edge plate clamp loosens and opens
 - The plate holding roller holds the plate
4. Open the Coating Unit Panel 1 cover.
5. Hold the trailing edge (cap at the trailing edge of the blanket) of the plate with your hand.
6. Press Start. When the alarm stops, press Start again and hold it pressed to pull out the plate (blanket).
 - The press rotates and stops at the reference position
 - The plate holding roller disengages the plate

7. Press Start. When the alarm stops, press Start again and hold it pressed to pull out the plate (blanket).
 - The press rotates and stops at the reference position
 - The leading edge plate clamp opens
8. Remove the previous plate (blanket) then insert the prepared plate into the leading edge plate clamp.
9. Press Start. When the alarm stops, press Start again and hold it pressed to rotate the press.
 - The press rotates and stops at the reference position
10. Press Start. When the alarm stops, press Start again.
 - The leading edge plate clamp closes
11. Press Start. When the alarm stops, press Start again and hold it pressed to wind the plate on.
 - The press rotates and stops at the reference position
12. Press Start. When the alarm stops, press Start again.
 - The plate holding roller holds the plate
13. Press Start. When the alarm stops, press Start again and hold it pressed to wind the plate on.
 - The press rotates and stops at the reference position
14. Insert the plate into the trailing edge plate clamp.
15. Press Start. When the alarm stops, press Start again and hold it pressed to rotate the press.
 - The press rotates and stops at the reference position
16. Press Start. When the alarm stops, press Start again.
 - The trailing edge plate clamp closes
 - Tighten the trailing edge plate clamp
 - The plate holding roller disengages the plate
17. Close the Coating Unit Panel 1 cover.

Plate changing (in case of blanket)



CAUTION

Do not operate the press unless you have read and fully understood the Safety Information. If the blanket is installed beforehand, coater plate exchange must be set independently and the plate clamp setting must be reset to its home position on the AMR beforehand. If plate exchange is performed without resetting the plate clamp to its home position, a malfunction or a failure may occur.

1. On the PQC touch panel, select blanket changing.
2. Press the AMR button. When the alarm stops, press the AMR button again.
3. When the coater plate exchange is ready, move to the coating unit.
The press rotates and stops at the reference position.
 - The leading edge plate clamp loosens, the press turns and stops, and the trailing edge plate clamp loosens and opens
 - The plate holding roller holds the blanket
4. Open the Coating Unit Panel 1 cover.
5. Remove and hold the cap at the trailing edge of the blanket (or trailing edge of the plate) with your hand.
6. Press Start. When the alarm stops, press Start again and hold it pressed to pull out the blanket (resin plate).
 - The press rotates and stops at the reference position
 - The plate holding roller disengages the plate
7. Press Start. When the alarm stops, press Start again and hold it pressed to pull out the blanket (resin plate).
 - The press rotates and stops at the reference position
 - The leading edge plate clamp opens
8. Remove the previous blanket (plate) then insert the cap of the prepared blanket into the leading edge plate clamp.
9. Press Start. When the alarm stops, press Start again and hold it pressed to rotate the press.
 - The press rotates and stops at the reference position
10. Press Start. When the alarm stops, press Start again.
 - The leading edge plate clamp closes
11. Press Start. When the alarm stops, press Start again and hold it pressed to wind the blanket on.
 - The press rotates and stops at the reference position
12. Press Start. When the alarm stops, press Start again.
 - The plate holding roller holds the blanket
13. Press Start. When the alarm stops, press Start again and hold it pressed to wind the blanket on.

- The press rotates and stops at the reference position
14. Insert the cap of the blanket into the trailing edge plate clamp.
 15. Press Start. When the alarm stops, press Start again and hold it pressed to rotate the press.
 - The press rotates and stops at the reference position
 16. Press Start. When the alarm stops, press Start again.
 - The trailing edge plate clamp closes
 - Tighten the trailing edge plate clamp
 - The plate holding roller disengages the blanket
 17. Press Start. When the alarm stops, press Start again and hold it pressed to rotate the press.
 - The press rotates and stops at the reference position
 - Tighten the trailing edge plate clamp
 18. Tension the blanket by tightening the fastening bolts on both the leading-and trailing-edge plate clamps
 19. Close the Coating Unit Panel 1 cover.

Chapter 9

Operating the Press

Perform an emergency stop

The locations of the ten Emergency Stop buttons are described in the Safety Device Locations section.



Only press the Emergency Stop button in emergency cases, specifically when you need to stop fast-speed operations. Frequent use of the button places a large burden on the motor brakes, which can lead to a malfunction.

Press the Emergency Stop button to stop the press immediately, regardless of its status.

- The Emergency Stop button is a push-lock button that remains pushed in when pressed
- The feeder and delivery piles and paper size preset operations cannot be activated

Release the push-lock Emergency Stop button

Turn the Emergency Stop button clockwise. The press can now be run.

Stop the feeder main pile during descent

Press the Main Pile Stop button.



This button has no effect when the pile is rising automatically

Lower and raise the feeder pile

1. Press the Main Pile Hoist button.
 - The button is illuminated
2. Press the Main Pile Up button to raise the pile, or press the Main Pile Down button to lower the pile.



The pile also stops if it reaches the upper limit detector or pile height detector, even if the button is still pressed.

The pile control circuits allow the pile to descend until it reaches the limit set by the temporary descent stop switch or the lower limiter

3. Press the Main Pile Stop button to stop raising or lowering the feeder main pile.
4. Press the Main Pile Hoist button again to disable the manual override and return to automated raising and lowering of the pile.

Lower and raise the auxiliary pile

1. Press the Auxiliary Pile Hoist button.
The button is illuminated.
2. Press the Auxiliary Pile Up button to raise the pile, or press the Auxiliary Pile Down button to lower the pile.
 - When the Auxiliary Pile Up button is released, the pile stops rising.



The pile also stops if it reaches the upper limit detector or pile height detector, even if the button is still pressed.

- When the Auxiliary Pile Down button is released, the pile stops descending.



The pile also stops if it reaches the lower limit detector or pile height detector, even if the button is still pressed.

3. Press the Auxiliary Pile Hoist button again to disable the manual override and return to automated raising and lowering of the pile.

Activate automatic sideways control of the sheet pile board

Press the Pile Sideways Control Start/Stop button.

- The button is illuminated
- The photoelectric sensor is activated for automatic sideways control of the sheet pile board

Check if the 0 point recovery has been completed

Check the Home Position Return indicator.

- When the indicator is illuminated the 0 point recovery has been completed
- The indicator remains illuminated until the sheet pile board is moved from the 0 point position

Reset the sideways control pile

Press the Sideways Control Pile Reset button.

- The button is illuminated
- The sheet pile board lowers and then returns to the home position when it reaches the lower limit

When this button is not illuminated, the sheet pile board remains in its current position.

Move the sheet pile board toward the operation side

Press and hold the Press and hold the Sideways Control Manual Operation (operation side) button.

Move the sheet pile board toward the drive side

Press and hold the Press and hold the Press and hold the Sideways Control Manual Operation (drive side) button.

Move the sucker box in the direction of the feeder

1. Press and hold the Sucker Circumferential Adjustment (+) button.
2. Release the button to stop moving the sucker box.

Move the sucker box in the direction the delivery

1. Press and hold the Sucker Circumferential Adjustment (—) button.
2. Release the button to stop moving the sucker box.

Raise the height of the sucker box

1. Press and hold the Sucker Height Adjustment (+) button.
2. Release the button to stop moving the sucker box.

Lower the height of the sucker box

1. Press and hold the Sucker Height Adjustment (—) button.
2. Release the button to stop moving the sucker box.

Move the side separator toward the sheet pile

1. Press the relevant Side Separator Switching button:
 - Operator Side button
 - Drive Side button
2. Press and hold the Side Separator Adjustment — button.
3. Release the Side Separator Switching button to stop moving the side separator.

Move the side separator away from the sheet pile

1. Press the relevant Side Separator Switching button:
 - Operator Side button
 - Drive Side button
2. Press and hold the Side Separator Adjustment + button.
3. Release the Side Separator Switching button to stop moving the side separator.

Rotate the substrate transport system cylinders

Enable the substrate transport system cylinders to rotate after the Prepare to Print software button has been pressed.

Press the Enable Paper Transport System button.

- The button flashes
- The substrate transport system cylinders rotate

Stop the press when it is running at slow or slower speed

Press the Stop button.

- The press immediately stops when it is running at slow or slower speeds. However, if the Stop button is pressed and the cylinders are engaged at slow or fast speed, the press runs at slow speed and only stops after the last sheet exits the delivery unit.
- This button uses a turn-locking system

Lock the Stop button

Rotate the Stop button clockwise.

Release the Stop button

Rotate the Stop button counterclockwise.

Start automatic sheet feeding

1. Press the Automatic Sheet Feeding button.

- Automatic sheet feeding begins
- The button flashes

Automatic sheet feeding is performed in the following order:

- a. Start
 - b. Ready
 - c. Slower speed
 - d. Ready
 - e. Slow speed
 - f. Feeder pump on
 - g. Dampening form roller on
 - h. Feeder on
 - i. Check that the paper surface is uppermost Feeder air valve open
 - j. Paper feed
 - k. Automatic cylinder engagement
 - l. Fast speed
2. Press the Automatic Sheet Feeding button again.
- The feeder air valve is closed
 - Sheet feeding stops
 - The cylinders are automatically disengaged, and the press runs at slow speed

Disengage the cylinders in an emergency

Press the Emergency Trip button.

- The feeder stops
- All unit cylinders disengage

Prevent the press from running at slow or higher speed

1. Press the Tune Up button.
 - The button remains selected
 - The button flashes
 - The press cannot be operated at slow or higher speed



The press can be operated at slower speed, however, if any of the foot boards between the units are open, the press cannot be operated at any speed above inching or reverse inching.

2. Press the Stop button to turn off the Safety indicator.

Inch the press

1. Press and release the Inch button.
 - Forward rotation alarm sounds
 - Safety indicator flashes
2. Press the Inch button again.
 - Alarm stops
 - Safety indicator continues to flash
3. Hold down the Inch button.
 - Press runs in the forward direction 25 mm at slower speed
4. Hold down and then release the Inch button.
 - The press stops

Run the press at a slower speed

1. Press and hold down the Slower button.
 - Forward rotation alarm sounds
 - Safety indicator flashes
2. If you release the button and then press it again after the alarm stops, but while the Safety indicator is still flashing, the press runs at a slower speed (300 rph).



The Slower button is used to turn off the tail edge guide device when the overrun detector has been activated.

Change press speed from slower to slow speed

1. Press the Slow/Fast button when the press is running at slower speed.
 - An alarm sounds
2. Press the button again.
 - The press runs at slow speed

Change press speed from slow to fast

Press the Slow/Fast button.

Change press speed from fast speed to slow speed

Press the Slow/Fast button.

- When the press is stopped, holding down Slow/Fast button sounds an alarm
- When the Slow/Fast button is pressed again (after the alarm stops), the following occurs:
 1. Press operates at a slower speed
 2. An alarm sounds
 3. Press operates at slow speed

Receive notification that the press is running

The Safety indicator lights up to notify the operator that the press is running.

When the press starts running, the following occurs:

1. Safety indicator flashes
2. An alarm sounds
3. The alarm stops
4. The Safety indicator flashes for three seconds to indicate you can continue running the press.
Continue the operation while the indicator is flashing.



If the press is not operated during the three second period, the indicator will turn off.

Receive notification that the press cannot be run

The Safety indicator illuminates when the press cannot run, for example, when the Stop button is locked, the manual handle is inserted, or there is a malfunction of the main motor.

Open or close the front and rear upper doors

1. Press and hold the Doors Enable button.
2. While the button is pressed, press the relevant upper door button to either open or close the doors.
3. Release the button to stop opening or closing the upper doors.

Raise or lower the access panels

1. Press and hold the Doors Enable button.
2. While the button is pressed, press the access panel button to either raise or lower the panel.
3. Release the button to stop raising or lowering the panel.

Display the status of the safety devices

1. Go to the Touch Panel Monitor, located on the Feeder Unit Side Panel.
2. Press the Print Key function button.

Display the safety device status for the feeder and delivery

1. Go to the Touch Panel Monitor.
2. Press the Monitor Key function button.

Perform fine tuning on the installed sheet size

1. Go to the Touch Panel Monitor, located on the feeder unit side panel.
2. Press the Sheet Size Key function button.

Adjust the feeder or delivery air volume

1. Go to the Touch Panel Monitor, located on the feeder unit side panel.
2. Press the relevant Air Key function button.

Adjust the delivery raise and lower settings

1. Go to the Touch Panel Monitor, located on the delivery unit operating side panel.
2. Press the Setting Key function button.

Put the print bars in service position

1. Open the Rear Upper Doors.
2. Press the Service button, located on the print bar, and pull out the print bar to service position.

Stop the print bar circulation

1. Open the Rear Upper Doors.
2. Press the Circulation button located on the print bar.

Chapter 10

Troubleshooting

Resolving Error Messages

Ink is not circulating through the print bar

1. Tap the Recover button located on the Control Panel.
If the problem persists, proceed below.
2. Login to the LIA with a higher access level (service engineer).
3. On the LIA, navigate to Printing System > Print Bar Monitor dialog.
4. Verify which print bar failed.
5. Open the relevant Rear Upper Door.
6. Check the ink levels in the refill ink tank and print bar ink tank.
 - If the levels are too low change the refill and/or circulation filters
 - If the ink levels are acceptable, perform a priming sequenceIf the problem persists, proceed below.
7. On the Print Bar Monitor dialog, check the ink pressure sensor.
 - If the pressure is higher than 500, proceed to step 8
 - If the pressure is lower than 500, call Landa Support
8. Press the Service button on the print bar and pull out the print bar to service position.
9. Open the print bar panel and check the following:
 - All the print head tubes are correctly connected
 - There are no signs of visible damage
 - None of the print heads are dripping
10. Push back the print bar and press the Circulation button (located on the print bar).
11. Close all Rear Upper Doors.
12. Perform priming.
If the problem persists, call Landa Support.

Print bars are not in capping position

1. Open the relevant Rear Upper Door.
2. Verify that the print bars are touching the rubber seal on the capping bath.
If the print bars are not touching the rubber seal, proceed below.
3. Pull the capping bath half way out and then push the capping bath back again.
4. Close the Rear Upper Doors.
5. Tap the Recover button located on the Control Panel.
6. If the problem persists, call Landa Support.

Print bars are not moving correctly

1. Open the relevant Rear Upper Door.
2. Make sure the print bar's side panel is closed.
3. Make sure the print bar is locked by gently pulling and pushing on the print bar handle.
4. Tap the Recover button located on the Control Panel.
5. If the problem still persists, reset the Real Time Computer (RTC).

Air pressure is out of range

There are four air pressure sensors located on the printing system pneumatics panel:

- High pressure sensor
- Low pressure sensor
- Purge pressure sensor
- Vacuum pressure sensor

If an air pressure alert message is displayed on the LIA, do the following:

1. Open Rear Panel 4 (concealing the ink delivery system's pneumatics panel).
2. Check the pressure readings.
If an air pressure readings is illuminated red (and not green), adjust the sensor's regulator to the required level.
 - If the high pressure sensor is not within working range, proceed to step 3
 - If the vacuum sensor is not within working range, proceed to step 4.

3. Check the compressor supply.
 - If the compressor supply is not functioning correctly, check the hose connected between the compressor and the press. If there is no sign of visible damage, call Landa Support.
4. If the vacuum sensor is not within working range, do the following:
 - Check for leaks originating in the vacuum manifold
 - Check the vacuum filter, and empty any liquid that has accumulated in the filter's cap
5. If the vacuum sensor is still not working, call Landa Support

There is a problem on the feeder board

There are four feeder board sensors:

- Registration O
- Registration D
- Overshoot detector
- Ultrasonic double sheet detector

Symptoms:

- Icon on Touch Monitor is illuminated
- Feeder stops
- Cylinders are disengaged
- Paper jam

Solution:

1. On the feeder/delivery unit panel, press the Slower button or the Slow/Fast button.
2. Remove the detected sheet.
3. On the LIA, tap the Recover button.
4. Wait until the press returns to Standby mode.
5. Tap the Print button to send the job to be printed again.

A sensor needs cleaning

Indicates the register front side and rear side sensors are dirty.

- Use either compressed air or a brush to clean the sensor

Ink Delivery System Troubleshooting

Vacuum filter contains ink or liquid

1. Open rear panel 4 (concealing the ink delivery system's pneumatics panel).
2. Unscrew the vacuum filter cap and drain the liquid.
If the problem persists, proceed below.
3. Open rear door 1 and access the ink delivery system cabinet.
4. Check the transparent vacuum hose on each lung.
If the lung is full of liquid, call Landa Support.

Purge filter cap contains ink

1. Open the relevant Rear Upper Door.
2. Press the Service button, located on the print bar, and pull out the print bar to service position.
3. Remove the print bar cover (box shaped and located at the rear of the print bar).
4. Unscrew the purge filter cap.
5. Clean the purge filter cap with a cloth and print head cleaning fluid.
6. If the problem persists, call Landa Support.

Fill the capping bath with print head cleaning fluid

Call Landa Support if there is not enough print head cleaning fluid in the capping bath.

Ink is dripping from the print heads

1. Perform a priming sequence if ink is dripping from the print heads.
2. If the problem persists, call Landa Support.

Ink is dripping inside the ink delivery system

1. Open the relevant Rear Upper Door.
2. Press the Circulation button located on the print bar.
3. Call Landa Support.

Alerts

Ink cooling chiller emits a beep or does not reach the correct temperature

If the ink cooling chiller emits a beep, it indicates that the chiller is low on water.

- Fill the ink cooling chiller with distilled water
- If the ink cooling chiller emits a beep but the water level is okay

OR

if the ink cooling chiller does not reach the correct temperature, it could be that the problem originates from the site's main external chiller.

Print bar door cooling chiller emits a beep or does not reach the correct temperature

If the print bar door cooling chiller emits a beep, it indicates that the chiller is low on water.

- Fill the print bar door cooling chiller with distilled water
- If the print bar door cooling chiller emits a beep but the water level is okay

OR

if the print bar door cooling chiller does not reach the correct temperature, it could be that the problem originates from the site's main external chiller.

Observation Deck Alerts

This section describes the alerts that appear on the Observation Deck of the Landa Operator Cockpit.

- A red alert indicates an error
- A yellow alert indicates a warning



General error



General warning



Paper jam



A door is open



A Stop button has been pressed



An Emergency Stop button has been pressed

Reject Tray Alerts

The Observation Deck displays the status of the reject tray.



Reject tray is not in position



Reject tray is almost full



Reject tray is full

Landa NanoInk Farm Alerts

The Observation Deck displays the status of the Landa NanoInk Farm tanks.



The amount of ink in each tank is indicated by the height of its color bar. For example, in the image above, the yellow ink tank contains less ink than the magenta ink tank, which in turn contains less in than the cyan ink tank.

When there is less than 10-minutes worth of ink remaining in a tank, a countdown appears above the tank. For example, in the image above, there is only sufficient violet ink remaining in the tank for a further one minute and 30 seconds.



An ink farm tank has been removed from its bay



An ink farm tank is undergoing service (priming, washing)



The ink temperature is too high



There is a problem with an ink farm tank

Model Alerts

The Observation Deck displays a 3D model of the printing press. When an alert is triggered, the location of the alert is flagged on the 3D model.

A number inside the alert bubble or orientation icon denotes how many warnings or alerts have been triggered.

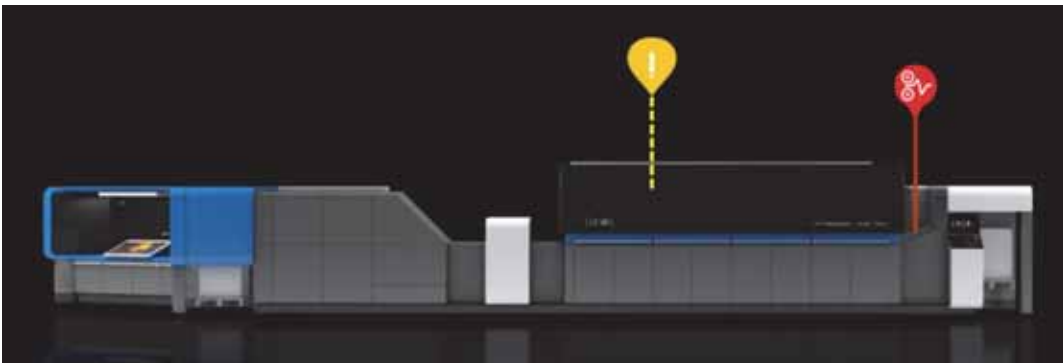
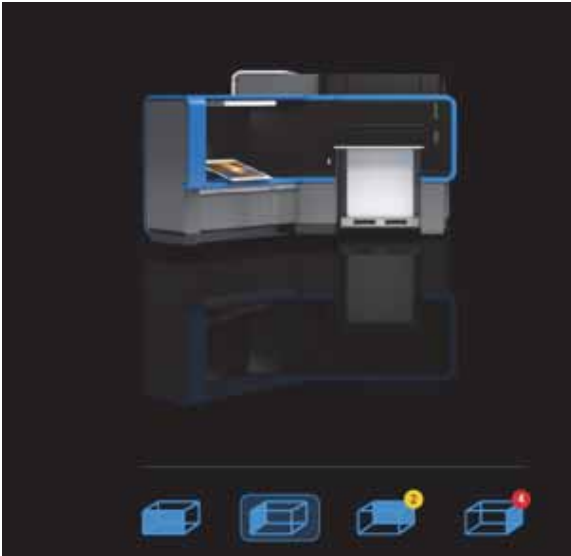

Coating Unit Alerts

Coating unit alerts are displayed on the coating unit image located on the Observation Deck.

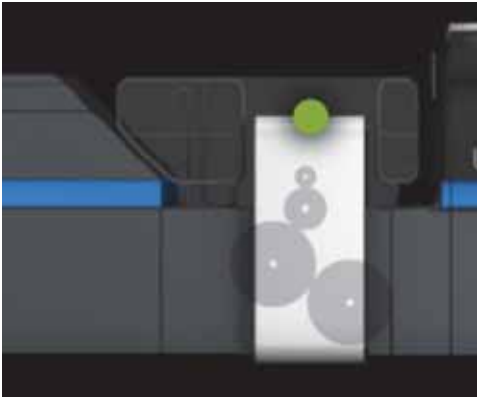

Ready



Not ready



Not ready

Drying Unit Alerts

Drying unit alerts are displayed on the drying unit image located on the Observation Deck.



Ready



Not ready



Not ready

Software Troubleshooting

Reset the Real Time computer

1. On the Landa Operator Cockpit, minimize the Landa Interface Application (LIA).
2. In Microsoft Windows, open the Remote Desktop Connection dialog.
3. In the Remote Desktop Connection dialog, enter the following IP address: 172.30.30.4
4. Click Connect.
5. Login to the Real Time computer.
6. Click the Code Sys application icon, located in the lower right corner of the monitor.
7. Right-mouse click and select Stop; after a few seconds, click Start.
8. Expand the LIA.
9. Tap the Recover button.

Sensor Troubleshooting

A sensor needs cleaning

Indicates the register front side and rear side sensors are dirty.

- Use either compressed air or a brush to clean the sensor

Registration front side sensor is activated

Symptoms:

- Icon is illuminated
- Feeder stops
- Cylinders are disengaged

Solution:

1. Remove the detected sheet.
2. On either the feeder unit panel or delivery unit panel, press the Slower button or the Slow/Fast button.

Registration rear side sensor is activated

Symptoms:

- Icon is illuminated
- Feeder stops
- Cylinders are disengaged

Solution:

1. Remove the detected sheet.
2. On either the feeder unit panel or delivery unit panel, press the Slower button or the Slow/Fast button.