

FCC TEST REPORT
For

Shenzhen Andobil Technology Co.,Ltd.

Wireless Charger

Test Model: CDRZ44

Additional Model No.:N/A

Prepared for : Shenzhen Andobil Technology Co.,Ltd.
Address : 322, Bldg.7, Pengsheng Village, No.39 Bagua 1 Rd.,Pengsheng
CMNY, Yuanling St Futian Dist.,shenzhen,Guangdong, China

Prepared by : Shenzhen LCS Compliance Testing Laboratory Ltd.
Address : 1/F., Xingyuan Industrial Park, Tongda Road, Bao'an Avenue,
Bao'an District, Shenzhen, Guangdong, China

Tel : (+86)755-82591330
Fax : (+86)755-82591332
Web : www.LCS-cert.com
Mail : webmaster@LCS-cert.com

Date of receipt of test sample : July 18, 2018
Number of tested samples : 1
Serial number : Prototype
Date of Test : August 06, 2018 ~ August 24, 2018
Date of Report : August 28, 2018

**FCC TEST REPORT
FCC CFR 47 PART 18: 2017**

Report Reference No. : **LCS18071810IAEA**

Date Of Issue : August 28, 2018

Testing Laboratory Name..... : **Shenzhen LCS Compliance Testing Laboratory Ltd.**

Address : 1/F., Xingyuan Industrial Park, Tongda Road, Bao'an Avenue,
Bao'an District, Shenzhen, Guangdong, China

Testing Location/ Procedure..... : Full application of Harmonised standards ■
Partial application of Harmonised standards □
Other standard testing method □

Applicant's Name : **Shenzhen Andobil Technology Co.,Ltd.**

Address : 322, Bldg.7, Pengsheng Village, No.39 Bagua 1 Rd.,Pengsheng
CMNY, Yuanling St Futian Dist.,shenzhen,Guangdong, China

Test Specification

Standard..... : FCC CFR 47 PART 18: 2017

Test Report Form No. : LCSEMC-1.0

TRF Originator : Shenzhen LCS Compliance Testing Laboratory Ltd.

Master TRF : Dated 2011-03

Shenzhen LCS Compliance Testing Laboratory Ltd. All rights reserved.

This publication may be reproduced in whole or in part for non-commercial purposes as long as the Shenzhen LCS Compliance Testing Laboratory Ltd. is acknowledged as copyright owner and source of the material. Shenzhen LCS Compliance Testing Laboratory Ltd. takes no responsibility for and will not assume liability for damages resulting from the reader's interpretation of the reproduced material due to its placement and context.

Test Item Description. : Wireless Charger

Trade Mark..... : Andobil

Test Model..... : CDRZ44

Power Supply : Input: DC 5V/500mA
Output: Wireless charge: DC 5V/2A(MAX)

Result : **Positive**

Compiled by:

Peter Xiao

Supervised by:

Calvin Weng

Approved by:

Gavin Liang

Peter Xiao / File administrators

Calvin Weng / Technique principal

Gavin Liang/ Manager

FCC -- TEST REPORT

Test Report No. : LCS180718101AEA	<u>August 28, 2018</u> Date of issue
---	---

Test Model..... : CDRZ44
EUT..... : Wireless Charger
Applicant..... : Shenzhen Andobil Technology Co.,Ltd. Address..... : 322, Bldg.7, Pengsheng Village, No.39 Bagua 1 Rd.,Pengsheng : CMNY, Yuanling St Futian Dist.,shenzhen,Guangdong, China Telephone..... : / Fax..... : /
Manufacturer..... : Shenzhen Andobil Technology Co.,Ltd. Address..... : 322, Bldg.7, Pengsheng Village, No.39 Bagua 1 Rd.,Pengsheng : CMNY, Yuanling St Futian Dist.,shenzhen,Guangdong, China Telephone..... : / Fax..... : /
Factory..... : Shenzhen Andobil Technology Co.,Ltd. Address..... : 322, Bldg.7, Pengsheng Village, No.39 Bagua 1 Rd.,Pengsheng : CMNY, Yuanling St Futian Dist.,shenzhen,Guangdong, China Telephone..... : / Fax..... : /

Test Result	Positive
--------------------	-----------------

The test report merely corresponds to the test sample.
 It is not permitted to copy extracts of these test result without the written permission of the test laboratory.

Revision History

Revision	Issue Date	Revisions	Revised By
000	August 28, 2018	Initial Issue	Gavin Liang

TABLE OF CONTENTS

1. GENERAL INFORMATION	6
1.1 Description of Device (EUT)	6
1.2 Support equipment List.....	6
1.3 External I/O Cable	6
1.4 Description of Test Facility	6
1.5 Statement of the Measurement Uncertainty.....	7
1.6 Measurement Uncertainty	7
1.7 Description of Test Modes.....	7
2. TEST METHODOLOGY	9
2.1 EUT Configuration	9
2.2 EUT Exercise.....	9
2.3 General Test Procedures	9
2.3.1 Conducted Emissions	9
2.3.2 Radiated Emissions	9
3. SYSTEM TEST CONFIGURATION	10
3.1 Justification	10
3.2 EUT Exercise Software.....	10
3.3 Special Accessories	10
3.4 Block Diagram/Schematics	10
3.5 Equipment Modifications	10
3.6 Test Setup.....	10
4. SUMMARY OF TEST EQUIPMENT	11
5. SUMMARY OF TEST RESULT	12
3. POWER LINE CONDUCTED MEASUREMENT	13
4. RADIATED EMISSION MEASUREMENT	15
4.1. Block Diagram of Test Setup.....	15
4.2. Radiated Emission Limit	16
4.3. EUT Configuration on Measurement.....	16
4.4. Operating Condition of EUT	16
4.5. Measuring Setting.....	16
4.6. Test Procedure	17
4.7. Test Results.....	18
5. PHOTOGRAPHS OF TEST SETUP	21
6. EXTERNAL PHOTOGRAPHS OF THE EUT	21
7. INTERNAL PHOTOGRAPHS OF THE EUT	21

1. GENERAL INFORMATION

1.1 Description of Device (EUT)

EUT : Wireless Charger
 Model Number(s) : CDRZ44
 Test Model : CDRZ44
 Hardware Version : 1.0
 Software Version : 1.0
 Operating Frequency : 110 KHz - 205 KHz
 Modulation Type : FSK
 Antenna Type : Coil Antenna
 Input/Output : Input: DC 5V/500mA
 Output: Wireless charge: DC 5V/2A(MAX)

1.2 Support equipment List

Manufacturer	Description	Model	Serial Number	Certificate
Samsung	Mobile Phone	S6	--	FCC ID
Dong Guan Bestgk Smart Technology Co.,Ltd	Adapter	K-T10E0503000E	---	FCC VOC

Note: Auxiliary equipment is provided by the laboratory.

1.3 External I/O Cable

I/O Port Description	Quantity	Cable
DC IN Port	1	0.8m unshielded

1.4 Description of Test Facility

FCC Registration Number. is 254912.

Industry Canada Registration Number. is 9642A-1.

ESMD Registration Number. is ARCB0108.

UL Registration Number. is 100571-492.

TUV SUD Registration Number. is SCN1081.

TUV RH Registration Number. is UA 50296516-001

NVLAP Registration Code is 600167-0

The 3m-Semi anechoic test site fulfils CISPR 16-1-4 according to ANSI C63.4:2014 and CISPR 16-1-4:2010 SVSWR requirement for radiated emission above 1GHz.

1.5 Statement of the Measurement Uncertainty

The data and results referenced in this document are true and accurate. The reader is cautioned that there may be errors within the calibration limits of the equipment and facilities. The measurement uncertainty was calculated for all measurements listed in this test report acc. To CISPR 16 – 4 “Specification for radio disturbance and immunity measuring apparatus and methods – Part 4: Uncertainty in EMC Measurements” and is documented in the LCS quality system acc. To DIN EN ISO/IEC 17025. Furthermore, component and process variability of devices similar to that tested may result in additional deviation. The manufacturer has the sole responsibility of continued compliance of the device.

1.6 Measurement Uncertainty

Test Item	Frequency Range	Uncertainty	Note
Radiation Uncertainty	9KHz~30MHz	3.10dB	(1)
	30MHz~200MHz	2.96dB	(1)
	200MHz~1000MHz	3.10dB	(1)
	1GHz~26.5GHz	3.80dB	(1)
	26.5GHz~40GHz	3.90dB	(1)
Conduction Uncertainty	150kHz~30MHz	1.63dB	(1)
Power disturbance	30MHz~300MHz	1.60dB	(1)

(1). This uncertainty represents an expanded uncertainty expressed at approximately the 95% confidence level using a coverage factor of k=2.

1.7 Description of Test Modes

Equipment under test was operated during the measurement under the following conditions:

Charging and communication mode

Modulation Type: FSK

Test Modes		
Mode 1	AC/DC Adapter (5V/2A) + EUT + Mobile Phone (Stand mode) (Battery Status: <1%)	Record
Mode 2	AC/DC Adapter + (5V/2A) + Mobile Phone (Stand mode) (Battery Status: <50%)	Pre-tested
Mode 3	AC/DC Adapter + (5V/2A) + Mobile Phone (Stand mode) (Battery Status: 100%)	Pre-tested
Mode 4	AC/DC Adapter (5V/2A) + EUT + Mobile Phone (Pad mode) (Battery Status: <1%)	Pre-tested
Mode 5	AC/DC Adapter + (5V/2A) + Mobile Phone (Pad mode) (Battery Status: <50%)	Pre-tested
Mode 6	AC/DC Adapter + (5V/2A) + Mobile Phone (Pad mode) (Battery Status: 100%)	Pre-tested
Note: All test modes were pre-tested, but we only recorded the worst case in this report.		

For AC conducted emission, pre-test at both AC 120V/60Hz and AC 240V/50Hz, recorded worst case;
For AC conducted emission, pre-test at both AC charge from power adapter and PC modes, recorded worst case.

Picture of Two Models

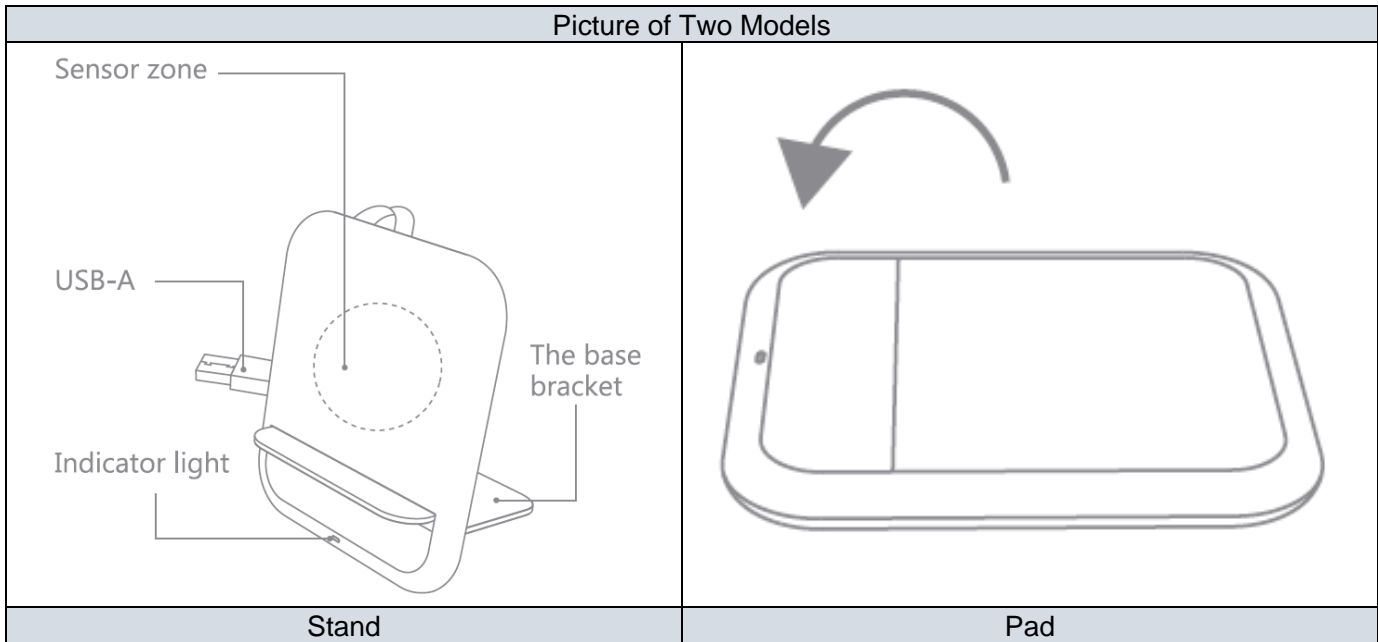

2. TEST METHODOLOGY

The tests documented in this report were performed in accordance with MP-5, and FCC CFR PART 18.

2.1 EUT Configuration

The EUT configuration for testing is installed on RF field strength measurement to meet the Commissions requirement and operating in a manner that intends to maximize its emission characteristics in a continuous normal application.

2.2 EUT Exercise

The EUT was operated in the charging and compunction mode to fix the TX frequency that was for the purpose of the measurements.

According to its specifications, the EUT must comply with the requirements of the Section 18.305 and 18.307 under the FCC Rules Part 18.

2.3 General Test Procedures

2.3.1 Conducted Emissions

The EUT is placed on the turntable, which is 0.8 m above ground plane. According to the requirements in FCC MP-5 for Conducted emissions from the EUT measured in the frequency range between 0.15 MHz and 30MHz using Quasi-peak and average detector modes.

2.3.2 Radiated Emissions

The EUT is placed on a turn table, which is 0.8 m above ground plane. The turntable shall rotate 360 degrees to determine the position of maximum emission level. EUT is set 3m away from the receiving antenna, which varied from 1m to 4m to find out the highest emission. And also, each emission was to be maximized by changing the polarization of receiving antenna both horizontal and vertical. In order to find out the maximum emissions, exploratory radiated emission measurements were made according to the requirements in FCC MP-5 for radiated emission.

3. SYSTEM TEST CONFIGURATION

3.1 Justification

The system was configured for testing in a normal condition.

3.2 EUT Exercise Software

N/A.

3.3 Special Accessories

N/A.

3.4 Block Diagram/Schematics

Please refer to the related document.

3.5 Equipment Modifications

Shenzhen LCS Compliance Testing Laboratory Ltd. has not done any modification on the EUT.

3.6 Test Setup

Please refer to the test setup photo.

4. SUMMARY OF TEST EQUIPMENT

Item	Equipment	Manufacturer	Model No.	Serial No.	Last Cal.	Next Cal.
1	Power Meter	R&S	NRVS	100444	2018-06-16	2019-06-15
2	Power Sensor	R&S	NRV-Z81	100458	2018-06-16	2019-06-15
3	Power Sensor	R&S	NRV-Z32	10057	2018-06-16	2019-06-15
4	ESA-E SERIES SPECTRUM ANALYZER	Agilent	E4407B	MY41440754	2017-11-17	2018-11-16
5	MXA Signal Analyzer	Agilent	N9020A	MY49100040	2018-06-16	2019-06-15
6	SPECTRUM ANALYZER	R&S	FSP	100503	2018-06-16	2019-06-15
7	3m Semi Anechoic Chamber	SIDT FRANKONIA	SAC-3M	03CH03-HY	2018-06-16	2019-06-15
8	Positioning Controller	MF	MF-7082	/	2018-06-16	2019-06-15
9	EMI Test Software	AUDIX	E3	N/A	N/A	N/A
10	EMI Test Receiver	R&S	ESR 7	101181	2018-06-16	2019-06-15
11	AMPLIFIER	QuieTek	QTK-A2525G	CHM10809065	2017-11-17	2018-11-16
12	Active Loop Antenna	SCHWARZBECK	FMZB 1519B	00005	2018-06-22	2019-06-21
13	By-log Antenna	SCHWARZBECK	VULB9163	9163-470	2018-05-01	2019-04-30
14	Horn Antenna	SCHWARZBECK	BBHA 9120 D	9120D-1925	2018-07-02	2019-07-01
15	Broadband Horn Antenna	SCHWARZBECK	BBHA 9170	791	2017-09-21	2018-09-20
16	Broadband Preamplifier	SCHWARZBECK	BBV 9719	9719-025	2017-09-21	2018-09-20
17	RF Cable-R03m	Jye Bao	RG142	CB021	2018-06-16	2019-06-15
18	RF Cable-HIGH	SUHNER	SUCOFLEX 106	03CH03-HY	2018-06-16	2019-06-15
19	TEST RECEIVER	R&S	ESCI	101142	2018-06-16	2019-06-15
20	RF Cable-CON	UTIFLEX	3102-26886-4	CB049	2018-06-16	2019-06-15
21	10dB Attenuator	SCHWARZBECK	MTS-IMP136	261115-001-0032	2018-06-16	2019-06-15
22	Artificial Mains	R&S	ENV216	101288	2018-06-16	2019-06-15
23	RF Control Unit	JS Tonscend Corporation	JS0806-2	178060073	2017-10-28	2018-10-27
24	JS1120-3 BT/WIFI Test Software	JS Tonscend Corporation	JS1120-3	/	N/A	N/A

Note: All equipment is calibrated through GUANGZHOU LISAI CALIBRATION AND TEST CO.,LTD.

5. SUMMARY OF TEST RESULT

Test Item	FCC Rule No.	Temperature conditions	Power source conditions	C	NC	NA	NP	Remark
Radiated Emission	§18.305 (b)	Nominal	Nominal	<input checked="" type="checkbox"/>	<input type="checkbox"/>	<input type="checkbox"/>	<input type="checkbox"/>	-/-
AC conducted emission	§18.307 (a)	Nominal	Nominal	<input checked="" type="checkbox"/>	<input type="checkbox"/>	<input type="checkbox"/>	<input type="checkbox"/>	-/-

Remark: The measurement uncertainty is not included in the test result.

3. POWER LINE CONDUCTED MEASUREMENT

3.1. Block Diagram of Test Setup

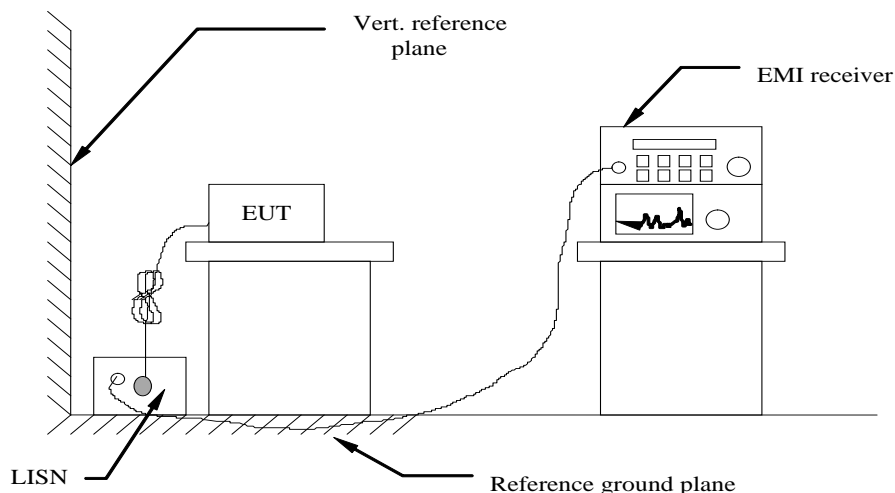

3.2. Standard Applicable

According to §18.307 (b): For all other part 18 consumer devices which is designed to be connected to the public utility (AC) power line, the radio frequency voltage that is conducted back onto the AC power line on any frequency or frequencies within the band 150 kHz to 30 MHz shall not exceed 250 microvolts (The limit decreases linearly with the logarithm of the frequency in the range 0.15 MHz to 0.50 MHz). The limits at specific frequency range are listed as follows:

Frequency Range (MHz)	Limits (dBµV)	
	Quasi-peak	Average
0.15 to 0.50	66 to 56	56 to 46
0.50 to 5	56	46
5 to 30	60	50

* Decreasing linearly with the logarithm of the frequency

3.3 Test Results

PASS.

The test data please refer to following page.

AC Power Line Conducted Emission (Power input to adapter @ AC 120V/60Hz (Worst Case))

Line

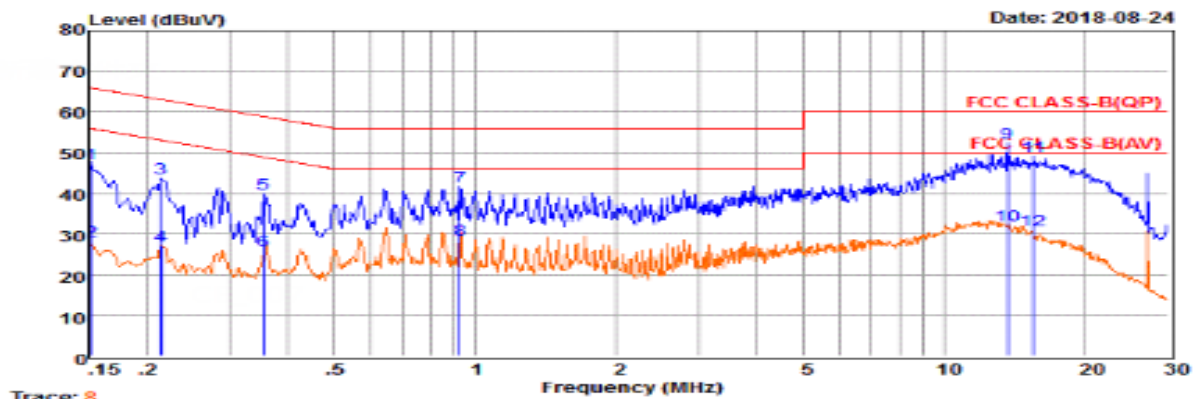

Trace: 8
Pol: LINE

	Freq	Reading	LISNFac	CabLos	Aux2Fac	Measured	Limit	Over	Remark
	MHz	dBuV	dB	dB	dB	dBuV	dBuV	dB	
1	0.15	27.70	9.57	0.02	10.00	47.29	65.91	-18.62	QP
2	0.15	8.73	9.57	0.02	10.00	28.32	55.91	-27.59	Average
3	0.21	24.11	9.63	0.03	10.00	43.77	63.05	-19.28	QP
4	0.21	7.54	9.63	0.03	10.00	27.20	53.05	-25.85	Average
5	0.35	20.14	9.62	0.03	10.00	39.79	58.87	-19.08	QP
6	0.35	6.11	9.62	0.03	10.00	25.76	48.87	-23.11	Average
7	0.93	21.90	9.63	0.05	10.00	41.58	56.00	-14.42	QP
8	0.93	8.75	9.63	0.05	10.00	28.43	46.00	-17.57	Average
9	13.62	32.62	9.71	0.10	10.00	52.43	60.00	-7.57	QP
10	13.62	12.25	9.71	0.10	10.00	32.06	50.00	-17.94	Average
11	15.47	29.32	9.71	0.10	10.00	49.13	60.00	-10.87	QP
12	15.47	11.07	9.71	0.10	10.00	30.88	50.00	-19.12	Average

Remarks: 1. Measured = Reading + LISNFac + Cable Loss + Aux2 Fac.
2. The emission levels that are 20dB below the official limit are not reported.

Neutral

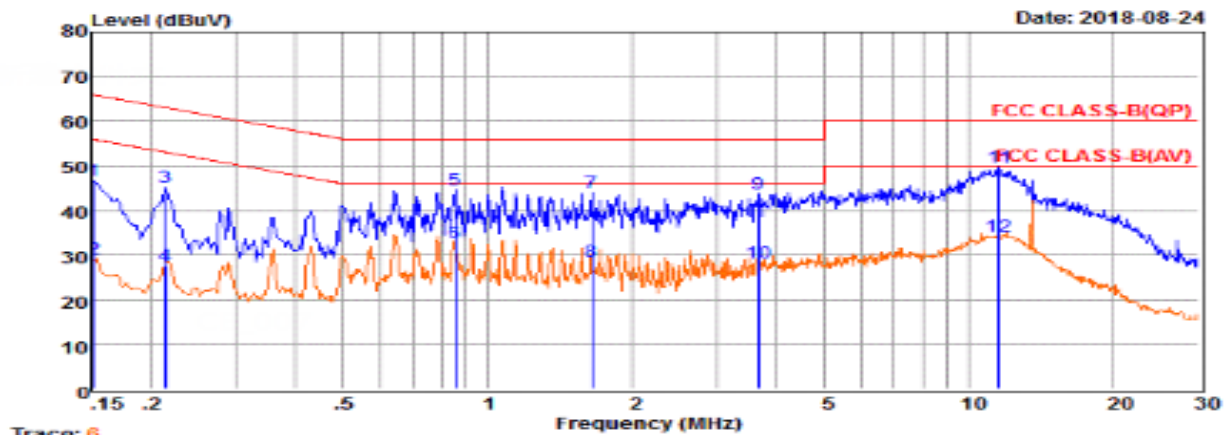

Trace: 6
Pol: NEUTRAL

	Freq	Reading	LISNFac	CabLos	Aux2Fac	Measured	Limit	Over	Remark
	MHz	dBuV	dB	dB	dB	dBuV	dBuV	dB	
1	0.15	26.83	9.70	0.02	10.00	46.55	65.91	-19.36	QP
2	0.15	9.30	9.70	0.02	10.00	29.02	55.91	-26.89	Average
3	0.21	25.44	9.59	0.03	10.00	45.06	63.05	-17.99	QP
4	0.21	7.95	9.59	0.03	10.00	27.57	53.05	-25.48	Average
5	0.86	24.88	9.63	0.04	10.00	44.55	56.00	-11.45	QP
6	0.86	13.06	9.63	0.04	10.00	32.73	46.00	-13.27	Average
7	1.64	24.27	9.63	0.05	10.00	43.95	56.00	-12.05	QP
8	1.65	8.80	9.63	0.05	10.00	28.48	46.00	-17.52	Average
9	3.64	23.86	9.65	0.06	10.00	43.57	56.00	-12.43	QP
10	3.64	8.59	9.65	0.06	10.00	28.30	46.00	-17.70	Average
11	11.56	29.88	9.73	0.09	10.00	49.70	60.00	-10.30	QP
12	11.56	14.42	9.73	0.09	10.00	34.24	50.00	-15.76	Average

Remarks: 1. Measured = Reading + LISNFac + Cable Loss + Aux2 Fac.
2. The emission levels that are 20dB below the official limit are not reported.

***Note: Pre-scan all modes and recorded the worst case results in this report.

4. RADIATED EMISSION MEASUREMENT

4.1. Block Diagram of Test Setup

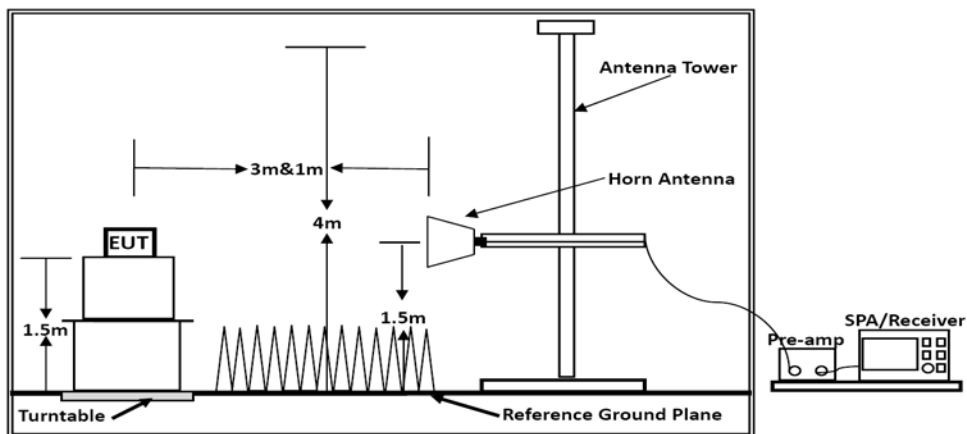
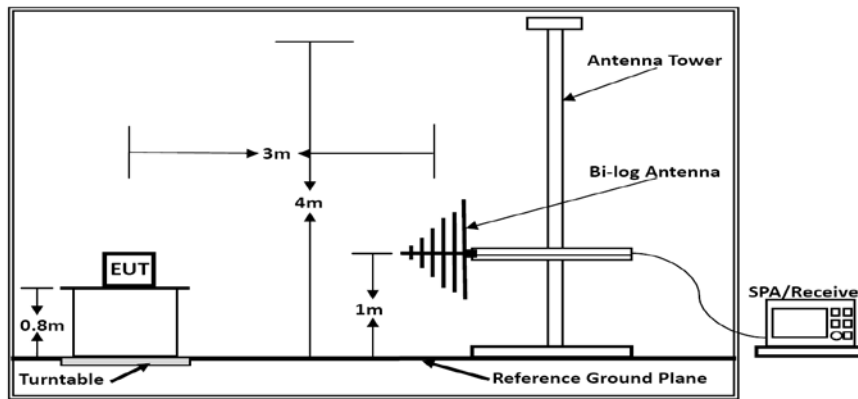
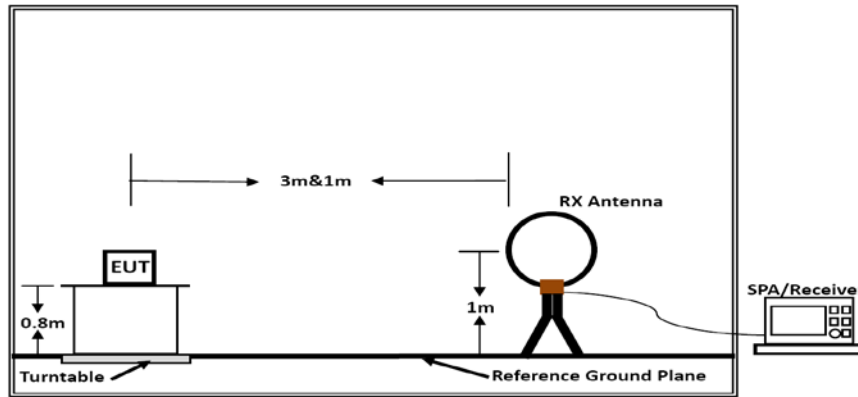

4.2. Radiated Emission Limit

Except as provided elsewhere in this Subpart 18.305 (b), the field strength levels of emissions which lie outside the bands specified in §18.301, unless otherwise indicated, shall not exceed the following table:

Frequency MHz	Distance Meters	Field Strengths Limit	
		$\text{dB}\mu\text{V/m}$	Remark
0.009~30MHz	3	103.5	Quasi-peak
30~88	3	40.0	Quasi-peak
88~216	3	43.5	Quasi-peak
216~960	3	46.0	Quasi-peak
960~1000	3	54.0	Quasi-peak

Remark:

- (1) Emission level $\text{dB}\mu\text{V/m}$ for 0.009~30MHz = $20\log(15) + 40\log(300/3)$ $\text{dB}\mu\text{V/m}$;
- (2) Calculated according FCC 18.305.
- (3) The smaller limit shall apply at the cross point between two frequency bands.
- (4) Distance is the distance in meters between the measuring instrument, antenna and the closest point of any part of the device or system.

4.3. EUT Configuration on Measurement

The following equipment are installed on Radiated Emission Measurement to meet the commission requirements and operating regulations in a manner which tends to maximize its emission characteristics in normal application.

4.4. Operating Condition of EUT

- (1) Setup the EUT as shown in Section 4.1.
- (2) Let the EUT work in worst test mode (Mode 1) and measure it.

4.5. Measuring Setting

The following table is the setting of spectrum analyzer and receiver.

Receiver Parameter	Setting
Attenuation	Auto
Start ~ Stop Frequency	9kHz~150kHz / RB 200Hz for QP/Average
Start ~ Stop Frequency	150kHz~30MHz / RB 9kHz for QP/Average
Start ~ Stop Frequency	30MHz~1000MHz / RB 100kHz for QP

4.6. Test Procedure

1) Sequence of testing 9 kHz to 30 MHz

Setup:

- The equipment was set up to simulate a typical usage like described in the user manual or described by manufacturer.
- If the EUT is a tabletop system, a rotatable table with 0.8 m height is used.
- If the EUT is a floor standing device, it is placed on the ground.
- Auxiliary equipment and cables were positioned to simulate normal operation conditions.
- The AC power port of the EUT (if available) is connected to a power outlet below the turntable.
- The measurement distance is 3 meter.
- The EUT was set into operation.

Premeasurement:

- The turntable rotates from 0° to 315° using 45° steps.
- The antenna height is 0.8 meter.
- At each turntable position the analyzer sweeps with peak detection to find the maximum of all emissions

Final measurement:

- Identified emissions during the premeasurement the software maximizes by rotating the turntable position (0° to 360°) and by rotating the elevation axes (0° to 360°).
- The final measurement will be done in the position (turntable and elevation) causing the highest emissions with QPK detector.
- The final levels, frequency, measuring time, bandwidth, turntable position, correction factor, margin to the limit and limit will be recorded. Also a plot with the graph of the premeasurement and the limit will be stored.

2) Sequence of testing 30 MHz to 1 GHz

Setup:

- The equipment was set up to simulate a typical usage like described in the user manual or described by manufacturer.
- If the EUT is a tabletop system, a table with 0.8 m height is used, which is placed on the ground plane.
- If the EUT is a floor standing device, it is placed on the ground plane with insulation between both.
- Auxiliary equipment and cables were positioned to simulate normal operation conditions
- The AC power port of the EUT (if available) is connected to a power outlet below the turntable.
- The measurement distance is 3 meter.
- The EUT was set into operation.

Premeasurement:

- The turntable rotates from 0° to 315° using 45° steps.
- The antenna is polarized vertical and horizontal.
- The antenna height changes from 1 to 3 meter.
- At each turntable position, antenna polarization and height the analyzer sweeps three times in peak to find the maximum of all emissions.

Final measurement:

- The final measurement will be performed with minimum the six highest peaks.
- According to the maximum antenna and turntable positions of premeasurement the software maximize the peaks by changing turntable position ($\pm 45^\circ$) and antenna movement between 1 and 4 meter.
- The final measurement will be done with QP detector with an EMI receiver.
- The final levels, frequency, measuring time, bandwidth, antenna height, antenna polarization, turntable angle, correction factor, margin to the limit and limit will be recorded. Also a plot with the graph of the premeasurement with marked maximum final measurements and the limit will be stored.

4.7. Test Results

PASS.

Only report the worst test data (Mode 1) in test report;

The test data please refer to following page:

0.009~30MHz

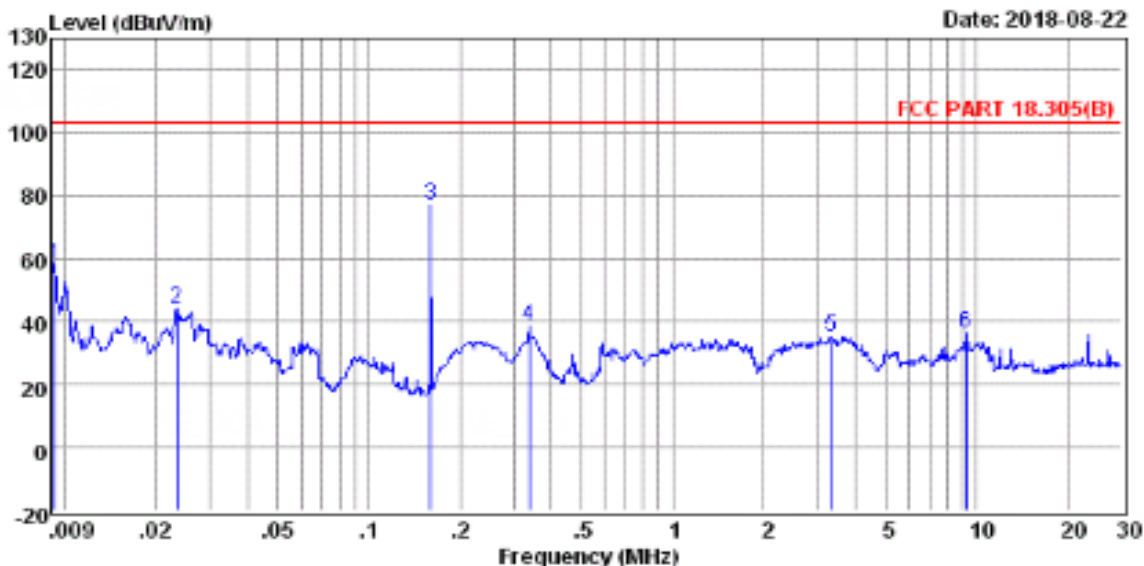

	Freq	Reading	CabLos	Antfac	Measured	Limit	Over	Remark
	MHz	dBuV	dB	dB/m	dBuV/m	dBuV/m	dB	
1	0.01	37.24	0.30	20.66	58.20	103.50	-45.30	QP
2	0.02	23.17	0.30	20.62	44.09	103.50	-59.41	QP
3	0.16	56.11	0.30	20.44	76.85	103.50	-26.65	QP
4	0.34	18.00	0.30	20.37	38.67	103.50	-64.83	QP
5	3.33	14.68	0.30	20.29	35.27	103.50	-68.23	QP
6	9.25	15.95	0.30	20.32	36.57	103.50	-66.93	QP

- Note: 1. All readings are Quasi-peak values.
 2. Measured= Reading + Antenna Factor + Cable Loss
 3. The emission that are 20db below the official limit are not reported

Remark: Measured antenna at both 0 degree and 90 degree, recorded worst case at 0 degree.

30MHz~1000MHz

Horizontal



pol:

HORIZONTAL

	Freq	Reading	CabLos	Antfac	Measured	Limit	Over	Remark
	MHz	dBuV	dB	dB/m	dBuV/m	dBuV/m	dB	
1	54.26	14.37	0.46	13.05	27.88	40.00	-12.12	QP
2	108.27	8.17	0.68	12.41	21.26	43.50	-22.24	QP
3	191.07	12.45	0.86	10.56	23.87	43.50	-19.63	QP
4	323.32	10.70	1.10	13.46	25.26	46.00	-20.74	QP
5	612.06	1.96	1.59	18.49	22.04	46.00	-23.96	QP
6	955.44	7.14	1.89	21.45	30.48	46.00	-15.52	QP

Note: 1. All readings are Quasi-peak values.
 2. Measured= Reading + Antenna Factor + Cable Loss
 3. The emission that are 20db below the official limit are not reported

Vertical

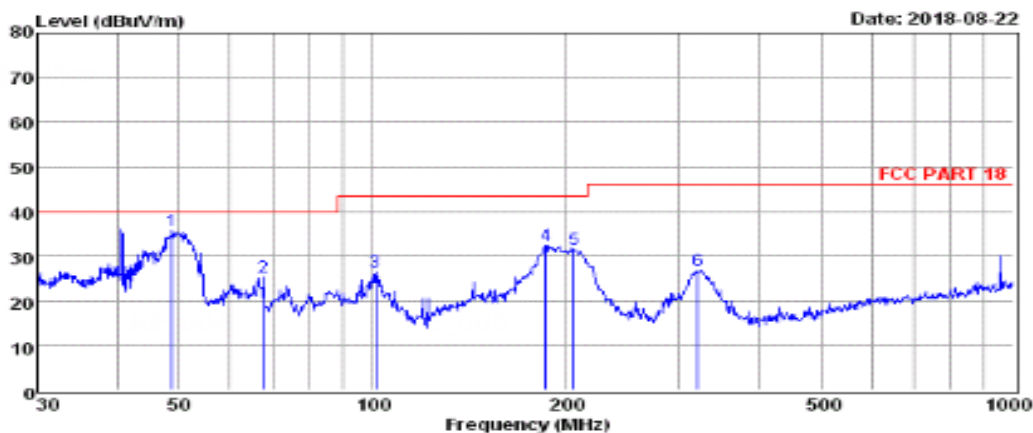

pol:

VERTICAL

	Freq	Reading	CabLos	Antfac	Measured	Limit	Over	Remark
	MHz	dBuV	dB	dB/m	dBuV/m	dBuV/m	dB	
1	48.67	21.89	0.35	13.33	35.57	40.00	-4.43	QP
2	67.68	15.18	0.51	9.61	25.30	40.00	-14.70	QP
3	101.29	12.72	0.60	13.04	26.36	43.50	-17.14	QP
4	186.44	21.21	0.98	10.25	32.44	43.50	-11.06	QP
5	206.40	19.74	0.99	10.77	31.50	43.50	-12.00	QP
6	322.19	12.06	1.16	13.42	26.64	46.00	-19.36	QP

Note: 1. All readings are Quasi-peak values.
 2. Measured= Reading + Antenna Factor + Cable Loss
 3. The emission that are 20db below the official limit are not reported

Note:

- 1). Pre-scan all modes and recorded the worst case results in this report.
- 2). Emission level (dBuV/m) = 20 log Emission level (uV/m).
- 3). Corrected Reading: Antenna Factor + Cable Loss + Read Level = Level.

5. PHOTOGRAPHS OF TEST SETUP

Please refer to separated files for Test Setup Photos of the EUT.

6. EXTERNAL PHOTOGRAPHS OF THE EUT

Please refer to separated files for External Photos of the EUT.

7. INTERNAL PHOTOGRAPHS OF THE EUT

Please refer to separated files for Internal Photos of the EUT.

-----THE END OF REPORT-----