

# FCC Test Report

**Equipment** : Bluetooth module  
**Model No** : BCM-DA100-AS  
**Applicant** : BNCOM CO.LTD  
1106, M-Techno Center, 46, Gongdan-ro 140 Beon-gil,  
Gunpo-si, Gyeonggi-do, 15847, Korea  
**Date of test** : January 29, 2020 to February 19, 2020  
**FCC Rule Part(s)** : FCC Part 15 Subpart C §15.247  
**Report Type** : Original Report

*The product was received on January 29, 2020 and testing was completed on February 19, 2020. We, BWS TECH Inc. would like to declare that the tested sample has been evaluated in accordance with the test procedures and has been in compliance with the applicable technical standards.*

*The test results in this report apply exclusively to the tested model / sample. Without written approval of BWS TECH Inc. the test report shall not be reproduced except in full.*

(Date) 02/19/2020

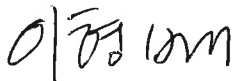

Tested by **Hyeong-Bae Lee**

(Date) 02/19/2020



Reviewed by **Yong-Ki Cho**

## BWS TECH INC.

#23, Gokhyeon-ro 480beon-gil, Mohyeon-eup, Cheoin-gu, Yongin-si,  
Gyeonggi-do 17031, Republic of Korea

TEL: +82-31-333-5997, FAX: +82-31-333-0017

<http://www.bws.co.kr>

\*This test report is not related to KS Q ISO/IEC 17025 and KOLAS accreditation.

\*The authenticity of this test report can be confirmed in the Android app "DOCUQR" or [www.docuqr.com](http://www.docuqr.com)

# Report Revision

TEST REPORT NO.	DATE	DESCRIPTION
BWS-20-RF-0002	February 19, 2020	- First Approval Report

## TABLE OF CONTENTS

<b>1.</b>	<b>General Information .....</b>	<b>4</b>
1.1	Applicant .....	4
1.2	Manufacturer .....	4
1.3	EUT Description .....	4
1.4	Other Information .....	4
<b>2.</b>	<b>Description of Test Facility .....</b>	<b>5</b>
<b>3.</b>	<b>Test Methodology .....</b>	<b>6</b>
3.1	EUT Configuration .....	6
3.2	EUT Exercise .....	6
3.3	FCC Part 15.205 Restricted Bands of Operations .....	6
3.4	Description of Test Modes .....	7
<b>4.</b>	<b>Summary of Test Result .....</b>	<b>8</b>
<b>5.</b>	<b>Test Equipment .....</b>	<b>9</b>
<b>6.</b>	<b>Test Data .....</b>	<b>10</b>
6.1	AC Power Line Conducted Emission .....	10
6.2	Number of Channel Measurement.....	13
6.3	Hopping Channel Separation Measurement .....	16
6.4	Dwell Time Measurement.....	21
6.5	20dB Bandwidth.....	24
6.6	Peak Output Power Measurement.....	29
6.7	Conducted Spurious Emission.....	37
6.8	Band Edges Measurement .....	42
6.9	Radiated Spurious Emission .....	48
6.10	Antenna Application .....	57
<b>Annex A.</b>	<b>Test setup photos.....</b>	<b>58</b>

# 1. General Information

**Scope** – Measurement and determination of electromagnetic emission(EME) of radio frequency devices including intentional radiators and/or unintentional radiators for compliance with the technical rules and regulations of the U.S Federal Communications Commission(FCC)

## 1.1 Applicant

● <b>Company Name</b>	: BNCOM CO.LTD
● <b>Company Address</b>	: 1106, M-Techno Center, 46, Gongdan-ro 140 Beon-gil, Gunpo-si, Gyeonggi-do, 15847, Korea
● <b>Phone/Fax</b>	: Tel No. : +82-31-427-6034 Fax No. : +82-31-427-8907

## 1.2 Manufacturer

● <b>Company Name</b>	: BNCOM CO.LTD
● <b>Company Address</b>	: 1106, M-Techno Center, 46, Gongdan-ro 140 Beon-gil, Gunpo-si, Gyeonggi-do, 15847, Korea
● <b>Phone/Fax</b>	: Tel No. : +82-31-427-6034 Fax No. : +82-31-427-8907

## 1.3 EUT Description

● <b>Equipment</b>	: Bluetooth module
● <b>Model(s)</b>	: BCM-DA100-AS
● <b>Operation Frequency</b>	: 2402 MHz ~ 2480 MHz (Bluetooth)
● <b>Number of Channels</b>	: 79
● <b>Modulation Method</b>	: BDR(GFSK), EDR( $\pi/4$ -DQPSK), EDR(8DPSK)
● <b>Power Tolerance</b>	: +/- 2dB
● <b>Input Voltage</b>	: DC 3 V
● <b>Antenna Peak Gain</b>	: -0.63 dBi

## 1.4 Other Information

● <b>FCC Rule Part(s)</b>	: Part 15 Subpart C §15.247
● <b>FCC ID</b>	: 2APDI-BCM-DA100-AS
● <b>Test Procedure</b>	: ANSI C63.10-2013, DA 00-705
● <b>Date of Test</b>	: January 29, 2020 to February 19, 2020
● <b>Place of Test</b>	: BWS TECH Inc. (FCC Registration Number : 287786) #23, Gokhyeon-ro 480 Beon-gil, Mohyeon-eup, Cheoin-gu, Yongin-si, Gyeonggi-do 17031, South Korea TEL: +82 31 333 5997 FAX: +82 31 333 0017

## 2. Description of Test Facility

### Site Description

- Test Lab.** :  NRRR Designation Number is KR0017.
-  The Certificate Designation Number is KR0017.
-  The Certificate Accreditation Number is KT174.
- Name of Firm** : BWS TECH Inc.
- Site Location** : #23, Gokhyeon-ro 480 Beon-gil, Mohyeon-eup, Cheoin-gu, Yongin-si, Gyeonggi-do 17031, South Korea

## 3. Test Methodology

The tests documented in this report were performed in accordance with ANSI C63.10: 2013 and the requirements of FCC Rules Part 15.207, 15.209 and 15.247. Radio testing was performed according to DA 00-705.

### 3.1 EUT Configuration

The EUT configuration for testing is installed on RF field strength measurement to meet the Commissions requirement and is operated in a manner that intends to maximize its emission characteristics in a continuous normal application.

### 3.2 EUT Exercise

The EUT was operated in the engineering mode to fix the TX frequency that was for the purpose of the measurements. According to its specifications, the EUT must comply with the requirements of the Section 15.207, 15.209 and 15.247 under the FCC Rules Part 15 Subpart C.

### 3.3 FCC Part 15.205 Restricted Bands of Operations

(a) Except as shown in paragraph (d) of this section, only spurious emissions are permitted in any of the frequency bands listed below:

MHz	MHz	MHz	GHz
0.090-0.110	16.42-16.423	399.9-410	4.5-5.15
10.495-0.505	16.69475-16.69525	608-614	5.35-5.46
2.1735-2.1905	16.80425-16.80475	960-1240	7.25-7.75
4.125-4.128	25.5-25.67	1300-1427	8.025-8.5
4.17725-4.17775	37.5-38.25	1435-1626.5	9.0-9.2
4.20725-4.20775	73-74.6	1645.5-1646.5	9.3-9.5
6.215-6.218	74.8-75.2	1660-1710	10.6-12.7
6.26775-6.26825	108-121.94	1718.8-1722.2	13.25-13.4
6.31175-6.31225	123-138	2200-2300	14.47-14.5
8.291-8.294	149.9-150.05	2310-2390	15.35-16.2
8.362-8.366	156.52475-156.52525	2483.5-2500	17.7-21.4
38675	156.7-156.9	2690-2900	22.01-23.12
8.41425-8.41475	162.0125-167.17	3260-3267	23.6-24.0
12.29-12.293	167.72-173.2	3332-3339	31.2-31.8
12.51975-12.52025	240-285	3345.8-3358	36.43-36.5
12.57675-12.57725	322-335.4	3600-4400	(2)
13.36-13.41			

1 Until February 1, 1999, this restricted band shall be 0.490-0.510 MHz.

2 Above 38.6

(b) Except as provided in paragraphs (d) and (e) of this section, the field strength of emissions appearing within these frequency bands shall not exceed the limits shown in §15.209. At frequencies equal to or less than 1000 MHz, compliance with the limits in §15.209 shall be demonstrated using measurement instrumentation employing a CISPR quasi-peak detector. Above 1000 MHz, compliance with the emission limits in §15.209 shall be demonstrated based on the average value of the measured emissions. The provisions in §15.35 apply to these measurements.

### 3.4 Description of Test Modes

This EUT use only BDR mode of bluetooth.

The EUT has been tested under operating condition.

After verification, all tests were carried out with the worst case test modes as shown below, and these were chosen for full testing.

Summary table of Test Cases			
Test Item	Data Rate (Modulation)		
	Bluetooth BDR 1Mbps (GFSK)	Bluetooth EDR 2Mbps ( $\pi/4$ -DQPSK)	Bluetooth EDR 3Mbps (8-DPSK)
Output Power	CH00_2402 MHz CH39_2441 MHz CH78_2480 MHz	CH00_2402 MHz CH39_2441 MHz CH78_2480 MHz	CH00_2402 MHz CH39_2441 MHz CH78_2480 MHz
Conducted Test Case	Data Rate (Modulation)		
	Bluetooth BDR 1Mbps (GFSK)	Bluetooth EDR 3Mbps (8-DPSK)	
	CH00_2402 MHz CH39_2441 MHz CH78_2480 MHz	CH00_2402 MHz CH39_2441 MHz CH78_2480 MHz	
Radiated Test Case	Data Rate (Modulation)		
	Bluetooth BDR 1Mbps (GFSK)	Bluetooth EDR 3Mbps (8-DPSK)	
	CH00_2402 MHz CH39_2441 MHz CH78_2480 MHz	CH00_2402 MHz CH39_2441 MHz CH78_2480 MHz	

## 4. Summary of Test Result

Clause	TEST Description	Standard Section	Requirements	Result
5.1	AC Power Line Conducted Emission	§15.207	§15.207(a)	Pass
5.2	Number of Channel Measurement	§15.247(a)(1)	≥ 15 Channel Number	Pass
5.3	Hopping Channel Separation Measurement	§15.247(a)(1)	≥ 2/3 of 20 dB Bandwidth	Pass
5.4	Dwell Time Measurement	§15.247(a)(1)	≤ 0.4 s	Pass
5.5	20dB Bandwidth	§15.247(a)(1)	N/A	Pass
5.6	Peak Output Power Measurement	§15.247(b)(1)	≤ 125mW	Pass
5.7	Conducted Spurious Emission	§15.247(d)	≥20dBc/100kHz	Pass
5.8	Band Edges Measurement	§15.247(d)	§15.205(a), §15.209(a)	Pass
5.9	Radiated Spurious Emission	§15.247(d), §15.209(a), §15.35(b)	§15.209, §15.247(d)	Pass
5.10	Antenna Application	§15.247(b), §15.203	§15.247(b), §15.203	Pass



## 5. Test Equipment

Equipment	Model	Manufacturer	Serial number	Calibration Due date (year/month/date)
PROGRAMMABLE TEMP. & HUMID. CHAMBER	SJ1013-TH	SeoJin Corp.	9204245	2020/06/07
USB RF POWER SENSOR	RPR3006W	D.A.R.E!! Instruments	14I000048SNO09	2020/04/10
PROGRAMMABLE DC POWER SUPPLY	UDP-6015R	UNICORN	1301006	2020/08/26
SYNTHESIZED SIGNAL GENERATOR	68367C	ANRITSU	#004908	2020/05/20
Signal Analyzer	FSP	Rohde & Schwarz	100631	2020/12/24
EMC ANALYZER	E7405A	Agilent	MY45104194	2021/02/13
Boresight Antenna mast controller	AM-BS-4500E	AUDIX	060908-BS	N/A
Antenna Turntable Controller	JAC-2	Daeli EMC	N/A	N/A
Loop Antenna	FMZB1519	SCHWARZBECK	00025	2020/07/24
TRILOG Broadband Antenna	VULB 9163	SCHWARZBECK	01063	2021/04/30
Active Horn Antenna	AHA-118	COM-POWER CORP.	701064	2021/04/30
Horn Antenna	AH-1840	COM-POWER	361812	2020/08/20
RF Amplifier	MPA-10-40	RF Bay, Inc.	191246	2020/06/07
Band reject filter	BRM50701	Micro-Tronics	G236	2020/08/26

## 6. Test Data

### 6.1 AC Power Line Conducted Emission

#### 6.1.1 Test Limit

For equipment that is designed to be connected to the public utility (AC) power line, the radio frequency voltage that is conducted back onto the AC power line on any frequency or frequencies within the band 150 kHz to 30 MHz shall not exceed the limits in the following table.

Frequency of emission(MHz)	Conducted limit(dBμV)	
	Quasi-peak	Average
0.15-0.5	66 to 56*	56 to 46*
0.5-5	56	46
5-30	60	50

\*Decreases with the logarithm of the frequency.

#### 6.1.2 Test Procedures

1. The EUT was placed 0.4 meter from the conducting wall of the shielding room and was kept at least 80 centimeters from any other grounded conducting surface.
2. Connect EUT to the power mains through a line impedance stabilization network(LISN).
3. All the support units are connecting to the other LISN.
4. The LISN provides 50 ohm coupling impedance for the measuring instrument.
5. The FCC states that a 50 ohm, 50 uH LISN should be used.
6. Both sides of AC line were checked for maximum conducted interference.
7. The frequency range from 150 kHz to 30 MHz was searched.
8. Set the test-receiver system to Peak Detect Function and specified bandwidth (IF Bandwidth = 9 kHz) with Maximum Hold Mode. Then measurement is also conducted by Average Detector and Quasi-Peak Detector Function respectively.

#### 6.1.3 Test SET-UP (Block Diagram of Configuration)

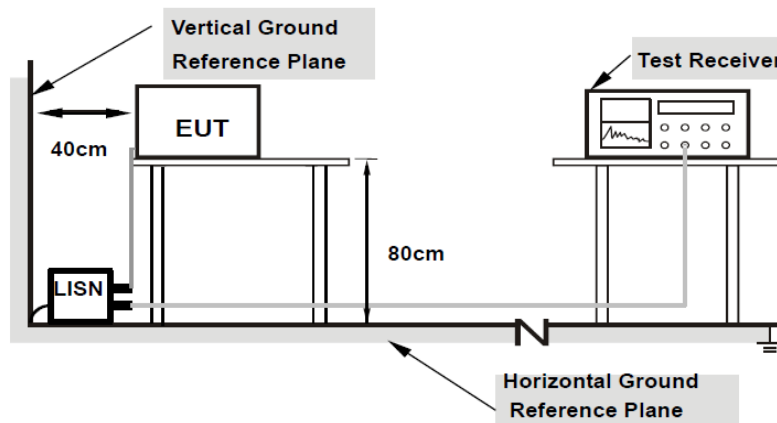

### 6.1.4 Test Results

## Common Information

Test Line: L1

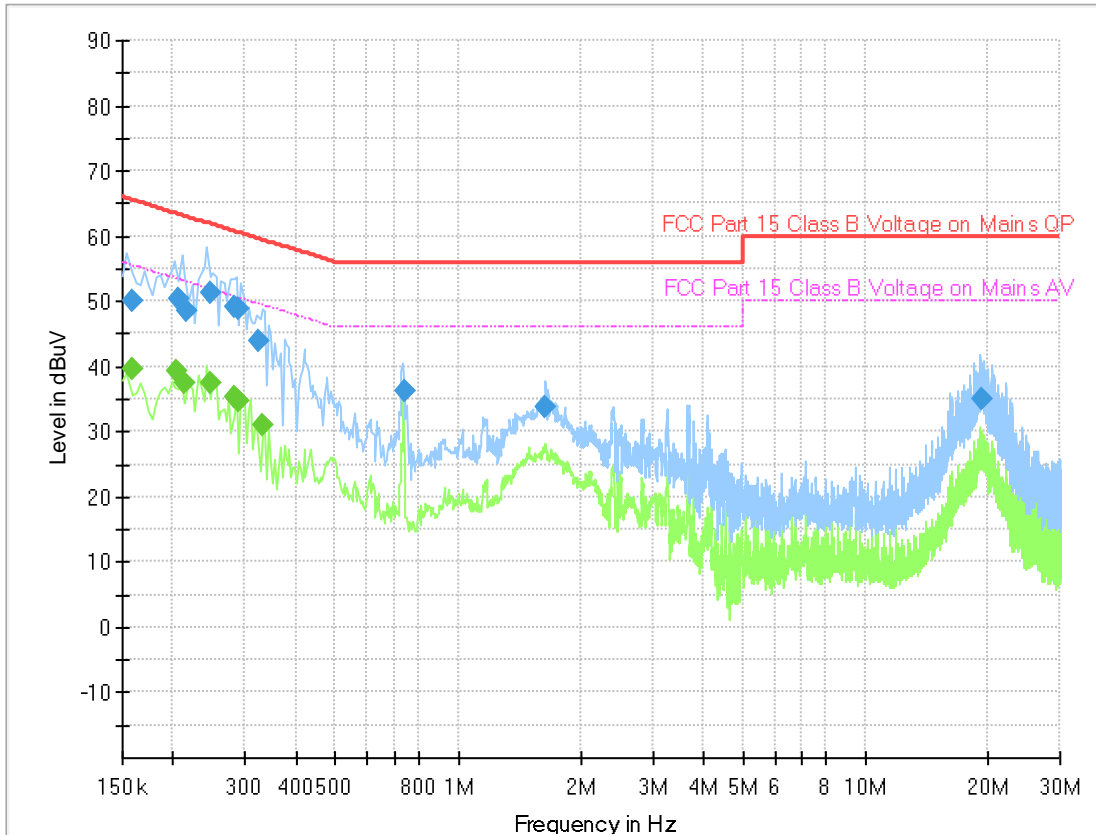

## Final Result

Frequency (MHz)	QuasiPeak (dBuV)	CAverage (dBuV)	Limit (dBuV)	Margin (dB)	Meas. Time (ms)	Bandwidth (kHz)	Line	PE	Corr. (dB)
0.158000	50.09	---	65.57	15.48	3000.0	9.000	L1	FLO	7.9
0.158500	---	39.52	55.54	16.02	3000.0	9.000	L1	FLO	7.9
0.202500	---	39.34	53.51	14.17	3000.0	9.000	L1	FLO	7.8
0.206500	50.31	---	63.35	13.04	3000.0	9.000	L1	FLO	7.8
0.213500	---	37.53	53.07	15.54	3000.0	9.000	L1	FLO	7.8
0.214501	48.42	---	63.03	14.61	3000.0	9.000	L1	FLO	7.8
0.245500	51.36	---	61.91	10.55	3000.0	9.000	L1	FLO	7.8
0.246500	---	37.53	51.87	14.34	3000.0	9.000	L1	FLO	7.8
0.281500	49.10	---	60.77	11.67	3000.0	9.000	L1	FLO	7.7
0.281500	---	35.27	50.77	15.50	3000.0	9.000	L1	FLO	7.7
0.289500	48.81	---	60.54	11.73	3000.0	9.000	L1	FLO	7.7
0.289500	---	34.58	50.54	15.95	3000.0	9.000	L1	FLO	7.7
0.325500	43.99	---	59.57	15.58	3000.0	9.000	L1	FLO	7.7
0.329500	---	31.03	49.46	18.43	3000.0	9.000	L1	FLO	7.7
0.737500	36.34	---	56.00	19.66	3000.0	9.000	L1	FLO	7.7
1.629830	33.77	---	56.00	22.23	3000.0	9.000	L1	FLO	7.9
19.257590	34.88	---	60.00	25.12	3000.0	9.000	L1	FLO	7.9

## Common Information

Test Line: N

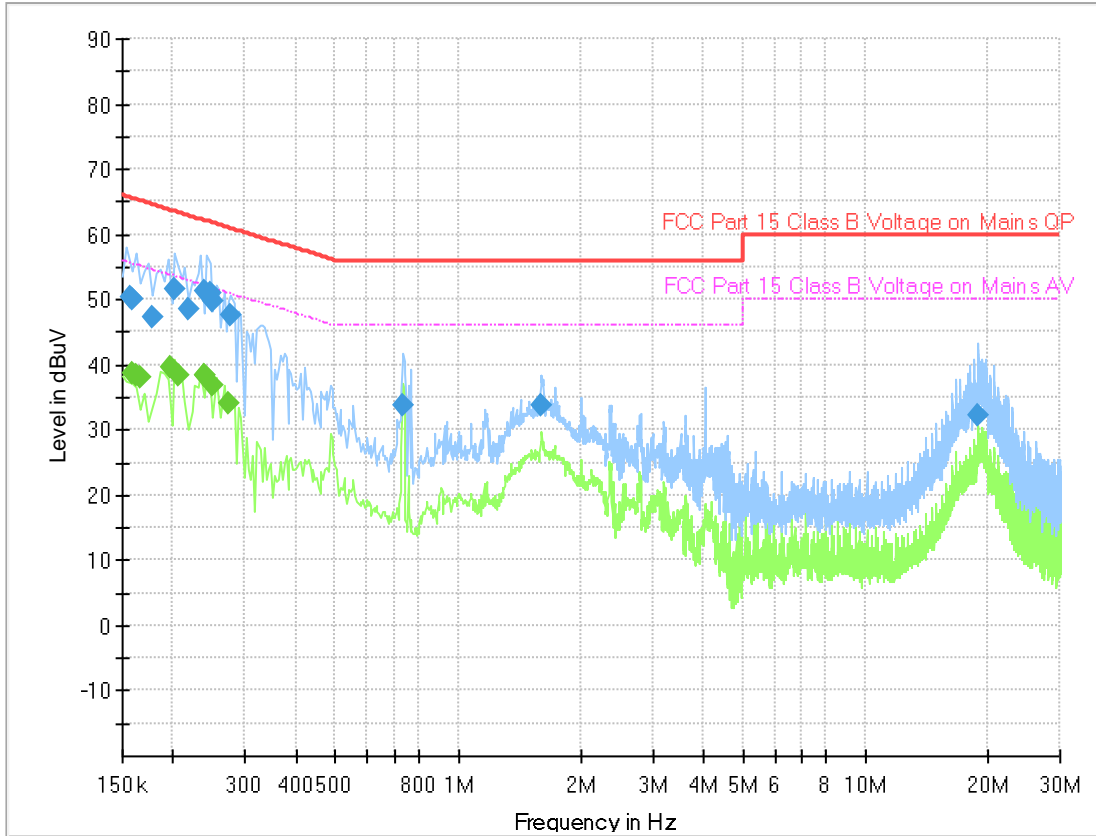

## Final Result

Frequency (MHz)	QuasiPeak (dBuV)	CAverage (dBuV)	Limit (dBuV)	Margin (dB)	Meas. Time (ms)	Bandwidth (kHz)	Line	PE	Corr. (dB)
0.157500	50.24	---	65.60	15.35	3000.0	9.000	N	GND	7.9
0.158000	---	38.62	55.57	16.95	3000.0	9.000	N	GND	7.9
0.158500	50.12	---	65.54	15.42	3000.0	9.000	N	GND	7.9
0.161500	---	38.43	55.39	16.95	3000.0	9.000	N	GND	7.9
0.165500	---	38.08	55.18	17.10	3000.0	9.000	N	GND	7.9
0.178500	47.20	---	64.56	17.35	3000.0	9.000	N	GND	7.9
0.197500	---	39.72	53.72	13.99	3000.0	9.000	N	GND	7.8
0.201500	51.73	---	63.55	11.82	3000.0	9.000	N	GND	7.8
0.205500	---	38.41	53.39	14.98	3000.0	9.000	N	GND	7.8
0.217500	48.39	---	62.91	14.53	3000.0	9.000	N	GND	7.8
0.237500	51.23	---	62.18	10.96	3000.0	9.000	N	GND	7.8
0.237500	---	38.24	52.18	13.95	3000.0	9.000	N	GND	7.8
0.238500	---	38.34	52.15	13.81	3000.0	9.000	N	GND	7.8
0.245500	50.93	---	61.91	10.98	3000.0	9.000	N	GND	7.8
0.249500	49.77	---	61.77	12.00	3000.0	9.000	N	GND	7.7
0.249500	---	36.94	51.77	14.84	3000.0	9.000	N	GND	7.7
0.273500	---	34.17	51.01	16.84	3000.0	9.000	N	GND	7.7
0.277500	47.46	---	60.89	13.43	3000.0	9.000	N	GND	7.7
0.729500	33.66	---	56.00	22.34	3000.0	9.000	N	GND	7.7
1.605970	33.68	---	56.00	22.32	3000.0	9.000	N	GND	7.9
18.795650	32.34	---	60.00	27.66	3000.0	9.000	N	GND	8.2

## 6.2 Number of Channel Measurement

### 6.2.1 Test Limit

Frequency hopping systems in the 2400-2483.5 MHz band shall use at least 15 channels.

### 6.2.2 Test Procedures

1. The testing follows FCC Public Notice DA 00-705 Measurement Guidelines.
2. The RF output of EUT was connected to the spectrum analyzer by RF cable and attenuator. The path loss was compensated to the results for each measurement.
3. Set to the maximum power setting and enable the EUT transmit continuously.
4. Enable the EUT hopping function.
5. Use the following spectrum analyzer settings: Span = the frequency band of operation; RBW  $\geq$  1% of the span; VBW  $\geq$  RBW; Sweep = auto; Detector function = peak; Trace = max hold.
6. The number of hopping frequency used is defined as the number of total channel.
7. Record the measurement data derived from spectrum analyzer.

### 6.2.3 Test SET-UP (Block Diagram of Configuration)

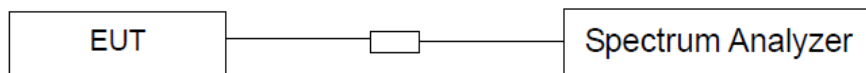

### 6.2.4 Test Results

Test Mode	Number of Hopping(Channel)	Channel Number	Result
BDR(GFSK)	79	$\geq 15$	Pass
EDR(8DPSK)	79	$\geq 15$	Pass

**BDR Number of Hopping Channel - 1**

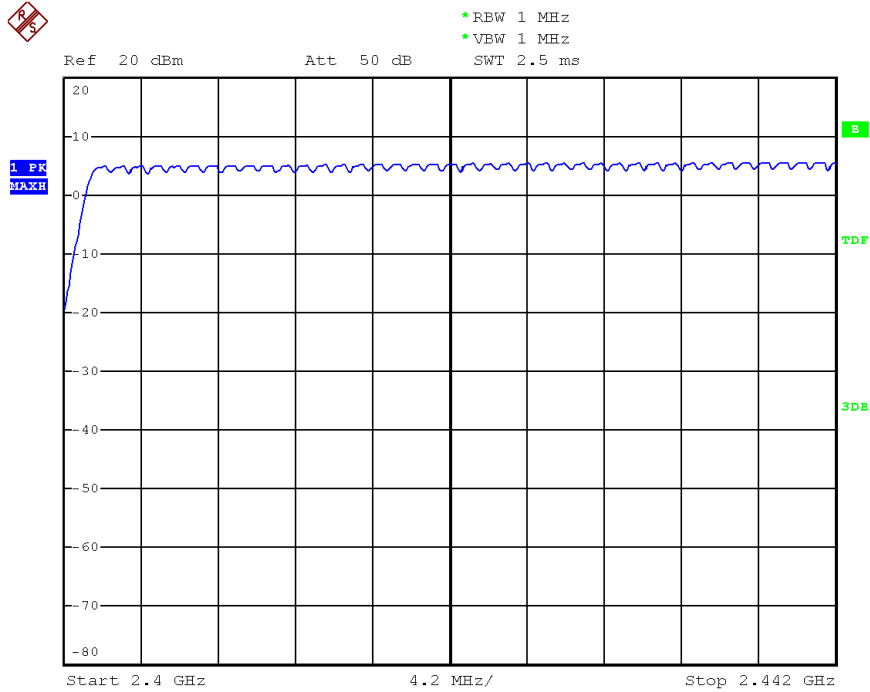

Date: 10.FEB.2020 16:35:35

**BDR Number of Hopping Channel - 2**

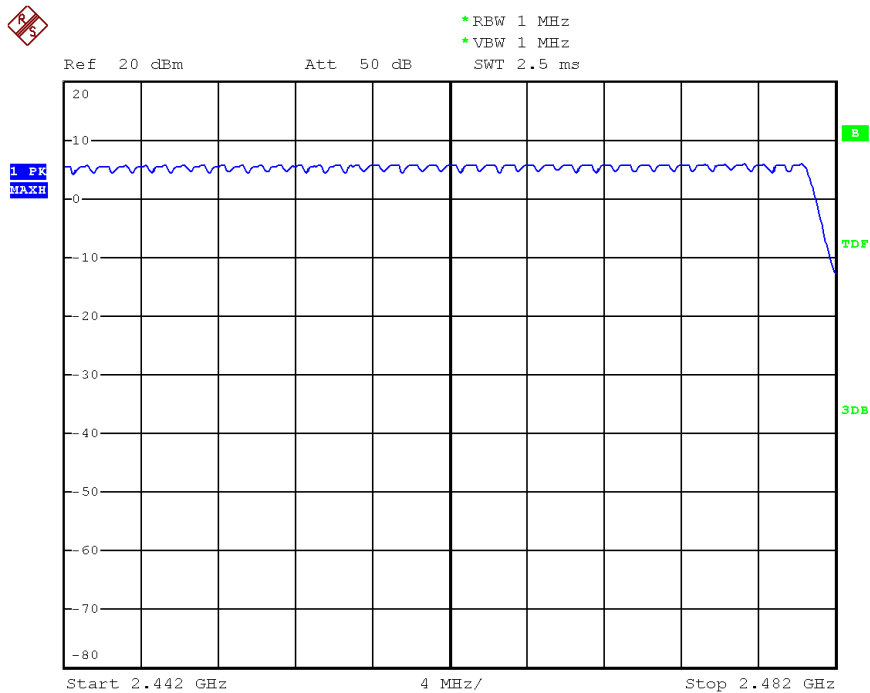

Date: 10.FEB.2020 16:36:12

**EDR Number of Hopping Channel - 1**

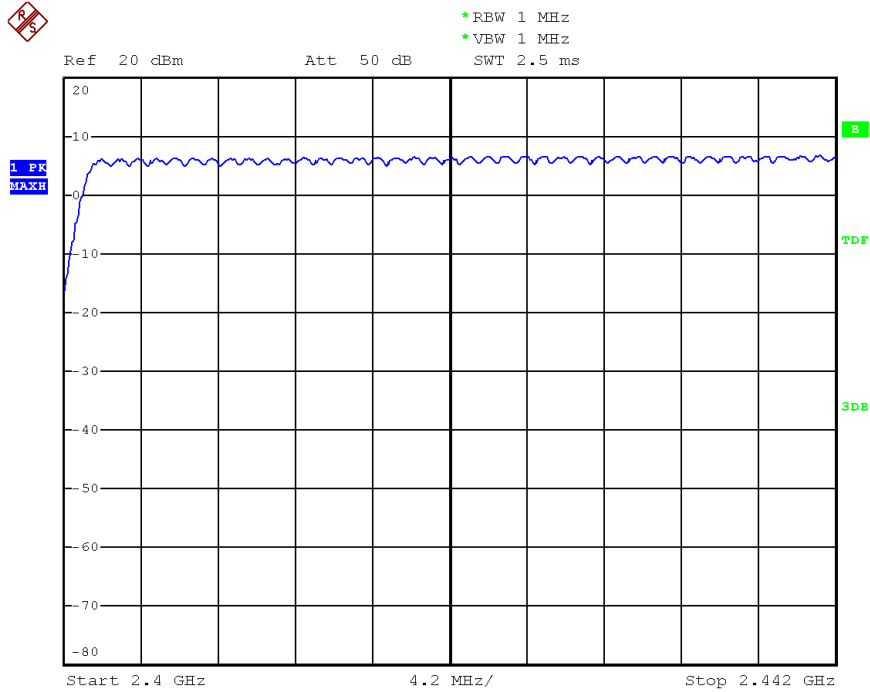

Date: 11.FEB.2020 15:33:28

**EDR Number of Hopping Channel - 2**

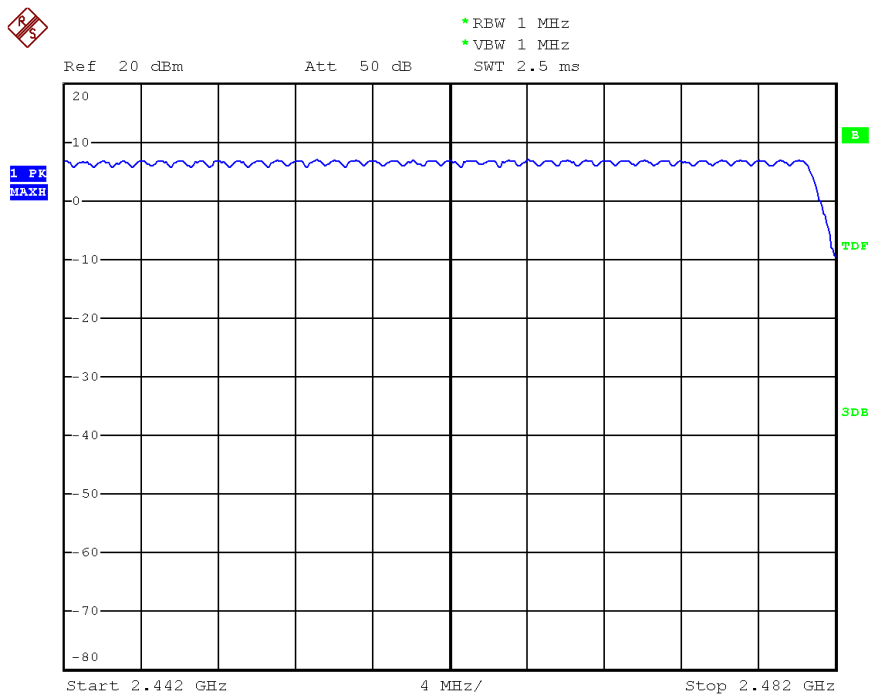

Date: 11.FEB.2020 15:34:47

## 6.3 Hopping Channel Separation Measurement

### 6.3.1 Test Limit

Frequency hopping systems operating in the 2400-2483.5 MHz band may have hopping channel Carrier frequencies that are separated by 25 kHz or two-thirds of the 20 dB bandwidth of the Hopping channel, whichever is greater.

### 6.3.3 Test Procedure

1. The testing follows FCC Public Notice DA 00-705 Measurement Guidelines.
2. The RF output of EUT was connected to the spectrum analyzer by RF cable and attenuator. The Path loss was compensated to the results for each measurement.
3. Set to the maximum power setting and enable the EUT transmit continuously.
4. Enable the EUT hopping function.
5. Use the following spectrum analyzer settings:  
 Span = wide enough to capture the peaks of two adjacent channels;  $RBW \geq 1\%$  of the span;  
 $VBW \geq RBW$ ; Sweep = auto; Detector function = peak; Trace = max hold.
6. Measure and record the results in the test report.

### 6.3.3 Test SET-UP (Block Diagram of Configuration)

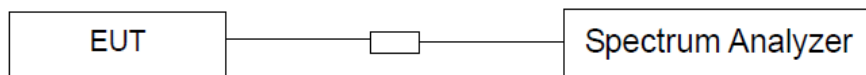

### 6.3.4 Test Results

Modulation	Channel	Test Result (kHz)	Limit (kHz) (2/3 of 20dB BW)
<b>BDR(GFSK)</b>	Low	1008	$\geq 597$
	Middle	1004	$\geq 597$
	High	996	$\geq 597$
<b>EDR(8DPSK)</b>	Low	1004	$\geq 856$
	Middle	1000	$\geq 844$
	High	996	$\geq 848$



**[Hopping Channel Separation]**

Test Mode : BDR 2402 MHz

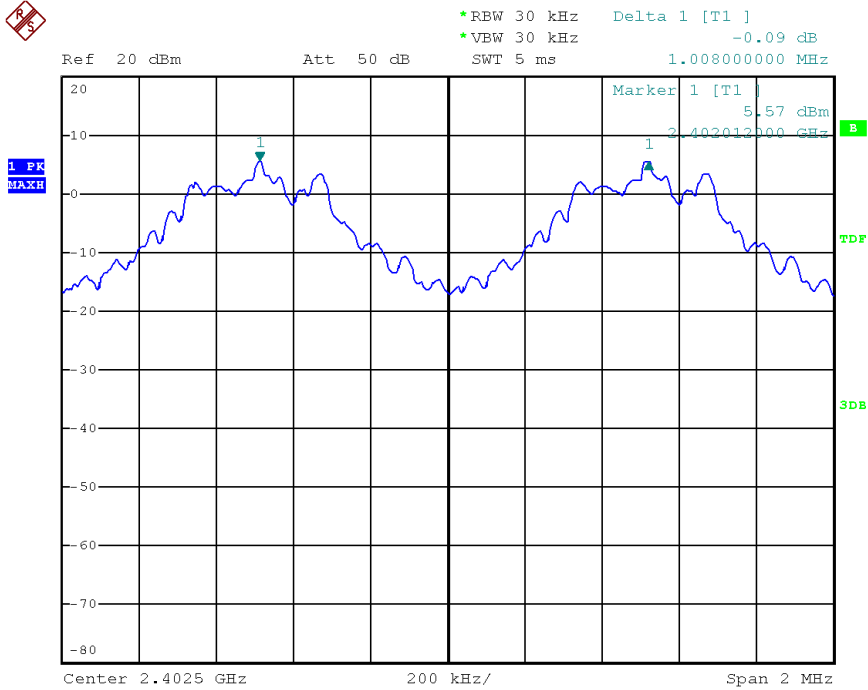

Date: 10.FEB.2020 16:14:00

Test Mode : BDR 2441 MHz

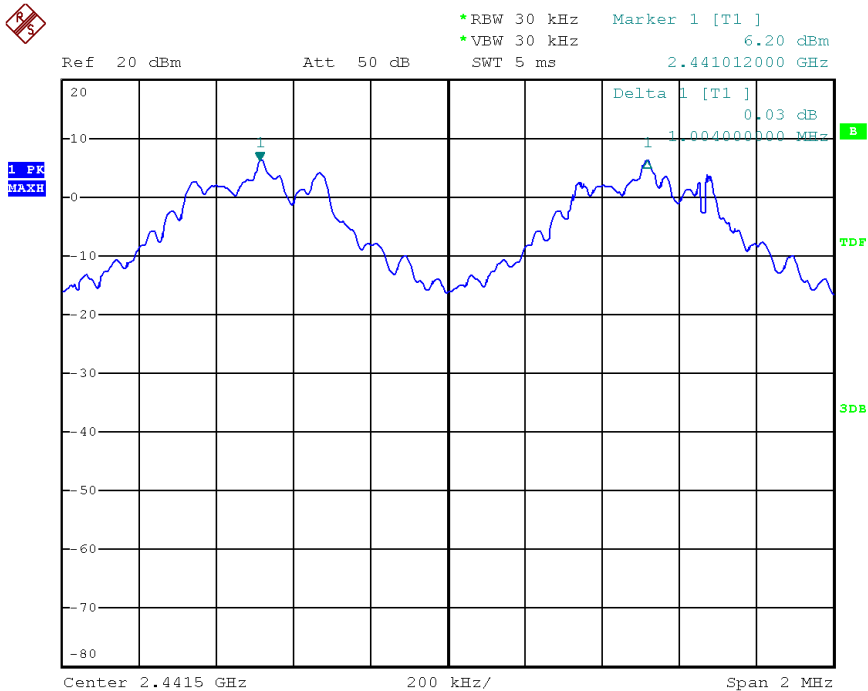

Date: 10.FEB.2020 16:16:14

Test Mode : BDR 2480 MHz

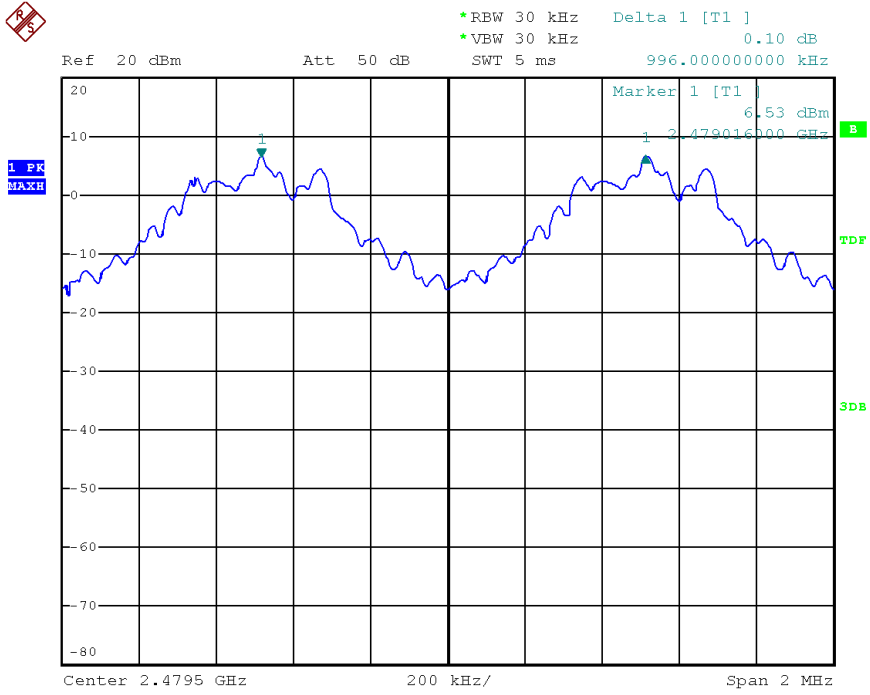

Date: 10.FEB.2020 16:17:15

Test Mode : EDR 2402MHz

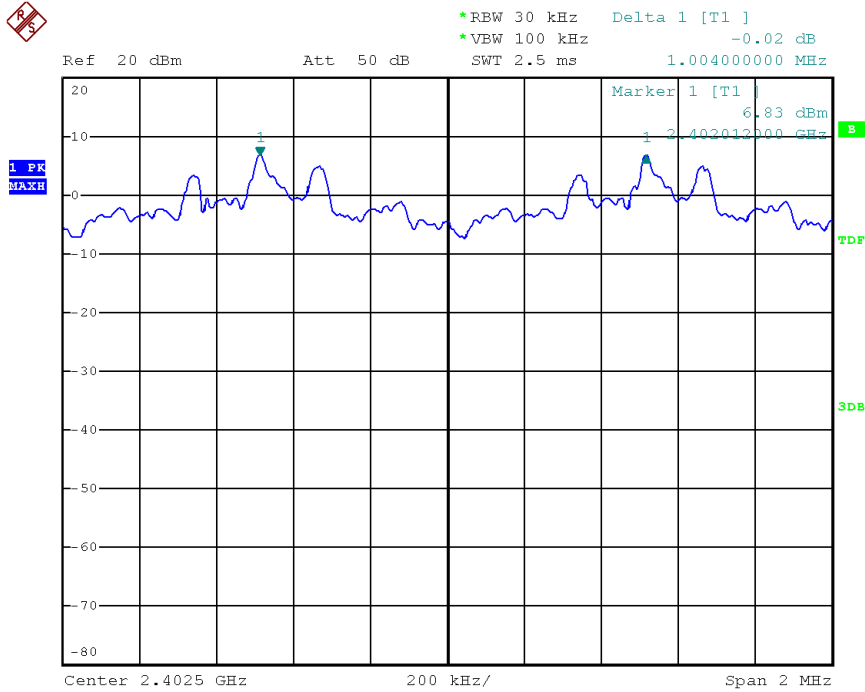

Date: 11.FEB.2020 15:15:22

Test Mode : EDR 2441MHz

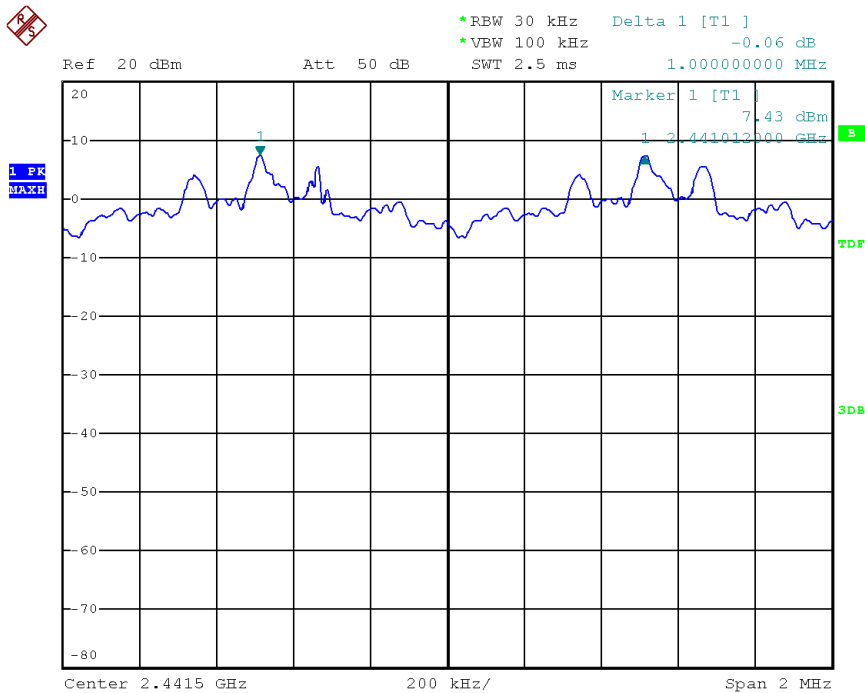

Date: 11.FEB.2020 15:16:13

Test Mode : EDR 2480MHz

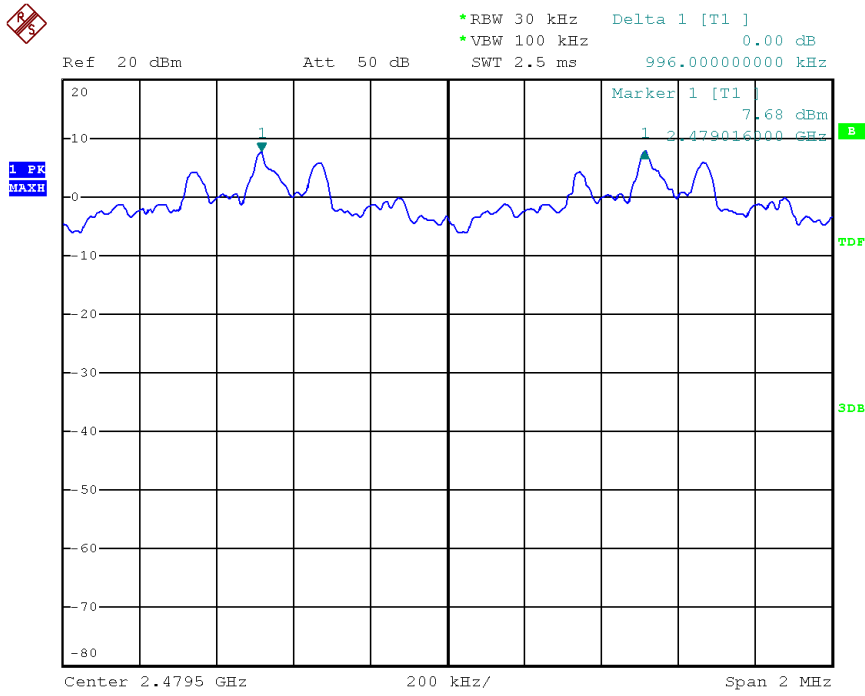

Date: 11.FEB.2020 15:16:58

## 6.4 Dwell Time Measurement

### 6.4.1 Test Limit

The average time of occupancy on any channel shall not be greater than 0.4 seconds within a period of 0.4 seconds multiplied by the number of hopping channels employed.

### 6.4.2 Measurement Procedure

1. The testing follows FCC Public Notice DA 00-705 Measurement Guidelines.
2. The RF output of EUT was connected to the spectrum analyzer by RF cable and attenuator. The path loss was compensated to the results for each measurement.
3. Set to the maximum power setting and enable the EUT transmit continuously.
4. Enable the EUT hopping function.
5. Use the following spectrum analyzer settings: Span = zero span, centered on a hopping channel; RBW = 1 MHz; VBW  $\geq$  RBW; Sweep = as necessary to capture the entire dwell time per hopping channel; Detector function = peak; Trace = max hold.
6. Measure and record the results in the test report.

### 6.4.3 Test SET-UP (Block Diagram of Configuration)

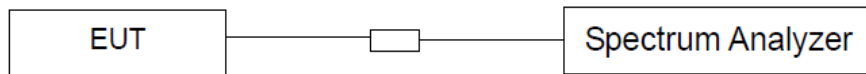

### 6.4.4 Test Results

Test Mode	Channel No.	Frequency (MHz)	Time Slot Length (ms)	Dwell Time (ms)	Limit (ms)	Result
BDR(GFSK)	0	2402	2.946	329.95	<400	Pass
EDR( $\pi/4$ -DQPSK)	0	2402	2.968	379.90	<400	Pass
EDR(8DPSK)	39	2441	2.947	377.22	<400	Pass

**Test mode : BDR**

**GFSK Time of Occupancy**

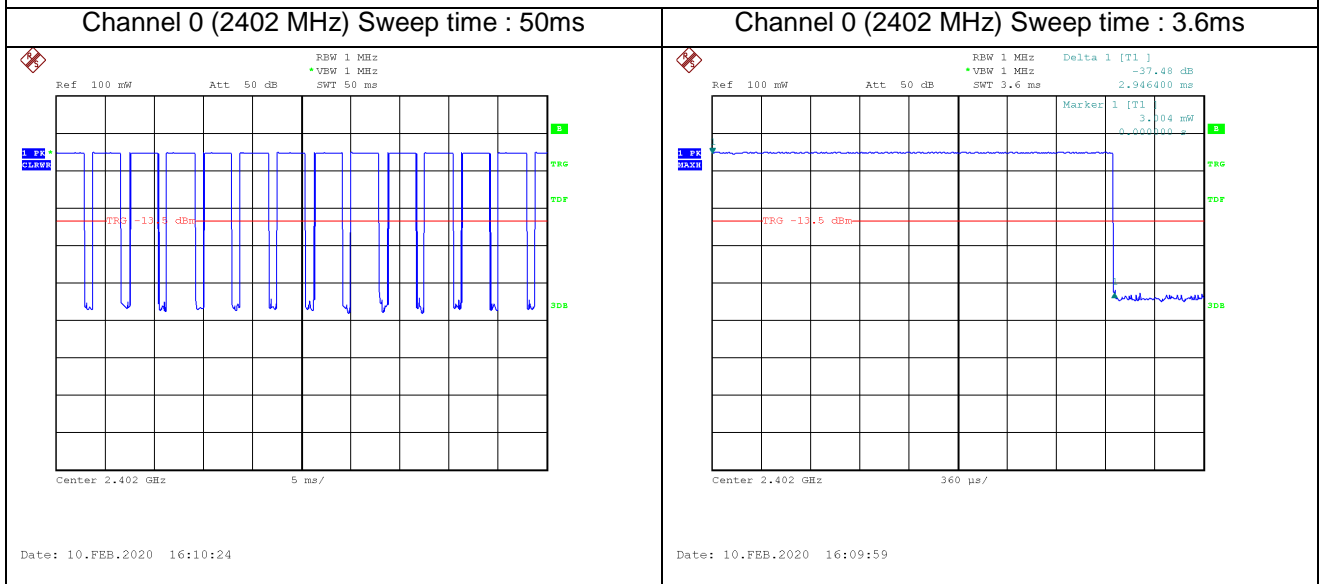

Note : Test Time Period:  $0.4 * 79 = 31.6\text{sec}$ , Hopping Time with 1sec :  $14/50\text{ms} = 280\text{ hops/sec}$ .  
 The Maxmum Occupancy Time within 31.6sec :  $[(2.946\text{ms} * 280) / 79] * 31.6 = 329.95\text{ msec}$ .

**Test mode : EDR**

**$\pi/4$ -DQPSK Time of Occupancy**

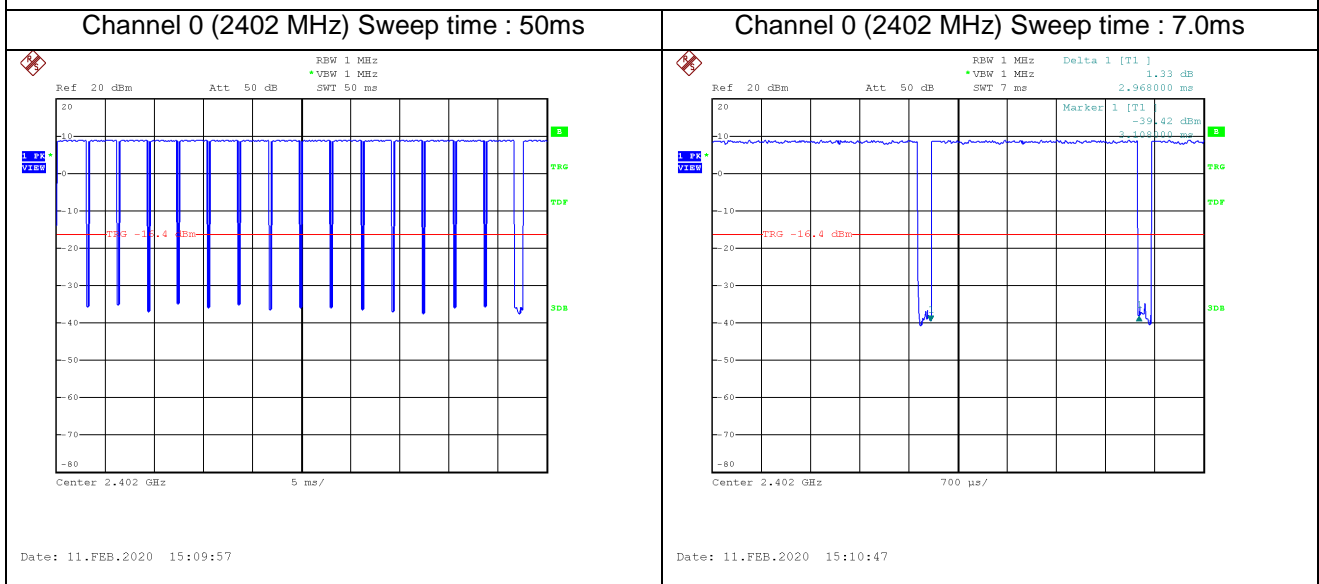

Note : Test Time Period:  $0.4 * 79 = 31.6\text{sec}$ , Hopping Time with 1sec :  $16/50\text{ms} = 320\text{ hops/sec}$ .  
 The Maxmum Occupancy Time within 31.6sec :  $[(2.968\text{ms} * 320) / 79] * 31.6 = 379.90\text{ msec}$ .

**Test mode : EDR**

**8DPSK Time of Occupancy**

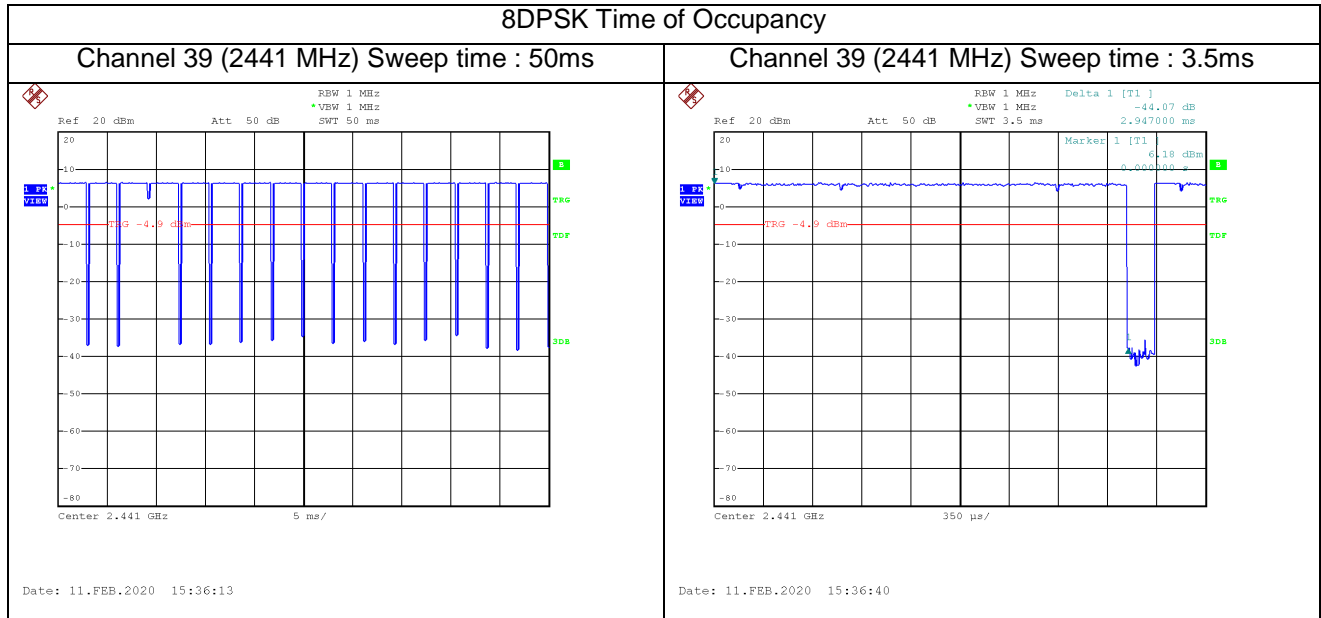

Note : Test Time Period:  $0.4 * 79 = 31.6\text{sec}$ , Hopping Time with 1sec :  $16/50\text{ms} = 320\text{ hops/sec}$ .  
 The Maximum Occupancy Time within 31.6sec :  $[(2.947\text{ms} * 320) / 79] * 31.6 = 377.22\text{ msec}$ .

## 6.5 20dB Bandwidth

### 6.5.1 Test Limit

Reporting only

### 6.5.2 Test Procedure

1. The testing follows FCC Public Notice DA 00-705 Measurement Guidelines.
2. The RF output of EUT was connected to the spectrum analyzer by RF cable and attenuator. The path loss was compensated to the results for each measurement.
3. Set to the maximum power setting and enable the EUT transmit continuously.
4. Use the following spectrum analyzer settings for 20dB Bandwidth measurement.  
Span = approximately 2 to 3 times the 20 dB bandwidth, centered on a hopping channel;  
RBW  $\geq$  1% of the 20 dB bandwidth; VBW  $\geq$  RBW; Sweep = auto; Detector function = peak;  
Trace = max hold.
5. Use the following spectrum analyzer settings for 99 % Bandwidth measurement.  
For 99% Bandwidth measurement, the RBW=30kHz, and VBW = 100kHz. Sweep = auto ;  
Detector function = sample. Trace = max hold.
6. Measure and record the results in the test report.

### 6.5.3 Test SET-UP (Block Diagram of Configuration)

Conducted Emission Test Set-Up, Frequency above 1000MHz

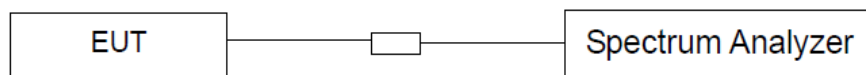



### 6.5.4 Test Result

Test Mode : BDR 2402 MHz

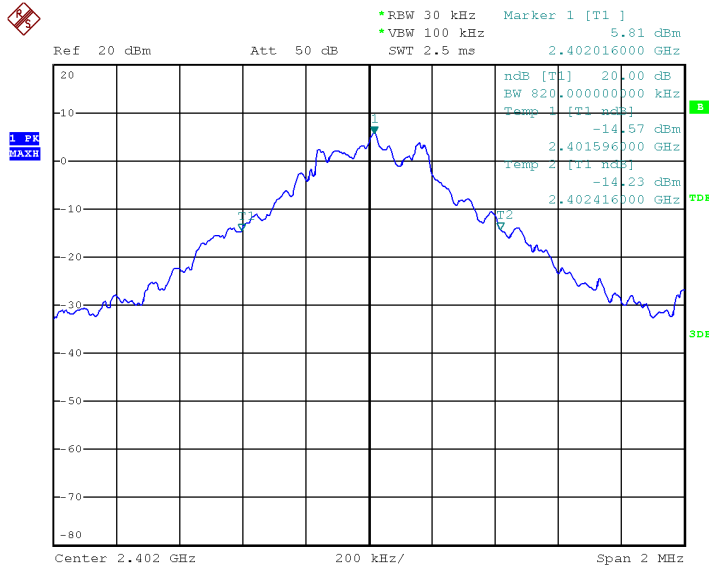

Date: 10.FEB.2020 16:11:16

Test Mode : BDR 2441 MHz

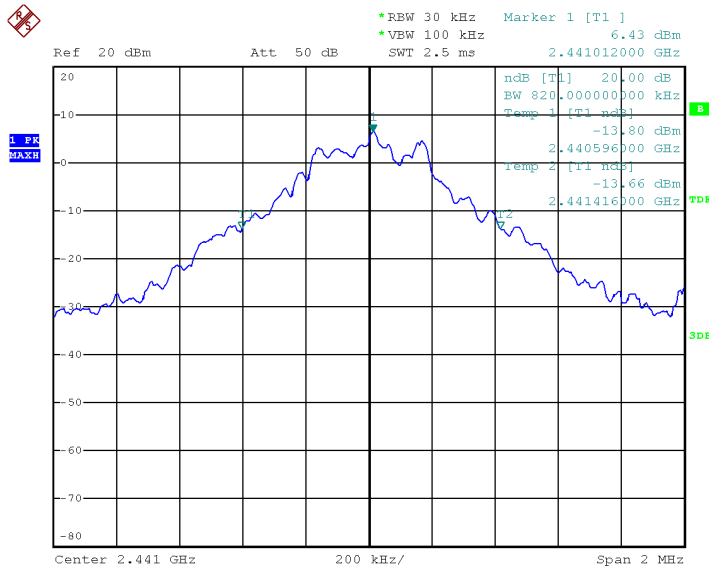

Date: 10.FEB.2020 16:11:50

Test Mode : BDR 2480 MHz

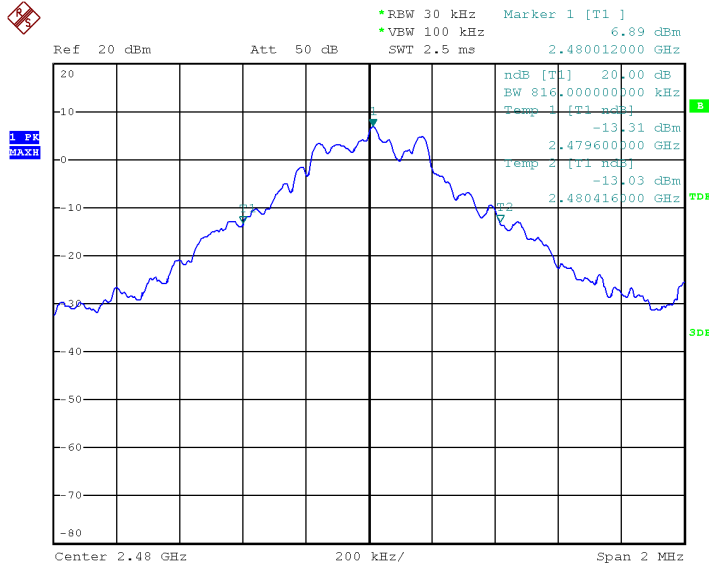

Date: 10.FEB.2020 16:12:20

Test Mode : EDR 2402MHz

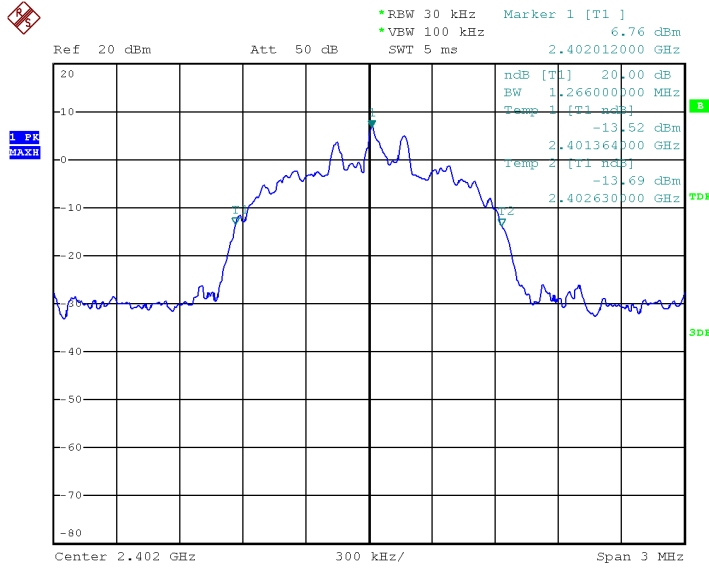

Date: 11.FEB.2020 15:13:29

Test Mode : EDR 2441MHz

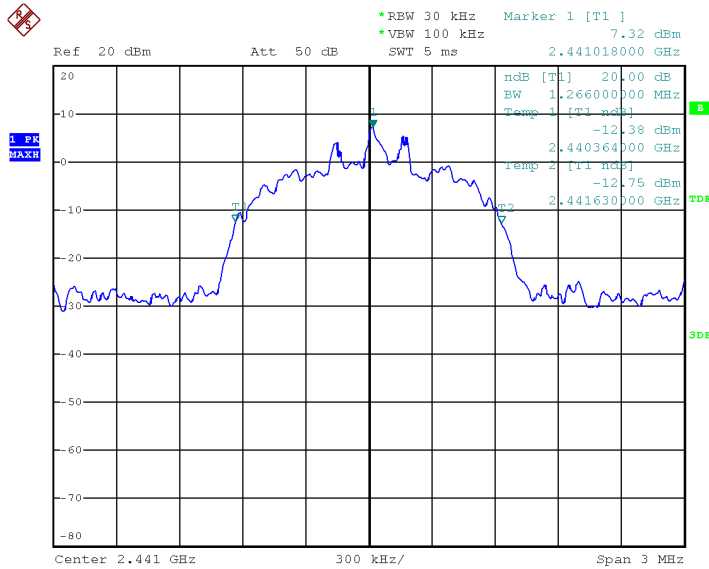

Date: 11.FEB.2020 15:13:57

Test Mode : EDR 2480MHz

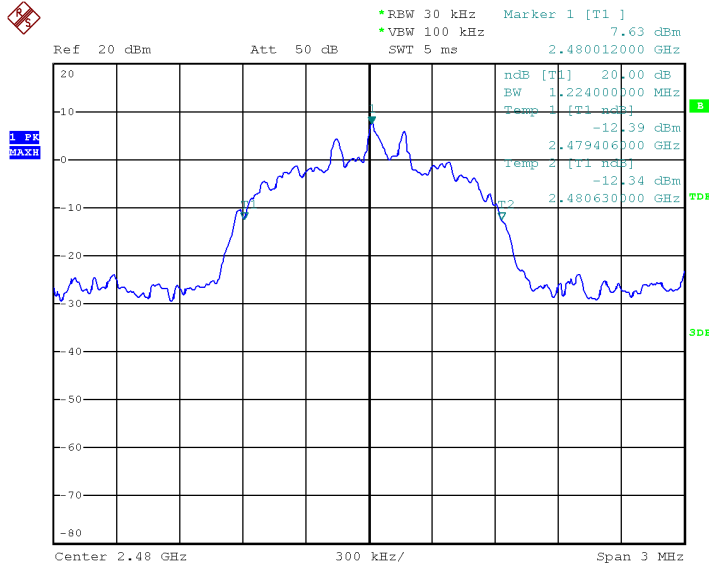

Date: 11.FEB.2020 15:14:20

## 6.6 Peak Output Power Measurement

### 6.6.1 Test Limit

The maximum peak conducted output power of the intentional radiator shall not exceed the following:  
 (1) For frequency hopping systems operating in the 2400-2483.5 MHz band employing at least 75 non-overlapping hopping channels, and all frequency hopping systems in the 5725-5850 MHz band: 1 watt. For all other frequency hopping systems in the 2400-2483.5 MHz band 0.125 watts.

### 6.6.2 Test Procedure

1. The testing follows FCC Public Notice DA 00-705 Measurement Guidelines.
2. The RF output of EUT was connected to the power meter by RF cable and attenuator. The path loss was compensated to the results for each measurement.
3. Set to the maximum power setting and enable the EUT transmit continuously.
4. Measure the conducted output power with cable loss and record the results in the test report.
5. Measure and record the results in the test report.

### 6.6.3 Test SET-UP (Block Diagram of Configuration)

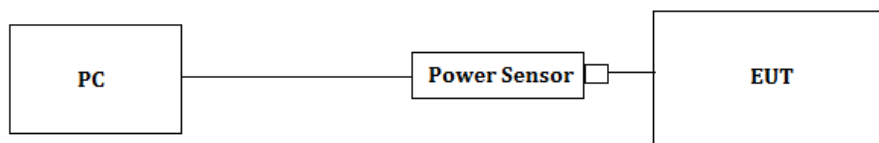

### 6.6.4 Test Result

[Duty Cycle]

Test Mode	Channel	Frequency (MHz)	Duty Cycle	Duty Cycle Factor (dB)
BDR(GFSK)	0	2402	0.787	1.0
	39	2441	0.794	1.0
	78	2480	0.790	1.0
EDR( $\pi/4$ -DQPSK)	0	2402	0.940	0.3
	39	2441	0.940	0.3
	78	2480	0.938	0.3
EDR(8DPSK)	0	2402	0.939	0.3
	39	2441	0.940	0.3
	78	2480	0.940	0.3

Notes : 1. Duty Cycle =  $T_{on} / T_{total}$

2. Duty Cycle Factor =  $10 \cdot \log(1/\text{Duty Cycle})$ .

**[Peak Output Power Measurement]**

Test Mode	Channel	Frequency (MHz)	Peak Output Power (dBm)	Antenna Gain (dBi)	Peak Output Power (EIRP) (dBm)	Duty Cycle Factor + Peak Output Power (EIRP) (dBm)	Max. Limit (dBm)	Result
BDR(GFSK)	0	2402	6.7	-0.63	6.07	7.07	≤ 20.97	Pass
	39	2441	7.2	-0.63	6.57	7.57	≤ 20.97	Pass
	78	2480	5.8	-0.63	5.17	6.17	≤ 20.97	Pass
EDR (π/4-DQPSK)	0	2402	5.2	-0.63	4.57	4.87	≤ 20.97	Pass
	39	2441	5.8	-0.63	5.17	5.47	≤ 20.97	Pass
	78	2480	6.1	-0.63	5.47	5.77	≤ 20.97	Pass
EDR (8DPSK)	0	2402	5.2	-0.63	4.57	4.87	≤ 20.97	Pass
	39	2441	5.9	-0.63	5.27	5.57	≤ 20.97	Pass
	78	2480	6.1	-0.63	5.47	5.77	≤ 20.97	Pass

**Note:** Limit(dBm) is the value of Limit(mW) to be conversion as follows:  $10\log_{10}125 = 20.97\text{dBm}$

Test Mode : : BDR 2402 MHz

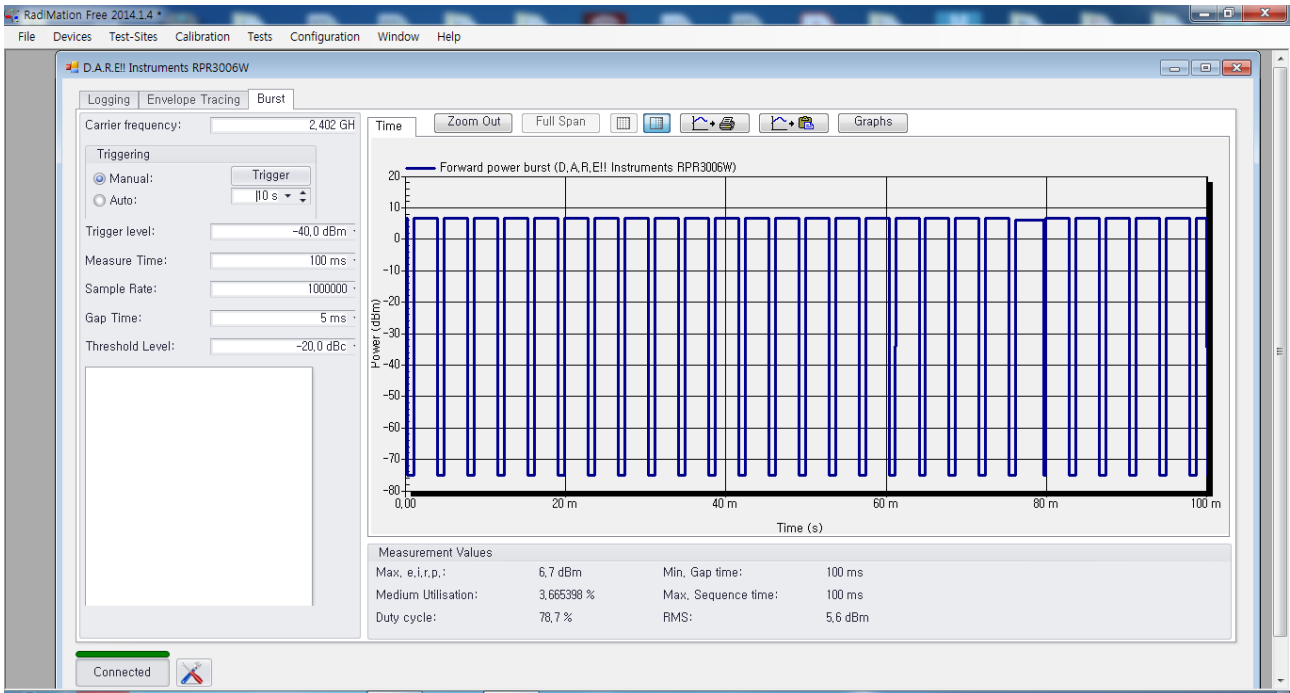

Test Mode : BDR 2441 MHz

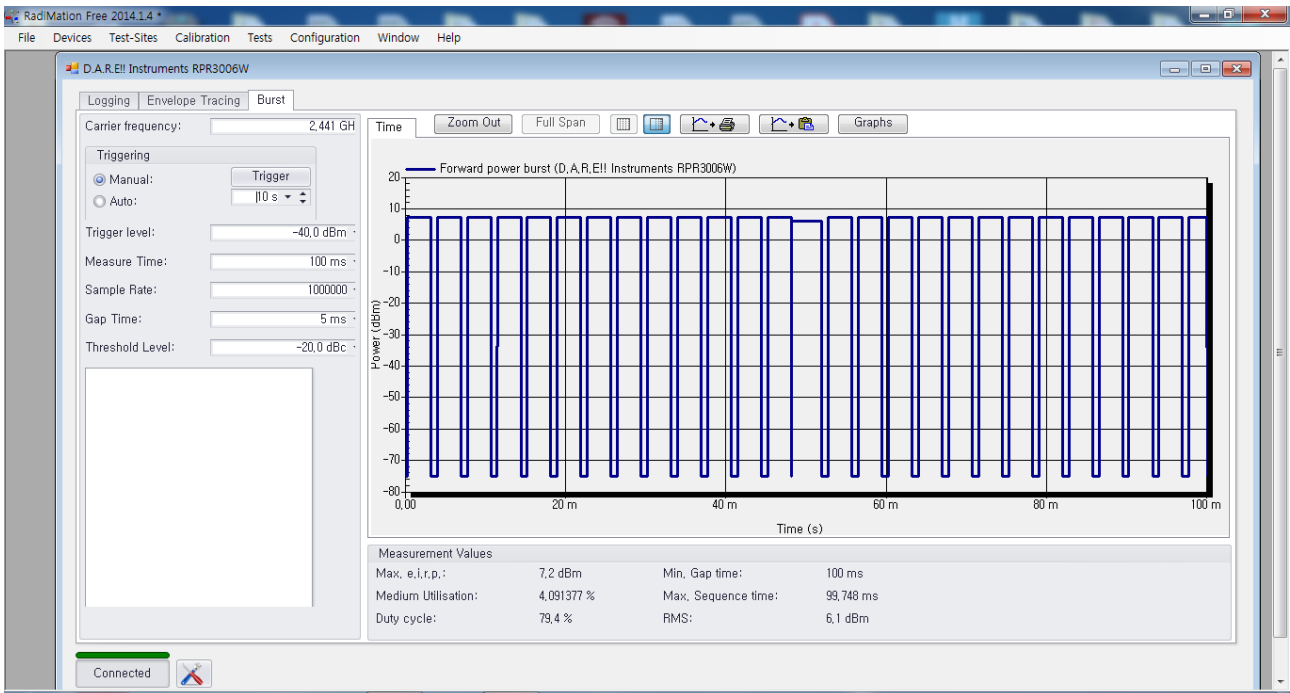

Test Mode : BDR 2480 MHz

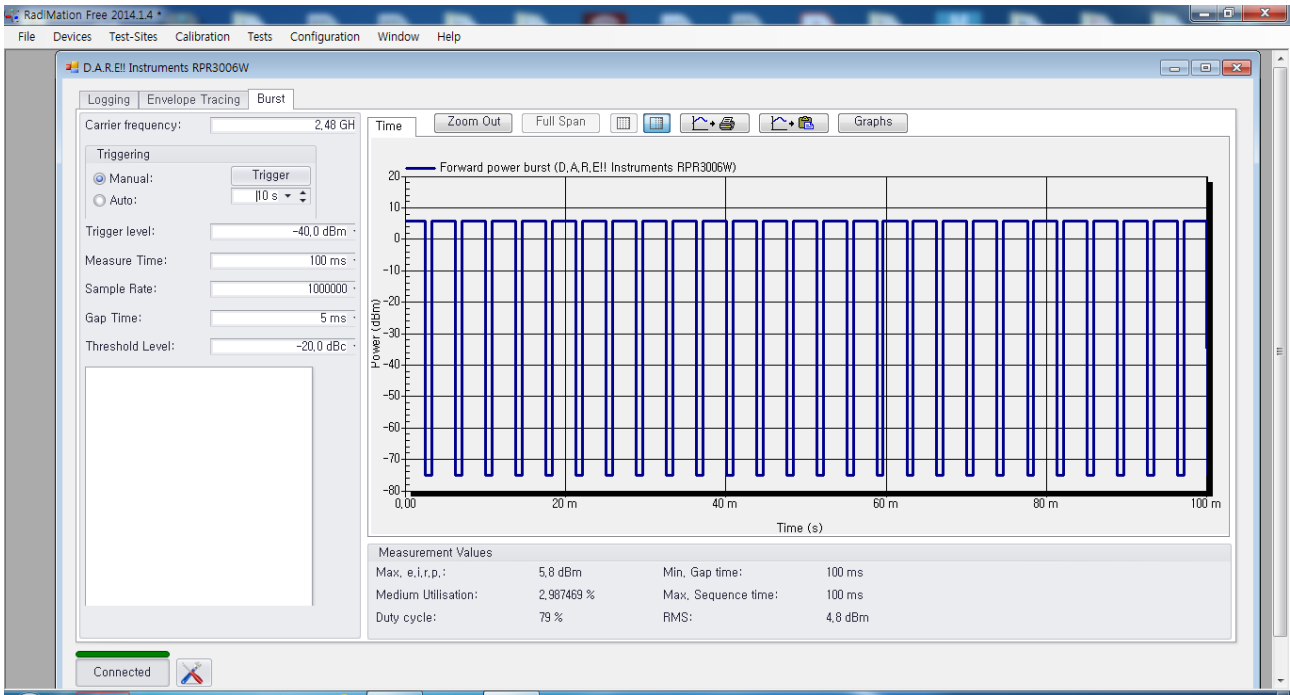



Test Mode : : EDR( $\pi/4$ -DQPSK) 2402 MHz

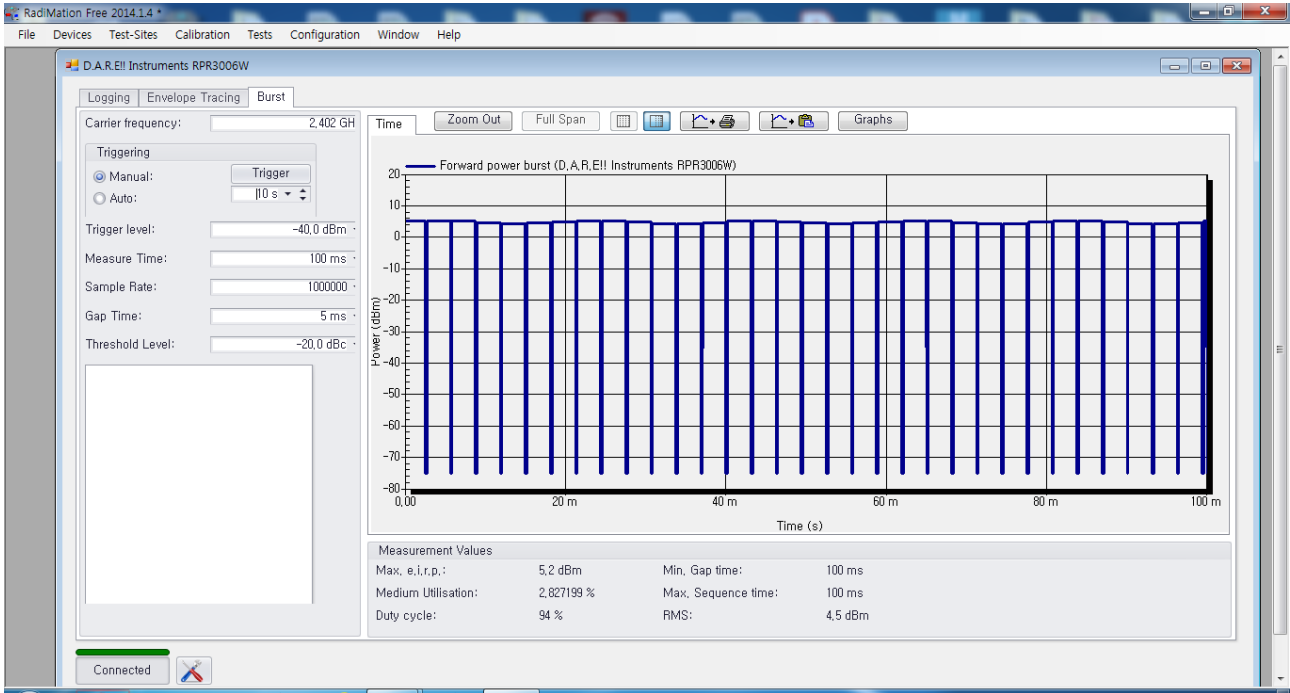

Test Mode : EDR( $\pi/4$ -DQPSK) 2441 MHz

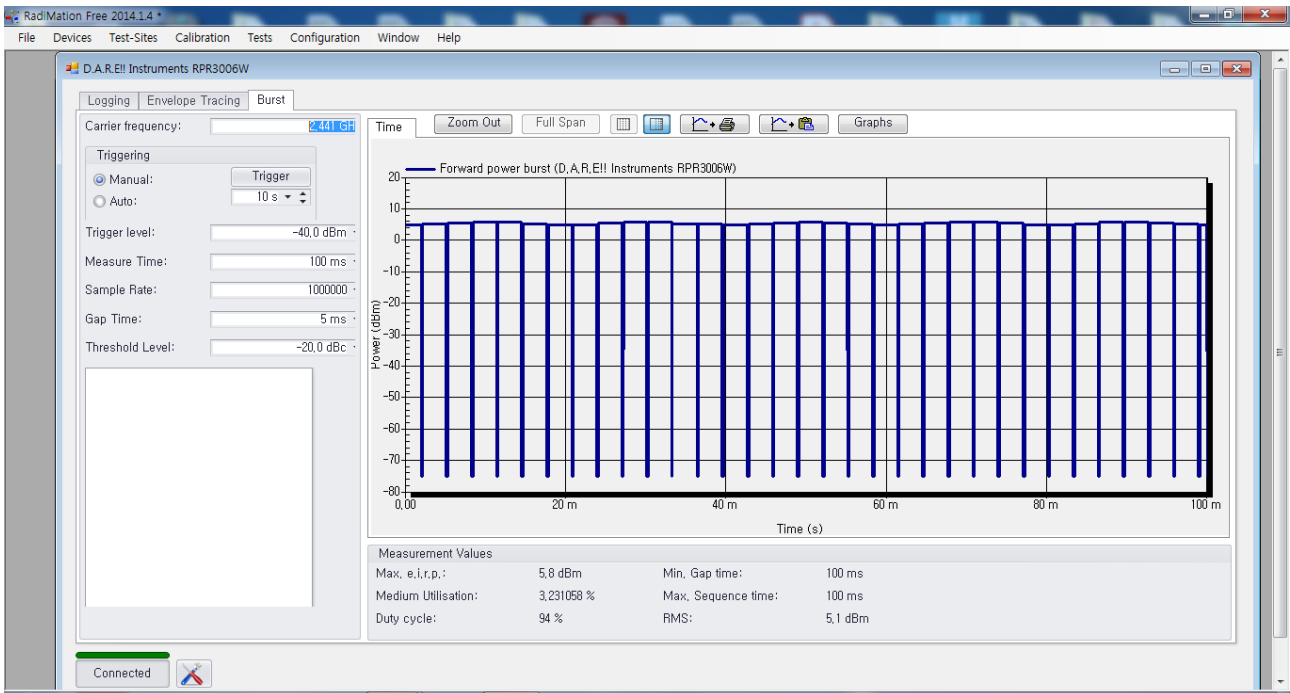

Test Mode : EDR( $\pi/4$ -DQPSK) 2480 MHz

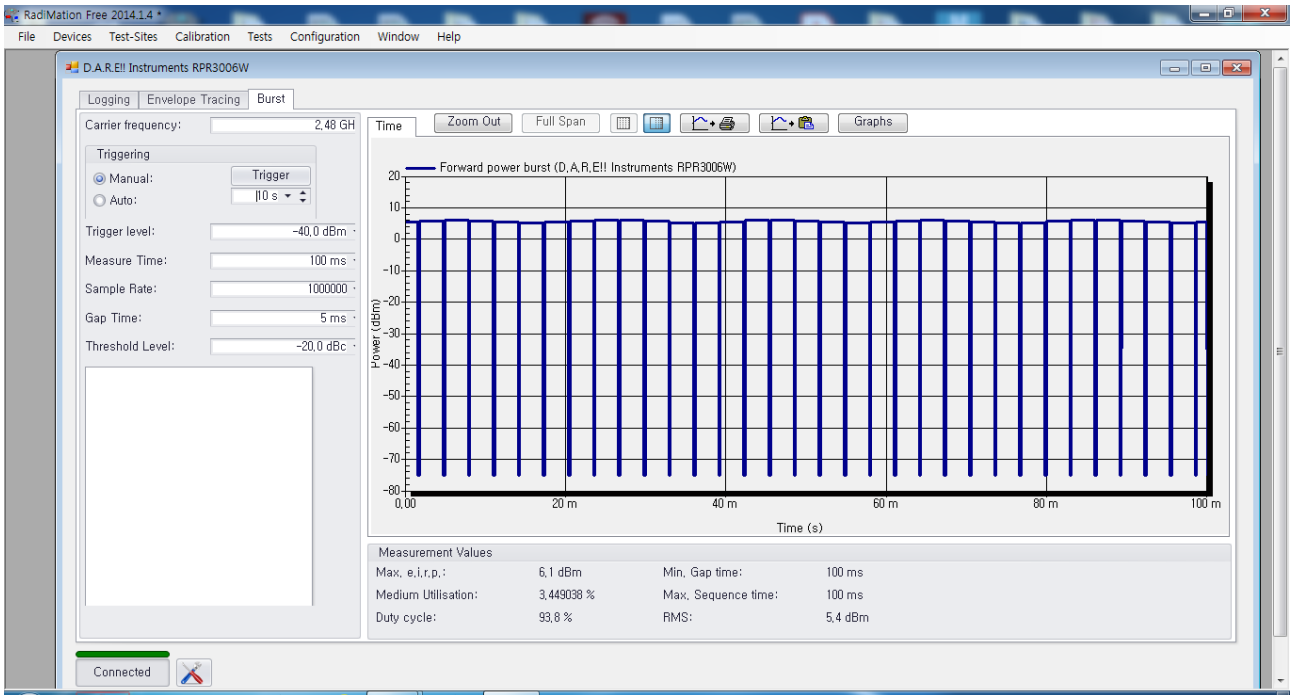

**Test Mode : : EDR(8DPSK) 2402 MHz**

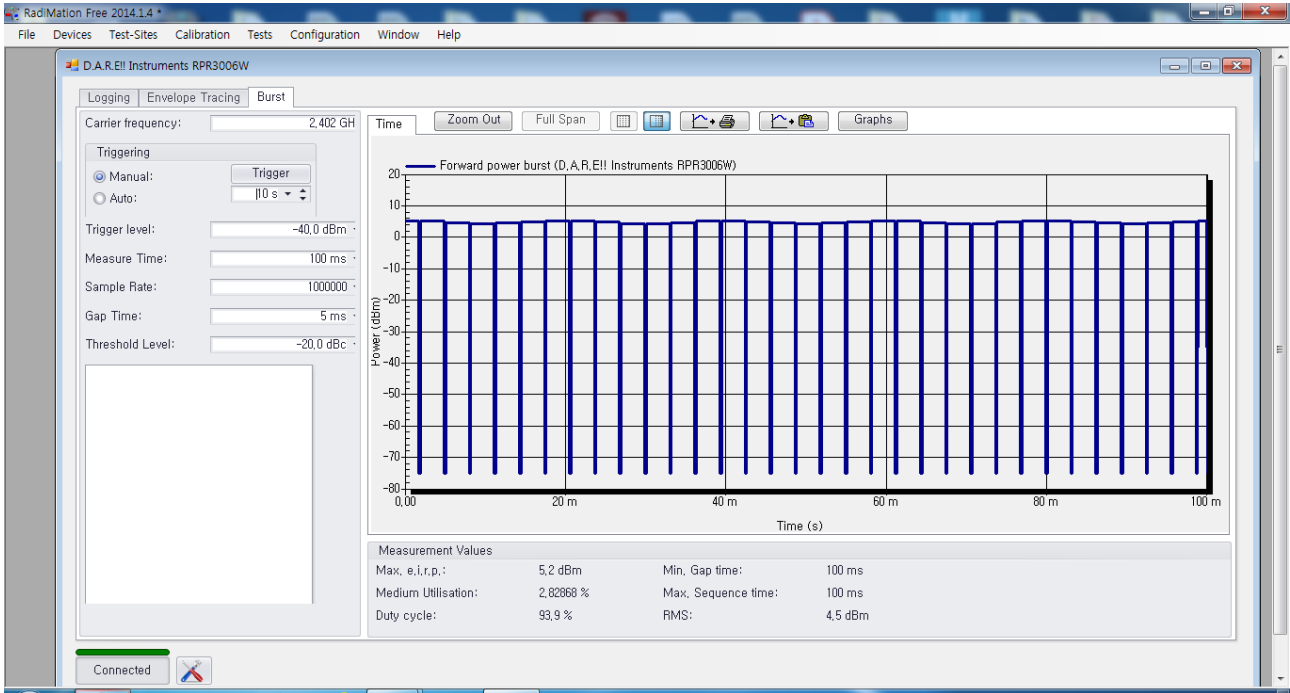

**Test Mode : EDR(8DPSK) 2441 MHz**

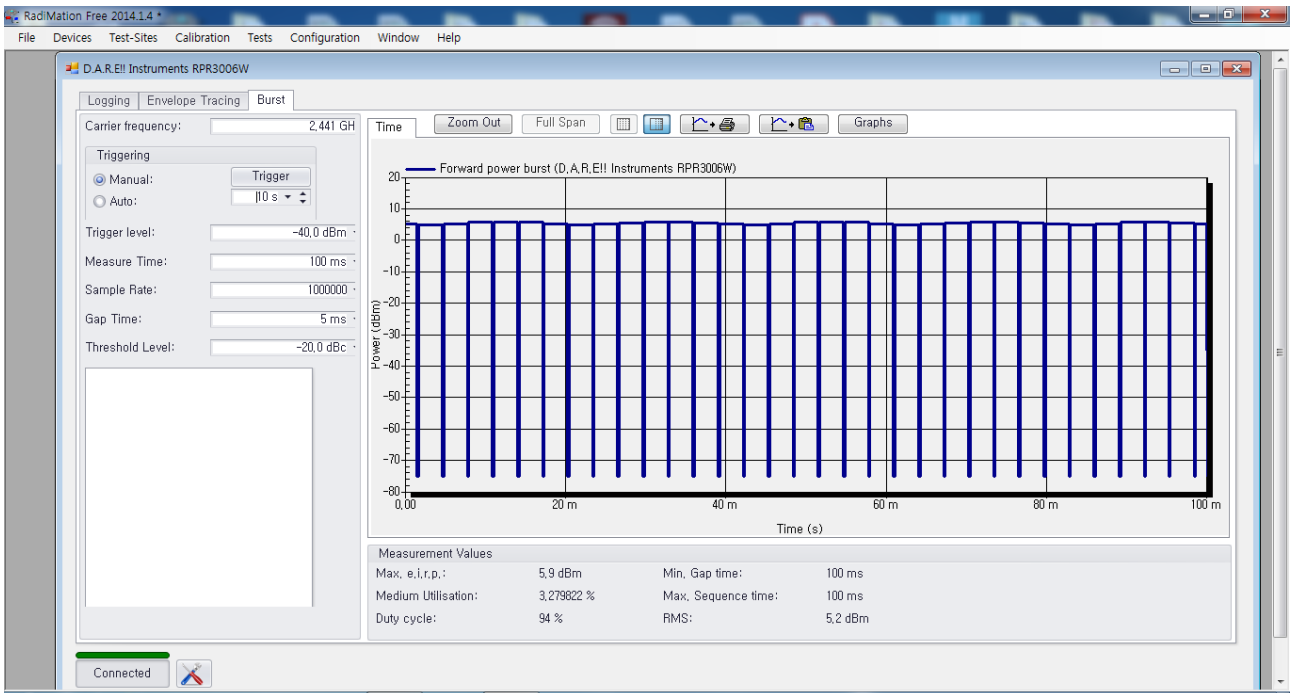

Test Mode : EDR(8DPSK) 2480 MHz

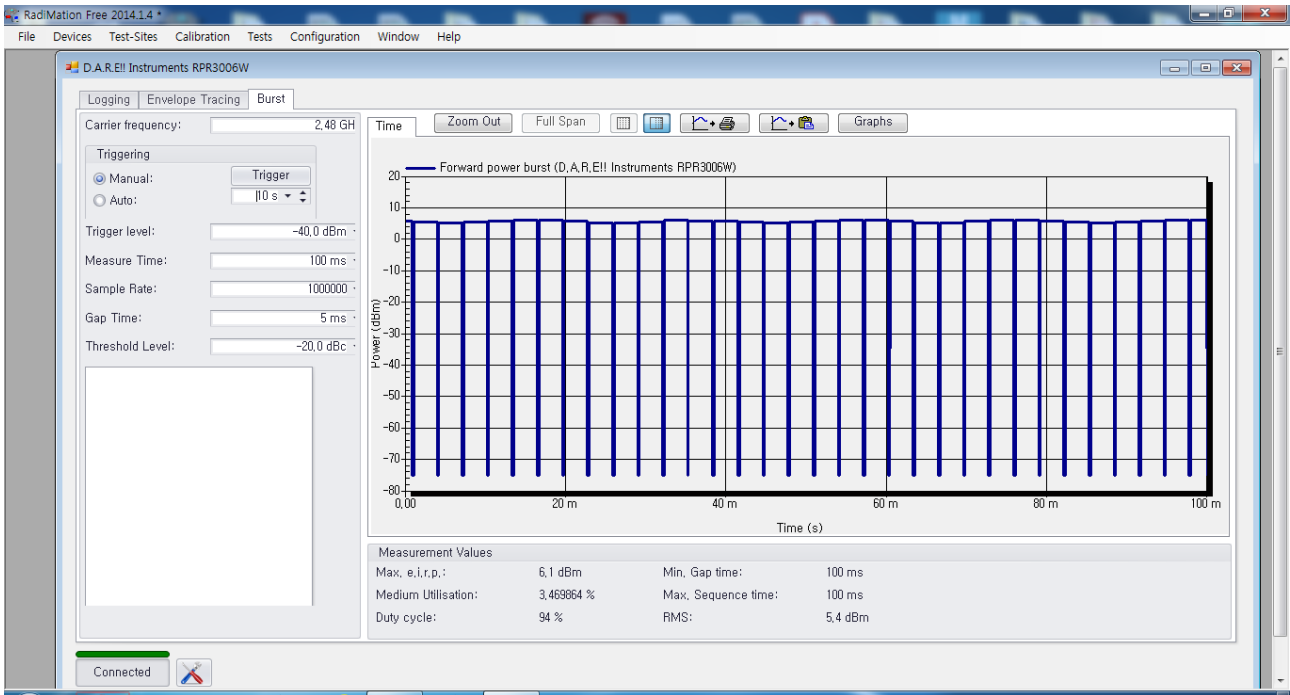

## 6.7 Conducted Spurious Emission

### 6.7.1 Test Limit

According to §15.247(d), in any 100 kHz bandwidth outside the frequency bands in which the spread spectrum intentional radiator is operating, the radio frequency power that is produced by the intentional radiator shall be at least 20dB below that in the 100kHz bandwidth within the band that contains the highest level of the desired power. In addition, radiated emissions which fall in the restricted bands, as defined in §15.205(a), must also comply with the radiated emission limits specified in 15.209(a).

### 6.7.2 Test Procedure

1. The testing follows the guidelines in Band-edge Compliance of RF Conducted Emissions of FCC Public Notice DA 00-705 Measurement Guidelines.
2. Set to the maximum power setting and enable the EUT transmit continuously.
3. Set RBW = 100kHz ( $\geq 1\%$  span=10MHz), VBW = 300kHz ( $\geq$  RBW). Band edge emissions must be at least 20 dB down from the highest emission level within the authorized band as measured with a 100kHz RBW. The attenuation shall be 30 dB instead of 20 dB, when RMS conducted output power procedure is used.
4. Enable hopping function of the EUT and then repeat step 2. and 3.
5. Measure and record the results in the test report.

### 6.7.3 Test SET-UP (Block Diagram of Configuration)

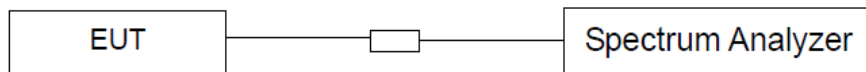

### 6.7.4 Test Result

Test Mode : BDR 2402 MHz

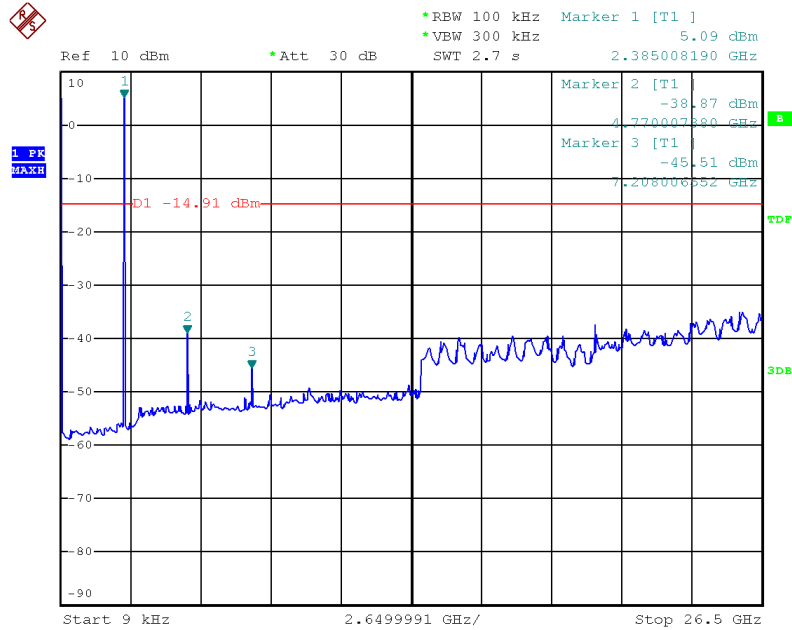

Date: 10.FEB.2020 16:24:55

Test Mode : BDR 2441 MHz

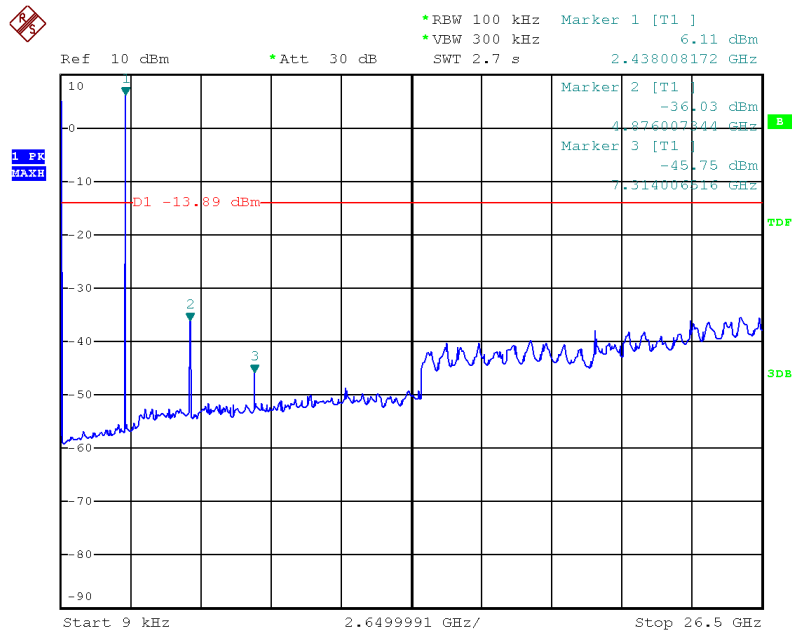

Date: 10.FEB.2020 16:23:05

Test Mode : BDR 2480 MHz

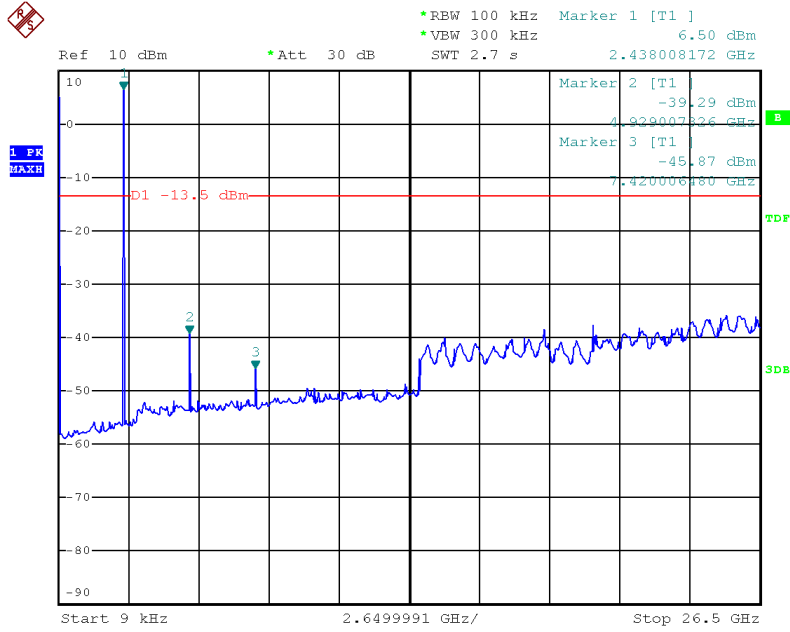

Date: 10.FEB.2020 16:20:50

Test Mode : EDR 2402 MHz

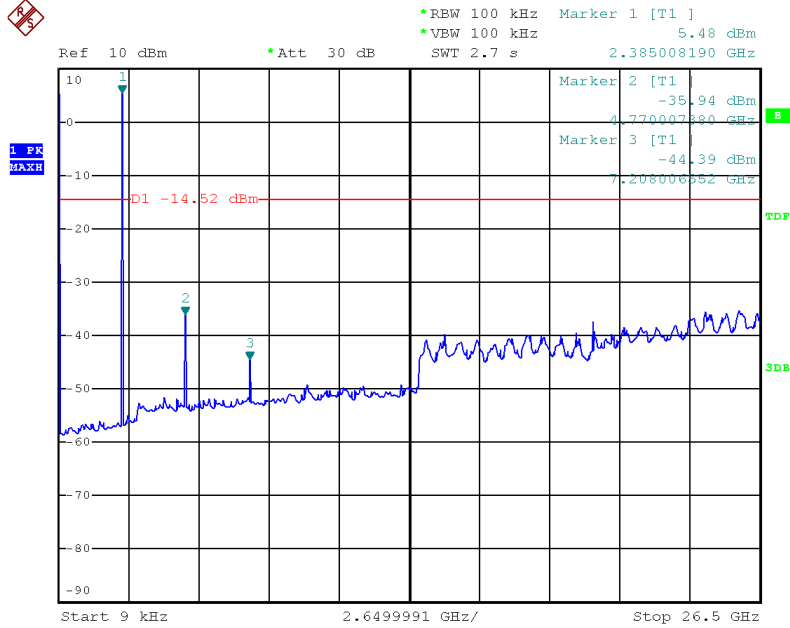

Date: 11.FEB.2020 15:21:14

Test Mode : EDR 2441 MHz

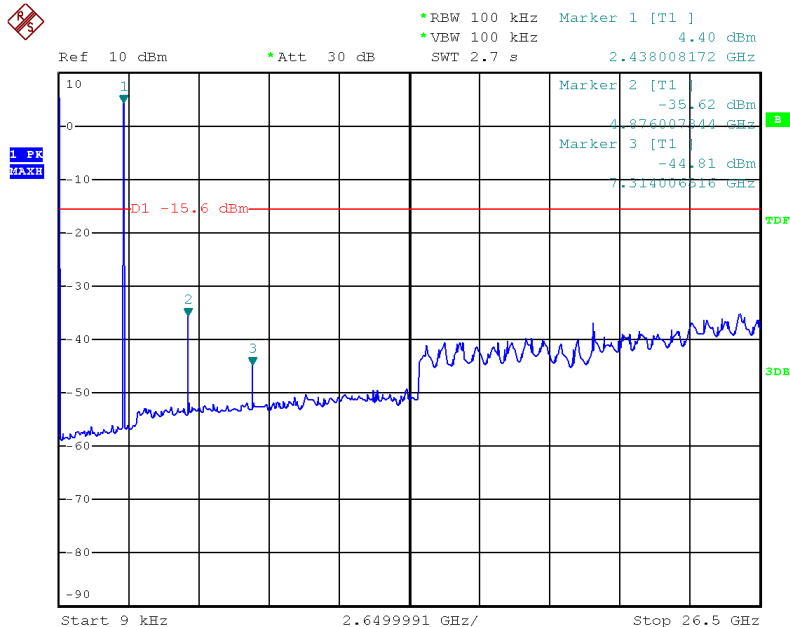

Date: 11.FEB.2020 15:23:25



Test Mode : EDR 2480 MHz

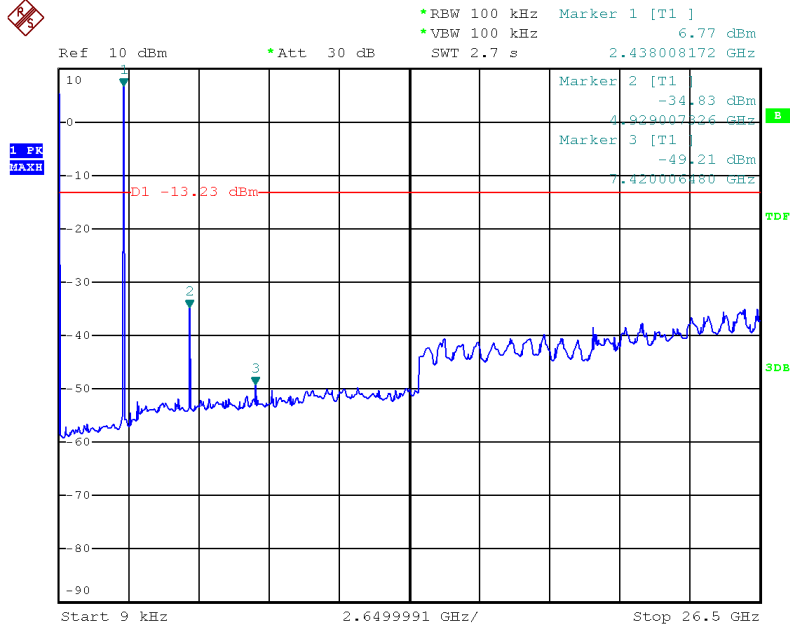

Date: 11.FEB.2020 15:25:30

## 6.8 Band Edges Measurement

### 6.8.1 Test Limit

According to §15.247(d), in any 100 kHz bandwidth outside the frequency bands in which the spread spectrum intentional radiator is operating, the radio frequency power that is produced by the intentional radiator shall be at least 20dB below that in the 100kHz bandwidth within the band that contains the highest level of the desired power. In addition, radiated emissions which fall in the restricted bands, as defined in §15.205(a), must also comply with the radiated emission limits specified in 15.209(a).

### 6.8.2 Test Procedure

The EUT is placed on a turntable with 1.5 meter above ground. The turntable shall be rotated for 360 degrees to determine the position of maximum emission level. EUT is set 3m away from the receiving antenna, which is varied from 1m to 4m to find out the highest emission. Set the spectrum analyzer in the following setting in order to capture the lower and upper band-edges of the emission:

PEAK: RBW=VBW=1MHz / Sweep=AUTO  
 AVERAGE: RBW=1MHz / VBW=10Hz / Sweep=AUTO

Repeat the procedures until all the PEAK and AVERAGE versus POLARIZATION are measured.

### 6.8.3 Test SET-UP (Block Diagram of Configuration)

(a) Conducted Emission Test Set-Up, Frequency above 1000MHz

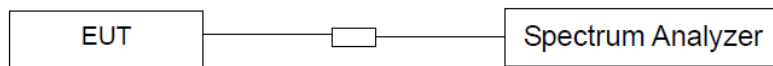

(b) Radiated Emission Test Set-Up, Frequency above 1000MHz

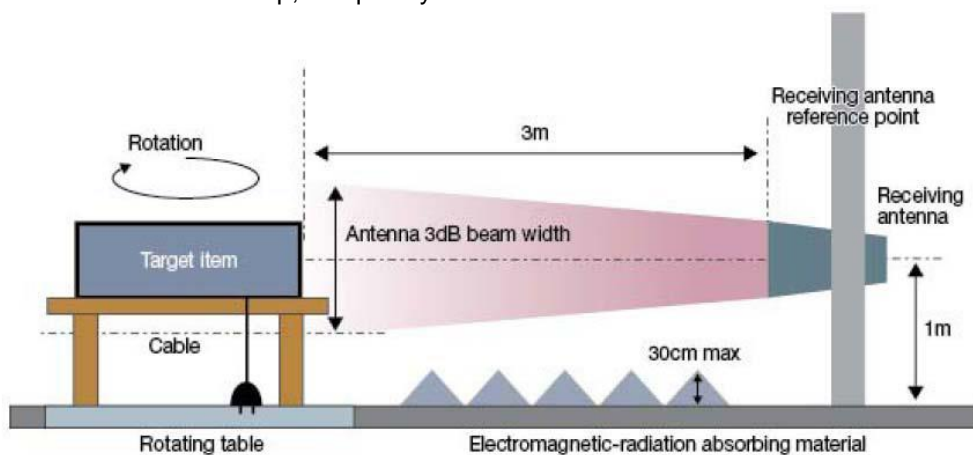

### 6.8.4 Test Result

#### [Conducted Band Edges]

Test Mode : BDR 2402 MHz Band Edge

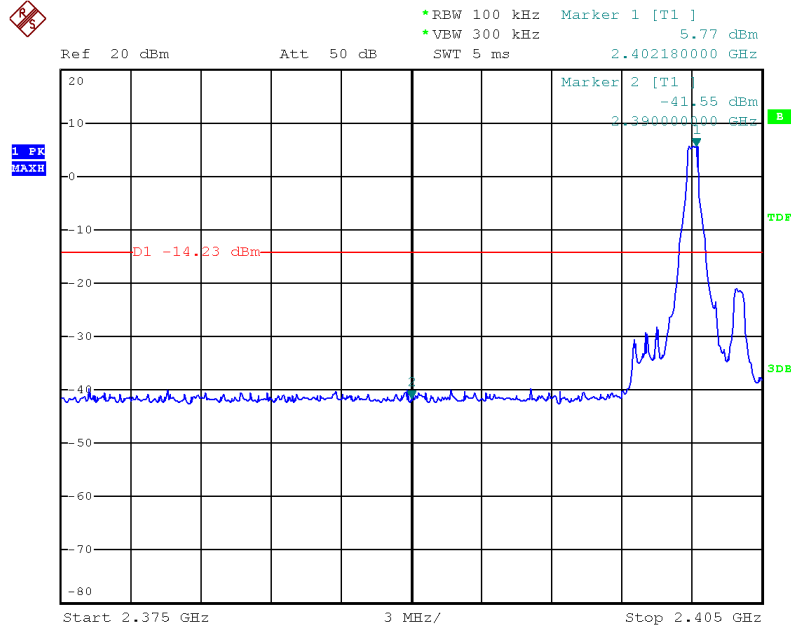

Date: 10.FEB.2020 16:27:28

Test Mode : BDR 2480 MHz Band Edge

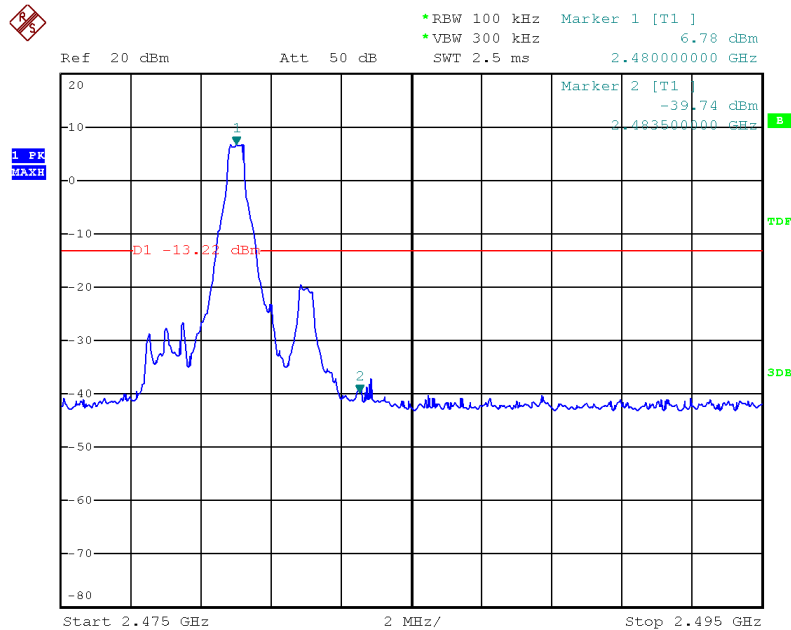

Date: 10.FEB.2020 16:29:05

Test Mode : Hopping Mode BDR 2402 MHz Band Edge

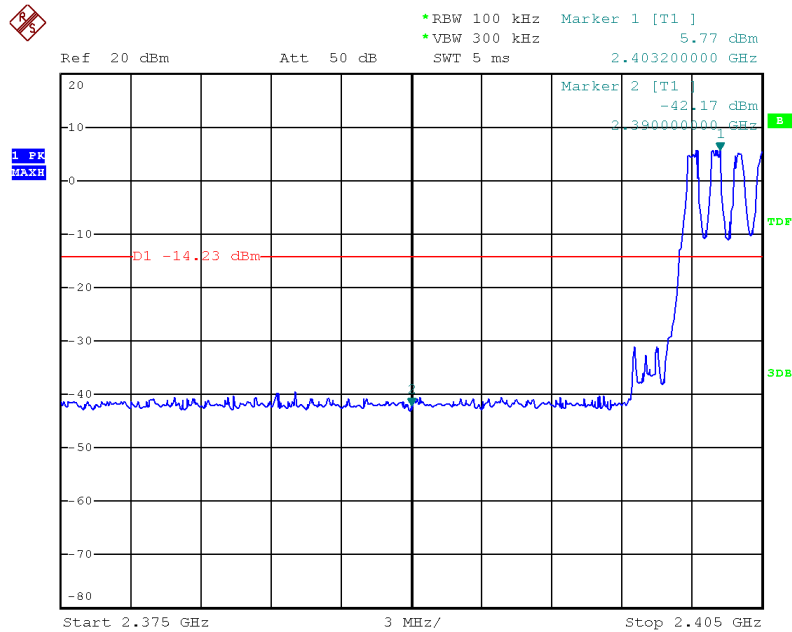

Date: 10.FEB.2020 16:32:00

Test Mode : Hopping Mode BDR 2480 MHz Band Edge

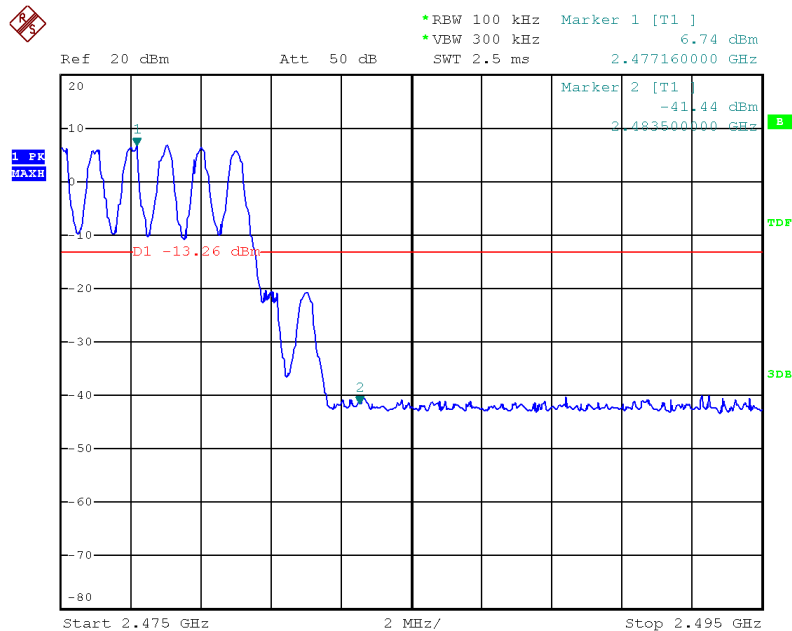

Date: 10.FEB.2020 16:30:48

Test Mode : EDR 2402 MHz Band Edge

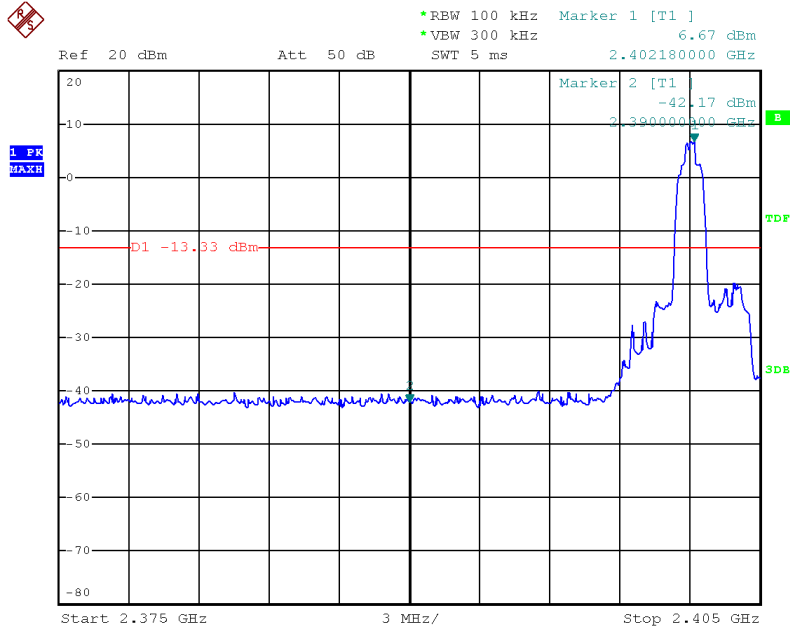

Date: 11.FEB.2020 15:27:31

Test Mode : EDR 2480 MHz Band Edge

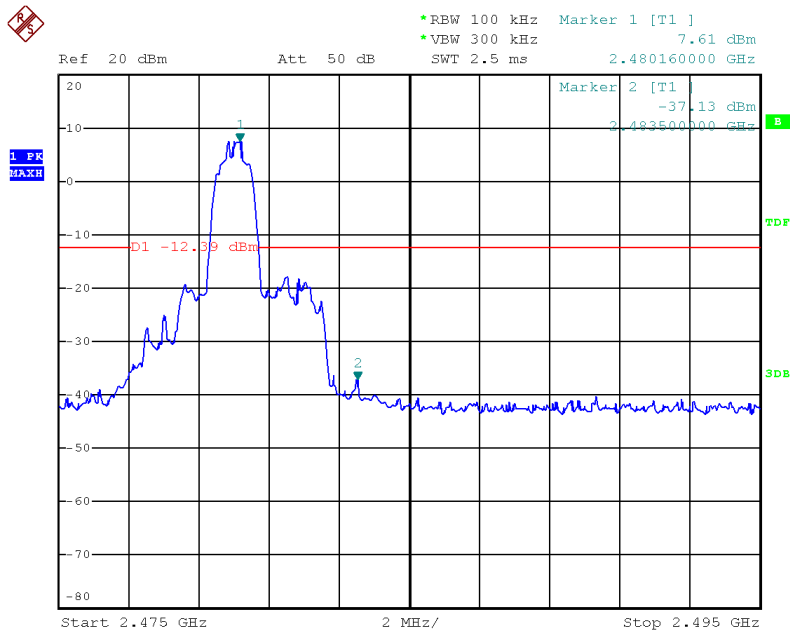

Date: 11.FEB.2020 15:28:32

Test Mode : Hopping Mode EDR 2402 MHz Band Edge

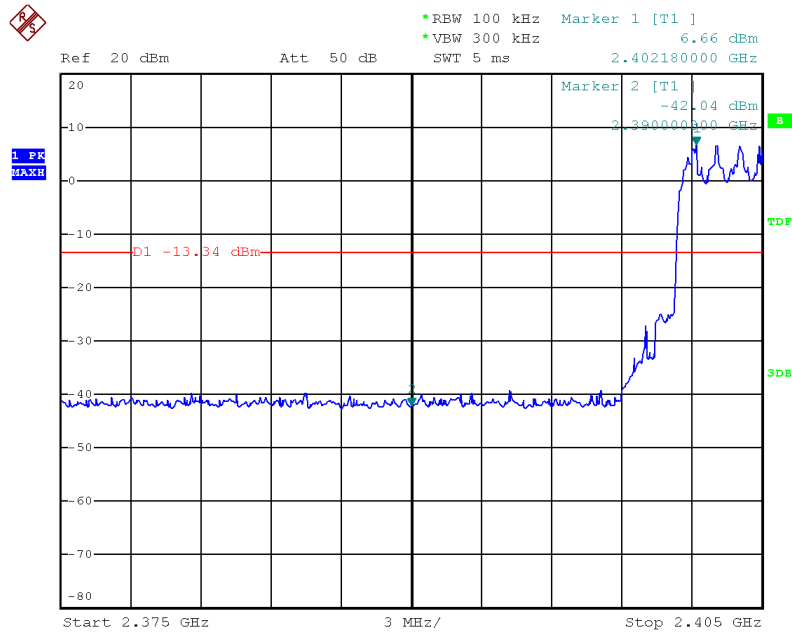

Date: 11.FEB.2020 15:32:25

Test Mode : Hopping Mode EDR 2480 MHz Band Edge

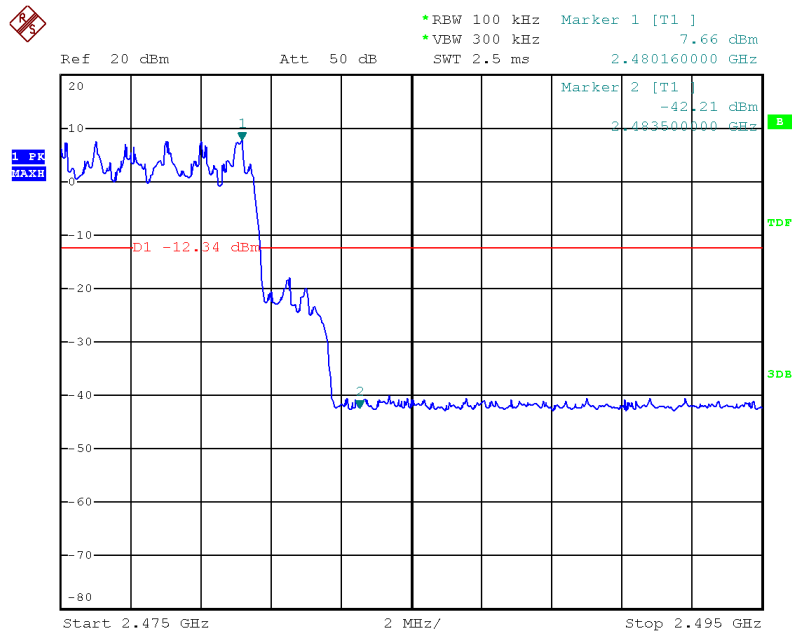

Date: 11.FEB.2020 15:30:30

**[Radiated Band Edges Test]**

**BDR**

Frequency [MHz]	Reading [dB $\mu$ V]	Detector Mode	Factor [dB]	Level [dBuV/m]	Limit [dBuV/m]	Margin [dB]	Pol/Phase
2390	31.14	Peak	-7.65	23.49	73.98	50.49	Hor
2390	31.09	Peak	-7.65	23.44	73.98	50.54	Ver
2483.5	32.45	Peak	-7.28	25.17	73.98	48.81	Hor
2483.5	32.64	Peak	-7.28	25.36	73.98	48.62	Ver

**EDR**

Frequency [MHz]	Reading [dB $\mu$ V]	Detector Mode	Factor [dB]	Level [dBuV/m]	Limit [dBuV/m]	Margin [dB]	Pol/Phase
2390	31.36	Peak	-7.65	23.71	73.98	50.27	Hor
2390	30.59	Peak	-7.65	22.94	73.98	51.04	Ver
2483.5	32.80	Peak	-7.28	25.52	73.98	48.46	Hor
2483.5	33.28	Peak	-7.28	26.00	73.98	47.98	Ver

Note : Factor = Antenna Gain + Cable loss – Amplifier Gain.

## 6.9 Radiated Spurious Emission

### 6.9.1 Test Limit

In any 100 kHz bandwidth outside the intentional radiator frequency band, all harmonics/spurious must be at least 20 dB below the highest emission level within the authorized band. If the output power of this device was measured by spectrum analyzer, the attenuation under this paragraph shall be 30 dB instead of 20 dB. In addition, radiated emissions which fall in the restricted bands must also comply with the FCC section 15.209 limits as below.

Frequency (MHz)	Field Strength (microvolts/meter)	Measurement distance (meters)
0.009-0.490	2400/F(kHz)	300
0.490-1.705	24000/F(kHz)	30
1.705-30.0	30	30
30-88	100	3
88-216	150	3
216-960	200	3

### 6.9.2 Test Procedure

1. The testing follows the guidelines in Spurious Radiated Emissions of FCC Public Notice DA 00-705 Measurement Guidelines.
2. The EUT was placed on a turntable with 0.8 meter for frequency below 1GHz and 1.5 meter for frequency above 1GHz respectively above ground.
3. The EUT was set 3 meters from the interference receiving antenna, which was mounted on the top of a variable height antenna tower.
4. For each suspected emission, the EUT was arranged to its worst case and then tune the Antenna tower (from 1 m to 4 m) and turntable (from 0 degree to 360 degrees) to find the maximum reading. A pre-amp and a high pass filter are used for the test in order to get better signal level to comply with the guidelines.
5. Set to the maximum power setting and enable the EUT transmit continuously.
6. Use the following spectrum analyzer settings:
  - (1) Span shall wide enough to fully capture the emission being measured;
  - (2) Set RBW=100 kHz for  $f < 1$  GHz, RBW=1MHz for  $f > 1$ GHz ; VBW RBW; Sweep = auto; Detector function = peak; Trace = max hold for peak
  - (3) For average measurement: use duty cycle correction factor method per 15.35(c).  
 Duty cycle = On time/100 milliseconds  
 On time =  $N1*L1+N2*L2+...+Nn-1*LNn-1+Nn*Ln$   
 Where N1 is number of type 1 pulses, L1 is length of type 1 pulses, etc.  
 Average Emission Level = Peak Emission Level +  $20*\log(\text{Duty cycle})$
7. Corrected Reading: Antenna Factor + Cable Loss + Read Level - Preamp Factor = Level



### 6.9.3 Test SET-UP (Block Diagram of Configuration)

1. Radiated Emission Test Set-Up, Frequency Below 30 MHz

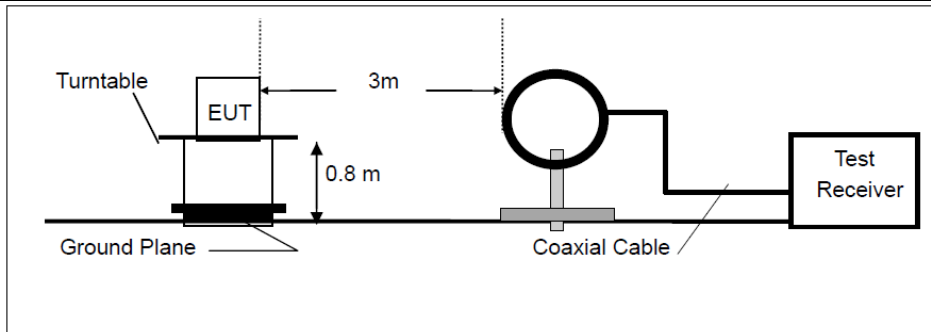

2. Radiated Emission Test Set-Up, Frequency Below 1000 MHz

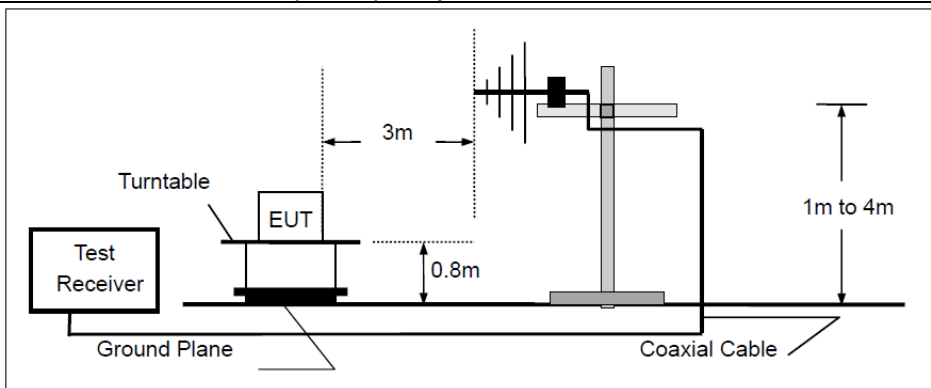

3. Radiated Emission Test Set-Up, Frequency above 1000MHz

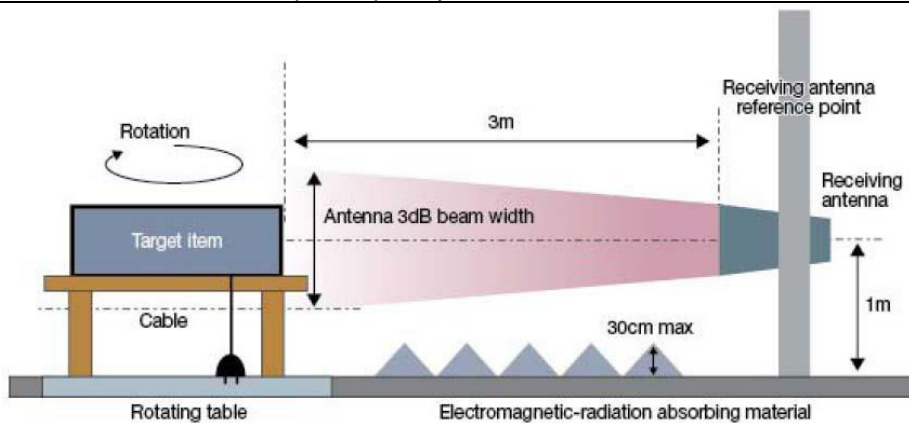

**6.9.4 Test Result**

[Below 30MHz]

Frequency [MHz]	Reading [dB $\mu$ V]	Antenna Factor [dB]	Cable Loss [dB]	Preamp Factor [dB]	Level [dBuV/m]	Poi/Phase
No other emissions were detected at a level greater than 20 dB below limit.						

Remark: §15.31(o)\_The amplitude of spurious emissions from intentional radiators and emissions from unintentional radiators which are attenuated more than 20 dB below the permissible value need not be reported unless specifically required elsewhere in this part.

**[Below 1 GHz – 30 MHz ~ 1 GHz]**

Test Mode : BDR (Worst case : Vertical F2)

Radiated Emission TEST ..test

EUT: BnCOM  
 Manufacturer: Below1GHz-V  
 Operating Condition: BDR-F2

Data: 4 File: C:\Users\user\Desktop\Test Data\이형배\FCC\BnCOM\BDR,EDR,LE,EM6 (79) Date: 2020-02-19 Time: 15:02:17

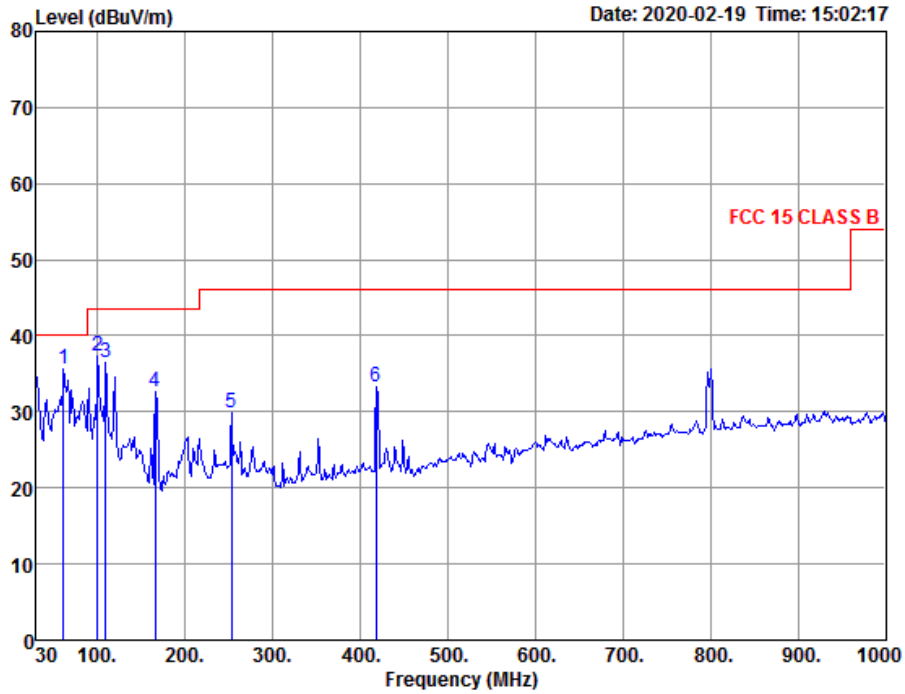

Freq. MHz	AntFac (dB/m)	CabLoss (dB)	Preamp (dB)	Reading (dBuV)	Measured (dBuV/m)	Over (dBuV/m)	Limit (dBuV/m)	Pol/Phase	Remark
61.040	18.29	0.70	37.10	53.77	35.66	-4.34	40.00		Peak
99.840	18.18	0.96	37.10	55.28	37.32	-6.18	43.50		Peak
109.540	17.55	0.93	37.08	55.13	36.53	-6.97	43.50		Peak
165.800	15.00	0.79	36.94	53.76	32.61	-10.89	43.50		Peak
253.100	18.86	0.55	36.72	47.16	29.85	-16.15	46.00		Peak
418.000	22.26	0.82	36.31	46.54	33.31	-12.69	46.00		Peak

Note: 1. Measured Level = Antenna Factor + Cable Loss - Preamp + Reading

Note : Only the worst case plots for Radiated Spurious Emissions.

Test Mode : EDR (Worst case : Vertical F3)

Radiated Emission TEST ..test

EUT: BnCOM  
 Manufacturer: Below 1GHz-V  
 Operating Condition: EDR-F3

Data: 13 File: C:\Users\user\Desktop\Test Data\이형배\FCC\BnCOM\BDR,EDR,LE,EM6 (79)

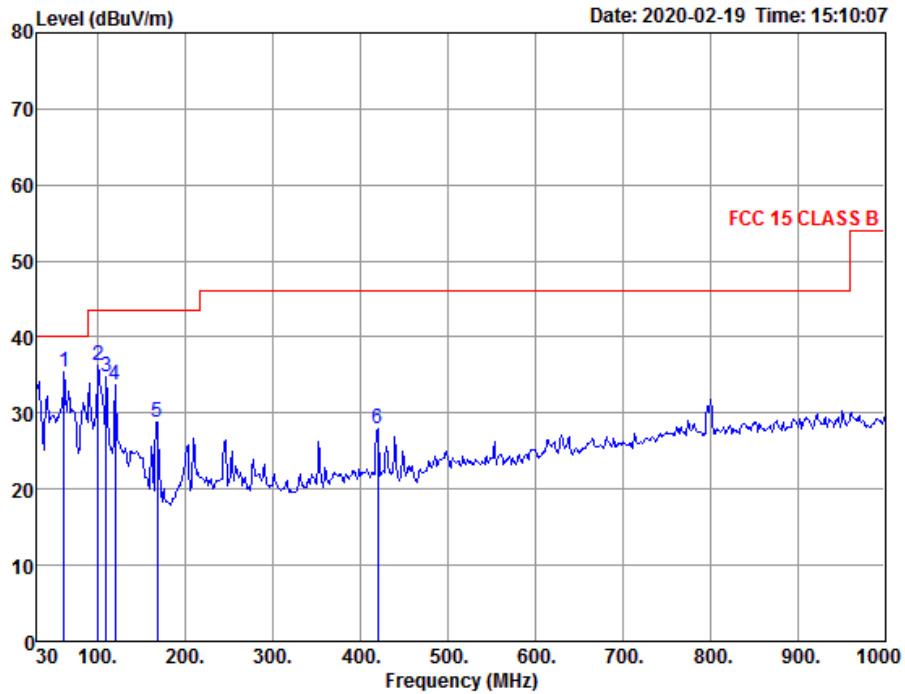

Freq. MHz	AntFac (dB/m)	CabLoss (dB)	Preamp (dB)	Reading (dBuV)	Measured (dBuV/m)	Over (dBuV/m)	Limit (dBuV/m)	Pol/Phase	Remark
61.040	18.29	0.70	37.10	53.61	35.50	-4.50	40.00		Peak
99.840	18.18	0.96	37.10	54.23	36.27	-7.23	43.50		Peak
109.540	17.55	0.93	37.08	53.42	34.82	-8.68	43.50		Peak
119.240	15.98	0.91	37.05	53.82	33.66	-9.84	43.50		Peak
167.740	15.00	0.78	36.93	49.98	28.83	-14.67	43.50		Peak
419.940	22.30	0.83	36.30	41.13	27.96	-18.04	46.00		Peak

Note: 1. Measured Level = Antenna Factor + Cable Loss - Preamp + Reading

Note : Only the worst case plots for Radiated Spurious Emissions.

**[Above 1 GHz – 1 GHz ~ 18 GHz]**

Test Mode : BDR (Worst case : Vertical F3)

Radiated Emission TEST ..test

EUT: BnCOM  
Manufacturer: Above 1GHz-V  
Operating Condition: BDR-F3

Data: 26 File: C:\Users\user\Desktop\Test Data\이형배\FCC\BnCOM\BDR,EDR,LE,EM6 (79)

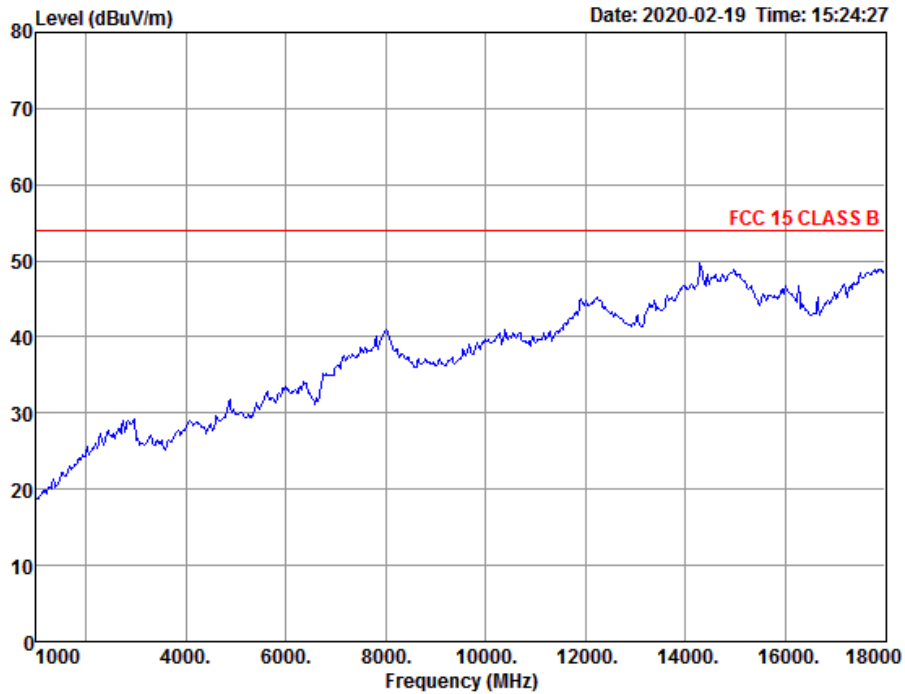

Review: \_\_\_\_\_

Note <sup>(1)</sup> : Only the worst case plots for Radiated Spurious Emissions.

Note <sup>(2)</sup> : No other emissions were detected.

Note <sup>(3)</sup> : A band rejection filter was used for this test.

**[Above 1 GHz – 1 GHz ~ 18 GHz]**

Test Mode : EDR (Worst case : Horizontal F1)

Radiated Emission TEST ..test

EUT: BnCOM  
Manufacturer: Above 1GHz-H  
Operating Condition: EDR-F1

Data: 27 File: C:\Users\user\Desktop\Test Data\이형배\FCC\BnCOM\BDR,EDR,LE,EM6 (79)

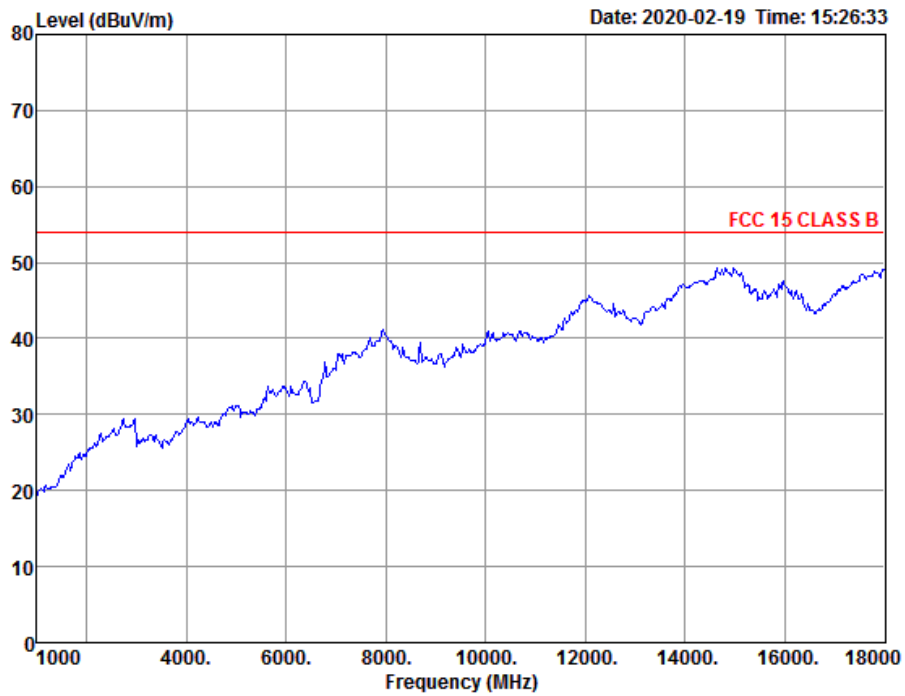

Review: \_\_\_\_\_

Note <sup>(1)</sup> : Only the worst case plots for Radiated Spurious Emissions.

Note <sup>(2)</sup> : No other emissions were detected.

Note <sup>(3)</sup> : A band rejection filter was used for this test.

**[Above 18 GHz – 18 GHz ~ 30 GHz]**

Test Mode : BDR (Worst case : Vertical F3)

Radiated Emission TEST ..test

EUT: BnCOM  
Manufacturer: Above 18GHz-V  
Operating Condition: BDR-F3

Data: 47 File: C:\Users\user\Desktop\Test Data\이형배\FCC\BnCOM\BDR,EDR,LE,EM6 (79)

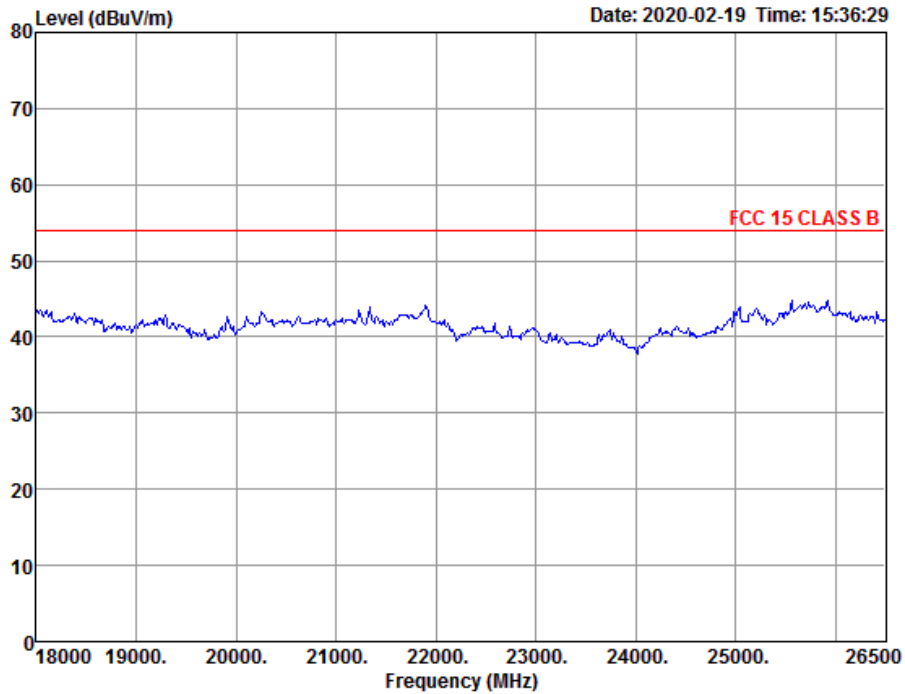

Review: \_\_\_\_\_

Note <sup>(1)</sup> : Only the worst case plots for Radiated Spurious Emissions.

Note <sup>(2)</sup> : No other emissions were detected.

**[Above 18 GHz – 18 GHz ~ 30 GHz]**

Test Mode : BDR (Worst case : Vertical F2)

Radiated Emission TEST ..test

EUT: BnCOM  
Manufacturer: Above 18GHz-V  
Operating Condition: EDR-F2

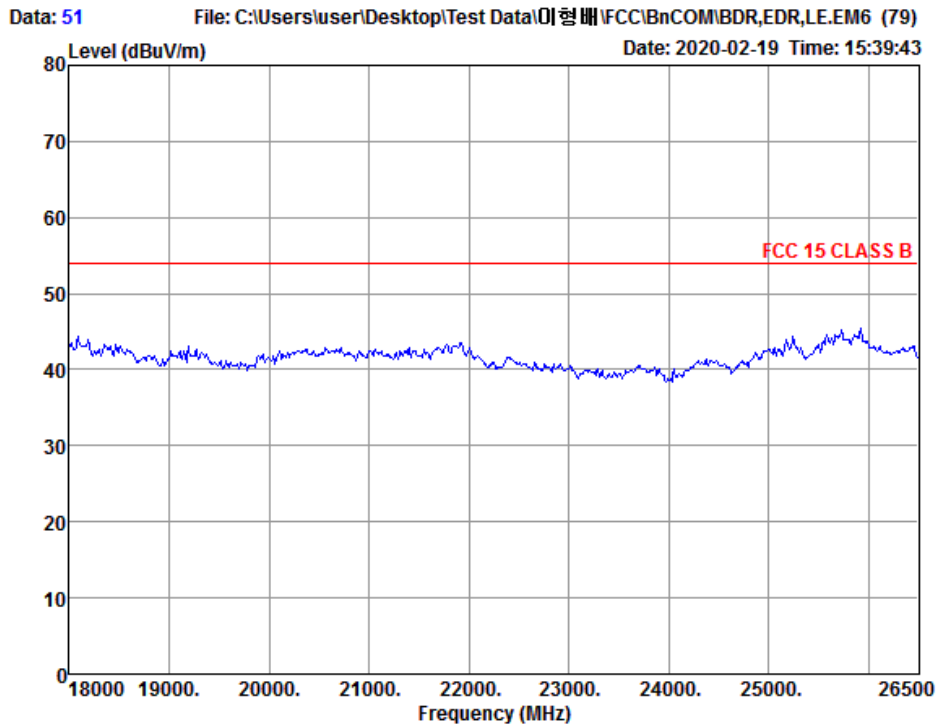

Review: \_\_\_\_\_

Note <sup>(1)</sup> : Only the worst case plots for Radiated Spurious Emissions.

Note <sup>(2)</sup> : No other emissions were detected.



## 6.10 Antenna Application

### 6.10.1 Antenna Requirement

According to §15.203, an intentional radiator shall be designed to ensure that no antenna other than that furnished by the responsible party shall be used with the device.

And according to §15.247 (b), if transmitting antennas of directional gain greater than 6dBi are used, the power shall be reduced by the amount in dB that the directional gain of the antenna exceeds 6dBi.

### 6.10.2 Test Results

Antenna Type	Frequency	Antenna Gain	Limit	Result
PCB Pattern Antenna	2.455 GHz	-0.63 dBi	≤ 6 dBi	Pass

## Annex A. Test setup photos



AC Conducted (1)

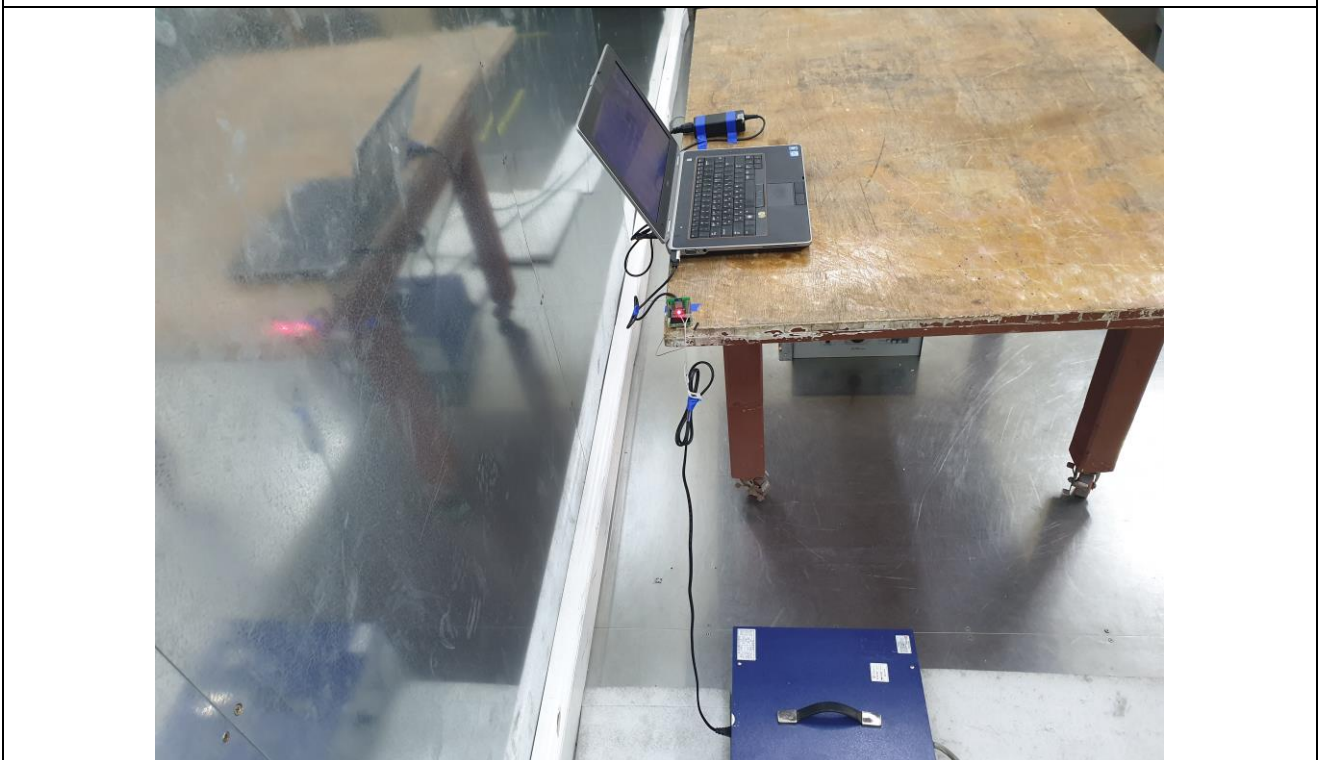

AC Conducted (2)



Below 1 GHz



Above 1 GHz

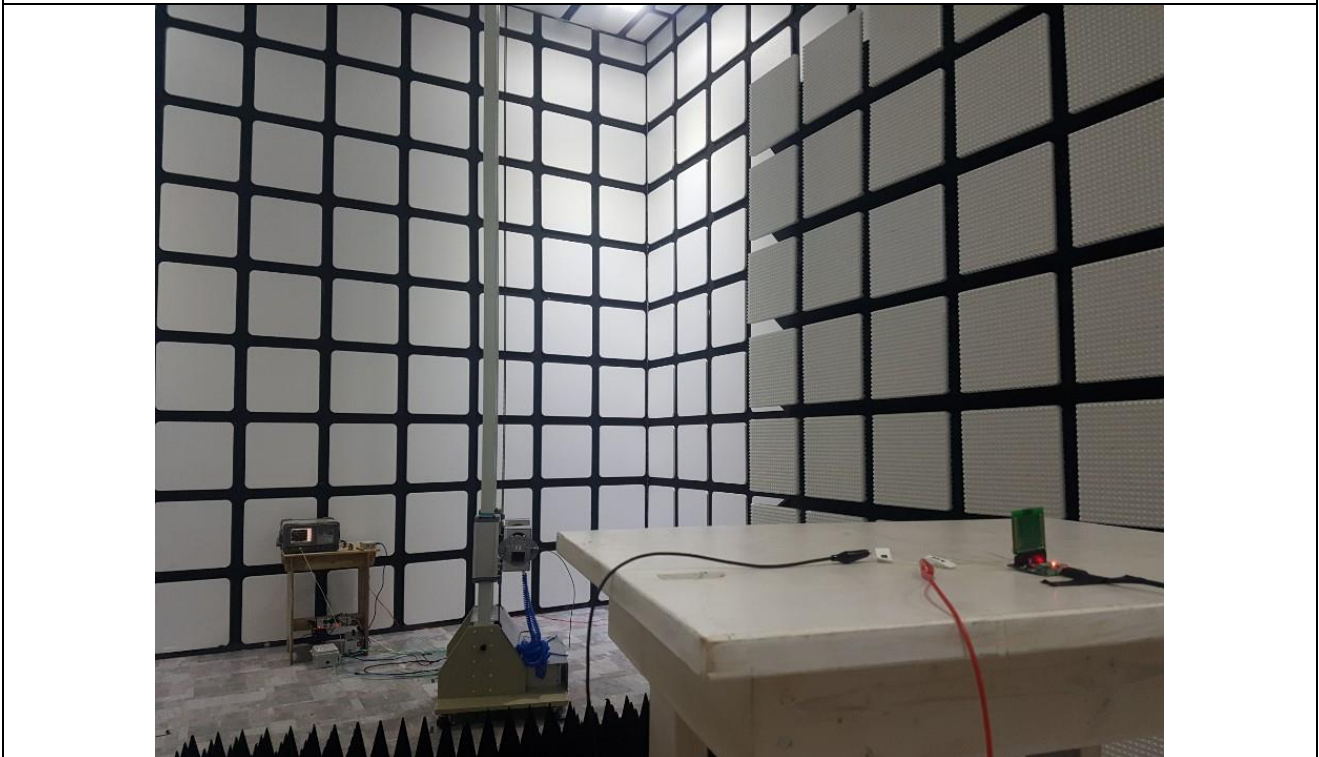

Above 18 GHz



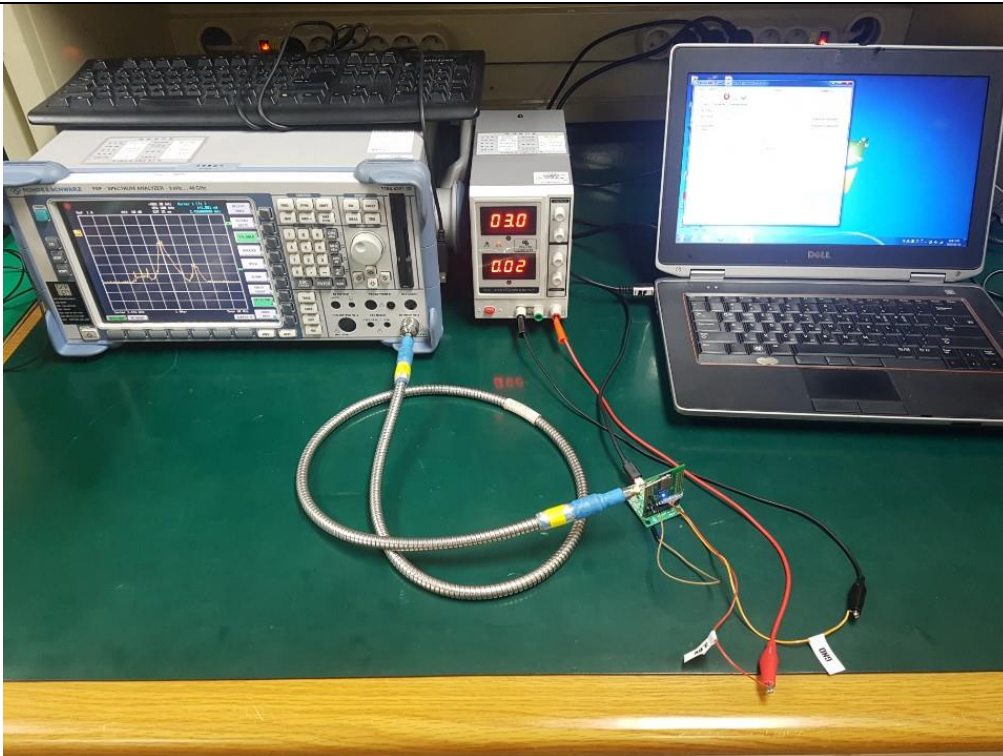

Conducted (1)

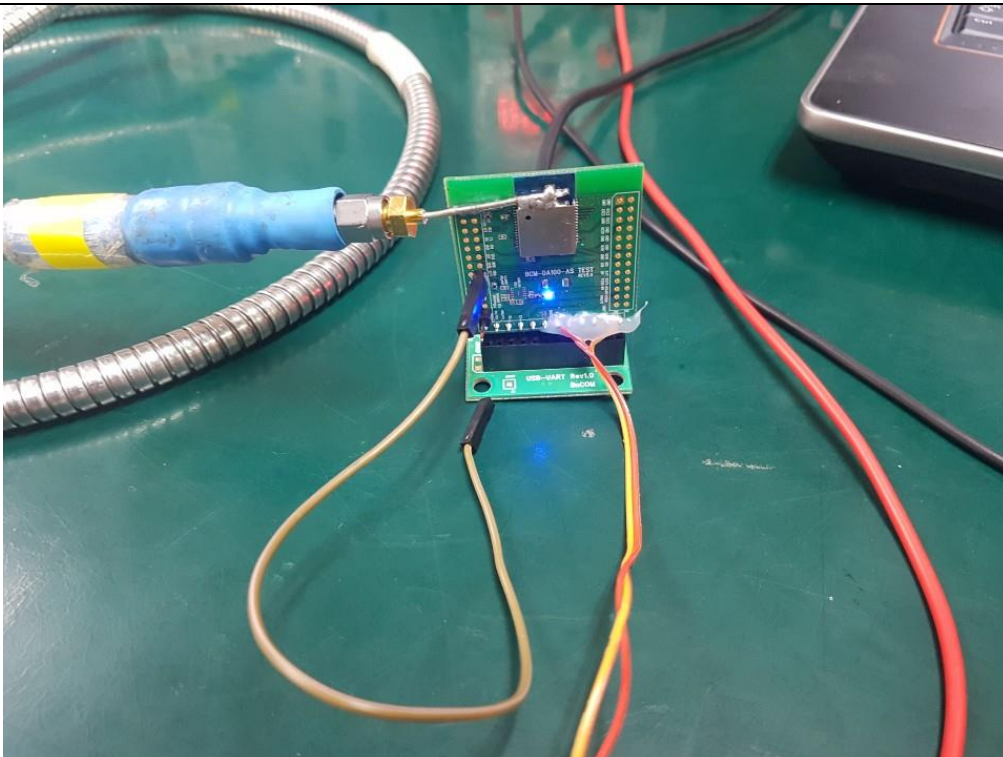

Conducted (2)