

# FCC Radio Test Report

## FCC ID: 2APD7-XYTAR9820F12

### Original Grant

**Report No.** : TB-FCC167229  
**Applicant** : Shenzhen Golden Vision Technology Development Co.,Ltd  
**Equipment Under Test (EUT)**  
**EUT Name** : Smart Camera  
**Model No.** : XY/TA-R9820-F12  
**Series Model No.** : see the page 6  
**Brand Name** : ----  
**Receipt Date** : 2019-07-09  
**Test Date** : 2019-07-10 to 2019-07-22  
**Issue Date** : 2019-07-23  
**Standards** : FCC Part 15, Subpart C (15.247:2018)  
**Test Method** : ANSI C63.10: 2013  
**Conclusions** : **PASS**

In the configuration tested, the EUT complied with the standards specified above,  
The EUT technically complies with the FCC and IC requirements

**Test/Witness Engineer** : *Jason Xu* Jason Xu  
**Engineer Supervisor** : *Ivan Su* Ivan Su  
**Engineer Manager** : *Ray Lai* Ray Lai

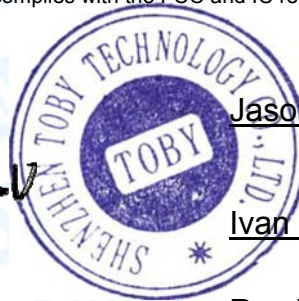

This report details the results of the testing carried out on one sample. The results contained in this test report do not relate to other samples of the same product. The manufacturer should ensure that all products in series production are in conformity with the product sample detailed in the report.

## Contents

<b>CONTENTS</b> .....	<b>2</b>
<b>1. GENERAL INFORMATION ABOUT EUT</b> .....	<b>5</b>
1.1 Client Information.....	5
1.2 General Description of EUT (Equipment Under Test) .....	5
1.3 Block Diagram Showing the Configuration of System Tested.....	6
1.4 Description of Support Units .....	6
1.5 Description of Test Mode.....	7
1.6 Description of Test Software Setting .....	8
1.7 Measurement Uncertainty .....	8
1.8 Test Facility.....	9
<b>2. TEST SUMMARY</b> .....	<b>10</b>
<b>3. TEST EQUIPMENT</b> .....	<b>11</b>
<b>4. CONDUCTED EMISSION TEST</b> .....	<b>12</b>
4.1 Test Standard and Limit.....	12
4.2 Test Setup.....	12
4.3 Test Procedure.....	12
4.4 EUT Operating Mode .....	13
4.5 Test Data.....	13
<b>5. RADIATED EMISSION TEST</b> .....	<b>14</b>
5.1 Test Standard and Limit.....	14
5.2 Test Setup.....	15
5.3 Test Procedure.....	16
5.4 EUT Operating Condition .....	16
5.5 Test Data.....	17
<b>6. RESTRICTED BANDS REQUIREMENT</b> .....	<b>18</b>
6.1 Test Standard and Limit.....	18
6.2 Test Setup.....	18
6.3 Test Procedure.....	18
6.4 EUT Operating Condition .....	19
6.5 Test Data.....	19
<b>7. BANDWIDTH TEST</b> .....	<b>20</b>
7.1 Test Standard and Limit.....	20
7.2 Test Setup.....	20
7.3 Test Procedure.....	20
7.4 EUT Operating Condition .....	20
7.5 Test Data.....	20
<b>8. PEAK OUTPUT POWER TEST</b> .....	<b>21</b>
8.1 Test Standard and Limit.....	21

8.2 Test Setup.....	21
8.3 Test Procedure.....	21
8.4 EUT Operating Condition .....	21
8.5 Test Data.....	21
<b>9. POWER SPECTRAL DENSITY TEST .....</b>	<b>22</b>
9.1 Test Standard and Limit.....	22
9.2 Test Setup.....	22
9.3 Test Procedure.....	22
9.4 EUT Operating Condition .....	22
9.5 Test Data.....	22
<b>10. ANTENNA REQUIREMENT.....</b>	<b>23</b>
10.1 Standard Requirement.....	23
10.2 Antenna Connected Construction.....	23
<b>ATTACHMENT A-- CONDUCTED EMISSION TEST DATA .....</b>	<b>24</b>
<b>ATTACHMENT C-- RESTRICTED BANDS &amp; BAND-EDGE REQUIREMENT TEST DATA.</b>	<b>41</b>
<b>ATTACHMENT D-- BANDWIDTH TEST DATA.....</b>	<b>61</b>
<b>ATTACHMENT E-- PEAK OUTPUT POWER TEST DATA.....</b>	<b>69</b>
<b>ATTACHMENT F-- POWER SPECTRAL DENSITY TEST DATA.....</b>	<b>72</b>

## Revision History

Report No.	Version	Description	Issued Date
TB-FCC167229	Rev.01	Initial issue of report	2019-07-23

# 1. General Information about EUT

## 1.1 Client Information

<b>Applicant</b>	:	Shenzhen Golden Vision Technology Development Co.,Ltd
<b>Address</b>	:	No.6 Baofu Road, Baolai industrial Park, Shang mu gu Village, Pinghu Longgang District, Shenzhen, China
<b>Manufacturer</b>	:	Shenzhen Golden Vision Technology Development Co.,Ltd
<b>Address</b>	:	No.6 Baofu Road, Baolai industrial Park, Shang mu gu Village, Pinghu Longgang District, Shenzhen, China

## 1.2 General Description of EUT (Equipment Under Test)

<b>EUT Name</b>	:	Smart Camera	
<b>Models No.</b>	:	XY/TA-R9820-F12, see the page 6	
<b>Model Difference</b>	:	All these models are the same PCB, layout and electrical circuit, the only difference is product appearance.	
<b>Product Description</b>	:	Operation Frequency:	802.11b/g/n(HT20): 2412MHz~2462MHz 802.11n(HT40): 2422MHz~2452MHz
		Number of Channel:	802.11b/g/n(HT20):11 channels see note(3) 802.11b/g/n(HT40):7 channels see note(3)
		RF Output Power:	802.11b: 9.42dBm 802.11g: 8.39dBm 802.11n (HT20): 8.25dBm 802.11n (HT40): 7.41dBm
		Antenna Gain:	3dBi PCB Antenna
<b>Power Supply</b>	:	DC Voltage supplied by AC/DC adapter	
<b>Power Rating</b>	:	Input: DC5V 1A	
<b>Software Version</b>	:	90A /V5.1.34	
<b>Hardware Version</b>	:	V1.5	
<b>Connecting I/O Port(S)</b>	:	Please refer to the User's Manual	

**Note:**

- (1) This Test Report is FCC Part 15.247 for 802.11b/g/n, the test procedure follows the FCC KDB 558074 D01 DTS Meas Guidance v05.

(2) For a more detailed features description, please refer to the manufacturer's specifications or the User's Manual.

(3) Channel List:

Channel	Frequency (MHz)	Channel	Frequency (MHz)	Channel	Frequency (MHz)
01	2412	05	2432	09	2452
02	2417	06	2437	10	2457
03	2422	07	2442	11	2462
04	2427	08	2447		

Note: CH 01~CH 11 for 802.11b/g/n(HT20)  
CH 03~CH 9 for 802.11n(HT40)

(4) The Antenna information about the equipment is provided by the applicant.

(5) Model

Model(s)			
XY/TA-R9820-F11,	XY/TA-R9820-F13,	XY/TA-R9820-F14,	XY/TA-R9820-K7,
XY/TA-R9820-K8,	XY/TA-R9820-K9,	XY/TA-R9820-K10,	XY/TA-R9820-Q11,
IPC-A3610-A111,	IPC/TA-A3610-XHR,	XY/TA-R9520-V8,	XY/TA-R9520-V9,
IPC-R9520-V7,	TA-A3410-R6,	IPC-C3310-R7,	XY-W102R,
TA-R9522-AFD		TA-FD-BL6,	TA-FD-BL7,

### 1.3 Block Diagram Showing the Configuration of System Tested

#### USB Charging Mode

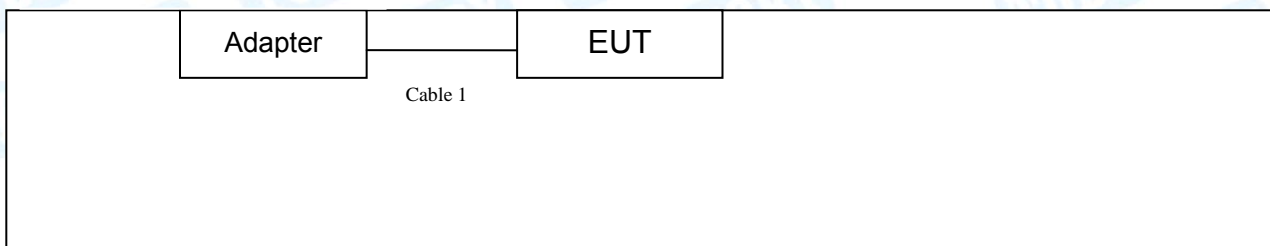

### 1.4 Description of Support Units

Equipment Information				
Name	Model	FCC ID/VOC	Manufacturer	Used “√”
ADAPTER	TPA-46B050100UU	---	/	√
Cable Information				
Number	Shielded Type	Ferrite Core	Length	Note
Cable 1	NO	NO	2.0M	Accessory

## 1.5 Description of Test Mode

To investigate the maximum EMI emission characteristics generates from EUT, the test system was pre-scanning tested base on the consideration of following EUT operation mode or test configuration mode which possible have effect on EMI emission level. Each of these EUT operation mode(s) or test configuration mode(s) mentioned follow was evaluated respectively.

For Conducted Test	
Final Test Mode	Description
Mode 1	USB Charging with TX G Mode Channel 06
For Radiated Test	
Final Test Mode	Description
Mode 2	TX Mode B Mode Channel 01/06/11
Mode 3	TX Mode G Mode Channel 01/06/11
Mode 4	TX Mode N(HT20) Mode Channel 01/06/11
Mode 5	TX Mode N(HT40) Mode Channel 03/06/09
<b>Remark: One electronic material suppliers are different, such as display screen.</b>	

### Note:

- (1) For all test, we have verified the construction and function in typical operation. And all the test modes were carried out with the EUT in transmitting operation in maximum power with all kinds of data rate.  
According to ANSI C63.10 standards, the measurements are performed at the highest, Middle, lowest available channels, and the worst case data rate as follows:
  - 802.11b Mode: CCK (1 Mbps)
  - 802.11g Mode: OFDM (6 Mbps)
  - 802.11n (HT20) Mode: MCS 0 (6.5 Mbps)
  - 802.11n (HT40) Mode: MCS 0 (13 Mbps)
- (2) During the testing procedure, the continuously transmitting with the maximum power mode was programmed by the customer.
- (3) The EUT is considered a portable unit; in normal use it was positioned on X-plane. The worst case was found positioned on X-plane. Therefore only the test data of this X-plane was used for radiated emission measurement test.

## 1.6 Description of Test Software Setting

During testing channel&Power controlling software provided by the customer was used to control the operating channel as well as the output power level. The RF output power selection is for the setting of RF output power expected by the customer and is going to be fixed on the firmware of the final end product power parameters of WLAN.

Test Software Version	REALTEK 11n 8188FU USB WLAN NIC Massproduction Kit.exe		
Channel	CH 01	CH 06	CH 11
IEEE 802.11b DSSS	30	30	30
IEEE 802.11g OFDM	25	25	27
IEEE 802.11n (HT20)	25	25	27
Test Software Version	SP_META.exe		
Channel	CH 03	CH 06	CH 09
IEEE 802.11n (HT40)	25	25	27

## 1.7 Measurement Uncertainty

The reported uncertainty of measurement  $y \pm U$ , where expanded uncertainty  $U$  is based on a standard uncertainty multiplied by a coverage factor of  $k=2$ , providing a level of confidence of approximately 95 %.

Test Item	Parameters	Expanded Uncertainty ( $U_{Lab}$ )
Conducted Emission	Level Accuracy: 9kHz~150kHz	$\pm 3.42$ dB
	150kHz to 30MHz	$\pm 3.42$ dB
Radiated Emission	Level Accuracy: 9kHz to 30 MHz	$\pm 4.60$ dB
Radiated Emission	Level Accuracy: 30MHz to 1000 MHz	$\pm 4.40$ dB
Radiated Emission	Level Accuracy: Above 1000MHz	$\pm 4.20$ dB



## 1.8 Test Facility

The testing report were performed by the Shenzhen Toby Technology Co., Ltd., in their facilities located at 1A/F., Bldg.6, Yusheng Industrial Zone, The National Road No.107 Xixiang Section 467, Xixiang, Bao'an, Shenzhen, Guangdong, China. At the time of testing, the following bodies accredited the Laboratory:

### **CNAS (L5813)**

The Laboratory has been accredited by CNAS to ISO/IEC 17025: 2005 General Requirements for the Competence of Testing and Calibration Laboratories for the competence in the field of testing. And the Registration No.: CNAS L5813.

### **A2LA Certificate No.: 4750.01**

The laboratory has been accredited by American Association for Laboratory Accreditation(A2LA) to ISO/IEC 17025: 2005 General Requirements for the Competence of Testing and Calibration Laboratories for the technical competence in the field of Electrical Testing. And the A2LA Certificate No.: 4750.01.

### **IC Registration No.: (11950A-1)**

The Laboratory has been registered by Certification and Engineering Bureau of Industry Canada for radio equipment testing. The site registration: Site# 11950A-1.

## 2. Test Summary

FCC Part 15 Subpart C(15.247)/ RSS 247 Issue 2				
Standard Section		Test Item	Judgment	Remark
FCC	IC			
15.203	/	Antenna Requirement	PASS	N/A
15.207	RSS-GEN 7.2.4	Conducted Emission	PASS	N/A
15.205	RSS-GEN 7.2.2	Restricted Bands	PASS	N/A
15.247(a)(2)	RSS 247 5.2 (1)	6dB Bandwidth	PASS	N/A
15.247(b)	RSS 247 5.4 (4)	Peak Output Power	PASS	N/A
15.247(e)	RSS 247 5.2 (2)	Power Spectral Density	PASS	N/A
15.247(d)	RSS 247 5.5	Band Edge	PASS	N/A
15.247(d)& 15.209	RSS 247 5.5	Transmitter Radiated Spurious Emission	PASS	N/A

**Note:** “/” for no requirement for this test item.  
N/A is an abbreviation for Not Applicable.

### 3. Test Equipment

Conducted Emission Test					
Equipment	Manufacturer	Model No.	Serial No.	Last Cal.	Cal. Due Date
EMI Test Receiver	Rohde & Schwarz	ESCI	100321	Jul. 13, 2019	Jul. 12, 2020
RF Switching Unit	Compliance Direction Systems Inc	RSU-A4	34403	Jul. 13, 2019	Jul. 12, 2020
AMN	SCHWARZBECK	NNBL 8226-2	8226-2/164	Jul. 13, 2019	Jul. 12, 2020
LISN	Rohde & Schwarz	ENV216	101131	Jul. 13, 2019	Jul. 12, 2020
Radiation Emission Test					
Equipment	Manufacturer	Model No.	Serial No.	Last Cal.	Cal. Due Date
Spectrum Analyzer	Agilent	E4407B	MY45106456	Jul. 13, 2019	Jul. 12, 2020
EMI Test Receiver	Rohde & Schwarz	ESPI	100010/007	Jul. 13, 2019	Jul. 12, 2020
Bilog Antenna	ETS-LINDGREN	3142E	00117537	Jan. 27, 2019	Jan. 26, 2020
Bilog Antenna	ETS-LINDGREN	3142E	00117542	Jan. 27, 2019	Jan. 26, 2020
Horn Antenna	ETS-LINDGREN	3117	00143207	Mar.03, 2019	Mar. 02, 2020
Horn Antenna	ETS-LINDGREN	3117	00143209	Mar.03, 2019	Mar. 02, 2020
Loop Antenna	SCHWARZBECK	FMZB 1519 B	1519B-059	Jul. 13, 2019	Jul. 12, 2020
Pre-amplifier	Sonoma	310N	185903	Mar.04, 2019	Mar. 03, 2020
Pre-amplifier	HP	8449B	3008A00849	Mar.03, 2019	Mar. 02, 2020
Cable	HUBER+SUHNER	100	SUCOFLEX	Mar.03, 2019	Mar. 02, 2020
Positioning Controller	ETS-LINDGREN	2090	N/A	N/A	N/A
Antenna Conducted Emission					
Equipment	Manufacturer	Model No.	Serial No.	Last Cal.	Cal. Due Date
Spectrum Analyzer	Agilent	E4407B	MY45106456	Jul. 13, 2019	Jul. 12, 2020
Spectrum Analyzer	Rohde & Schwarz	ESCI	100010/007	Jul. 13, 2019	Jul. 12, 2020
MXA Signal Analyzer	Agilent	N9020A	MY49100060	Sep. 15, 2018	Sep. 14, 2019
Vector Signal Generator	Agilent	N5182A	MY50141294	Sep. 15, 2018	Sep. 14, 2019
Analog Signal Generator	Agilent	N5181A	MY50141953	Sep. 15, 2018	Sep. 14, 2019
RF Power Sensor	DARE!! Instruments	RadiPowerRPR3006W	17I00015SNO26	Sep. 15, 2018	Sep. 14, 2019
	DARE!! Instruments	RadiPowerRPR3006W	17I00015SNO29	Sep. 15, 2018	Sep. 14, 2019
	DARE!! Instruments	RadiPowerRPR3006W	17I00015SNO31	Sep. 15, 2018	Sep. 14, 2019
	DARE!! Instruments	RadiPowerRPR3006W	17I00015SNO33	Sep. 15, 2018	Sep. 14, 2019

## 4. Conducted Emission Test

### 4.1 Test Standard and Limit

#### 4.1.1 Test Standard

FCC Part 15.207

#### 4.1.2 Test Limit

**Conducted Emission Test Limit**

Frequency	Maximum RF Line Voltage (dB $\mu$ V)	
	Quasi-peak Level	Average Level
150kHz~500kHz	66 ~ 56 *	56 ~ 46 *
500kHz~5MHz	56	46
5MHz~30MHz	60	50

Notes:

(1) \*Decreasing linearly with logarithm of the frequency.

(2) The lower limit shall apply at the transition frequencies.

(3) The limit decrease in line with the logarithm of the frequency in the range of 0.15 to 0.50MHz.

### 4.2 Test Setup

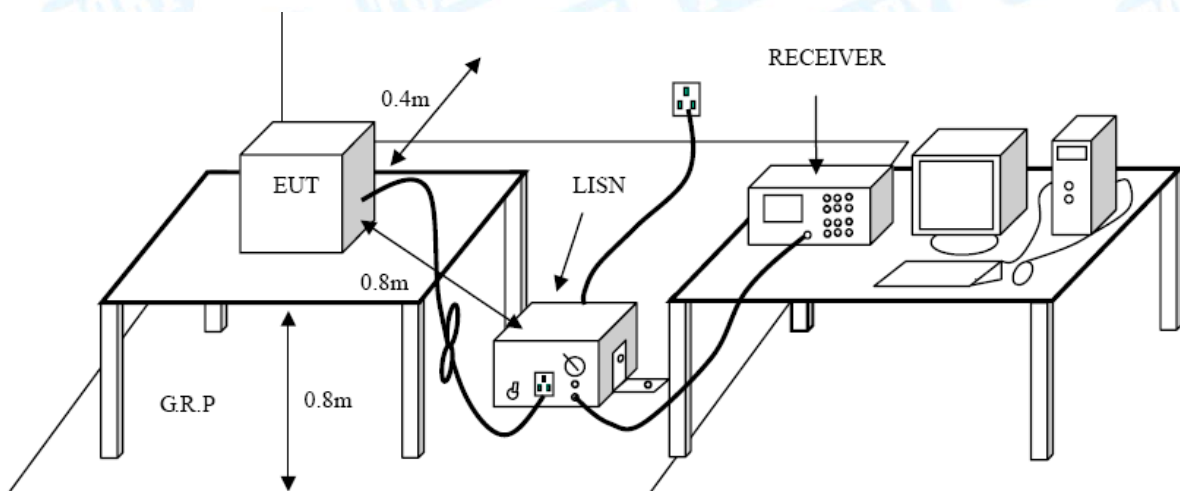

### 4.3 Test Procedure

The EUT was placed 0.8 meters from the horizontal ground plane with EUT being connected to the power mains through a line impedance stabilization network (LISN). All other support equipments powered from additional LISN(s). The LISN provide 50 Ohm/ 50uH of coupling impedance for the measuring instrument.

Interconnecting cables that hang closer than 40 cm to the ground plane shall be folded back and forth in the center forming a bundle 30 to 40 cm long.

I/O cables that are not connected to a peripheral shall be bundled in the center. The end of the cable may be terminated, if required, using the correct terminating impedance. The overall length shall not exceed 1 m.

LISN at least 80 cm from nearest part of EUT chassis.

The bandwidth of EMI test receiver is set at 9kHz, and the test frequency band is from 0.15MHz to 30MHz.

#### 4.4 EUT Operating Mode

Please refer to the description of test mode.

#### 4.5 Test Data

Please refer to the Attachment A.

## 5. Radiated Emission Test

### 5.1 Test Standard and Limit

5.1.1 Test Standard  
FCC Part 15.209

5.1.2 Test Limit

#### Radiated Emission Limits ( 9 kHz~1000 MHz)

Frequency (MHz)	Field Strength (microvolt/meter)	Measurement Distance (meters)
0.009~0.490	2400/F(KHz)	300
0.490~1.705	24000/F(KHz)	30
1.705~30.0	30	30
30~88	100	3
88~216	150	3
216~960	200	3
Above 960	500	3

#### Radiated Emission Limit (Above 1000MHz)

Frequency (MHz)	Distance of 3m (dBuV/m)	
	Peak	Average
Above 1000	74	54

**Note:**

- (1) The tighter limit applies at the band edges.
- (2) Emission Level(dBuV/m)=20log Emission Level(uV/m)

5.2 Test Setup

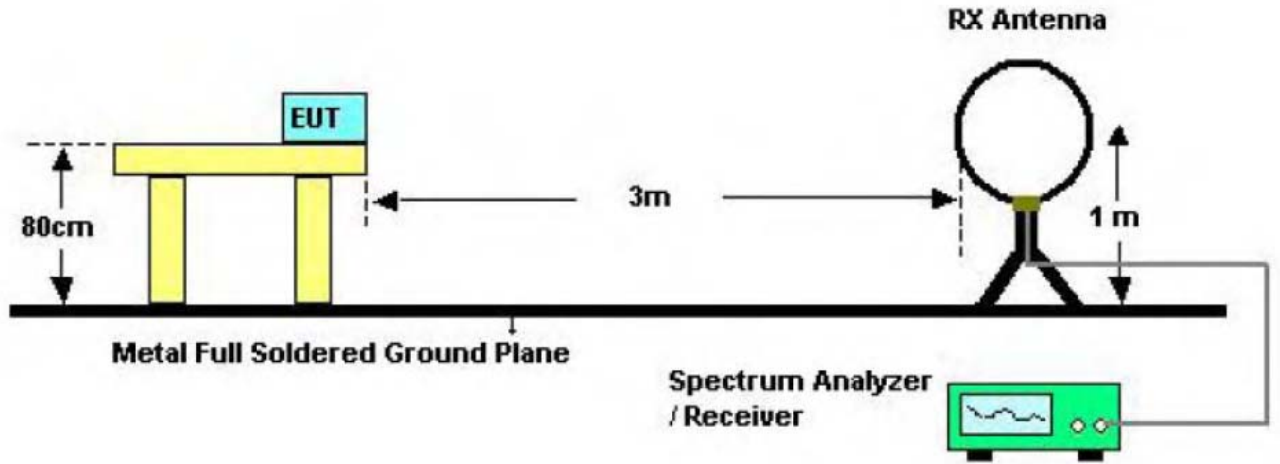

Below 30MHz Test Setup

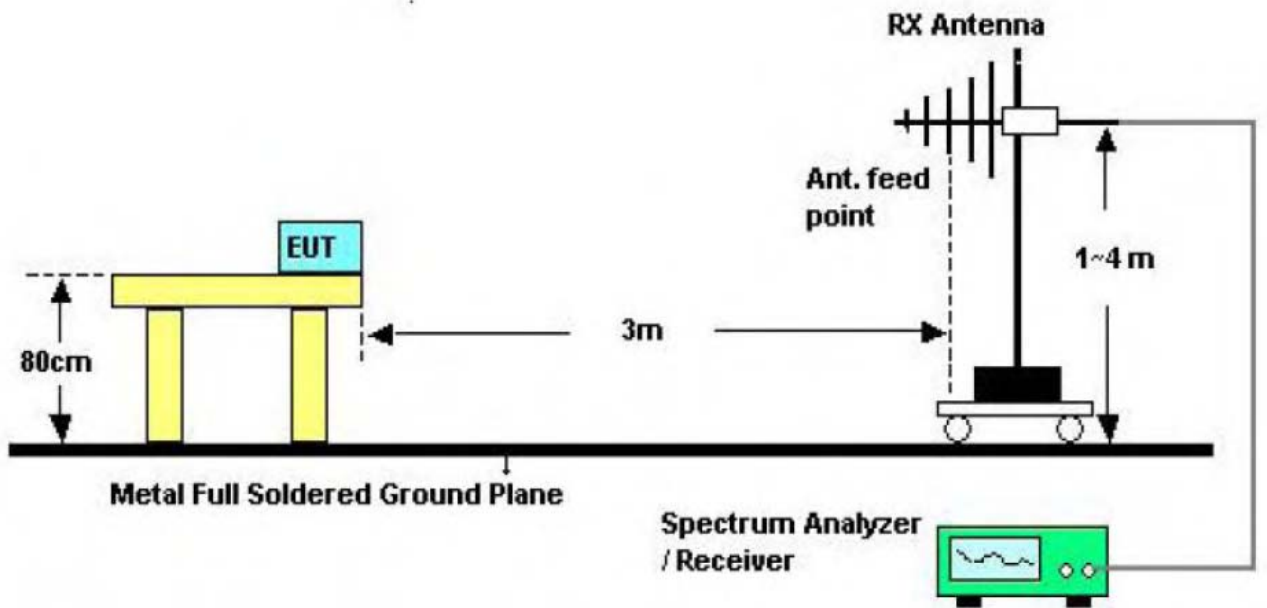

Below 1000MHz Test Setup



Above 1GHz Test Setup

### 5.3 Test Procedure

- (1) Measurements at frequency above 1GHz. The EUT was placed on a rotating 1.5m high above the ground. RF absorbers covered the ground plane with a minimum area of 3.0m by 3.0m between the EUT and measurement receiver antenna. The RF absorber shall not exceed 30cm in high above the conducting floor. The table was rotated 360 degrees to determine the position of the highest radiation.
- (2) The Test antenna shall vary between 1m and 4m, Both Horizontal and Vertical antenna are set to make measurement.
- (3) The initial step in collecting conducted emission data is a spectrum analyzer peak detector mode pre-scanning the measurement frequency range. Significant peaks are then marked and then Quasi Peak detector mode re-measured.
- (4) If the Peak Mode measured value compliance with and lower than Quasi Peak Mode Limit Bellow 1 GHz, the EUT shall be deemed to meet QP Limits and then no additional QP Mode measurement performed. But the Peak Value and average value both need to comply with applicable limit above 1 GHz.
- (5) Testing frequency range below 1GHz the measuring instrument use VBW=120 kHz with Quasi-peak detection.
- (6) Testing frequency range above 1GHz the measuring instrument use RBW=1 MHz and VBW=3 MHz with Peak Detector for Peak Values, and use RBW=1 MHz and VBW=10 Hz with Peak Detector for Average Values.
- (7) For the actual test configuration, please see the test setup photo.

### 5.4 EUT Operating Condition

The Equipment Under Test was set to Continual Transmitting in maximum power.



## 5.5 Test Data

Remark: During testing above 1GHz the measuring instrument use RBW=1 MHz and VBW=3 MHz with Peak Detector for Peak Values, and use RBW=1 MHz and VBW=10 Hz with Peak Detector for Average Values.

Please refer to the Attachment B.

## 6. Restricted Bands Requirement

### 6.1 Test Standard and Limit

- 6.1.1 Test Standard
  - FCC Part 15.247(d)
  - FCC Part 15.209
  - FCC Part 15.205

#### 6.1.2 Test Limit

Restricted Frequency Band (MHz)	Distance of 3m (dBuV/m)	
	Peak	Average
2310 ~2390	74	54
2483.5 ~2500	74	54

### 6.2 Test Setup

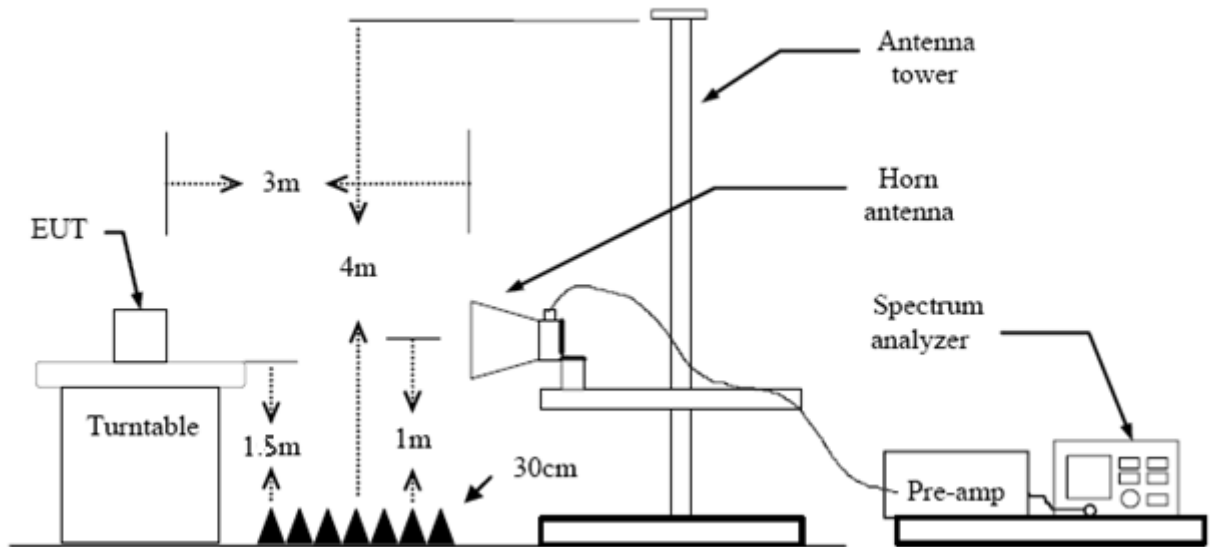

### 6.3 Test Procedure

- (1) The measuring distance of 3m shall be used for measurements at frequency below 1GHz and above 1 GHz. The EUT was placed on a rotating 0.8m high above ground, the table was rotated 360 degrees to determine the position of the highest radiation.
- (2) Measurements at frequency above 1GHz. The EUT was placed on a rotating 1.5m high above the ground. RF absorbers covered the ground plane with a minimum area of 3.0m by 3.0m between the EUT and measurement receiver antenna. The RF absorber shall not exceed 30cm in high above the conducting floor. The table was rotated 360 degrees to determine the position of the highest radiation.

- (3) The Test antenna shall vary between 1m and 4m, Both Horizontal and Vertical antenna are set to make measurement.
- (4) The initial step in collecting conducted emission data is a spectrum analyzer peak detector mode pre-scanning the measurement frequency range. Significant peaks are then marked and then Quasi Peak detector mode re-measured.
- (5) If the Peak Mode measured value compliance with and lower than Quasi Peak Mode Limit Bellow 1 GHz, the EUT shall be deemed to meet QP Limits and then no additional QP Mode measurement performed. But the Peak Value and average value both need to comply with applicable limit above 1 GHz.
- (6) Testing frequency range below 1GHz the measuring instrument use VBW=120 kHz with Quasi-peak detection.
- (7) Testing frequency range above 1GHz the measuring instrument use RBW=1 MHz and VBW=3 MHz with Peak Detector for Peak Values, and use RBW=1 MHz and VBW=10 Hz with Peak Detector for Average Values.
- (8) For the actual test configuration, please see the test setup photo.

#### 6.4 EUT Operating Condition

The Equipment Under Test was set to Continual Transmitting in maximum power.

#### 6.5 Test Data

Please refer to the Attachment C.

## 7. Bandwidth Test

### 7.1 Test Standard and Limit

#### 7.1.1 Test Standard

FCC Part 15.247 (a)(2)

#### 7.1.2 Test Limit

FCC Part 15 Subpart C(15.247)/RSS-210		
Test Item	Limit	Frequency Range(MHz)
Bandwidth	$\geq 500$ KHz (6dB bandwidth)	2400~2483.5

### 7.2 Test Setup

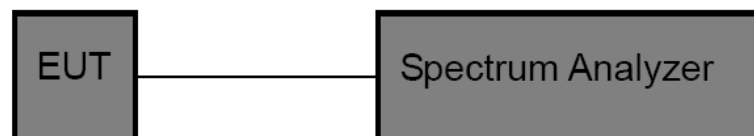

### 7.3 Test Procedure

- (1) The EUT was directly connected to the spectrum analyzer and antenna output port as show in the block diagram above.
- (2) The bandwidth is measured at an amplitude level reduced 6dB from the reference level. The reference level is the level of the highest amplitude signal observed from the transmitter at the fundamental frequency. Once the reference level is established, the equipment is conditioned with typical modulating signal to produce the worst -case (i.e the widest) bandwidth.
- (3) Measure the channel separation the spectrum analyzer was set to Resolution Bandwidth:100 kHz, and Video Bandwidth:300 kHz, Detector: Peak, Sweep Time set auto.

### 7.4 EUT Operating Condition

The EUT was set to continuously transmitting in each mode and low, Digital photo framesdle and high channel for the test.

### 7.5 Test Data

Please refer to the Attachment D.

## 8. Peak Output Power Test

### 8.1 Test Standard and Limit

#### 8.1.1 Test Standard

FCC Part 15.247 (b)

#### 8.1.2 Test Limit

FCC Part 15 Subpart C(15.247)/RSS-210		
Test Item	Limit	Frequency Range(MHz)
Peak Output Power	1 Watt or 30 dBm	2400~2483.5

### 8.2 Test Setup

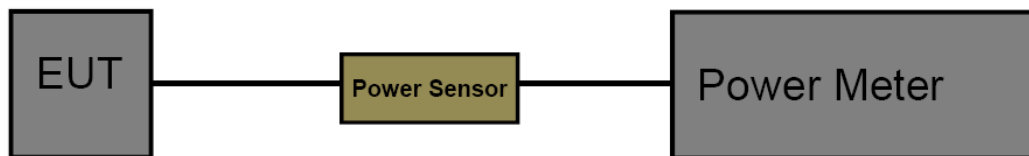

### 8.3 Test Procedure

The measurement is according to section 9.1.2 of KDB 558074 D01 DTS Meas Guidance v05. The EUT was connected to RF power meter via a broadband power sensor as show the block above. The power sensor video bandwidth is greater than or equal to the DTS bandwidth of the equipment.

### 8.4 EUT Operating Condition

The EUT was set to continuously transmitting in the max power during the test.

### 8.5 Test Data

Please refer to the Attachment E.

## 9. Power Spectral Density Test

### 9.1 Test Standard and Limit

#### 9.1.1 Test Standard

FCC Part 15.247 (e)

#### 9.1.2 Test Limit

FCC Part 15 Subpart C(15.247)		
Test Item	Limit	Frequency Range(MHz)
Power Spectral Density	8dBm(in any 3 kHz)	2400~2483.5

### 9.2 Test Setup

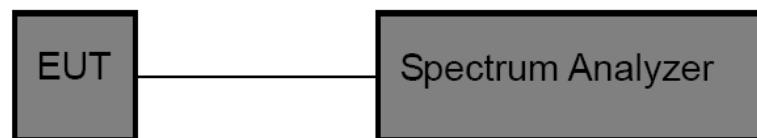

### 9.3 Test Procedure

The EUT was directly connected to the Spectrum Analyzer and antenna output port as show in the block diagram above. The measurement according to section 10.2 of KDB 558074 D01 DTS Meas Guidance v05.

- (1) The EUT was directly connected to the spectrum analyzer and antenna output port as show in the block diagram above.
- (2) Set analyser center frequency to DTS channel center frequency.
- (3) Set the span to 1.5 times the DTS bandwidth.
- (4) Set the RBW to: 3 kHz
- (5) Set the VBW to: 10 kHz
- (6) Detector: peak
- (7) Sweep time: auto
- (8) Allow trace to fully stabilize. Then use the peak marker function to determine the maximum amplitude level.

### 9.4 EUT Operating Condition

The EUT was set to continuously transmitting in each mode and low, Digital photo framesdle and high channel for the test.

### 9.5 Test Data

Please refer to the Attachment F.

## 10. Antenna Requirement

### 10.1 Standard Requirement

#### 10.1.1 Standard

FCC Part 15.203

#### 10.1.2 Requirement

An intentional radiator shall be designed to ensure that no antenna other than that furnished by the responsible party shall be used with the device. The use of a permanently attached antenna or of an antenna that uses a unique coupling to the intentional radiator shall be considered sufficient to comply with the provisions of this Section. The manufacturer may design the unit so that a broken antenna can be replaced by the user, but the use of a standard antenna jack or electrical connector is prohibited.

### 10.2 Antenna Connected Construction

The gains of the antenna used for transmitting is 3dBi, and the antenna de-signed with permanent attachment and no consideration of replacement. Please see the EUT photo for details.

#### Result

The EUT antenna is a PCB Antenna. It complies with the standard requirement.

Antenna Type
<input checked="" type="checkbox"/> Permanent attached antenna
<input type="checkbox"/> Unique connector antenna
<input type="checkbox"/> Professional installation antenna

## Attachment A-- Conducted Emission Test Data

Temperature:	24 °C	Relative Humidity:	55%
Test Voltage:	AC 120V/60 Hz		
Terminal:	Line		
Test Mode:	Mode 1		
Remark:	Only worse case is reported		

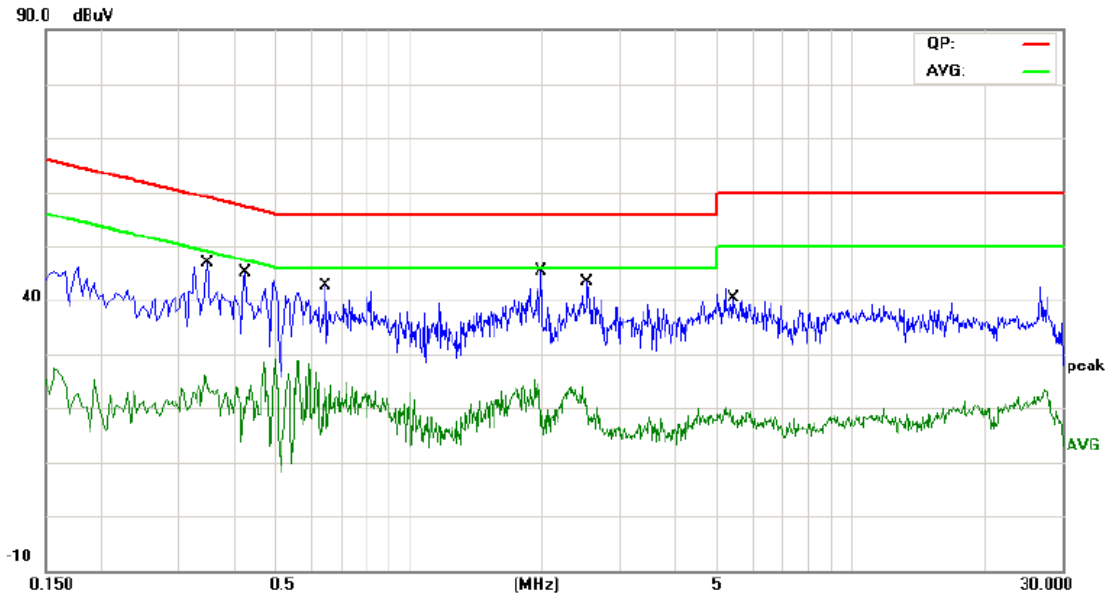

No.	Mk.	Freq. MHz	Reading Level dBuV	Correct Factor dB	Measure- ment dBuV	Limit dBuV	Over dB	Detector
1	*	0.3500	27.22	9.76	36.98	58.96	-21.98	QP
2		0.3500	10.94	9.76	20.70	48.96	-28.26	AVG
3		0.4260	23.86	9.78	33.64	57.33	-23.69	QP
4		0.4260	6.21	9.78	15.99	47.33	-31.34	AVG
5		0.6460	23.95	9.81	33.76	56.00	-22.24	QP
6		0.6460	9.25	9.81	19.06	46.00	-26.94	AVG
7		1.9900	18.79	9.85	28.64	56.00	-27.36	QP
8		1.9900	4.96	9.85	14.81	46.00	-31.19	AVG
9		2.5340	21.25	9.87	31.12	56.00	-24.88	QP
10		2.5340	7.93	9.87	17.80	46.00	-28.20	AVG
11		5.4140	19.58	9.93	29.51	60.00	-30.49	QP
12		5.4140	6.15	9.93	16.08	50.00	-33.92	AVG

Emission Level= Read Level+ Correct Factor



<b>Temperature:</b>	24 °C	<b>Relative Humidity:</b>	55%
<b>Test Voltage:</b>	AC 120V/60 Hz		
<b>Terminal:</b>	Neutral		
<b>Test Mode:</b>	Mode 1		
<b>Remark:</b>	Only worse case is reported		

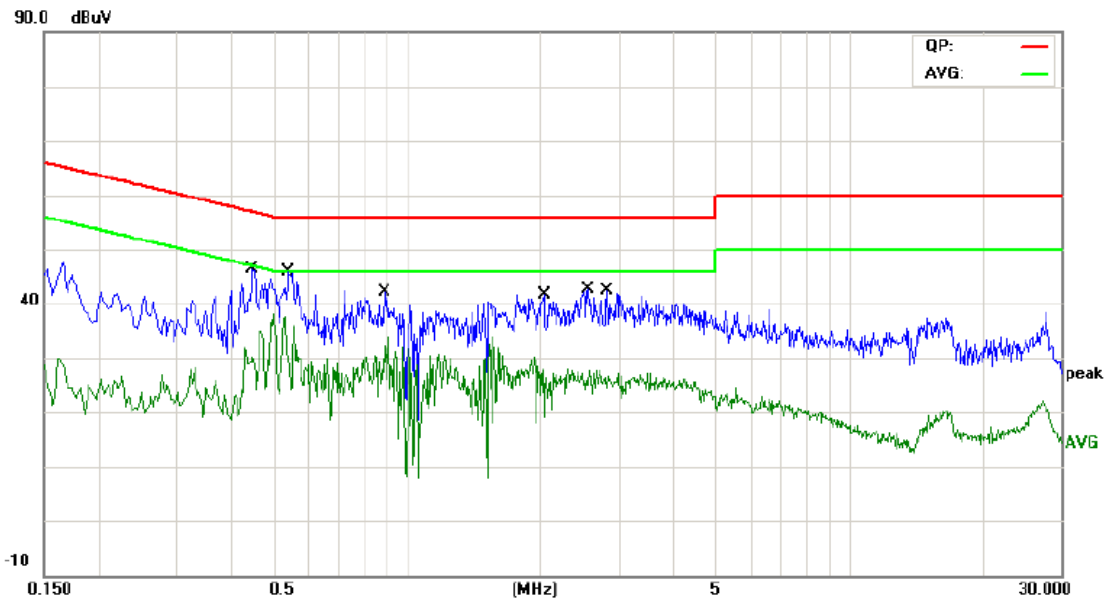

No.	Mk.	Freq. MHz	Reading Level dBuV	Correct Factor dB	Measure- ment dBuV	Limit dBuV	Over dB	Detector
1		0.4460	25.80	9.78	35.58	56.95	-21.37	QP
2	*	0.4460	19.32	9.78	29.10	46.95	-17.85	AVG
3		0.5380	25.31	9.80	35.11	56.00	-20.89	QP
4		0.5380	8.26	9.80	18.06	46.00	-27.94	AVG
5		0.8860	26.21	9.84	36.05	56.00	-19.95	QP
6		0.8860	18.15	9.84	27.99	46.00	-18.01	AVG
7		2.0340	22.83	9.85	32.68	56.00	-23.32	QP
8		2.0340	7.37	9.85	17.22	46.00	-28.78	AVG
9		2.5620	21.42	9.87	31.29	56.00	-24.71	QP
10		2.5620	6.96	9.87	16.83	46.00	-29.17	AVG
11		2.8260	22.31	9.86	32.17	56.00	-23.83	QP
12		2.8260	14.48	9.86	24.34	46.00	-21.66	AVG

Emission Level= Read Level+ Correct Factor

## Attachment B-- Radiated Emission Test Data

### 9KHz~30MHz

From 9KHz to 30MHz: Conclusion: PASS

Note: The amplitude of spurious emissions which are attenuated by more than 20dB below the permissible value has no need to be reported.

### 30MHz~1GHz

<b>Temperature:</b>	25 °C	<b>Relative Humidity:</b>	55%
<b>Test Voltage:</b>	AC120V 60HZ		
<b>Ant. Pol.</b>	Horizontal		
<b>Test Mode:</b>	TX B Mode 2412MHz		
<b>Remark:</b>	Only worse case is reported		

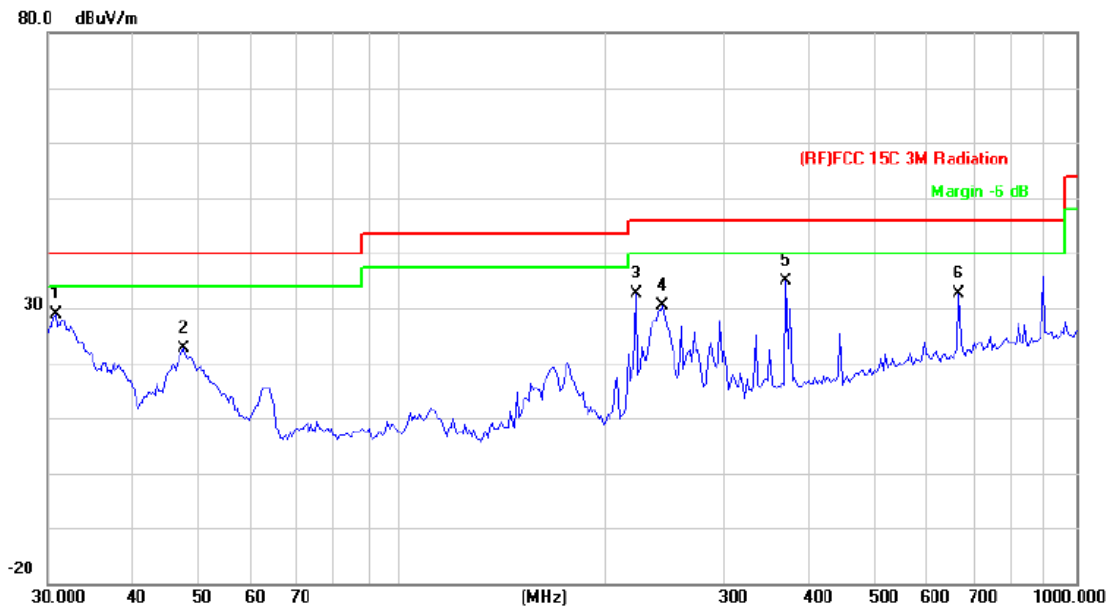

No.	Mk.	Freq. MHz	Reading Level dBuV	Correct Factor dB/m	Measure- ment dBuV/m	Limit dBuV/m	Over dB	Detector
1		30.8535	42.49	-13.64	28.85	40.00	-11.15	QP
2		47.6586	45.07	-22.56	22.51	40.00	-17.49	QP
3		222.9502	51.32	-18.60	32.72	46.00	-13.28	QP
4		244.2321	47.67	-17.37	30.30	46.00	-15.70	QP
5	*	372.0045	48.37	-13.37	35.00	46.00	-11.00	QP
6		670.4893	40.01	-7.32	32.69	46.00	-13.31	QP

\*:Maximum data    x:Over limit    !:over margin

**Emission Level= Read Level+ Correct Factor**

<b>Temperature:</b>	25 °C	<b>Relative Humidity:</b>	55%
<b>Test Voltage:</b>	AC120V 60HZ		
<b>Ant. Pol.</b>	Vertical		
<b>Test Mode:</b>	TX B Mode 2412MHZ		
<b>Remark:</b>	Only worse case is reported		

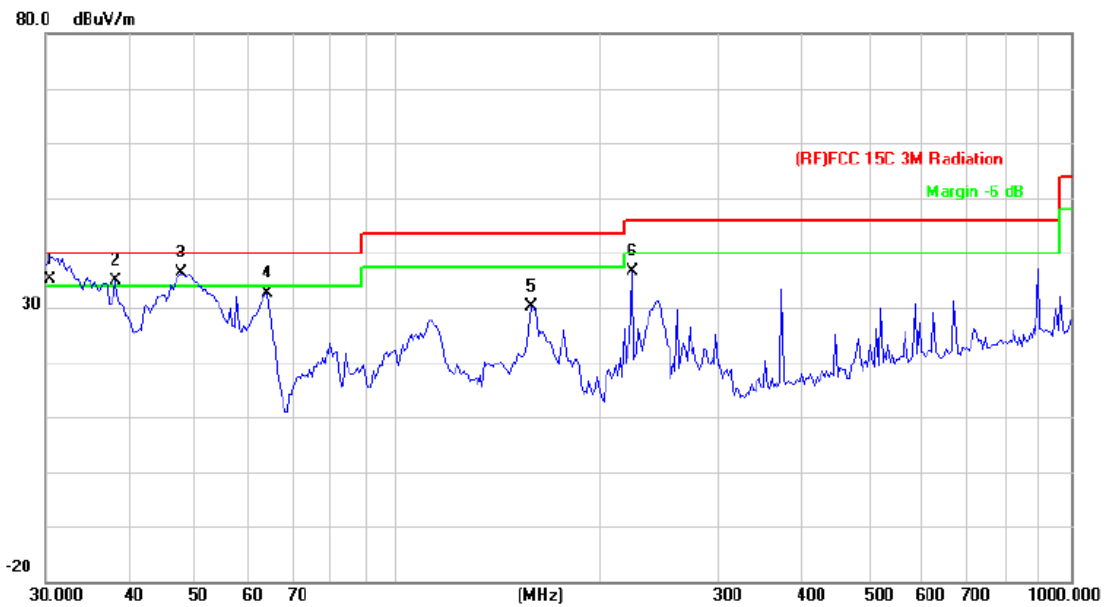

No.	Mk.	Freq. MHz	Reading Level dBuV	Correct Factor dB/m	Measure- ment dBuV/m	Limit dBuV/m	Over dB	Detector
1	!	30.4238	48.42	-13.32	35.10	40.00	-4.90	QP
2	!	38.0783	53.10	-18.26	34.84	40.00	-5.16	QP
3	*	47.6586	58.94	-22.56	36.38	40.00	-3.62	QP
4		63.9828	56.60	-24.09	32.51	40.00	-7.49	QP
5		158.1123	51.09	-20.96	30.13	43.50	-13.37	QP
6		222.9502	55.34	-18.60	36.74	46.00	-9.26	QP

\*:Maximum data    x:Over limit    !:over margin

**Emission Level= Read Level+ Correct Factor**

**Above 1GHz**

<b>Temperature:</b>	26 °C	<b>Relative Humidity:</b>	55%
<b>Test Voltage:</b>	AC120V 60Hz		
<b>Ant. Pol.</b>	Horizontal		
<b>Test Mode:</b>	TX B Mode 2412MHz		
<b>Remark:</b>	No report for the emission which more than 10 dB below the prescribed limit.		

No.	Mk.	Freq.	Reading Level	Correct Factor	Measurement	Limit	Over	Detector
		MHz	dBuV	dB/m	dBuV/m	dBuV/m	dB	
1	*	4823.946	29.66	14.55	44.21	54.00	-9.79	AVG
2		4824.018	42.46	14.55	57.01	74.00	-16.99	peak

**Emission Level= Read Level+ Correct Factor**

<b>Temperature:</b>	26 °C	<b>Relative Humidity:</b>	55%
<b>Test Voltage:</b>	AC120V 60HZ		
<b>Ant. Pol.</b>	Vertical		
<b>Test Mode:</b>	TX B Mode 2412MHz		
<b>Remark:</b>	No report for the emission which more than 10 dB below the prescribed limit.		

No.	Mk.	Freq.	Reading Level	Correct Factor	Measurement	Limit	Over	Detector
		MHz	dBuV	dB/m	dBuV/m	dBuV/m	dB	
1		4822.698	43.34	14.55	57.89	74.00	-16.11	peak
2	*	4822.698	29.09	14.55	43.64	54.00	-10.36	AVG

**Emission Level= Read Level+ Correct Factor**

<b>Temperature:</b>	26 °C	<b>Relative Humidity:</b>	55%
<b>Test Voltage:</b>	AC120V 60HZ		
<b>Ant. Pol.</b>	Horizontal		
<b>Test Mode:</b>	TX B Mode 2437MHz		
<b>Remark:</b>	No report for the emission which more than 10 dB below the prescribed limit.		

No.	Mk.	Freq.	Reading Level	Correct Factor	Measurement	Limit	Over	Detector
		MHz	dBuV	dB/m	dBuV/m	dBuV/m	dB	
1		4873.328	41.70	14.86	56.56	74.00	-17.44	peak
2	*	4875.086	29.13	14.87	44.00	54.00	-10.00	AVG

**Emission Level= Read Level+ Correct Factor**

<b>Temperature:</b>	26 °C	<b>Relative Humidity:</b>	55%
<b>Test Voltage:</b>	AC120V 60HZ		
<b>Ant. Pol.</b>	Vertical		
<b>Test Mode:</b>	TX B Mode 2437MHz		
<b>Remark:</b>	No report for the emission which more than 10 dB below the prescribed limit.		

No.	Mk.	Freq.	Reading Level	Correct Factor	Measurement	Limit	Over	Detector
		MHz	dBuV	dB/m	dBuV/m	dBuV/m	dB	
1	*	4873.976	29.03	14.86	43.89	54.00	-10.11	AVG
2		4874.414	42.60	14.86	57.46	74.00	-16.54	peak

**Emission Level= Read Level+ Correct Factor**

<b>Temperature:</b>	26 °C	<b>Relative Humidity:</b>	55%
<b>Test Voltage:</b>	AC120V 60HZ		
<b>Ant. Pol.</b>	Horizontal		
<b>Test Mode:</b>	TX B Mode 2462MHz		
<b>Remark:</b>	No report for the emission which more than 10 dB below the prescribed limit.		

No.	Mk.	Freq.	Reading Level	Correct Factor	Measurement	Limit	Over	Detector
		MHz	dBuV	dB/m	dBuV/m	dBuV/m	dB	
1		4923.334	42.84	15.17	58.01	74.00	-15.99	peak
2	*	4923.522	29.63	15.17	44.80	54.00	-9.20	AVG

**Emission Level= Read Level+ Correct Factor**

<b>Temperature:</b>	26 °C	<b>Relative Humidity:</b>	55%
<b>Test Voltage:</b>	AC120V 60HZ		
<b>Ant. Pol.</b>	Vertical		
<b>Test Mode:</b>	TX B Mode 2462MHz		
<b>Remark:</b>	No report for the emission which more than 10 dB below the prescribed limit.		

No.	Mk.	Freq.	Reading Level	Correct Factor	Measurement	Limit	Over	Detector
		MHz	dBuV	dB/m	dBuV/m	dBuV/m	dB	
1		4923.034	41.65	15.17	56.82	74.00	-17.18	peak
2	*	4923.034	29.39	15.17	44.56	54.00	-9.44	AVG

**Emission Level= Read Level+ Correct Factor**

<b>Temperature:</b>	26 °C	<b>Relative Humidity:</b>	55%																																				
<b>Test Voltage:</b>	AC120V 60HZ																																						
<b>Ant. Pol.</b>	Horizontal																																						
<b>Test Mode:</b>	TX G Mode 2412MHz																																						
<b>Remark:</b>	No report for the emission which more than 10 dB below the prescribed limit.																																						
<table border="1"> <thead> <tr> <th>No.</th> <th>Mk.</th> <th>Freq.</th> <th>Reading Level</th> <th>Correct Factor</th> <th>Measurement</th> <th>Limit</th> <th>Over</th> <th></th> </tr> <tr> <th></th> <th></th> <th>MHz</th> <th>dBuV</th> <th>dB/m</th> <th>dBuV/m</th> <th>dBuV/m</th> <th>dB</th> <th>Detector</th> </tr> </thead> <tbody> <tr> <td>1</td> <td>*</td> <td>4823.700</td> <td>29.60</td> <td>14.55</td> <td>44.15</td> <td>54.00</td> <td>-9.85</td> <td>AVG</td> </tr> <tr> <td>2</td> <td></td> <td>4823.772</td> <td>42.42</td> <td>14.55</td> <td>56.97</td> <td>74.00</td> <td>-17.03</td> <td>peak</td> </tr> </tbody> </table>				No.	Mk.	Freq.	Reading Level	Correct Factor	Measurement	Limit	Over				MHz	dBuV	dB/m	dBuV/m	dBuV/m	dB	Detector	1	*	4823.700	29.60	14.55	44.15	54.00	-9.85	AVG	2		4823.772	42.42	14.55	56.97	74.00	-17.03	peak
No.	Mk.	Freq.	Reading Level	Correct Factor	Measurement	Limit	Over																																
		MHz	dBuV	dB/m	dBuV/m	dBuV/m	dB	Detector																															
1	*	4823.700	29.60	14.55	44.15	54.00	-9.85	AVG																															
2		4823.772	42.42	14.55	56.97	74.00	-17.03	peak																															
<b>Emission Level= Read Level+ Correct Factor</b>																																							

<b>Temperature:</b>	26 °C	<b>Relative Humidity:</b>	55%																																				
<b>Test Voltage:</b>	AC120V 60HZ																																						
<b>Ant. Pol.</b>	Vertical																																						
<b>Test Mode:</b>	TX G Mode 2412MHz																																						
<b>Remark:</b>	No report for the emission which more than 10 dB below the prescribed limit.																																						
<table border="1"> <thead> <tr> <th>No.</th> <th>Mk.</th> <th>Freq.</th> <th>Reading Level</th> <th>Correct Factor</th> <th>Measurement</th> <th>Limit</th> <th>Over</th> <th></th> </tr> <tr> <th></th> <th></th> <th>MHz</th> <th>dBuV</th> <th>dB/m</th> <th>dBuV/m</th> <th>dBuV/m</th> <th>dB</th> <th>Detector</th> </tr> </thead> <tbody> <tr> <td>1</td> <td></td> <td>4823.364</td> <td>42.68</td> <td>14.55</td> <td>57.23</td> <td>74.00</td> <td>-16.77</td> <td>peak</td> </tr> <tr> <td>2</td> <td>*</td> <td>4823.988</td> <td>29.21</td> <td>14.55</td> <td>43.76</td> <td>54.00</td> <td>-10.24</td> <td>AVG</td> </tr> </tbody> </table>				No.	Mk.	Freq.	Reading Level	Correct Factor	Measurement	Limit	Over				MHz	dBuV	dB/m	dBuV/m	dBuV/m	dB	Detector	1		4823.364	42.68	14.55	57.23	74.00	-16.77	peak	2	*	4823.988	29.21	14.55	43.76	54.00	-10.24	AVG
No.	Mk.	Freq.	Reading Level	Correct Factor	Measurement	Limit	Over																																
		MHz	dBuV	dB/m	dBuV/m	dBuV/m	dB	Detector																															
1		4823.364	42.68	14.55	57.23	74.00	-16.77	peak																															
2	*	4823.988	29.21	14.55	43.76	54.00	-10.24	AVG																															
<b>Emission Level= Read Level+ Correct Factor</b>																																							

<b>Temperature:</b>	26 °C	<b>Relative Humidity:</b>	55%
<b>Test Voltage:</b>	AC120V 60HZ		
<b>Ant. Pol.</b>	Horizontal		
<b>Test Mode:</b>	TX G Mode 2437MHz		
<b>Remark:</b>	No report for the emission which more than 10 dB below the prescribed limit.		

No.	Mk.	Freq.	Reading Level	Correct Factor	Measurement	Limit	Over	Detector
		MHz	dBuV	dB/m	dBuV/m	dBuV/m	dB	
1		4873.592	41.69	14.86	56.55	74.00	-17.45	peak
2	*	4873.592	29.05	14.86	43.91	54.00	-10.09	AVG

**Emission Level= Read Level+ Correct Factor**

<b>Temperature:</b>	26 °C	<b>Relative Humidity:</b>	55%
<b>Test Voltage:</b>	AC120V 60HZ		
<b>Ant. Pol.</b>	Vertical		
<b>Test Mode:</b>	TX G Mode 2437MHz		
<b>Remark:</b>	No report for the emission which more than 10 dB below the prescribed limit.		

No.	Mk.	Freq.	Reading Level	Correct Factor	Measurement	Limit	Over	Detector
		MHz	dBuV	dB/m	dBuV/m	dBuV/m	dB	
1		4873.292	43.10	14.86	57.96	74.00	-16.04	peak
2	*	4873.292	29.03	14.86	43.89	54.00	-10.11	AVG

**Emission Level= Read Level+ Correct Factor**



<b>Temperature:</b>	26 °C	<b>Relative Humidity:</b>	55%																																				
<b>Test Voltage:</b>	AC120V 60HZ																																						
<b>Ant. Pol.</b>	Horizontal																																						
<b>Test Mode:</b>	TX G Mode 2462MHz																																						
<b>Remark:</b>	No report for the emission which more than 10 dB below the prescribed limit.																																						
<table border="1"> <thead> <tr> <th>No.</th> <th>Mk.</th> <th>Freq.</th> <th>Reading Level</th> <th>Correct Factor</th> <th>Measurement</th> <th>Limit</th> <th>Over</th> <th></th> </tr> <tr> <th></th> <th></th> <th>MHz</th> <th>dBuV</th> <th>dB/m</th> <th>dBuV/m</th> <th>dBuV/m</th> <th>dB</th> <th>Detector</th> </tr> </thead> <tbody> <tr> <td>1</td> <td></td> <td>4924.072</td> <td>40.48</td> <td>15.17</td> <td>55.65</td> <td>74.00</td> <td>-18.35</td> <td>peak</td> </tr> <tr> <td>2</td> <td>*</td> <td>4924.072</td> <td>29.47</td> <td>15.17</td> <td>44.64</td> <td>54.00</td> <td>-9.36</td> <td>AVG</td> </tr> </tbody> </table>				No.	Mk.	Freq.	Reading Level	Correct Factor	Measurement	Limit	Over				MHz	dBuV	dB/m	dBuV/m	dBuV/m	dB	Detector	1		4924.072	40.48	15.17	55.65	74.00	-18.35	peak	2	*	4924.072	29.47	15.17	44.64	54.00	-9.36	AVG
No.	Mk.	Freq.	Reading Level	Correct Factor	Measurement	Limit	Over																																
		MHz	dBuV	dB/m	dBuV/m	dBuV/m	dB	Detector																															
1		4924.072	40.48	15.17	55.65	74.00	-18.35	peak																															
2	*	4924.072	29.47	15.17	44.64	54.00	-9.36	AVG																															
<b>Emission Level= Read Level+ Correct Factor</b>																																							

<b>Temperature:</b>	26 °C	<b>Relative Humidity:</b>	55%																																				
<b>Test Voltage:</b>	AC120V 60HZ																																						
<b>Ant. Pol.</b>	Vertical																																						
<b>Test Mode:</b>	TX G Mode 2462MHz																																						
<b>Remark:</b>	No report for the emission which more than 10 dB below the prescribed limit.																																						
<table border="1"> <thead> <tr> <th>No.</th> <th>Mk.</th> <th>Freq.</th> <th>Reading Level</th> <th>Correct Factor</th> <th>Measurement</th> <th>Limit</th> <th>Over</th> <th></th> </tr> <tr> <th></th> <th></th> <th>MHz</th> <th>dBuV</th> <th>dB/m</th> <th>dBuV/m</th> <th>dBuV/m</th> <th>dB</th> <th>Detector</th> </tr> </thead> <tbody> <tr> <td>1</td> <td>*</td> <td>4923.676</td> <td>29.45</td> <td>15.17</td> <td>44.62</td> <td>54.00</td> <td>-9.38</td> <td>AVG</td> </tr> <tr> <td>2</td> <td></td> <td>4925.242</td> <td>42.72</td> <td>15.19</td> <td>57.91</td> <td>74.00</td> <td>-16.09</td> <td>peak</td> </tr> </tbody> </table>				No.	Mk.	Freq.	Reading Level	Correct Factor	Measurement	Limit	Over				MHz	dBuV	dB/m	dBuV/m	dBuV/m	dB	Detector	1	*	4923.676	29.45	15.17	44.62	54.00	-9.38	AVG	2		4925.242	42.72	15.19	57.91	74.00	-16.09	peak
No.	Mk.	Freq.	Reading Level	Correct Factor	Measurement	Limit	Over																																
		MHz	dBuV	dB/m	dBuV/m	dBuV/m	dB	Detector																															
1	*	4923.676	29.45	15.17	44.62	54.00	-9.38	AVG																															
2		4925.242	42.72	15.19	57.91	74.00	-16.09	peak																															
<b>Emission Level= Read Level+ Correct Factor</b>																																							

<b>Temperature:</b>	26 °C	<b>Relative Humidity:</b>	55%
<b>Test Voltage:</b>	AC120V 60HZ		
<b>Ant. Pol.</b>	Horizontal		
<b>Test Mode:</b>	TX N(HT20) Mode 2412MHz		
<b>Remark:</b>	No report for the emission which more than 10 dB below the prescribed limit.		

No.	Mk.	Freq.	Reading Level	Correct Factor	Measurement	Limit	Over	Detector
		MHz	dBuV	dB/m	dBuV/m	dBuV/m	dB	
1		4824.078	42.65	14.55	57.20	74.00	-16.80	peak
2	*	4824.078	29.63	14.55	44.18	54.00	-9.82	AVG

**Emission Level= Read Level+ Correct Factor**

<b>Temperature:</b>	26 °C	<b>Relative Humidity:</b>	55%
<b>Test Voltage:</b>	AC120V 60HZ		
<b>Ant. Pol.</b>	Vertical		
<b>Test Mode:</b>	TX N(HT20) Mode 2412MHz		
<b>Remark:</b>	No report for the emission which more than 10 dB below the prescribed limit.		

No.	Mk.	Freq.	Reading Level	Correct Factor	Measurement	Limit	Over	Detector
		MHz	dBuV	dB/m	dBuV/m	dBuV/m	dB	
1		4822.944	41.56	14.55	56.11	74.00	-17.89	peak
2	*	4822.944	29.05	14.55	43.60	54.00	-10.40	AVG

**Emission Level= Read Level+ Correct Factor**

<b>Temperature:</b>	26 °C	<b>Relative Humidity:</b>	55%																																
<b>Test Voltage:</b>	AC120V 60HZ																																		
<b>Ant. Pol.</b>	Horizontal																																		
<b>Test Mode:</b>	TX N(HT20) Mode 2437MHz																																		
<b>Remark:</b>	No report for the emission which more than 10 dB below the prescribed limit.																																		
<table border="1"> <thead> <tr> <th>No. Mk.</th> <th>Freq.</th> <th>Reading Level</th> <th>Correct Factor</th> <th>Measurement</th> <th>Limit</th> <th>Over</th> <th></th> </tr> <tr> <th></th> <th>MHz</th> <th>dBuV</th> <th>dB/m</th> <th>dBuV/m</th> <th>dBuV/m</th> <th>dB</th> <th>Detector</th> </tr> </thead> <tbody> <tr> <td>1</td> <td>4873.610</td> <td>43.11</td> <td>14.86</td> <td>57.97</td> <td>74.00</td> <td>-16.03</td> <td>peak</td> </tr> <tr> <td>2</td> <td>* 4874.192</td> <td>29.08</td> <td>14.86</td> <td>43.94</td> <td>54.00</td> <td>-10.06</td> <td>AVG</td> </tr> </tbody> </table>				No. Mk.	Freq.	Reading Level	Correct Factor	Measurement	Limit	Over			MHz	dBuV	dB/m	dBuV/m	dBuV/m	dB	Detector	1	4873.610	43.11	14.86	57.97	74.00	-16.03	peak	2	* 4874.192	29.08	14.86	43.94	54.00	-10.06	AVG
No. Mk.	Freq.	Reading Level	Correct Factor	Measurement	Limit	Over																													
	MHz	dBuV	dB/m	dBuV/m	dBuV/m	dB	Detector																												
1	4873.610	43.11	14.86	57.97	74.00	-16.03	peak																												
2	* 4874.192	29.08	14.86	43.94	54.00	-10.06	AVG																												
<b>Emission Level= Read Level+ Correct Factor</b>																																			

<b>Temperature:</b>	26 °C	<b>Relative Humidity:</b>	55%																																
<b>Test Voltage:</b>	AC120V 60HZ																																		
<b>Ant. Pol.</b>	Vertical																																		
<b>Test Mode:</b>	TX N(HT20) Mode 2437MHz																																		
<b>Remark:</b>	No report for the emission which more than 10 dB below the prescribed limit.																																		
<table border="1"> <thead> <tr> <th>No. Mk.</th> <th>Freq.</th> <th>Reading Level</th> <th>Correct Factor</th> <th>Measurement</th> <th>Limit</th> <th>Over</th> <th></th> </tr> <tr> <th></th> <th>MHz</th> <th>dBuV</th> <th>dB/m</th> <th>dBuV/m</th> <th>dBuV/m</th> <th>dB</th> <th>Detector</th> </tr> </thead> <tbody> <tr> <td>1</td> <td>4875.002</td> <td>41.04</td> <td>14.86</td> <td>55.90</td> <td>74.00</td> <td>-18.10</td> <td>peak</td> </tr> <tr> <td>2</td> <td>* 4875.002</td> <td>29.14</td> <td>14.86</td> <td>44.00</td> <td>54.00</td> <td>-10.00</td> <td>AVG</td> </tr> </tbody> </table>				No. Mk.	Freq.	Reading Level	Correct Factor	Measurement	Limit	Over			MHz	dBuV	dB/m	dBuV/m	dBuV/m	dB	Detector	1	4875.002	41.04	14.86	55.90	74.00	-18.10	peak	2	* 4875.002	29.14	14.86	44.00	54.00	-10.00	AVG
No. Mk.	Freq.	Reading Level	Correct Factor	Measurement	Limit	Over																													
	MHz	dBuV	dB/m	dBuV/m	dBuV/m	dB	Detector																												
1	4875.002	41.04	14.86	55.90	74.00	-18.10	peak																												
2	* 4875.002	29.14	14.86	44.00	54.00	-10.00	AVG																												
<b>Emission Level= Read Level+ Correct Factor</b>																																			

<b>Temperature:</b>	26 °C	<b>Relative Humidity:</b>	55%
<b>Test Voltage:</b>	AC120V 60HZ		
<b>Ant. Pol.</b>	Horizontal		
<b>Test Mode:</b>	TX N(HT20) Mode 2462MHz		
<b>Remark:</b>	No report for the emission which more than 10 dB below the prescribed limit.		

No.	Mk.	Freq.	Reading Level	Correct Factor	Measurement	Limit	Over	Detector
		MHz	dBuV	dB/m	dBuV/m	dBuV/m	dB	
1		4924.390	43.28	15.17	58.45	74.00	-15.55	peak
2	*	4924.390	29.40	15.17	44.57	54.00	-9.43	AVG

**Emission Level= Read Level+ Correct Factor**

<b>Temperature:</b>	26 °C	<b>Relative Humidity:</b>	55%
<b>Test Voltage:</b>	AC120V 60HZ		
<b>Ant. Pol.</b>	Vertical		
<b>Test Mode:</b>	TX N(HT20) Mode 2462MHz		
<b>Remark:</b>	No report for the emission which more than 10 dB below the prescribed limit.		

No.	Mk.	Freq.	Reading Level	Correct Factor	Measurement	Limit	Over	Detector
		MHz	dBuV	dB/m	dBuV/m	dBuV/m	dB	
1		4923.004	43.23	15.17	58.40	74.00	-15.60	peak
2	*	4923.004	29.35	15.17	44.52	54.00	-9.48	AVG

**Emission Level= Read Level+ Correct Factor**

<b>Temperature:</b>	26 °C	<b>Relative Humidity:</b>	55%
<b>Test Voltage:</b>	AC120V 60HZ		
<b>Ant. Pol.</b>	Horizontal		
<b>Test Mode:</b>	TX N(HT40) Mode 2422MHz		
<b>Remark:</b>	No report for the emission which more than 10 dB below the prescribed limit.		

No.	Mk.	Freq.	Reading Level	Correct Factor	Measurement	Limit	Over	Detector
		MHz	dBuV	dB/m	dBuV/m	dBuV/m	dB	
1	*	4842.644	29.22	14.66	43.88	54.00	-10.12	AVG
2		4843.160	42.20	14.67	56.87	74.00	-17.13	peak

**Emission Level= Read Level+ Correct Factor**

<b>Temperature:</b>	26 °C	<b>Relative Humidity:</b>	55%
<b>Test Voltage:</b>	AC120V 60HZ		
<b>Ant. Pol.</b>	Vertical		
<b>Test Mode:</b>	TX N(HT40) Mode 2422MHz		
<b>Remark:</b>	No report for the emission which more than 10 dB below the prescribed limit.		

No.	Mk.	Freq.	Reading Level	Correct Factor	Measurement	Limit	Over	Detector
		MHz	dBuV	dB/m	dBuV/m	dBuV/m	dB	
1		4844.588	41.29	14.68	55.97	74.00	-18.03	peak
2	*	4844.588	29.21	14.68	43.89	54.00	-10.11	AVG

**Emission Level= Read Level+ Correct Factor**

<b>Temperature:</b>	26 °C	<b>Relative Humidity:</b>	55%																																				
<b>Test Voltage:</b>	AC120V 60HZ																																						
<b>Ant. Pol.</b>	Horizontal																																						
<b>Test Mode:</b>	TX N(HT40) Mode 2437MHz																																						
<b>Remark:</b>	No report for the emission which more than 10 dB below the prescribed limit.																																						
<table border="1"> <thead> <tr> <th>No.</th> <th>Mk.</th> <th>Freq.</th> <th>Reading Level</th> <th>Correct Factor</th> <th>Measurement</th> <th>Limit</th> <th>Over</th> <th>Detector</th> </tr> <tr> <th></th> <th></th> <th>MHz</th> <th>dBuV</th> <th>dB/m</th> <th>dBuV/m</th> <th>dBuV/m</th> <th>dB</th> <th></th> </tr> </thead> <tbody> <tr> <td>1</td> <td>*</td> <td>4873.000</td> <td>30.12</td> <td>14.85</td> <td>44.97</td> <td>54.00</td> <td>-9.03</td> <td>AVG</td> </tr> <tr> <td>2</td> <td></td> <td>4873.184</td> <td>44.70</td> <td>14.85</td> <td>59.55</td> <td>74.00</td> <td>-14.45</td> <td>peak</td> </tr> </tbody> </table>				No.	Mk.	Freq.	Reading Level	Correct Factor	Measurement	Limit	Over	Detector			MHz	dBuV	dB/m	dBuV/m	dBuV/m	dB		1	*	4873.000	30.12	14.85	44.97	54.00	-9.03	AVG	2		4873.184	44.70	14.85	59.55	74.00	-14.45	peak
No.	Mk.	Freq.	Reading Level	Correct Factor	Measurement	Limit	Over	Detector																															
		MHz	dBuV	dB/m	dBuV/m	dBuV/m	dB																																
1	*	4873.000	30.12	14.85	44.97	54.00	-9.03	AVG																															
2		4873.184	44.70	14.85	59.55	74.00	-14.45	peak																															
<b>Emission Level= Read Level+ Correct Factor</b>																																							

<b>Temperature:</b>	26 °C	<b>Relative Humidity:</b>	55%																																				
<b>Test Voltage:</b>	AC120V 60HZ																																						
<b>Ant. Pol.</b>	Vertical																																						
<b>Test Mode:</b>	TX N(HT40) Mode 2437MHz																																						
<b>Remark:</b>	No report for the emission which more than 10 dB below the prescribed limit.																																						
<table border="1"> <thead> <tr> <th>No.</th> <th>Mk.</th> <th>Freq.</th> <th>Reading Level</th> <th>Correct Factor</th> <th>Measurement</th> <th>Limit</th> <th>Over</th> <th>Detector</th> </tr> <tr> <th></th> <th></th> <th>MHz</th> <th>dBuV</th> <th>dB/m</th> <th>dBuV/m</th> <th>dBuV/m</th> <th>dB</th> <th></th> </tr> </thead> <tbody> <tr> <td>1</td> <td></td> <td>4873.862</td> <td>42.97</td> <td>14.86</td> <td>57.83</td> <td>74.00</td> <td>-16.17</td> <td>peak</td> </tr> <tr> <td>2</td> <td>*</td> <td>4873.862</td> <td>28.99</td> <td>14.86</td> <td>43.85</td> <td>54.00</td> <td>-10.15</td> <td>AVG</td> </tr> </tbody> </table>				No.	Mk.	Freq.	Reading Level	Correct Factor	Measurement	Limit	Over	Detector			MHz	dBuV	dB/m	dBuV/m	dBuV/m	dB		1		4873.862	42.97	14.86	57.83	74.00	-16.17	peak	2	*	4873.862	28.99	14.86	43.85	54.00	-10.15	AVG
No.	Mk.	Freq.	Reading Level	Correct Factor	Measurement	Limit	Over	Detector																															
		MHz	dBuV	dB/m	dBuV/m	dBuV/m	dB																																
1		4873.862	42.97	14.86	57.83	74.00	-16.17	peak																															
2	*	4873.862	28.99	14.86	43.85	54.00	-10.15	AVG																															
<b>Emission Level= Read Level+ Correct Factor</b>																																							

<b>Temperature:</b>	26 °C	<b>Relative Humidity:</b>	55%
<b>Test Voltage:</b>	AC120V 60HZ		
<b>Ant. Pol.</b>	Horizontal		
<b>Test Mode:</b>	TX N(HT40) Mode 2452MHz		
<b>Remark:</b>	No report for the emission which more than 10 dB below the prescribed limit.		

No.	Mk.	Freq.	Reading Level	Correct Factor	Measurement	Limit	Over	
		MHz	dBuV	dB/m	dBuV/m	dBuV/m	dB	Detector
1		4905.062	42.24	15.05	57.29	74.00	-16.71	peak
2	*	4905.062	29.40	15.05	44.45	54.00	-9.55	AVG

**Emission Level= Read Level+ Correct Factor**

<b>Temperature:</b>	26 °C	<b>Relative Humidity:</b>	55%
<b>Test Voltage:</b>	AC120V 60HZ		
<b>Ant. Pol.</b>	Vertical		
<b>Test Mode:</b>	TX N(HT40) Mode 2452MHz		
<b>Remark:</b>	No report for the emission which more than 10 dB below the prescribed limit.		

No.	Mk.	Freq.	Reading Level	Correct Factor	Measurement	Limit	Over	
		MHz	dBuV	dB/m	dBuV/m	dBuV/m	dB	Detector
1		4903.316	40.90	15.04	55.94	74.00	-18.06	peak
2	*	4903.316	29.40	15.04	44.44	54.00	-9.56	AVG

**Emission Level= Read Level+ Correct Factor**

**Conducted Emission Test Data**

**802.11B Mode (Only worse case is reported)**

**2412 MHz**



**802.11B Mode**

**2437 MHz**

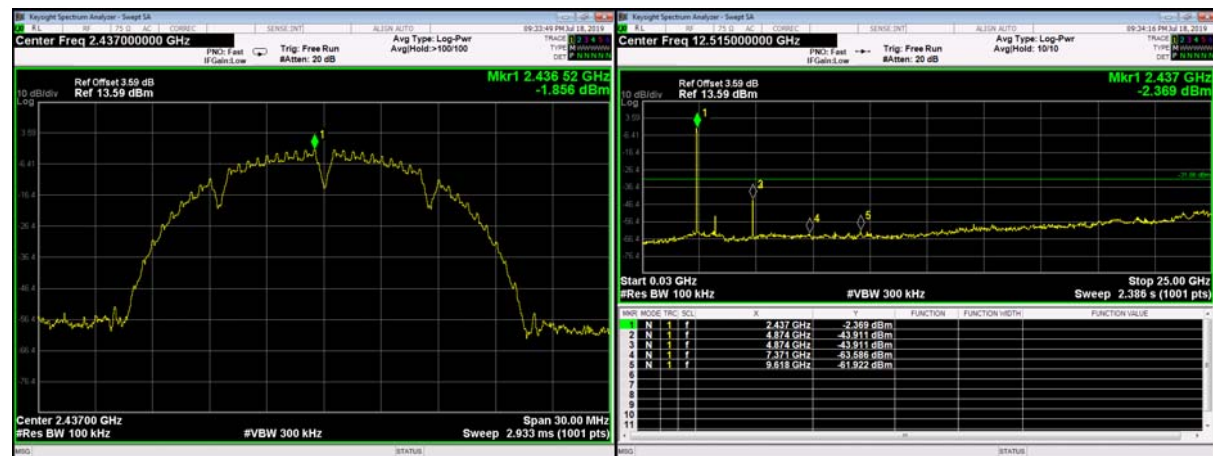

**802.11B Mode**

**2462 MHz**

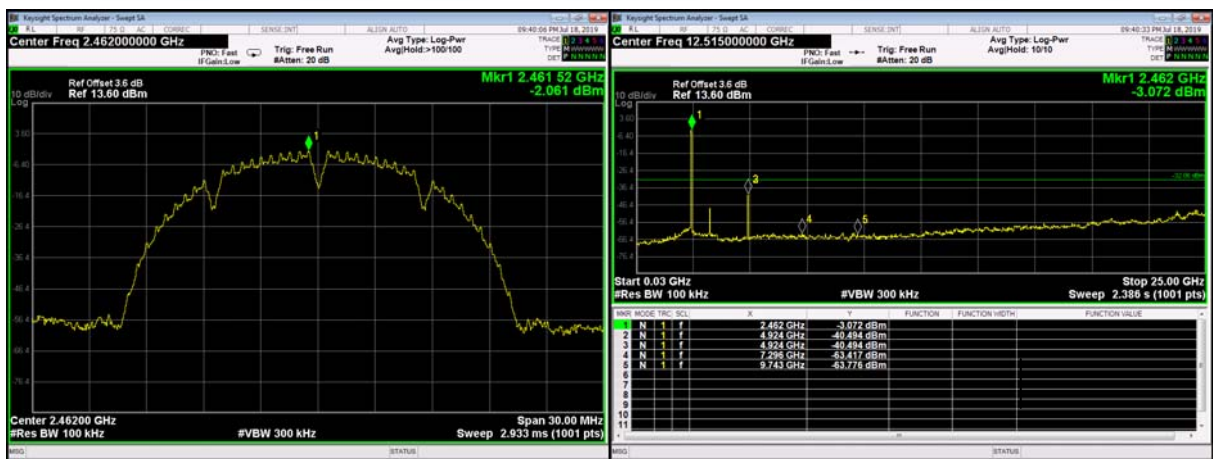



# Attachment C-- Restricted Bands & Band-edge Requirement

## Test Data

### (1) Radiation Test

Temperature:	26 °C	Relative Humidity:	55%
Test Voltage:	AC120V 60HZ		
Ant. Pol.	Horizontal		
Test Mode:	TX B Mode 2412MHz		
Remark:	N/A		

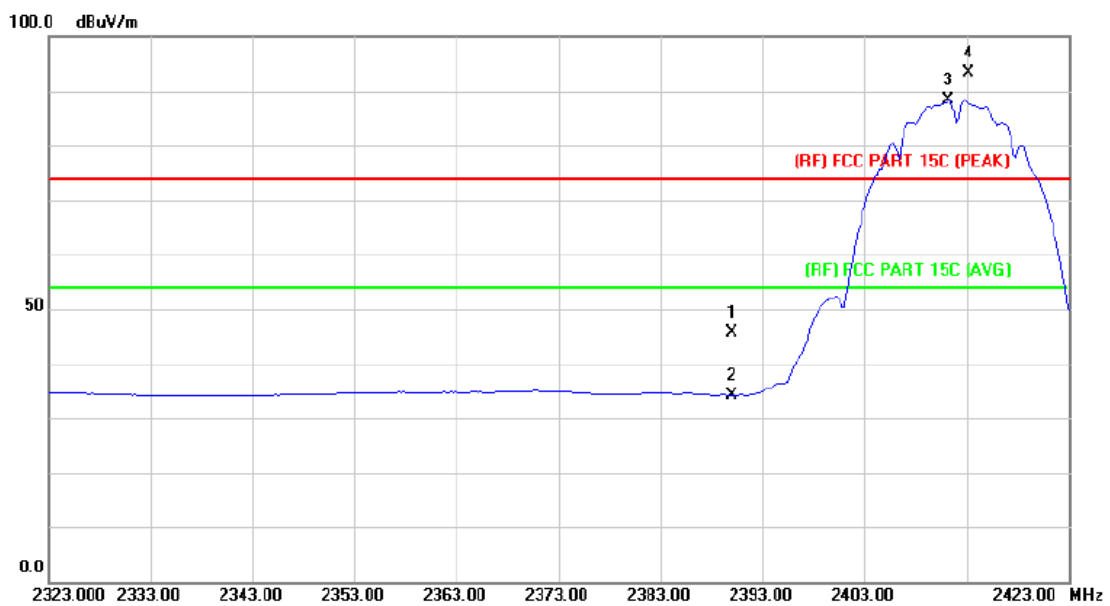

No.	Mk.	Freq. MHz	Reading Level dBuV	Correct Factor dB/m	Measure- ment dBuV/m	Limit dBuV/m	Over dB	Detector
1		2390.000	42.70	2.82	45.52	74.00	-28.48	peak
2		2390.000	31.40	2.82	34.22	54.00	-19.78	AVG
3	*	2411.200	85.50	2.94	88.44	Fundamental Frequency		AVG
4	X	2413.200	90.36	2.95	93.31	Fundamental Frequency		peak

Emission Level= Read Level+ Correct Factor

<b>Temperature:</b>	26 °C	<b>Relative Humidity:</b>	55%
<b>Test Voltage:</b>	AC120V 60HZ		
<b>Ant. Pol.</b>	Vertical		
<b>Test Mode:</b>	TX B Mode 2412MHz		
<b>Remark:</b>	N/A		

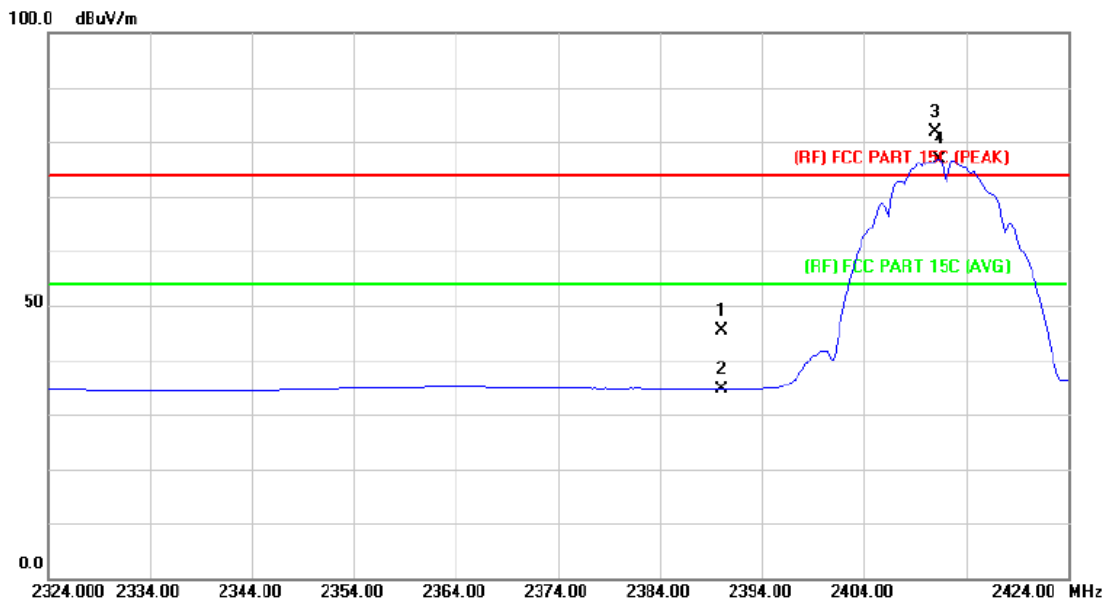

No.	Mk.	Freq. MHz	Reading Level dBuV	Correct Factor dB/m	Measure- ment dBuV/m	Limit dBuV/m	Over dB	Detector
1		2390.000	42.46	2.82	45.28	74.00	-28.72	peak
2		2390.000	31.78	2.82	34.60	54.00	-19.40	AVG
3	X	2411.000	79.01	2.93	81.94	Fundamental Frequency		peak
4	*	2411.400	74.01	2.94	76.95	Fundamental Frequency		AVG

Emission Level= Read Level+ Correct Factor

<b>Temperature:</b>	26 °C	<b>Relative Humidity:</b>	55%
<b>Test Voltage:</b>	AC120V 60HZ		
<b>Ant. Pol.</b>	Horizontal		
<b>Test Mode:</b>	TX B Mode 2462MHz		
<b>Remark:</b>	N/A		

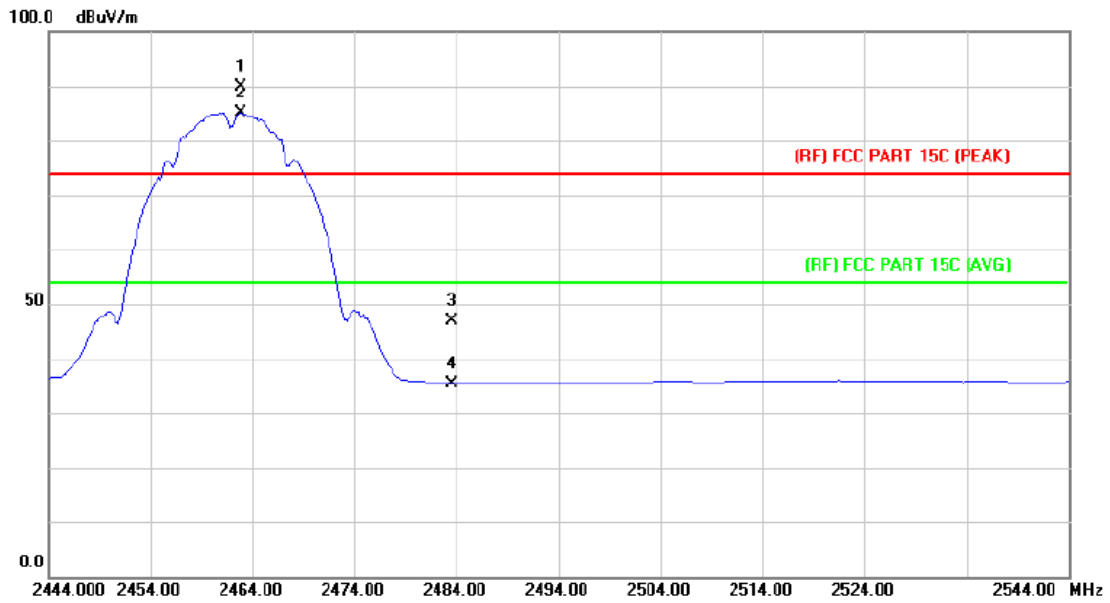

No.	Mk.	Freq. MHz	Reading Level dBuV	Correct Factor dB/m	Measure- ment dBuV/m	Limit dBuV/m	Over dB	Detector
1	X	2462.800	86.62	3.27	89.89	Fundamental Frequency		peak
2	*	2462.800	81.95	3.27	85.22	Fundamental Frequency		AVG
3		2483.500	43.40	3.41	46.81	74.00	-27.19	peak
4		2483.500	31.96	3.41	35.37	54.00	-18.63	AVG

Emission Level= Read Level+ Correct Factor

<b>Temperature:</b>	26 °C	<b>Relative Humidity:</b>	55%
<b>Test Voltage:</b>	AC120V 60HZ		
<b>Ant. Pol.</b>	Vertical		
<b>Test Mode:</b>	TX B Mode 2462MHz		
<b>Remark:</b>	N/A		

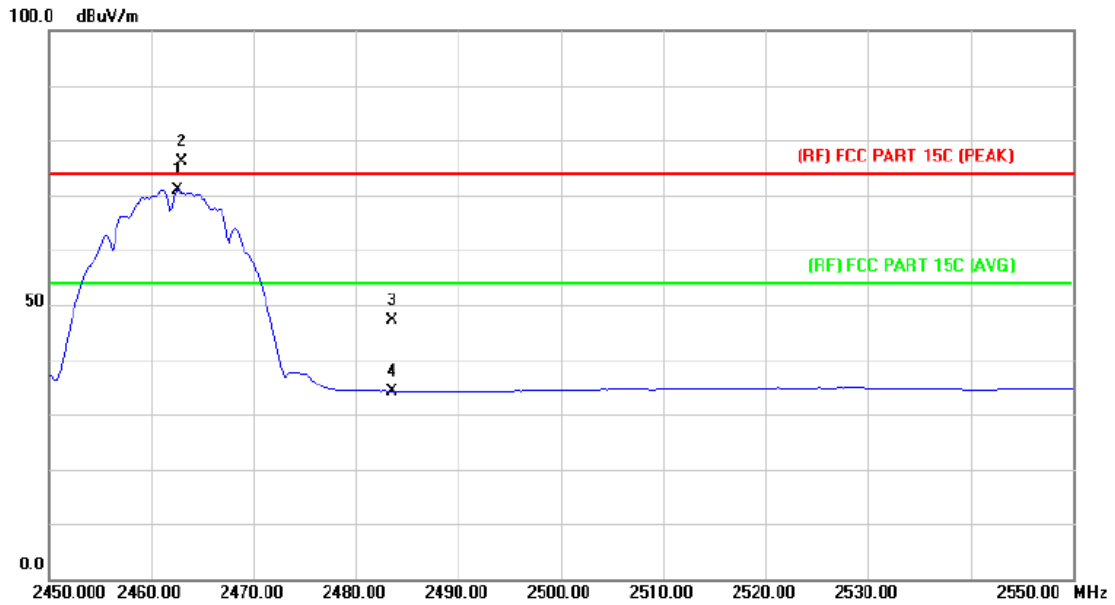

No.	Mk.	Freq. MHz	Reading Level dBuV	Correct Factor dB/m	Measure- ment dBuV/m	Limit dBuV/m	Over dB	Detector
1	*	2462.600	67.73	3.27	71.00	Fundamental Frequency		AVG
2	X	2463.000	72.87	3.27	76.14	Fundamental Frequency		peak
3		2483.500	43.65	3.41	47.06	74.00	-26.94	peak
4		2483.500	30.74	3.41	34.15	54.00	-19.85	AVG

Emission Level= Read Level+ Correct Factor

<b>Temperature:</b>	26 °C	<b>Relative Humidity:</b>	55%
<b>Test Voltage:</b>	AC120V 60HZ		
<b>Ant. Pol.</b>	Horizontal		
<b>Test Mode:</b>	TX G Mode 2412MHz		
<b>Remark:</b>	N/A		

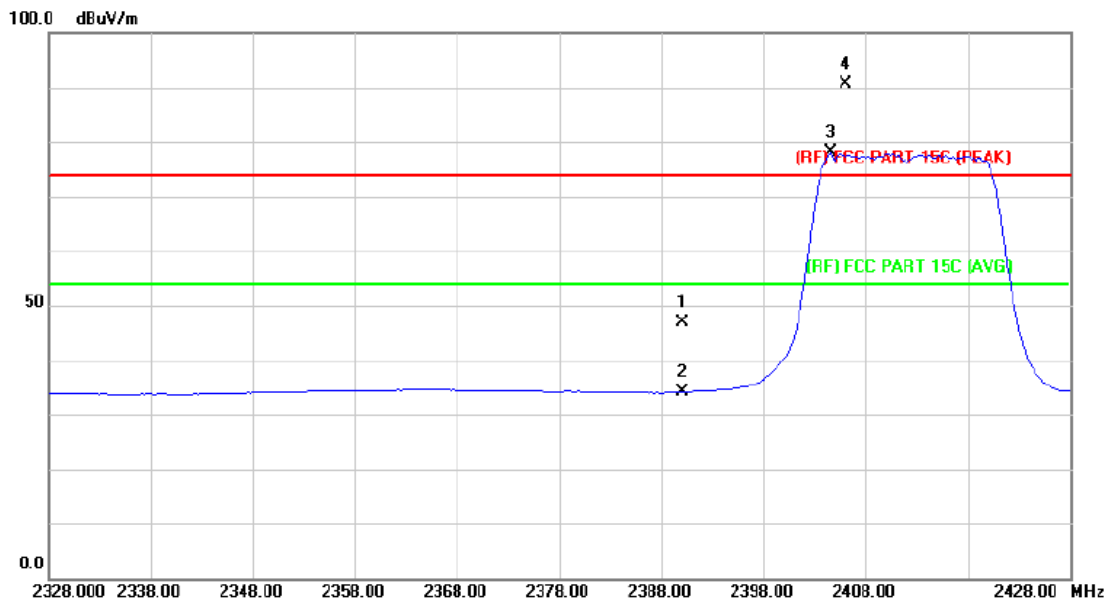

No.	Mk.	Freq. MHz	Reading Level dBuV	Correct Factor dB/m	Measure- ment dBuV/m	Limit dBuV/m	Over dB	Detector
1		2390.000	44.14	2.82	46.96	74.00	-27.04	peak
2		2390.000	31.35	2.82	34.17	54.00	-19.83	AVG
3	*	2404.600	75.29	2.88	78.17	Fundamental Frequency	7	AVG
4	X	2406.000	87.83	2.90	90.73	Fundamental Frequency		peak

Emission Level= Read Level+ Correct Factor

<b>Temperature:</b>	26 °C	<b>Relative Humidity:</b>	55%
<b>Test Voltage:</b>	AC120V 60HZ		
<b>Ant. Pol.</b>	Vertical		
<b>Test Mode:</b>	TX G Mode 2412MHz		
<b>Remark:</b>	N/A		

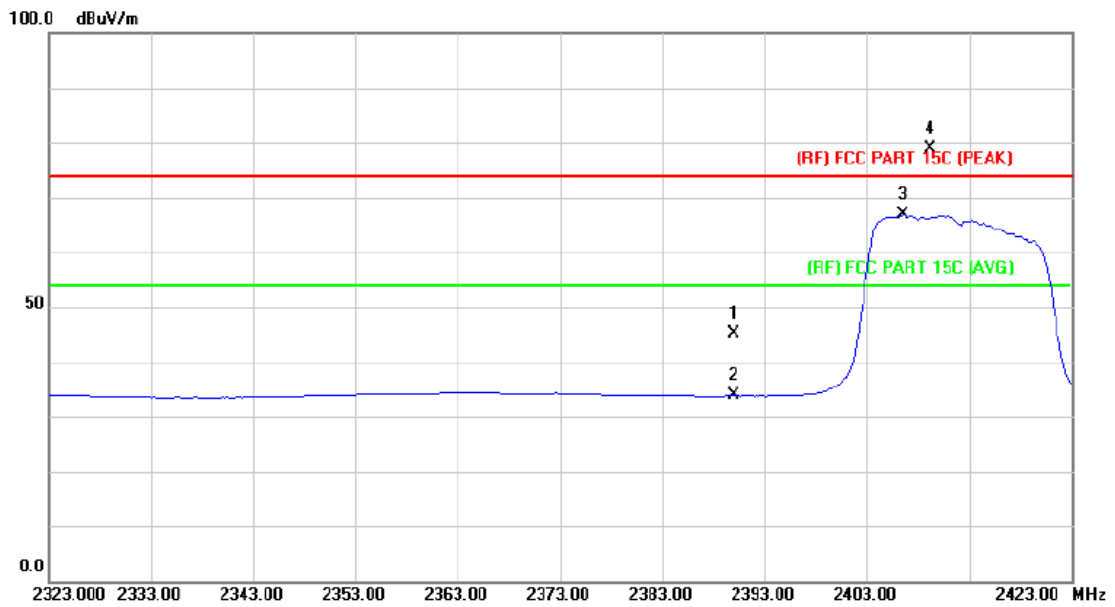

No.	Mk.	Freq. MHz	Reading Level dBuV	Correct Factor dB/m	Measure- ment dBuV/m	Limit dBuV/m	Over dB	Detector
1		2390.000	42.31	2.82	45.13	74.00	-28.87	peak
2		2390.000	30.95	2.82	33.77	54.00	-20.23	AVG
3	*	2406.600	63.86	2.90	66.76	Fundamental Frequency		AVG
4	X	2409.200	75.94	2.93	78.87	Fundamental Frequency		peak

Emission Level= Read Level+ Correct Factor

<b>Temperature:</b>	26 °C	<b>Relative Humidity:</b>	55%
<b>Test Voltage:</b>	AC120V 60HZ		
<b>Ant. Pol.</b>	Horizontal		
<b>Test Mode:</b>	TX G Mode 2462MHz		
<b>Remark:</b>	N/A		

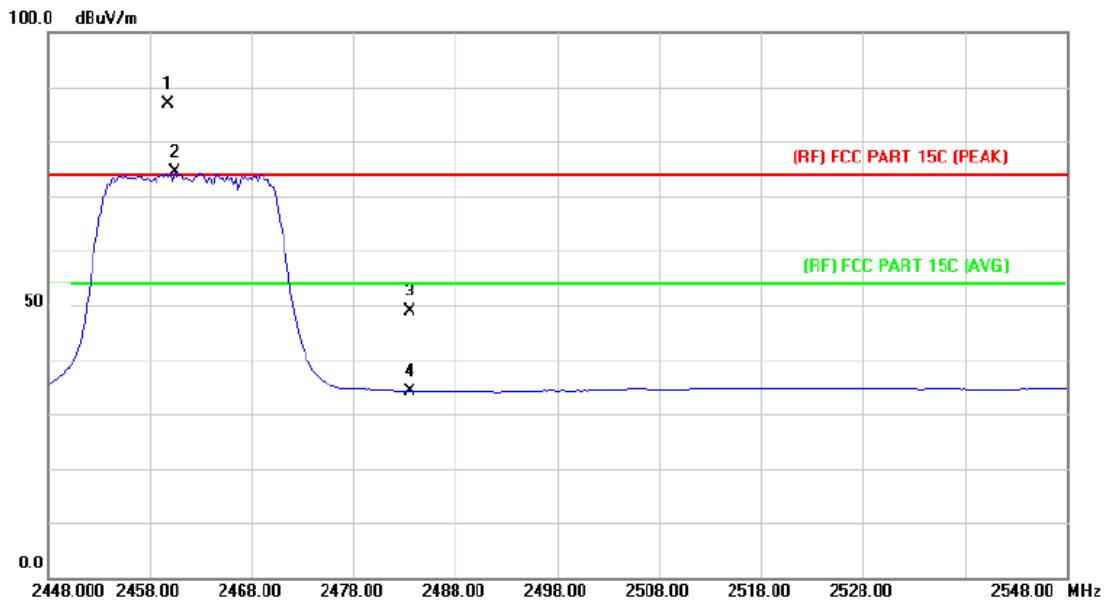

No.	Mk.	Freq. MHz	Reading Level dBuV	Correct Factor dB/m	Measure- ment dBuV/m	Limit dBuV/m	Over dB	Detector
1	X	2459.800	83.57	3.26	86.83	Fundamental Frequency		peak
2	*	2460.400	71.02	3.26	74.28	Fundamental Frequency		AVG
3		2483.500	45.56	3.41	48.97	74.00	-25.03	peak
4		2483.500	30.67	3.41	34.08	54.00	-19.92	AVG

Emission Level= Read Level+ Correct Factor

<b>Temperature:</b>	26 °C	<b>Relative Humidity:</b>	55%
<b>Test Voltage:</b>	AC120V 60HZ		
<b>Ant. Pol.</b>	Vertical		
<b>Test Mode:</b>	TX G Mode 2462MHz		
<b>Remark:</b>	N/A		

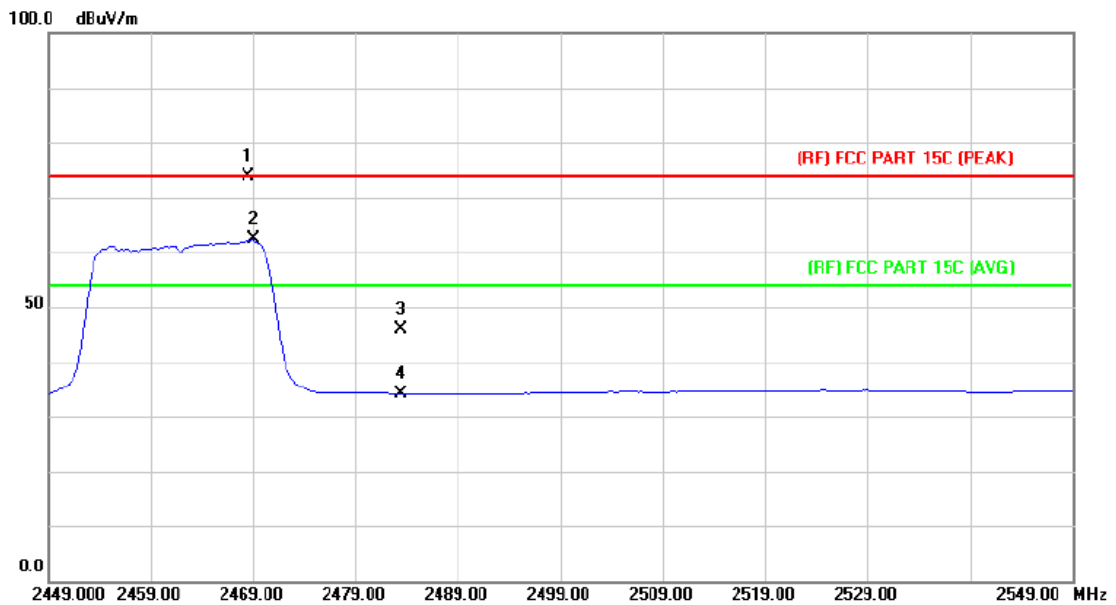

No.	Mk.	Freq. MHz	Reading Level dBuV	Correct Factor dB/m	Measure- ment dBuV/m	Limit dBuV/m	Over dB	Detector
1		2468.600	70.57	3.31	73.88	Fundamental Frequency		peak
2	*	2469.000	58.95	3.31	62.26	Fundamental Frequency		AVG
3		2483.500	42.58	3.41	45.99	74.00	-28.01	peak
4		2483.500	30.68	3.41	34.09	54.00	-19.91	AVG

Emission Level= Read Level+ Correct Factor



<b>Temperature:</b>	26 °C	<b>Relative Humidity:</b>	55%
<b>Test Voltage:</b>	AC120V 60HZ		
<b>Ant. Pol.</b>	Horizontal		
<b>Test Mode:</b>	TX N(HT20) Mode 2412MHz		
<b>Remark:</b>	N/A		

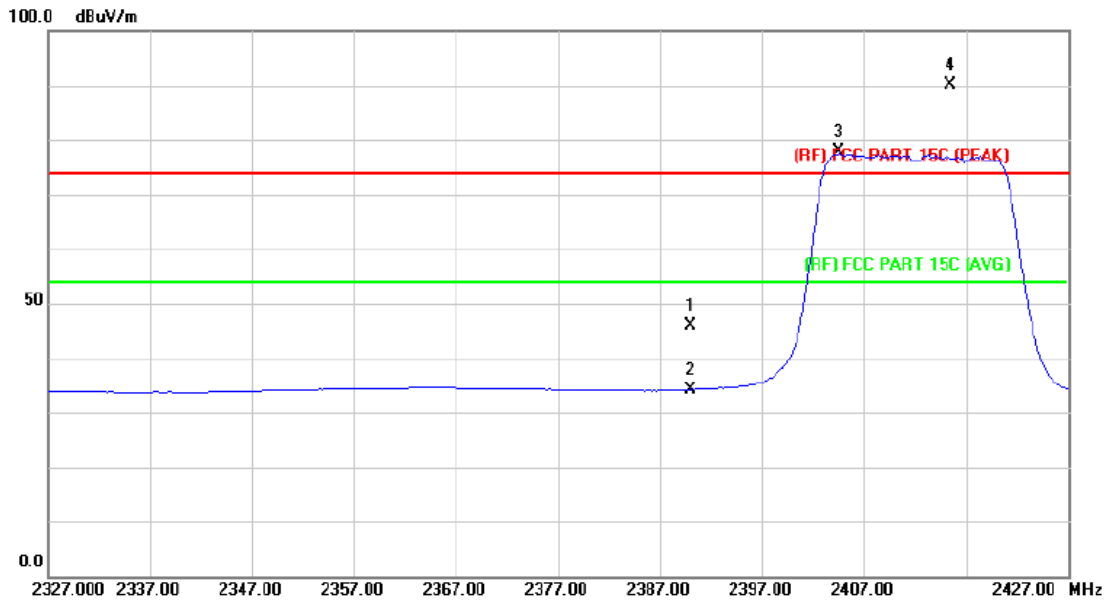

No.	Mk.	Freq. MHz	Reading Level dBuV	Correct Factor dB/m	Measure- ment dBuV/m	Limit dBuV/m	Over dB	Detector
1		2390.000	43.01	2.82	45.83	74.00	-28.17	peak
2		2390.000	31.41	2.82	34.23	54.00	-19.77	AVG
3	*	2404.600	74.96	2.88	77.84	Fundamental Frequency		AVG
4	X	2415.400	87.06	2.96	90.02	Fundamental Frequency		peak

Emission Level= Read Level+ Correct Factor

<b>Temperature:</b>	26 °C	<b>Relative Humidity:</b>	55%
<b>Test Voltage:</b>	AC120V 60HZ		
<b>Ant. Pol.</b>	Vertical		
<b>Test Mode:</b>	TX N(HT20) Mode 2412MHz		
<b>Remark:</b>	N/A		

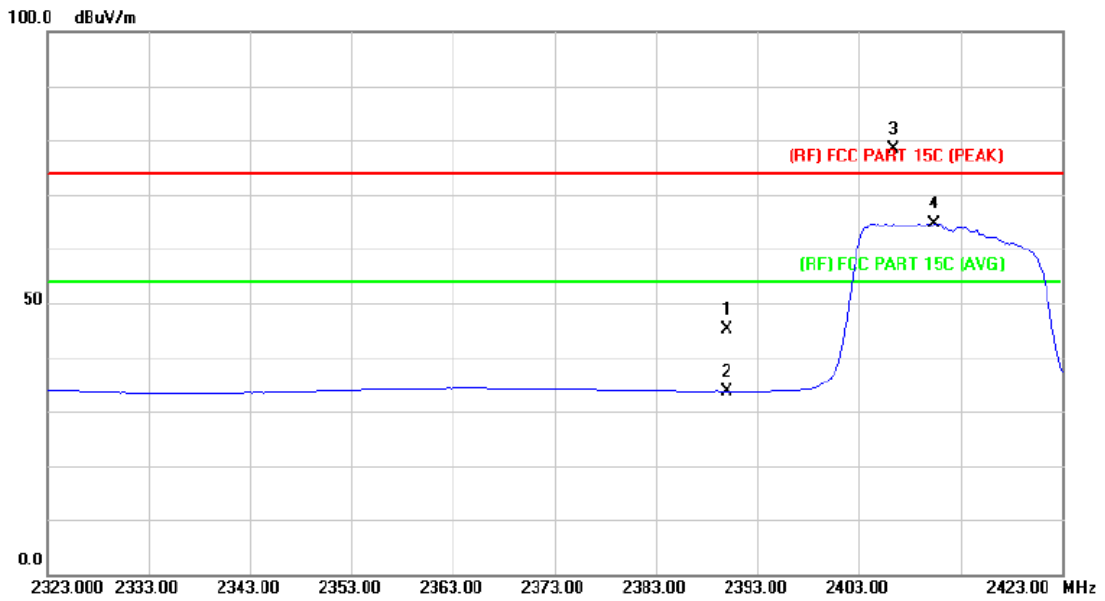

No.	Mk.	Freq. MHz	Reading Level dBuV	Correct Factor dB/m	Measure- ment dBuV/m	Limit dBuV/m	Over dB	Detector
1		2390.000	42.38	2.82	45.20	74.00	-28.80	peak
2		2390.000	30.91	2.82	33.73	54.00	-20.27	AVG
3	X	2406.400	75.52	2.90	78.42	Fundamental Frequency		peak
4	*	2410.400	61.81	2.93	64.74	Fundamental Frequency		AVG

Emission Level= Read Level+ Correct Factor

<b>Temperature:</b>	26 °C	<b>Relative Humidity:</b>	55%
<b>Test Voltage:</b>	AC120V 60HZ		
<b>Ant. Pol.</b>	Horizontal		
<b>Test Mode:</b>	TX N(HT20) Mode 2462MHz		
<b>Remark:</b>	N/A		

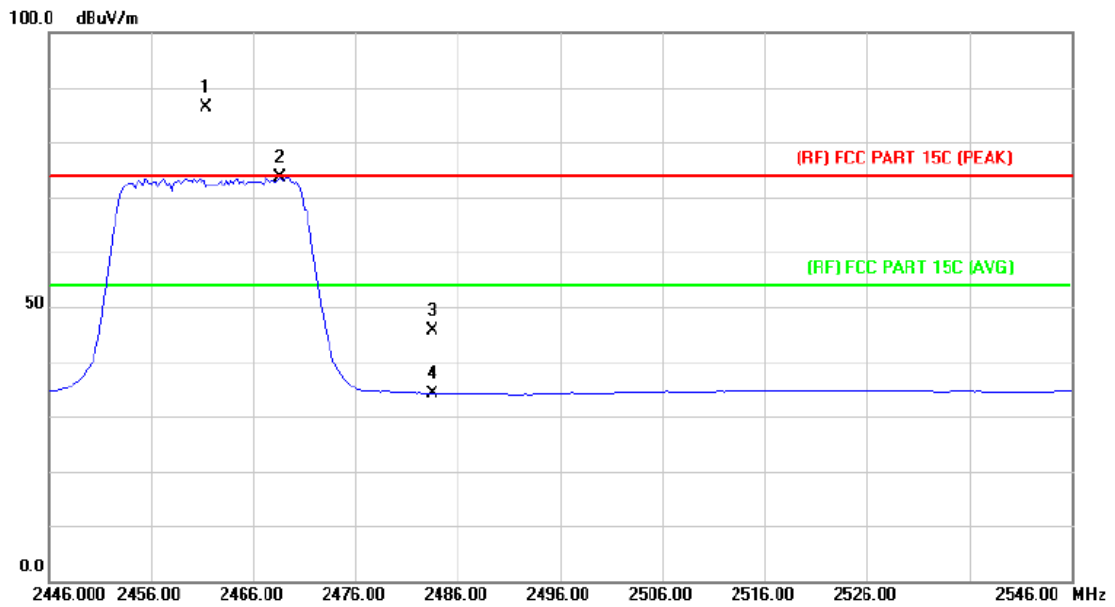

No.	Mk.	Freq. MHz	Reading Level dBuV	Correct Factor dB/m	Measure- ment dBuV/m	Limit dBuV/m	Over dB	Detector
1	X	2461.400	83.23	3.27	86.50	Fundamental Frequency		peak
2	*	2468.600	70.43	3.31	73.74	Fundamental Frequency		AVG
3		2483.500	42.31	3.41	45.72	74.00	-28.28	peak
4		2483.500	30.66	3.41	34.07	54.00	-19.93	AVG

Emission Level= Read Level+ Correct Factor

<b>Temperature:</b>	26 °C	<b>Relative Humidity:</b>	55%
<b>Test Voltage:</b>	AC120V 60HZ		
<b>Ant. Pol.</b>	Vertical		
<b>Test Mode:</b>	TX N(HT20) Mode 2462MHz		
<b>Remark:</b>	N/A		

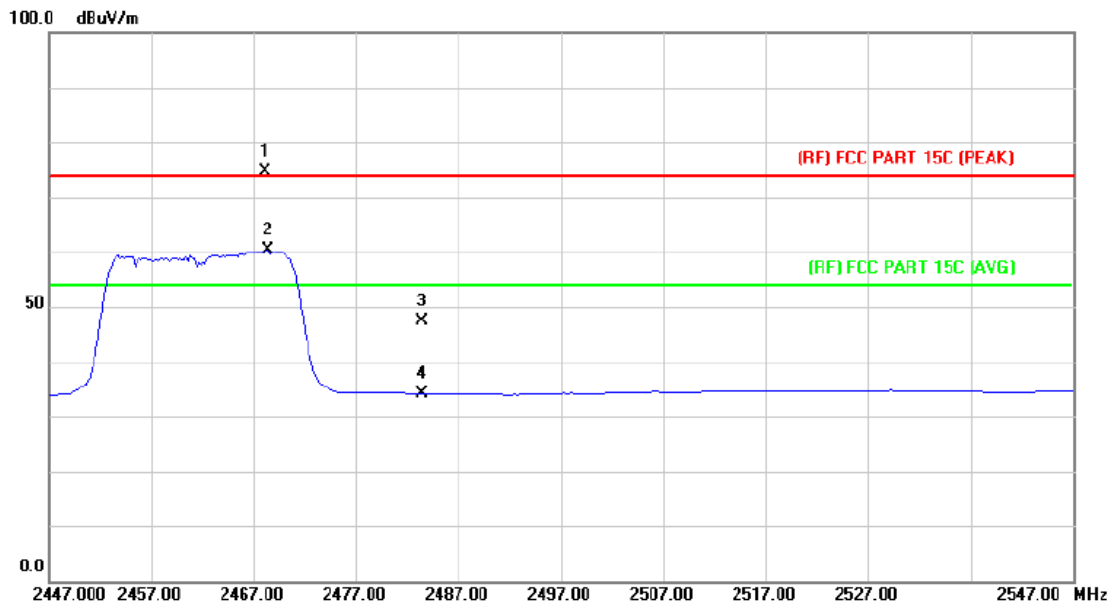

No.	Mk.	Freq. MHz	Reading Level dBuV	Correct Factor dB/m	Measure- ment dBuV/m	Limit dBuV/m	Over dB	Detector
1	X	2468.200	71.37	3.31	74.68	Fundamental Frequency		peak
2	*	2468.400	57.12	3.31	60.43	Fundamental Frequency		AVG
3		2483.500	43.95	3.41	47.36	74.00	-26.64	peak
4		2483.500	30.68	3.41	34.09	54.00	-19.91	AVG

Emission Level= Read Level+ Correct Factor

<b>Temperature:</b>	26 °C	<b>Relative Humidity:</b>	55%
<b>Test Voltage:</b>	AC120V 60HZ		
<b>Ant. Pol.</b>	Horizontal		
<b>Test Mode:</b>	TX N(HT40) Mode 2422MHz		
<b>Remark:</b>	N/A		

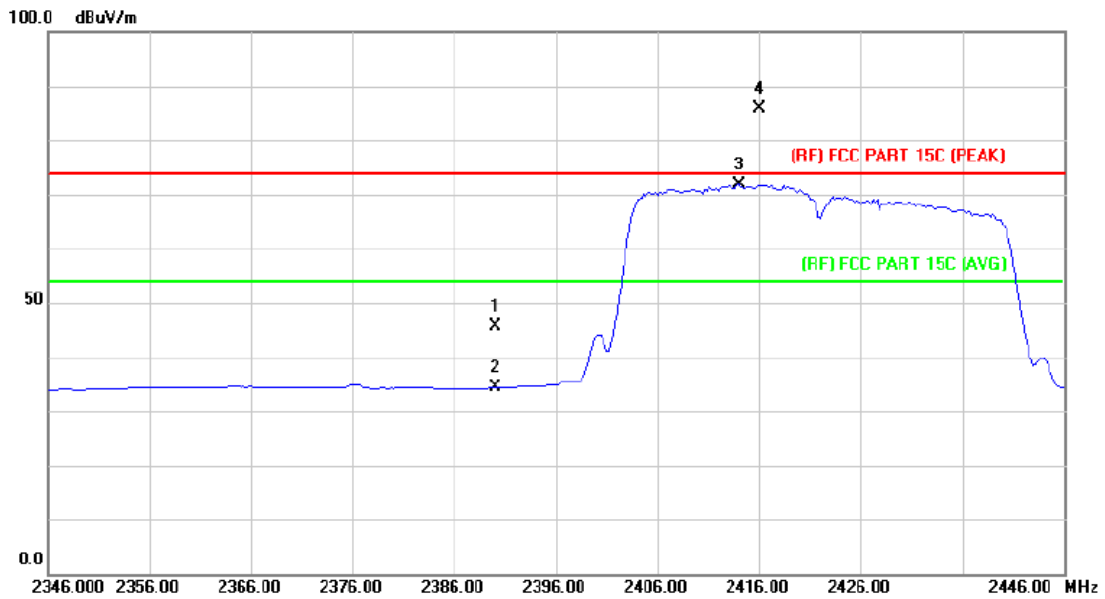

No.	Mk.	Freq. MHz	Reading Level dBuV	Correct Factor dB/m	Measure- ment dBuV/m	Limit dBuV/m	Over dB	Detector
1		2390.000	42.70	2.82	45.52	74.00	-28.48	peak
2		2390.000	31.49	2.82	34.31	54.00	-19.69	AVG
3	*	2414.000	68.83	2.95	71.78	Fundamental Frequency		AVG
4	X	2416.000	83.01	2.97	85.98	Fundamental Frequency		peak

Emission Level= Read Level+ Correct Factor

<b>Temperature:</b>	26 °C	<b>Relative Humidity:</b>	55%
<b>Test Voltage:</b>	AC120V 60HZ		
<b>Ant. Pol.</b>	Vertical		
<b>Test Mode:</b>	TX N(HT40) Mode 2422MHz		
<b>Remark:</b>	N/A		

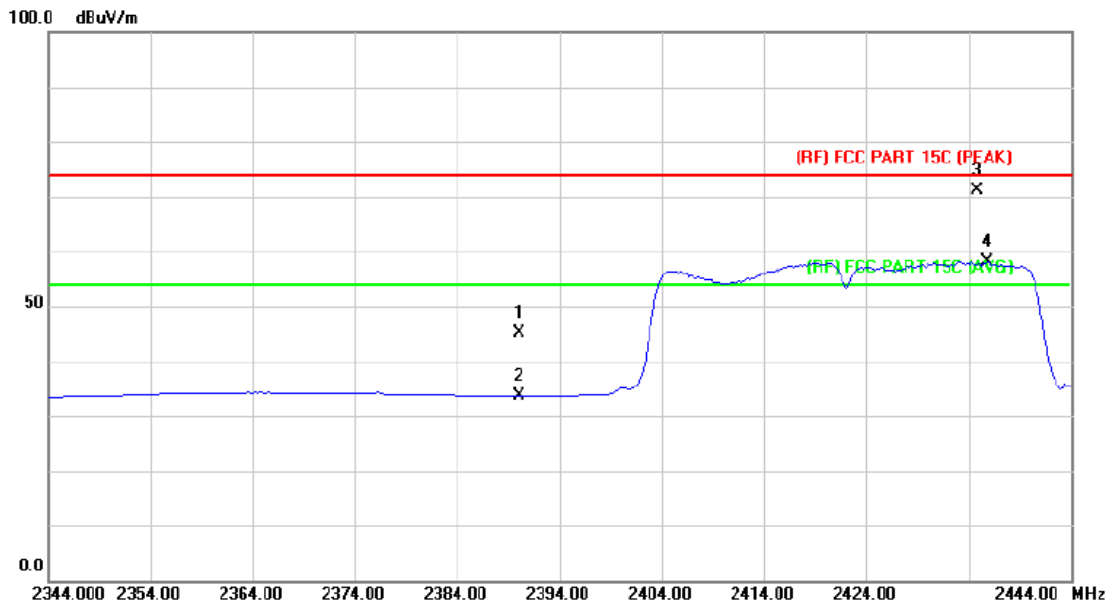

No.	Mk.	Freq. MHz	Reading Level dBuV	Correct Factor dB/m	Measure- ment dBuV/m	Limit dBuV/m	Over dB	Detector
1		2390.000	42.31	2.82	45.13	74.00	-28.87	peak
2		2390.000	30.81	2.82	33.63	54.00	-20.37	AVG
3		2434.800	68.08	3.08	71.16	Fundamental Frequency		peak
4	*	2435.800	55.02	3.09	58.11	Fundamental Frequency		AVG

Emission Level= Read Level+ Correct Factor

<b>Temperature:</b>	26 °C	<b>Relative Humidity:</b>	55%
<b>Test Voltage:</b>	AC120V 60HZ		
<b>Ant. Pol.</b>	Horizontal		
<b>Test Mode:</b>	TX N(HT40) Mode 2452MHz		
<b>Remark:</b>	N/A		

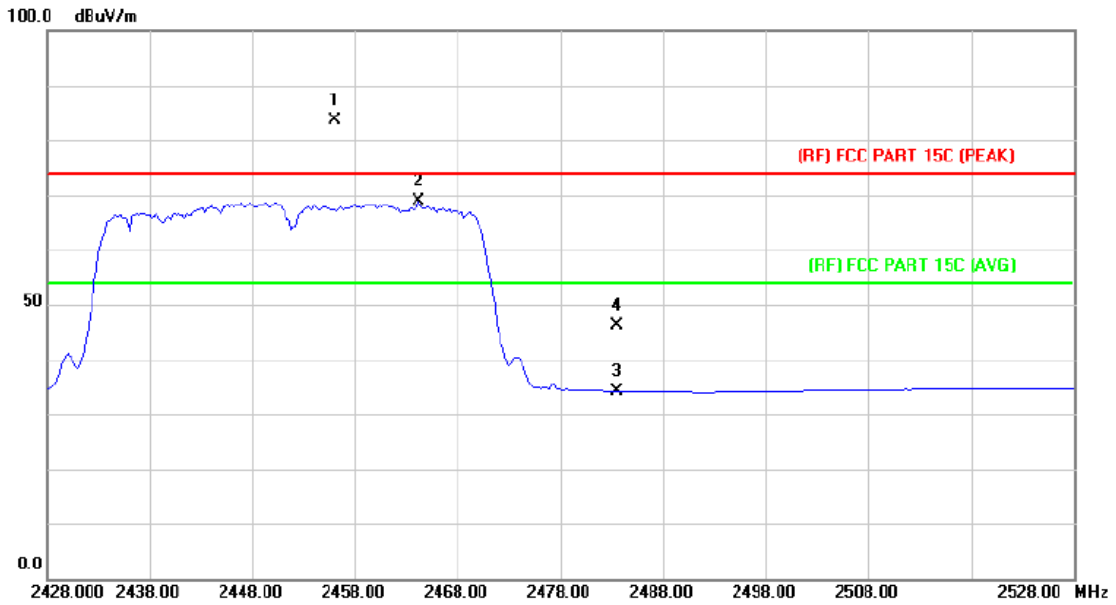

No.	Mk.	Freq. MHz	Reading Level dBuV	Correct Factor dB/m	Measure- ment dBuV/m	Limit dBuV/m	Over dB	Detector
1	*	2456.000	80.37	3.23	83.60	Fundamental Frequency		peak
2		2464.200	65.61	3.28	68.89	Fundamental Frequency		AVG
3		2483.500	30.68	3.41	34.09	74.00	-39.91	AVG
4		2483.500	42.60	3.41	46.01	74.00	-27.99	peak

Emission Level= Read Level+ Correct Factor

<b>Temperature:</b>	26 °C	<b>Relative Humidity:</b>	55%
<b>Test Voltage:</b>	AC120V 60HZ		
<b>Ant. Pol.</b>	Vertical		
<b>Test Mode:</b>	TX N(HT40) Mode 2452MHz		
<b>Remark:</b>	N/A		

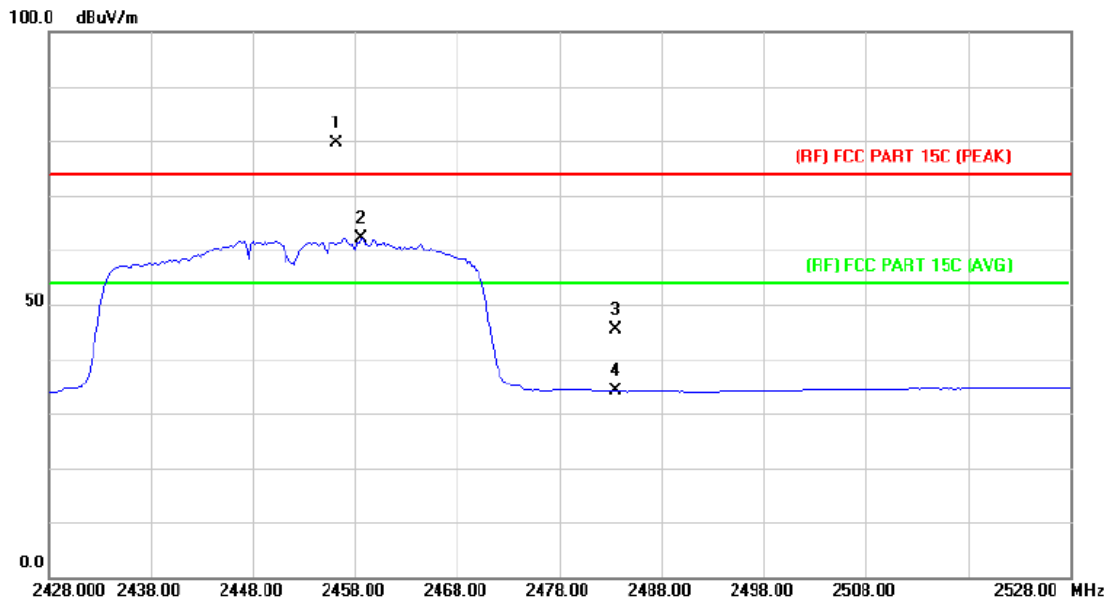

No.	Mk.	Freq. MHz	Reading Level dBuV	Correct Factor dB/m	Measure- ment dBuV/m	Limit dBuV/m	Over dB	Detector
1	X	2456.200	76.36	3.23	79.59	Fundamental Frequency		peak
2	*	2458.600	58.84	3.24	62.08	Fundamental Frequency		AVG
3		2483.500	42.04	3.41	45.45	74.00	-28.55	peak
4		2483.500	30.64	3.41	34.05	54.00	-19.95	AVG

Emission Level= Read Level+ Correct Factor



**(2) Conducted Test**

Temperature:	25 °C	Relative Humidity:	55%
Test Voltage:	AC120V 60HZ		
Test Mode:	TX B Mode 2412MHz / TX B Mode 2462MHz		
Remark:	The EUT is programed in continuously transmitting mode		

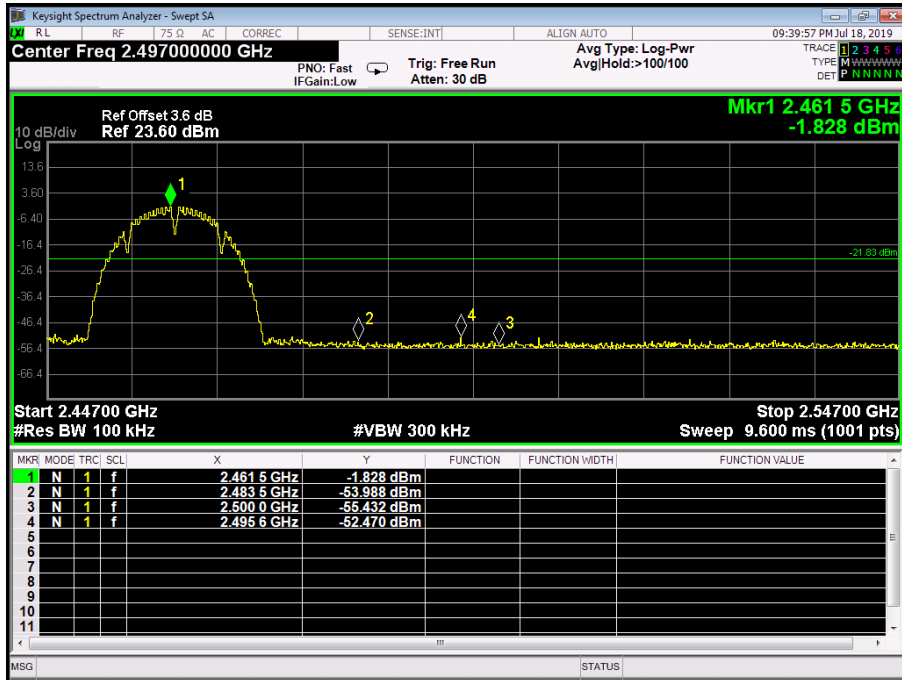
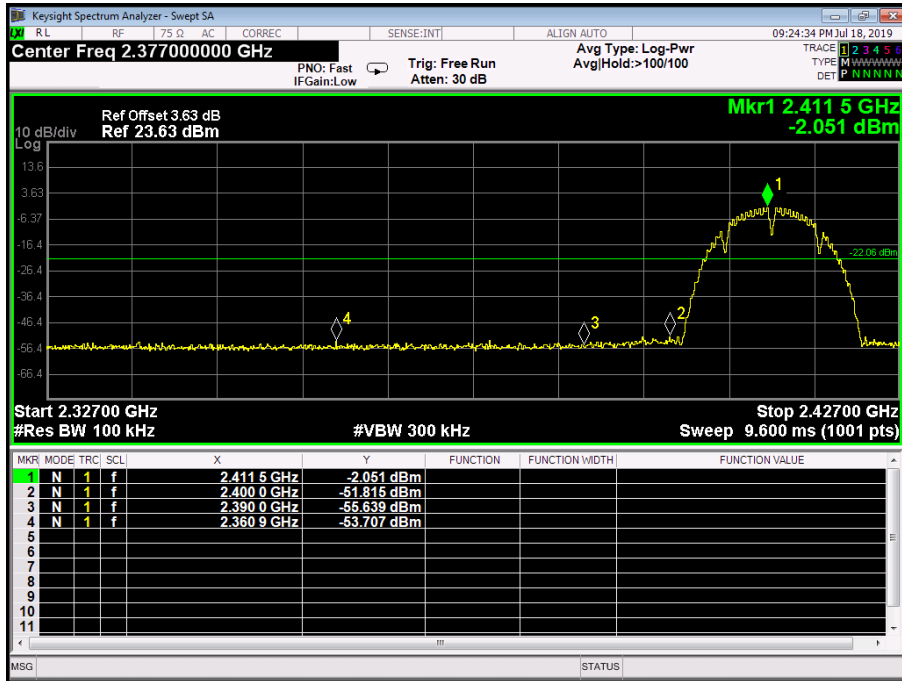

Temperature:	25 °C	Relative Humidity:	55%
Test Voltage:	AC120V 60HZ		
Test Mode:	TX G Mode 2412MHz / TX G Mode 2462MHz		
Remark:	The EUT is programed in continuously transmitting mode		

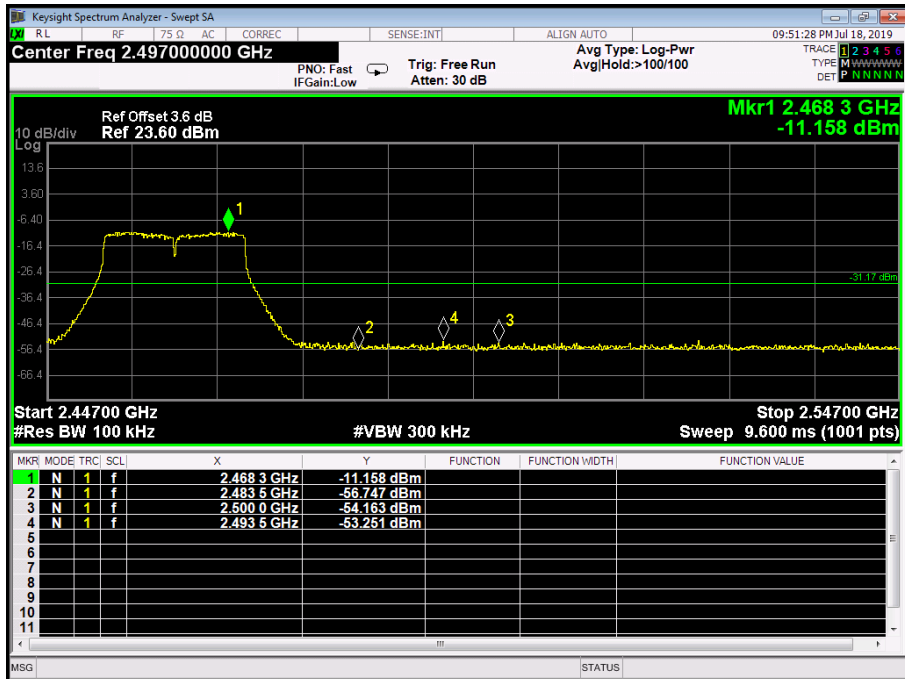
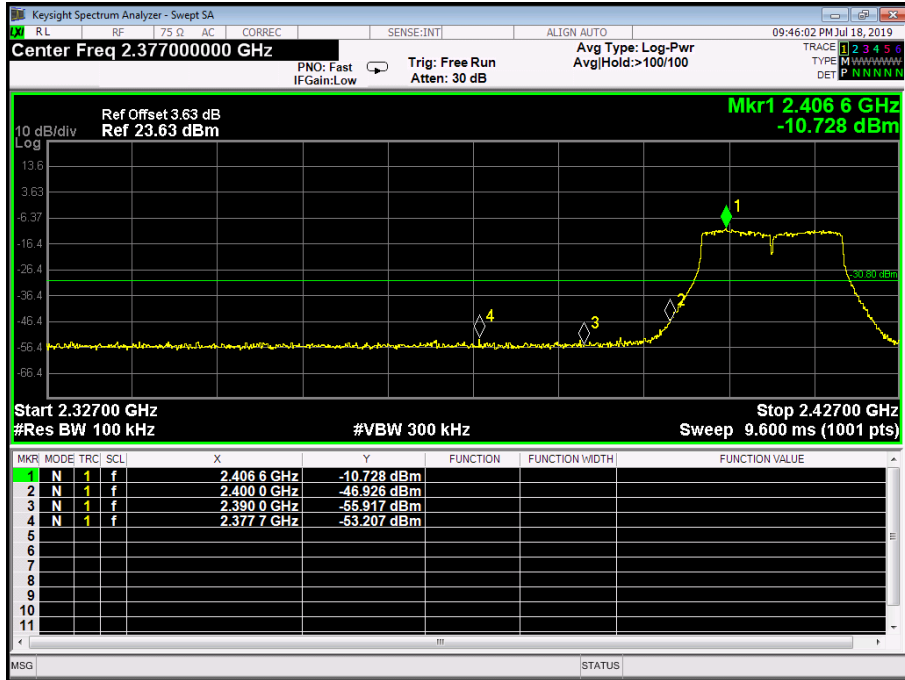

<b>Temperature:</b>	25 °C	<b>Relative Humidity:</b>	55%
<b>Test Voltage:</b>	AC120V 60HZ		
<b>Test Mode:</b>	TX N(HT20) Mode 2412MHz / TX N(HT20) Mode 2462MHz		
<b>Remark:</b>	The EUT is programed in continuously transmitting mode		

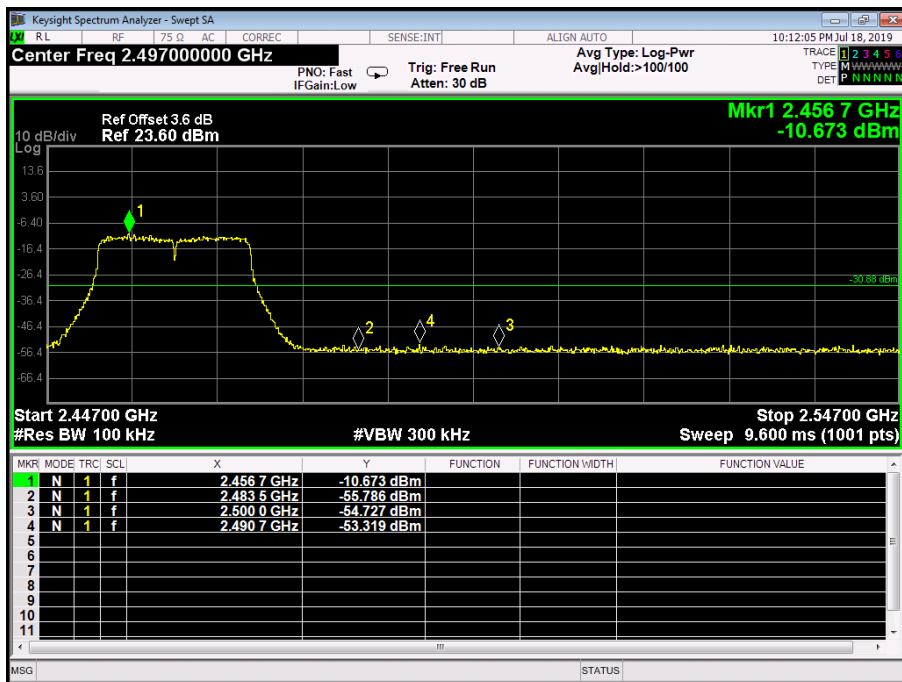
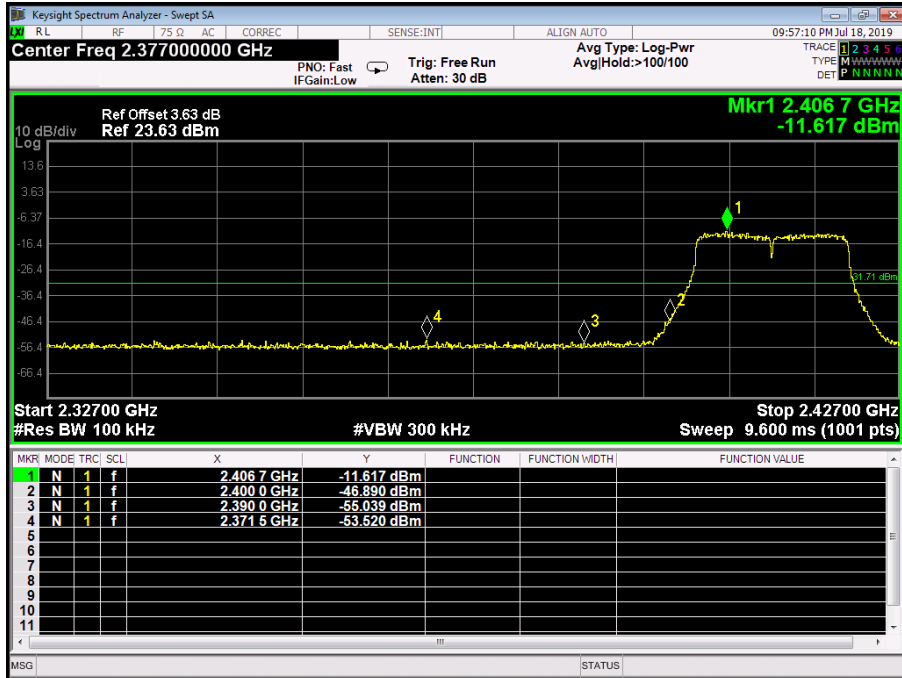

<b>Temperature:</b>	25 °C	<b>Relative Humidity:</b>	55%
<b>Test Voltage:</b>	AC120V 60HZ		
<b>Test Mode:</b>	TX N(HT40) Mode 2422MHz / TX N(HT40) Mode 2452MHz		
<b>Remark:</b>	The EUT is programed in continuously transmitting mode		

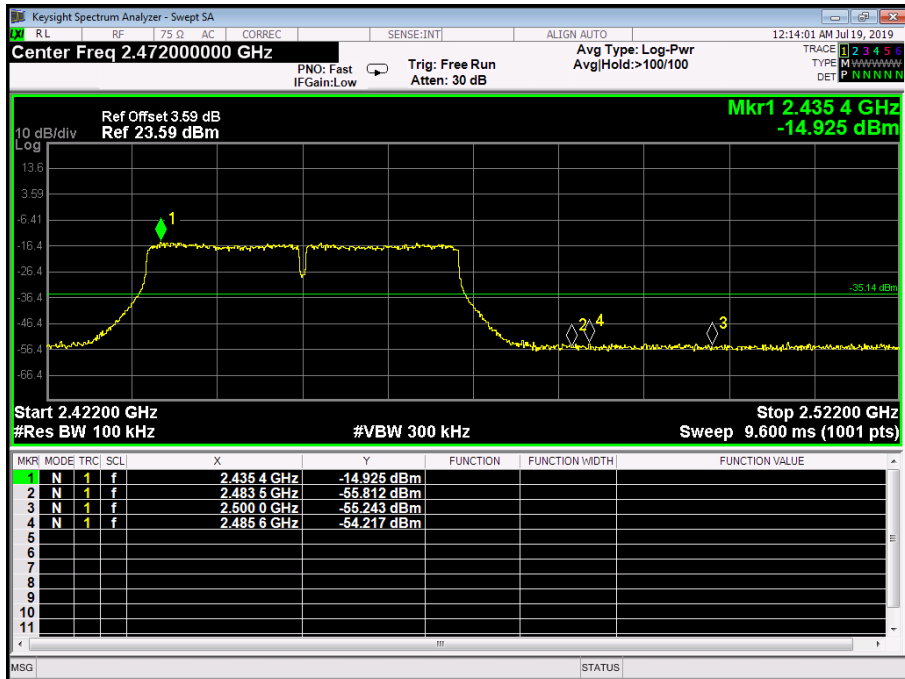
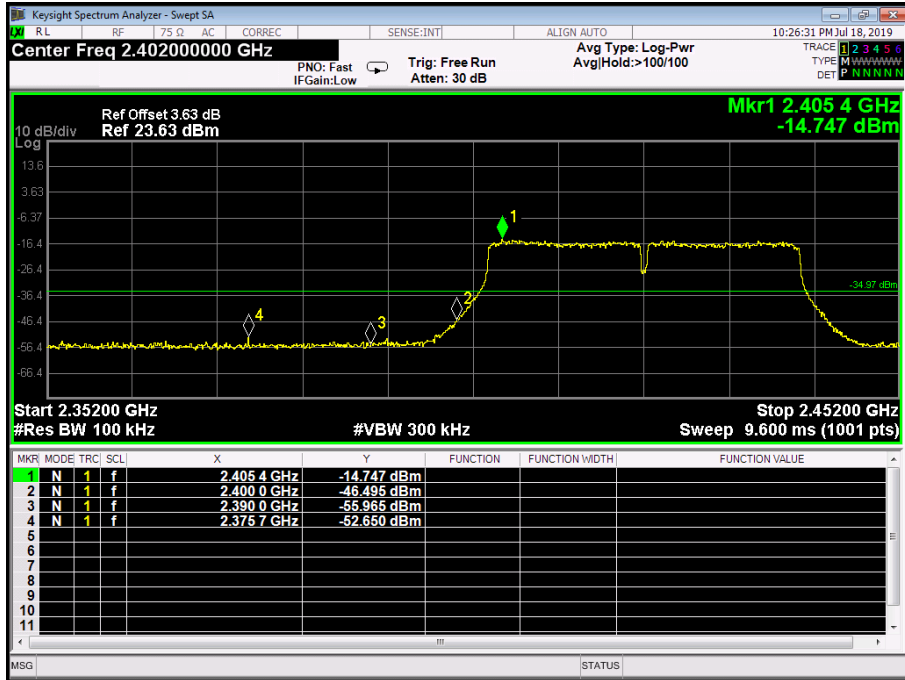

## Attachment D-- Bandwidth Test Data

Temperature:	25 °C	Relative Humidity:	55%
Test Voltage:	AC120V 60HZ		
Test Mode:	TX 802.11B Mode		
Channel frequency (MHz)	6dB Bandwidth (MHz)	99% Bandwidth (MHz)	Limit (MHz)
2412	9.555	13.708	>=0.5
2437	9.546	13.691	
2462	9.099	13.591	

**802.11B Mode**

**2412 MHz**

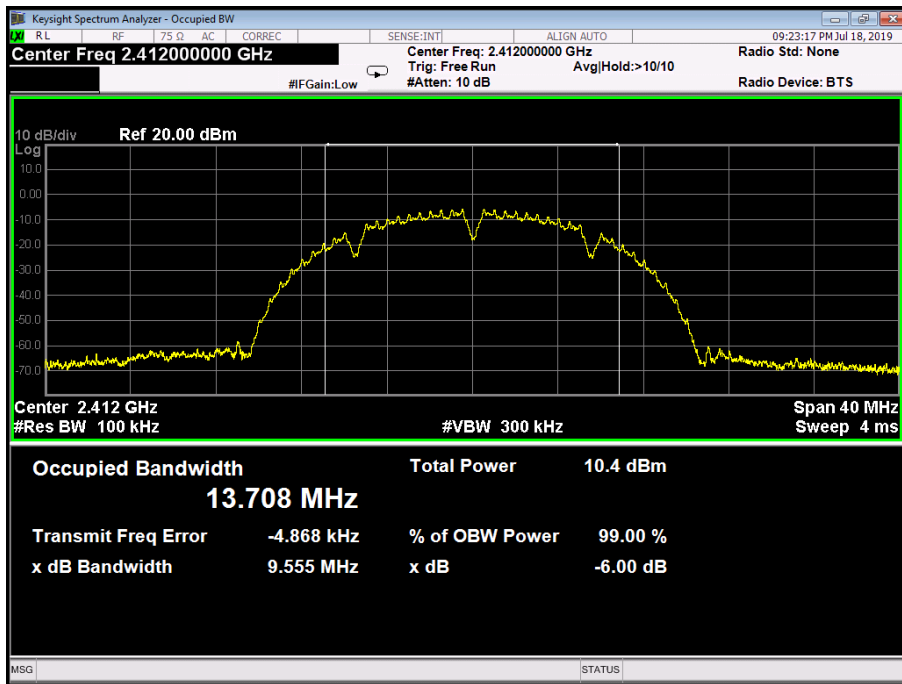

**802.11B Mode**  
**2437 MHz**

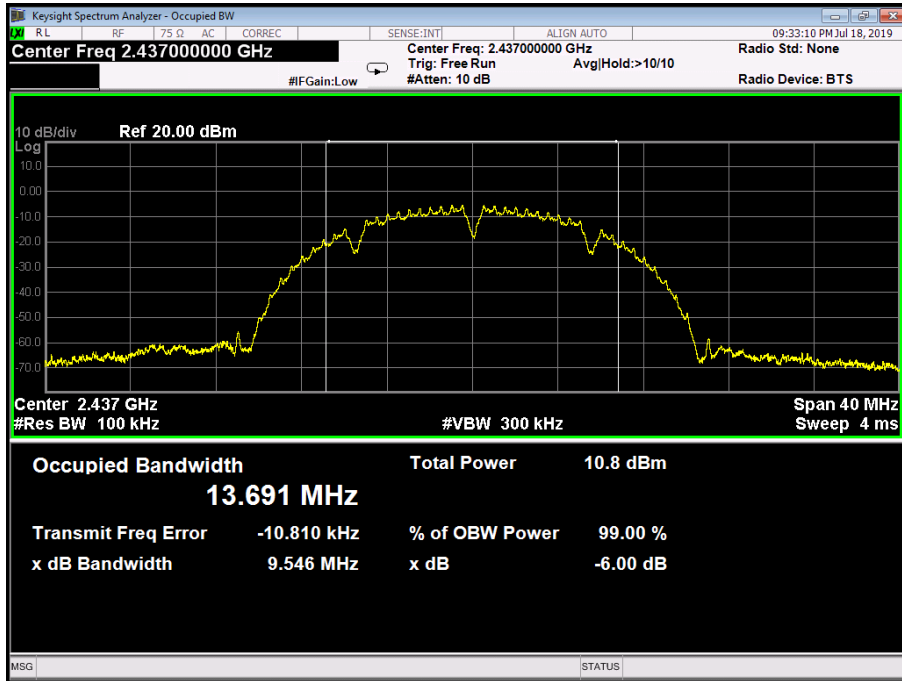

**802.11B Mode**  
**2462 MHz**

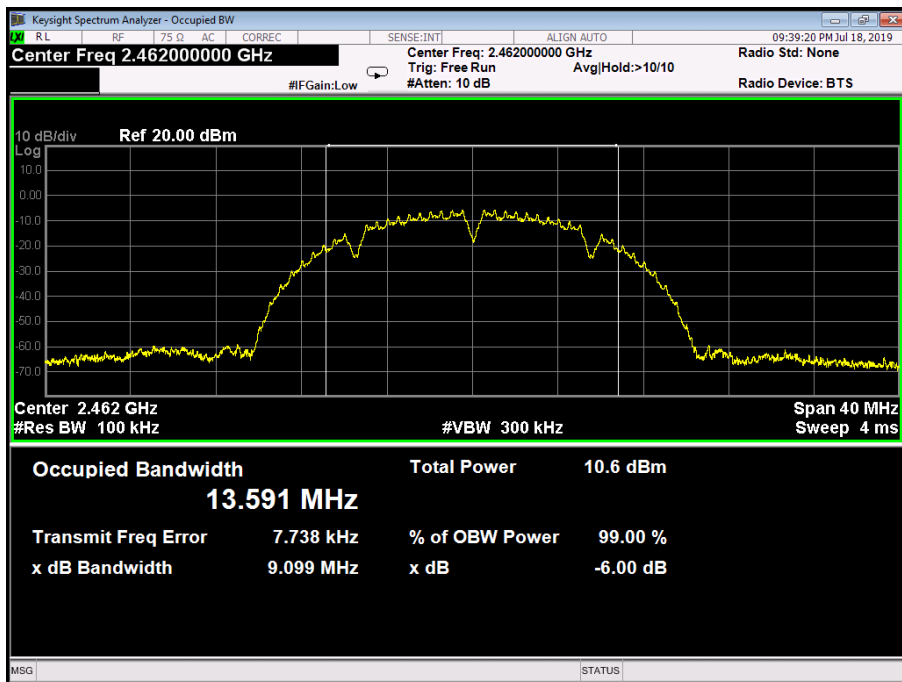

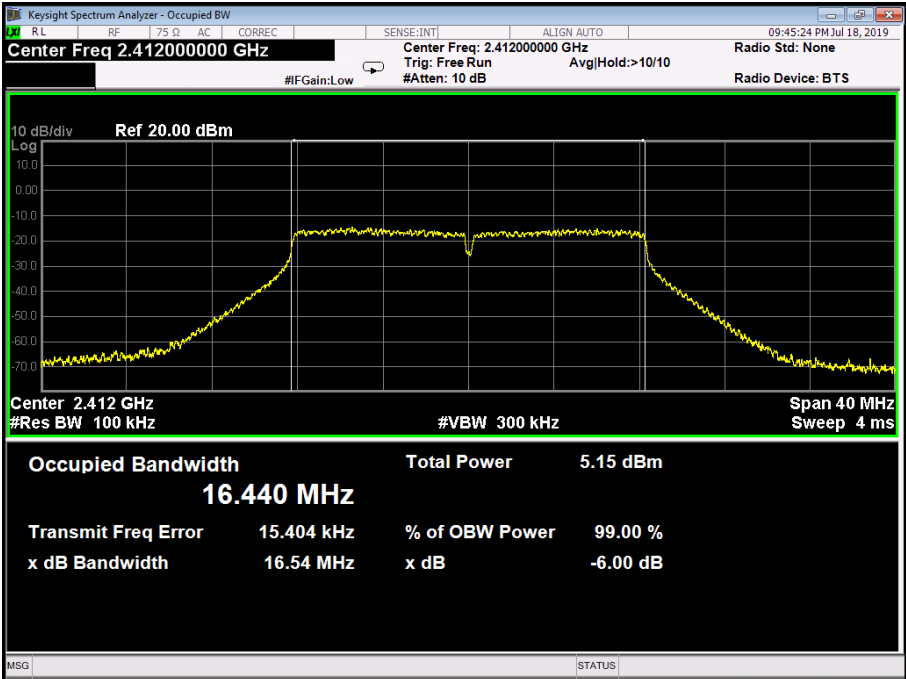
<b>Temperature:</b>	25 °C	<b>Relative Humidity:</b>	55%
<b>Test Voltage:</b>	AC120V 60HZ		
<b>Test Mode:</b>	TX 802.11G Mode		
Channel frequency (MHz)	6dB Bandwidth (MHz)	99% Bandwidth (MHz)	Limit (MHz)
2412	16.54	16.440	>=0.5
2437	16.54	16.455	
2462	16.55	16.422	
<b>802.11G Mode</b>			
<b>2412 MHz</b>			
 <p>Keysight Spectrum Analyzer - Occupied BW</p> <p>Center Freq: 2.41200000 GHz</p> <p>Center Freq: 2.412000000 GHz</p> <p>Trig: Free Run</p> <p>#FGain: Low</p> <p>#Atten: 10 dB</p> <p>Avg/Hold: &gt;10/10</p> <p>Radio Std: None</p> <p>Radio Device: BTS</p> <p>10 dB/div</p> <p>Ref 20.00 dBm</p> <p>Center 2.412 GHz</p> <p>#Res BW 100 kHz</p> <p>#VBW 300 kHz</p> <p>Span 40 MHz</p> <p>Sweep 4 ms</p> <p><b>Occupied Bandwidth 16.440 MHz</b></p> <p>Total Power 5.15 dBm</p> <p>Transmit Freq Error 15.404 kHz</p> <p>% of OBW Power 99.00 %</p> <p>x dB Bandwidth 16.54 MHz</p> <p>x dB -6.00 dB</p>			

**802.11G Mode**

**2437 MHz**

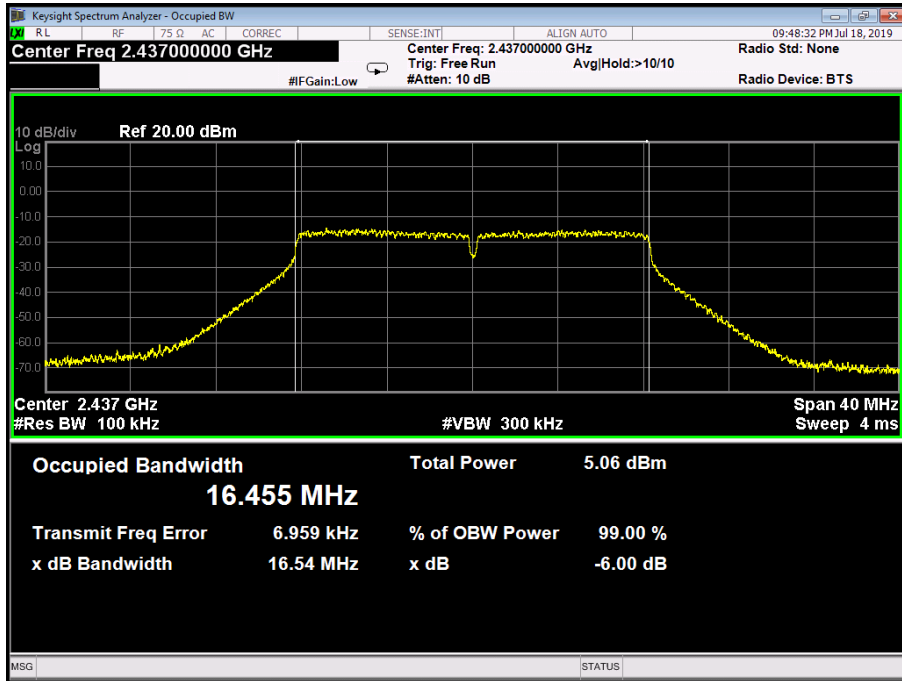

**802.11G Mode**

**2462 MHz**

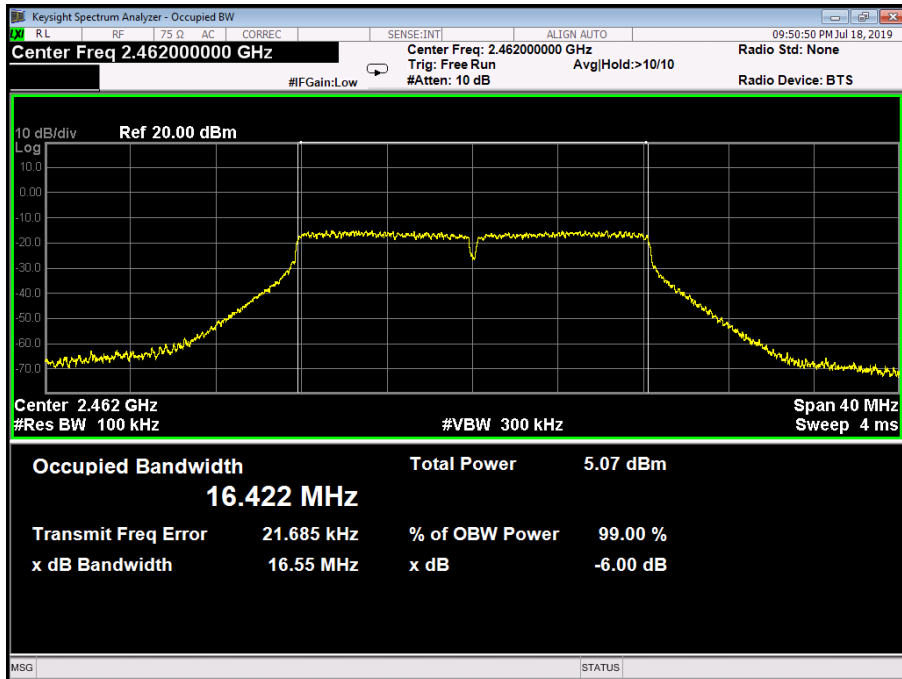



<b>Temperature:</b>	25 °C	<b>Relative Humidity:</b>	55%
<b>Test Voltage:</b>	AC120V 60HZ		
<b>Test Mode:</b>	TX 802.11N(HT20) Mode		
Channel frequency (MHz)	6dB Bandwidth (MHz)	99% Bandwidth (MHz)	Limit (MHz)
2412	17.70	17.619	>=0.5
2437	17.71	17.624	
2462	17.69	17.625	
<b>802.11N(HT20) Mode</b>			

**2412 MHz**

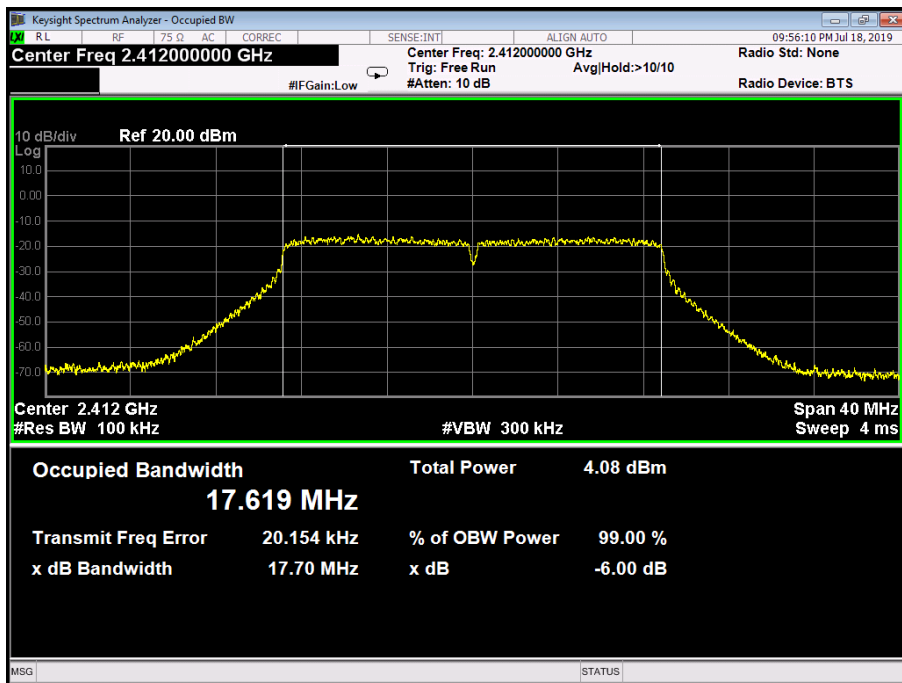

**802.11N(HT20) Mode**  
**2437 MHz**

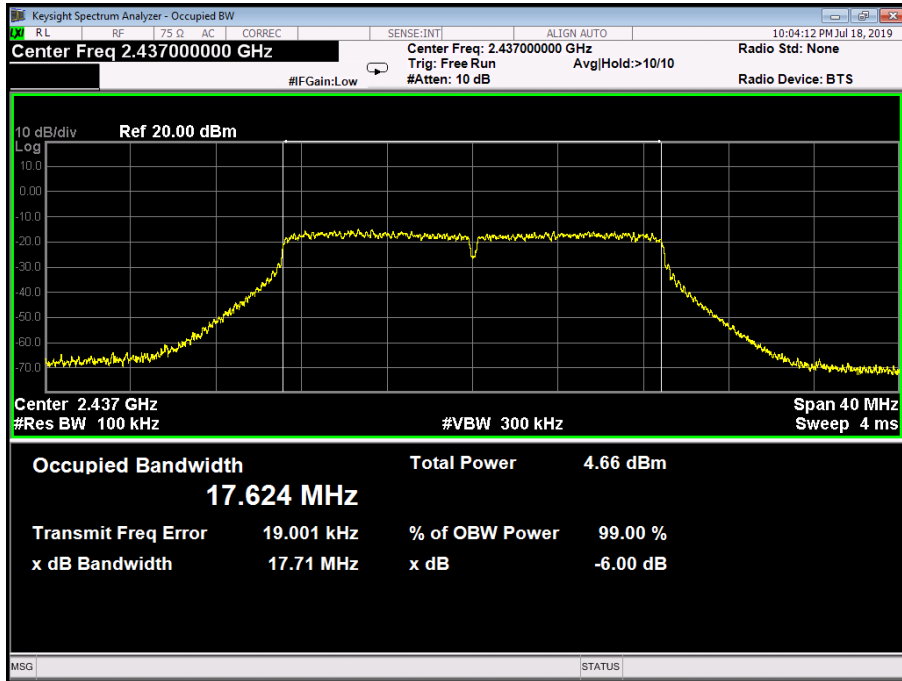

**802.11N(HT20) Mode**  
**2462 MHz**

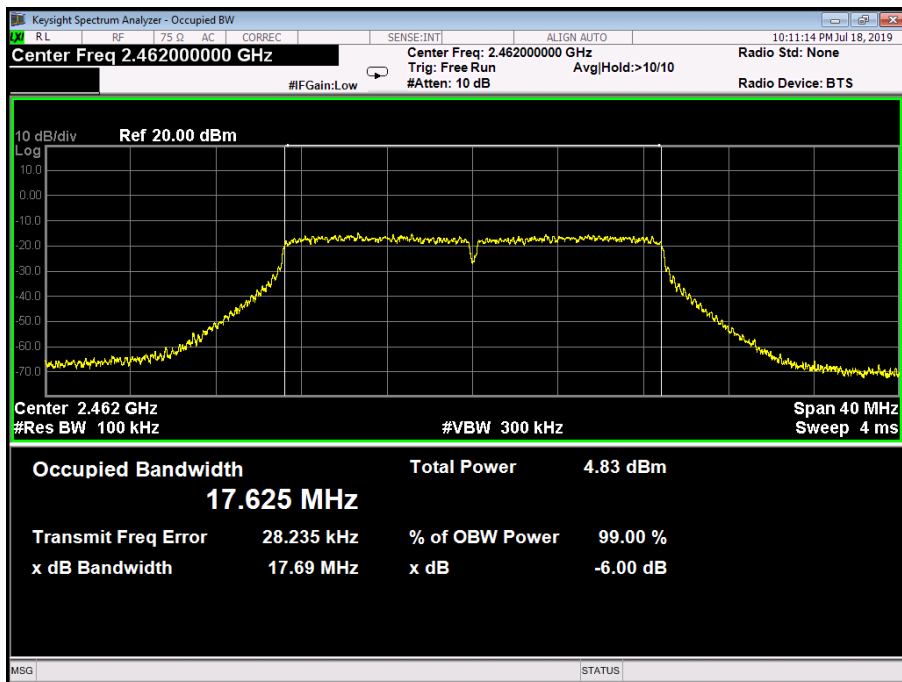

<b>Temperature:</b>	25 °C	<b>Relative Humidity:</b>	55%
<b>Test Voltage:</b>	AC120V 60HZ		
<b>Test Mode:</b>	TX 802.11N(HT40) Mode		
<b>Channel frequency (MHz)</b>	<b>6dB Bandwidth (MHz)</b>	<b>99% Bandwidth (MHz)</b>	<b>Limit (MHz)</b>
2422	36.45	36.148	>=0.5
2437	36.48	36.164	
2452	36.49	36.166	

**802.11N(HT40) Mode**

**2422 MHz**

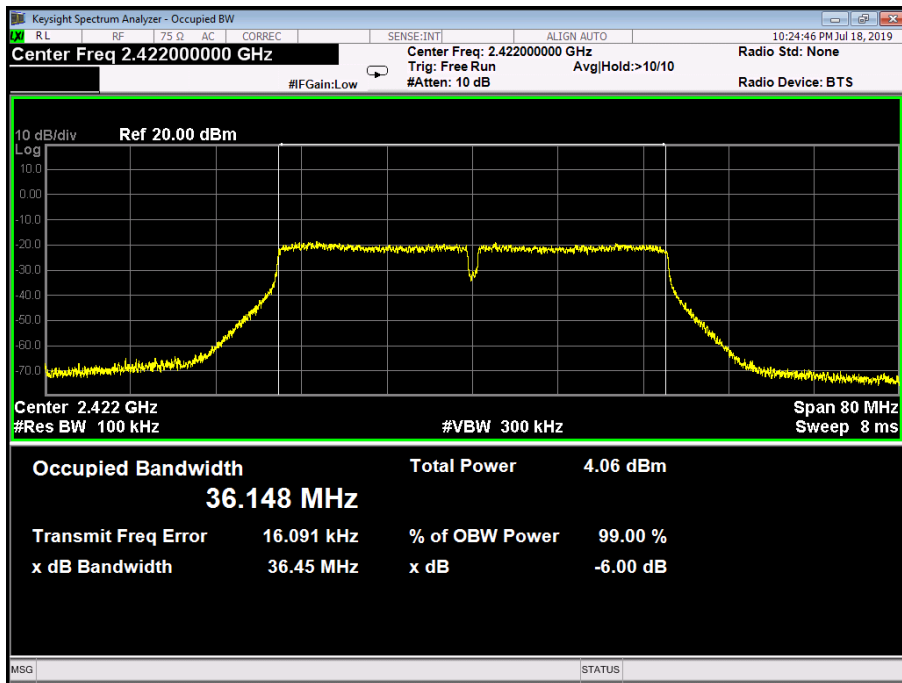

**802.11N(HT40) Mode**  
**2437 MHz**

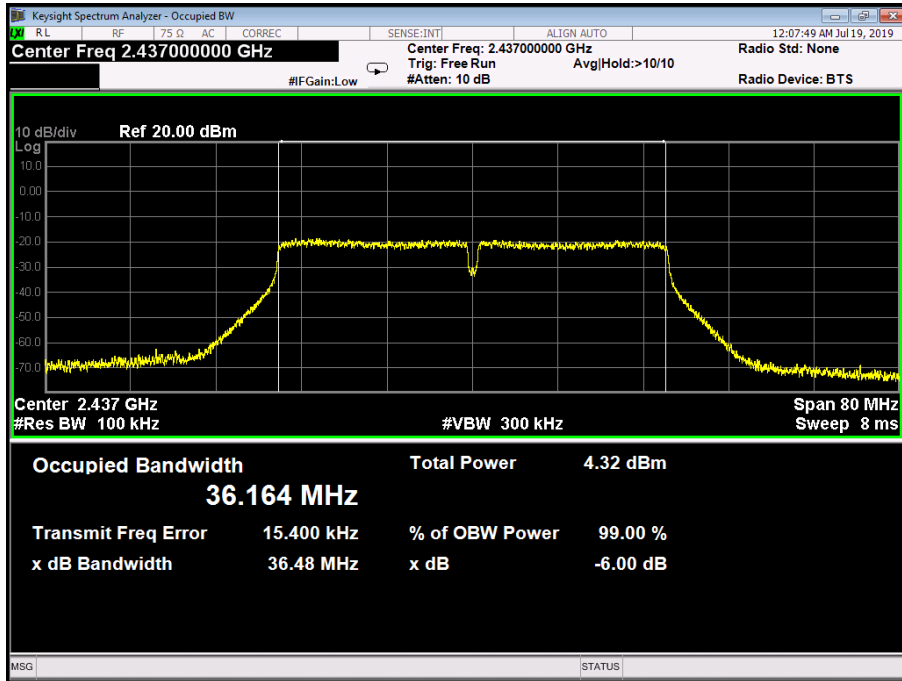

**802.11N(HT20) Mode**  
**2452 MHz**

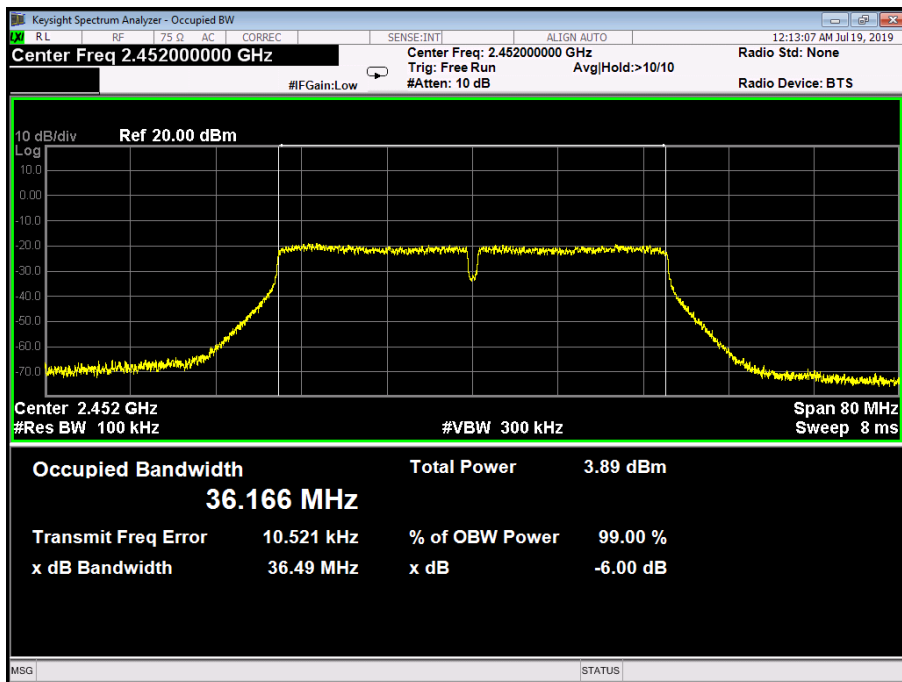

## Attachment E-- Peak Output Power Test Data

<b>Test Conditions:</b>		Continuous Transmitting Mode	
<b>Temperature:</b>		25 °C	<b>Relative Humidity:</b> 55%
<b>Test Voltage:</b>		AC120V 60HZ	
Mode	Channel frequency (MHz)	Test Result (dBm)	Limit (dBm)
802.11b	2412	9.11	30
	2437	9.42	
	2462	9.37	
802.11g	2412	8.39	
	2437	8.18	
	2462	8.31	
802.11n (HT20)	2412	7.54	
	2437	8.07	
	2462	8.25	
802.11n (HT40)	2422	7.36	
	2437	7.41	
	2452	7.00	
<b>Result: PASS</b>			

Duty Cycle		
Mode	Channel frequency (MHz)	Test Result
802.11b	2412	>98%
	2437	
	2462	
802.11g	2412	
	2437	
	2462	
802.11n (HT20)	2412	
	2437	
	2462	
802.11n (HT40)	2422	
	2437	
	2452	
Please see below plots		

**802.11 B Mode 2437 MHz**

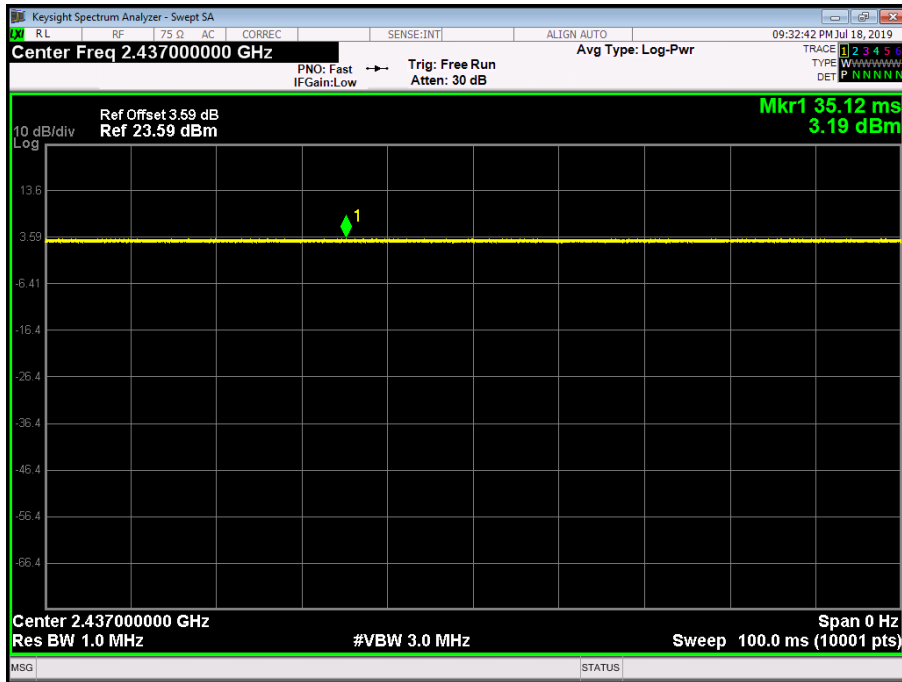

**802.11 G Mode 2437 MHz**

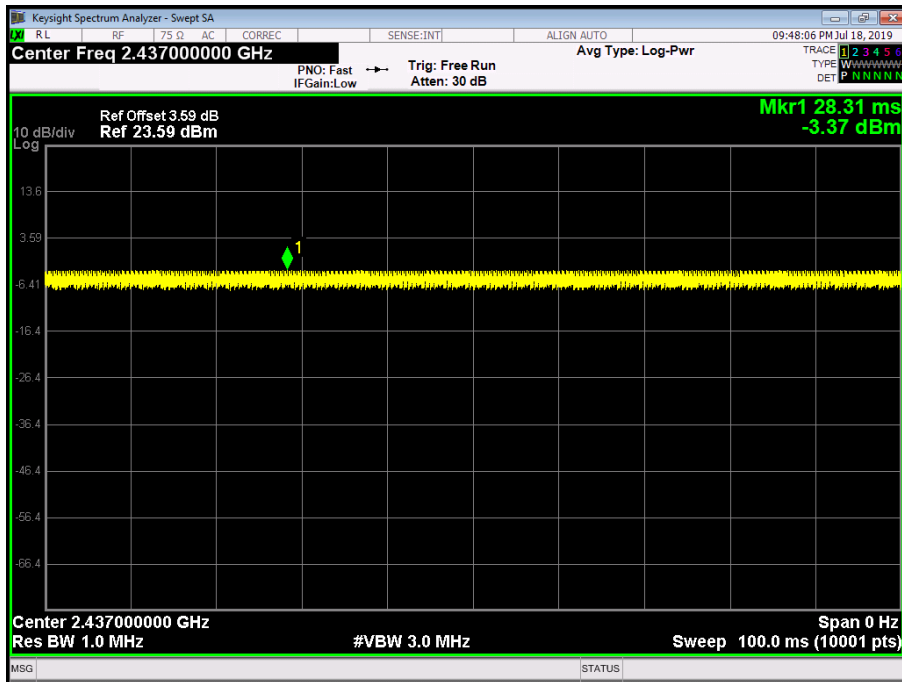

**802.11 N20 Mode 2437 MHz**

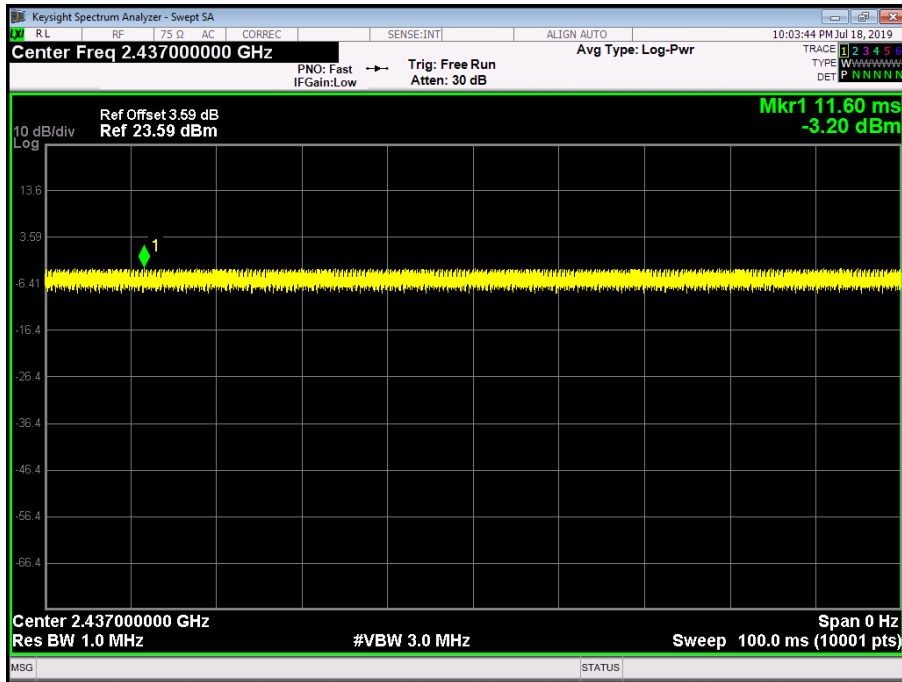

**802.11 N40 Mode 2437 MHz**

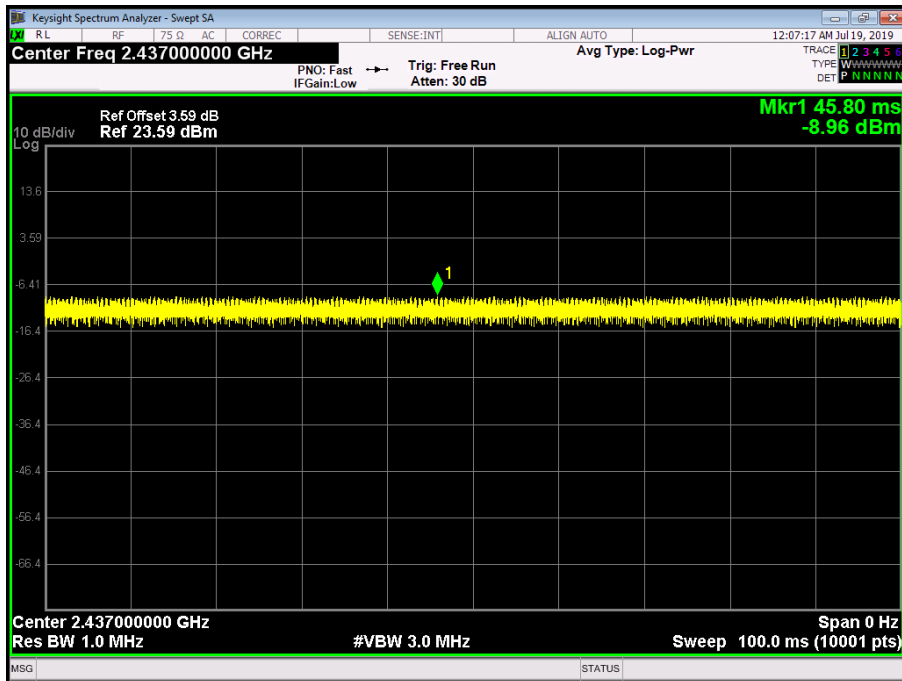

## Attachment F-- Power Spectral Density Test Data

Temperature:	25 °C	Relative Humidity:	55%
Test Voltage:	AC120V 60HZ		
Test Mode:	TX 802.11B Mode		
Channel Frequency (MHz)	Power Density (dBm/3 kHz)	Limit (dBm/3 kHz)	
2412	-22.137	8	
2437	-21.789		
2462	-21.900		

**802.11B Mode**

**2412 MHz**

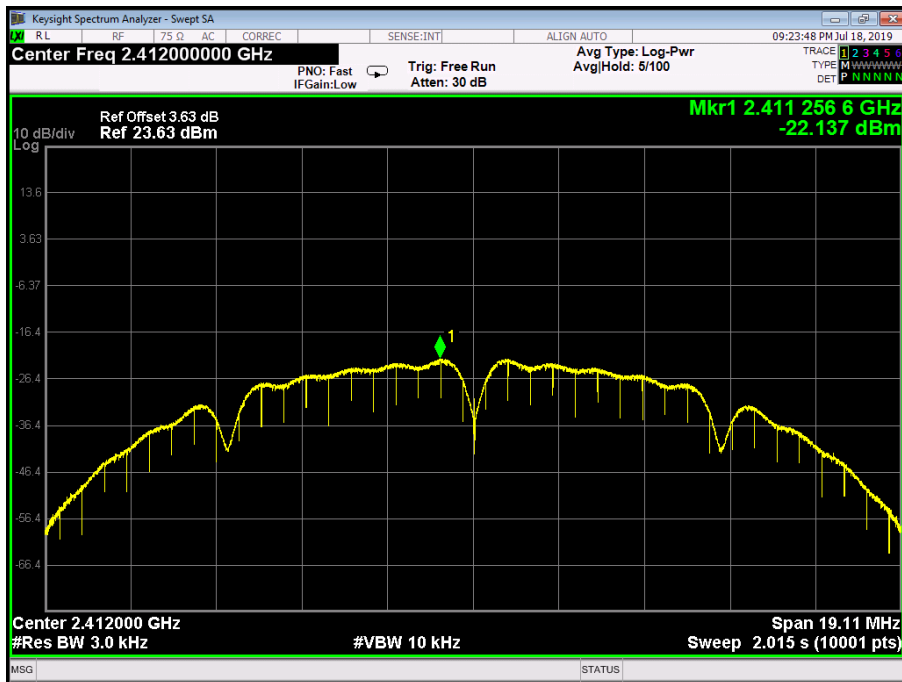



**802.11B Mode**

**2437 MHz**

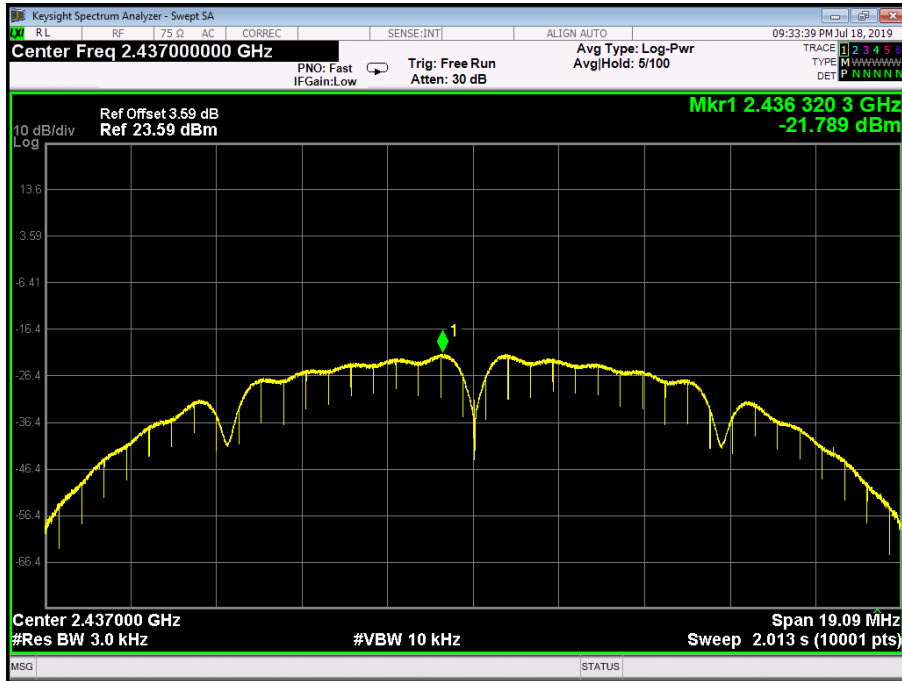

**802.11B Mode**

**2462 MHz**

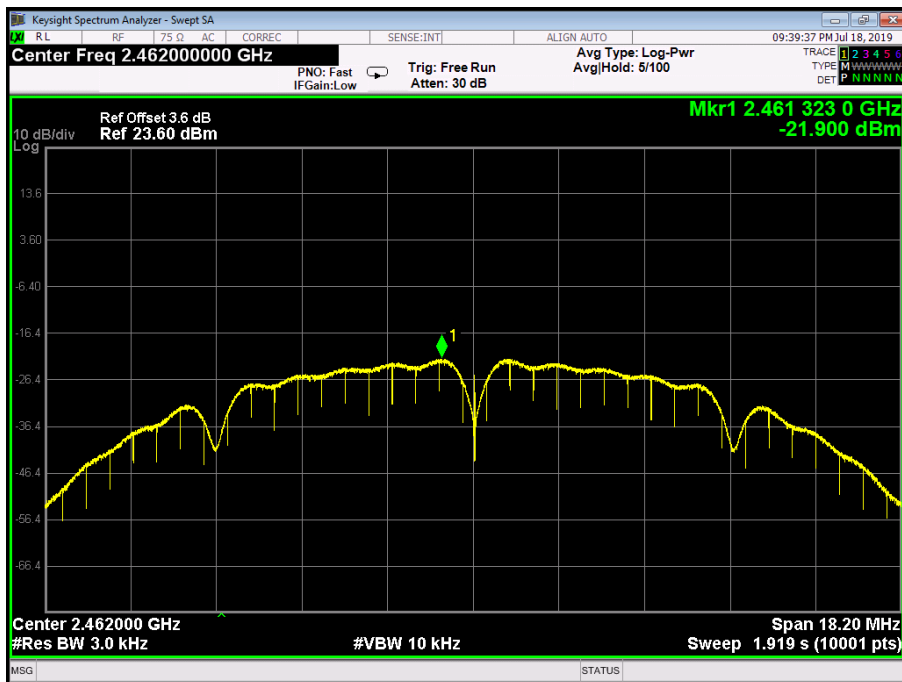

Temperature:	25 °C	Temperature:	25 °C
Test Voltage:	AC120V 60HZ		
Test Mode:	TX 802.11G Mode		
Channel Frequency (MHz)	Power Density (dBm/3 kHz)	Limit (dBm/3 kHz)	
2412	-25.145	8	
2437	-24.871		
2462	-25.290		

**802.11G Mode**

**2412 MHz**

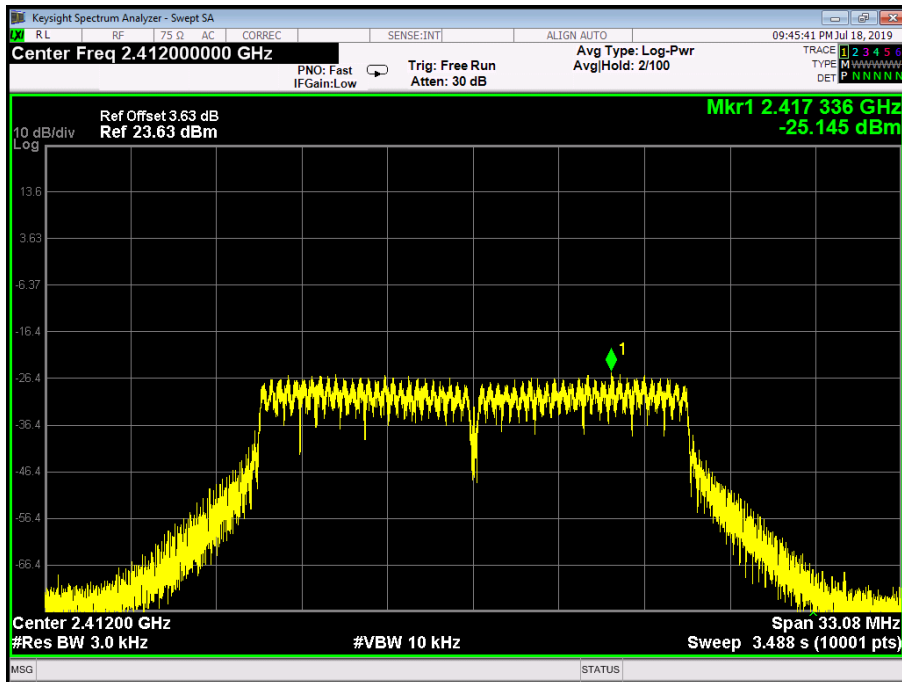

**802.11G Mode**

**2437 MHz**

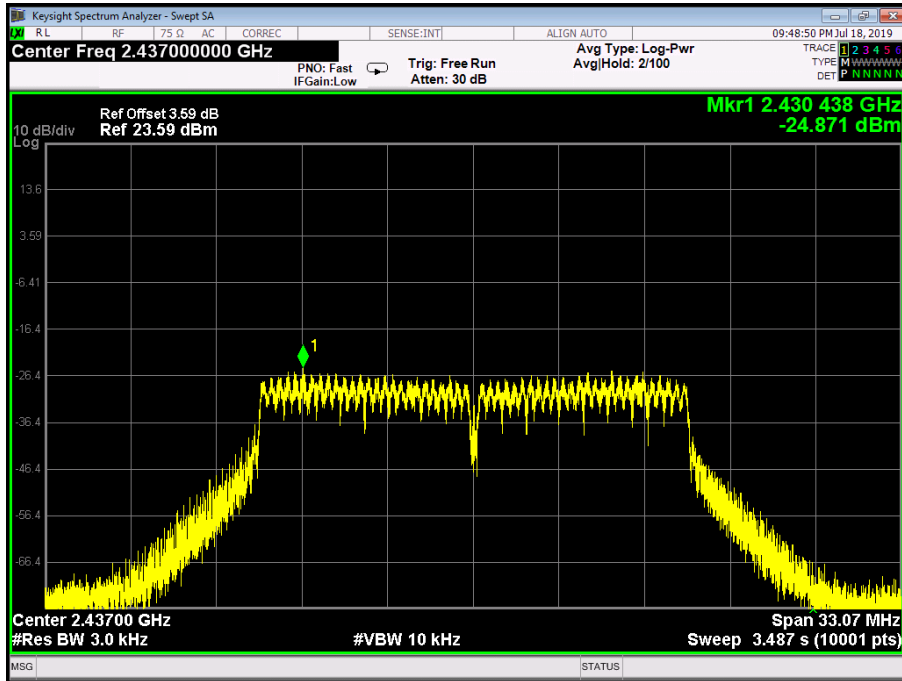

**802.11G Mode**

**2462 MHz**

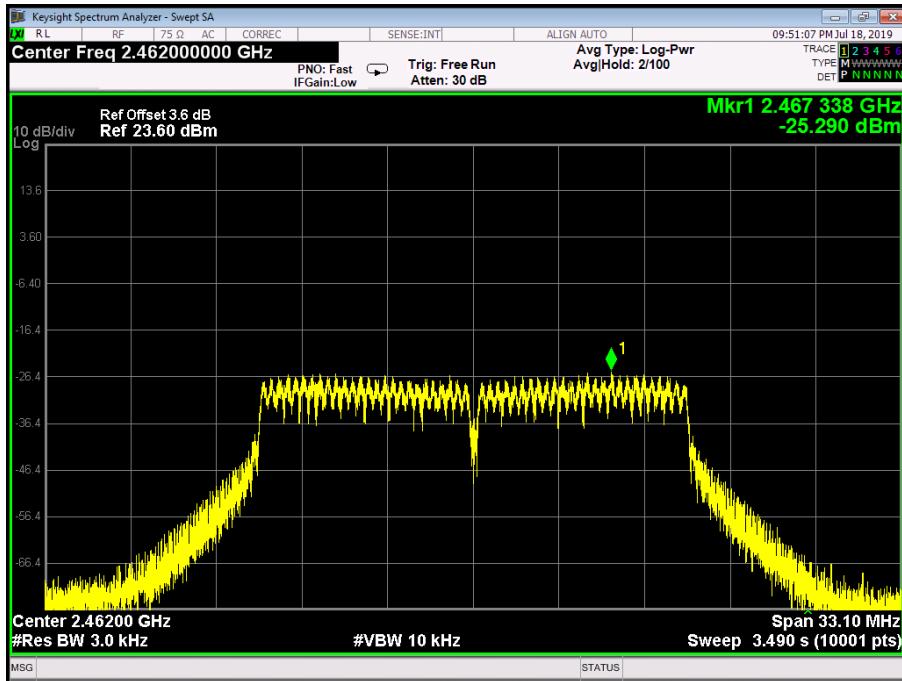

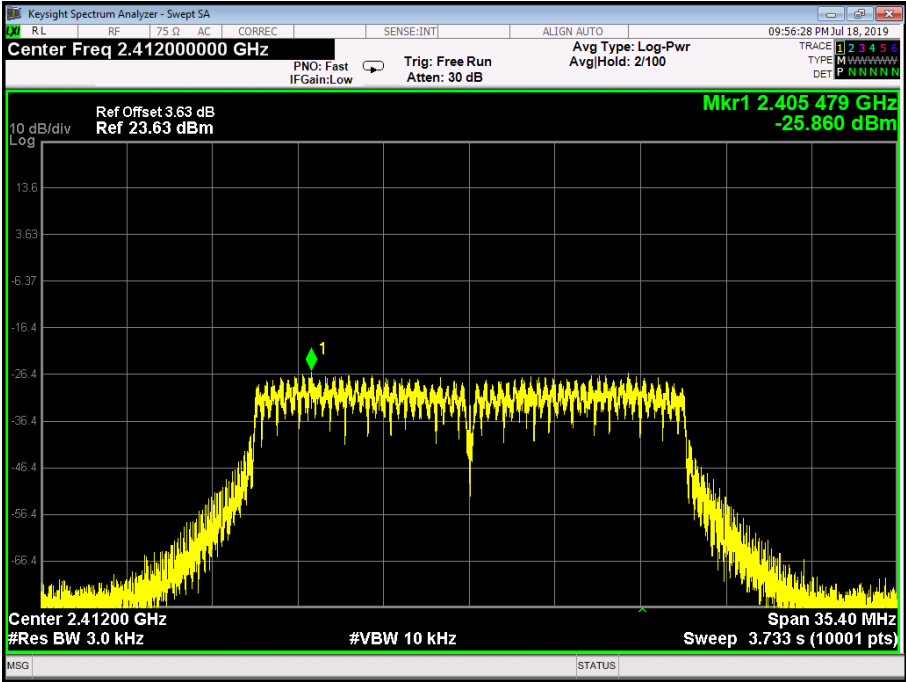
<b>Temperature:</b>	25 °C	<b>Temperature:</b>	25 °C
<b>Test Voltage:</b>	AC120V 60HZ		
<b>Test Mode:</b>	TX 802.11N(HT20) Mode		
Channel Frequency (MHz)	Power Density (dBm/3 kHz)	Limit (dBm/3 kHz)	
2412	-25.860	8	
2437	-24.755		
2462	-24.858		
<b>802.11N(HT20) Mode</b>			
<b>2412 MHz</b>			
			

**802.11N(HT20) Mode**

**2437 MHz**

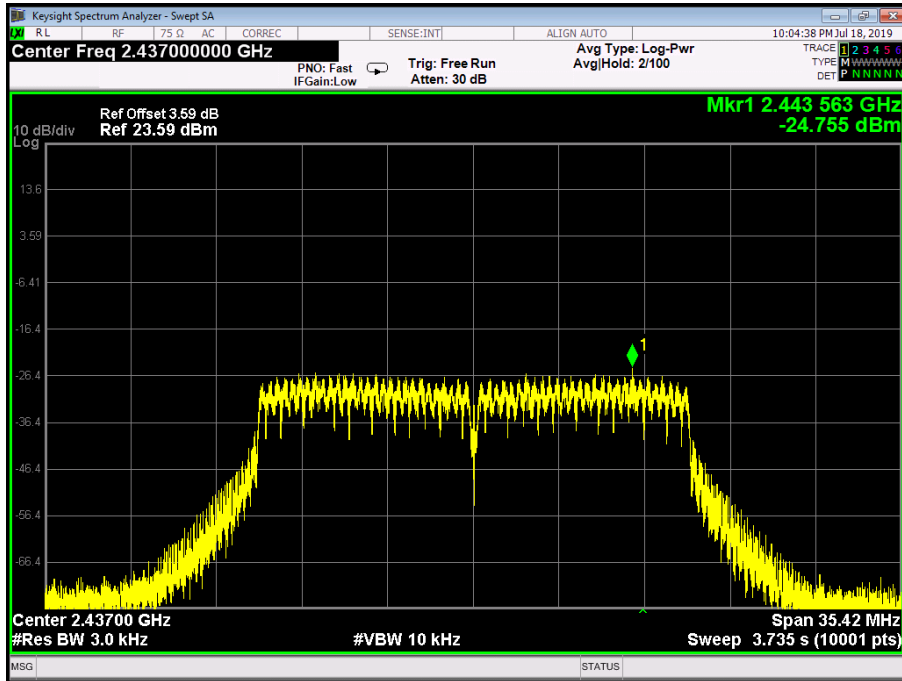

**802.11N(HT20) Mode**

**2462 MHz**

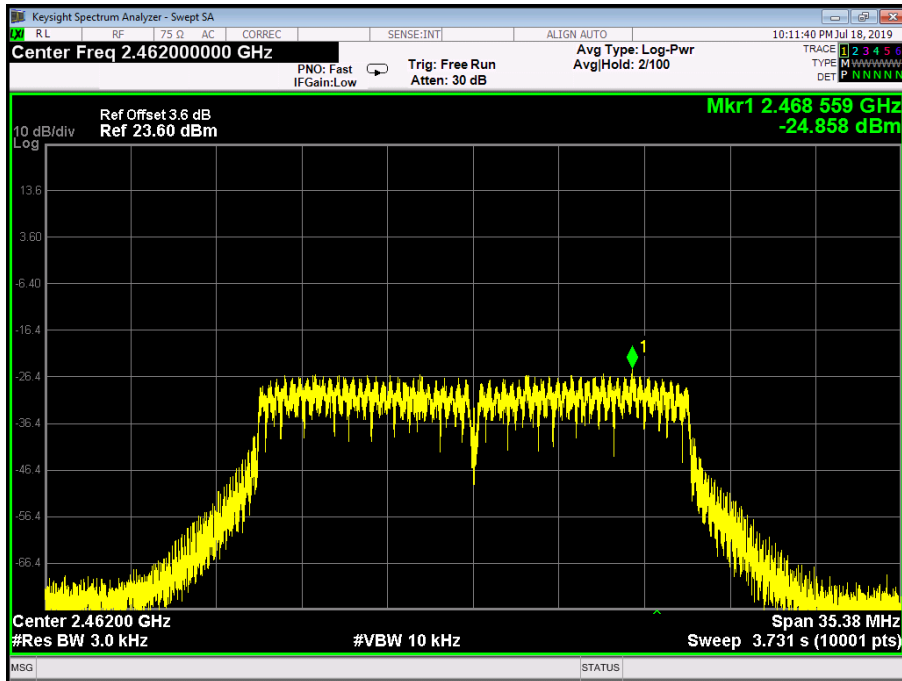

<b>Temperature:</b>	25 °C	<b>Temperature:</b>	25 °C
<b>Test Voltage:</b>	AC120V 60HZ		
<b>Test Mode:</b>	TX 802.11N(HT40) Mode		
<b>Channel Frequency (MHz)</b>	<b>Power Density (dBm/3 kHz)</b>	<b>Limit (dBm/3 kHz)</b>	
2422	-28.959	<b>8</b>	
2437	-27.714		
2452	-28.380		

**802.11N(HT40) Mode**

**2422 MHz**

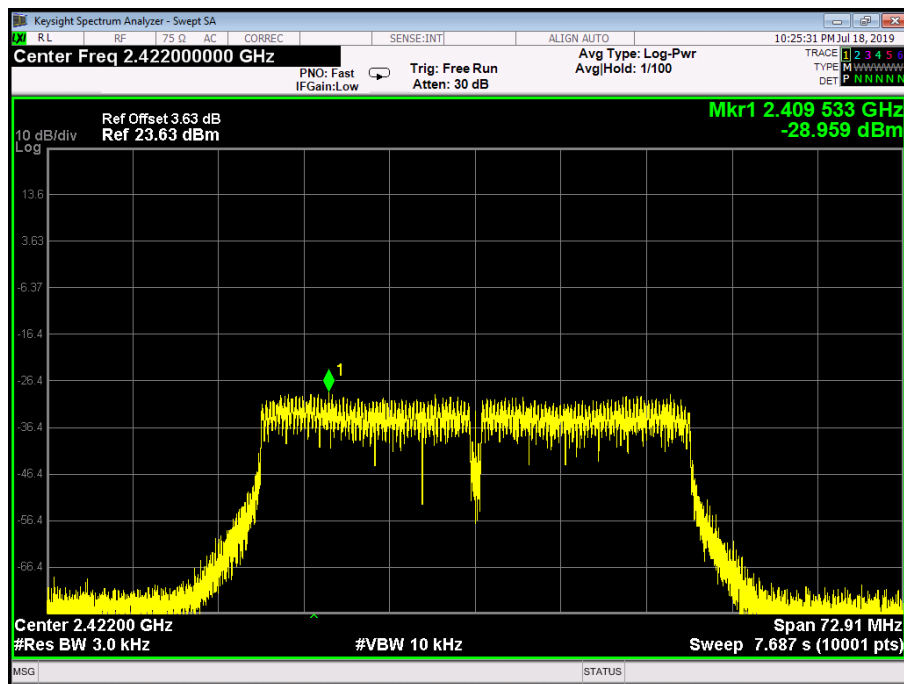

**802.11N(HT40) Mode**

**2437 MHz**

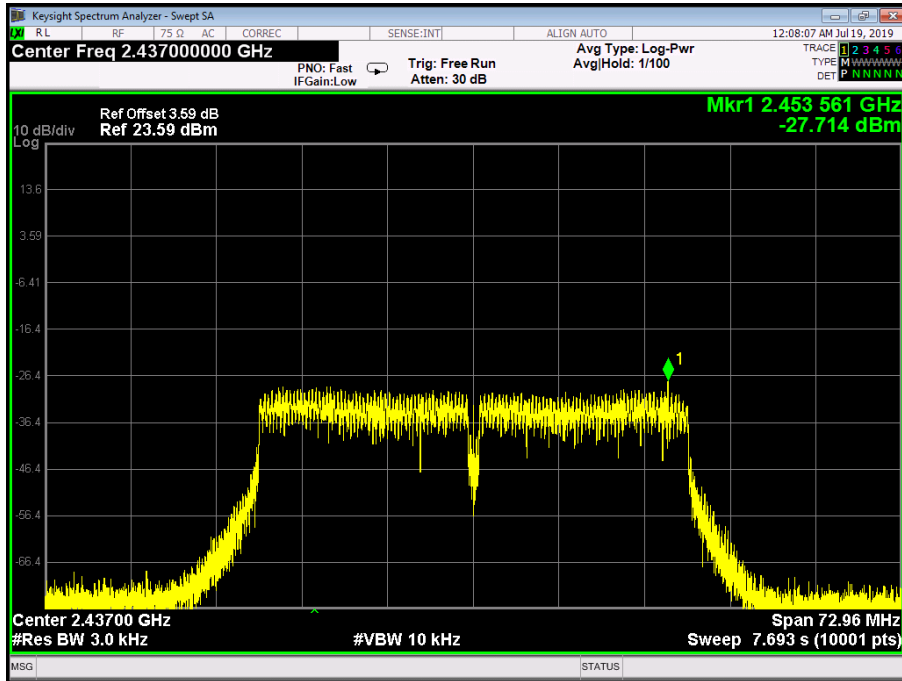

**802.11N(HT40) Mode**

**2452 MHz**

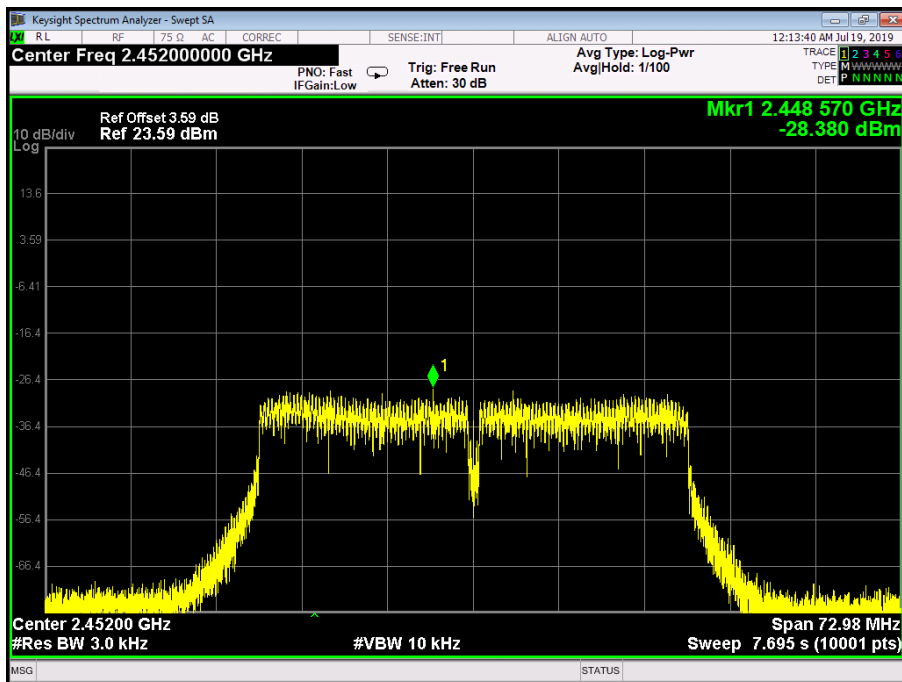

-----END OF REPORT-----