

Catalogue

Please read this manual carefully before use to ensure safe use of the intelligent automatic feeder.

Product Introduction 2

operation guide 3-8

First Time Use 3

Function Description 3

Bind SmartLife APP 3-6

Video version feeder interface introduction 7

WiFi version feeder interface introduction 6

Cleaning/maintenance 9

Precautions 10

common problem 11

List of accessories (subject to the actual product)

adapterX1 cableX1 manualX1 Desiccant GX1

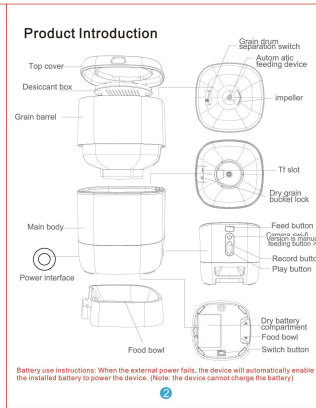

Operation Guide

1. The first Use

- Open the top cover of the feeder and remove the power cord adapter from the backside.
- Plug the power cord into the power connector on the rear of the main unit and connect the adapter to power.
- Place the main unit in a horizontal position and the food bowl is installed at the corresponding position of the main unit.
- Add pet dry food to the feeder bucket.
- The desiccant is placed in the desiccant box by default. Please replace it regularly for long-term use (do not use cleaning).
- The battery compartment can be installed with sections of No.1 battery for manual feeding when there is no electricity (optional).
- Bind the feeder to the SmartLife app to set up the feeding and planning of the pet.

2. The function description

Feed button: Short press to eat one, long press for 5 seconds to restore the factory settings.

Record button: Press and hold the "Record button" to record the sound to remind the pet eat before feeding.

Play button: Play the recorded sound.

Router switch: Feeder switch.

Dry battery compartment: Three 1st batteries can be installed for power supply.

3. Bind SmartLife APP

3.1 APP download and installation

Scan the QR code below to download the SmartLife app and complete the installation.

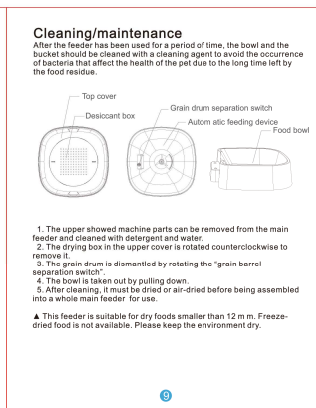
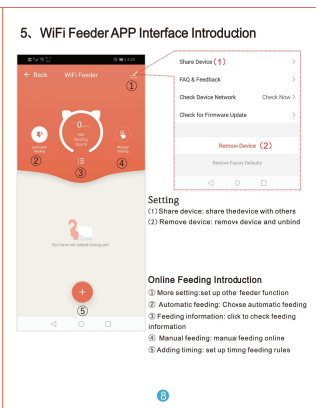
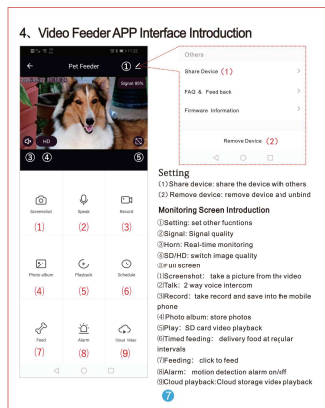
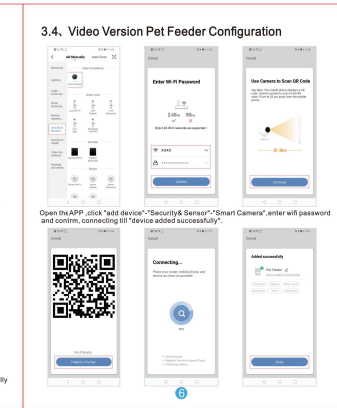
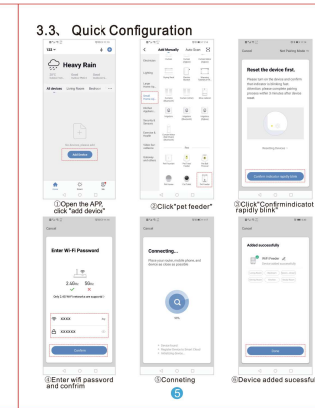
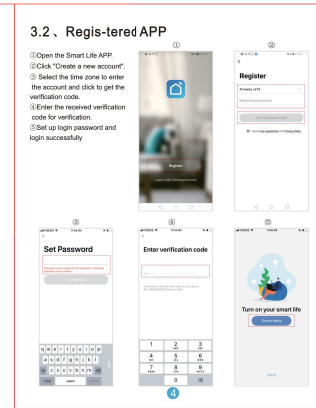

Attentions

- Please place the device correctly, prevent the pet from tipping over the device. This device is only suitable for small and medium pets under 20kg.
- Please replace the desiccant in the storage lid regularly. No desiccant is needed.
- Please keep the food bucket dry and sealed, and check regularly to ensure food residue Prevention.
- Do not drop all substances other than pet dry food into the grain bin. Otherwise, the device may be used abnormally or even cause pet safety problems.
- To prevent the pet from falling over the product, it is recommended to place the corner or against the wall.
- The product anti-battering line should be installed as concealed as possible to prevent the equipment from being damaged by the pet biting the wire.
- If children are using this device, be sure to use it under adult guidance.
- After installing the spare dry battery, you can manually operate the device to provide normal power supply during power failure.
- Regularly clean the food bucket and food bowl.
- This device is not recommended for young pets within three months.

Maintenance records:

Maintenance time: _____

Fault conditions: _____

Trouble shooting: _____

Return and exchange proof: _____

Date of validity: _____

Original device ID: _____

New device ID: _____

Maintenance personnel signature: _____

Maintenance Department seal: _____

FAQ

- The feeder is not connected, what is the problem, what to do.
 - Check if the machine is normal: Check the status of the device indicator. After the power is turned on, the blue indicator light flashes. When the network is connected, it will be on. There will be a drop tone before the network is configured.
 - Check if the Wi-Fi username and password are normal: Wi-Fi username and password cannot have special characters. It is recommended to use English letters + number signs.
 - Uninstall the software and reinstall the software: Please authorize the APP to obtain the location information and access the network permissions during the installation process. Follow the above steps, and enter the correct wifi password. If you still have difficulties, please contact customer service.
- When connecting the feeder, sometimes it can be connected normally, sometimes not, how to deal with it?
 - Check if the machine's food outlet is blocked. At this time, the blue indicator is always on. Q: Why does the feeding time differ by tens of seconds from the current time to refresh.
 - The parameters set on the APP will have an error of about 30 seconds depending on the timing of the network environment.
 - How to quickly reconnect after the machine is disconnected.
 - Exit the APP and re-enter: wait for the data update.
 - Switches from the feeding interface to the video interface and waits for the video to refresh.
 - Feeder requirements for network type: A.Support 8-84G B.Support 802.11n

A.The feeder must use a wifi signal that satisfies the wifi 802.11n protocol.

FCC Statement

This equipment has been tested and found to comply with the limits for a Class B digital device, pursuant to part 15 of the FCC Rules. These limits are designed to provide reasonable protection against harmful interference in a residential installation. This equipment generates, uses and can radiate radio frequency energy and, if not installed and used in accordance with the instructions, may cause harmful interference to radio communications. However, there is no guarantee that interference will not occur in a particular installation. If this equipment does cause harmful interference to radio or television reception, which can be determined by turning the equipment off and on, the user is encouraged to try to correct the interference by one or more of the following measures:

- Reorient or relocate the receiving antenna.
- Increase the separation between the equipment and receiver.
- Connect the equipment into an outlet on a circuit different from that to which the receiver is connected.
- Consult the dealer or an experienced radio/TV technician for help.

Caution: Any changes or modifications to this device not explicitly approved by manufacturer could void your authority to operate the equipment.

This device complies with part 15 of the FCC Rules. Operation is subject to the following two conditions: (1) This device may not cause harmful interference, and (2) this device must accept any interference received, including interference that may cause undesired operation.

RF Exposure Information

This equipment complies with FCC radiation exposure limits set forth for an uncontrolled environment. This equipment should be installed and operated with minimum distance 20cm between the radiator & your body.

单页尺寸: 100*127mm