



TEST REPORT

FCC ID: 2APD3AM-M701

Product Name: AM-M701
Trademark: AccuHealth
Model Number: AM-M701
Prepared For: SHEN ZHEN TOMSTAR TECHNOLOGY CO., LTD
Address: Room 2110-2116, huafeng international building, No.4018
BaoAn Blvd, Shenzhen, China
Manufacturer: SHEN ZHEN TOMSTAR TECHNOLOGY CO., LTD
Address: Room 2110-2116, huafeng international building, No.4018
BaoAn Blvd, Shenzhen, China
Prepared By: Shenzhen BCTC Testing Co., Ltd.
Address: BCTC Building & 1-2F, East of B Building, Pengzhou
Industrial, Fuyuan 1st Road, Qiaotou Community, Fuyong
Street, Bao'an District, Shenzhen, China
Sample Received Date: Apr 25, 2018
Sample tested Date: Apr.25, 2018 to May 02, 2018
Issue Date: May 02, 2018
Report No.: BCTC-FY180402083-3E
Test Standards: FCC Part15.247
ANSI C63.10-2013
Test Results: PASS
Remark: This is WIFI-2.4GHz band radio test report.

Compiled by:

Willen Wang

Willen Wang

Reviewed by:

Rita Xiao

Rita Xiao

Approved by:



Carson Zhang/Manager

The test report is effective only with both signature and specialized stamp. This result(s) shown in this report refer only to the sample(s) tested. Without written approval of Shenzhen BCTC Testing Co., Ltd, this report can't be reproduced except in full. The tested sample(s) and the sample information are provided by the client.



TABLE OF CONTENT

	Page
Test Report Declaration	
1. VERSION	4
2. TEST SUMMARY	5
3. MEASUREMENT UNCERTAINTY	6
4. PRODUCT INFORMATION AND TEST SETUP	7
4.1 Product Information	7
4.2 Test Setup Configuration	8
4.3 Support Equipment	8
4.4 Channel List	8
4.5 Test Mode	8
5. TEST FACILITY AND TEST INSTRUMENT USED	10
5.1 Test Facility	10
5.2 Test Instrument Used	10
6. CONDUCTED EMISSIONS	12
6.1 Block Diagram Of Test Setup	12
6.2 Limit	12
6.3 Test procedure	12
6.4 Test Result	13
7. RADIATED EMISSIONS	15
7.1 Block Diagram Of Test Setup	15
7.2 Limit	16
7.3 Test procedure	16
7.4 Test Result	19
8. CONDUCTED EMISSION	42
8.1 Block Diagram Of Test Setup	42
8.2 Limit	42
8.3 Test procedure	42
8.4 Test Result	43
9. 6 DB BANDWIDTH	59
9.1 Block Diagram Of Test Setup	59
9.2 Limit	59
9.3 Test procedure	59
9.4 Test Result	60
10. MAXIMUM PEAK OUTPUT POWER	67
10.1 Block Diagram Of Test Setup	67
10.2 Limit	67
10.3 Test procedure	67
10.4 Test Result	68
11. POWER SPECTRAL DENSITY	69
11.1 Block Diagram Of Test Setup	69
11.2 Limit	69



11.3	Test procedure	69
11.4	Test Result	70
12.	ANTENNA REQUIREMENT	77
13.	EUT PHOTOGRAPHS	78
14.	EUT TEST SETUP PHOTOGRAPHS	81

(Note: N/A means not applicable)



1. VERSION

Report No.	Issue Date	Description	Approved
BCTC-FY180402083-3E	May 02, 2018	Original	Valid



2. TEST SUMMARY

The Product has been tested according to the following specifications:

No.	Test Parameter	Clause No	Results
1	Radiated Spurious Emissions	15.205(a) 15.209 15.247(d)	PASS
2	Conducted Spurious emissions	15.247(d)	PASS
3	Band edge	15.247(d) 15.205(a)	PASS
4	Conducted Emission	15.207	PASS
5	6dB Bandwidth	15.247(a)	PASS
6	Maximum Peak Output Power	15.247(b)	PASS
7	Power Spectral Density	15.247(e)	PASS
8	Antenna Requirement	15.203	PASS

Note: N/A is an abbreviation for Not Applicable and means this test item is not applicable for this device according to the technology characteristic of device.



3. MEASUREMENT UNCERTAINTY

Where relevant, the following measurement uncertainty levels have been estimated for tests performed on the Product as specified in CISPR 16-4-2. This uncertainty represents an expanded uncertainty expressed at approximately the 95% confidence level using a coverage factor of $k=2$.

RF frequency	1×10^{-7}
RF power, conducted	± 1.0 dB
Conducted emission of receivers	± 1 dB
Radiated emission of transmitter	± 6 dB
Radiated emission of receiver	± 6 dB
Temperature	± 1 degree
Humidity	± 5 %



4. PRODUCT INFORMATION AND TEST SETUP

4.1 Product Information

Model(s):	AM-M701
Model Description:	N/A
GSM Band(s):	GSM 850/1900MHz
WCDMA Band(s):	FDD Band II/V
Wi-Fi Specification:	IEEE 802.11b/g/n
Bluetooth Version:	Bluetooth v4.0 with BLE
Hardware Version:	N/A
Software Version:	N/A
Operation Frequency:	GPRS: Tx: 824-849MHz, Rx: 869-894MHz GPRS: TX: 1850-1910 MHz, Rx: 1930-1990MHz WCDMA Band II: Tx: 1850-1910MHz, Rx: 1930-1990MHz WCDMA Band V: Tx: 824-849MHz, Rx: 869-894MHz WiFi: IEEE 802.11b/g/n HT20: 2412-2462MHz IEEE 802.11n HT40: 2422-2452MHz Bluetooth: 2402-2480MHz
Max. RF output power:	GSM900: 33.52dBm GSM1800: 29.60dBm WCDMA Band II: 22.77dBm WCDMA Band V: 22.51dBm WiFi (2.4G) : 6.89dBm Bluetooth: 1.976dBm
Type of Modulation:	GPRS:GMSK WCDMA: BPSK, QPSK, 16QAM, 64QAM WiFi: DQPSK, DBPSK, DSSS, CCK and OFDM Bluetooth: GFSK, Pi/4 DQPSK, 8DPSK
Antenna installation:	GSM/WCDMA: integral antenna WiFi/Bluetooth: FPCB antenna
Antenna Gain:	GSM850: 0.35dBi GSM1900: 1.72dBi WCDMA Band II: 1.72dBi WCDMA Band V: 0.35dBi WiFi (2.4G) : 1.82dBi Bluetooth: 1.82dBi
Ratings:	Battery DC 3.8V

DC 5V 2A charging from adapter
 Input: 100-240V~50/60Hz, 0.35A MAX
 Adapter: Input: 100-240V~50/60Hz, 0.35A MAX
 Output: 5V 2A

4.2 Test Setup Configuration

See test photographs attached in *EUT TEST SETUP PHOTOGRAPHS* for the actual connections between Product and support equipment.

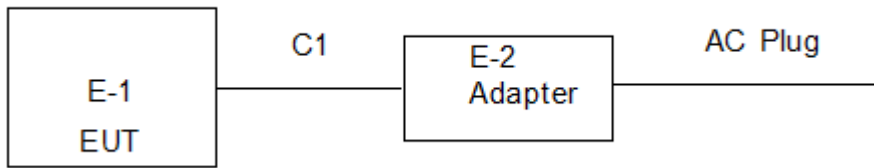

4.3 Support Equipment

No.	Device Type	Brand	Model	Series No.	Data Cable	Power Cord
1.	---	---	---	---	---	---

Notes:

1. All the equipment/cables were placed in the worst-case configuration to maximize the emission during the test.
2. Grounding was established in accordance with the manufacturer’s requirements and conditions for the intended use.

4.4 Channel List

CH	Frequency (MHz)	CH	Frequency (MHz)	CH	Frequency (MHz)	CH	Frequency (MHz)
1	2412	2	2417	3	2422	4	2427
5	2432	6	2437	7	2442	8	2447
9	2452	10	2457	11	2462	12	/

4.5 Test Mode

All test mode(s) and condition(s) mentioned were considered and evaluated respectively by performing full tests, the worst data were recorded and reported.

During testing, Channel and Power Controlling Software provided by the customer was used to control the operating channel as well as the output power level. The RF output power selection is for the setting of RF output power expected by the customer and is going to be fixed on the firmware of the final end product.

Transmitting duty cycle is 100%.

The software is installed in operation system, named “RFTestTool.apk” ,Version 1.0.



Test mode	Test mode	Low channel	Middle channel	High channel
1	Transmitting(802.11b/g/n20)	2412MHz	2442MHz	2462MHz
2	Transmitting(802.11n40)	2422MHz	2437MHz	2452MHz
3	Transmitting (conducted emission and Radiated emission)			



5. TEST FACILITY AND TEST INSTRUMENT USED

5.1 Test Facility

All measurement facilities used to collect the measurement data are located at BCTC Building & 1-2F, East of B Building, Pengzhou Industrial, Fuyuan 1st Road, Qiaotou Community, Fuyong Street, Bao'an District, Shenzhen, China. The site and apparatus are constructed in conformance with the requirements of ANSI C63.4 and CISPR 16-1-1 other equivalent standards.

5.2 Test Instrument Used

Radiation Test						
Item	Equipment	Manufacturer	Type No.	Serial No.	Cal.Date	Cal.Due date
1	Spectrum Analyzer (9kHz-26.5GHz)	Agilent	E4407B	MY45108040	Aug. 27, 2017	Aug.26, 2018
2	Test Receiver (9kHz-7GHz)	R&S	ESPI	101318	Aug. 27, 2017	Aug.26, 2018
3	Bilog Antenna (30MHz-1GHz)	R&S	VULB 9168	VULB91 68-438	Aug. 27, 2017	Aug.26, 2018
4	Horn Antenna (1GHz-18GHz)	SCHWARZB ECK	BBHA9120D	1201	Sep.03, 2017	Sep.02,2018
5	Horn Antenna (14GHz-40GHz)	SCHWARZB ECK	BBHA 9170	9170-181	Sep.03, 2017	Sep.02,2018
6	Amplifier (9kHz-6GHz)	SCHWARZB ECK	BBV9744	9744-0037	Aug. 27, 2017	Aug.26, 2018
7	Amplifier (1GHz-18GHz)	SCHWARZB ECK	BBV9718	9718-309	Aug. 27, 2017	Aug.26, 2018
8	Amplifier (18GHz-40GHz)	SCHWARZB ECK	BBV 9721	9721-205	Aug. 27, 2017	Aug.26, 2018
9	Loop Antenna (9kHz-30MHz)	SCHWARZB ECK	FMZB1519B	00014	Sep.03, 2017	Sep.02,2018
10	RF cables1 (9kHz-1GHz)	R&S	R203	R20X	Aug. 27, 2017	Aug.26, 2018
11	RF cables2 (1GHz-40GHz)	R&S	R204	R21X	Aug. 27, 2017	Aug.26, 2018
12	Antenna connector	Florida RF Labs	N/A	RF 01#	Aug. 27, 2017	Aug.26, 2018
13	Power Metter	ANRITSU	ML2487A	6K00001568	Aug. 27, 2017	Aug.26, 2018
14	Power Sensor (AV)	ANRITSU	ML2491A	030989	Aug. 27, 2017	Aug.26, 2018
15	Signal Analyzer 9kHz-26.5GHz	Agilent	N9010A	MY48030494	Aug. 27, 2017	Aug.26, 2018
16	Test Receiver 20kHz-40GHz	R&S	ESU 40	100376	Aug. 27, 2017	Aug.26, 2018
17	D.C. Power Supply	LongWei	PS-305D	010964729	Aug. 27, 2017	Aug.26, 2018



Conduction Test						
Item	Equipment	Manufacturer	Type No.	Serial No.	Cal.Date	Cal.Due date
1	Test Receiver	R&S	ESCI	1166.5950K0 3-101165-ha	Aug. 27, 2017	Aug.26, 2018
2	LISN	SCHWARZB ECK	NSLK8127	8127739	Aug. 27, 2017	Aug.26, 2018
3	LISN	R&S	NSLK8126	8126487	Aug. 27, 2017	Aug.26, 2018
4	RF cables	R&S	R204	R20X	Sep.03, 2017	Sep.02,2018
5	Attenuator	R&S	ESH3-Z2	143206	Sep.03, 2017	Sep.02,2018

6. CONDUCTED EMISSIONS

6.1 Block Diagram Of Test Setup

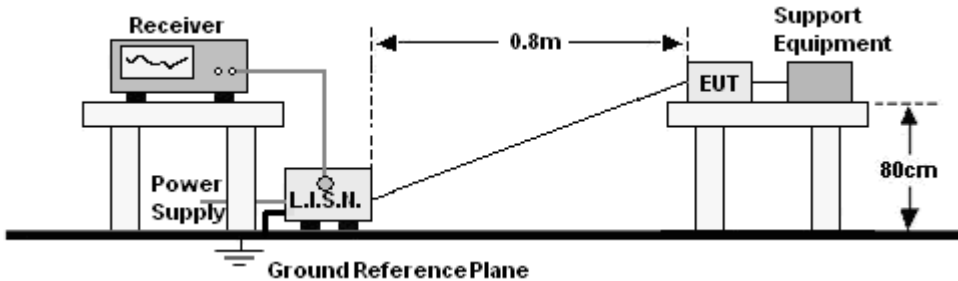

6.2 Limit

FREQUENCY (MHz)	Limit (dBuV)	
	Quas-peak	Average
0.15 -0.5	66 - 56 *	56 - 46 *
0.50 -5.0	56.00	46.00
5.0 -30.0	60.00	50.00

Notes:
1. *Decreasing linearly with logarithm of frequency.
2. The lower limit shall apply at the transition frequencies.

6.3 Test procedure

Receiver Parameters	Setting
Attenuation	10 dB
Start Frequency	0.15 MHz
Stop Frequency	30 MHz
IF Bandwidth	9 kHz

- The Product was placed on a nonconductive table 0.8m above the horizontal ground reference plane, and 0.4 m from the vertical ground reference plane, and connected to the main through Line Impedance Stability Network (L.I.S.N).
- The RBW of the receiver was set at 9 kHz in 150 kHz ~ 30MHz with Peak and AVG detector in Max Hold mode. Run the receiver's pre-scan to record the maximum disturbance generated from Product in all power lines in the full band.
- For each frequency whose maximum record was higher or close to limit, measure its QP and AVG values and record.



6.4 Test Result

Temperature :	25 °C	Relative Humidity :	54%
Pressure :	1010hPa	Phase :	L
Test Voltage :	AC 120V/60Hz	Test Mode :	Mode 3

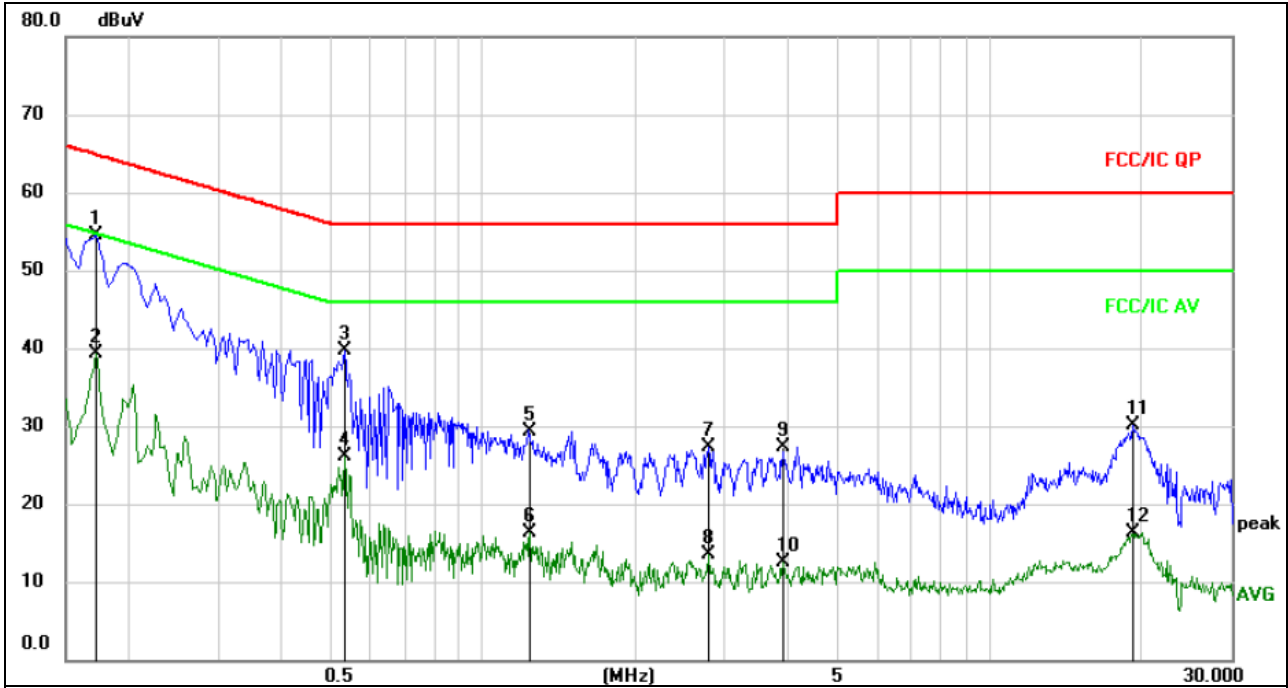

Remark:

1. All readings are Quasi-Peak and Average values.
2. Factor = Insertion Loss + Cable Loss.

No.	Mk.	Freq. MHz	Reading Level dBuV	Correct Factor dB	Measure- ment dBuV	Limit dBuV	Over dB	Detector	Comment
1	*	0.1725	44.88	9.66	54.54	64.84	-10.30	QP	
2		0.1725	29.71	9.66	39.37	54.84	-15.47	AVG	
3		0.5325	29.93	9.68	39.61	56.00	-16.39	QP	
4		0.5325	16.48	9.68	26.16	46.00	-19.84	AVG	
5		1.2390	19.68	9.69	29.37	56.00	-26.63	QP	
6		1.2390	6.54	9.69	16.23	46.00	-29.77	AVG	
7		2.7869	17.56	9.72	27.28	56.00	-28.72	QP	
8		2.7869	3.78	9.72	13.50	46.00	-32.50	AVG	
9		3.9030	17.53	9.73	27.26	56.00	-28.74	QP	
10		3.9030	2.85	9.73	12.58	46.00	-33.42	AVG	
11		19.1940	20.30	9.86	30.16	60.00	-29.84	QP	
12		19.1940	6.41	9.86	16.27	50.00	-33.73	AVG	



Temperature :	25 °C	Relative Humidity :	54%
Pressure :	1010hPa	Phase :	N
Test Voltage :	AC 120V/60Hz	Test Mode :	Mode 3

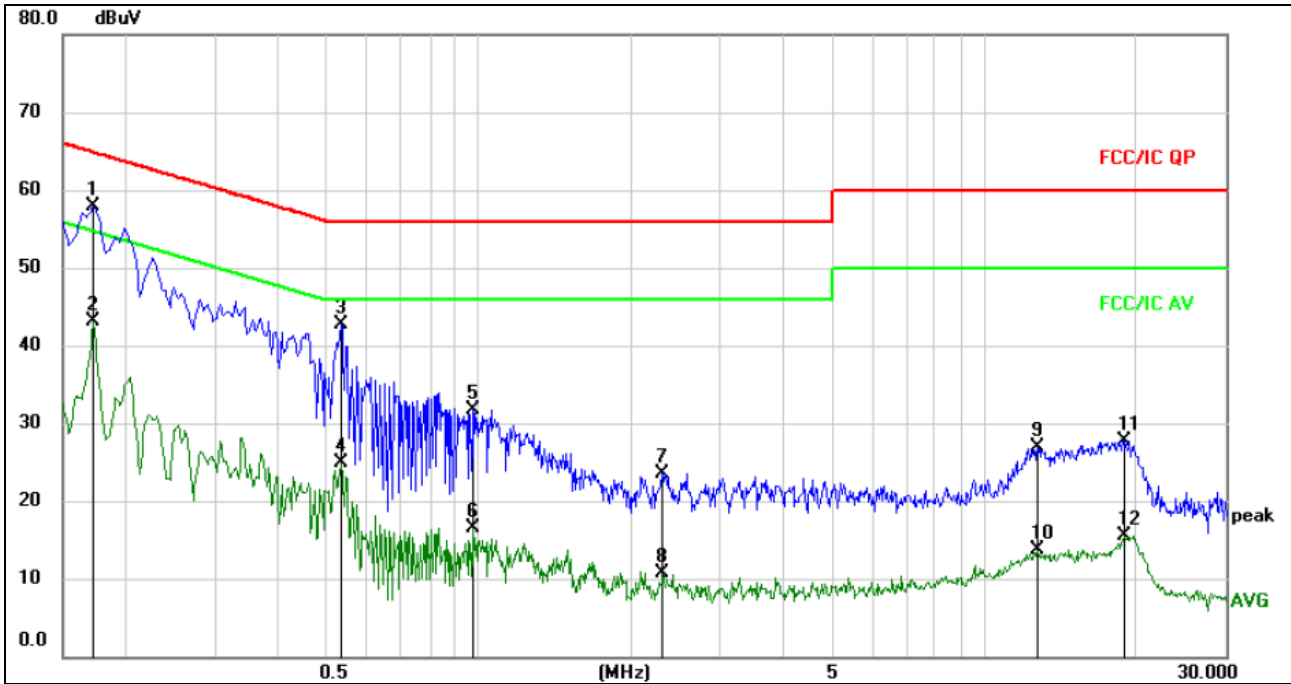

Remark:

1. All readings are Quasi-Peak and Average values.
2. Factor = Insertion Loss + Cable Loss.

No.	Mk.	Freq.	Reading Level	Correct Factor	Measurement	Limit	Over	Detector	Comment
		MHz	dBuV	dB	dBuV	dBuV	dB		
1	*	0.1725	48.33	9.66	57.99	64.84	-6.85	QP	
2		0.1725	33.38	9.66	43.04	54.84	-11.80	AVG	
3		0.5325	32.95	9.68	42.63	56.00	-13.37	QP	
4		0.5325	15.23	9.68	24.91	46.00	-21.09	AVG	
5		0.9690	22.04	9.69	31.73	56.00	-24.27	QP	
6		0.9690	6.80	9.69	16.49	46.00	-29.51	AVG	
7		2.3055	13.70	9.72	23.42	56.00	-32.58	QP	
8		2.3055	0.96	9.72	10.68	46.00	-35.32	AVG	
9		12.7545	17.05	9.83	26.88	60.00	-33.12	QP	
10		12.7545	3.84	9.83	13.67	50.00	-36.33	AVG	
11		18.9555	17.88	9.85	27.73	60.00	-32.27	QP	
12		18.9555	5.64	9.85	15.49	50.00	-34.51	AVG	

7. RADIATED EMISSIONS

7.1 Block Diagram Of Test Setup

(A) Radiated Emission Test-Up Frequency Below 30MHz

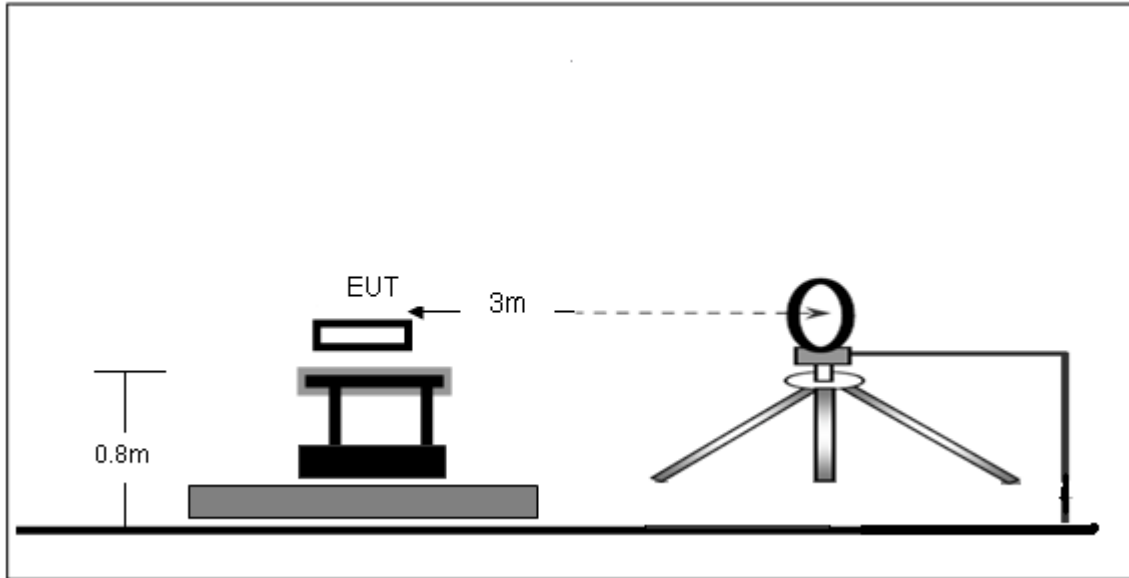

(B) Radiated Emission Test-Up Frequency 30MHz~1GHz

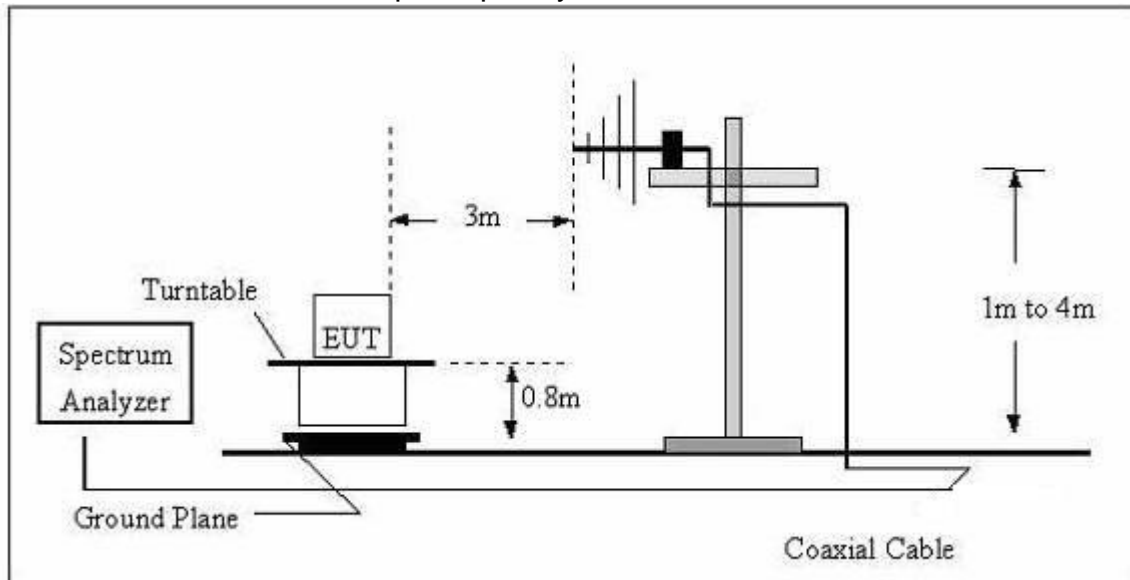

(C) Radiated Emission Test-Up Frequency Above 1GHz

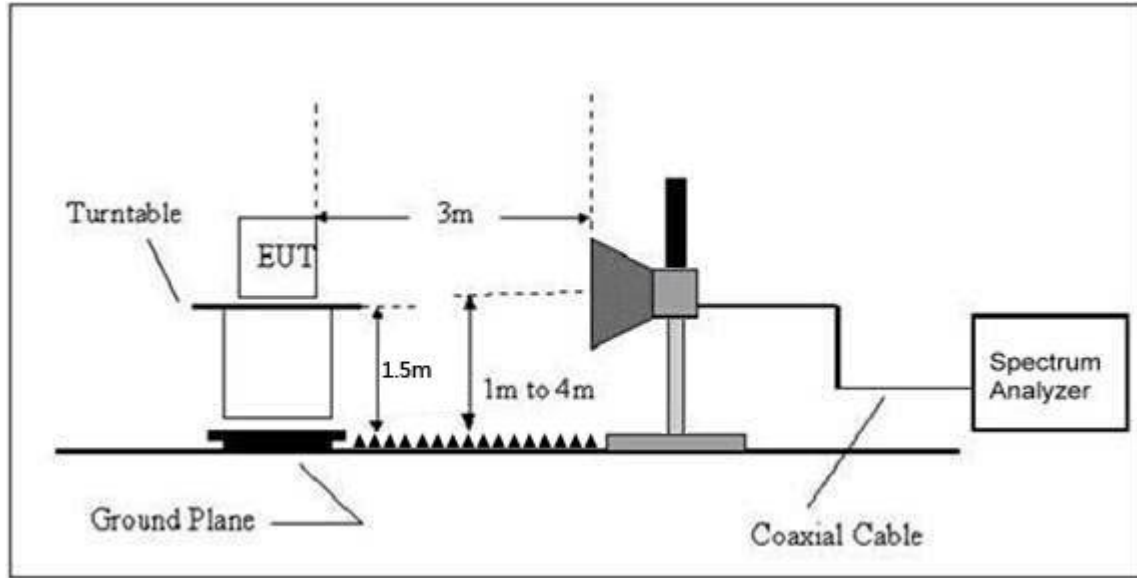

7.2 Limit

20dBc in any 100 kHz bandwidth outside the operating frequency band. In case the emission fall within the restricted band specified on 15.205(a), then the 15.209(a) limit in the table below has to be followed.

Frequency (MHz)	Field Strength uV/m	Distance (m)	Field Strength Limit at 3m Distance	
			uV/m	dBuV/m
0.009 ~ 0.490	2400/F(kHz)	300	10000 * 2400/F(kHz)	$20\log^{(2400/F(kHz))} + 80$
0.490 ~ 1.705	24000/F(kHz)	30	100 * 24000/F(kHz)	$20\log^{(24000/F(kHz))} + 40$
1.705 ~ 30	30	30	100 * 30	$20\log^{(30)} + 40$
30 ~ 88	100	3	100	$20\log^{(100)}$
88 ~ 216	150	3	150	$20\log^{(150)}$
216 ~ 960	200	3	200	$20\log^{(200)}$
Above 960	500	3	500	$20\log^{(500)}$

7.3 Test procedure

Receiver Parameter	Setting
Attenuation	Auto
9kHz~150kHz	RBW 200Hz for QP
150kHz~30MHz	RBW 9kHz for QP
30MHz~1000MHz	RBW 120kHz for QP

Spectrum Parameter	Setting
1-25GHz	RBW 1 MHz /VBW 1 MHz for Peak, RBW 1 MHz / VBW 10Hz for Average



Below 1GHz test procedure as below:

- a. The EUT was placed on the top of a rotating table 0.8 meters above the ground at a 3 meter semi-anechoic chamber. The table was rotated 360 degrees to determine the position of the highest radiation.
- b. The EUT was set 3 meters away from the interference-receiving antenna, which was mounted on the top of a variable-height antenna tower.
- c. The antenna height is varied from one meter to four meters above the ground to determine the maximum value of the field strength. Both horizontal and vertical polarizations of the antenna are set to make the measurement.
- d. For each suspected emission, the EUT was arranged to its worst case and then the antenna was tuned to heights from 1 meter to 4 meters (for the test frequency of below 30MHz, the antenna was tuned to heights 1 meter) and the rotatable table was turned from 0 degrees to 360 degrees to find the maximum reading.
- e. The test-receiver system was set to Peak Detect Function and Specified Bandwidth with Maximum Hold Mode.
- f. If the emission level of the EUT in peak mode was 10dB lower than the limit specified, then testing could be stopped and the peak values of the EUT would be reported. Otherwise the emissions that did not have 10dB margin would be re-tested one by one using peak, quasi-peak or average method as specified and then reported in a data sheet.

Above 1GHz test procedure as below:

- g. Different between above is the test site, change from Semi- Anechoic Chamber to fully Anechoic Chamber and change form table 0.8 metre to 1.5 metre(Above 18GHz the distance is 1 meter and table is 1.5 metre).
- h. Test the EUT in the lowest channel ,the middle channel ,the Highest channel.

Note:

Both horizontal and vertical antenna polarities were tested and performed pretest to three orthogonal axis. The worst case emissions were reported.

Above 1GHz test procedure as below:

- a.The EUT was placed on the top of a rotating table 1.5 meters above the ground at a 3 meter chamber. The table was rotated 360 degrees to determine the position of the highest radiation.
- b.The EUT was set 3 meters away from the interference-receiving antenna, which was mounted on the top of a variable-height antenna tower.
- c.The antenna height is varied from one meter to four meters above the ground to determine the maximum value of the field strength. Both horizontal and vertical polarizations of the antenna are set to make the measurement.



d. For each suspected emission, the EUT was arranged to its worst case and then the antenna was tuned to heights from 1 meter to 4 meters and the rota table was turned from 0 degrees to 360 degrees to find the maximum reading.

e. The test-receiver system was set to Peak Detect Function and Specified Bandwidth with Maximum Hold Mode.

f. If the emission level of the EUT in peak mode was 10dB lower than the limit specified, then testing could be stopped and the peak values of the EUT would be reported. Otherwise the emissions that did not have 10dB margin would be re-tested one by one using peak, quasi-peak or average method as specified and then reported in a data sheet.

g. Test the EUT in the lowest channel, the Highest channel.

Note:

Both horizontal and vertical antenna polarities were tested and performed pretest to three orthogonal axis. The worst case emissions were reported.



7.4 Test Result

Below 30MHz

Temperature:	25°C	Relative Humidity:	54%
Pressure:	1010 hPa	Test Voltage :	AC 120V/60Hz
Test Mode :	Mode 5	Polarization :	--

Freq. (MHz)	Reading (dBuV/m)	Limit (dBuV/m)	Margin (dB)	State P/F
--	--	--	--	PASS
--	--	--	--	PASS

Note:

The amplitude of spurious emissions which are attenuated by more than 20dB below the permissible value has no need to be reported.

Distance extrapolation factor = $40 \log(\text{specific distance}/\text{test distance})$ (dB);

Limit line = specific limits(dBuv) + distance extrapolation factor.



Between 30MHz – 1GHz

Temperature:	25°C	Relative Humidity:	54%
Pressure:	1010 hPa	Test Voltage :	AC 120V/60Hz
Test Mode :	Mode 3	Polarization :	Horizontal

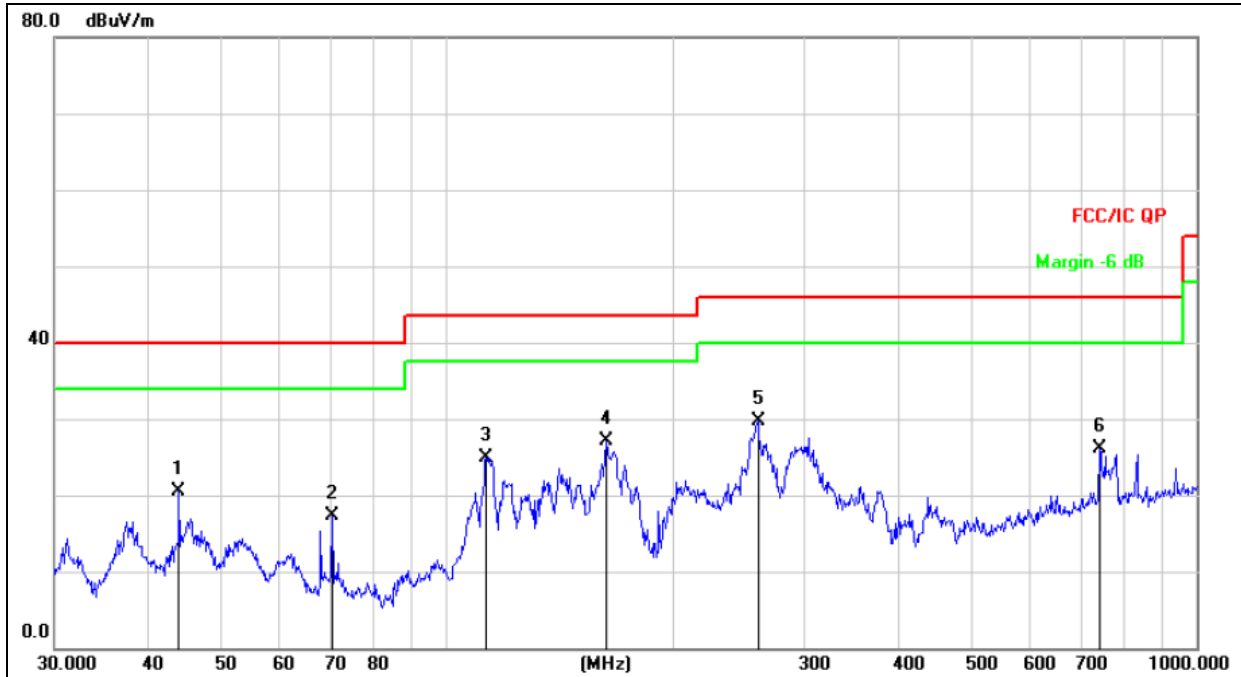

Remark:

Factor = Antenna Factor + Cable Loss – Pre-amplifier.

No.	Mk.	Freq.	Reading Level	Correct Factor	Measurement	Limit	Over	Detector
		MHz	dBuV	dB	dBuV/m	dB/m	dB	
1		43.9658	34.59	-14.18	20.41	40.00	-19.59	QP
2		70.3365	34.96	-17.66	17.30	40.00	-22.70	QP
3		112.9196	41.18	-16.24	24.94	43.50	-18.56	QP
4		163.1818	45.93	-18.91	27.02	43.50	-16.48	QP
5	*	260.1444	44.78	-15.01	29.77	46.00	-16.23	QP
6		742.2587	31.14	-5.03	26.11	46.00	-19.89	QP



Temperature:	25°C	Relative Humidity:	54%
Pressure:	1010 hPa	Test Voltage :	AC 120V/60Hz
Test Mode :	Mode 3	Polarization :	Vertical

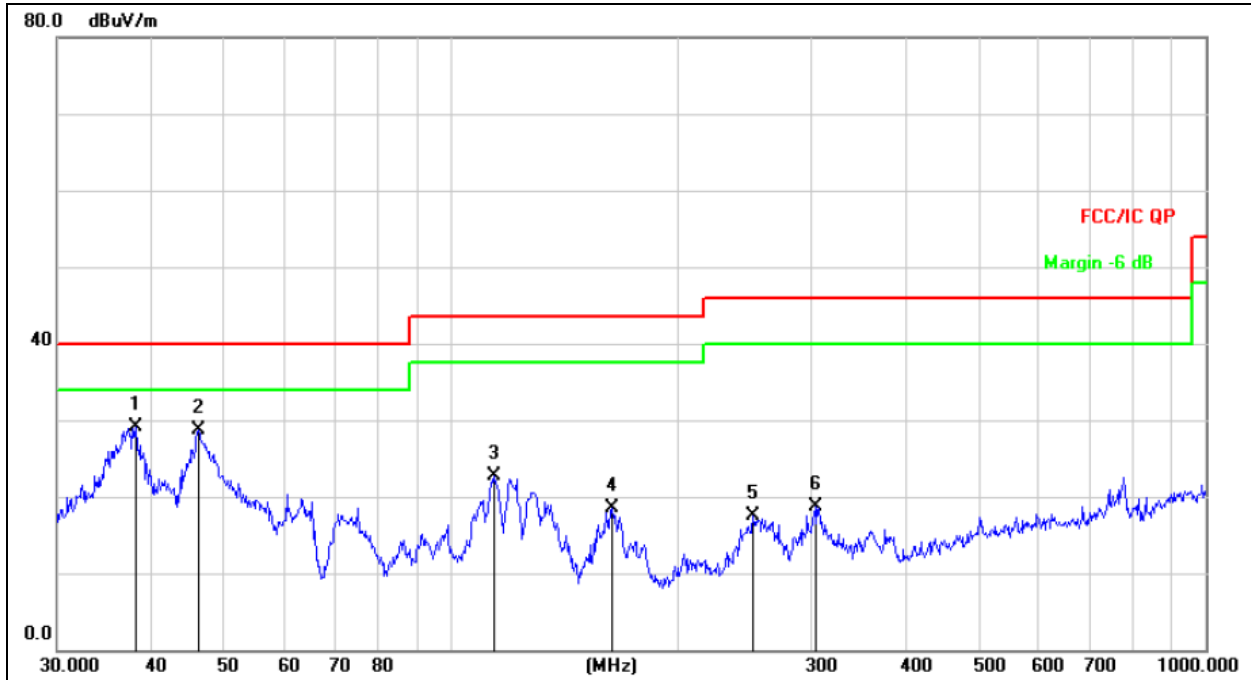

Remark:

Factor = Antenna Factor + Cable Loss – Pre-amplifier.

No.	Mk.	Freq.	Reading Level	Correct Factor	Measurement	Limit	Over	Detector
		MHz	dBuV	dB	dBuV/m	dB/m	dB	
1	*	38.0783	44.56	-15.40	29.16	40.00	-10.84	QP
2		46.1779	42.81	-14.02	28.79	40.00	-11.21	QP
3		113.7143	39.06	-16.37	22.69	43.50	-20.81	QP
4		163.1818	37.49	-18.91	18.58	43.50	-24.92	QP
5		251.1804	32.68	-15.09	17.59	46.00	-28.41	QP
6		303.5437	32.14	-13.47	18.67	46.00	-27.33	QP



Between 1-25GHz

Polar (H/V)	Frequency	Meter Reading	Pre-amplifier	Cable Loss	Antenna Factor	Emission Level	Limits	Margin	Detector Type
	(MHz)	(dBuV)	(dB)	(dB)	(dB)	(dBuV/m)	(dBuV/m)	(dB)	
802.11b Low Channel:2412MHz									
V	4824.00	62.86	39.55	7.85	25.66	56.82	74.00	-17.18	PK
V	4824.00	45.98	39.55	7.85	25.66	39.94	54.00	-14.06	AV
V	7236.00	66.02	38.33	7.52	24.55	59.76	74.00	-14.24	PK
V	7236.00	44.34	38.33	7.52	24.55	38.08	54.00	-15.92	AV
V	15450.00	41.31	35.23	6.75	26.59	39.42	74.00	-34.58	PK
H	4824.00	69.69	39.55	7.85	25.66	63.65	74.00	-10.35	PK
H	4824.00	51.79	39.55	7.85	25.66	45.75	54.00	-8.25	AV
H	7236.00	72.38	38.33	7.52	23.55	65.12	74.00	-8.88	PK
H	7236.00	44.13	38.33	7.52	23.22	36.54	54.00	-17.46	AV
H	15450.00	45.65	35.45	6.75	27.88	44.83	74.00	-29.17	PK

Polar (H/V)	Frequency	Meter Reading	Pre-amplifier	Cable Loss	Antenna Factor	Emission Level	Limits	Margin	Detector Type
	(MHz)	(dBuV)	(dB)	(dB)	(dB)	(dBuV/m)	(dBuV/m)	(dB)	
802.11b Middle Channel:2437MHz									
V	4874.00	62.01	39.55	7.85	25.66	55.97	74.00	-18.03	PK
V	4874.00	45.43	39.55	7.85	25.66	39.39	54.00	-14.61	AV
V	7311.00	65.62	38.33	7.52	24.55	59.36	74.00	-14.64	PK
V	7311.00	42.55	38.33	7.52	24.55	36.29	54.00	-17.71	AV
V	15450.00	38.61	35.23	6.75	26.59	36.72	74.00	-37.28	PK
H	4874.00	66.83	39.55	7.85	25.66	60.79	74.00	-13.21	PK
H	4874.00	49.51	39.55	7.85	25.66	43.47	54.00	-10.53	AV
H	7311.00	73.74	38.33	7.52	23.55	66.48	74.00	-7.52	PK
H	7311.00	42.38	38.33	7.52	23.22	34.79	54.00	-19.21	AV
H	15450.00	46.49	35.45	6.75	27.88	45.67	74.00	-28.33	PK

Polar (H/V)	Frequency	Meter Reading	Pre-amplifier	Cable Loss	Antenna Factor	Emission Level	Limits	Margin	Detector Type
	(MHz)	(dBuV)	(dB)	(dB)	(dB)	(dBuV/m)	(dBuV/m)	(dB)	
802.11b High Channel:2462MHz									
V	4924.00	65.12	39.55	7.85	25.66	59.08	74.00	-14.92	PK
V	4924.00	45.59	39.55	7.85	25.66	39.55	54.00	-14.45	AV
V	7386.00	63.63	38.33	7.52	24.55	57.37	74.00	-16.63	PK
V	7386.00	41.44	38.33	7.52	24.55	35.18	54.00	-18.82	AV
V	15450.00	40.87	35.23	6.75	26.59	38.98	74.00	-35.02	PK
H	4924.00	68.37	39.55	7.85	25.66	62.33	74.00	-11.67	PK
H	4924.00	53.72	39.55	7.85	25.66	47.68	54.00	-6.32	AV
H	7386.00	75.05	38.33	7.52	23.55	67.79	74.00	-6.21	PK
H	7386.00	44.98	38.33	7.52	23.22	37.39	54.00	-16.61	AV
H	15450.00	46.20	35.45	6.75	27.88	45.38	74.00	-28.62	PK

Remark:

1. Emission Level = Meter Reading + Antenna Factor + Cable Loss – Pre-amplifier, Margin= Emission Level - Limit
2. If peak below the average limit, the average emission was no test.
3. The amplitude of spurious emissions which are attenuated by more than 20dB below the permissible value has no need to be reported.



Polar (H/V)	Frequency	Meter Reading	Pre-amplifier	Cable Loss	Antenna Factor	Emission Level	Limits	Margin	Detector Type
	(MHz)	(dBuV)	(dB)	(dB)	(dB)	(dBuV/m)	(dBuV/m)	(dB)	
802.11g Low Channel:2412MHz									
V	4824.00	60.96	39.55	7.85	25.66	54.92	74.00	-19.08	PK
V	4824.00	47.30	39.55	7.85	25.66	41.26	54.00	-12.74	AV
V	7236.00	67.78	38.33	7.52	24.55	61.52	74.00	-12.48	PK
V	7236.00	43.27	38.33	7.52	24.55	37.01	54.00	-16.99	AV
V	15450.00	42.57	35.23	6.75	26.59	40.68	74.00	-33.32	PK
H	4824.00	71.42	39.55	7.85	25.66	65.38	74.00	-8.62	PK
H	4824.00	52.84	39.55	7.85	25.66	46.80	54.00	-7.20	AV
H	7236.00	73.61	38.33	7.52	23.55	66.35	74.00	-7.65	PK
H	7236.00	42.08	38.33	7.52	23.22	34.49	54.00	-19.51	AV
H	15450.00	46.10	35.45	6.75	27.88	45.28	74.00	-28.72	PK

Polar (H/V)	Frequency	Meter Reading	Pre-amplifier	Cable Loss	Antenna Factor	Emission Level	Limits	Margin	Detector Type
	(MHz)	(dBuV)	(dB)	(dB)	(dB)	(dBuV/m)	(dBuV/m)	(dB)	
802.11g Middle Channel:2437MHz									
V	4874.00	65.73	39.55	7.85	25.66	59.69	74.00	-14.31	PK
V	4874.00	46.61	39.55	7.85	25.66	40.57	54.00	-13.43	AV
V	7311.00	68.88	38.33	7.52	24.55	62.62	74.00	-11.38	PK
V	7311.00	42.97	38.33	7.52	24.55	36.71	54.00	-17.29	AV
V	15450.00	41.87	35.23	6.75	26.59	39.98	74.00	-34.02	PK
H	4874.00	69.82	39.55	7.85	25.66	63.78	74.00	-10.22	PK
H	4874.00	54.02	39.55	7.85	25.66	47.98	54.00	-6.02	AV
H	7311.00	74.12	38.33	7.52	23.55	66.86	74.00	-7.14	PK
H	7311.00	46.91	38.33	7.52	23.22	39.32	54.00	-14.68	AV
H	15450.00	45.82	35.45	6.75	27.88	45.00	74.00	-29.00	PK

Polar (H/V)	Frequency	Meter Reading	Pre-amplifier	Cable Loss	Antenna Factor	Emission Level	Limits	Margin	Detector Type
	(MHz)	(dBuV)	(dB)	(dB)	(dB)	(dBuV/m)	(dBuV/m)	(dB)	
802.11g High Channel:2462MHz									
V	4924.00	61.82	39.55	7.85	25.66	55.78	74.00	-18.22	PK
V	4924.00	47.02	39.55	7.85	25.66	40.98	54.00	-13.02	AV
V	7386.00	65.69	38.33	7.52	24.55	59.43	74.00	-14.57	PK
V	7386.00	41.82	38.33	7.52	24.55	35.56	54.00	-18.44	AV
V	15450.00	41.84	35.23	6.75	26.59	39.95	74.00	-34.05	PK
H	4924.00	70.76	39.55	7.85	25.66	64.72	74.00	-9.28	PK
H	4924.00	51.92	39.55	7.85	25.66	45.88	54.00	-8.12	AV
H	7386.00	70.66	38.33	7.52	23.55	63.40	74.00	-10.60	PK
H	7386.00	45.10	38.33	7.52	23.22	37.51	54.00	-16.49	AV
H	15450.00	45.37	35.45	6.75	27.88	44.55	74.00	-29.45	PK

Remark:

1. Emission Level = Meter Reading + Antenna Factor + Cable Loss – Pre-amplifier, Margin= Emission Level - Limit
2. If peak below the average limit, the average emission was no test.
3. The amplitude of spurious emissions which are attenuated by more than 20dB below the permissible value has no need to be reported.



Polar (H/V)	Frequency	Meter Reading	Pre-amplifier	Cable Loss	Antenna Factor	Emission Level	Limits	Margin	Detector Type
	(MHz)	(dBuV)	(dB)	(dB)	(dB)	(dBuV/m)	(dBuV/m)	(dB)	
802.11n20 Low Channel:2412MHz									
V	4824.00	62.91	39.55	7.85	25.66	56.87	74.00	-17.13	PK
V	4824.00	45.96	39.55	7.85	25.66	39.92	54.00	-14.08	AV
V	7236.00	66.42	38.33	7.52	24.55	60.16	74.00	-13.84	PK
V	7236.00	46.81	38.33	7.52	24.55	40.55	54.00	-13.45	AV
V	15450.00	38.97	35.23	6.75	26.59	37.08	74.00	-36.92	PK
H	4824.00	67.40	39.55	7.85	25.66	61.36	74.00	-12.64	PK
H	4824.00	50.62	39.55	7.85	25.66	44.58	54.00	-9.42	AV
H	7236.00	74.39	38.33	7.52	23.55	67.13	74.00	-6.87	PK
H	7236.00	44.71	38.33	7.52	23.22	37.12	54.00	-16.88	AV
H	15450.00	42.87	35.45	6.75	27.88	42.05	74.00	-31.95	PK

Polar (H/V)	Frequency	Meter Reading	Pre-amplifier	Cable Loss	Antenna Factor	Emission Level	Limits	Margin	Detector Type
	(MHz)	(dBuV)	(dB)	(dB)	(dB)	(dBuV/m)	(dBuV/m)	(dB)	
802.11n20 Middle Channel:2437MHz									
V	4874.00	63.45	39.55	7.85	25.66	57.41	74.00	-16.59	PK
V	4874.00	44.41	39.55	7.85	25.66	38.37	54.00	-15.63	AV
V	7311.00	67.68	38.33	7.52	24.55	61.42	74.00	-12.58	PK
V	7311.00	41.56	38.33	7.52	24.55	35.30	54.00	-18.70	AV
V	15450.00	38.41	35.23	6.75	26.59	36.52	74.00	-37.48	PK
H	4874.00	71.09	39.55	7.85	25.66	65.05	74.00	-8.95	PK
H	4874.00	53.11	39.55	7.85	25.66	47.07	54.00	-6.93	AV
H	7311.00	75.30	38.33	7.52	23.55	68.04	74.00	-5.96	PK
H	7311.00	46.40	38.33	7.52	23.22	38.81	54.00	-15.19	AV
H	15450.00	43.24	35.45	6.75	27.88	42.42	74.00	-31.58	PK

Polar (H/V)	Frequency	Meter Reading	Pre-amplifier	Cable Loss	Antenna Factor	Emission Level	Limits	Margin	Detector Type
	(MHz)	(dBuV)	(dB)	(dB)	(dB)	(dBuV/m)	(dBuV/m)	(dB)	
802.11n20 High Channel:2462MHz									
V	4924.00	64.47	39.55	7.85	25.66	58.43	74.00	-15.57	PK
V	4924.00	47.88	39.55	7.85	25.66	41.84	54.00	-12.16	AV
V	7386.00	66.76	38.33	7.52	24.55	60.50	74.00	-13.50	PK
V	7386.00	46.65	38.33	7.52	24.55	40.39	54.00	-13.61	AV
V	15450.00	42.02	35.23	6.75	26.59	40.13	74.00	-33.87	PK
H	4924.00	70.52	39.55	7.85	25.66	64.48	74.00	-9.52	PK
H	4924.00	52.21	39.55	7.85	25.66	46.17	54.00	-7.83	AV
H	7386.00	70.49	38.33	7.52	23.55	63.23	74.00	-10.77	PK
H	7386.00	47.04	38.33	7.52	23.22	39.45	54.00	-14.55	AV
H	15450.00	48.21	35.45	6.75	27.88	47.39	74.00	-26.61	PK

Remark:

1. Emission Level = Meter Reading + Antenna Factor + Cable Loss – Pre-amplifier, Margin= Emission Level - Limit
2. If peak below the average limit, the average emission was no test.
3. The amplitude of spurious emissions which are attenuated by more than 20dB below the permissible value has no need to be reported.



Polar (H/V)	Frequency	Meter Reading	Pre-amplifier	Cable Loss	Antenna Factor	Emission Level	Limits	Margin	Detector Type
	(MHz)	(dBuV)	(dB)	(dB)	(dB)	(dBuV/m)	(dBuV/m)	(dB)	
802.11n40 Low Channel:2422MHz									
V	4824.00	65.63	39.55	7.85	25.66	59.59	74.00	-14.41	PK
V	4824.00	48.60	39.55	7.85	25.66	42.56	54.00	-11.44	AV
V	7236.00	65.53	38.33	7.52	24.55	59.27	74.00	-14.73	PK
V	7236.00	46.64	38.33	7.52	24.55	40.38	54.00	-13.62	AV
V	15450.00	42.03	35.23	6.75	26.59	40.14	74.00	-33.86	PK
H	4824.00	68.86	39.55	7.85	25.66	62.82	74.00	-11.18	PK
H	4824.00	51.04	39.55	7.85	25.66	45.00	54.00	-9.00	AV
H	7236.00	70.01	38.33	7.52	23.55	62.75	74.00	-11.25	PK
H	7236.00	44.26	38.33	7.52	23.22	36.67	54.00	-17.33	AV
H	15450.00	50.20	35.45	6.75	27.88	49.38	74.00	-24.62	PK

Polar (H/V)	Frequency	Meter Reading	Pre-amplifier	Cable Loss	Antenna Factor	Emission Level	Limits	Margin	Detector Type
	(MHz)	(dBuV)	(dB)	(dB)	(dB)	(dBuV/m)	(dBuV/m)	(dB)	
802.11n40 Middle Channel:2437MHz									
V	4874.00	61.87	39.55	7.85	25.66	55.83	74.00	-18.17	PK
V	4874.00	50.13	39.55	7.85	25.66	44.09	54.00	-9.91	AV
V	7311.00	67.46	38.33	7.52	24.55	61.20	74.00	-12.80	PK
V	7311.00	49.48	38.33	7.52	24.55	43.22	54.00	-10.78	AV
V	15450.00	39.56	35.23	6.75	26.59	37.67	74.00	-36.33	PK
H	4874.00	73.40	39.55	7.85	25.66	67.36	74.00	-6.64	PK
H	4874.00	51.24	39.55	7.85	25.66	45.20	54.00	-8.80	AV
H	7311.00	72.48	38.33	7.52	23.55	65.22	74.00	-8.78	PK
H	7311.00	44.05	38.33	7.52	23.22	36.46	54.00	-17.54	AV
H	15450.00	48.74	35.45	6.75	27.88	47.92	74.00	-26.08	PK

Polar (H/V)	Frequency	Meter Reading	Pre-amplifier	Cable Loss	Antenna Factor	Emission Level	Limits	Margin	Detector Type
	(MHz)	(dBuV)	(dB)	(dB)	(dB)	(dBuV/m)	(dBuV/m)	(dB)	
802.11n40 High Channel:2452MHz									
V	4904.00	65.88	39.55	7.85	25.66	59.84	74.00	-14.16	PK
V	4904.00	49.95	39.55	7.85	25.66	43.91	54.00	-10.09	AV
V	7365.00	65.12	38.33	7.52	24.55	58.86	74.00	-15.14	PK
V	7365.00	46.02	38.33	7.52	24.55	39.76	54.00	-14.24	AV
V	15450.00	43.56	35.23	6.75	26.59	41.67	74.00	-32.33	PK
H	4904.00	68.54	39.55	7.85	25.66	62.50	74.00	-11.50	PK
H	4904.00	49.42	39.55	7.85	25.66	43.38	54.00	-10.62	AV
H	7365.00	68.56	38.33	7.52	23.55	61.30	74.00	-12.70	PK
H	7365.00	47.82	38.33	7.52	23.22	40.23	54.00	-13.77	AV
H	15450.00	50.46	35.45	6.75	27.88	49.64	74.00	-24.36	PK

Remark:

1. Emission Level = Meter Reading + Antenna Factor + Cable Loss – Pre-amplifier, Margin= Emission Level - Limit
2. If peak below the average limit, the average emission was no test.
3. The amplitude of spurious emissions which are attenuated by more than 20dB below the permissible value has no need to be reported.



Radiated Bandedge Emission

Temperature:	25°C	Relative Humidity:	54%
Pressure:	1010 hPa	Test Voltage :	AC 120V/60Hz
Test Mode :	802.11b Low Channel	Polarization :	Horizontal

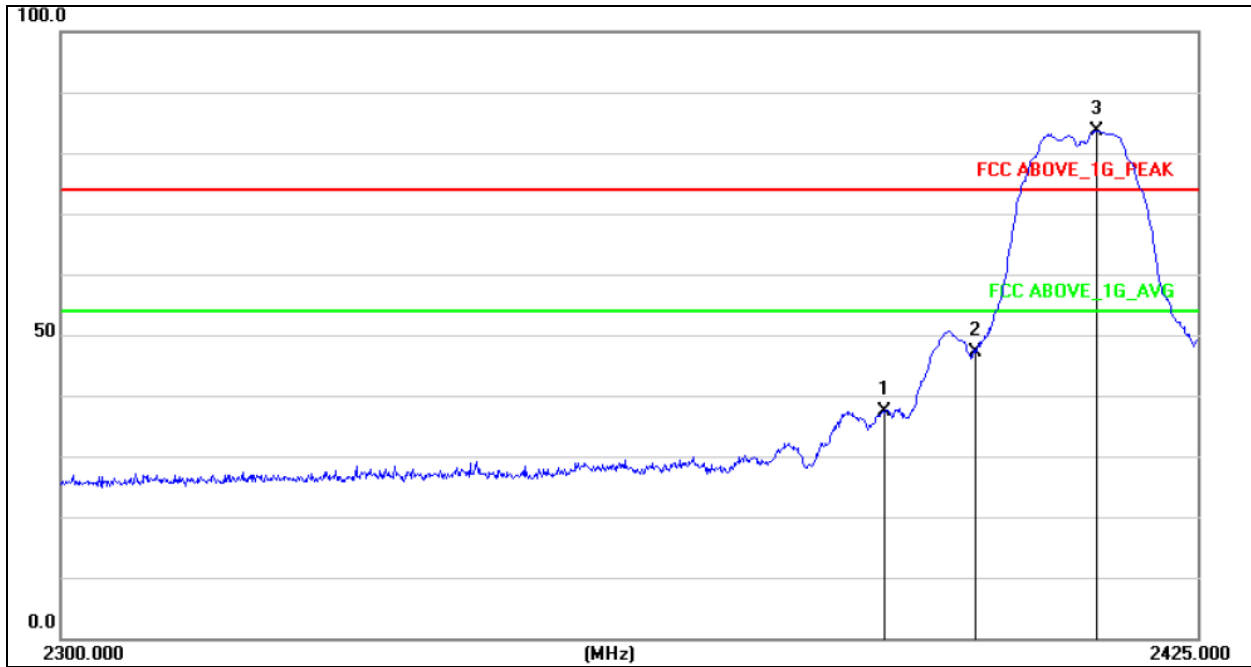

Remark:
Factor = Antenna Factor + Cable Loss – Pre-amplifier.

No.	Frequency (MHz)	Reading (dBuV/m)	Correct Factor(dB/m)	Result (dBuV/m)	Limit (dBuV/m)	Margin (dB)	Remark
1	2390.000	53.91	-16.52	37.39	74.00	-36.61	peak
2	2400.000	63.65	-16.50	47.15	74.00	-26.85	peak
3	2413.625	100.14	-16.48	83.66	74.00	9.66	peak



Temperature:	25°C	Relative Humidity:	54%
Pressure:	1010 hPa	Test Voltage :	AC 120V/60Hz
Test Mode :	802.11b Low Channel	Polarization :	Vertical

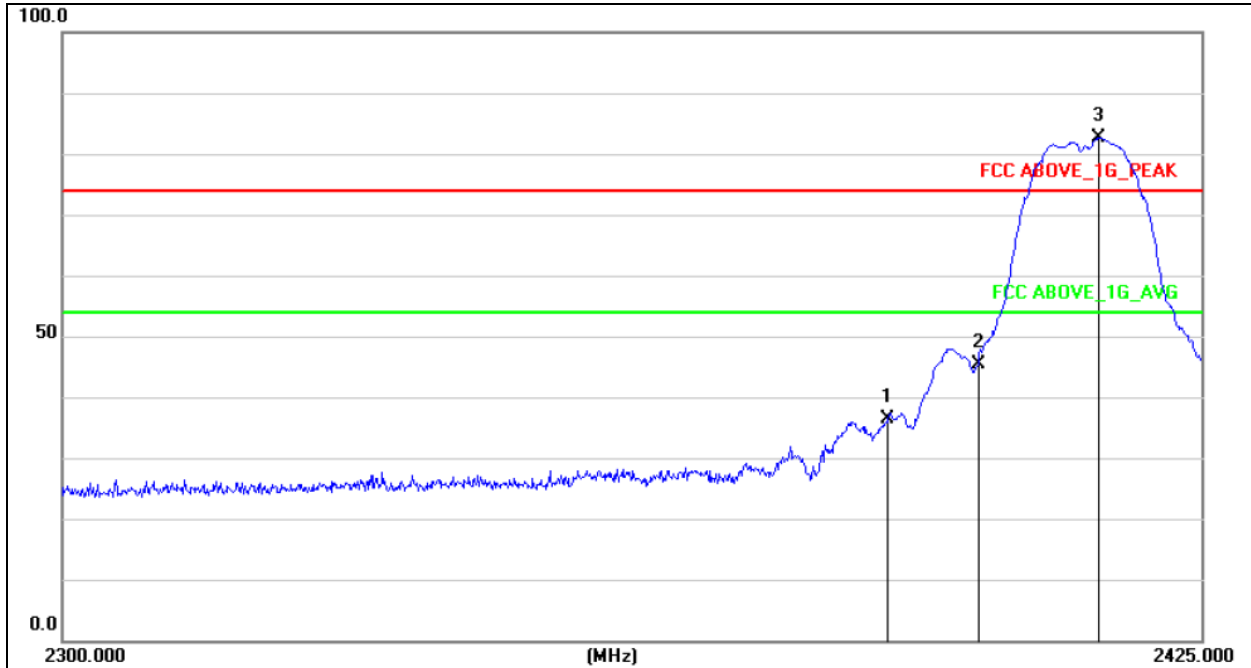

Remark:
Factor = Antenna Factor + Cable Loss – Pre-amplifier.

No.	Frequency (MHz)	Reading (dBuV/m)	Correct Factor(dB/m)	Result (dBuV/m)	Limit (dBuV/m)	Margin (dB)	Remark
1	2390.000	52.90	-16.52	36.38	74.00	-37.62	peak
2	2400.000	61.98	-16.50	45.48	74.00	-28.52	peak
3	2413.500	99.12	-16.48	82.64	74.00	8.64	peak



Temperature:	25°C	Relative Humidity:	54%
Pressure:	1010 hPa	Test Voltage :	AC 120V/60Hz
Test Mode :	802.11b High Channel	Polarization :	Horizontal

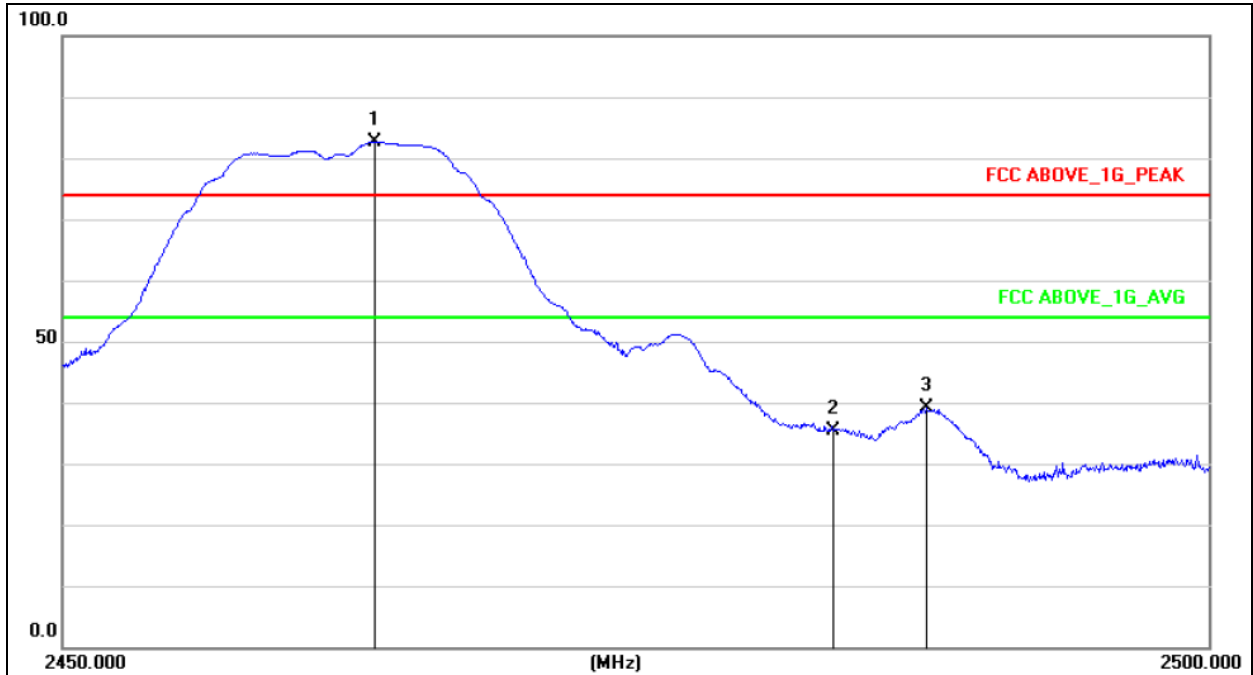

Remark:

Factor = Antenna Factor + Cable Loss – Pre-amplifier.

No.	Frequency (MHz)	Reading (dBuV/m)	Correct Factor(dB/m)	Result (dBuV/m)	Limit (dBuV/m)	Margin (dB)	Remark
1	2463.550	99.06	-16.41	82.65	74.00	8.65	peak
2	2483.500	51.81	-16.37	35.44	74.00	-38.56	peak
3	2487.650	55.51	-16.37	39.14	74.00	-34.86	peak



Temperature:	25°C	Relative Humidity:	54%
Pressure:	1010 hPa	Test Voltage :	AC 120V/60Hz
Test Mode :	802.11b High Channel	Polarization :	Vertical

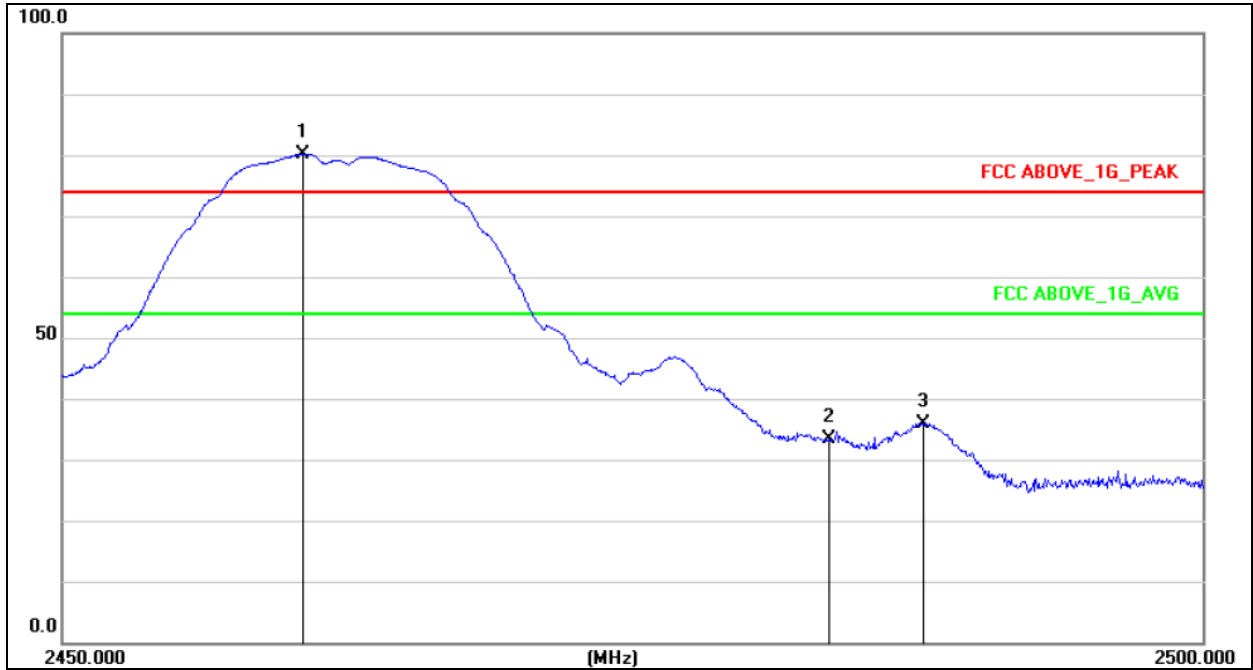

Remark:

Factor = Antenna Factor + Cable Loss – Pre-amplifier.

No.	Frequency (MHz)	Reading (dBuV/m)	Correct Factor(dB/m)	Result (dBuV/m)	Limit (dBuV/m)	Margin (dB)	Remark
P	2460.500	96.62	-16.41	80.21	74.00	6.21	peak
2	2483.500	49.87	-16.37	33.50	74.00	-40.50	peak
3	2487.700	52.35	-16.37	35.98	74.00	-38.02	peak



Temperature:	25°C	Relative Humidity:	54%
Pressure:	1010 hPa	Test Voltage :	AC 120V/60Hz
Test Mode :	802.11g Low Channel	Polarization :	Horizontal

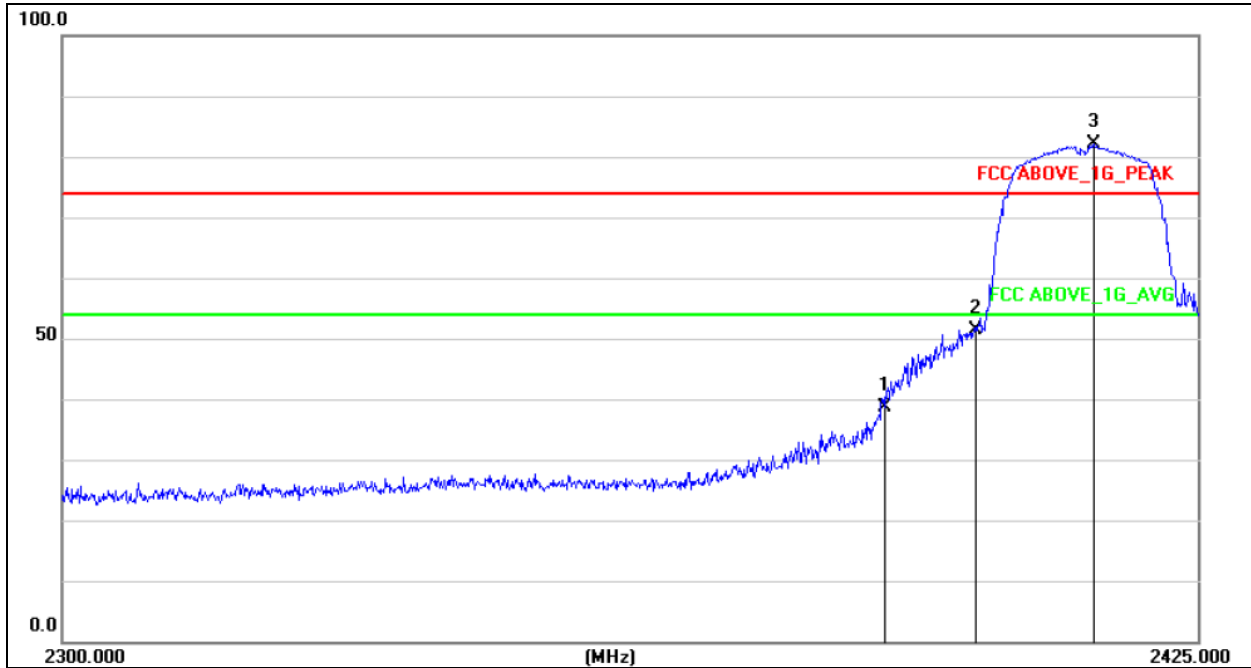

Remark:

Factor = Antenna Factor + Cable Loss – Pre-amplifier.

No.	Frequency (MHz)	Reading (dBuV/m)	Correct Factor(dB/m)	Result (dBuV/m)	Limit (dBuV/m)	Margin (dB)	Remark
1	2390.000	55.15	-16.52	38.63	74.00	-35.37	peak
2	2400.000	67.80	-16.50	51.30	74.00	-22.70	peak
3	2413.250	98.71	-16.48	82.23	74.00	8.23	peak



Temperature:	25°C	Relative Humidity:	54%
Pressure:	1010 hPa	Test Voltage :	AC 120V/60Hz
Test Mode :	802.11g Low Channel	Polarization :	Vertical



Remark:

Factor = Antenna Factor + Cable Loss – Pre-amplifier.

No.	Frequency (MHz)	Reading (dBuV/m)	Correct Factor(dB/m)	Result (dBuV/m)	Limit (dBuV/m)	Margin (dB)	Remark
1	2390.000	61.03	-16.52	44.51	74.00	-29.49	peak
2	2400.000	69.60	-16.50	53.10	74.00	-20.90	peak
3	2410.875	97.24	-16.48	80.76	74.00	6.76	peak



Temperature:	25°C	Relative Humidity:	54%
Pressure:	1010 hPa	Test Voltage :	AC 120V/60Hz
Test Mode :	802.11g High Channel	Polarization :	Horizontal

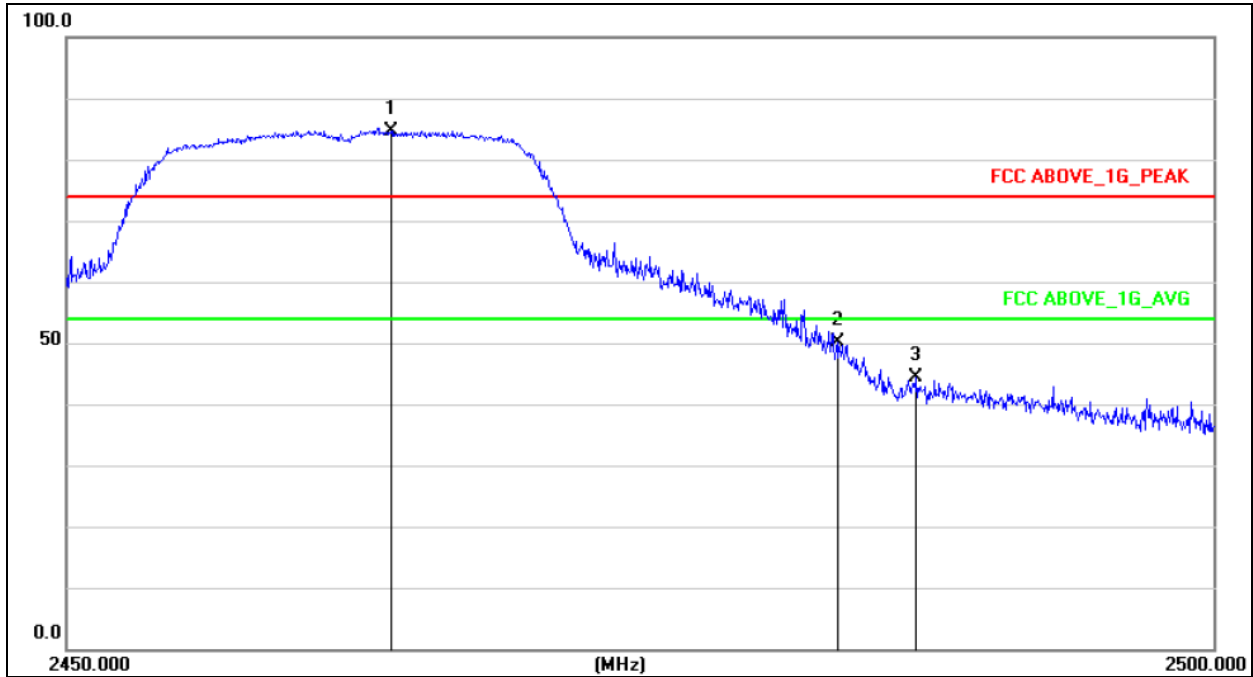

Remark:

Factor = Antenna Factor + Cable Loss – Pre-amplifier.

No.	Frequency (MHz)	Reading (dBuV/m)	Correct Factor(dB/m)	Result (dBuV/m)	Limit (dBuV/m)	Margin (dB)	Remark
1	2464.050	101.10	-16.41	84.69	74.00	10.69	peak
2	2483.500	66.60	-16.37	50.23	74.00	-23.77	peak
3	2487.000	60.67	-16.37	44.30	74.00	-29.70	peak



Temperature:	25°C	Relative Humidity:	54%
Pressure:	1010 hPa	Test Voltage :	AC 120V/60Hz
Test Mode :	802.11g High Channel	Polarization :	Vertical

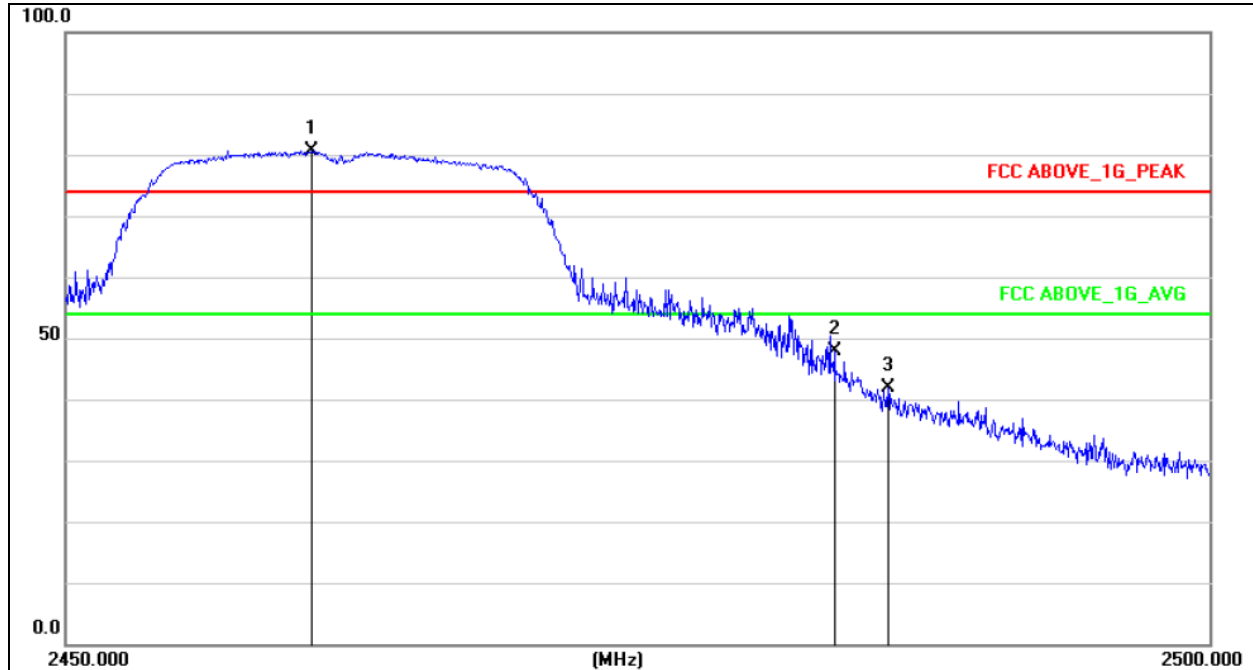

Remark:
Factor = Antenna Factor + Cable Loss – Pre-amplifier.

No.	Frequency (MHz)	Reading (dBuV/m)	Correct Factor(dB/m)	Result (dBuV/m)	Limit (dBuV/m)	Margin (dB)	Remark
1	2460.700	96.97	-16.41	80.56	74.00	6.56	peak
2	2483.500	64.26	-16.37	47.89	74.00	-26.11	peak
3	2485.850	58.23	-16.37	41.86	74.00	-32.14	peak



Temperature:	25°C	Relative Humidity:	54%
Pressure:	1010 hPa	Test Voltage :	AC 120V/60Hz
Test Mode :	802.11n20 Low Channel	Polarization :	Horizontal

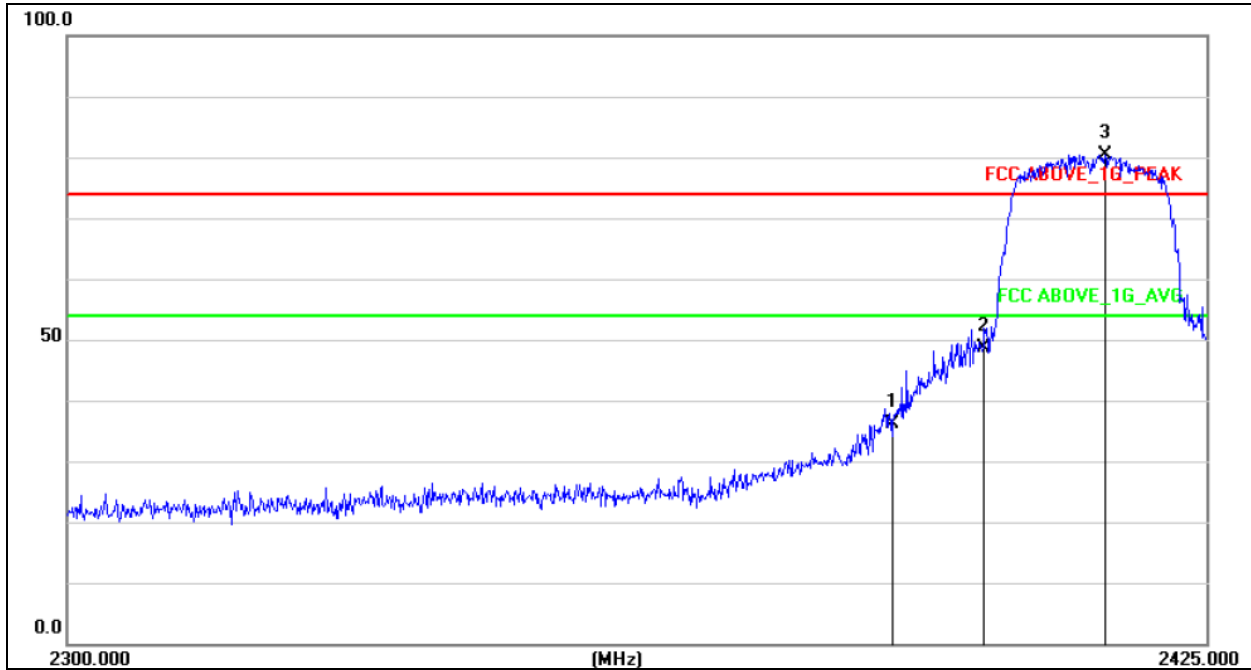

Remark:

Factor = Antenna Factor + Cable Loss – Pre-amplifier.

No.	Frequency (MHz)	Reading (dBuV/m)	Correct Factor(dB/m)	Result (dBuV/m)	Limit (dBuV/m)	Margin (dB)	Remark
1	2390.000	52.69	-16.52	36.17	74.00	-37.83	peak
2	2400.000	65.10	-16.50	48.60	74.00	-25.40	peak
3	2413.625	96.91	-16.48	80.43	74.00	6.43	peak



Temperature:	25°C	Relative Humidity:	54%
Pressure:	1010 hPa	Test Voltage :	AC 120V/60Hz
Test Mode :	802.11n20 Low Channel	Polarization :	Vertical

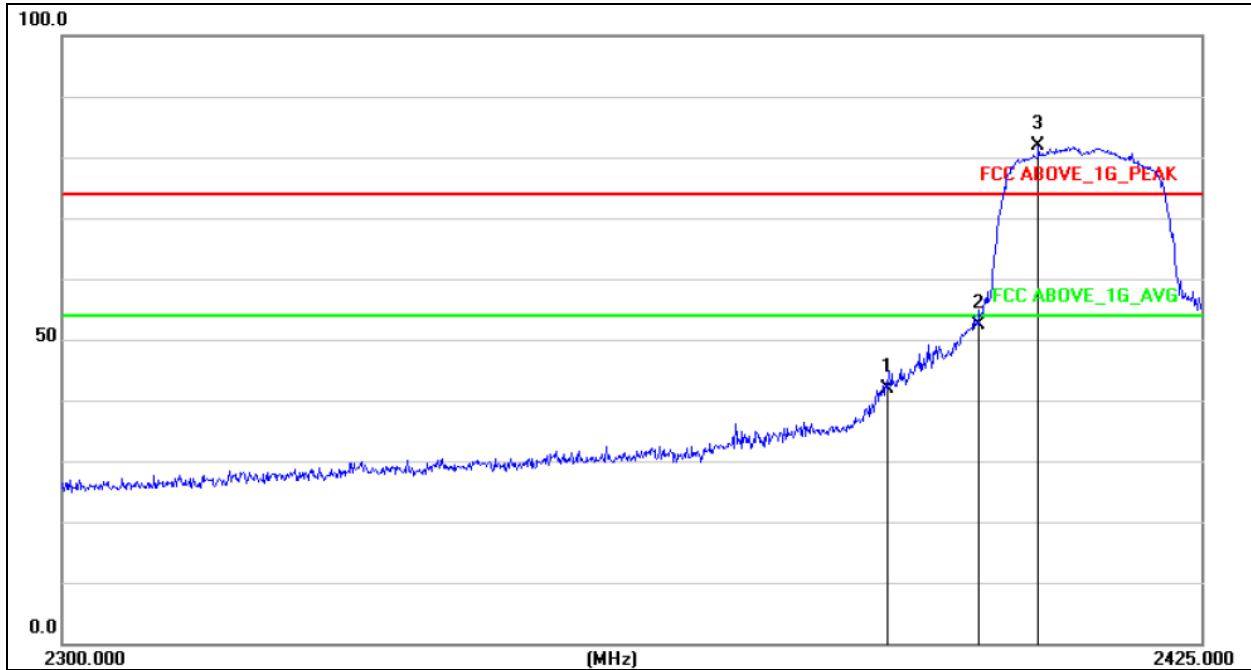

Remark:

Factor = Antenna Factor + Cable Loss – Pre-amplifier.

No.	Frequency (MHz)	Reading (dBuV/m)	Correct Factor(dB/m)	Result (dBuV/m)	Limit (dBuV/m)	Margin (dB)	Remark
1	2390.000	58.50	-16.52	41.98	74.00	-32.02	peak
2	2400.000	68.91	-16.50	52.41	74.00	-21.59	peak
3	2406.750	98.42	-16.49	81.93	74.00	7.93	peak



Temperature:	25°C	Relative Humidity:	54%
Pressure:	1010 hPa	Test Voltage :	AC 120V/60Hz
Test Mode :	802.11n20 High Channel	Polarization :	Horizontal

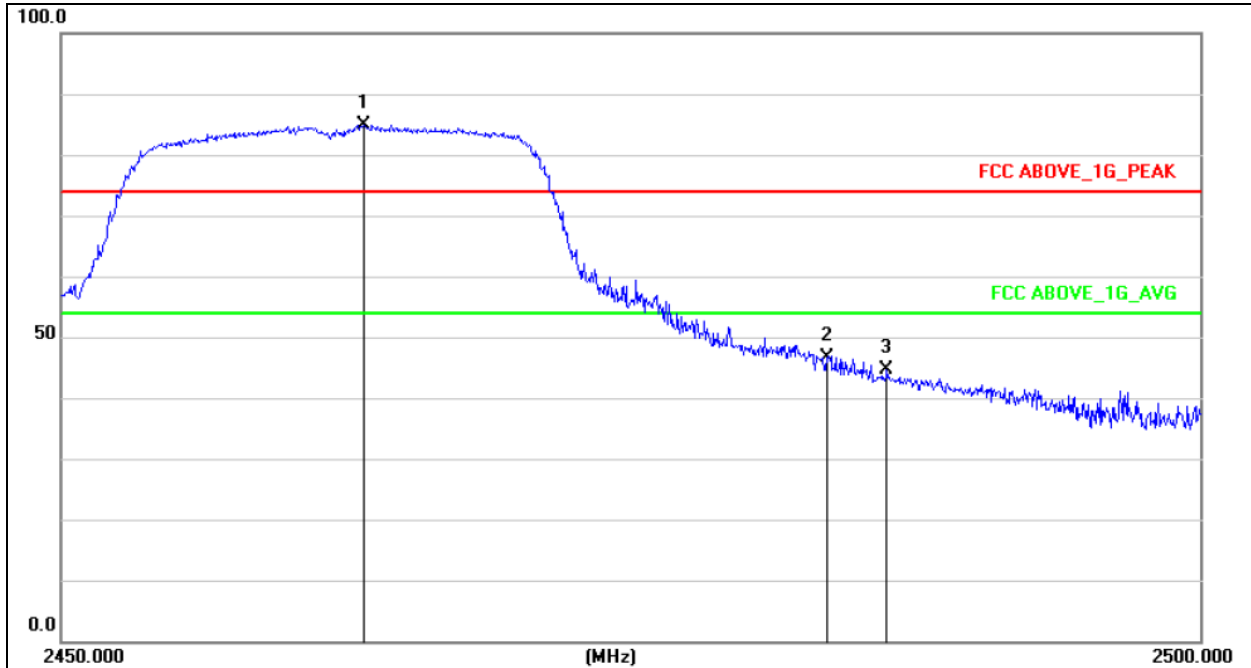

Remark:

Factor = Antenna Factor + Cable Loss – Pre-amplifier.

No.	Frequency (MHz)	Reading (dBuV/m)	Correct Factor(dB/m)	Result (dBuV/m)	Limit (dBuV/m)	Margin (dB)	Remark
1	2463.250	101.40	-16.41	84.99	74.00	10.99	peak
2	2483.500	62.91	-16.37	46.54	74.00	-27.46	peak
3	2486.150	61.03	-16.37	44.66	74.00	-29.34	peak



Temperature:	25°C	Relative Humidity:	54%
Pressure:	1010 hPa	Test Voltage :	AC 120V/60Hz
Test Mode :	802.11n20 High Channel	Polarization :	Vertical

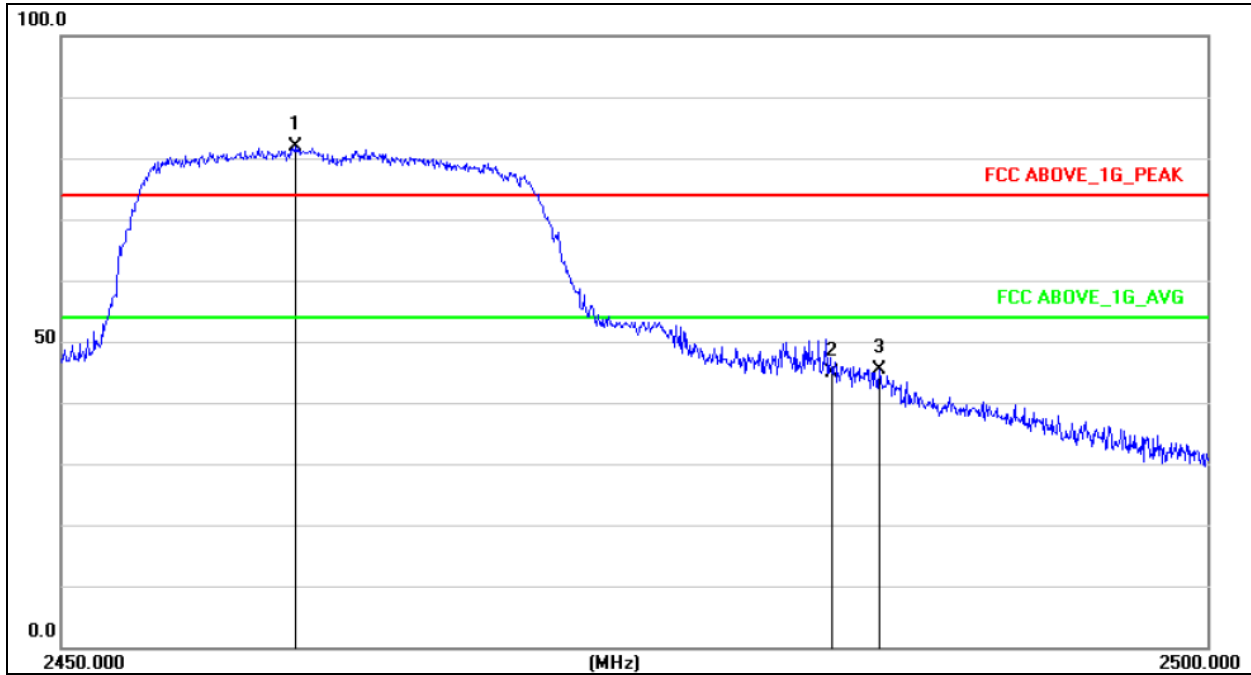

Remark:

Factor = Antenna Factor + Cable Loss – Pre-amplifier.

No.	Frequency (MHz)	Reading (dBuV/m)	Correct Factor(dB/m)	Result (dBuV/m)	Limit (dBuV/m)	Margin (dB)	Remark
1	2460.150	98.38	-16.41	81.97	74.00	7.97	peak
2	2483.500	61.25	-16.37	44.88	74.00	-29.12	peak
3	2485.600	61.64	-16.37	45.27	74.00	-28.73	peak



Temperature:	25°C	Relative Humidity:	54%
Pressure:	1010 hPa	Test Voltage :	AC 120V/60Hz
Test Mode :	802.11n40 Low Channel	Polarization :	Horizontal

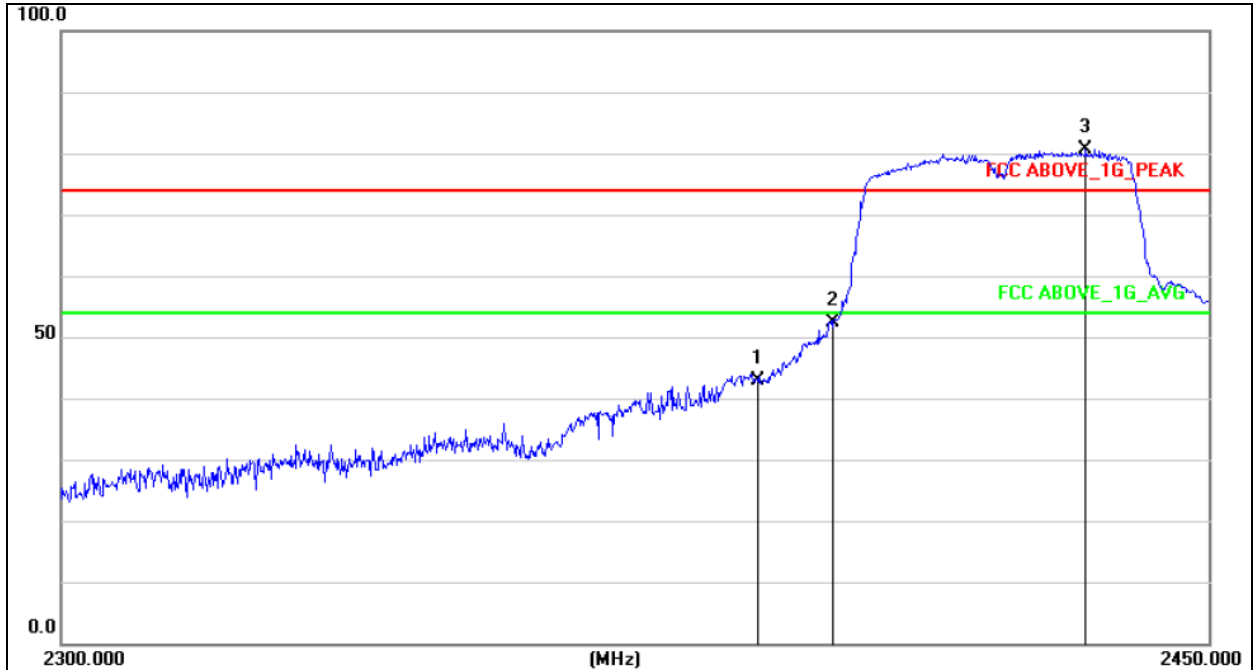

Remark:

Factor = Antenna Factor + Cable Loss – Pre-amplifier.

No.	Frequency (MHz)	Reading (dBuV/m)	Correct Factor(dB/m)	Result (dBuV/m)	Limit (dBuV/m)	Margin (dB)	Remark
1	2390.000	59.38	-16.52	42.86	74.00	-31.14	peak
2	2400.000	68.92	-16.50	52.42	74.00	-21.58	peak
3	2433.500	97.11	-16.44	80.67	74.00	6.67	peak



Temperature:	25°C	Relative Humidity:	54%
Pressure:	1010 hPa	Test Voltage :	AC 120V/60Hz
Test Mode :	802.11n40 Low Channel	Polarization :	Vertical

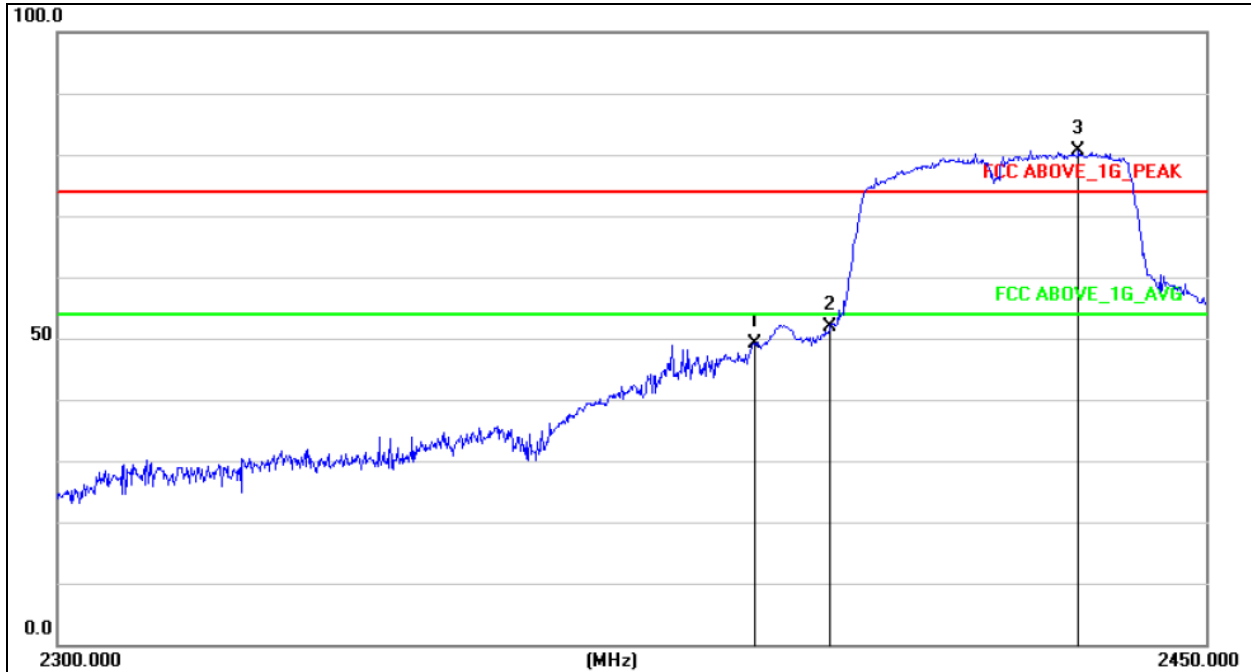

Remark:

Factor = Antenna Factor + Cable Loss – Pre-amplifier.

No.	Frequency (MHz)	Reading (dBuV/m)	Correct Factor(dB/m)	Result (dBuV/m)	Limit (dBuV/m)	Margin (dB)	Remark
1	2390.000	65.67	-16.52	49.15	74.00	-24.85	peak
2	2400.000	68.26	-16.50	51.76	74.00	-22.24	peak
3	2432.900	97.18	-16.44	80.74	74.00	6.74	peak



Temperature:	25°C	Relative Humidity:	54%
Pressure:	1010 hPa	Test Voltage :	AC 120V/60Hz
Test Mode :	802.11n40 High Channel	Polarization :	Horizontal

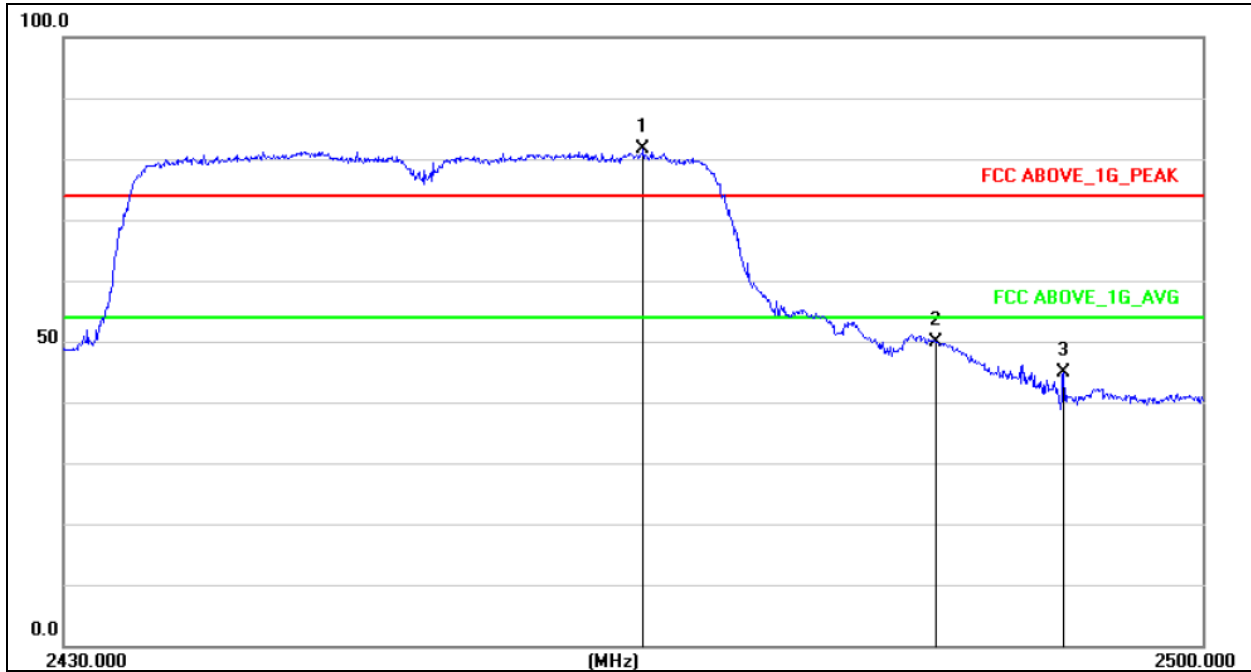

Remark:

Factor = Antenna Factor + Cable Loss – Pre-amplifier.

No.	Frequency (MHz)	Reading (dBuV/m)	Correct Factor(dB/m)	Result (dBuV/m)	Limit (dBuV/m)	Margin (dB)	Remark
1	2465.420	98.07	-16.41	81.66	74.00	7.66	peak
2	2483.500	66.24	-16.37	49.87	74.00	-24.13	peak
3	2491.390	61.21	-16.36	44.85	74.00	-29.15	peak



Temperature:	25°C	Relative Humidity:	54%
Pressure:	1010 hPa	Test Voltage :	AC 120V/60Hz
Test Mode :	802.11n40 High Channel	Polarization :	Vertical

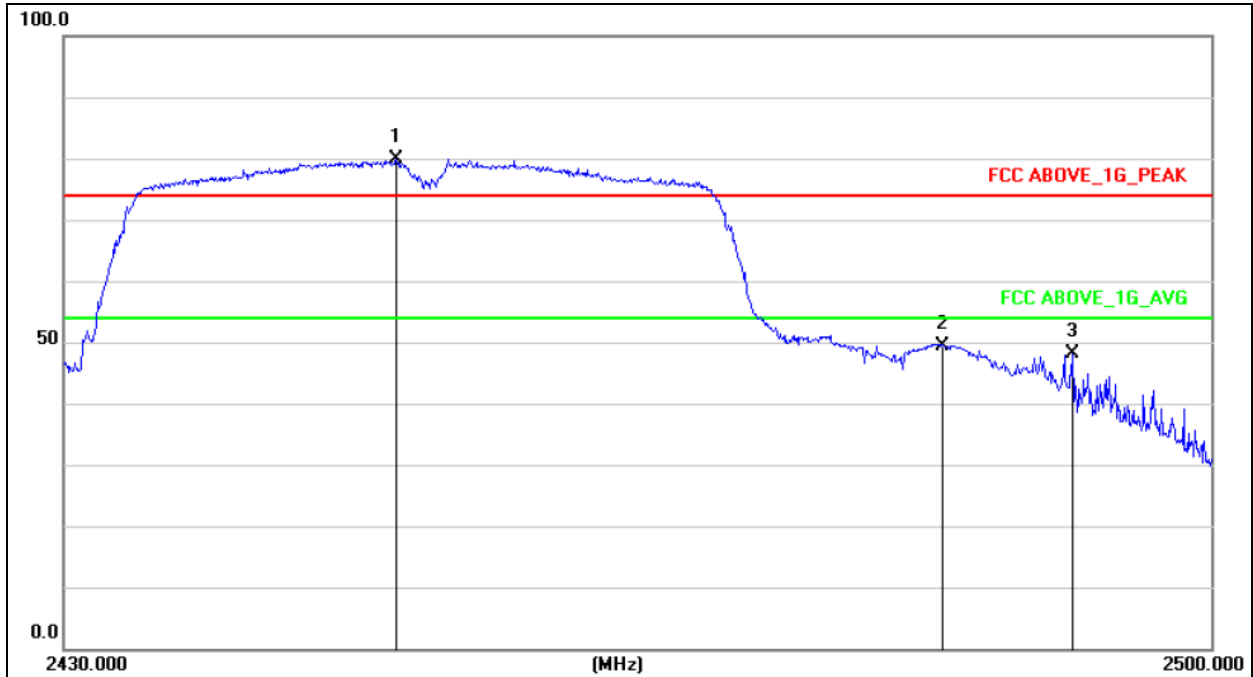

Remark:

Factor = Antenna Factor + Cable Loss – Pre-amplifier.

No.	Frequency (MHz)	Reading (dBuV/m)	Correct Factor(dB/m)	Result (dBuV/m)	Limit (dBuV/m)	Margin (dB)	Remark
1	2450.160	96.33	-16.43	79.90	74.00	5.90	peak
2	2483.500	65.79	-16.37	49.42	74.00	-24.58	peak
3	2491.460	64.47	-16.36	48.11	74.00	-25.89	peak

8. CONDUCTED EMISSION

8.1 Block Diagram Of Test Setup

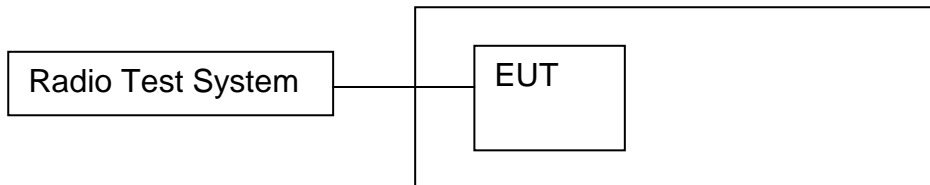

8.2 Limit

Regulation 15.247 (d), In any 100 kHz bandwidth outside the frequency band in which the spread spectrum or digitally modulated intentional radiator is operating, the radio frequency power that is produced by the intentional radiator shall be at least 20 dB below that in the 100 kHz bandwidth within the band that contains the highest level of the desired power, based on either an RF conducted or a radiated measurement, provided the transmitter demonstrates compliance with the peak conducted power limits. If the transmitter complies with the conducted power limits based on the use of RMS averaging over a time interval, as permitted under paragraph (b)(3) of this section, the attenuation required under this paragraph shall be 30 dB instead of 20 dB. Attenuation below the general limits specified in §15.209(a) is not required. In addition, radiated emissions which fall in the restricted bands, as defined in §15.205(a), must also comply with the radiated emission limits specified in §15.209(a) (see §15.205(c)).

8.3 Test procedure

1. Remove the antenna from the EUT and then connect a low RF cable from the antenna port to the spectrum;

2. Set the spectrum analyzer:

Below 30MHz:

RBW = 100kHz, VBW = 300kHz, Sweep = auto

Detector function = peak, Trace = max hold

Above 30MHz:

RBW = 100KHz, VBW = 300KHz, Sweep = auto

Detector function = peak, Trace = max hold



8.4 Test Result

9KHz - 30MHz
802.11b
Low Channel

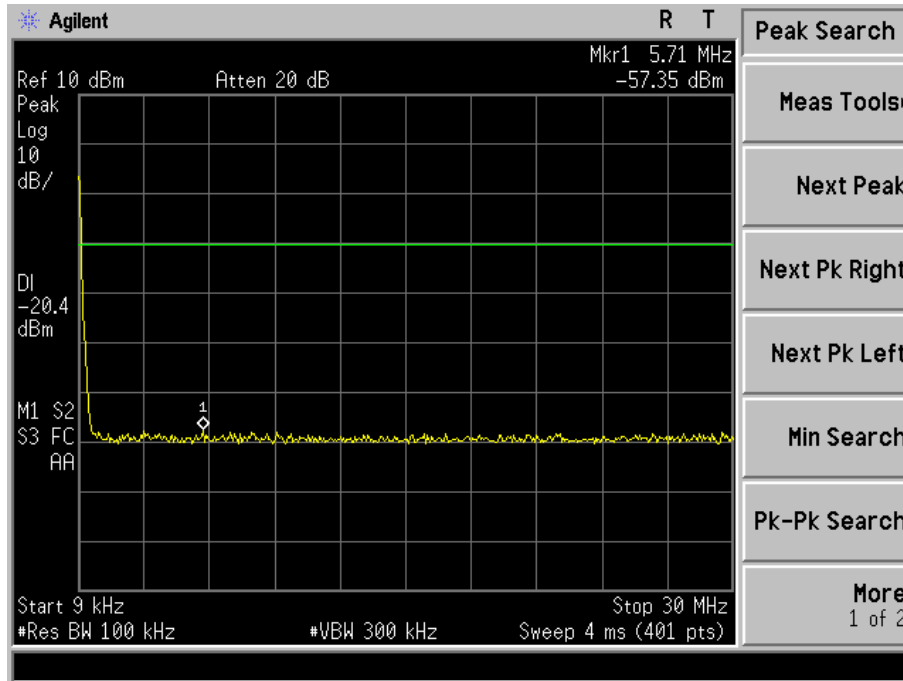

Middle Channel

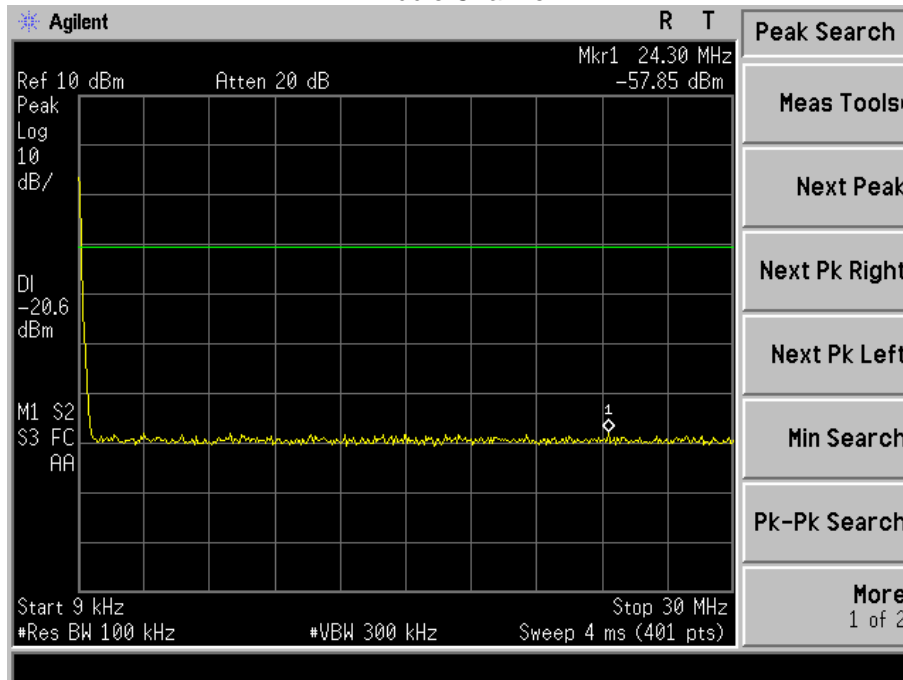



High Channel

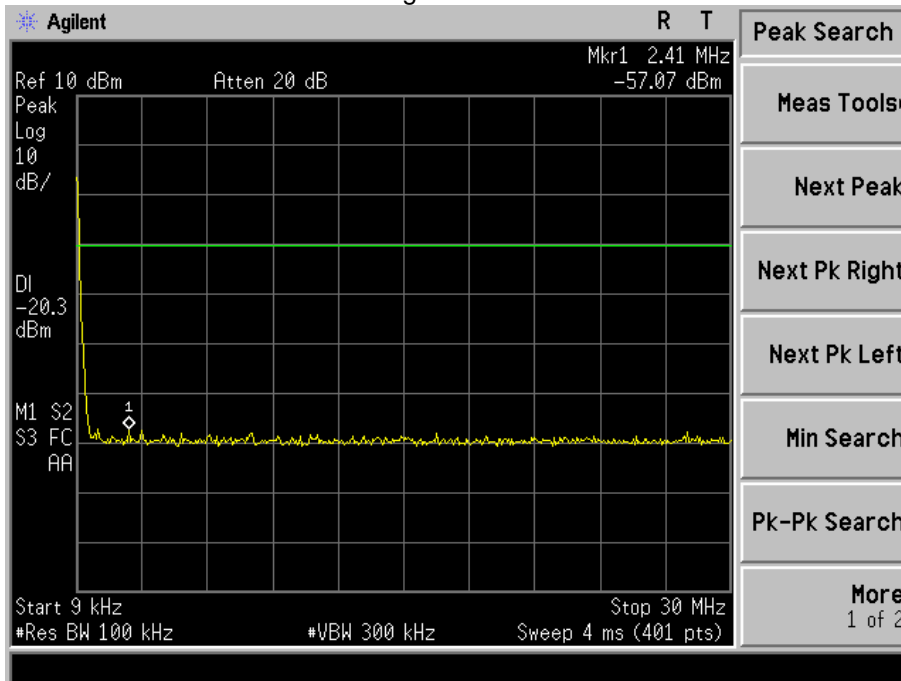

802.11g
Low Channel

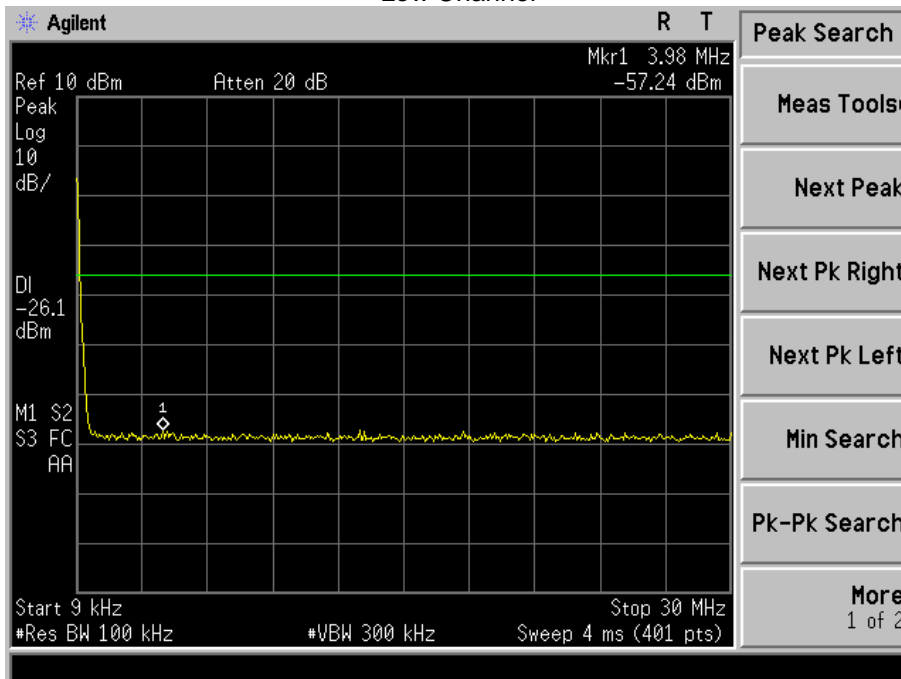



Middle Channel

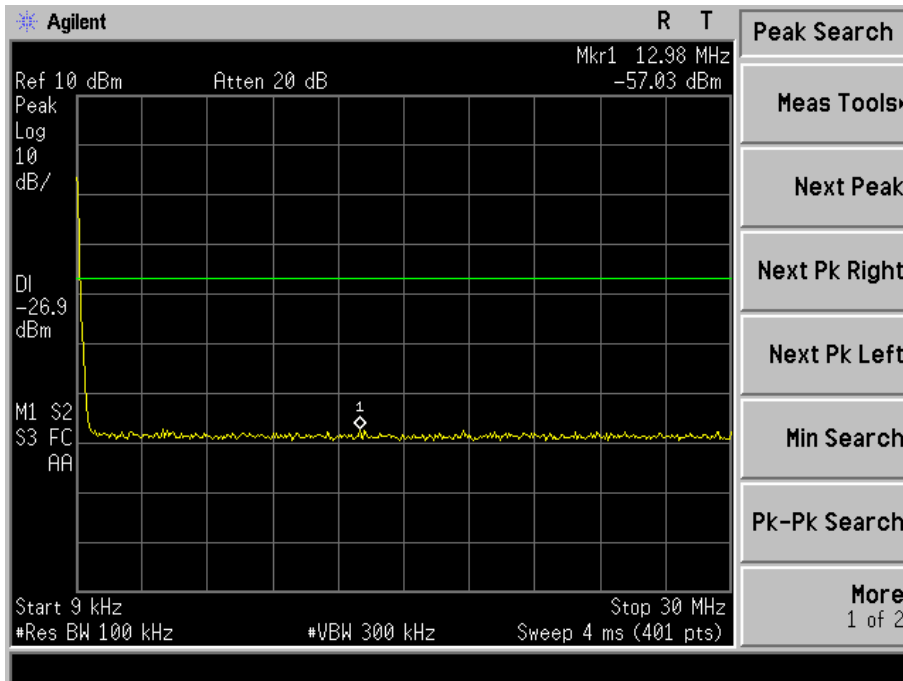

High Channel

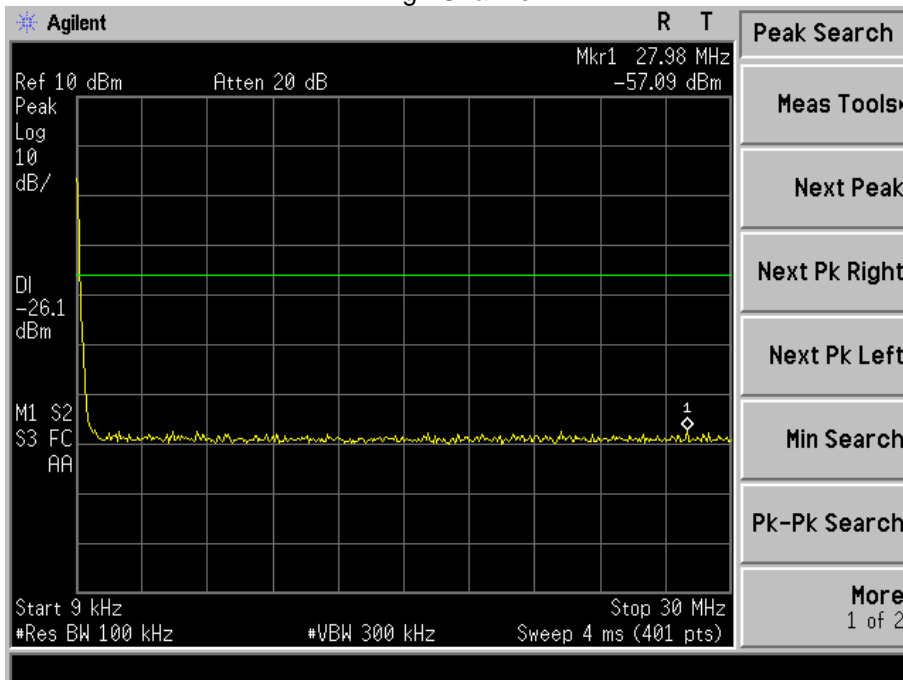



802.11n20
Low Channel

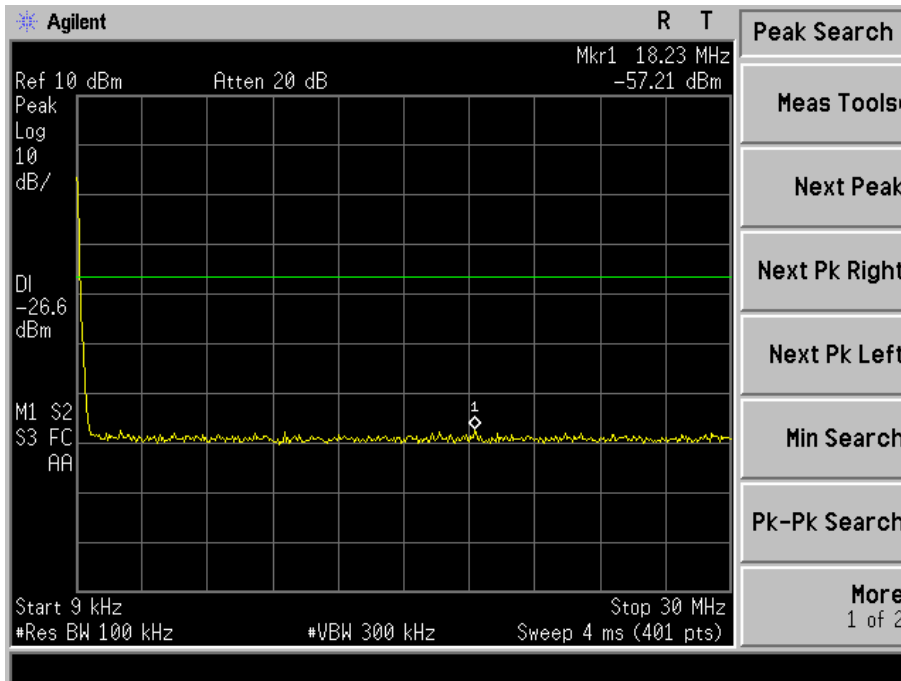

Middle Channel

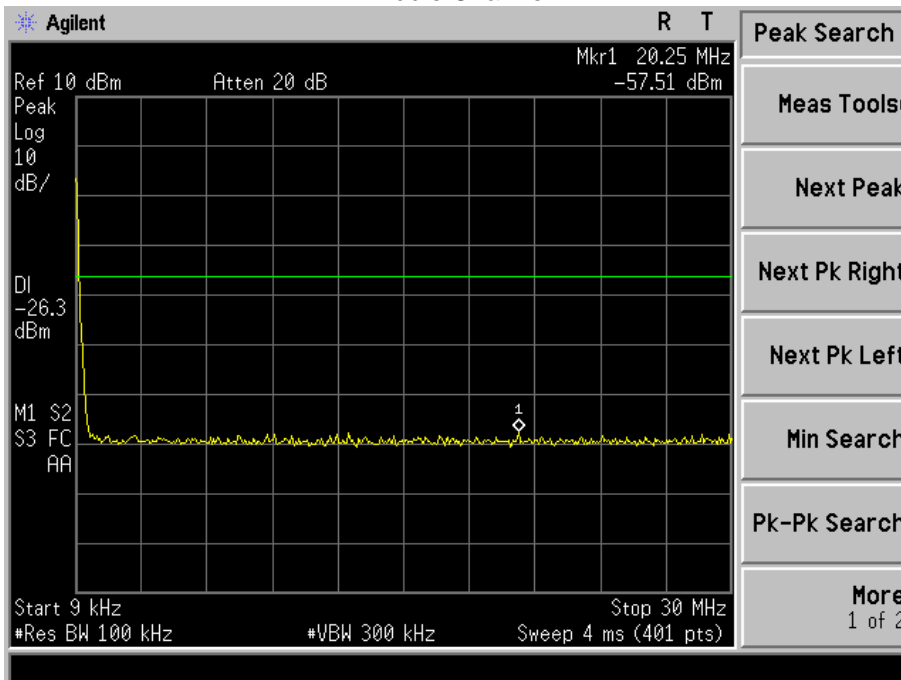



High Channel

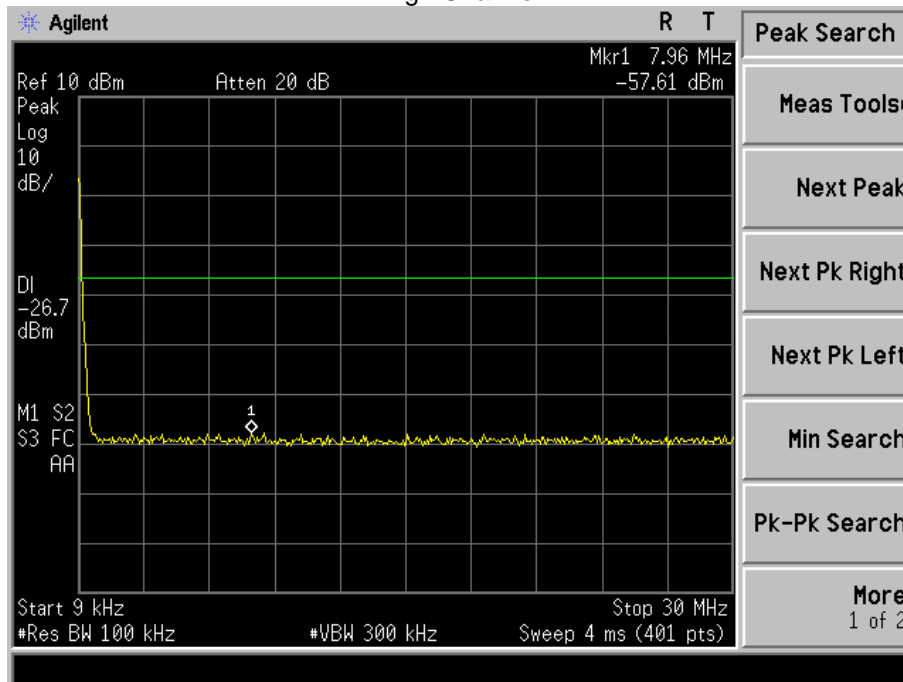

802.11n40
Low Channel

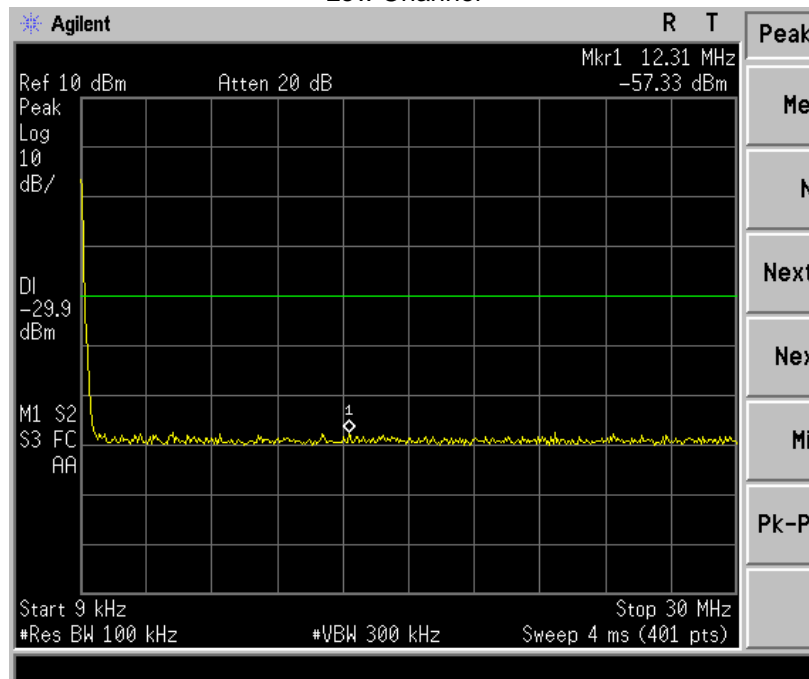



Middle Channel

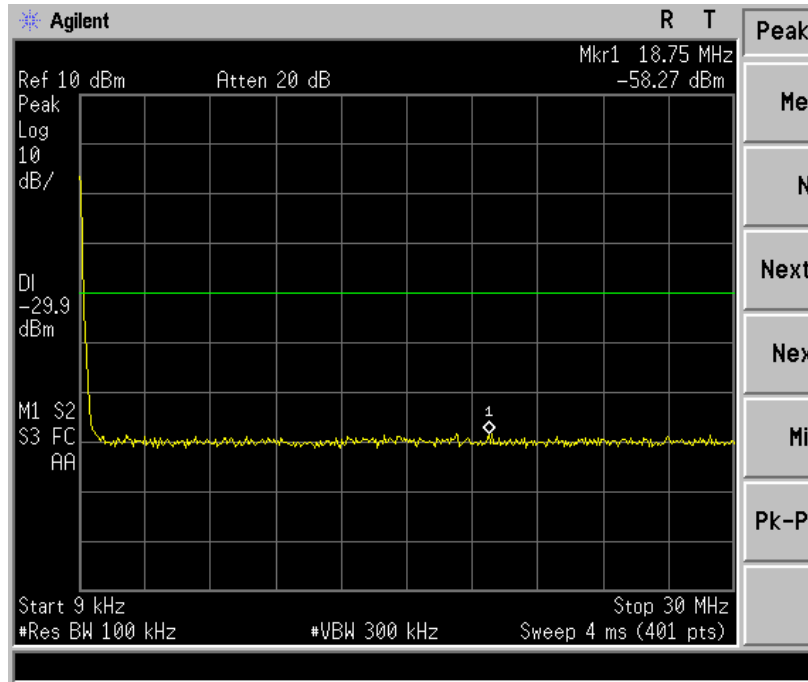

High Channel

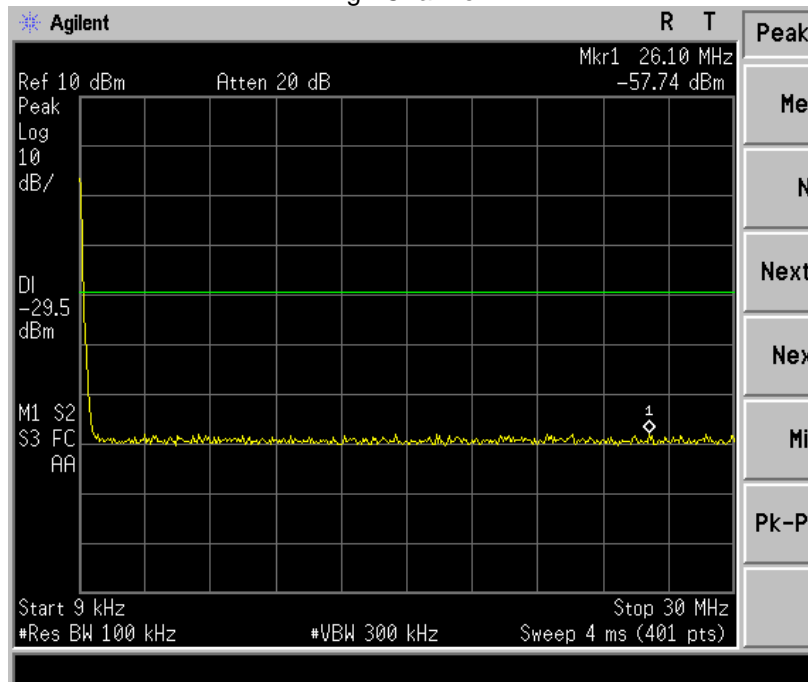



30MHz – 25GHz
802.11b Low Channel

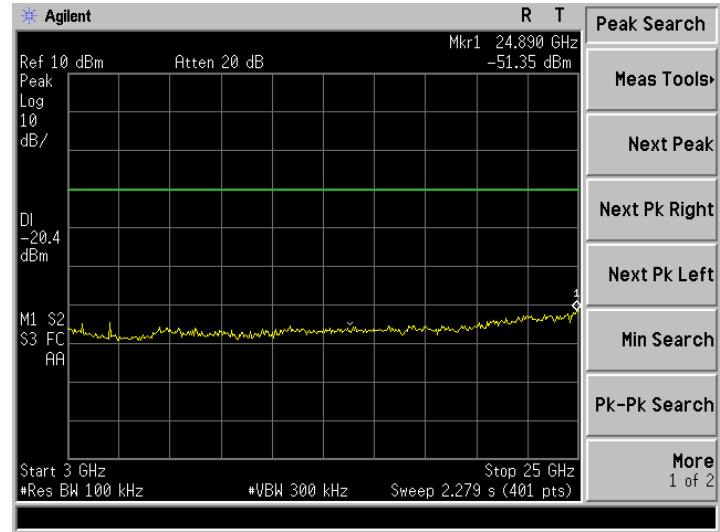
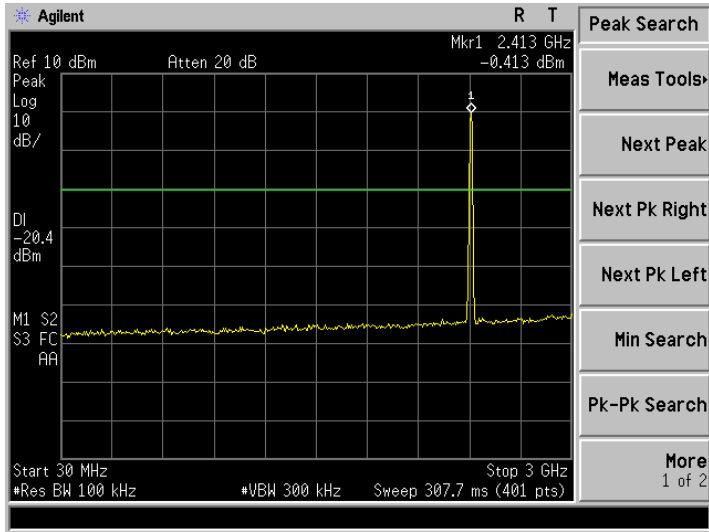

802.11b Middle Channel

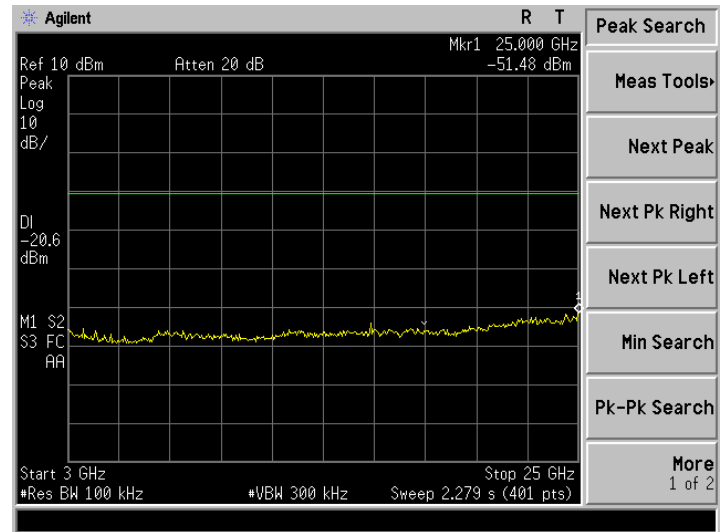
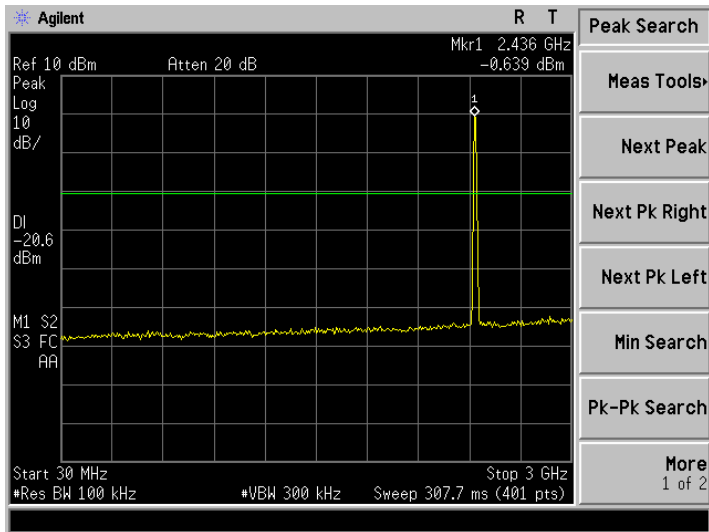



802.11b High Channel

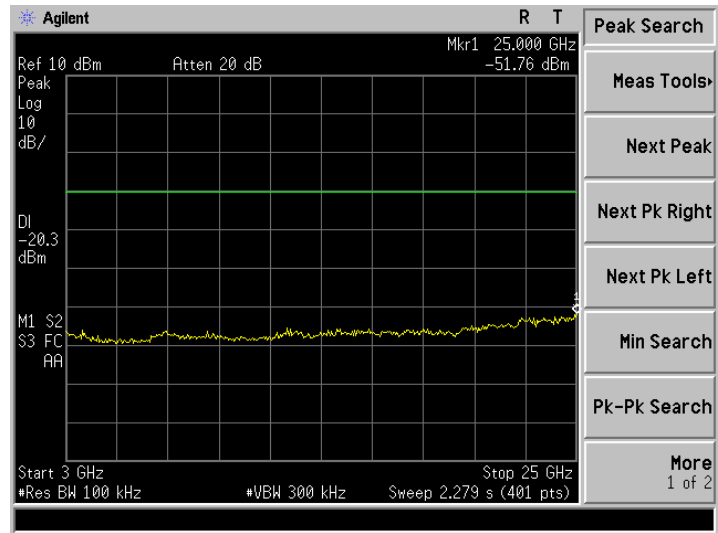
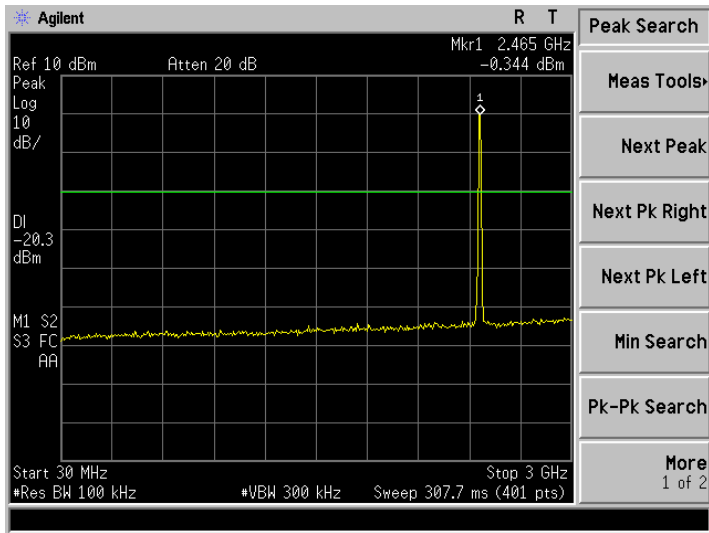

802.11g Low Channel

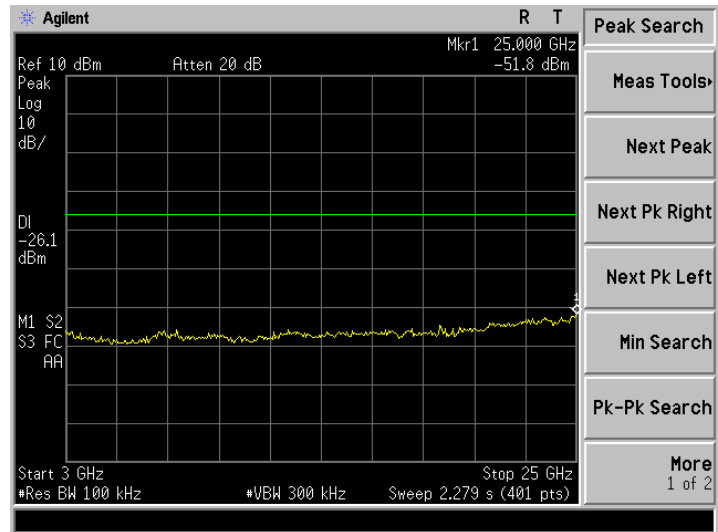
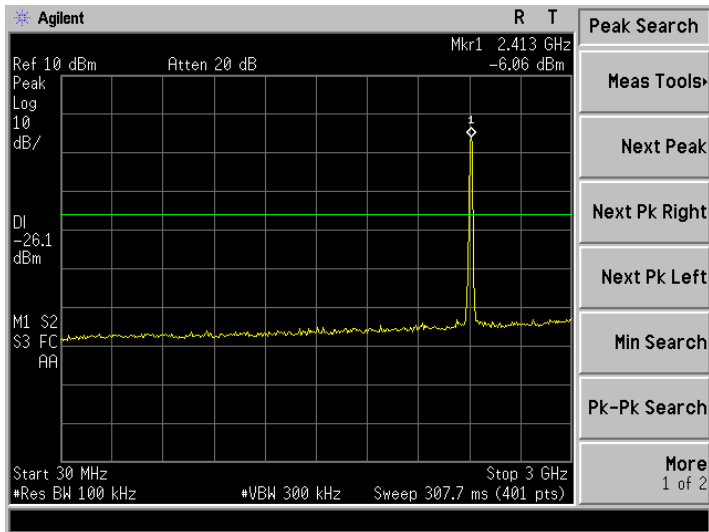



802.11g Middle Channel

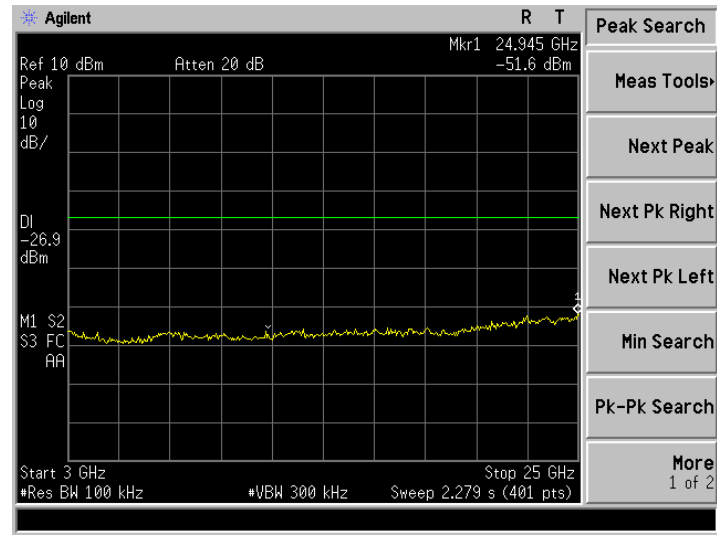
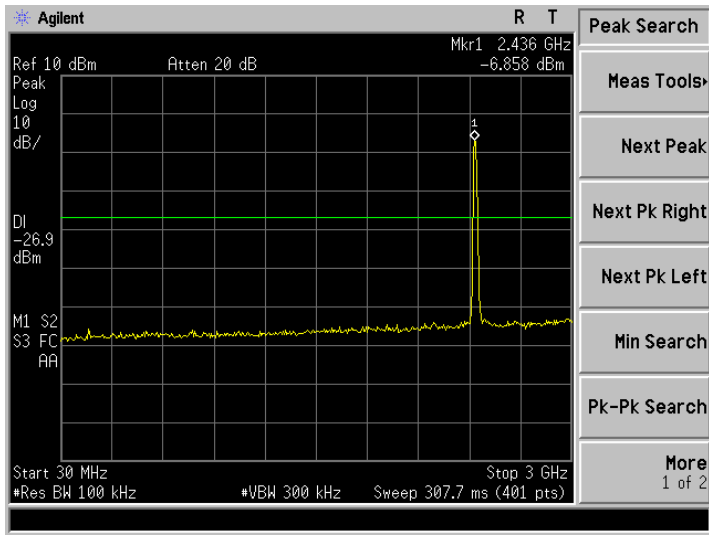

802.11g High Channel

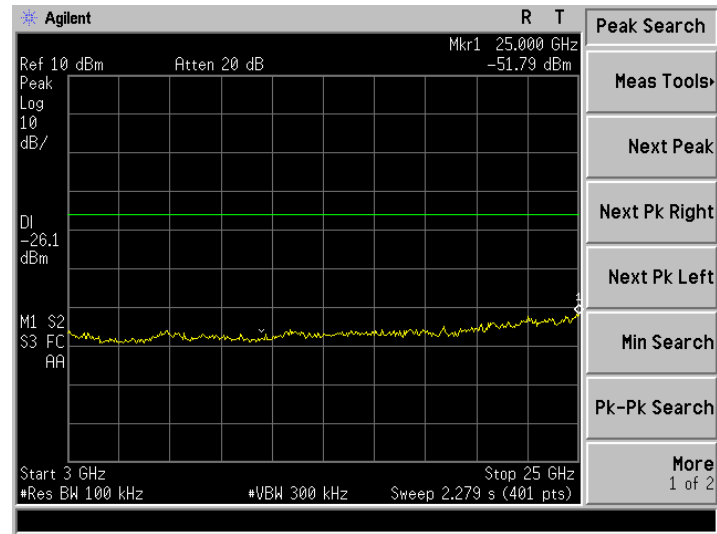
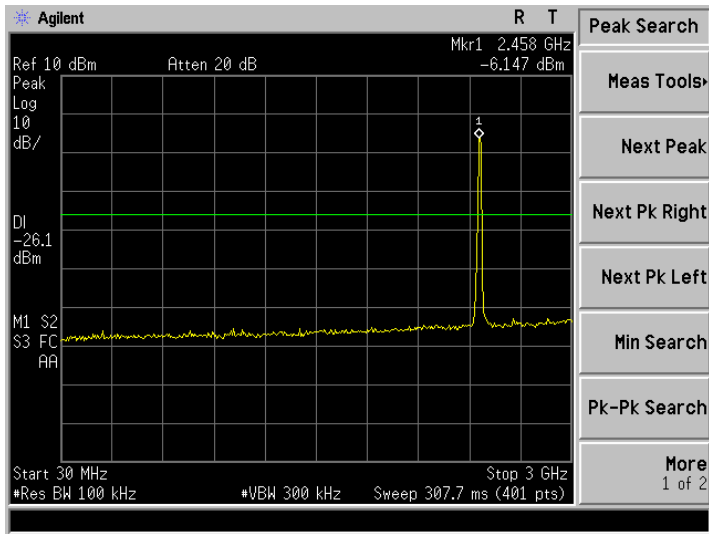



802.11n20 Low Channel

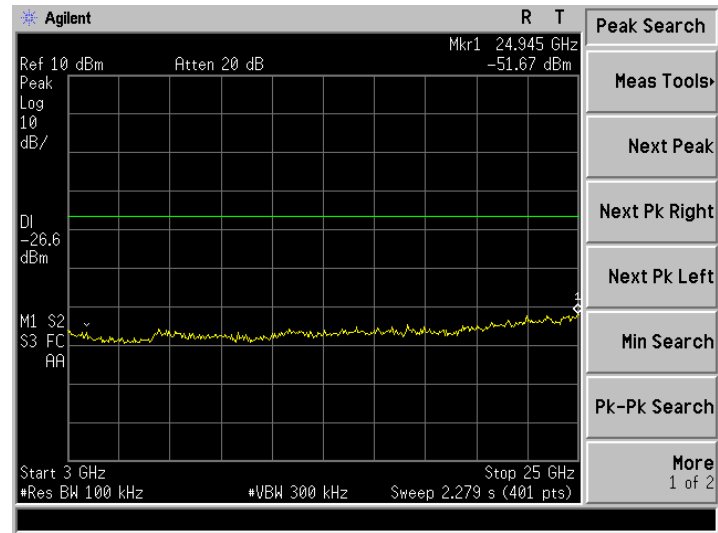
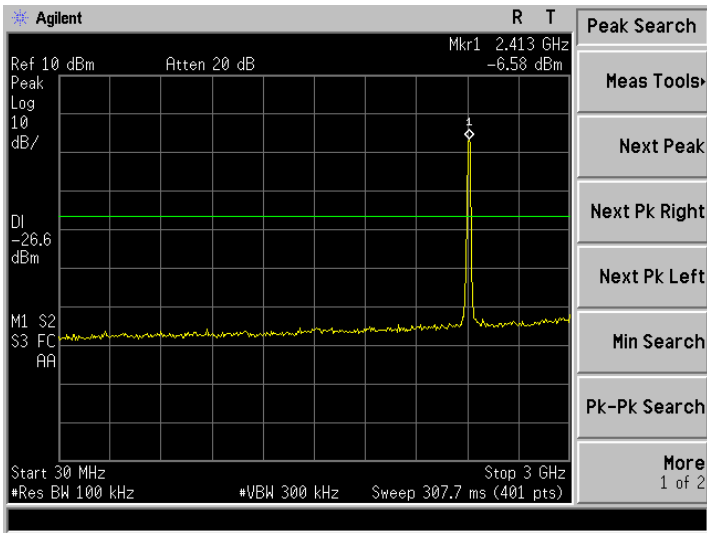

802.11n20 Middle Channel

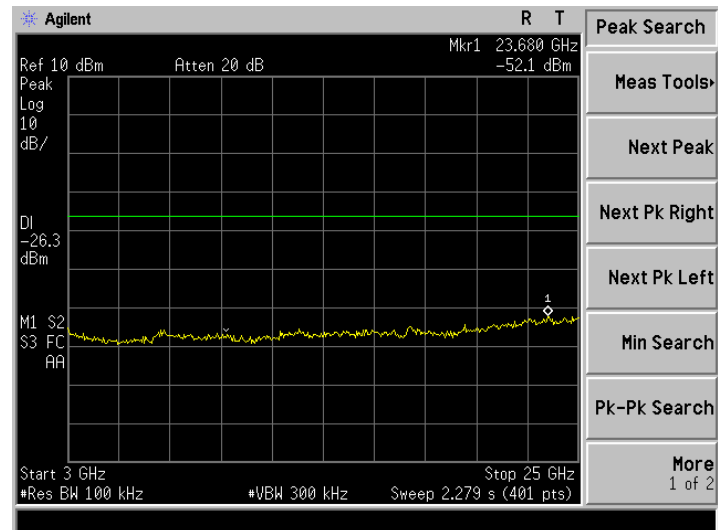
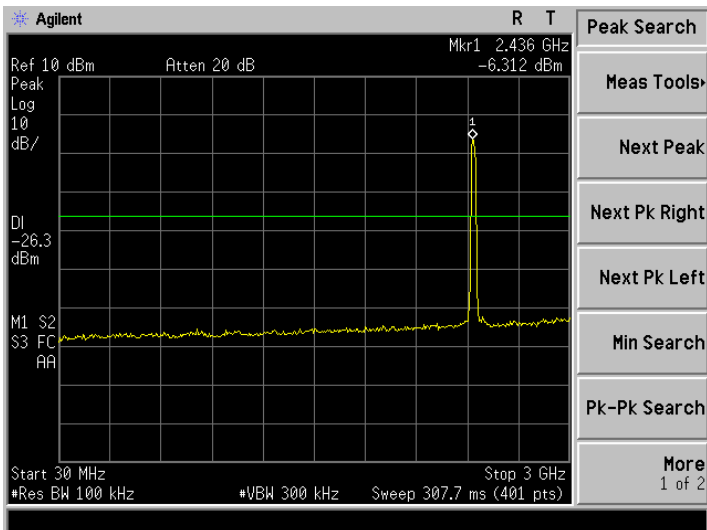



802.11n20 High Channel

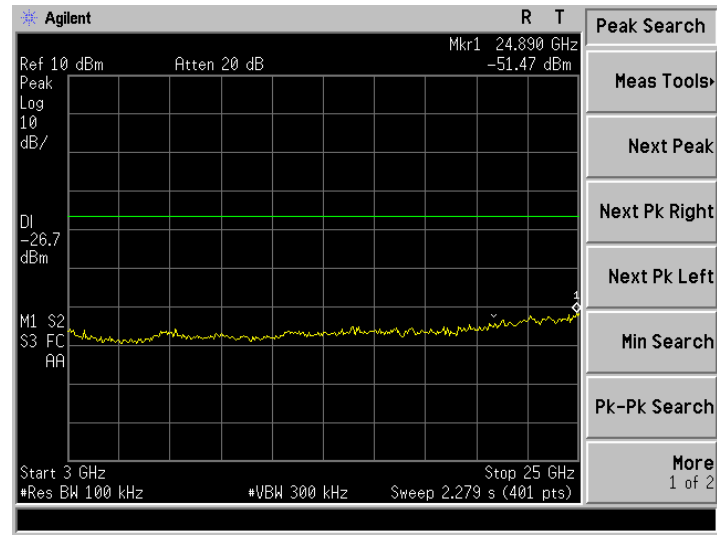
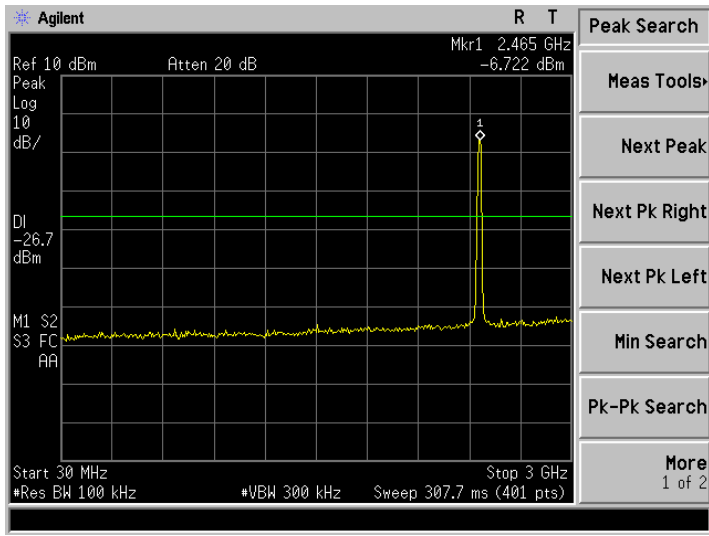

802.11n40 Low Channel

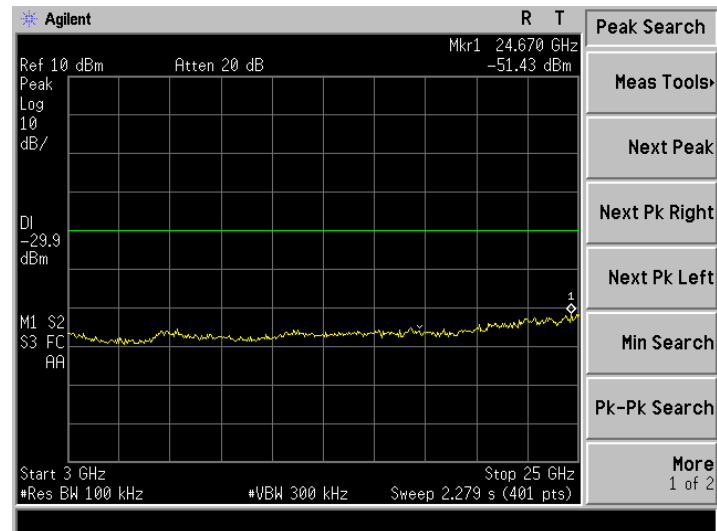
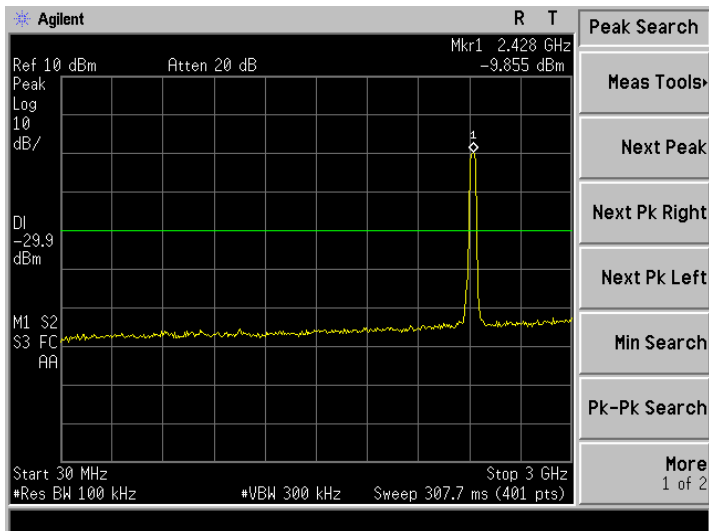



802.11n40 Middle Channel

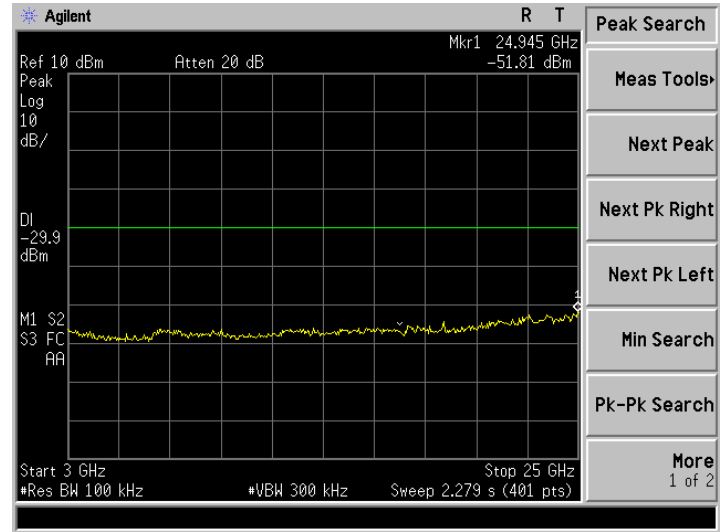
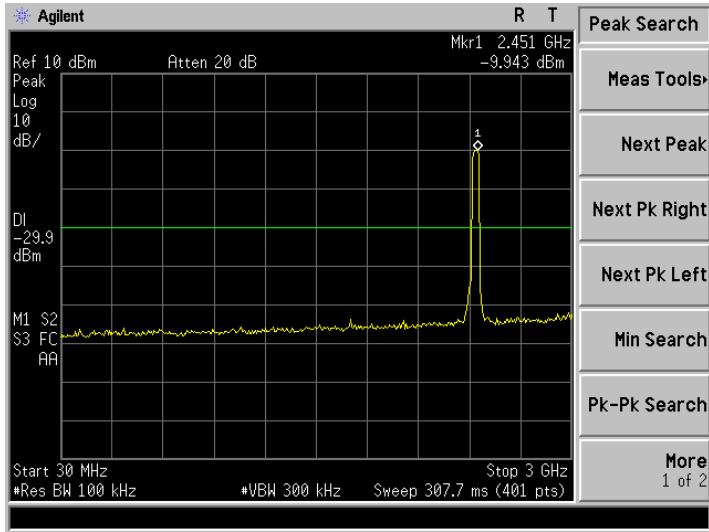

802.11n40 High Channel

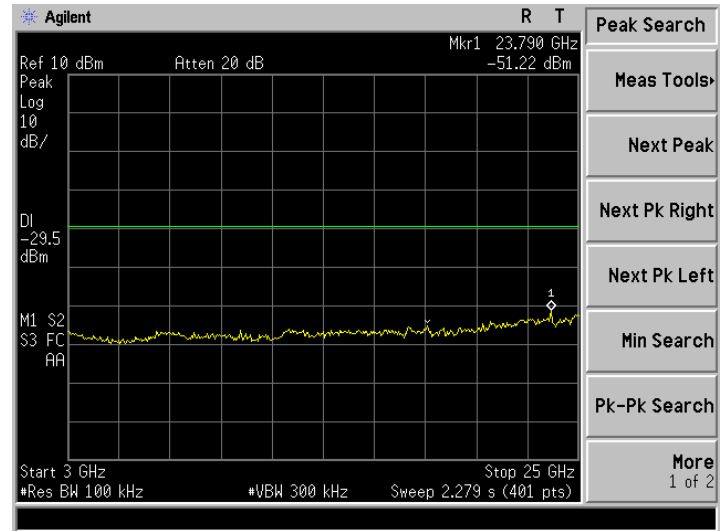
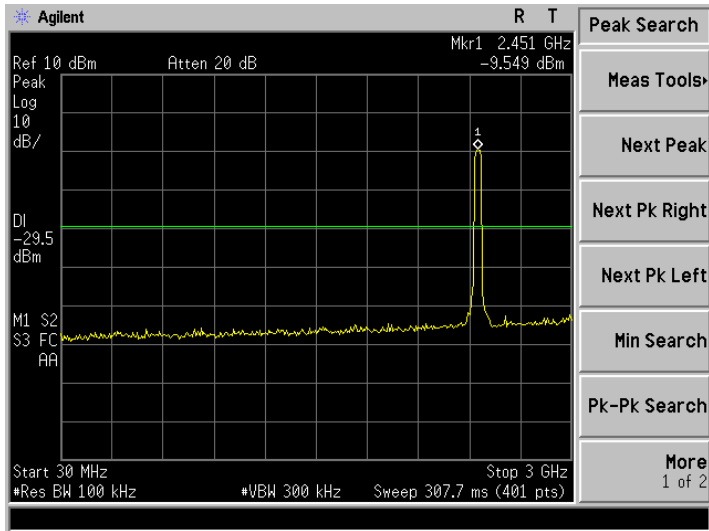



802.11b Transmitting Band edge-left side

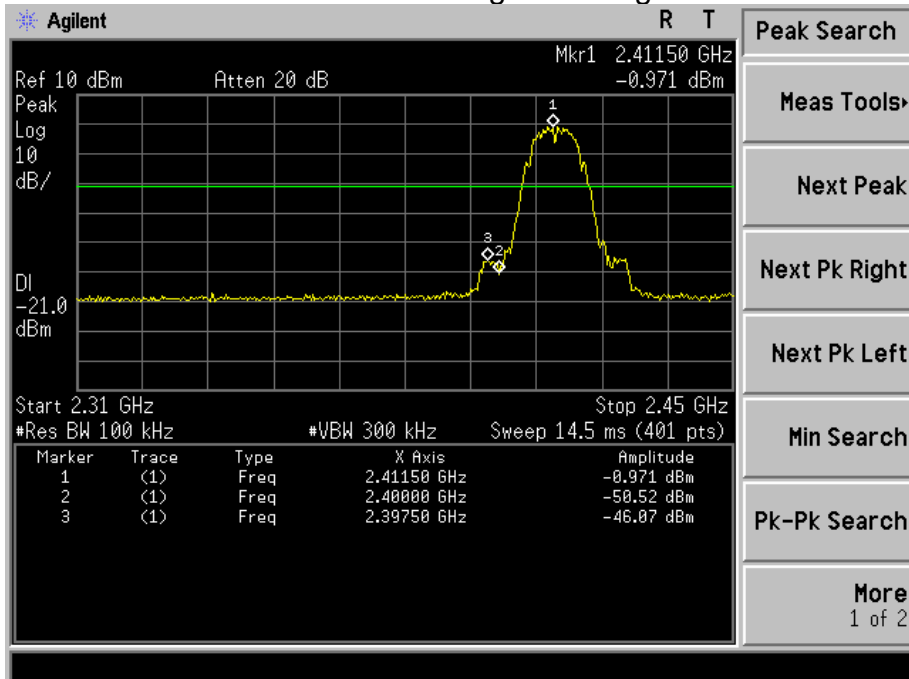

802.11b Transmitting Band edge-right side

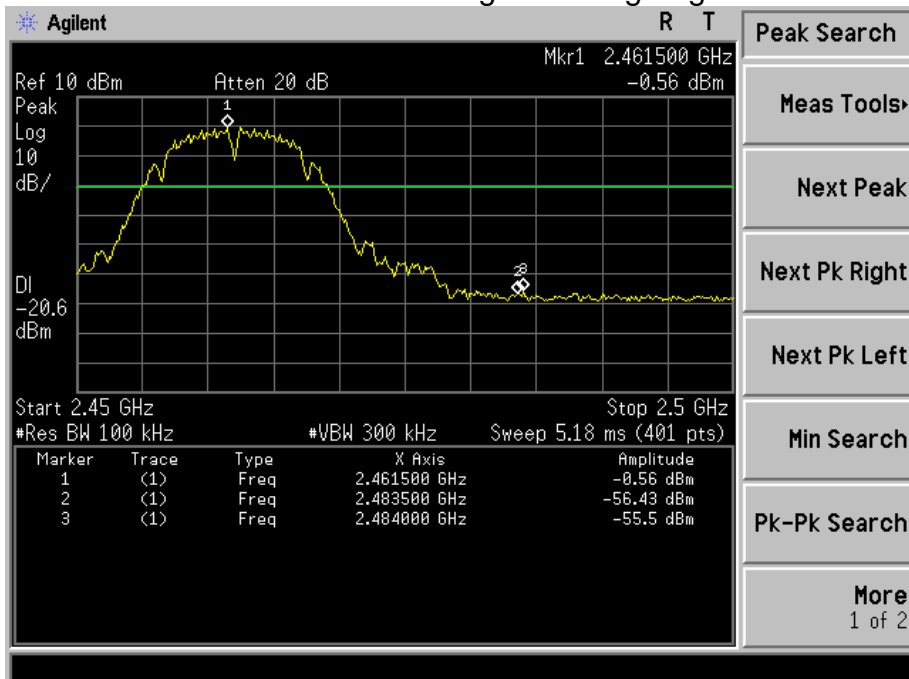



802.11g Transmitting Band edge-left side

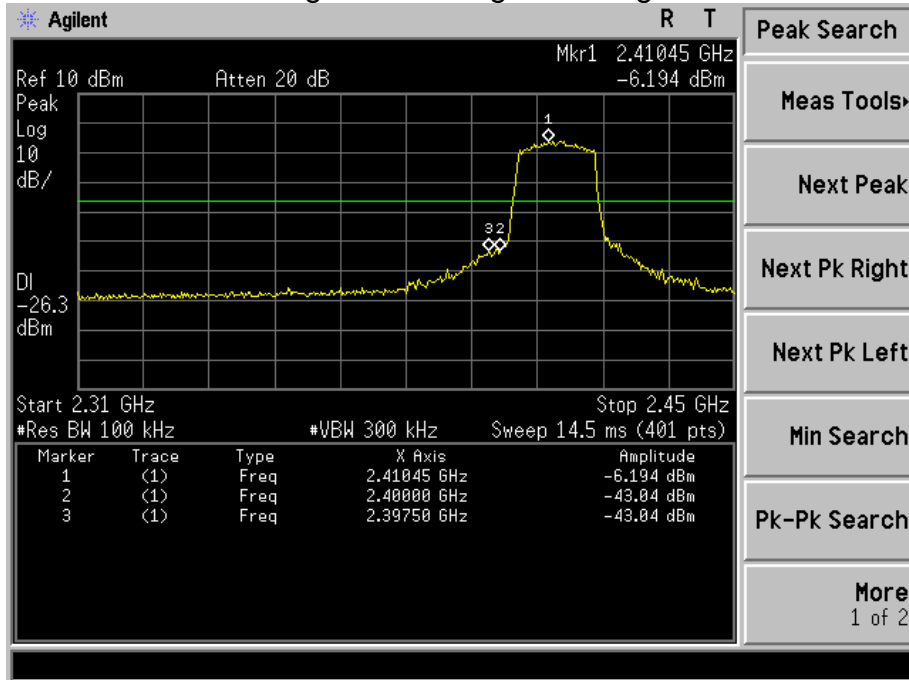

802.11g Transmitting Band edge-right side

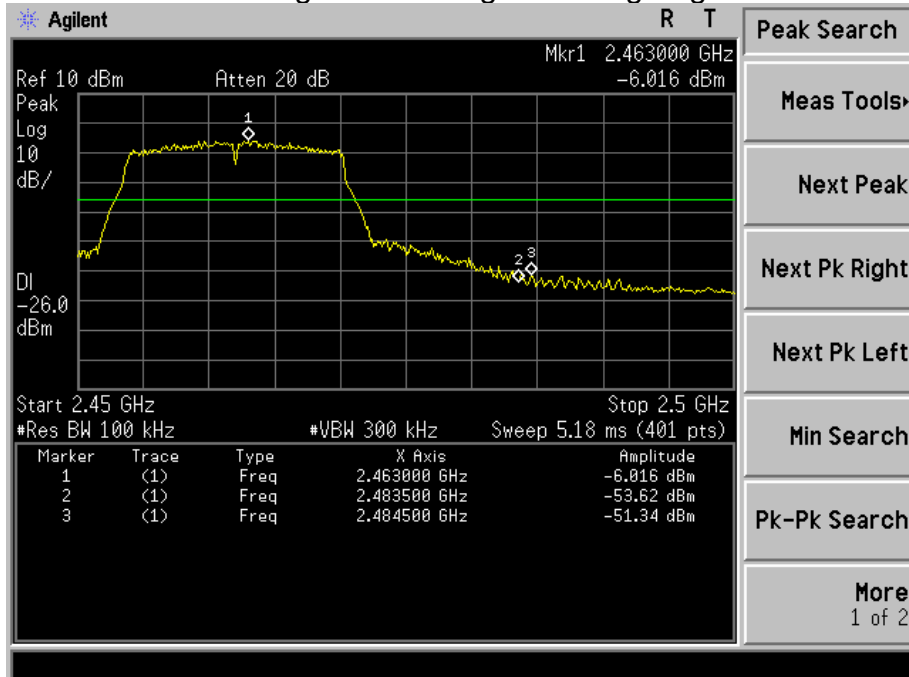



802.11n20 Transmitting Band edge-left side

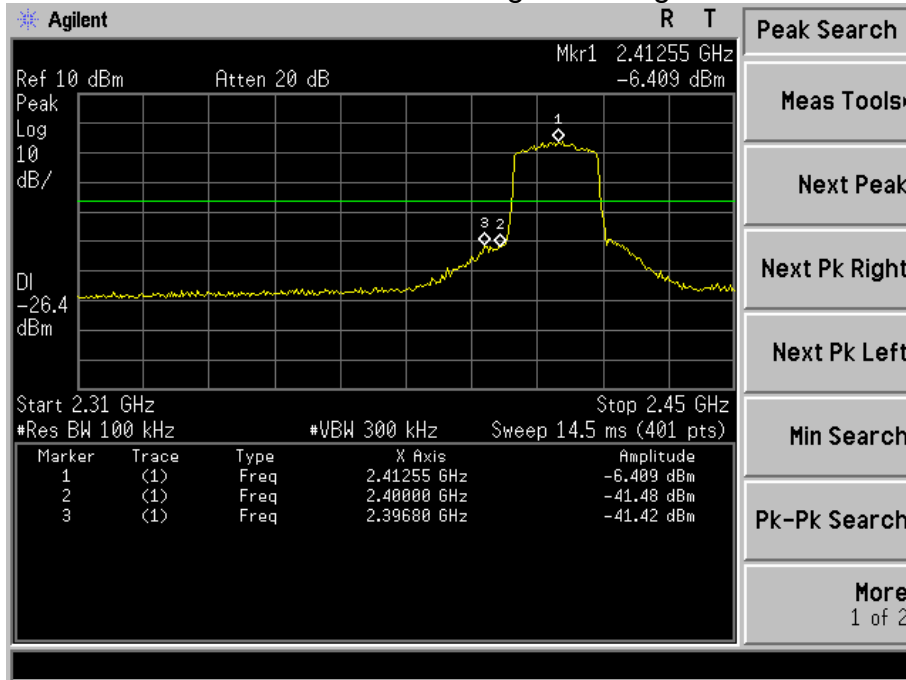

802.11n20 Transmitting Band edge-right side

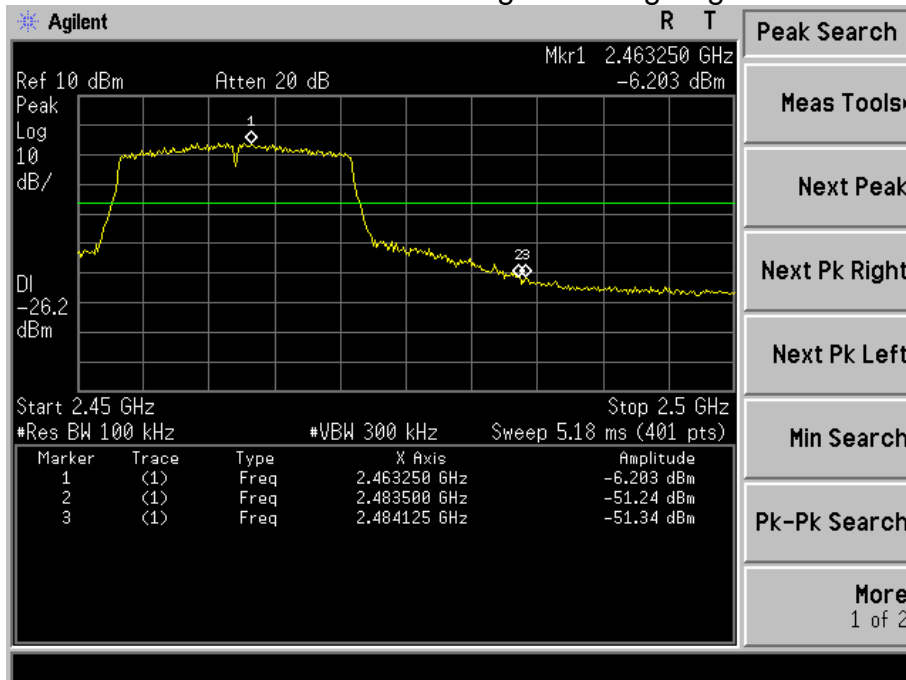



802.11n40 Transmitting Band edge-left side

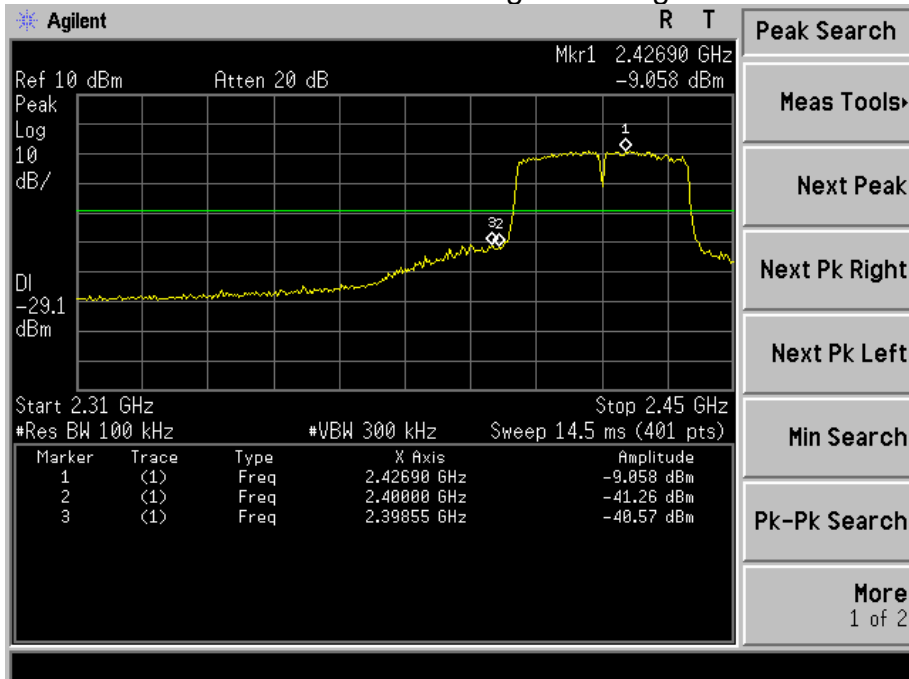

802.11n40 Transmitting Band edge-right side

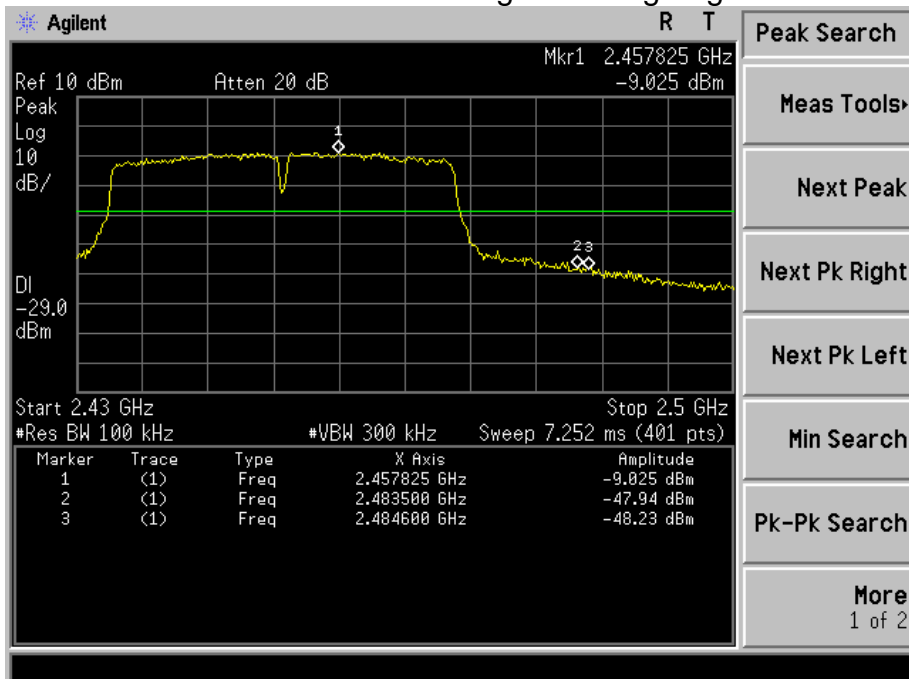

9. 6 DB BANDWIDTH

9.1 Block Diagram Of Test Setup

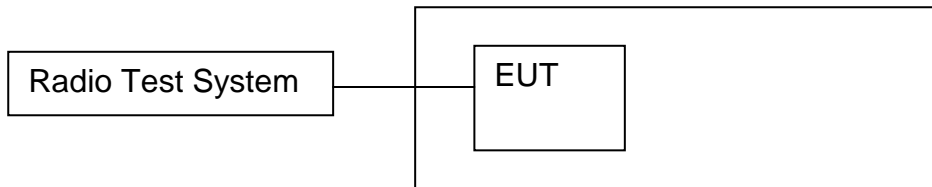

9.2 Limit

More than 500kHz

9.3 Test procedure

1. Set RBW = 100 kHz.
2. Set the video bandwidth (VBW) $\geq 3 \times$ RBW.
3. Detector = Peak.
4. Trace mode = max hold.
5. Sweep = auto couple.
6. Allow the trace to stabilize.
7. Measure the maximum width of the emission that is constrained by the frequencies associated with the two outermost amplitude points (upper and lower frequencies) that are attenuated by 6 dB relative to the maximum level measured in the fundamental emission.



9.4 Test Result

Modulation	Test Channel	6dB Bandwidth(MHz)
802.11b	Low	9.126
802.11b	Middle	9.117
802.11b	High	9.116
802.11g	Low	16.415
802.11g	Middle	16.408
802.11g	High	16.395
802.11n20	Low	17.619
802.11n20	Middle	17.631
802.11n20	High	17.620
802.11n40	Low	36.273
802.11n40	Middle	36.275
802.11n40	High	36.289

Test plots
802.11b Low Channel

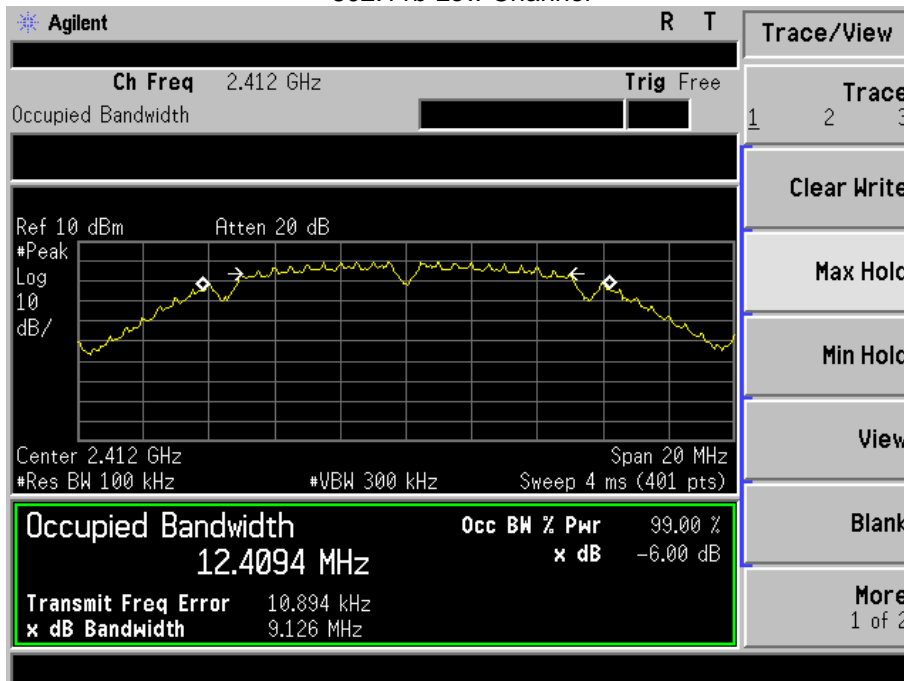



802.11b Middle Channel

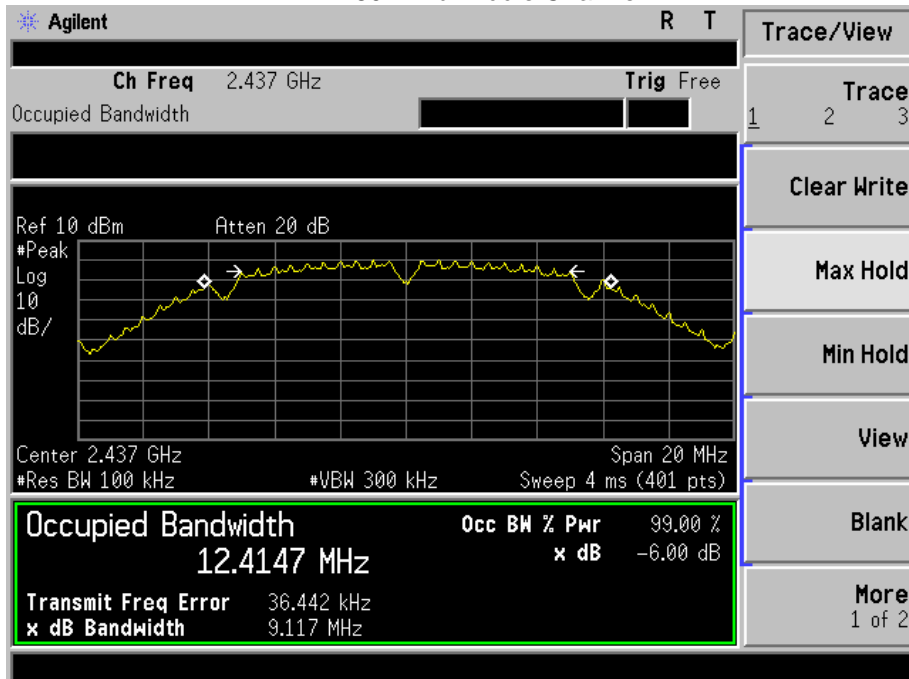

802.11b High Channel

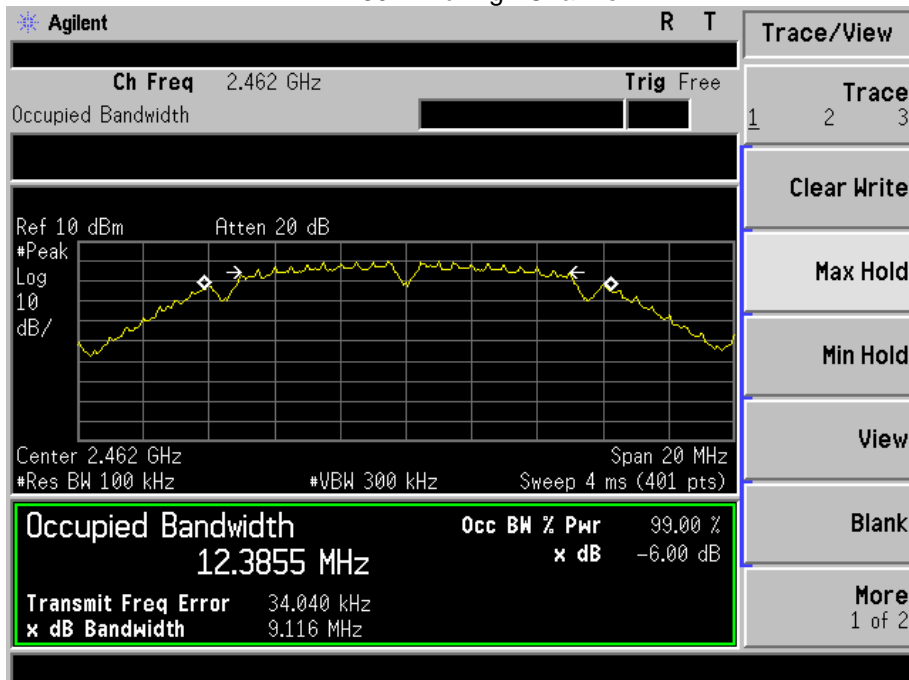



802.11g Low Channel

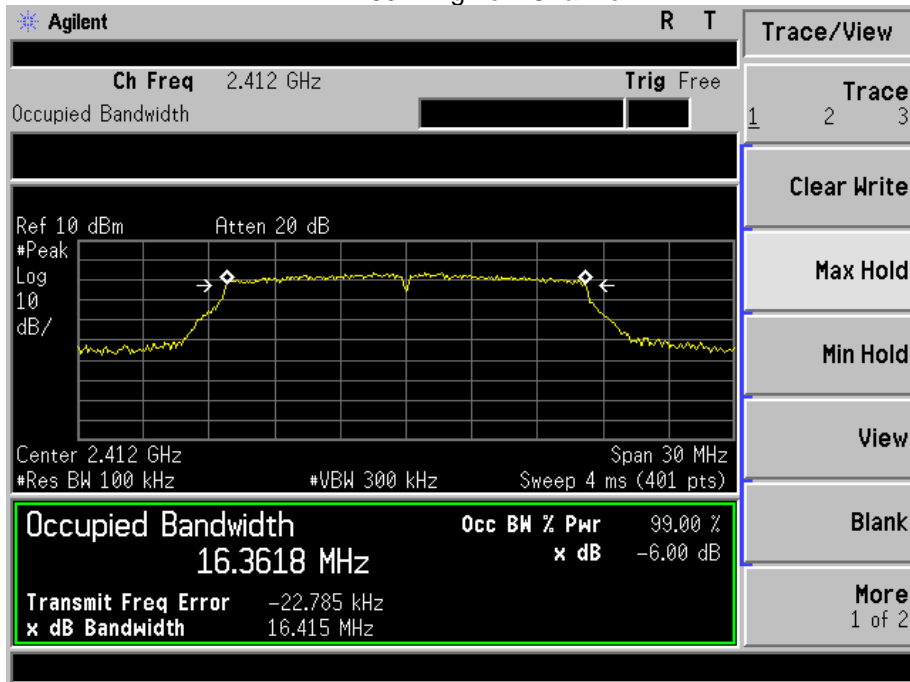

802.11g Middle Channel

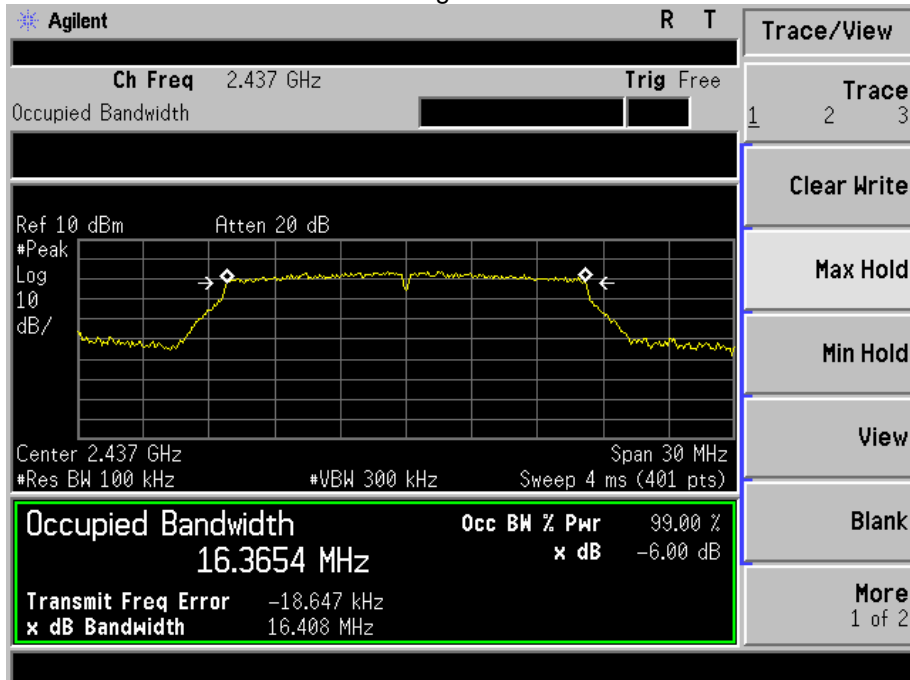



802.11g High Channel

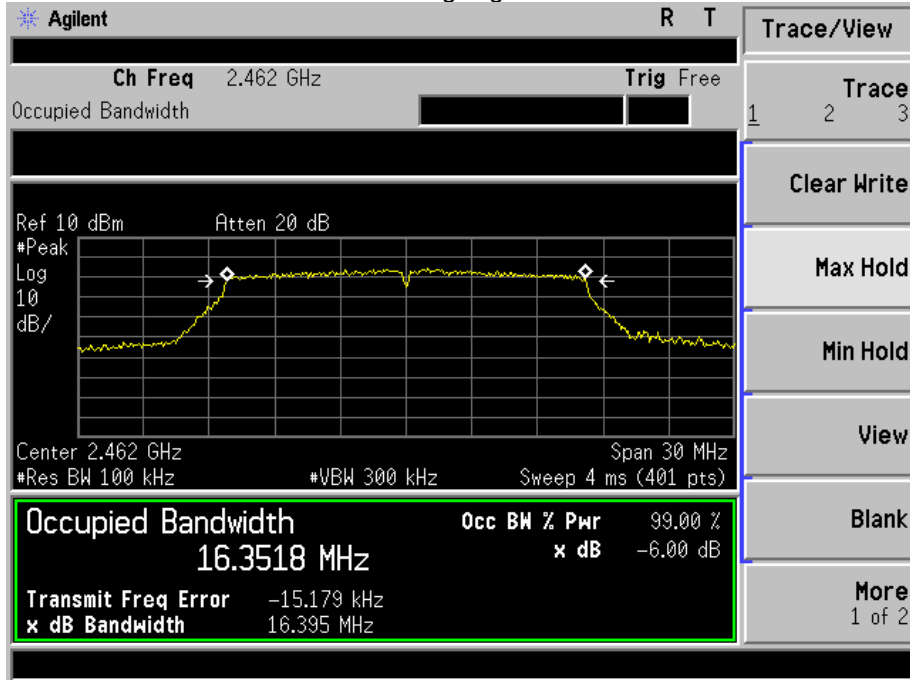

802.11n20 Low Channel

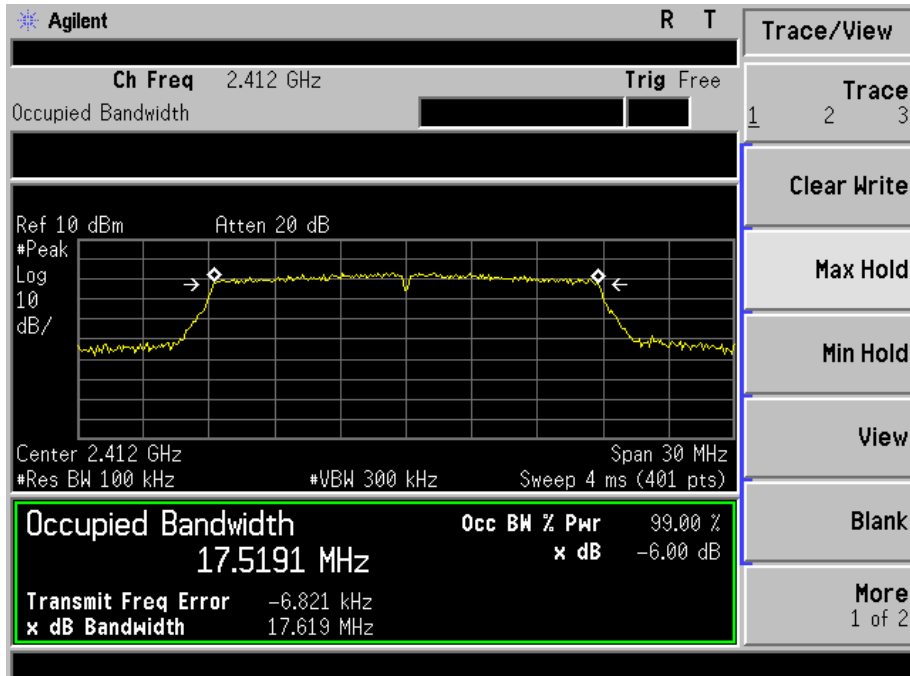



802.11n20 Middle Channel

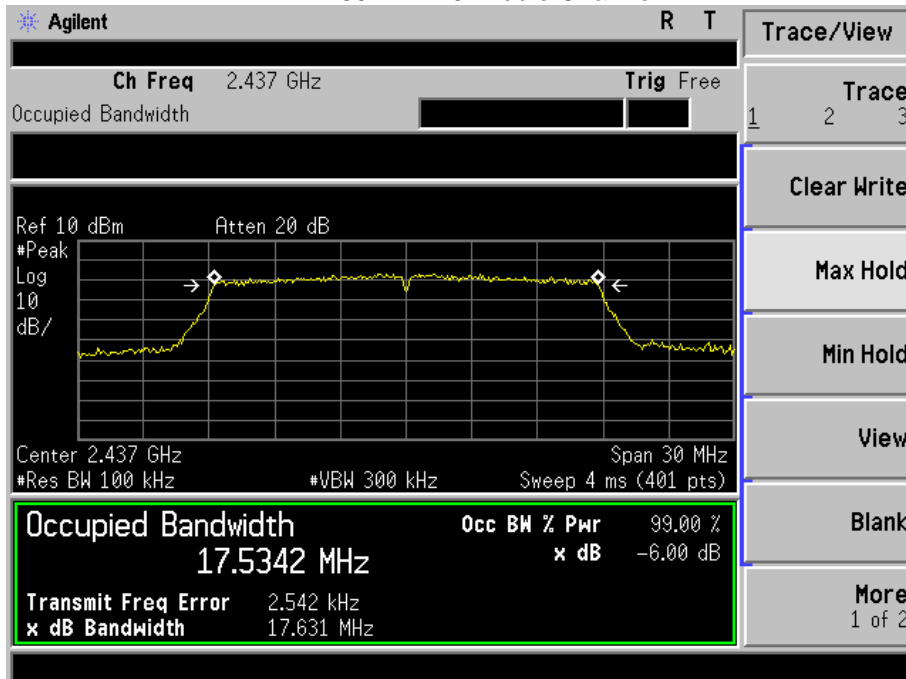

802.11n20 High Channel

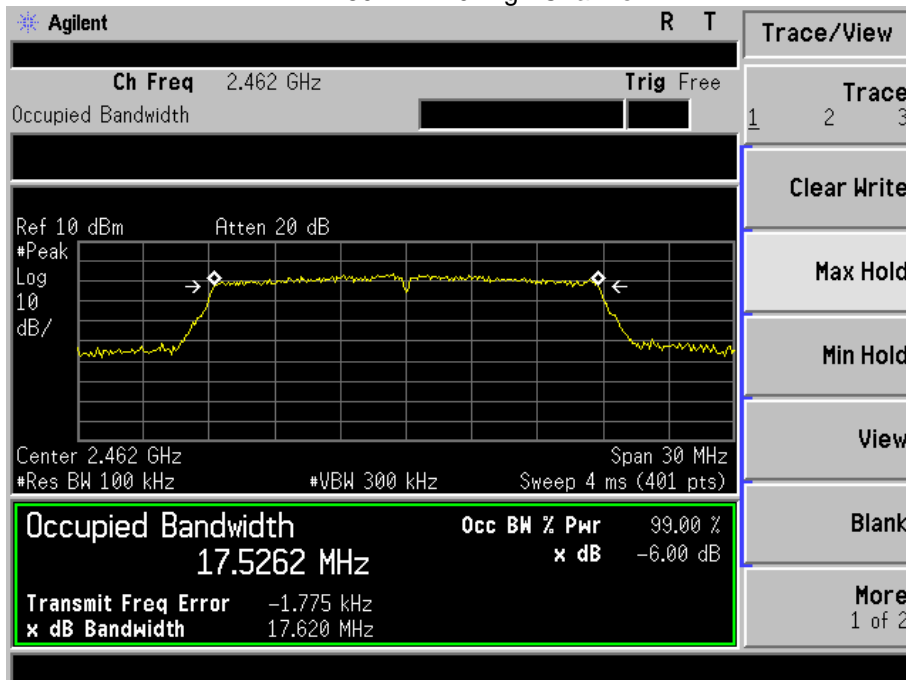



802.11n40 Low Channel

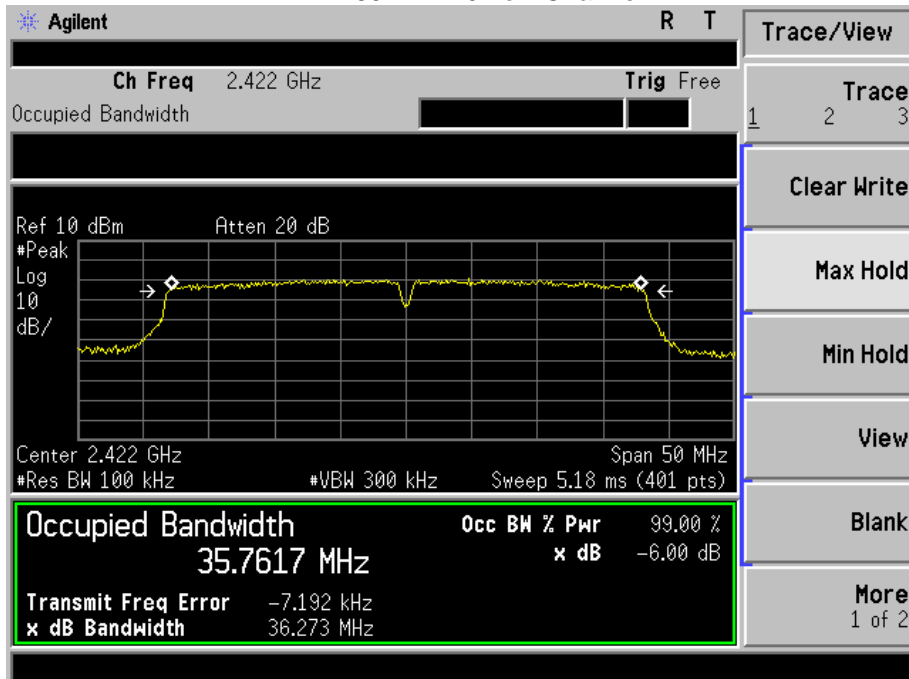

802.11n40 Middle Channel

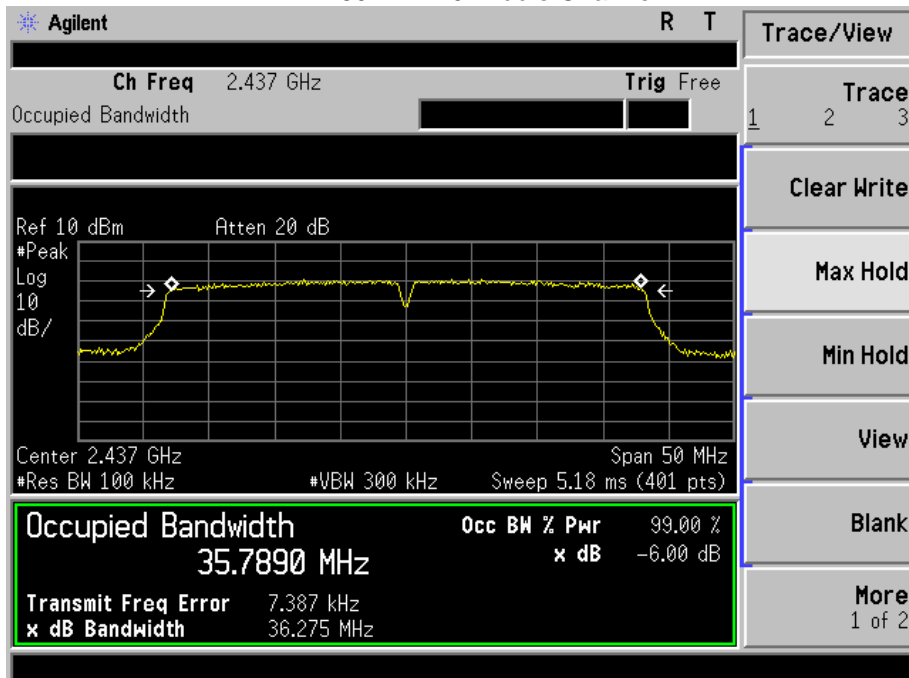



802.11n40 High Channel

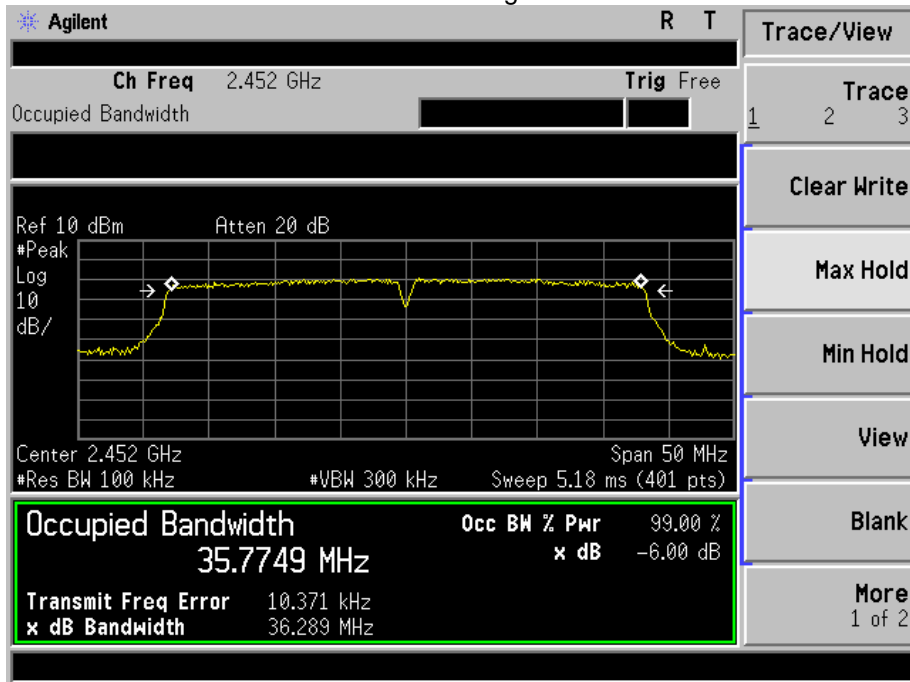

10. MAXIMUM PEAK OUTPUT POWER

10.1 Block Diagram Of Test Setup

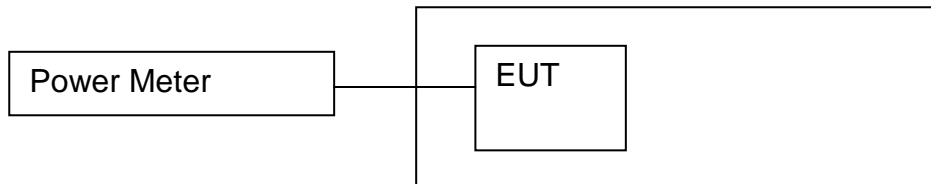

10.2 Limit

For systems using digital modulation in the 902-928 MHz, 2400-2483.5 MHz, and 5725-5850 MHz bands: 1 Watt.

10.3 Test procedure

1. Test procedures refer KDB 558074 D01 DTS Meas Guidance v04 section 9.2.3.2 Measurement using a power meter

(PM).

2. Alternatively, measurements may be performed using a wideband gated RF power meter provided that the gate parameters are adjusted such that the power is measured only when the EUT is transmitting at its maximum power control level. Since this measurement is made only during the ON time of the transmitter, no duty cycle correction is required.

3. Multiple antenna system was performed in accordance with KDB 662911 D01 v02r01 Emissions

Testing of Transmitters with Multiple Outputs in the Same Band.



10.4 Test Result

Operation mode	Channel Frequency (MHz)	Maximum Peak Output Power (dBm)	Limit
TX 11b	Low-2412	6.65	1W/30dBm
	Middle-2437	6.81	1W/30dBm
	High-2462	6.89	1W/30dBm
TX 11g	Low-2412	6.18	1W/30dBm
	Middle-2437	6.32	1W/30dBm
	High-2462	6.12	1W/30dBm
TX 11n HT20	Low-2412	5.39	1W/30dBm
	Middle-2437	5.26	1W/30dBm
	High-2462	5.33	1W/30dBm
TX 11n HT40	Low-2422	5.36	1W/30dBm
	Middle-2437	5.42	1W/30dBm
	High-2452	5.35	1W/30dBm

11. POWER SPECTRAL DENSITY

11.1 Block Diagram Of Test Setup

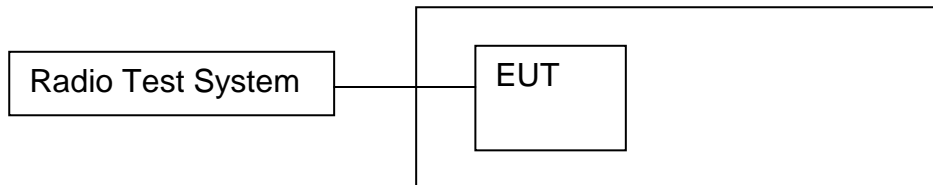

11.2 Limit

For digitally modulated systems, the power spectral density conducted from the intentional radiator to the antenna shall not be greater than 8 dBm in any 3 kHz band during any time interval of continuous transmission.

11.3 Test procedure

KDB 558074 D01 DTS Meas Guidance v04 section 10.2

1. Remove the antenna from the EUT and then connect a low RF cable from the antenna port to the spectrum.
2. Set the spectrum analyzer: RBW = 3kHz. VBW = 10kHz , Span = 1.5 times the DTS channel bandwidth(6 dB bandwidth). Sweep = auto; Detector Function = Peak. Trace = Max hold.
3. Allow the trace to stabilize. Use the marker-delta function to determine the separation between the peaks of the adjacent channels. The limit is specified in one of the subparagraphs of this Section Submit this plot.



11.4 Test Result

Operation mode	Channel Frequency (MHz)	Power Spectral (dBm per 3kHz)	Limit
TX 11b	Low-2412	-19.67	8dBm per 3kHz
	Middle-2437	-19.65	8dBm per 3kHz
	High-2462	-19.19	8dBm per 3kHz
TX 11g	Low-2412	-19.78	8dBm per 3kHz
	Middle-2437	-20.00	8dBm per 3kHz
	High-2462	-15.74	8dBm per 3kHz
TX 11n HT20	Low-2412	-19.83	8dBm per 3kHz
	Middle-2437	-19.86	8dBm per 3kHz
	High-2462	-15.92	8dBm per 3kHz
TX 11n HT40	Low-2422	-16.90	8dBm per 3kHz
	Middle-2437	-18.32	8dBm per 3kHz
	High-2452	-17.18	8dBm per 3kHz

Test Plot

Mode: TX 11b low channel

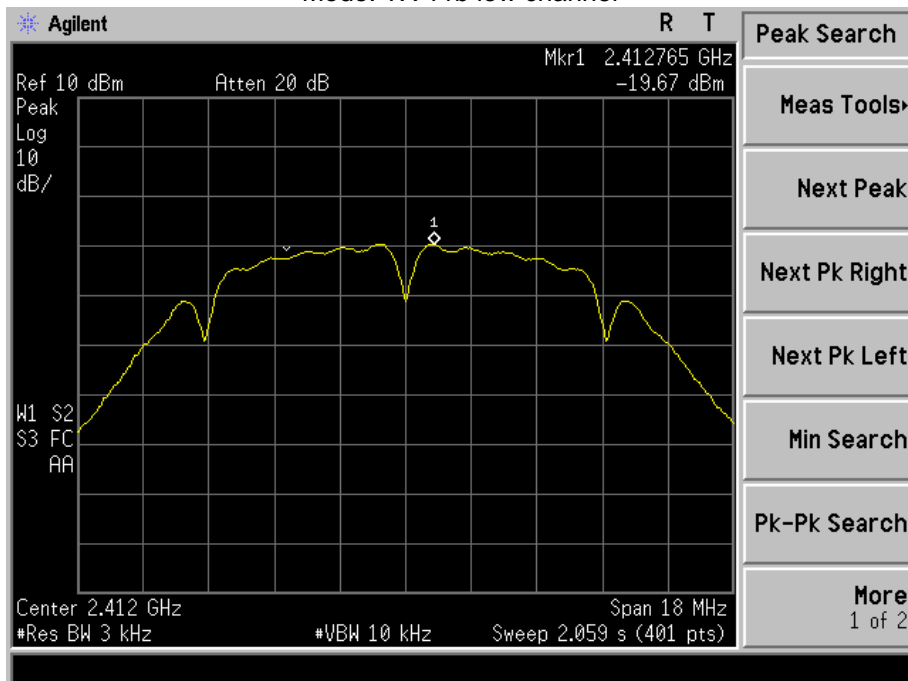



Mode: TX 11b middle channel

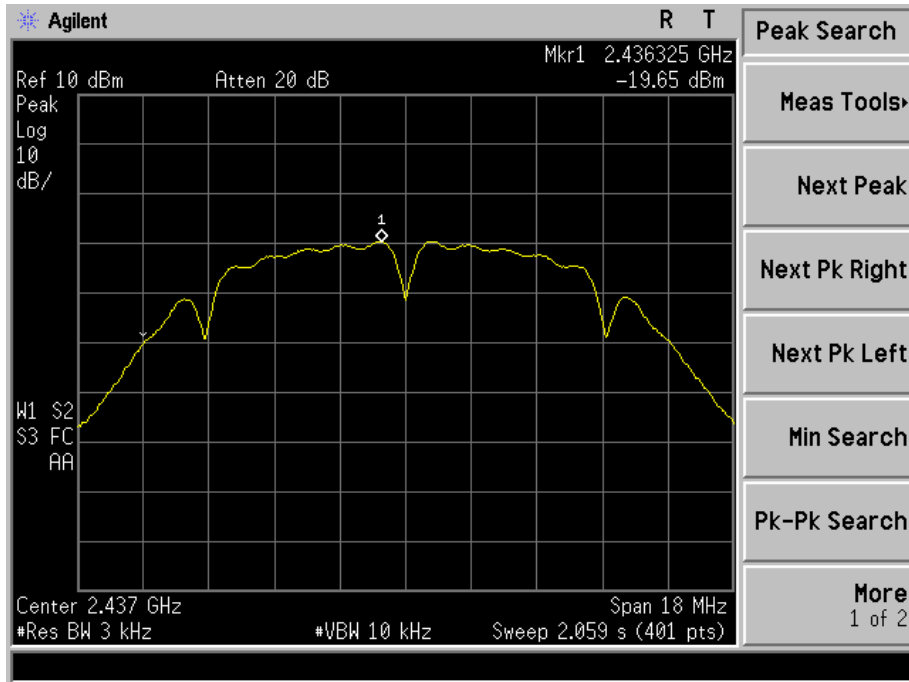

Mode: TX 11b high channel

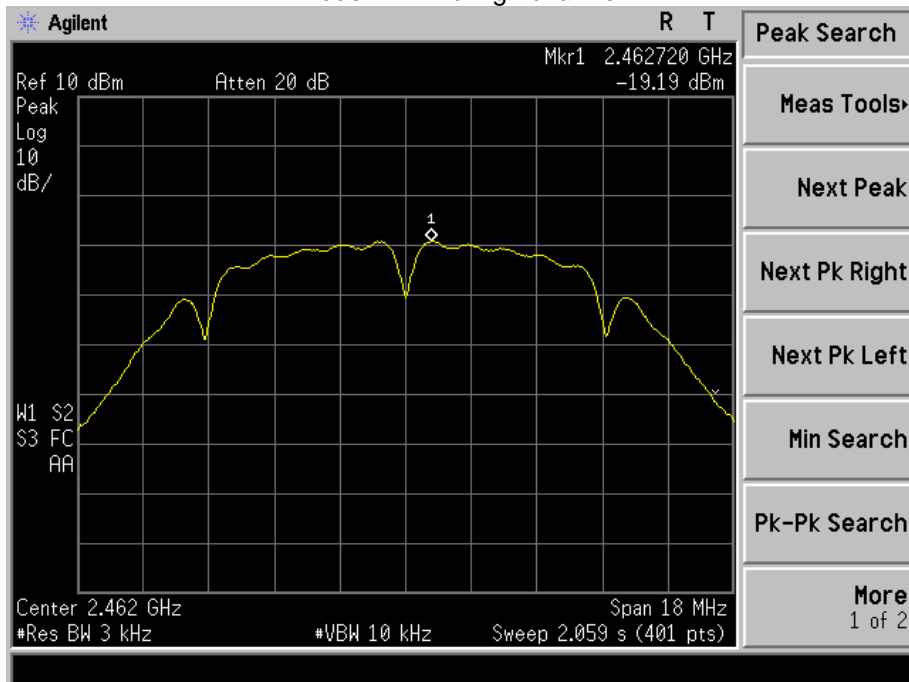



Mode :TX 11g low channel

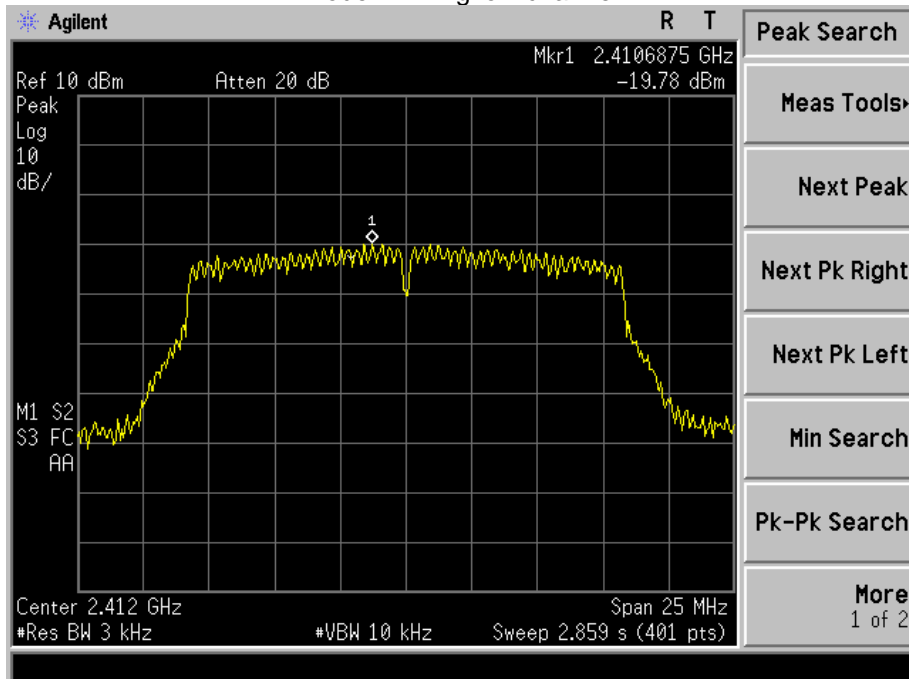

Mode :TX 11g middle channel

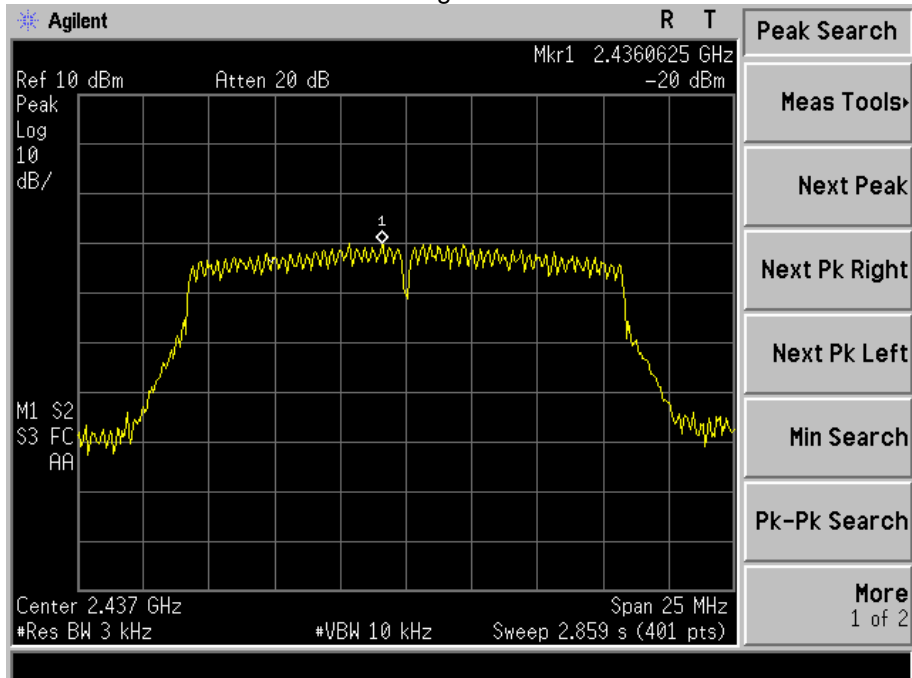



Mode :TX 11g high channel

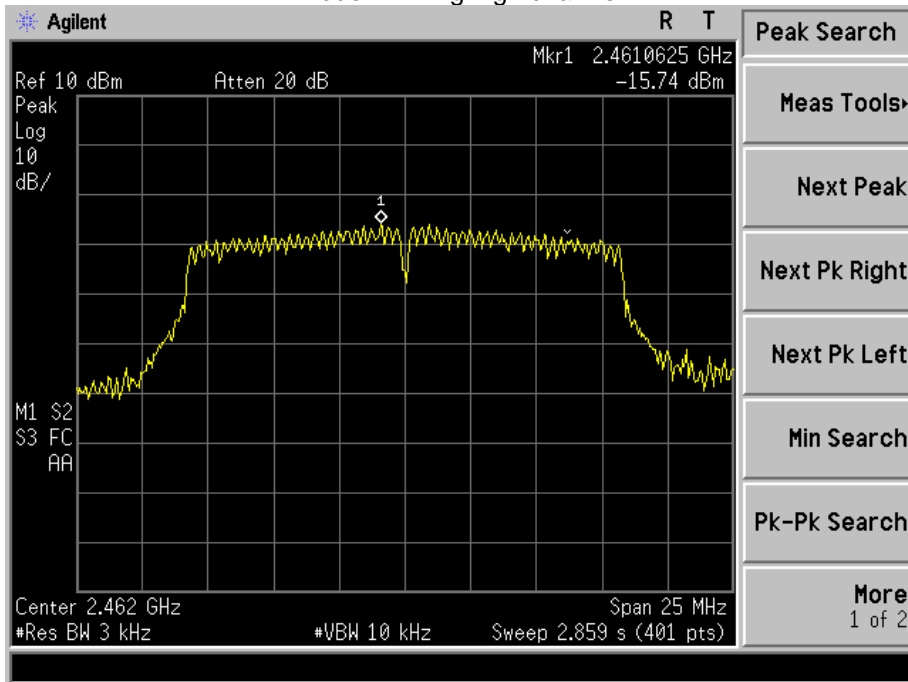

Mode: TX 11n HT20 low channel

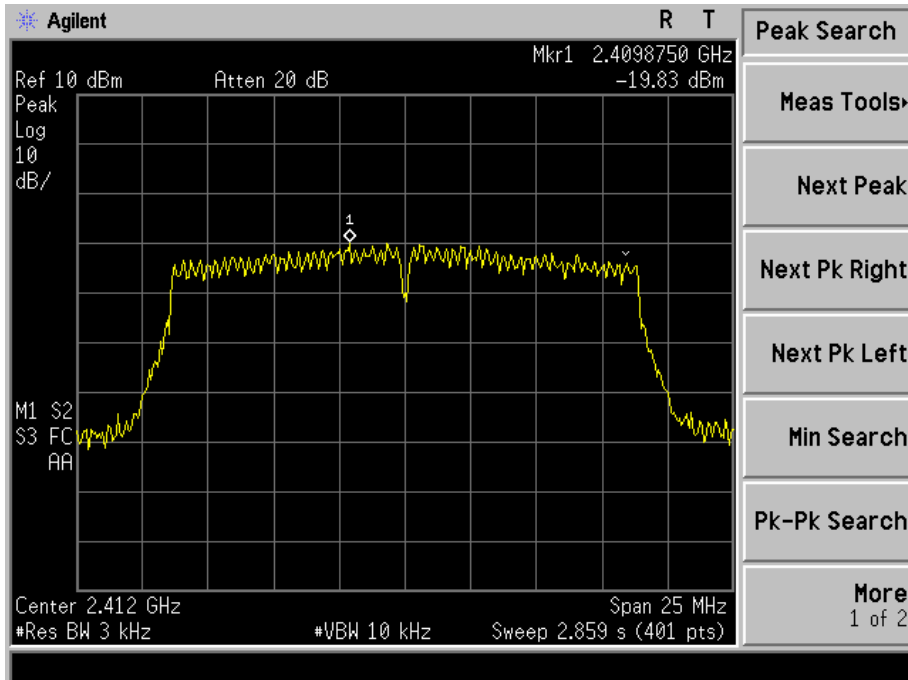



Mode: TX 11n HT20 middle channel

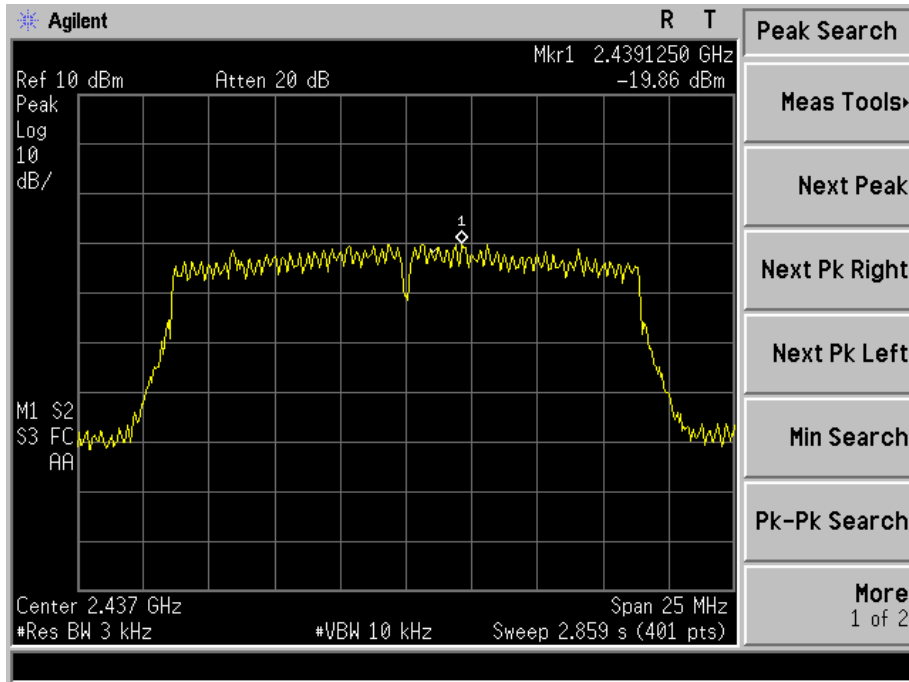

Mode: TX 11n HT20 high channel

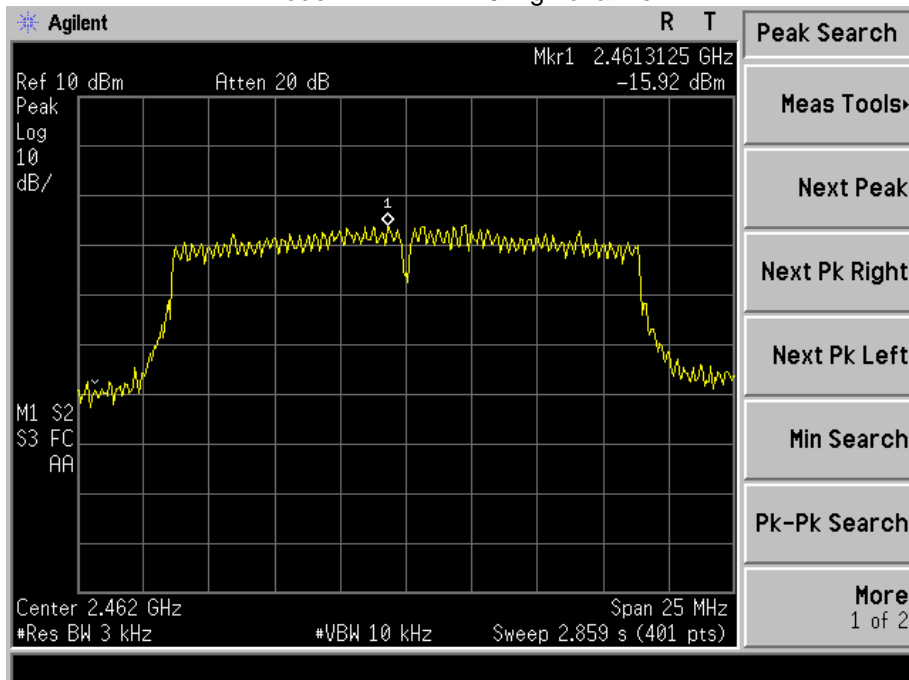



Mode: TX 11n HT40 low channel

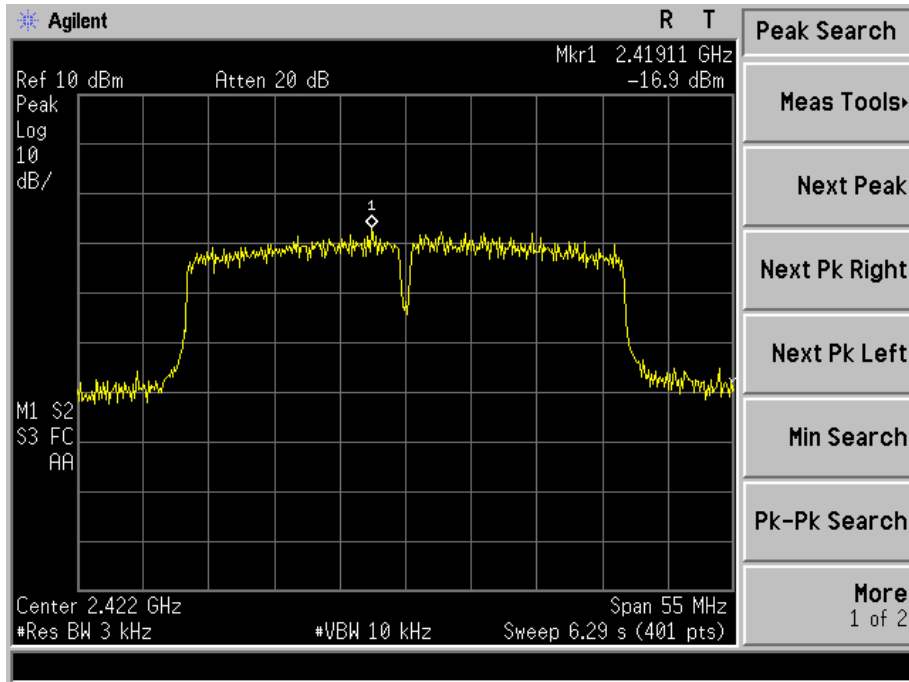

Mode: TX 11n HT40 middle channel

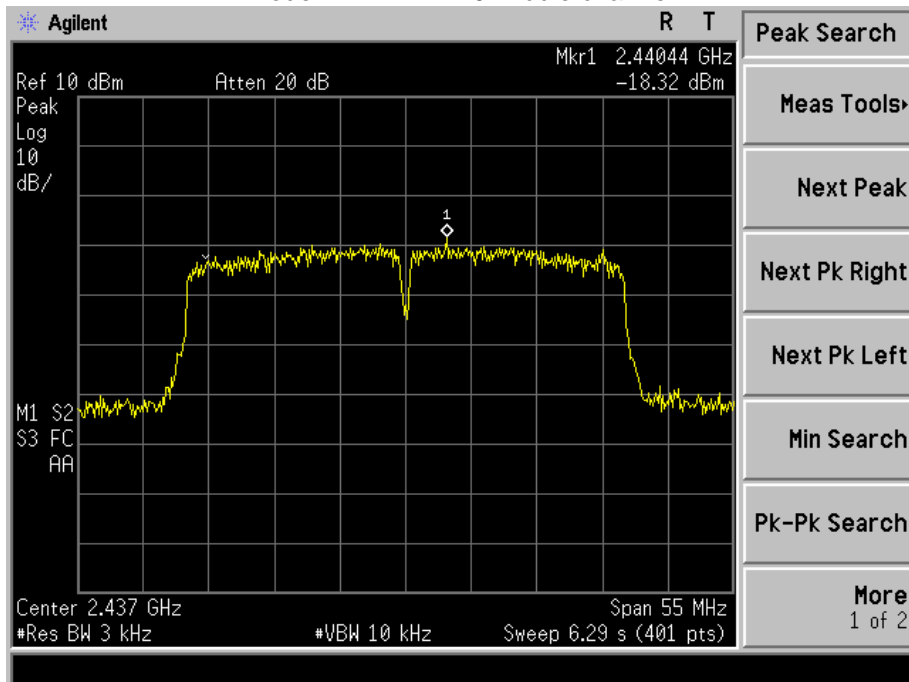

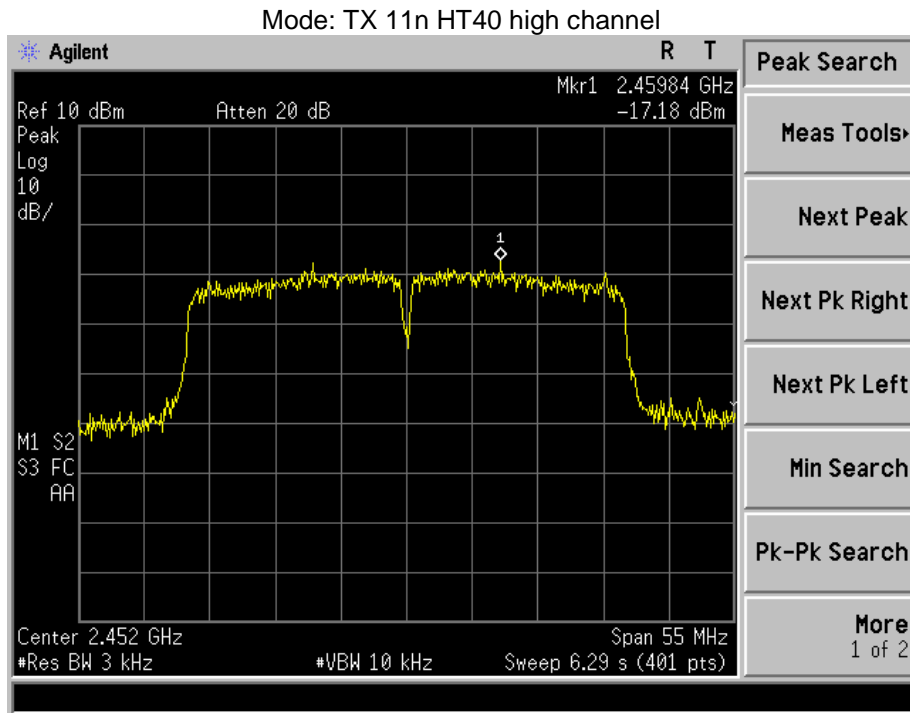



12. ANTENNA REQUIREMENT

An intentional radiator shall be designed to ensure that no antenna other than that furnished by the responsible party shall be used with the device. The use of a permanently attached antenna or of an antenna that uses a unique coupling to the intentional radiator shall be considered sufficient to comply with the provisions of this section. The manufacturer may design the unit so that a broken antenna can be replaced by the user, but the use of a standard antenna jack or electrical connector is prohibited. This requirement does not apply to carrier current devices or to devices operated under the provisions of §15.211, §15.213, §15.217, §15.219, or §15.221. Further, this requirement does not apply to intentional radiators that must be professionally installed, such as perimeter protection systems and some field disturbance sensors, or to other intentional radiators which, in accordance with §15.31(d), must be measured at the installation site. However, the installer shall be responsible for ensuring that the proper antenna is employed so that the limits in this part are not exceeded.

For intentional device, according to FCC 47 CFR Section 15.203, an intentional radiator shall be designed to ensure that no antenna other than that furnished by the responsible party shall be used with the device.

The EUT has a FPCB antenna, meets the requirements of FCC 15.203.

13. EUT PHOTOGRAPHS

EUT Photo 1



EUT Photo 2



EUT Photo 3



EUT Photo 4





EUT Photo 5



14. EUT TEST SETUP PHOTOGRAPHS

Spurious emissions

Below 1GHz

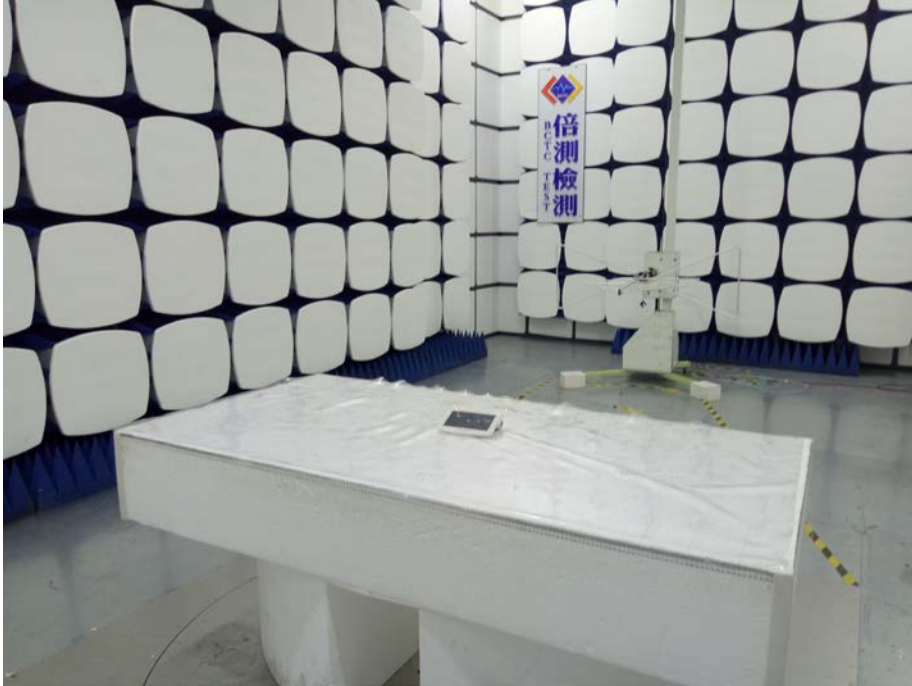

Above 1GHz

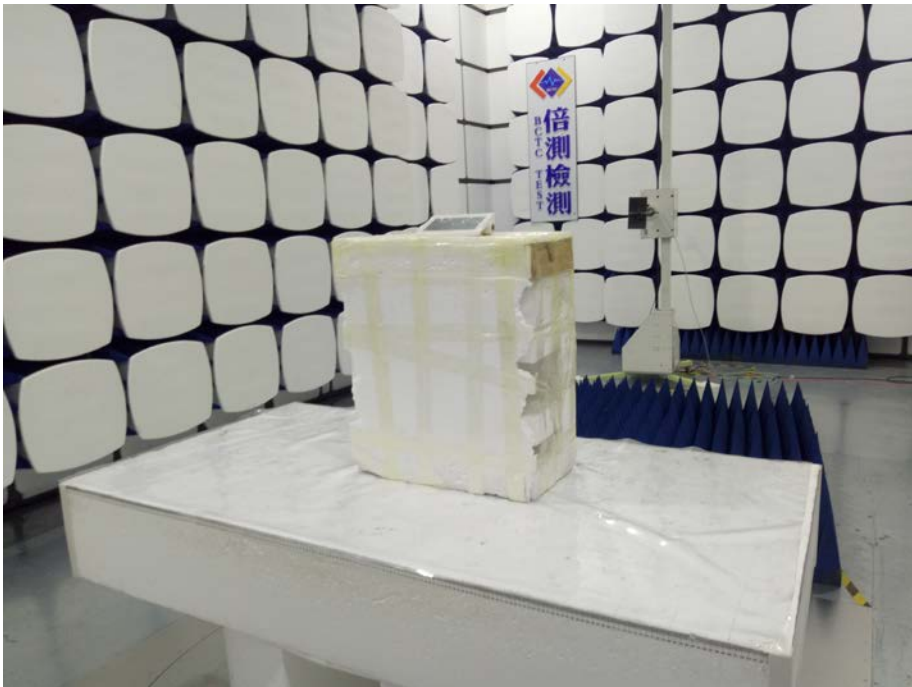

***** END OF REPORT *****