

# Automatic Induction Fast Wireless Car Charger

## Instructions

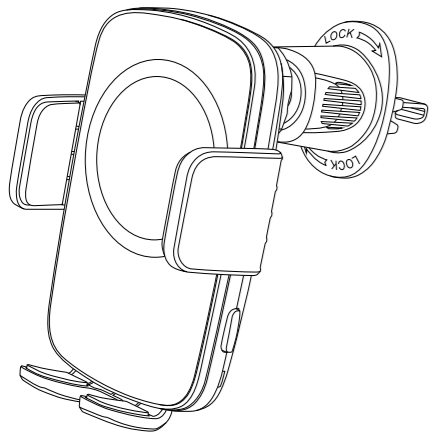

Please read the instructions carefully before using. Pictures are for reference only. Specifications are subject to the physical product

### What is included:

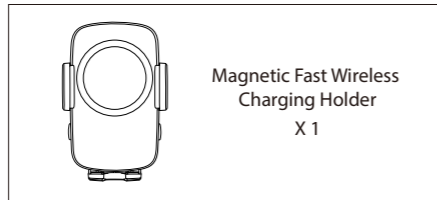

Magnetic Fast Wireless Charging Holder X 1



Air vent mount X 1

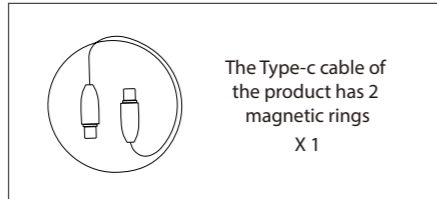

The Type-c cable of the product has 2 magnetic rings X 1

### Features:

- Car holder with wireless charging function, charges your phone conveniently when driving.
- Power output 5W/7.5W/10W/15W, compatible with all phones with Qi standard.
- Full 360 degrees rotation for perfect viewing angle.
- Start charging once as the phone contact with the holder, no need plug cable in the phone.
- Adjustable foot support makes easy to align to the charging center.

### Parameters:

#### Air Vent Mount

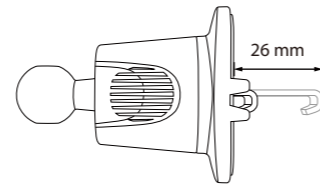

### Parameters:

#### Wireless Charging Holder

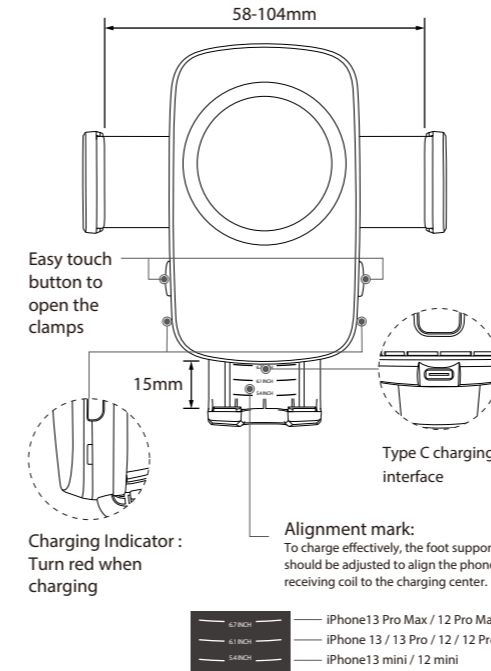

Easy touch button to open the clamps

Alignment mark:  
To charge effectively, the foot support should be adjusted to align the phone receiving coil to the charging center.

- iPhone13 Pro Max / 12 Pro Max
- iPhone 13 / 13 Pro / 12 / 12 Pro
- iPhone13 mini / 12 mini

### Product specification:

Wireless Charging Holder	
Input voltage	5V/9V/12V / Over voltage protection
Input current	2A / Over current protection
Output power	5W / 7.5W / 10W / 15W (Max)
Frequency	115-148KHZ
Efficiency	10W/83% 15W/82.6%
Induction Distance:	4mm (Max)
Open / Close holder arms:	Coil Induction or press button
Compatible with Fast Wireless Charging Mode:	Support Qi / Apple Iphone 7.5W / HUAWEI / SAMSUNG 10W / LG / SONY / GOOGLE / XIAOMI wireless charging
FCC ID	2APCQ-TAC-138

### LED Mode:

Working state	LED light color
Power transfer	Red, blue, red blue light flash once, then off
Standby mode	Light off
Charging	Red light keeps on
FOD Warning	Red light keeps flashing
Charge complete	Red light keeps on

### Compatible devices:

- Work well with all Qi enabled devices including: iPhone 13, iPhone13 Pro Max, iPhone13 Pro, iPhone13 mini, iPhone 12, iPhone12 Pro Max, iPhone12 Pro, iPhone12 mini, Samsung Note 8, Note 9, iPhone XS MAS, Huawei P30 Pro, MIUI9, Samsung S10+, iPhone 8Plus, Samsung S9+, Samsung S8+, iPhone XR, Samsung S10, Samsung S7edge, Samsung S8, iPhone XS, iPhone X, Samsung S9, iPhone 8, iPhone 11, iPhone SE, Samsung S22, Samsung S21, Samsung S20
- Qi disabled devices with wireless receiver or wireless charging case.  
(Require receiver compliant with WPC Qi standard to match).

### Install instructions:

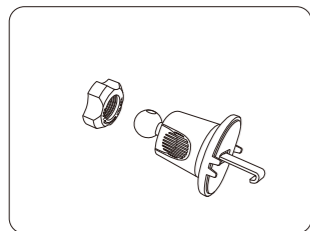

1. Insert the adjuster into the ball joint adapter.

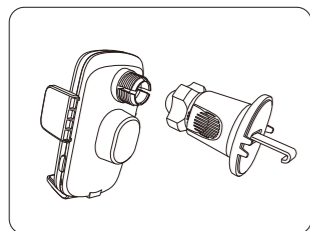

2. Insert the ball into the socket at the back of the bracket, turn the adjuster to tighten.

### Install instructions:

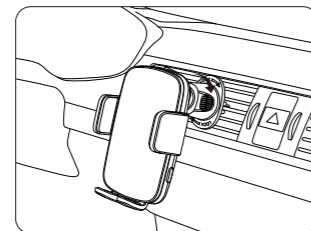

3. Insert the hook into the car air outlet vane and tighten to lock. When you hear 'clatter' sounds, it means the mount has been fixed tightly.

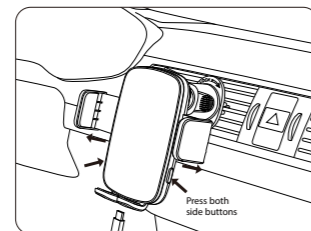

4. Connect the charging cable to the charging interface, after power is on, the clamp arms will open automatically, the clamp arm can also be opened by pressing the button on both sides.

### Install instructions:

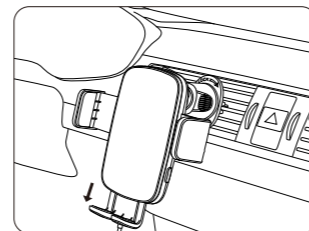

5. Extend the foot support according to your phone size, to align the charging center of your smartphone.

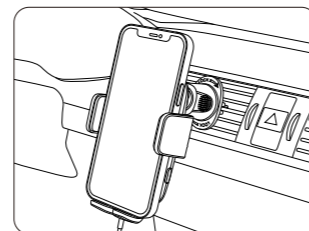

6. Place your device into the bracket, clamping arms of bracket will closed automatically when it inducts receiver coil of your device.

### Attentions:

1. Please use the product correctly according instructions.
2. Please do not disassemble the product or throw it to fire and water, to avoid leakage that caused by electrical short circuit.
3. Please do not use wireless charger in high temperature, wet, corrosive environment, to avoid leakage that caused by damaged circuit.
4. Please do not put wireless charger close to cards with magnetic stripes or chips (ID card, credit card etc.) to avoid demagnetization
5. Please keep wireless charger at least 20 CM distance away from implantable medical device (heart pacemaker, Implantable cochlea etc.) to avoid potential interferences.
6. Please do safekeeping, do not let your kids treat wireless charger as toy to avoid unwanted accidents.

The pictures only supplies the reference, please take the actual product as the standard.

### FCC Statement:

FCC ID: 2APCQ-TAC-138

FCC WARNING: This device complies with part 15 of the FCC Rules. Operation is subject to the following two conditions: (1) this device may not cause harmful interference, and (2) this device must accept any interference received, including interference that may cause undesired operation.

Any changes or modifications not expressly approved by the party responsible for compliance could void the user's authority to operate the equipment.

NOTE: This equipment has been tested and found to comply with the limits for a Class B digital device, pursuant to Part 15 of the FCC Rules. These limits are designed to provide reasonable protection against harmful interference in a residential installation. This equipment generates, uses and can radiate radio frequency energy and, if not installed and used in accordance with the instructions, may cause harmful interference to radio communications. However, there is no guarantee that interference will not occur in a particular installation.

If this equipment does cause harmful interference to radio or television reception, which can be determined by turning the equipment off and on, the user is encouraged to try to correct the interference by one or more of the following measures:

### FCC Statement:

- Reorient or relocate the receiving antenna.
- Increase the separation between the equipment and receiver.
- Connect the equipment into an outlet on a circuit different from that to which the receiver is connected.
- Consult the dealer or an experienced radio/TV technician for help.

FCC RF exposure statement:  
The equipment complies with FCC radiation exposure limits set forth for an uncontrolled environment. This equipment should be installed and operated with minimum distance between 20cm the radiator your body.