

Test Report

FCC ID:2APCQ-TAC-106A

Date of issue: July 28, 2020

Report number: MTi20062406-4E1

Sample description: Infrared Sensor Wireless Charge Holder

Model(s): TAC-106A, YT-701

Applicant: DONGGUAN CHUANGLONG ELECTRONICS LIMITED

Address: King Long industrial district, xiekeng village, qingxi town,
Dongguan city, Guangdong China

Date of test: June 30, 2020 - July 25, 2020

Shenzhen Microtest Co., Ltd.
<http://www.mtitest.com>

This test report is valid for the tested samples only. It cannot be reproduced except in full without prior written consent of Shenzhen Microtest Co., Ltd.



Table of Contents

1	GENERAL INFORMATION	4
1.1	FEATURE OF EQUIPMENT UNDER TEST (EUT).....	4
1.2	TEST MODE	4
1.3	EUT TEST SETUP.....	5
1.4	ANCILLARY EQUIPMENT	5
2	SUMMARY OF TEST RESULT	6
2.1	OPERATION CHANNEL LIST	6
2.2	TEST CHANNEL	6
3	TEST FACILITIES AND ACCREDITATIONS	7
3.1	TEST LABORATORY	7
3.2	ENVIRONMENTAL CONDITIONS	7
3.3	MEASUREMENT UNCERTAINTY.....	7
3.4	TEST SOFTWARE	7
4	LIST OF TEST EQUIPMENT	8
5	TEST RESULTS.....	9
5.1	ANTENNA REQUIREMENT	9
5.1.1	<i>Standard requirement</i>	9
5.1.2	<i>EUT Antenna</i>	9
5.2	CONDUCTED EMISSION	10
5.2.1	<i>Limits</i>	10
5.2.2	<i>Test Procedures</i>	10
5.2.3	<i>Test Setup</i>	10
5.2.4	<i>Test Result</i>	10
5.3	RADIATED EMISSION.....	15
5.3.1	<i>Limits</i>	15
5.3.2	<i>Test Procedures</i>	16
5.3.3	<i>Test Setup</i>	17
5.3.4	<i>Test Result</i>	17
5.4	OCCUPIED BANDWIDTH.....	21
5.4.1	<i>Test method</i>	21
5.4.2	<i>Test result</i>	21
	PHOTOGRAPHS OF THE TEST SETUP	22
	PHOTOGRAPHS OF THE EUT.....	24

Test Result Certification

Applicant's name: DONGGUAN CHUANGLONG ELECTRONICS LIMITED

Address: King Long industrial district, xiekeng village, qingxi town, Dongguan city, Guangdong China

Manufacture's name: DONGGUAN CHUANGLONG ELECTRONICS LIMITED

Address: King Long industrial district, xiekeng village, qingxi town, Dongguan city, Guangdong China

Product name: Infrared Sensor Wireless Charge Holder

Trademark: N/A

Model name: TAC-106A, YT-701

Standards: FCC Part 15C

Test procedure: ANSI C63.10-2013

This device described above has been tested by Shenzhen Microtest Co., Ltd. and the test results show that the equipment under test (EUT) is in compliance with the FCC requirements. And it is applicable only to the tested sample identified in the report.

Tested by:



Demi Mu

July 25, 2020

Reviewed by:

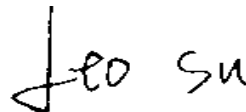

Leo Su

July 28, 2020

Approved by:



Tom Xue

July 28, 2020

1 GENERAL INFORMATION

1.1 Feature of equipment under test (EUT)

Product name:	Infrared Sensor Wireless Charge Holder
Model name:	TAC-106A, YT-701
Model difference:	All the model are the same circuit and RF module, except the model No..
Operation frequency:	115–205 kHz
Modulation type:	Load modulation
Antenna type:	Coil Antenna
Power supply:	DC 9V from adapter AC 120V/60Hz
Battery:	N/A
Adapter information:	N/A
EUT serial number:	MTi20062406-4-S0001

1.2 Test mode

To investigate the maximum EMI emission characteristics generates from EUT, the test system was pre-scanning tested base on the consideration of following EUT operation mode or test configuration mode which possible have effect on EMI emission level. Each of these EUT operation mode(s) or test configuration mode(s) mentioned above was evaluated respectively.

Test mode	Description
Mode 1	TX

Note:

1: The test modes were carried out for all operation modes. The final test mode of the EUT was the worst test mode for EMI, and its test data was showed.

2: EUT is tested under full load.

1.3 EUT test setup

See photographs of the test setup in the report for the actual setup and connections between EUT and support equipment.

1.4 Ancillary equipment

Equipment	Model	S/N	Manufacturer
Adapter	HW-090200CH0	/	HUIZHOU BYD ELECTRONICS CO., LTD.
Load	/	/	/

2 Summary of Test Result

Item	FCC Part No.	Description of Test	Result
1	FCC PART 15.203	Antenna requirement	Pass
2	FCC PART 15.207	Conducted emission	Pass
3	FCC PART 15.209	Radiated emission	Pass
4	FCC Part 15.215	20dB bandwidth	Pass

2.1 Operation channel list

Channel	Frequency (kHz)
Low	115
Middle	118
High	205

2.2 Test channel

Channel	Frequency (kHz)
Middle	118

3 Test Facilities and Accreditations

3.1 Test laboratory

Test Laboratory	Shenzhen Microtest Co., Ltd
Location	101, No. 7, Zone 2, Xinxing Industrial Park, Fuhai Avenue, Xinhe Community, Fuhai Street, Bao'an District, Shenzhen, Guangdong, China.
FCC Registration No.:	448573

3.2 Environmental conditions

Temperature:	15°C~35°C
Humidity	20%~75%
Atmospheric pressure	98kPa~101kPa

3.3 Measurement uncertainty

Measurement Uncertainty for a Level of Confidence of 95 %, $U=2xUc(y)$

RF frequency	1×10^{-7}
RF power, conducted	± 1 dB
Conducted emission(150kHz~30MHz)	± 2.5 dB
Radiated emission(30MHz~1GHz)	± 4.2 dB
Radiated emission (above 1GHz)	± 4.3 dB
Temperature	± 1 degree
Humidity	± 5 %

3.4 Test software

Software Name	Manufacturer	Model	Version
RF Test System	Shenzhen JS tonscond co., ltd	JS1120-3	2.5.77.0418

4 List of test equipment

Equipment No.	Equipment Name	Manufacturer	Model	Serial No.	Calibration date	Due date
MTI-E004	EMI Test Receiver	Rohde&schwarz	ESPI7	100314	2019/10/09	2020/10/08
MTI-E006	TRILOG Broadband Antenna	Schwarzbeck	VULB 9163	9163-872	2019/10/15	2020/10/14
MTI-E014	amplifier	Hewlett-Packard	8447D	3113A06150	2019/10/09	2020/10/08
MTI-E036	Single path vehicle AMN(LISN)	Schwarzbeck	NNBM 8124	01175	2019/10/09	2020/10/08
MTI-E038	Low noise active vertical monopole antenna	Schwarzbeck	VAMP 9243	#565	2019/10/16	2020/10/15
MTI-E039	Biconical antenna	Schwarzbeck	BBA 9106	#164	2019/10/15	2020/10/14
MTI-E041	MXG Vector Signal Generator	Agilent	N5182A	MY49060455	2020/04/16	2021/04/15
MTI-E042	ESG Series Analog signal generator	Agilent	E4421B	GB40051240	2020/05/21	2021/05/20
MTI-E044	Thermometer clock humidity monitor	-	HTC-1	/	2020/04/17	2021/04/16
MTI-E062	Log Periodic Antenna	Schwarzbeck	VUSLP 9111B	#312	2020/04/11	2022/04/10
MTI-E063	Log Periodic Dipole Array Antenna	ETS-LINDGREN	3148B	00224524	2020/04/11	2022/04/10
MTI-E065	Amplifier	EMtrace	RP06A	00117	2019/04/29	2020/04/28
MTI-E071	PXA Signal Analyzer	Agilent	N9030A	MY51350296	2018/10/25	2020/10/24
MTI-E076	EMI Test Receiver	Rohde&schwarz	ESIB26	100273	2020/04/16	2021/04/15
MTI-E078	Synthesized Sweeper	Agilent	83752A	3610A01957	2020/04/16	2021/04/15
MTI-E079	DC Power Supply	Agilent	E3632A	MY40027695	2020/04/16	2021/04/15
MTI-E093	Artificial mains network	3ctest	LISN J50	ES3911805	2020/04/16	2021/04/15
MTI-E096	Power amplifier	Space-Dtronics	EWLNA0118G-P40	1852001	2020/04/29	2021/04/28
MTI-E097	Current Probe	SOLAR ELECTRONICS CO.	9207-1	220095-1	2020/04/17	2021/04/16
MTI-E098	Loop Sensor	SOLAR ELECTRONICS CO.	7334-1	220095-2	2020/04/21	2021/04/20

Note: the calibration interval of the above test instruments is 12 or 24 months and the calibrations are traceable to international system unit (SI).

5 Test Results

5.1 Antenna requirement

5.1.1 Standard requirement

15.203 requirement: For intentional device, according to 15.203: an intentional radiator shall be designed to ensure that no antenna other than that furnished by the responsible party shall be used with the device

5.1.2 EUT Antenna

The EUT antenna is Coil Antenna. It comply with the standard requirement. In case of replacement of broken antenna the same antenna type must be used.

5.2 Conducted emission

5.2.1 Limits

For the following equipment, when designed to be connected to the public utility (AC) power line the radio frequency voltage that is conducted back onto the AC power line on any frequency or frequencies shall not exceed the limits in the following tables. Compliance with the provisions of this paragraph shall be based on the measurement of the radio frequency voltage between each power line and ground at the power terminal using a 50 μ H/50 ohms line impedance stabilization network (LISN).

Frequency (MHz)	Conducted limit (dB μ V)	
	Quasi-peak	Average
0.15 -0.5	66 - 56 *	56 - 46 *
0.5 -5	56	46
5 -30	60	50

Note:

the limit of " * " marked band means the limitation decreases linearly with the logarithm of the frequency in the range.

5.2.2 Test Procedures

The EUT was placed 0.8 meters from the horizontal ground plane with EUT being connected to the power mains through a line impedance stabilization network (LISN). All other support equipment powered from additional LISN(s). The LISN provide 50 Ohm/ 50uH of coupling impedance for the measuring instrument.

Interconnecting cables that hang closer than 40 cm to the ground plane shall be folded back and forth in the center forming a bundle 30 to 40 cm long.

I/O cables that are not connected to a peripheral shall be bundled in the center. The end of the cable may be terminated, if required, using the correct terminating impedance. The overall length shall not exceed 1 m.

LISN is at least 80 cm from nearest part of EUT chassis.

For the actual test configuration, please refer to the related Item – photographs of the test setup.

5.2.3 Test Setup

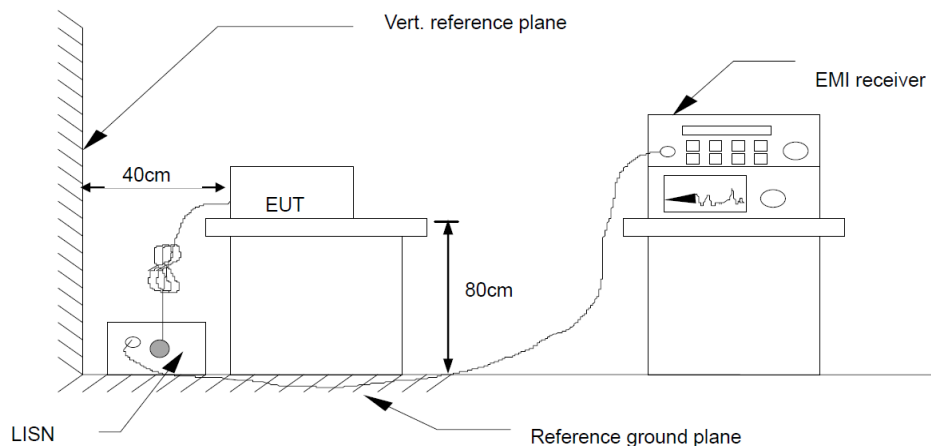

5.2.4 Test Result



EUT:	Infrared Sensor Wireless Charge Holder	Model Name:	TAC-106A
Pressure:	101kPa	Phase:	L
Test voltage:	DC 9V from adapter AC 120V/60Hz	Test mode:	Mode 1

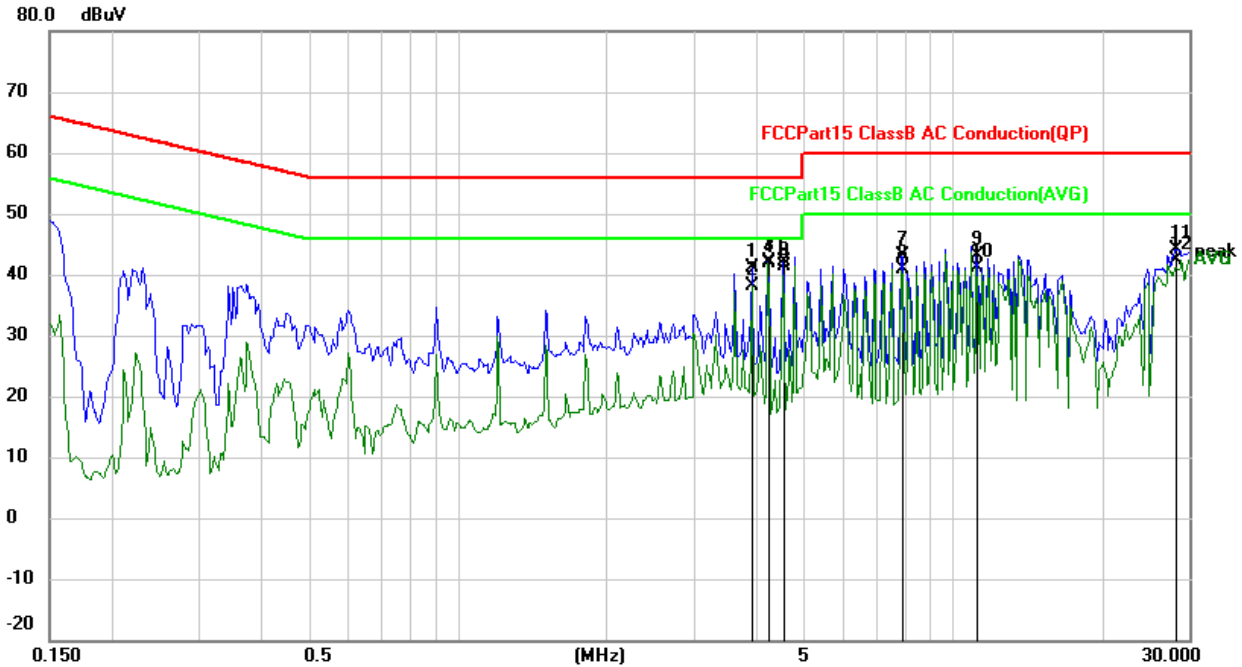

No.	Mk.	Freq.	Reading Level	Correct Factor	Measurement	Limit	Over	Detector
		MHz	dBuV	dB	dBuV	dBuV	dB	
1		3.9297	31.15	10.03	41.18	56.00	-14.82	QP
2		3.9297	28.18	10.03	38.21	46.00	-7.79	AVG
3		4.2305	32.12	10.03	42.15	56.00	-13.85	QP
4	*	4.2305	31.73	10.03	41.76	46.00	-4.24	AVG
5		4.5313	32.18	10.04	42.22	56.00	-13.78	QP
6		4.5313	31.26	10.04	41.30	46.00	-4.70	AVG
7		7.8906	33.05	10.19	43.24	60.00	-16.76	QP
8		7.8906	30.64	10.19	40.83	50.00	-9.17	AVG
9		11.1758	32.99	10.26	43.25	60.00	-16.75	QP
10		11.1758	30.85	10.26	41.11	50.00	-8.89	AVG
11		28.1055	33.92	10.33	44.25	60.00	-15.75	QP
12		28.1055	32.01	10.33	42.34	50.00	-7.66	AVG



EUT:	Infrared Sensor Wireless Charge Holder	Model Name:	TAC-106A
Pressure:	101kPa	Phase:	N
Test voltage:	DC 9V from adapter AC 120V/60Hz	Test mode:	Mode 1

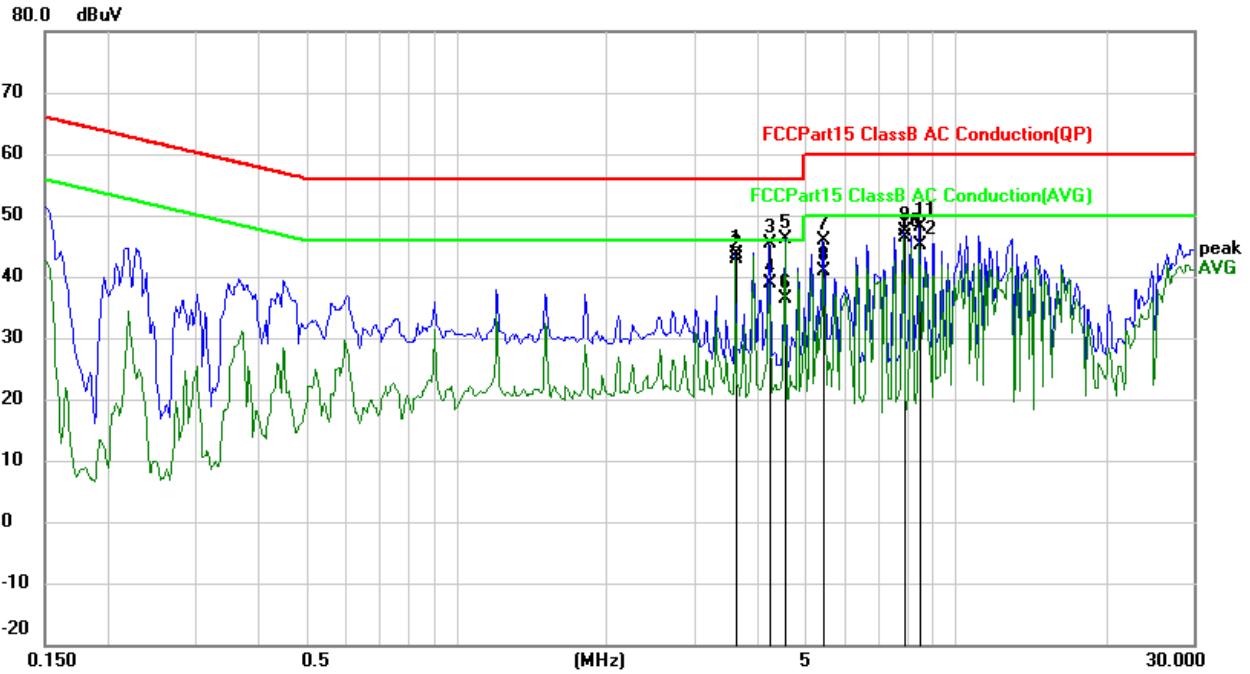

No.	Mk.	Freq.	Reading Level	Correct Factor	Measurement	Limit	Over	Detector
		MHz	dBuV	dB	dBuV	dBuV	dB	
1		3.6250	33.70	10.02	43.72	56.00	-12.28	QP
2	*	3.6250	32.95	10.02	42.97	46.00	-3.03	AVG
3		4.2266	35.43	10.03	45.46	56.00	-10.54	QP
4		4.2266	28.86	10.03	38.89	46.00	-7.11	AVG
5		4.5508	36.10	10.04	46.14	56.00	-9.86	QP
6		4.5508	26.46	10.04	36.50	46.00	-9.50	AVG
7		5.4375	35.81	10.07	45.88	60.00	-14.12	QP
8		5.4375	30.73	10.07	40.80	50.00	-9.20	AVG
9		7.8555	37.07	10.19	47.26	60.00	-12.74	QP
10		7.8555	36.11	10.19	46.30	50.00	-3.70	AVG
11		8.4570	37.96	10.22	48.18	60.00	-11.82	QP
12		8.4570	34.89	10.22	45.11	50.00	-4.89	AVG

EUT:	Infrared Sensor Wireless Charge Holder	Model Name:	TAC-106A
Pressure:	101kPa	Phase:	L
Test voltage:	DC 9V from adapter AC 240V/60Hz	Test mode:	Mode 1

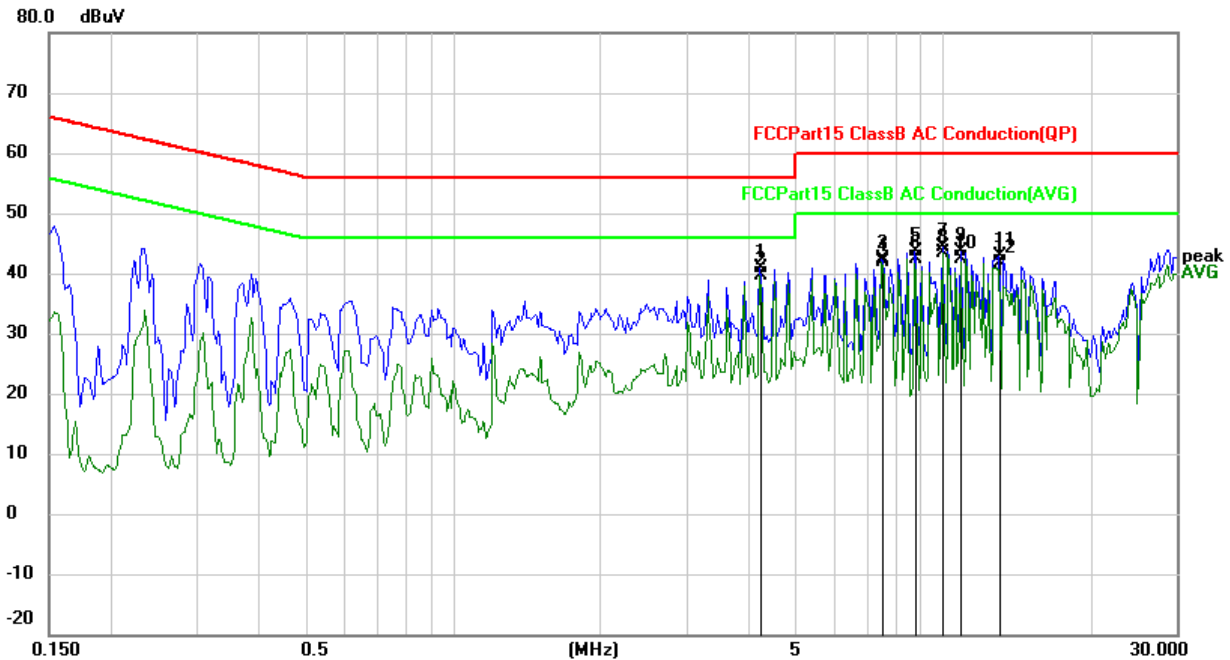

No.	Mk.	Freq. MHz	Reading Level dBuV	Correct Factor dB	Measure- ment dBuV	Limit dBuV	Over dB	Detector
1		4.2305	30.95	10.03	40.98	56.00	-15.02	QP
2	*	4.2305	29.69	10.03	39.72	46.00	-6.28	AVG
3		7.5195	32.25	10.17	42.42	60.00	-17.58	QP
4		7.5195	31.59	10.17	41.76	50.00	-8.24	AVG
5		8.7617	33.34	10.23	43.57	60.00	-16.43	QP
6		8.7617	32.08	10.23	42.31	50.00	-7.69	AVG
7		9.9922	34.17	10.29	44.46	60.00	-15.54	QP
8		9.9922	33.00	10.29	43.29	50.00	-6.71	AVG
9		10.8827	33.48	10.27	43.75	60.00	-16.25	QP
10		10.8827	32.12	10.27	42.39	50.00	-7.61	AVG
11		12.9961	32.74	10.23	42.97	60.00	-17.03	QP
12		12.9961	31.40	10.23	41.63	50.00	-8.37	AVG



EUT:	Infrared Sensor Wireless Charge Holder	Model Name:	TAC-106A
Pressure:	101kPa	Phase:	N
Test voltage:	DC 9V from adapter AC 240V/60Hz	Test mode:	Mode 1

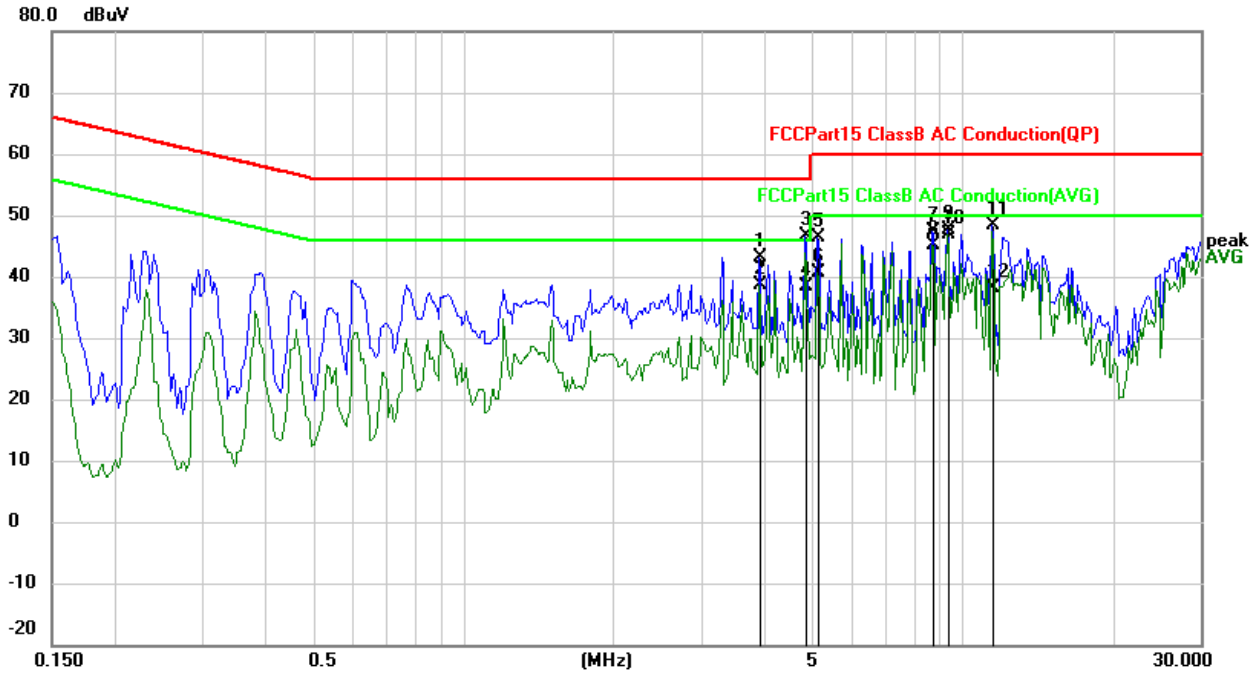

No.	Mk.	Freq.	Reading Level	Correct Factor	Measurement	Limit	Over	Detector
		MHz	dBuV	dB	dBuV	dBuV	dB	
1		3.9063	33.14	10.03	43.17	56.00	-12.83	QP
2		3.9063	28.62	10.03	38.65	46.00	-7.35	AVG
3		4.8358	36.56	10.05	46.61	56.00	-9.39	QP
4		4.8358	28.35	10.05	38.40	46.00	-7.60	AVG
5		5.1367	36.27	10.05	46.32	60.00	-13.68	QP
6		5.1367	30.58	10.05	40.63	50.00	-9.37	AVG
7		8.7266	37.04	10.23	47.27	60.00	-12.73	QP
8		8.7266	35.01	10.23	45.24	50.00	-4.76	AVG
9		9.3242	37.30	10.26	47.56	60.00	-12.44	QP
10	*	9.3242	36.67	10.26	46.93	50.00	-3.07	AVG
11		11.4844	38.05	10.26	48.31	60.00	-11.69	QP
12		11.4844	27.94	10.26	38.20	50.00	-11.80	AVG

5.3 Radiated emission

5.3.1 Limits

In case the emission fall within the restricted band specified on 15.205(a), then the 15.209(a) limit in the table below has to be followed.

Frequencies (MHz)	Field Strength (microrvolts/meter)	Measurement Distance (meters)
0.009~0.490	2400/F(KHz)	300
0.490~1.705	24000/F(KHz)	30
1.705~30.0	30	30
30~88	100	3
88~216	150	3
216~960	200	3
Above 960	500	3

LIMITS OF RADIATED EMISSION MEASUREMENT (Above 1000MHz)

FREQUENCY (MHz)	Class B (dBuV/m) (at 3M)	
	PEAK	AVERAGE
Above 1000	74	54

Notes:

The limit for radiated test was performed according to FCC PART 15C.

The tighter limit applies at the band edges.

Emission level (dBuV/m)=20log Emission level (uV/m).

FREQUENCY RANGE OF RADIATED MEASUREMENT (For unintentional radiators)

Highest frequency generated or Upper frequency of measurement used in the device or on which the device operates or tunes (MHz)	Range (MHz)
Below 1.705	30
1.705 – 108	1000
108 – 500	2000
500 – 1000	5000
Above 1000	5 th harmonic of the highest frequency or 40 GHz, whichever is lower

Spectrum Parameter	Setting
Attenuation	Auto
Start Frequency	1000 MHz
Stop Frequency	10th carrier harmonic
RB / VB (emission in restricted band)	1 MHz / 1 MHz for Peak, 1 MHz / 10Hz for Average

Receiver Parameter	Setting
Attenuation	Auto
Start ~ Stop Frequency	9kHz~150kHz / RB 200Hz for QP
Start ~ Stop Frequency	150kHz~30MHz / RB 9kHz for QP

Start ~ Stop Frequency	30MHz~1000MHz / RB 120kHz for QP
------------------------	----------------------------------

5.3.2 Test Procedures

- a. The measuring distance of at 3 m shall be used for measurements at frequency up to 25GHz. For frequencies above 1GHz, any suitable measuring distance may be used.
- b. The EUT was placed on the top of a rotating table 0.8 meters above the ground at a 3 meter semi-chamber test. The table was rotated 360 degrees to determine the position of the highest radiation.
- c. The height of the equipment or of the substitution antenna shall be 0.8m; above 1GHz, the height was 1.5m, the height of the test antenna shall vary between 1 m to 4 m. Both horizontal and vertical polarizations of the antenna are set to make the measurement.
- d. The initial step in collecting conducted emission data is a spectrum analyzer peak detector mode pre-scanning the measurement frequency range. Significant peaks are then marked and then Quasi Peak detector mode re-measured.
- e. If the Peak Mode measured value compliance with and lower than Quasi Peak Mode Limit, the EUT shall be deemed to meet QP Limits and then no additional QP Mode measurement performed.
- f. For the actual test configuration, please refer to the related Item –EUT Test Photos.
- g. For the radiated emission test above 1GHz:
Place the measurement antenna away from each area of the EUT determined to be a source of emissions at the specified measurement distance, while keeping the measurement antenna aimed at the source of emissions at each frequency of significant emissions, with polarization oriented for maximum response.
- h. The measurement antenna may have to be higher or lower than the EUT, depending on the radiation pattern of the emission and staying aimed at the emission source for receiving the maximum signal. The final measurement antenna elevation shall be that which maximizes the emissions. The measurement antenna elevation for maximum emissions shall be restricted to a range of heights of from 1 m to 4 m above the ground or reference ground plane.

Note: Both horizontal and vertical antenna polarities were tested and performed pretest to three orthogonal axis. The worst case emissions were reported.

5.3.3 Test Setup

Radiated Emission Test-Up Frequency Below 30MHz

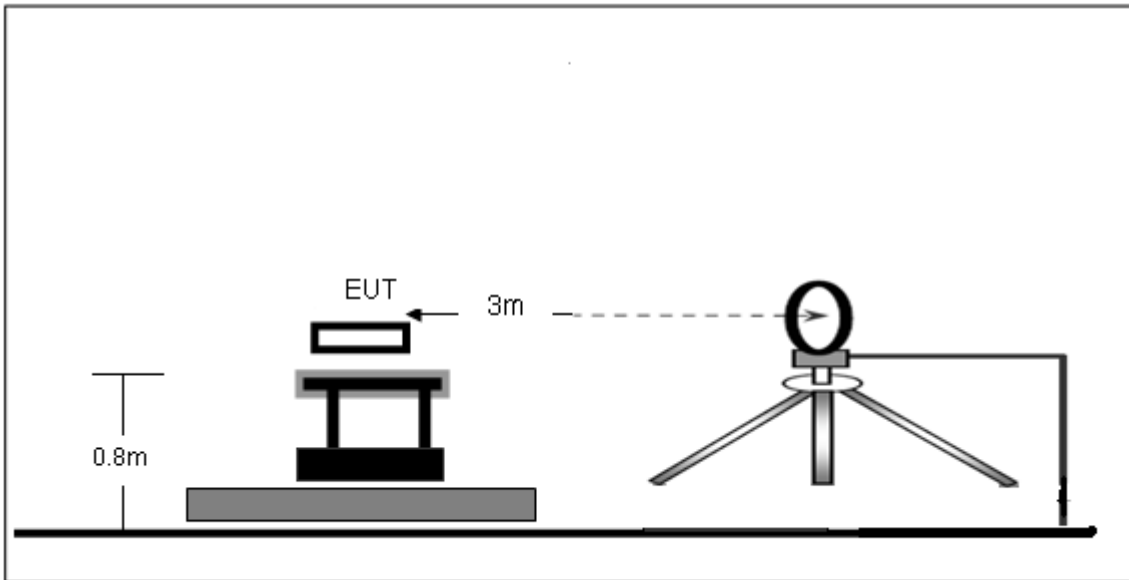

Radiated Emission Test-Up Frequency 30MHz~1GHz

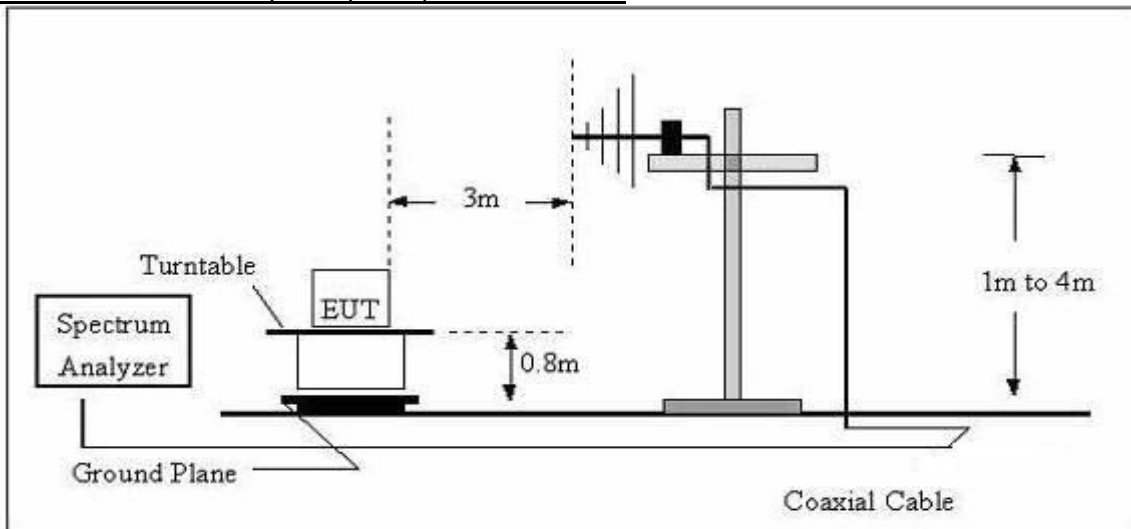

5.3.4 Test Result



Frequency range (9kHz – 30MHz)

EUT:	Infrared Sensor Wireless Charge Holder	Model Name:	TAC-106A
Pressure:	101kPa	Test mode:	Mode 1
Test voltage:	DC 9V from adapter AC 120V/60Hz		

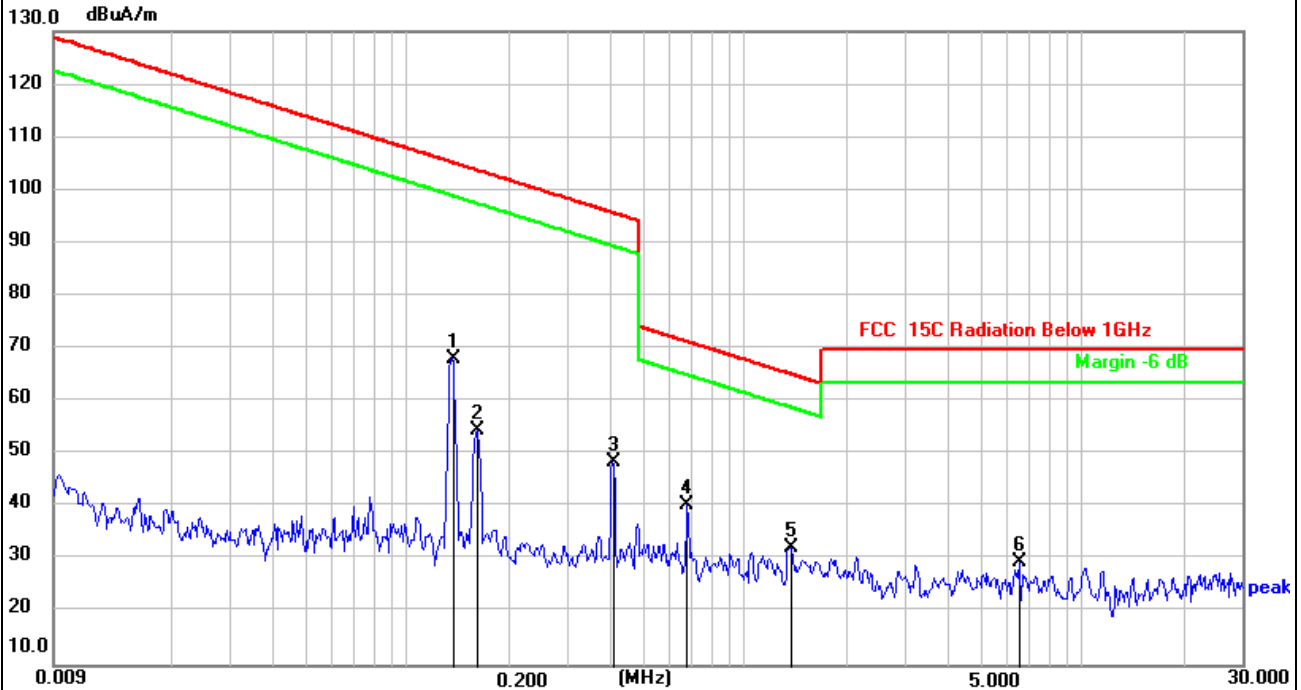

No.	Frequency (MHz)	Reading (dBuA)	Factor (dB/m)	Level (dBuA/m)	Limit (dBuA/m)	Margin (dB)	Detector
1	0.1363	47.98	20.11	68.09	104.91	-36.82	QP
2	0.1616	34.48	20.12	54.60	103.44	-48.84	QP
3	0.4074	28.23	20.29	48.52	95.40	-46.88	QP
4 *	0.6790	20.08	20.43	40.51	70.97	-30.46	QP
5	1.3754	11.88	20.50	32.38	64.86	-32.48	QP
6	6.5286	9.31	20.46	29.77	69.50	-39.73	QP



Frequency range (30MHz – 1GHz)

EUT:	Infrared Sensor Wireless Charge Holder	Model Name:	TAC-106A
Pressure:	101kPa	Polarization:	Vertical
Test voltage:	DC 9V from adapter AC 120V/60Hz	Test mode:	Mode 1

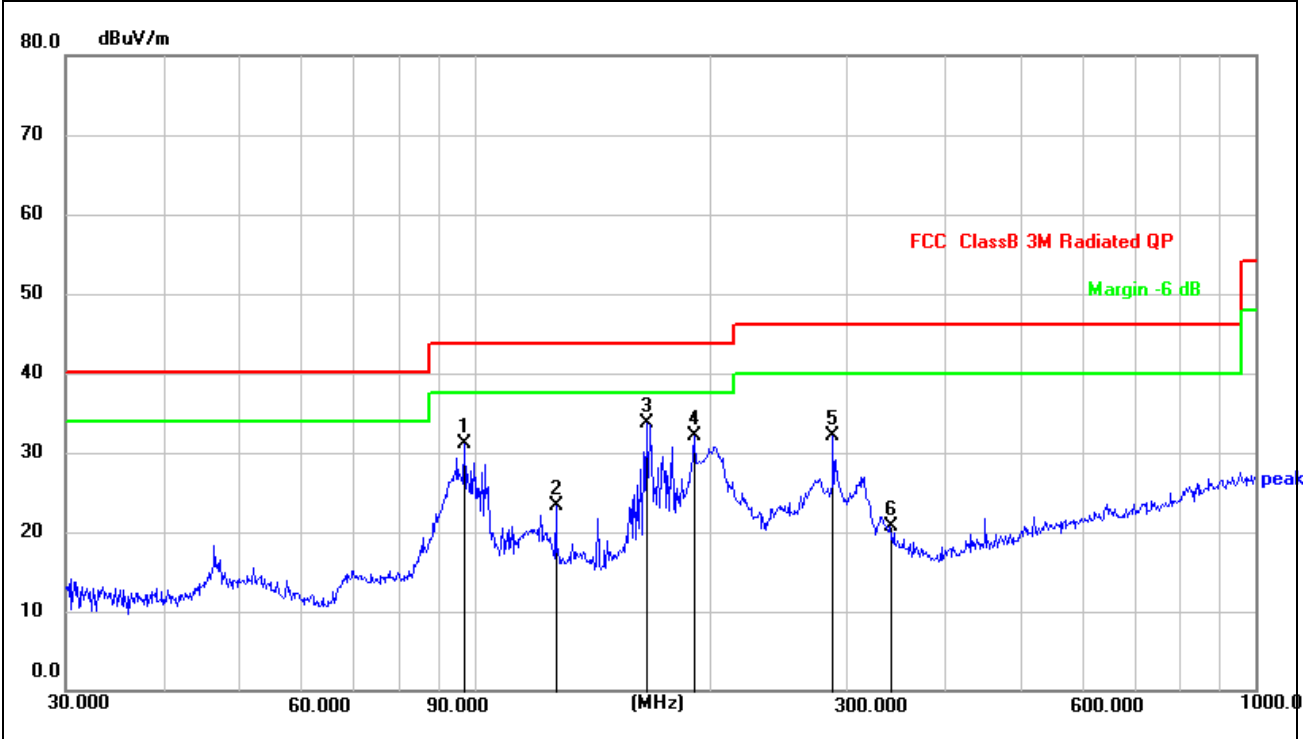

No.	Frequency (MHz)	Reading (dBuV)	Factor (dB/m)	Level (dBuV/m)	Limit (dBuV/m)	Margin (dB)	Detector
1	97.1148	46.63	-15.50	31.13	43.50	-12.37	QP
2	127.2176	40.35	-17.02	23.33	43.50	-20.17	QP
3 *	166.0680	50.28	-16.58	33.70	43.50	-9.80	QP
4	191.0738	46.79	-14.61	32.18	43.50	-11.32	QP
5	287.9904	43.33	-11.23	32.10	46.00	-13.90	QP
6	340.7817	30.95	-10.27	20.68	46.00	-25.32	QP



EUT:	Infrared Sensor Wireless Charge Holder	Model Name:	TAC-106A
Pressure:	101kPa	Polarization:	Horizontal
Test voltage:	DC 9V from adapter AC 120V/60Hz	Test mode:	Mode 1

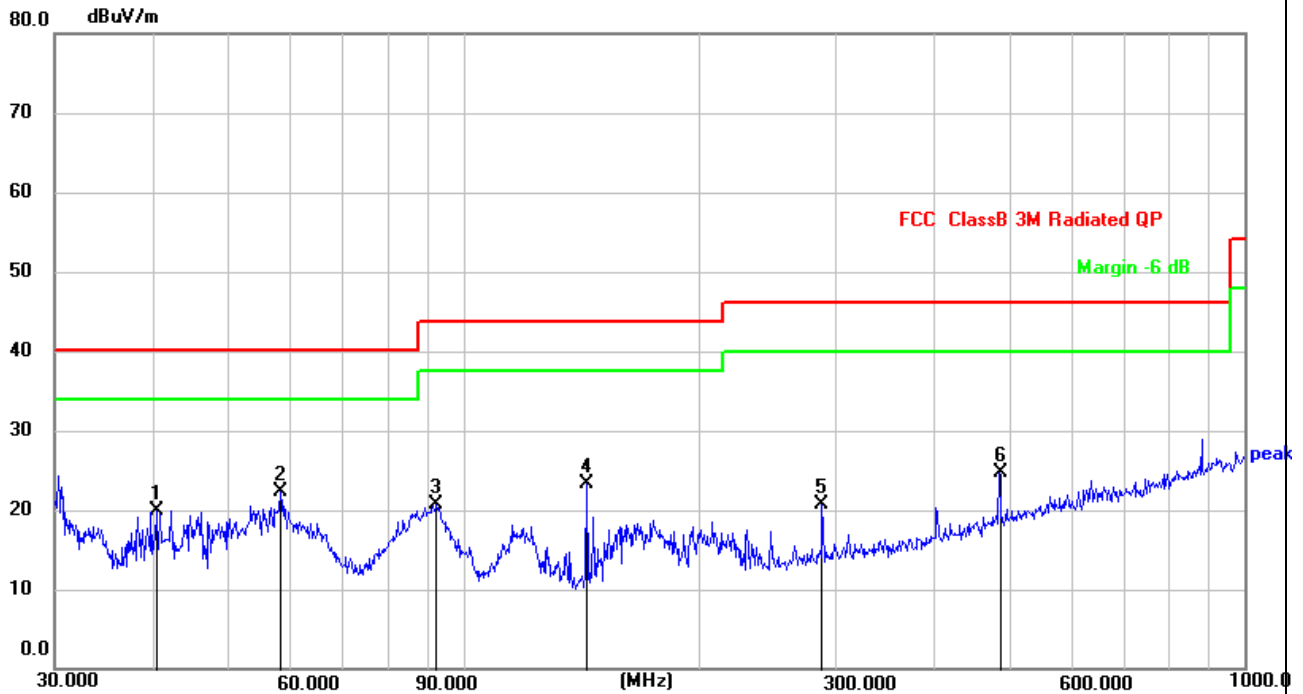

No.	Frequency (MHz)	Reading (dBuV)	Factor (dB/m)	Level (dBuV/m)	Limit (dBuV/m)	Margin (dB)	Detector
1	40.5591	34.57	-14.65	19.92	40.00	-20.08	QP
2 *	58.4074	37.13	-14.92	22.21	40.00	-17.79	QP
3	92.4624	36.97	-16.21	20.76	43.50	-22.74	QP
4	143.8295	41.11	-17.74	23.37	43.50	-20.13	QP
5	287.9904	31.93	-11.23	20.70	46.00	-25.30	QP
6	485.6093	32.44	-7.76	24.68	46.00	-21.32	QP

5.4 Occupied bandwidth

5.4.1 Test method

Use the following spectrum analyzer settings:

Span = approximately 2 to 3 times the 20 dB bandwidth, centered on a hopping channel

RBW $\geq 1\%$ of the 20 dB bandwidth

VBW \geq RBW

Sweep = auto

Detector function = peak

Trace = max hold

The EUT should be transmitting at its maximum data rate. Allow the trace to stabilize. Use the marker-to-peak function to set the marker to the peak of the emission. Use the marker-delta function to measure 20 dB down one side of the emission. Reset the marker-delta function, and move the marker to the other side of the emission, until it is (as close as possible to) even with the reference marker level. The marker-delta reading at this point is the 20 dB bandwidth and 99% occupied bandwidth of the emission.

5.4.2 Test result

Frequency (kHz)	20dB emission bandwidth (kHz)	99% occupied bandwidth (kHz)
118	8.093	6.965

Test plots as below:

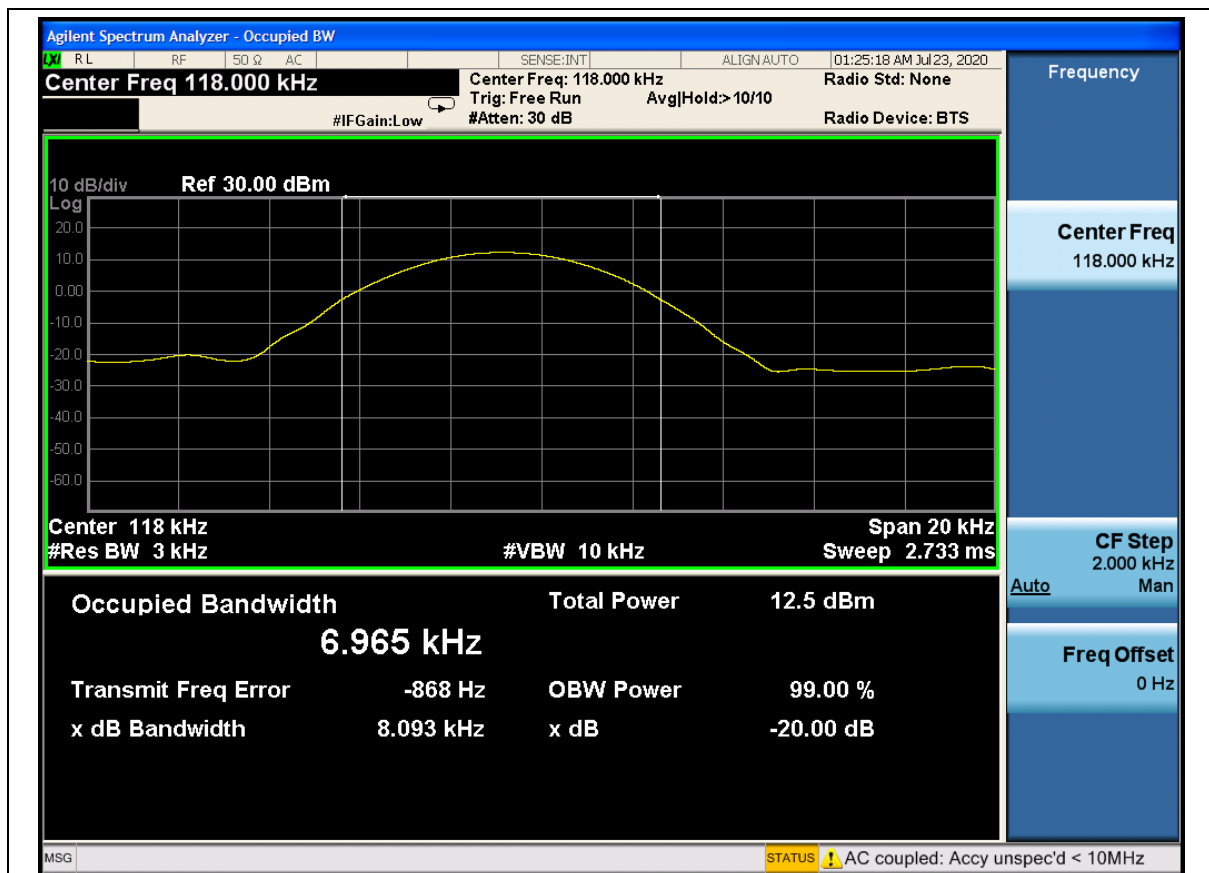

Photographs of the Test Setup

Radiated emission

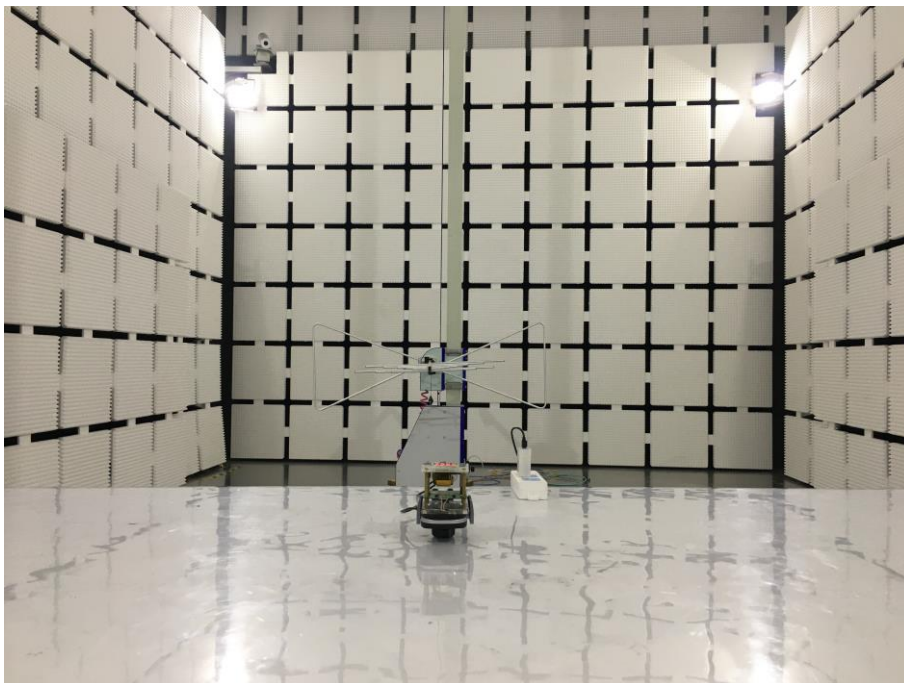
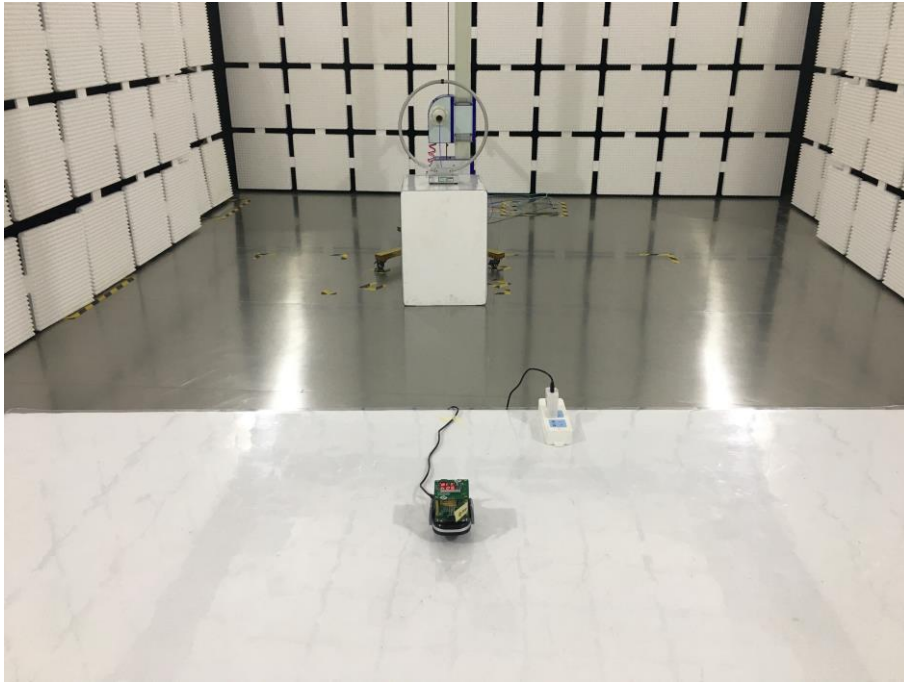



Conducted emission



Photographs of the EUT

See the APPENDIX 1: EUT PHOTOS in the report No.: MTi20062406-4E1-1.

----END OF REPORT----