

Wireless Car Charging holder User manual C108

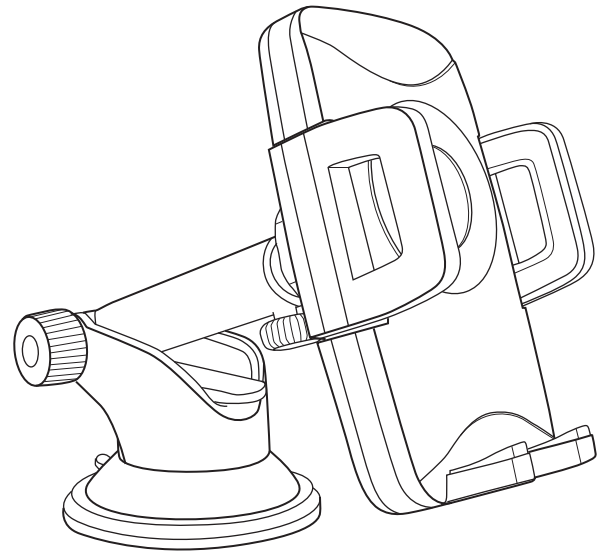

Please read the instructions carefully before using.

What is included:

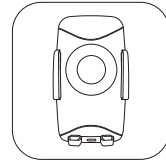

Wireless holder
X 1

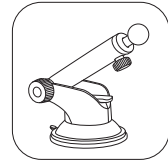

Suction cup mount
X 1

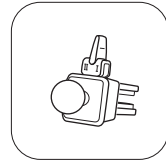

Air vent mount
X 1

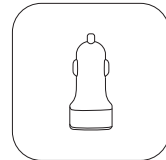

QC3.0 car charger
X 1

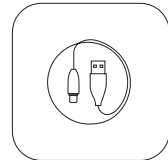

USB cable
X 1

Features:

- Car holder with wireless charging function, charges your phone conveniently when driving
- Designed to provide wireless-charging phones with Max. output 10W
- Full 360 degrees rotation for perfect viewing angle
- Supports mounting on dash or window or air vent.
- Adjustable foot support makes easy to align to the charging center
- Start charging asap as the phone contact with the holder, no need cable anymore
- QC 3.0 USB car charger included so you can start charging readily, with over temperature, over current, over voltage multi-safety protection

Parameters:

Wireless holder

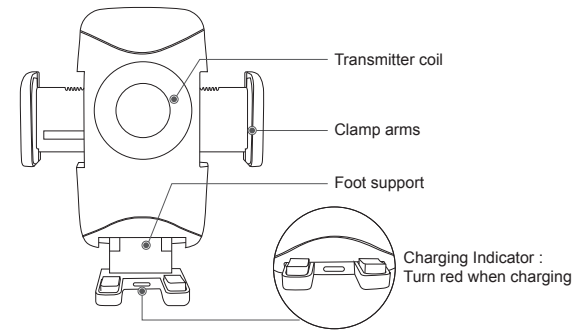

Telescoping suction cup mount

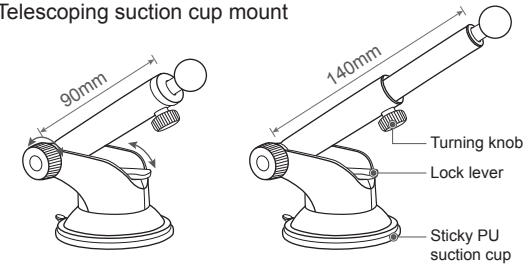

Air vent mount

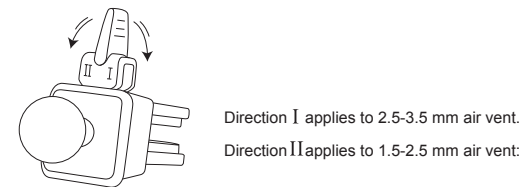

Product specification:

Wireless holder			
Input voltage	DC 5V/9V	Input current	2A
Output power	10W(Max)	Frequency	110-205KHZ
QC 3.0 car charger			
Input voltage	DC 12-24V		
Output Current/voltage 1	5V=3A, 9V=2A, 12V=1.5A		
Output Current/voltage 2	5V=2.4A		

Compatible devices:

1. Work well with iPhone X,iPhone 8,iPhone 8Plus, Samsung note 8/S8
2. Also work with all other Qi enabled devices

LED mode

Working state	LED light color
Power transfer	Red,blue,red blue light turn on by turns for once,then off
Standby mode	Light off
Charging	Red light keeps on
FOD Warning	Red light keeps flashing
Charge complete	Red light keeps on

FCC Statement

Changes or modifications not expressly approved by the party responsible for compliance could void the user's authority to operate the equipment.

This equipment has been tested and found to comply with the limits for a Class B digital device, pursuant to Part 15 of the FCC Rules. These limits are designed to provide reasonable protection against harmful interference in a residential installation. This equipment generates uses and can radiate radio frequency energy and, if not installed and used in accordance with the instructions, may cause harmful interference to radio communications. However, there is no guarantee that interference will not occur in a particular installation. If this equipment does cause harmful interference to radio or television reception, which can be determined by turning the equipment off and on, the user is encouraged to try to correct the interference by one or more of the following measures:

- Reorient or relocate the receiving antenna.
- Increase the separation between the equipment and receiver.
- Connect the equipment into an outlet on a circuit different from that to which the receiver is connected.
- Consult the dealer or an experienced radio/TV technician for help.

This device complies with part 15 of the FCC rules. Operation is subject to the following two conditions (1) this device may not cause harmful interference, and (2) this device must accept any interference received, including interference that may cause undesired operation.

Installation:

Mount on windshield:

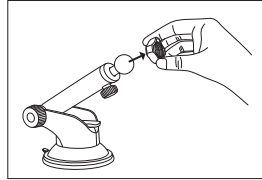

1. Insert the adjuster into the ball joint adapter

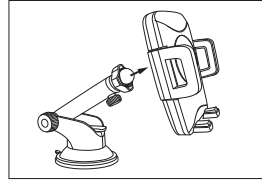

2. Insert the ball into the socket at the back of bracket and tighten

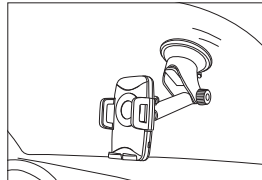

3. Clean the mounting area, push suction cup firmly against windshield and press the lever to lock

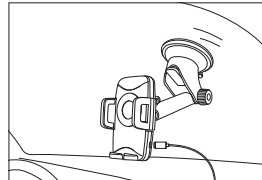

4. Connect wireless holder with USB cable micro end

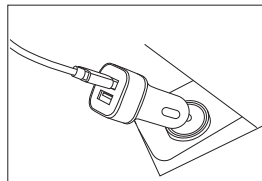

5. Connect the other end to green (fast charge) port of car charger, insert the charger to car cigar lighter

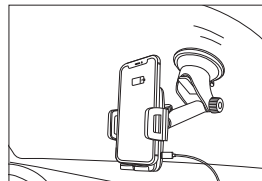

6. Open the clamp arms and put your phone in, extend the foot support to align the charging center

Mount on the dashboard:

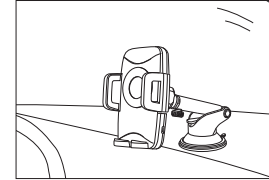

1. Find a part of flat surface and clean the mounting area, push suction cup firmly against the area and press the lever to lock

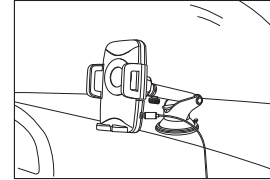

2. Connect wireless holder with USB cable micro end

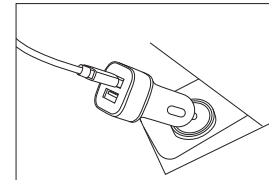

3. Connect the other end to green (fast charge) port of car charger, insert the charger to car cigar lighter

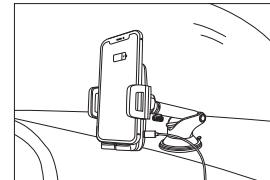

4. Open the clamp arms and put your phone in, extend the foot support to align the charging center

Mount on air vent:

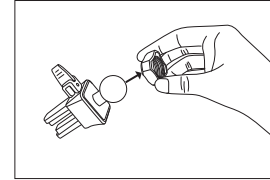

1. Insert the adjuster into the ball joint adapter

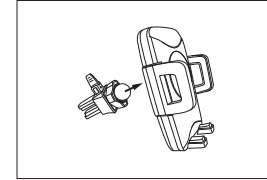

2. Insert the ball into the socket at the back of bracket and tighten

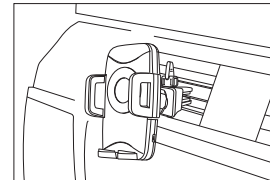

3. Insert the mount clips into the car air vent louver and press down the switch

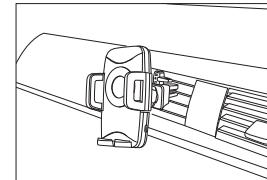

4. Firstly turn the switch to direction I if too loose, turn to direction II

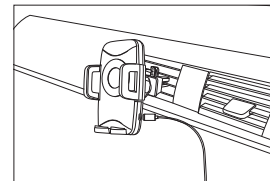

5. Connect wireless holder with USB cable micro end

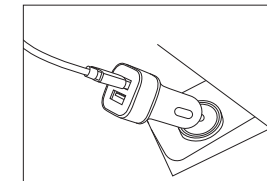

6. Connect the other end to green (fast charge) port of car charger, insert the charger to car cigar lighter

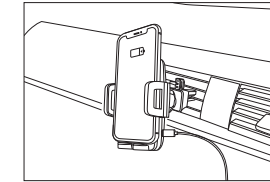

7. Open the clamp arms and put your phone in, extend the foot support to align the charging center

Attentions:

1. Please use the product correctly according instructions
2. Please do not disassemble the product or throw it to fire and water, to avoid leakage caused by electrical short circuit
3. Please do not use wireless charger in high temperature, wet, corrosive environment, to avoid leakage from caused by damaged circuit
4. Please do not put wireless charger close to cards with magnetic stripes or chips (ID card, credit card etc.) to avoid demagnetization
5. Please keep wireless charger at least 20 CM distance away from implantable medical device (heart pacemaker, Implantable cochlea etc.) to avoid potential interferences
6. Please do safekeeping, do not let your kids treat wireless charger as toy to avoid unwanted accidents

The pictures only supplies the reference, please take the actual product as the standard

Wireless Car Charging holder User manual

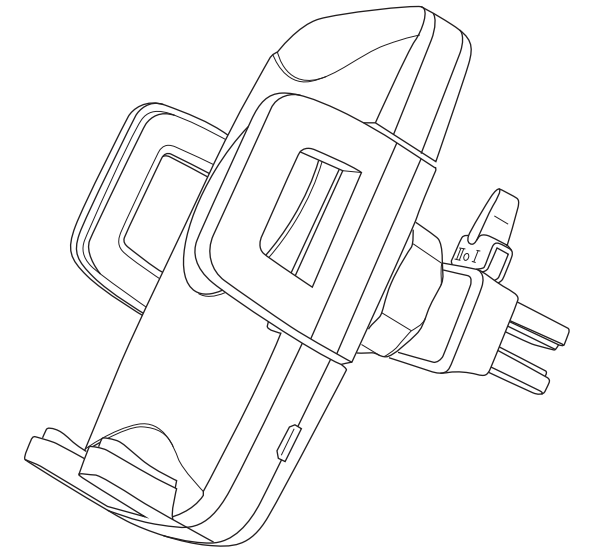

Please read the instructions carefully before using.