

Prüfbericht-Nr.: <i>Test Report No.:</i>	50224373 001	Auftrags-Nr.: <i>Order No.:</i>	238100815	Seite 1 von 32 <i>Page 1 of 32</i>	
Kunden-Referenz-Nr.: <i>Client Reference No.:</i>	N/A	Auftragsdatum: <i>Order date:</i>	31-Jan-2019		
Auftraggeber: <i>Client:</i>	H.P.B. HI-TECH CORP. 10F., No. 308, Sec. 1, Neihu Rd., Taipei City 114, Taiwan, R.O.C				
Prüfgegenstand: <i>Test item:</i>	Hand Gesture Controller				
Bezeichnung / Typ-Nr.: <i>Identification / Type No.:</i>	Wave1210				
Auftrags-Inhalt: <i>Order content:</i>	FCC Test report (BLE)				
Prüfgrundlage: <i>Test specification:</i>	FCC 47CFR Part 15: Subpart C Section 15.247(DTS)				
Wareneingangsdatum: <i>Date of receipt:</i>	07-Jan-2019				
Prüfmuster-Nr.: <i>Test sample No.:</i>	A000863281-001,002				
Prüfzeitraum: <i>Testing period:</i>	17-Jan-2019 – 15-Feb-2019				
Ort der Prüfung: <i>Place of testing:</i>	EMC/RF Laboratory Taipei				
Prüflaboratorium: <i>Testing laboratory:</i>	TUV Rheinland Taiwan Ltd.				
Prüfergebnis*: <i>Test result*:</i>	Pass				
geprüft von / tested by:		kontrolliert von / reviewed by:			
2019-02-19	Mars Y.J. Lin / Project Engineer	2019-02-19	Ryan W. T. Chen / Project Manager		
Datum <i>Date</i>	Name / Stellung <i>Name / Position</i>	Unterschrift <i>Signature</i>	Datum <i>Date</i>	Name / Stellung <i>Name / Position</i>	Unterschrift <i>Signature</i>
Sonstiges / Other:					
Zustand des Prüfgegenstandes bei Anlieferung: <i>Condition of the test item at delivery:</i>		Prüfmuster vollständig und unbeschädigt <i>Test item complete and undamaged</i>			
* Legende: 1 = sehr gut 2 = gut 3 = befriedigend 4 = ausreichend 5 = mangelhaft P(ass) = entspricht o.g. Prüfgrundlage(n) F(ail) = entspricht nicht o.g. Prüfgrundlage(n) N/A = nicht anwendbar N/T = nicht getestet					
Legend: 1 = very good 2 = good 3 = satisfactory 4 = sufficient 5 = poor P(ass) = passed a.m. test specification(s) F(ail) = failed a.m. test specification(s) N/A = not applicable N/T = not tested					
Dieser Prüfbericht bezieht sich nur auf das o.g. Prüfmuster und darf ohne Genehmigung der Prüfstelle nicht auszugsweise vervielfältigt werden. Dieser Bericht berechtigt nicht zur Verwendung eines Prüfzeichens. <i>This test report only relates to the a. m. test sample. Without permission of the test center this test report is not permitted to be duplicated in extracts. This test report does not entitle to carry any test mark.</i>					

TEST SUMMARY

5.1.1 ANTENNA REQUIREMENT

RESULT: *Passed*

5.1.2 PEAK OUTPUT POWER

RESULT: *Passed*

5.1.3 6dB BANDWIDTH

RESULT: *Passed*

5.1.4 POWER DENSITY

RESULT: *Passed*

5.1.5 CONDUCTED SPURIOUS EMISSIONS AND FREQUENCY BAND EDGE MEASURED IN 100KHZ BANDWIDTH

RESULT: *Passed*

5.1.6 SPURIOUS EMISSION

RESULT: *Passed*

5.2.1 MAINS CONDUCTED EMISSIONS

RESULT: *Passed*

6.1.1 ELECTROMAGNETIC FIELDS

RESULT: *Passed*

Contents

1.	GENERAL REMARKS	5
1.1	COMPLEMENTARY MATERIALS.....	5
1.2	COMPLEMENTARY MATERIALS.....	5
2.	TEST SITES	6
2.1	TEST LABORATORY	6
2.2	TEST FACILITY.....	6
2.3	LIST OF TEST AND MEASUREMENT INSTRUMENTS.....	7
2.4	TRACEABILITY	8
2.5	CALIBRATION	8
2.6	MEASUREMENT UNCERTAINTY	8
3.	GENERAL PRODUCT INFORMATION.....	9
3.1	PRODUCT FUNCTION AND INTENDED USE	9
3.2	SYSTEM DETAILS AND RATINGS.....	9
3.3	INDEPENDENT OPERATION MODES.....	10
3.4	NOISE GENERATING AND NOISE SUPPRESSING PARTS	10
3.5	SUBMITTED DOCUMENTS.....	10
4.	TEST SET-UP AND OPERATION MODES.....	11
4.1	PRINCIPLE OF CONFIGURATION SELECTION	11
4.2	TEST OPERATION AND TEST SOFTWARE.....	11
4.3	SPECIAL ACCESSORIES AND AUXILIARY EQUIPMENT	11
4.4	COUNTERMEASURES TO ACHIEVE EMC COMPLIANCE.....	12
4.5	TEST SETUP DIAGRAM	12
5.	TEST RESULTS	14
5.1	TRANSMITTER REQUIREMENT & TEST SUITES.....	14
5.1.1	<i>Antenna Requirement</i>	<i>14</i>
5.1.2	<i>Peak Output Power</i>	<i>15</i>
5.1.3	<i>6dB Bandwidth</i>	<i>16</i>
5.1.4	<i>Power Density</i>	<i>19</i>
5.1.5	<i>Conducted spurious emissions and Frequency Band Edge measured in 100kHz Bandwidth.....</i>	<i>22</i>
5.1.6	<i>Spurious Emission</i>	<i>26</i>
5.2	MAINS EMISSIONS.....	27
5.2.1	<i>Mains Conducted Emissions.....</i>	<i>27</i>
6.	SAFETY HUMAN EXPOSURE	28

6.1	RADIO FREQUENCY EXPOSURE COMPLIANCE	28
6.1.1	<i>Electromagnetic Fields.....</i>	<i>28</i>
7.	PHOTOGRAPHS OF THE TEST SET-UP.....	29
8.	LIST OF TABLES	32
9.	LIST OF PHOTOGRAPHS.....	32

1. General Remarks

1.1 Complementary Materials

These attachments are integral parts of this test report:

Appendix P: Photo Documentation internal view
(File Name: 50224373 001APPENDIXP)

Appendix D: Test Result of Radiated Emissions
(File Name: 50224373 001APPENDIXD)

Test Specifications

The following standards were applied.

Table 1: Applied Standard and Test Levels

Radio
FCC CFR47 Part 15: Subpart C Section 15.247 ANSI C63.10 (2013) KDB 558074 D01 15.247 Meas Guidance v05r01

1.2 Complementary Materials

The decision rule of conformity of this test report is following the requirements of the requested standard in the quotation, and agreed among testing laboratory and manufacturer (applicant) to exclude the consideration of Measurement Uncertainty, unless it is required by the specific standard.

2. Test Sites

2.1 Test Laboratory

TUV Rheinland Taiwan Ltd.
Taichung Branch Office

No.9, Lane 36, Minsheng Rd., Sec. 3, Daya District,
Taichung City 428
Taiwan (R.O.C.)

2.2 Test Facility

TUV Rheinland Taiwan Ltd.
Taipei Office

11F. No.758, Sec. 4, Bade Rd., Songshan Dist.
Taipei City 105
Taiwan (R.O.C.)

FCC RegistrationNo.: 340738
IC Canada Registration No.: 9465A-1
TAF Accredited NCC Test Lab. No.:0759
TAF ISO17025 Certification effective periods: 2016-Jul-1st to 2019-Jun-30th



Testing Laboratory
0759

2.3 List of Test and Measurement Instruments

Table 2: List of Test and Measurement Equipment

Kind of Equipment	Manu-facturer	Type	S/N	Last Calibration	Next Calibration
Test Software	Farad	EZ_EMC	Ver. TUV3A1	N/A	N/A
Spectrum Analyzer	R&S	FSV 40	100921	2018/05/02	2019/05/01
EXA Signal Analyzer	KEYSIGHT	N9010A	MY52221334	2018/04/05	2019/04/04
Preamplifier (30MHz -1GHz)	HP	8447F	2805A03335	2018/08/14	2019/08/13
Preamplifier (18 GHz -40 GHz)	COM-POWER	PAM-840	461257	2019/01/18	2020/01/17
Pre-Amplifier (1GHz~18GHz)	EM Electronics	EM01G18G	60558	2018/11/21	2019/11/20
Bilog Antenna	TESEQ	CBL6111D	29804	2018/08/18	2019/08/17
Horn Antenna	ETS-Lindgren	3117	201918	2018/08/18	2019/08/17
Horn Antenna (18GHz~40GHz)	COM-POWER	AH-840	101029	2018/11/28	2019/11/27
Loop Antenna	Schwarzbeck	FMZB 1513	1513-076	2018/06/14	2019/06/13
EMI Test Receiver	R&S	ESR 7	101549	2018/11/10	2019/11/09
Spectrum Analyzer	R&S	FSL3	101943	2018/09/07	2019/09/06
Temp. & Humid. Chamber	Giant Force	GCT-099-40-S	MAF0103-007	2018/03/09	2019/03/08

2.4 Traceability

All measurement equipment calibrations are traceable to NML(Taiwan)/NIST(USA) or where calibration is performed outside Taiwan, to equivalent nationally recognized standards organizations.

2.5 Calibration

Equipment requiring calibration is calibrated periodically in a suitably accredited Calibration Lab. Additionally all equipment is verified for proper performance on a regular schedule using in house standards or comparisons.

2.6 Measurement Uncertainty

The estimated combined standard uncertainty for radiated emissions and conducted emissions measurements .

Table 3: Emission Measurement Uncertainty

Parameter	Uncertainty
Radio Frequency	± 0.1 ppm
RF power, conducted	± 1.5 dB
RF power density, conducted	± 3 dB
spurious emissions, conducted	± 3 dB
all emissions, radiated	± 6 dB
Temperature	± 1 °C
Humidity	± 5 %
DC and low frequency voltages	±3 %

3. General Product Information

3.1 Product Function and Intended Use

The EUT is a Hand Gesture Controller. It contains a Bluetooth compatible module enabling the user to communicate data through a Wireless interface. For details refer to the User Guide, Data Sheet and Block Diagram.

3.2 System Details and Ratings

Table 4: Basic Information of EUT

Item	EUT information
Kind of Equipment/Test Item	Hand Gesture Controller
Type Identification	Wave1210
FCC ID	2APC5-WAVE1210

Table 5: Technical Specification of EUT

Technical Specification	Value
Operating Frequencies	2402MHz ~ 2480MHz
Channel Spacing	2 MHz
Channel number	40
Operation Voltage	9Vdc
Modulation	GFSK
Antenna gain	2.41dBi

3.3 Independent Operation Modes

Basic operation modes are:

- A. Transmitting
 - 1. Low channel
 - 2. Middle channel
 - 3. High channel
- B. Receiving
- C. Normal

3.4 Noise Generating and Noise Suppressing Parts

Refer to the Block Diagram.

3.5 Submitted Documents

- Block Diagram
- Instruction Manual
- Rating Label
- Technical Description

4. Test Set-up and Operation Modes

4.1 Principle of Configuration Selection

The equipment under test (EUT) was configured to measure its maximum power level. The test modes were adapted accordingly in reference to the instructions for use.

4.2 Test Operation and Test Software

Setup for testing: Test samples are provided with USB interface which makes it possible to control them through a test software installed on a notebook computer.

This software nRFgo was running on the laptop computer connected to the EUT. It was used to enable the operation modes listed in section 3.3 as appropriate.

The samples were used as follows:

Conducted test: A000863281-001

Radiated test: A000863281-002

Full test was applied on all test modes, but only worst case was shown

4.3 Special Accessories and Auxiliary Equipment

The product has been tested together with the following additional accessories:

Kind of Equipment	Manufacturer	Model Name	S/N
Laptop	MSI	MSI4532(CX420MX)	1008000096
Fan sensor	N/A	N/A	N/A

4.4 Countermeasures to achieve EMC Compliance

The test sample which has been tested contained the noise suppression parts as described in the Constructional Data Form or the Technical Construction File. No additional measures were employed to achieve compliance.

4.5 Test Setup Diagram

Diagram of Measurement Configuration for Radiation Test

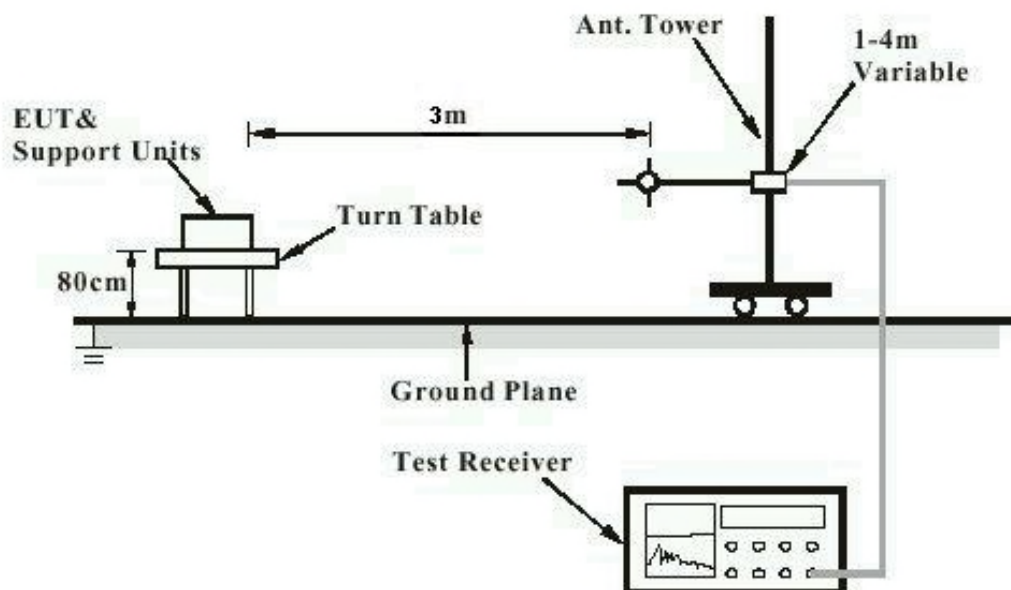

Note: Measurements above 1 GHz are done with a table height of 1.5m

Diagram of Measurement Equipment Configuration for Mains Conduction Measurement (if applicable)

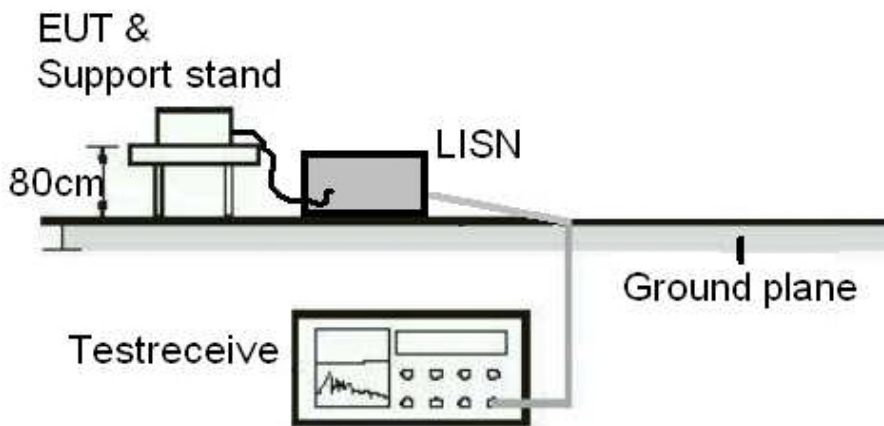
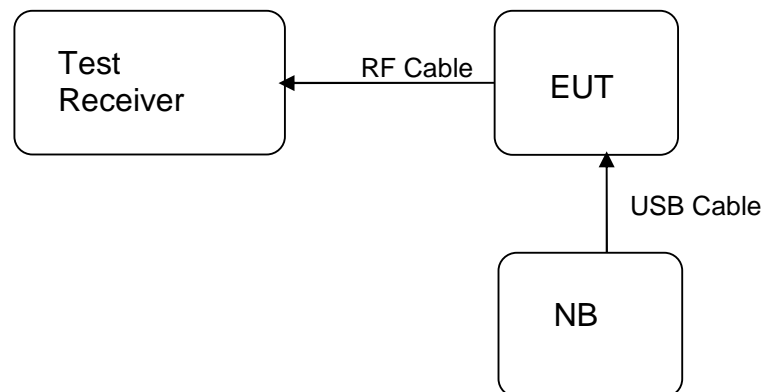

Diagram of Measurement Equipment Configuration for Conducted Transmitter Measurement



5. Test Results

5.1 Transmitter Requirement & Test Suites

5.1.1 Antenna Requirement

RESULT: **Passed**

Test standard : FCC Part 15.247(b)(4), Part 15.203

Requirement : use of approved antennas only with directional gains that do not exceed 6 dBi

According to the manufacturer declaration, the EUT has an antenna with a directional gain of 2.41dBi. The antenna is a Chip Antenna soldered to the PCB with no possibility of replacement with a non-approved antenna by the end-user. Therefore, the EUT is considered to comply with this provision.

Refer to EUT photo for details.

5.1.2 Peak Output Power

RESULT:
Passed

Test standard : FCC Part 15.247(b)(3)
 Basic standard : ANSI C63.10 (2013), KDB558074
 Limit : 1 Watt
 Kind of test site : Shielded room

Test setup

Test Channel : Low/ Middle/ High
 Operation Mode : A
 Ambient temperature : 20-24 °C
 Relative humidity : 50-65 %
 Atmospheric pressure : 100-103 kPa

Table 6: Test result of Peak Output Power

Channel	Channel Frequency (MHz)	Output Power		Limit
		(dBm)	(W)	(W)
Low Channel	2402	-10.16	0.00010	1
Middle Channel	2440	-12.21	0.00006	1
High Channel	2480	-13.69	0.00004	1

Pmax: 0.0964mW

5.1.3 6dB Bandwidth

RESULT:
Passed

Test standard : FCC Part 15.247(a)(2)
 Basic standard : ANSI C63.10 (2013), KDB558074
 Kind of test site : Shielded room

Test setup

Test Channel : Low/ Middle/ High
 Operation Mode : A
 Ambient temperature : 20-24°C
 Relative humidity : 50-65%
 Atmospheric pressure : 100-103 kPa

Table 7: Test result of 6dB Bandwidth

Channel	Channel Frequency (MHz)	6dB Bandwidth (kHz)	Limit (kHz)	Result
Low Channel	2402	678.3	>500	Pass
Mid Channel	2440	696.2	>500	Pass
High Channel	2480	701.3	>500	Pass

Test Plot of 6dB Bandwidth

Low Channel

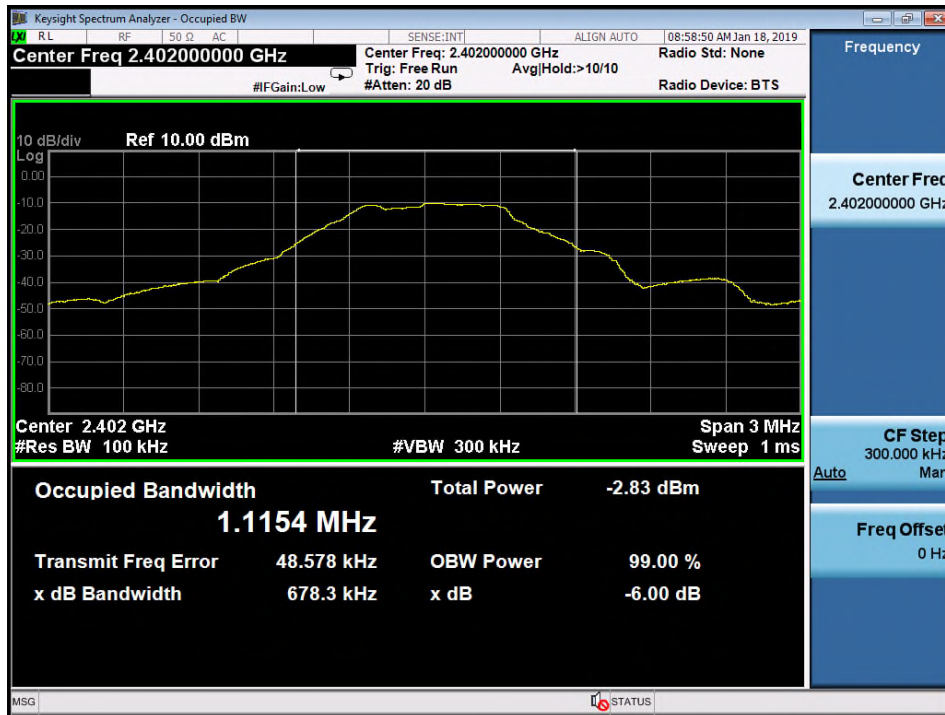

Middle Channel

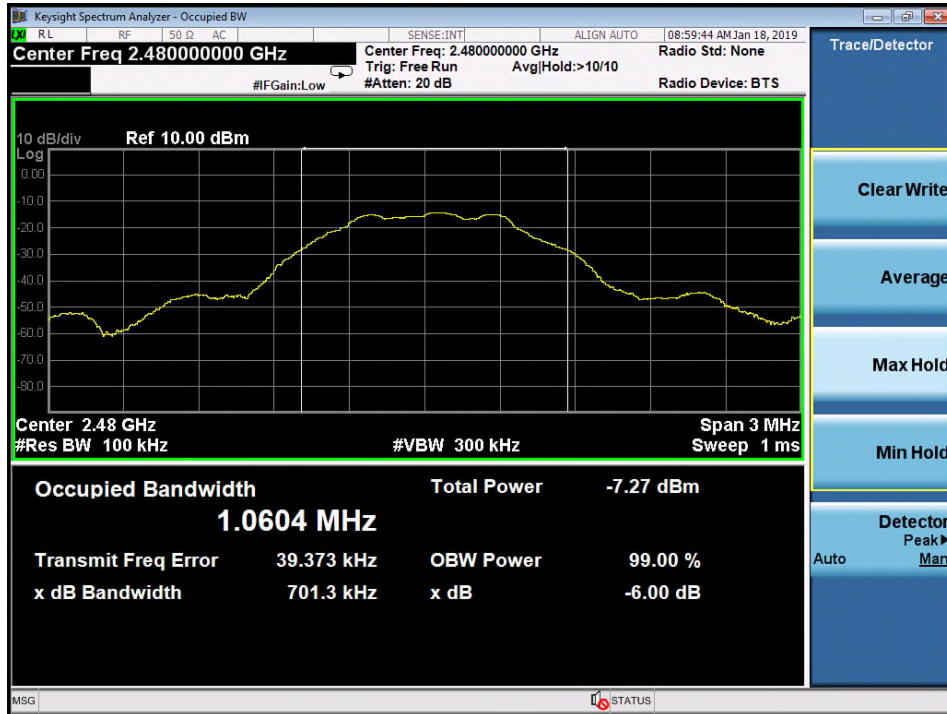

High Channel

5.1.4 Power Density

RESULT:
Passed

Test standard : FCC Part 15.247(e)
 Basic standard : ANSI C63.10 (2013), KDB558074
 Kind of test site : Shielded room

Test setup

Test Channel : Low/ Middle/ High
 Operation Mode : A
 Ambient temperature : 20-24°C
 Relative humidity : 50-65%
 Atmospheric pressure : 100-103 kPa

Table 8: Test result of Power Density

Channel	Channel Frequency (MHz)	Power Density	Limit
		(dBm)	(dBm)
Low Channel	2402	-23.95	8
Middle Channel	2440	-26.42	8
High Channel	2480	-27.53	8

Test Plot of Power Density

Low Channel

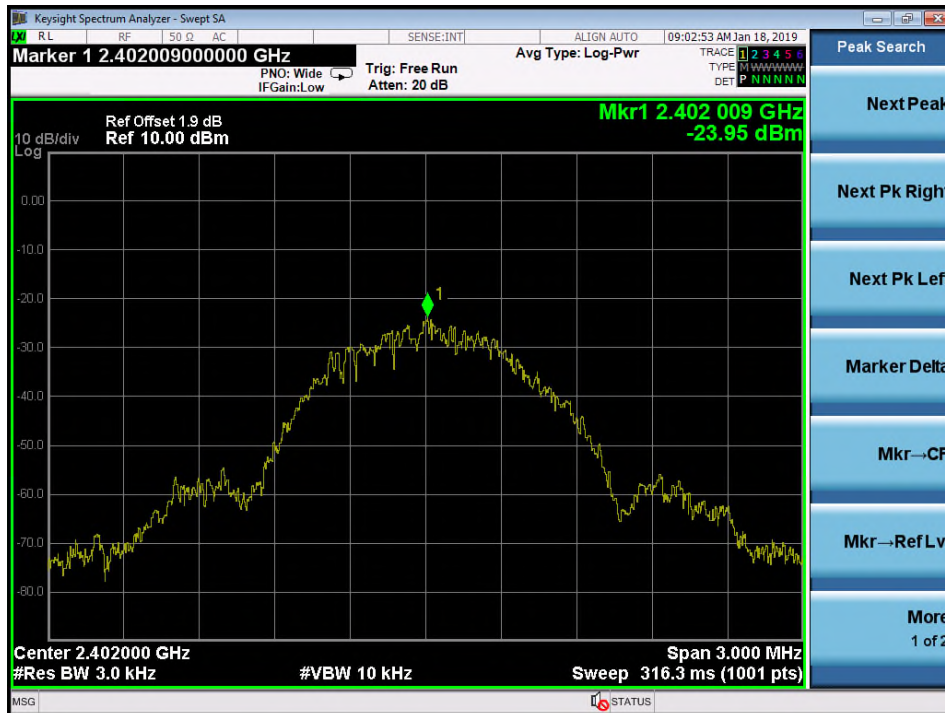

Middle Channel



High Channel

5.1.5 Conducted spurious emissions and Frequency Band Edge measured in 100kHz Bandwidth

RESULT: **Passed**

Test standard : FCC part 15.247(d)
Basic standard : ANSI C63.10 (2013), KDB558074
Limit : 20dB (below that in the 100kHz bandwidth within the band that contains the highest level of the desired power)
Kind of test site : Shielded room

Test setup

Test Channel : Low/ Middle/ High for Conducted Spurious Emissions
Low/ High for Frequency Band Edge
Operation Mode : A
Ambient temperature : 20-24°C
Relative humidity : 50-65%
Atmospheric pressure : 100-103 kPa

All emissions are more than 20dB below fundamental, details refer to following test plot, and compliance is achieved as well.

Due to the small size of the product and that there are no inductive components of significant size, 9kHz to 30MHz frequency range is not tested based on technical judgment.

Test Plot 100kHz RBW of Band Edge

Low Channel

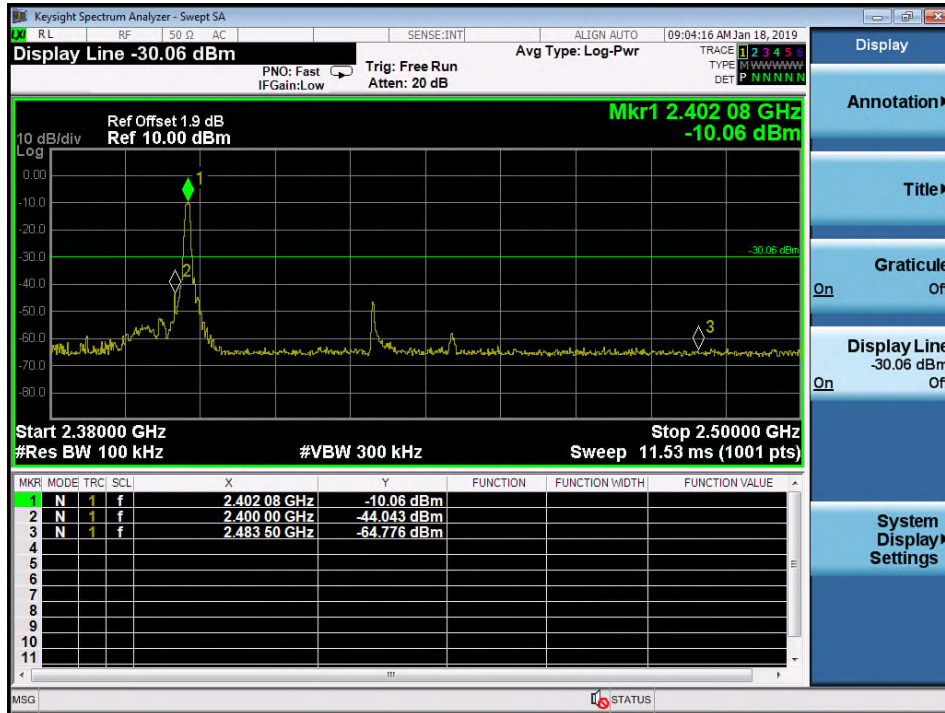

High Channel

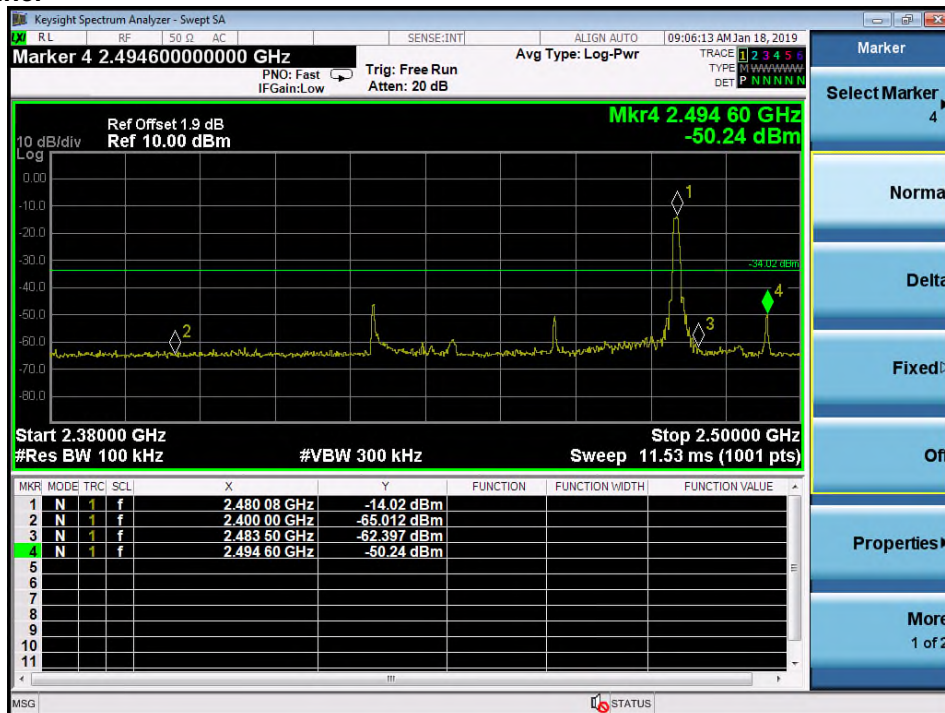

5.1.6 Spurious Emission

RESULT:**Passed**

Test standard : FCC part 15.247(d), FCC 15.205, FCC 15.209
Basic standard : ANSI C63.10 (2013)
Limits : Radiated emissions which fall in the restricted bands, as defined in FCC 15.205(a) and RSS-Gen i5, 8.10 (Table 7), must comply with the radiated emission limits specified in FCC 15.209(a) and RSS-Gen 5, 8.9 (Table 5 and 6). Emission radiated outside the restricted and authorized frequency bands must either comply with the radiated emission limits specified for the restricted bands or in FCC15.247(d) and RSS-247 i2, 5.5

Kind of test site : 3m Semi-Anechoic Chamber

Test setup

Test Channel : Low/ Middle/ High
Operation mode : A,B

Factor (dB/m)=Antenna Factor(dB/m)+Cable loss (dB)
Level(dBuV/m)=Reading(dBuV)+ Factor(dB/m)

Testing was carried out within frequency range 9kHz to the tenth harmonic. For details refer to Appendix D. The Radiated Emissions testing was performed in the X, Y and Z axis orientation. The worst-case Axis orientation is recorded in this test report.

5.2 Mains Emissions

5.2.1 Mains Conducted Emissions

RESULT:**Passed**

Test standard : FCC Part 15.207
FCC Part 15.107

Limits : Mains Conducted emissions as defined in
above test standards must comply with the
mains conducted emission limits specified

Kind of test site : Shielded Room

Test setup

Operation mode : C

Factor (dB/m)=Antenna Factor(dB/m)+Cable loss (dB)
Level(dBuV/m)=Reading(dBuV)+ Factor(dB/m)

Remark: For details refer to Appendix D.

6. Safety Human exposure

6.1 Radio Frequency Exposure Compliance

6.1.1 Electromagnetic Fields

RESULT:**Passed**

Test standard : FCC KDB Publication 447498 D01 v06

FCC:

Since maximum peak output power of the transmitter is $0.0964\text{mW} < 10\text{mW}$, hence the EUT is excluded from SAR evaluation according to FCC KDB publication 447498: Mobile Portable RF Exposure

7. Photographs of the Test Set-Up

Photograph 1: Set-up for Spurious Emissions (Front View)



Photograph 2: Set-up for Spurious Emissions (Back View 1)

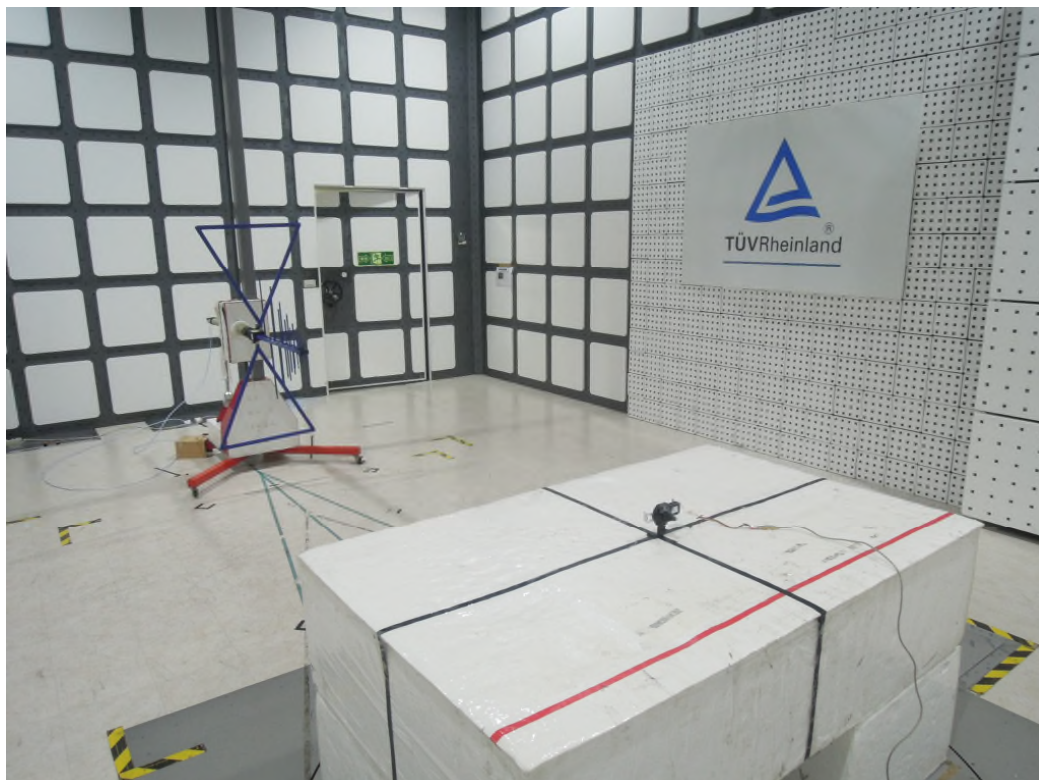

Photograph 3: Set-up for Spurious Emissions (Back View 2)

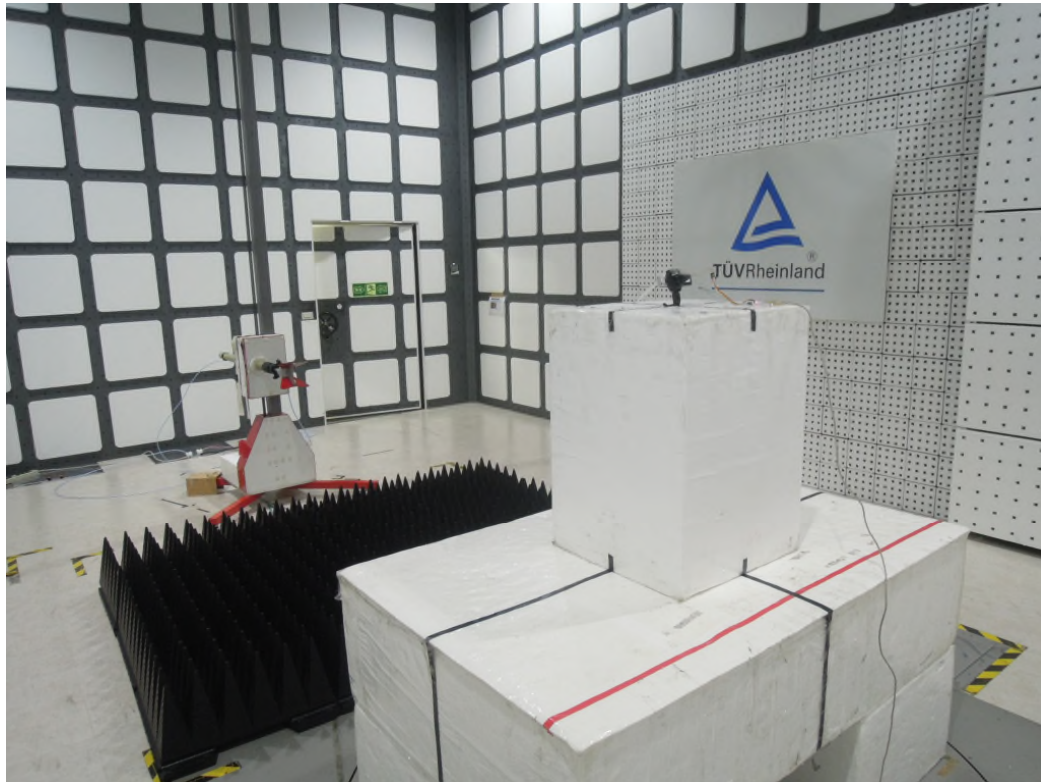

Photograph 4: Set-up for Conducted testing

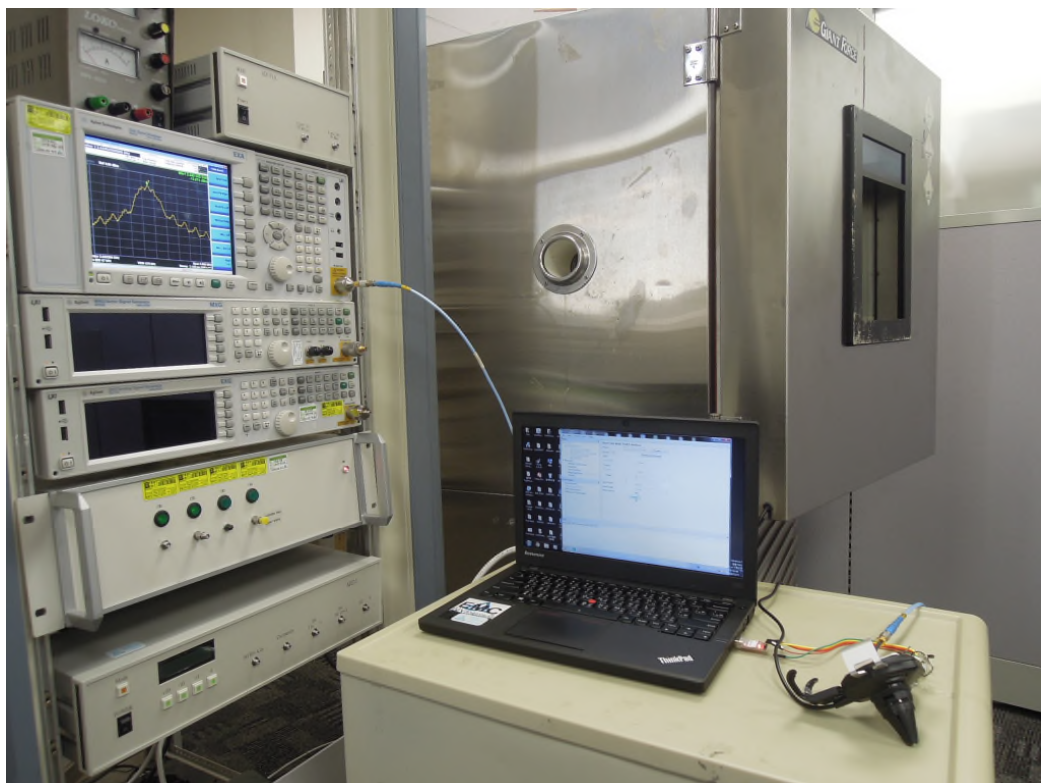

Photograph 5: Set-up for Spurious Emissions, AC Mains (Front View)



Photograph 6: Set-up for Spurious Emissions, AC Mains (Back View)

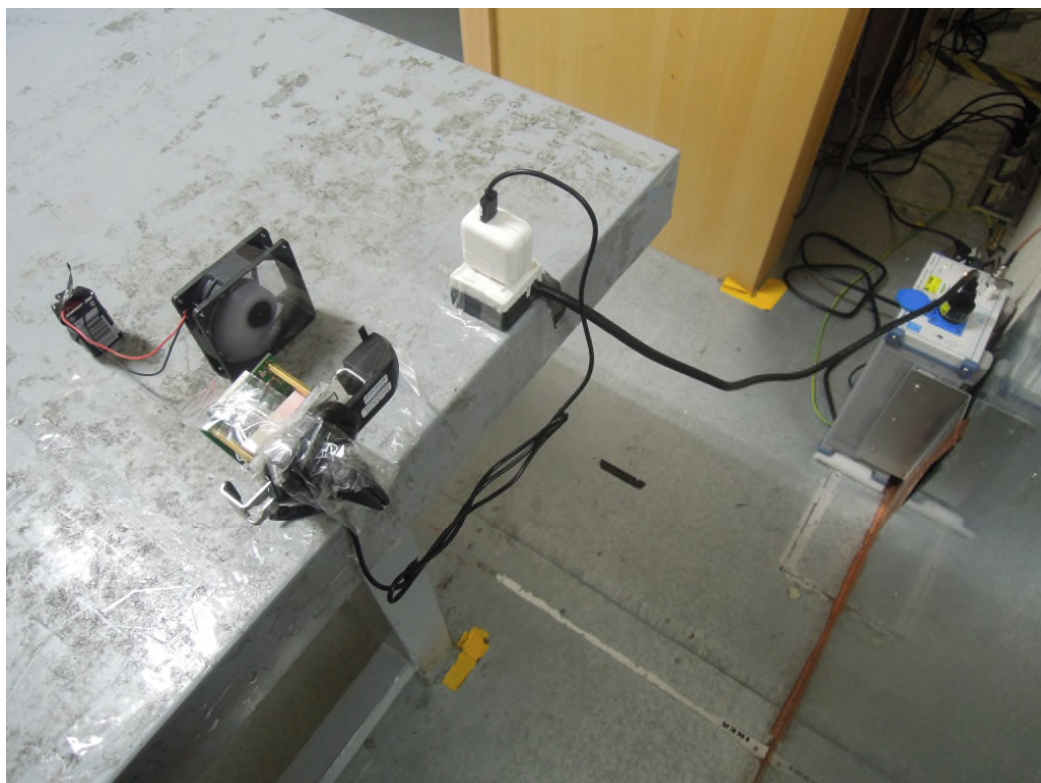

8. List of Tables

Table 1: Applied Standard and Test Levels	5
Table 2: List of Test and Measurement Equipment	7
Table 3: Emission Measurement Uncertainty.....	8
Table 4: Basic Information of EUT	9
Table 5: Technical Specification of EUT	9
Table 6: Test result of Peak Output Power	15
Table 7: Test result of 6dB Bandwidth	16
Table 8: Test result of Power Density	19

9. List of Photographs

Photograph 1: Set-up for Spurious Emissions (Front View).....	29
Photograph 2: Set-up for Spurious Emissions (Back View 1)	29
Photograph 3: Set-up for Spurious Emissions (Back View 2)	30
Photograph 4: Set-up for Conducted testing	30
Photograph 5: Set-up for Spurious Emissions, AC Mains (Front View)	31
Photograph 6: Set-up for Spurious Emissions, AC Mains (Back View)	31