

FCC Radio Test Report



FCC ID: 2APBP-CS30

Original Grant

Report No. : TB-FCC179357
Applicant : Ciontek Technology Corp.
Equipment Under Test (EUT)
EUT Name : Handheld Smart POS
Model No. : CS30
Series Model No. : CS30PRO, CS30LITE, CS30S, CS30V, CS30MINI, CS30A, CS30C, CS31, CS32
Brand Name : Ciontek
Sample ID : 20200916-08-01#& 20200916-08-02#
Receipt Date : 2021-03-22
Test Date : 2021-03-23 to 2021-05-25
Issue Date : 2021-05-28
Standards : 47 CFR Part 2, 22(H), 24(E), 27
Test Method : ANSI C63.26 2015
Conclusions : **PASS**

In the configuration tested, the EUT complied with the standards specified above,

The EUT technically complies with the FCC requirements

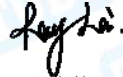
Test/Witness Engineer : 
Engineer Supervisor : 
Engineer Manager : 



This report details the results of the testing carried out on one sample. The results contained in this test report do not relate to other samples of the same product. The manufacturer should ensure that all products in series production are in conformity with the product sample detailed in the report.

Contents

| | |
|---|-----------|
| CONTENTS | 2 |
| 1. GENERAL INFORMATION ABOUT EUT | 5 |
| 1.1 Client Information..... | 5 |
| 1.2 General Description of EUT (Equipment Under Test) | 5 |
| 1.3 Block Diagram Showing the Configuration of System Tested..... | 9 |
| 1.4 Description of Support Units | 9 |
| 1.5 Description of Test Mode..... | 10 |
| 1.6 Measurement Uncertainty | 11 |
| 1.7 Test Facility..... | 12 |
| 2. TEST SUMMARY | 13 |
| 3. TEST EQUIPMENT | 14 |
| 4. CONDUCTED RF OUTPUT POWER | 15 |
| 4.1 Test Standard and Limit..... | 15 |
| 4.2 Test Setup..... | 15 |
| 4.3 Test Procedure..... | 15 |
| 4.4 EUT Operating Condition | 15 |
| 4.5 Deviation From Test Standard..... | 15 |
| 4.6 Test Data..... | 15 |
| 5. PEAK-AVERAGE RATIO | 16 |
| 5.1 Test Standard and Limit..... | 16 |
| 5.2 Test Setup..... | 16 |
| 5.3 Test Procedure..... | 16 |
| 5.4 EUT Operating Condition | 16 |
| 5.5 Deviation From Test Standard..... | 16 |
| 5.6 Test Data..... | 16 |
| 6. OCCUPIED BANDWIDTH | 17 |
| 6.1 Test Standard and Limit..... | 17 |
| 6.2 Test Setup..... | 17 |
| 6.3 Test Procedure..... | 17 |
| 6.4 EUT Operating Condition | 18 |
| 6.5 Deviation From Test Standard..... | 18 |
| 6.6 Test Data..... | 18 |
| 7. OUT OF BAND EMISSION AT ANTENNA TERMINALS | 19 |
| 7.1 Test Standard and Limit..... | 19 |
| 7.2 Test Setup..... | 19 |
| 7.3 Test Procedure..... | 20 |
| 7.4 EUT Operating Condition | 20 |
| 7.5 Deviation From Test Standard..... | 20 |
| 7.6 Test Data..... | 20 |
| 8. BAND EDGE TEST | 21 |
| 8.1 Test Standard and Limit..... | 21 |

| | |
|--|------------|
| 8.2 Test Setup..... | 21 |
| 8.3 Test Procedure..... | 21 |
| 8.4 EUT Operating Condition | 22 |
| 8.5 Deviation From Test Standard..... | 22 |
| 8.6 Test Data..... | 22 |
| 9. RADIATED OUTPUT POWER | 23 |
| 9.1 Test Standard and Limit..... | 23 |
| 9.2 Test Setup..... | 23 |
| 9.3 Test Procedure..... | 24 |
| 9.4 EUT Operating Condition | 24 |
| 9.5 Deviation From Test Standard..... | 24 |
| 9.6 Test Data..... | 24 |
| 10. RADIATED OUT BAND OF EMISSIONS..... | 25 |
| 10.1 Test Standard and Limit | 25 |
| 10.2 Test Setup..... | 25 |
| 10.3 Test Procedure..... | 25 |
| 10.4 EUT Operating Condition | 26 |
| 10.5 Deviation From Test Standard..... | 26 |
| 10.6 Test Data..... | 26 |
| 11. FREQUENCY STABILITY | 27 |
| 11.1 Test Standard and Limit | 27 |
| 11.2 Test Setup..... | 27 |
| 11.3 Test Procedure..... | 28 |
| 11.4 EUT Operating Condition | 28 |
| 11.5 Deviation From Test Standard..... | 28 |
| 11.6 Test Data..... | 28 |
| ATTACHMENT A--CONDUCTED RF OUTPUT POWER | 29 |
| ATTACHMENT B--PEAK-AVERAGE RATIO | 54 |
| ATTACHMENT C--OCCUPY BANDWIDTH | 119 |
| ATTACHMENT D--OUT OF BAND EMISSION AT ANTENNA TERMINALS | 167 |
| ATTACHMENT E--BAND EDGE TEST | 287 |
| ATTACHMENT F--RADIATED OUTPUT POWER | 347 |
| ATTACHMENT G--RADIATED OUT BAND OF EMISSIONS | 358 |
| ATTACHMENT H--FREQUENCY STABILITY | 361 |

1. General Information about EUT

1.1 Client Information

| | | |
|---------------------|---|--|
| Applicant | : | Ciontek Technology Corp. |
| Address | : | B501, Chanxueyan Building Wuhan University, No.6 Of Yuexing 2nd Road, Yuehai Street, Nanshan District, Shenzhen, China |
| Manufacturer | : | Ciontek Technology Corp. |
| Address | : | B501, Chanxueyan Building Wuhan University, No.6 Of Yuexing 2nd Road, Yuehai Street, Nanshan District, Shenzhen, China |

1.2 General Description of EUT (Equipment Under Test)

| | | |
|-------------------------------|---|---|
| EUT Name | : | Handheld Smart POS |
| Models No. | : | CS30, CS30PRO, CS30LITE, CS30S, CS30V, CS30MINI, CS30A, CS30C, CS31, CS32 |
| Model Difference | : | All these models are identical in the same PCB, layout and electrical circuit, The only difference is appearance color. |
| Product Description | : | Frequency Bands: LTE Band 2:TX: 1850MHz-1910MHz, RX: 1930MHz-1990MHz LTE Band 4:TX: 1710MHz-1755MHz, RX: 2110MHz-2155MHz LTE Band 5:TX: 824MHz-849MHz, RX: 869MHz-894MHz LTE Band 12: TX: 699MHz -716MHz, RX: 729MHz-746MHz LTE Band 17: TX: 704MHz -716MHz, RX: 734MHz-746MHz |
| | : | Antenna Type: 0.75dBi PIFA Antenna |
| | : | Modulation Type: QPSK, 16QAM |
| | : | Bandwidth: LTE Band 2 :1.4MHz/3MHz/5MHz/10MHz/15MHz/20MHz LTE Band 4 :1.4MHz/3MHz/5MHz/10MHz/15MHz/20MHz LTE Band 5 :1.4MHz/3MHz/5MHz/10MHz LTE Band 12 :1.4MHz/3MHz/5MHz/10MHz LTE Band 17 : 5MHz/10MHz |
| Power Rating | : | Adapter(XS12-050200U) Input: 100-240V~, 50/60Hz, 0.5A Output: DC5V2A |
| Li-ion Polymer Battery | : | 7.6V, 2600mAh, 19.76Wh |
| Software Version | : | a51_v0.01_20210316c |
| Hardware Version | : | CS30HWV2.0 |
| Remark | : | The antenna gain and adapter provided by the applicant, the verified for the RF conduction test provided by TOBY test lab. |

Note:

- (1) For a more detailed features description, please refer to the manufacturer's specifications or the User's Manual.

(2) Channel List

| LTE Band 2(1.4MHz) | | LTE Band 2(3MHz) | |
|--------------------|-----------------|-------------------|-----------------|
| Channel | Frequency (MHz) | Channel | Frequency (MHz) |
| 18607 | 1850.70 | 18615 | 1851.50 |
| 18608 | 1850.80 | 18616 | 1851.60 |
| | | | |
| 18899 | 1879.90 | 18899 | 1879.90 |
| 18900 | 1880.00 | 18900 | 1880.00 |
| 18901 | 1880.10 | 18901 | 1880.10 |
| | | | |
| 19192 | 1909.20 | 19184 | 1905.40 |
| 19193 | 1909.30 | 19185 | 1908.50 |
| LTE Band 2(5MHz) | | LTE Band 2(10MHz) | |
| Channel | Frequency (MHz) | Channel | Frequency (MHz) |
| 18625 | 1852.50 | 18650 | 1855.00 |
| 18616 | 1853.60 | 18626 | 1854.90 |
| | | | |
| 18899 | 1879.90 | 18899 | 1879.90 |
| 18900 | 1880.00 | 18900 | 1880.00 |
| 18901 | 1880.10 | 18901 | 1880.10 |
| | | | |
| 19174 | 1908.40 | 19149 | 1907.90 |
| 19175 | 1907.50 | 19150 | 1905.00 |
| LTE Band 2(15MHz) | | LTE Band 2(20MHz) | |
| Channel | Frequency (MHz) | Channel | Frequency (MHz) |
| 18675 | 1857.50 | 18700 | 1860.00 |
| 18676 | 1857.60 | 18701 | 1860.10 |
| | | | |
| 18899 | 1879.90 | 18899 | 1879.90 |
| 18900 | 1880.00 | 18900 | 1880.00 |
| 18901 | 1880.10 | 18901 | 1880.10 |
| | | | |
| 19124 | 1902.40 | 19099 | 1899.90 |
| 19125 | 1902.50 | 19100 | 1900.00 |
| LTE Band 4(1.4MHz) | | LTE Band 4(3MHz) | |
| Channel | Frequency (MHz) | Channel | Frequency (MHz) |
| 19957 | 1710.70 | 19965 | 1711.50 |
| 19958 | 1710.80 | 19966 | 1711.60 |
| | | | |
| 20174 | 1732.40 | 20174 | 1732.40 |
| 20175 | 1732.50 | 20175 | 1732.50 |
| 20176 | 1732.60 | 20176 | 1732.60 |
| | | | |

| | | | |
|---------------------------|------------------------|--------------------------|------------------------|
| 20392 | 1754.20 | 20384 | 1753.40 |
| 20393 | 1754.30 | 20385 | 1753.50 |
| LTE Band 4(5MHz) | | LTE Band 4(10MHz) | |
| Channel | Frequency (MHz) | Channel | Frequency (MHz) |
| 19975 | 1712.50 | 20000 | 1715.00 |
| 19976 | 1712.60 | 20001 | 1715.10 |
| | | | |
| 20174 | 1732.40 | 20174 | 1732.40 |
| 20175 | 1732.50 | 20175 | 1732.50 |
| 20176 | 1732.60 | 20176 | 1732.60 |
| | | | |
| 20374 | 1752.40 | 20349 | 1749.90 |
| 20375 | 1752.50 | 20350 | 1750.00 |
| LTE Band 4(15MHz) | | LTE Band 4(20MHz) | |
| Channel | Frequency (MHz) | Channel | Frequency (MHz) |
| 20025 | 1717.50 | 20050 | 1720.00 |
| 20026 | 1717.60 | 20051 | 1720.10 |
| | | | |
| 20174 | 1732.40 | 20174 | 1732.40 |
| 20175 | 1732.50 | 20175 | 1732.50 |
| 20176 | 1732.60 | 20176 | 1732.60 |
| | | | |
| 20324 | 1747.40 | 20299 | 1744.90 |
| 20325 | 1747.50 | 20300 | 1745.00 |
| LTE Band 5(1.4MHz) | | LTE Band 5(3MHz) | |
| Channel | Frequency (MHz) | Channel | Frequency (MHz) |
| 20407 | 824.70 | 20415 | 825.50 |
| 20408 | 824.80 | 20416 | 825.60 |
| | | | |
| 20524 | 836.40 | 20524 | 836.40 |
| 20525 | 836.50 | 20525 | 836.50 |
| 20526 | 836.60 | 20526 | 836.60 |
| | | | |
| 20643 | 848.20 | 20634 | 847.40 |
| 20643 | 848.30 | 20635 | 847.50 |
| LTE Band 5(5MHz) | | LTE Band 5(10MHz) | |
| Channel | Frequency (MHz) | Channel | Frequency (MHz) |
| 20425 | 826.50 | 20450 | 829.00 |
| 20426 | 826.60 | 20451 | 829.10 |
| | | | |
| 20524 | 836.40 | 20524 | 836.40 |
| 20525 | 836.50 | 20525 | 836.50 |
| 20526 | 836.60 | 20526 | 836.60 |
| | | | |

| | | | |
|----------------------------|------------------------|---------------------------|------------------------|
| 20624 | 846.40 | 20599 | 843.90 |
| 20625 | 846.50 | 20600 | 844.00 |
| LTE Band 12(1.4MHz) | | LTE Band 12(3MHz) | |
| Channel | Frequency (MHz) | Channel | Frequency (MHz) |
| 23017 | 699.70 | 23025 | 700.50 |
| 23018 | 699.80 | 23026 | 700.60 |
| | | | |
| 23094 | 707.40 | 23094 | 707.40 |
| 23095 | 707.50 | 23095 | 707.50 |
| 23096 | 707.60 | 23096 | 707.60 |
| | | | |
| 23172 | 715.20 | 23164 | 714.30 |
| 23173 | 715.30 | 23165 | 714.40 |
| LTE Band 12(5MHz) | | LTE Band 12(10MHz) | |
| Channel | Frequency (MHz) | Channel | Frequency (MHz) |
| 23035 | 701.50 | 23060 | 704.00 |
| 23036 | 701.40 | 23061 | 703.90 |
| | | | |
| 23094 | 707.40 | 23094 | 707.40 |
| 23095 | 707.50 | 23095 | 707.50 |
| 23096 | 707.60 | 23096 | 707.60 |
| | | | |
| 23156 | 713.40 | 23129 | 710.90 |
| 23155 | 713.50 | 23130 | 711.00 |
| LTE Band 17(5MHz) | | LTE Band 17(10MHz) | |
| Channel | Frequency (MHz) | Channel | Frequency (MHz) |
| 23755 | 706.50 | 23780 | 709.00 |
| 23756 | 706.60 | 23781 | 709.10 |
| | | | |
| 23789 | 709.90 | 23789 | 709.90 |
| 23790 | 710.00 | 23790 | 710.00 |
| 23791 | 710.10 | 23791 | 710.10 |
| | | | |
| 23524 | 713.40 | 23799 | 710.90 |
| 23825 | 713.50 | 23800 | 711.00 |

1.3 Block Diagram Showing the Configuration of System Tested

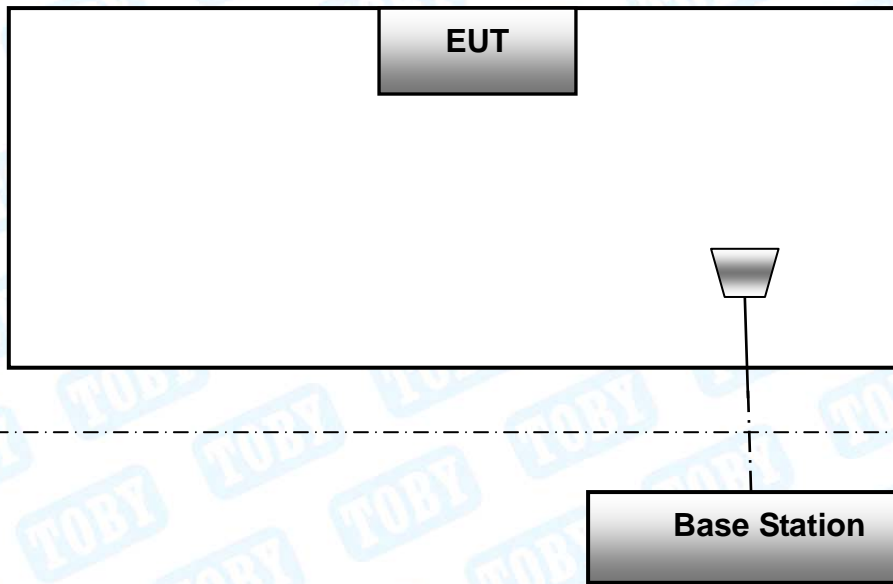

The above block diagram of setup is the normal mode. And more detail please refer to the test setup of each test item of bellow.

1.4 Description of Support Units

The EUT has been tested as an independent unit.

1.5 Description of Test Mode

Antenna port conducted and radiated test items listed below are performed according to KDB 971168 D01 v03r01 and ANSI C63.26 2015 Power Meas. License Digital Systems with maximum output power. Radiated measurements are performed by rotating the EUT in three different ortho-gonal test planes to find the maximum emission.

Remark:

1. The mark “v “ means that this configuration is chosen for testing
2. The mark “--“ means that this bandwidth is not supported.
3. The device is investigated from 30MHz to 10 times of fundamental signal for radiated

| ITEMS | Band | Bandwidth (MHz) | | | | | | Modulation | | RB # | | | Test Channel | | |
|---|------|-----------------|----|----|----|----|----|------------|-------|------|------|------|--------------|---|---|
| | | 1.4 | 3 | 5 | 10 | 15 | 20 | QPSK | 16QAM | 1 | Half | Full | L | M | H |
| RF Output Power | 2 | V | V | V | V | V | V | V | V | V | V | V | V | V | V |
| | 4 | V | V | V | V | V | V | V | V | V | V | V | V | V | V |
| | 5 | V | V | V | V | -- | -- | V | V | V | V | V | V | V | V |
| | 12 | V | V | V | V | -- | -- | V | V | V | V | V | V | V | V |
| | 17 | -- | -- | V | V | -- | -- | V | V | V | V | V | V | V | V |
| Peak-to-Average Ratio | 2 | -- | -- | -- | -- | -- | V | V | V | V | | V | V | V | V |
| | 4 | -- | -- | -- | -- | -- | V | V | V | V | | V | V | V | V |
| | 5 | -- | -- | -- | V | -- | -- | V | V | V | | V | V | V | V |
| | 12 | -- | -- | -- | V | -- | -- | V | V | V | | V | V | V | V |
| | 17 | -- | -- | -- | V | -- | -- | V | V | V | | V | V | V | V |
| 99% & -26 dB Occupied Bandwidth | 2 | V | V | V | V | V | V | V | V | V | | | V | V | V |
| | 4 | V | V | V | V | V | V | V | V | V | | | V | V | V |
| | 5 | V | V | V | V | -- | -- | V | V | V | | | V | V | V |
| | 12 | V | V | V | V | -- | -- | V | V | V | | | V | V | V |
| | 17 | -- | -- | V | V | -- | -- | V | V | V | | | V | V | V |
| Spurious Emissions at Antenna Terminal | 2 | V | V | V | V | V | V | V | V | V | | V | V | V | V |
| | 4 | V | V | V | V | V | V | V | V | V | | V | V | V | V |
| | 5 | V | V | V | V | -- | -- | V | V | V | | V | V | V | V |
| | 12 | V | V | V | V | -- | -- | V | V | V | | V | V | V | V |
| | 17 | -- | -- | V | V | -- | -- | V | V | V | | V | V | V | V |
| Field Strength of Spurious Radiation | 2 | -- | -- | -- | -- | -- | V | V | -- | V | | | | V | |
| | 4 | -- | -- | -- | -- | -- | V | V | -- | V | | | | V | |
| | 5 | -- | -- | -- | V | -- | -- | V | -- | V | | | | V | |
| | 12 | -- | -- | -- | V | -- | -- | V | -- | V | | | | V | |
| | 17 | -- | -- | -- | V | -- | -- | V | -- | V | | | | V | |

| | | | | | | | | | | | | | | |
|-----------------------------------|----|----|----|---|---|----|----|---|---|---|---|---|---|---|
| Out of band emission Band Edge | 2 | V | V | V | V | V | V | V | V | V | V | V | V | V |
| | 4 | V | V | V | V | V | V | V | V | V | V | V | V | V |
| | 5 | V | V | V | V | -- | -- | V | V | V | V | V | V | V |
| | 12 | V | V | V | V | -- | -- | V | V | V | V | V | V | V |
| | 17 | -- | -- | V | V | -- | -- | V | V | V | V | V | V | V |
| Frequency stability | 2 | V | V | V | V | V | V | V | V | V | V | V | V | V |
| | 4 | V | V | V | V | V | V | V | V | V | V | V | V | V |
| | 5 | V | V | V | V | -- | -- | V | V | V | V | V | V | V |
| | 12 | V | V | V | V | -- | -- | V | V | V | V | V | V | V |
| | 17 | -- | -- | V | V | -- | -- | V | V | V | V | V | V | V |

Note: (1) During the testing procedure, the EUT is in link mode with base station emulator at maximum power level in each test mode.

(2) The EUT is considered a portable unit; it was pre-tested on the positioned of each 3 axis, X-plane, Y-plane and Z-plane. The worst case was found positioned on Z-plane as the normal use. Therefore only the test data of this Z-plane was used for radiated emission measurement test.

1.6 Measurement Uncertainty

| Test Item | Parameters | Expanded Uncertainty (U _{Lab}) |
|---------------------|--------------------------------------|--|
| RF Power, conducted | / | ±0.82 dB |
| Radiated Emission | Level Accuracy: 9kHz to 30 MHz | ±4.60 dB |
| Radiated Emission | Level Accuracy: 30MHz to 1000 MHz | ±4.40 dB |
| Radiated Emission | Level Accuracy: Above 1000MHz | ±4.20 dB |

1.7 Test Facility

The testing report were performed by the Shenzhen Toby Technology Co., Ltd., in their facilities located at 1A/F., Bldg.6, Yusheng Industrial Zone, The National Road No.107 Xixiang Section 467, Xixiang, Bao'an, Shenzhen, Guangdong, China. At the time of testing, the following bodies accredited the Laboratory:

CNAS (L5813)

The Laboratory has been accredited by CNAS to ISO/IEC 17025: 2017 General Requirements for the Competence of Testing and Calibration Laboratories for the competence in the field of testing. And the Registration No.: CNAS L5813.

A2LA Certificate No.: 4750.01

The laboratory has been accredited by American Association for Laboratory Accreditation(A2LA) to ISO/IEC 17025: 2017 General Requirements for the Competence of Testing and Calibration Laboratories for the technical competence in the field of Electrical Testing. And the A2LA Certificate No.: 4750.01.FCC Accredited Test Site Number: 854351.

IC Registration No.: (11950A)

The Laboratory has been registered by Certification and Engineering Bureau of Industry Canada for radio equipment testing. The site registration: Site# 11950A. CAB identifier: CN0056.

2. Test Summary

| Test Item | Section in CFR 47 | Result |
|--|--|-------------|
| RF Output Power | Part 2.1046 Part 22.913(a)(2) Part 24.232(c) Part 27.50 (b)(10) Part 27.50 (d)(4) Part 27.50 (h)(2) | PASS |
| Peak-to-Average Ratio | Part 24.232(d) Part 27.50(d)(5) | PASS |
| 99% & -26 dB Occupied Bandwidth | Part 2.1049 Part 22.917(a) Part 24.238(b) Part 27.53(h) Part 27.53(m) | PASS |
| Spurious Emissions at Antenna Terminal | Part 2.1051 Part 24.238(a) Part 27.53 (h) Part 27.53(m) | PASS |
| Field Strength of Spurious Radiation | Part 2.1053 Part 22.917(a) Part 24.238(a) Part 27.53 (h) Part 27.53(m) | PASS |
| Out of band emission, Band Edge | Part 24.238(a) Part 22.917(a) Part 27.53 (h) Part 27.53(m) | PASS |
| Frequency stability vs. temperature | Part 27.54 Part 24.235 Part 22.355 Part 2.1055(a)(1)(b) | PASS |
| Frequency stability vs. voltage | Part 27.54 Part 24.235 Part 22.355 Part 2.1055(d)(2) | PASS |

Pass: The EUT complies with the essential requirements in the standard.

3. Test Equipment

| Radiation Emission Test | | | | | |
|---|--------------------|-------------------|---------------|---------------|---------------|
| Equipment | Manufacturer | Model No. | Serial No. | Last Cal. | Cal. Due Date |
| Spectrum Analyzer | Agilent | E4407B | MY45106456 | Jul. 06, 2020 | Jul. 05, 2021 |
| EMI Test Receiver | Rohde & Schwarz | ESPI | 100010/007 | Jul. 06, 2020 | Jul. 05, 2021 |
| Spectrum Analyzer | Rohde & Schwarz | FSV40-N | 102197 | Jul. 06, 2020 | Jul. 05, 2021 |
| Wideband Radio Communication Tester | Rohde & Schwarz | CMW500 | 144382 | Sep. 11, 2020 | Sep. 10, 2021 |
| Universal Radio Communication Tester | Rohde&Schwarz | CMU200 | 103903 | Jul. 06, 2020 | Jul. 05, 2021 |
| Bilog Antenna | ETS-LINDGREN | 3142E | 00117537 | Mar.01, 2020 | Feb. 28, 2022 |
| Horn Antenna | ETS-LINDGREN | 3117 | 00143207 | Mar.01, 2020 | Feb. 28, 2022 |
| Horn Antenna | ETS-LINDGREN | BBHA 9170 | BBHA9170582 | Mar.01, 2020 | Feb. 28, 2022 |
| Loop Antenna | SCHWARZBECK | FMZB 1519 B | 1519B-059 | Jul. 07, 2020 | Jul. 06, 2021 |
| Pre-amplifier | Sonoma | 310N | 185903 | Feb. 25, 2021 | Feb. 24, 2022 |
| Pre-amplifier | HP | 8449B | 3008A00849 | Feb. 25, 2021 | Feb. 24, 2022 |
| Pre-amplifier | SKET | LNPA_1840G-50 | SK201904032 | Feb. 25, 2021 | Feb. 24, 2022 |
| Cable | HUBER+SUHNER | 100 | SUCOFLEX | Feb. 25, 2021 | Feb. 24, 2022 |
| Positioning Controller | ETS-LINDGREN | 2090 | N/A | N/A | N/A |
| Antenna Conducted Emission | | | | | |
| Equipment | Manufacturer | Model No. | Serial No. | Last Cal. | Cal. Due Date |
| Spectrum Analyzer | Agilent | E4407B | MY45106456 | Jul. 06, 2020 | Jul. 05, 2021 |
| Wideband Radio Communication Tester | Rohde & Schwarz | CMW500 | 144382 | Sep. 11, 2020 | Sep. 10, 2021 |
| Universal Radio Communication Tester | Rohde&Schwarz | CMU200 | 103903 | Jul. 06, 2020 | Jul. 05, 2021 |
| Spectrum Analyzer | Rohde & Schwarz | ESPI | 100010/007 | Jul. 06, 2020 | Jul. 05, 2021 |
| MXA Signal Analyzer | Agilent | N9020A | MY49100060 | Sep. 11, 2020 | Sep. 10, 2021 |
| Vector Signal Generator | Agilent | N5182A | MY50141294 | Sep. 11, 2020 | Sep. 10, 2021 |
| Analog Signal Generator | Agilent | N5181A | MY50141953 | Sep. 11, 2020 | Sep. 10, 2021 |
| RF Power Sensor | DARE!! Instruments | RadiPowerRPR3006W | 17I00015SNO26 | Sep. 11, 2020 | Sep. 10, 2021 |
| | DARE!! Instruments | RadiPowerRPR3006W | 17I00015SNO29 | Sep. 11, 2020 | Sep. 10, 2021 |
| | DARE!! Instruments | RadiPowerRPR3006W | 17I00015SNO31 | Sep. 11, 2020 | Sep. 10, 2021 |
| | DARE!! Instruments | RadiPowerRPR3006W | 17I00015SNO33 | Sep. 11, 2020 | Sep. 10, 2021 |

4. Conducted RF Output Power

4.1 Test Standard and Limit

4.1.1 Test Standard

FCC part 2.1046, FCC part 22.913(a)(2),
FCC part 24.232(c), FCC Part 27.50(b)&(d),
FCC Part 27.50 (h)

4.2 Test Setup

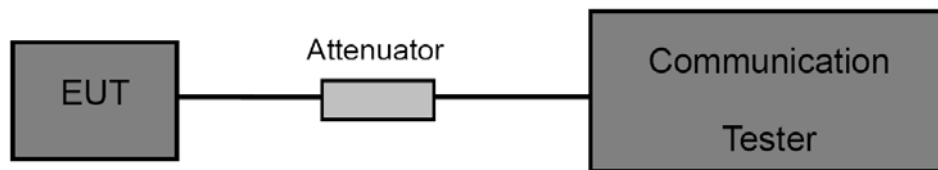

4.3 Test Procedure

- (1) The EUT is coupled to the Base Station with the suitable Attenuator, the path loss is calibrated to correct the reading.
- (2) A call is set up by the Base Station to the generic call set up procedure.
- (3) Set EUT at maximum power level through base station by power level command.
- (4) Then read record the power value from the Base Station in dBm.

4.4 EUT Operating Condition

The EUT was continuously connected with the Base station and transmitting in the max power during the test.

4.5 Deviation From Test Standard

No deviation

4.6 Test Data

Please refer to the Attachment A.

5. Peak-Average Ratio

5.1 Test Standard and Limit

5.1.1 Test Standard

FCC part 24.232(d)

FCC Part 27.50(d), FCC Part 27.50 (h)

5.1.2 Test Limit

Peak-to-Average Ratio

The peak-to-average ratio (PAR) of the transmission may not exceed 13 dB.

5.2 Test Setup

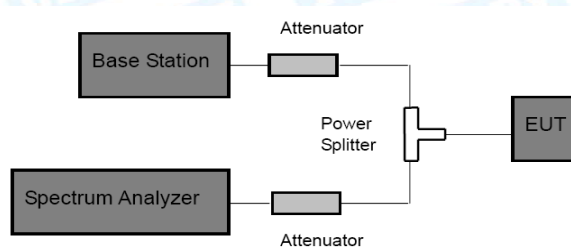

5.3 Test Procedure

According with KDB 971168

- (1) The signal analyzer's CCDF measurement profile is enabled.
- (2) Frequency = carrier center frequency.
- (3) Measurement BW > Emission bandwidth of signal.
- (4) The signal analyzer was set to collect one million samples to generate the CCDF curve.
- (5) Set the EUT working in highest power level, measured and recorded the 0.1% as PAPR level.
- (6) The measurement interval was set depending on the type of signal analyzed. For continuous signals (>98% duty cycle), the measurement interval was set to 1ms. For burst transmissions, the spectrum analyzer is set to use an internal "RF Burst" trigger that is synced with an incoming pulse and the measurement interval is set to less than the duration of the "on time" of one burst to ensure that energy is only captured during a time in which of the transmitter is operating at maximum power.

5.4 EUT Operating Condition

The EUT was continuously connected with the Base station and transmitting in the max power during the test.

5.5 Deviation From Test Standard

No deviation

5.6 Test Data

Please refer to the Attachment B.

6. Occupied Bandwidth

6.1 Test Standard and Limit

6.1.1 Test Standard

FCC Part 2: 2.1049, FCC Part 22.917(a),
FCC part 24.238(b)
FCC Part 27.53(h)
FCC Part 27.53(m)

6.1.2 Test Requirement

According to FCC section 2.1049, the occupied bandwidth is the frequency bandwidth such that below its lower and above its upper frequency limits, the mean powers radiated are each equal to 0.5 percent of the total mean power radiated by a given emission.

Occupied bandwidth is also known as 99% power and -26dBC occupied bandwidths.

6.2 Test Setup

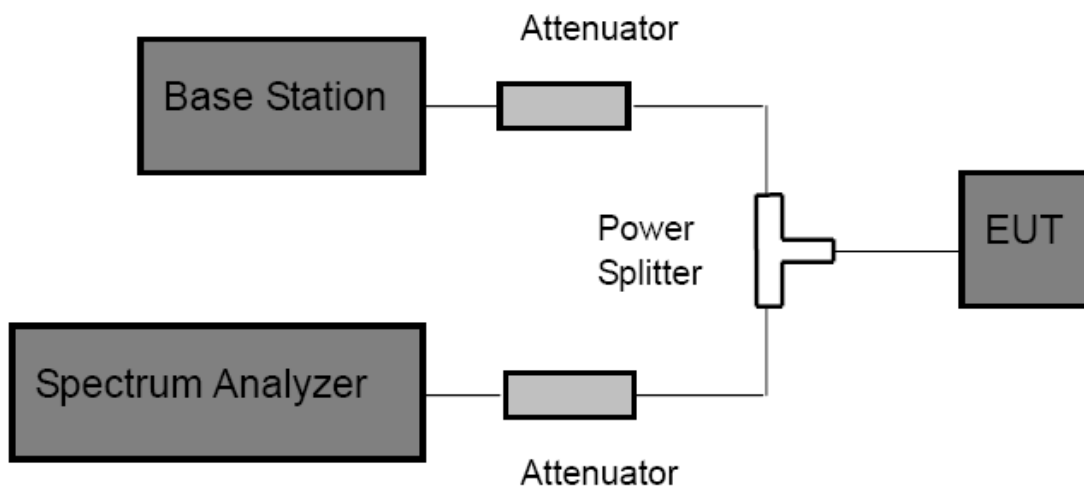

6.3 Test Procedure

- (1) The EUT was directly connected to the spectrum analyzer and Base station via power splitter as show in the block diagram above.
- (2) The resolution bandwidth of the Spectrum Analyzer is set to at least 1% of the occupied bandwidth. VBW= 3 times RBW.
- (3) The low, middle and the high channels are selected to perform tests respectively.
- (4) Set the frequency range of the Spectrum Analyzer suitably to capture the waveform; search peak; make a line whose value is 26dB lower than the peak; mark two points which the line intersected the waveform at; finally record the delta of the two points as the occupied bandwidth and the plot.
- (5) Set the Spectrum Analyzer Occupied bandwidth function to measure the 99% occupied bandwidth.

6.4 EUT Operating Condition

The EUT was continuously connected with the Base station and transmitting in the max power during the test.

6.5 Deviation From Test Standard

No deviation

6.6 Test Data

Please refer to the Attachment C.

7. Out of Band Emission at Antenna Terminals

7.1 Test Standard and Limit

7.1.1 Test Standard

FCC Part 2: 2.1051, 2.1057
FCC Part 22.917(a), FCC part 24.238(a)
FCC Part 27.53 (h), FCC Part 27.53(m)

7.1.2 Test Limit

Band 7: For mobile digital stations, the attenuation factor shall be not less than $40 + 10 \log (P)$ dB on all frequencies between the channel edge and 5 megahertz from the channel edge, $43 + 10 \log (P)$ dB on all frequencies between 5 megahertz and X megahertz from the channel edge, and $55 + 10 \log (P)$ dB on all frequencies more than X megahertz from the channel edge, where X is the greater of 6 megahertz or the actual emission bandwidth as defined in paragraph (m)(6) of this section. In addition, the attenuation factor shall not be less that $43 + 10 \log (P)$ dB on all frequencies between 2490.5 MHz and 2496 MHz and $55 + 10 \log (P)$ dB at or below 2490.5 MHz. The power of any emission outside of the authorized operating frequency ranges must be attenuated below the transmitting power(P) by a factor of at least $43 + 10 \log (P)$ dB. For all power levels +30 dBm to 0 dBm, this becomes a constant specification limit of -13 dBm.

7.2 Test Setup

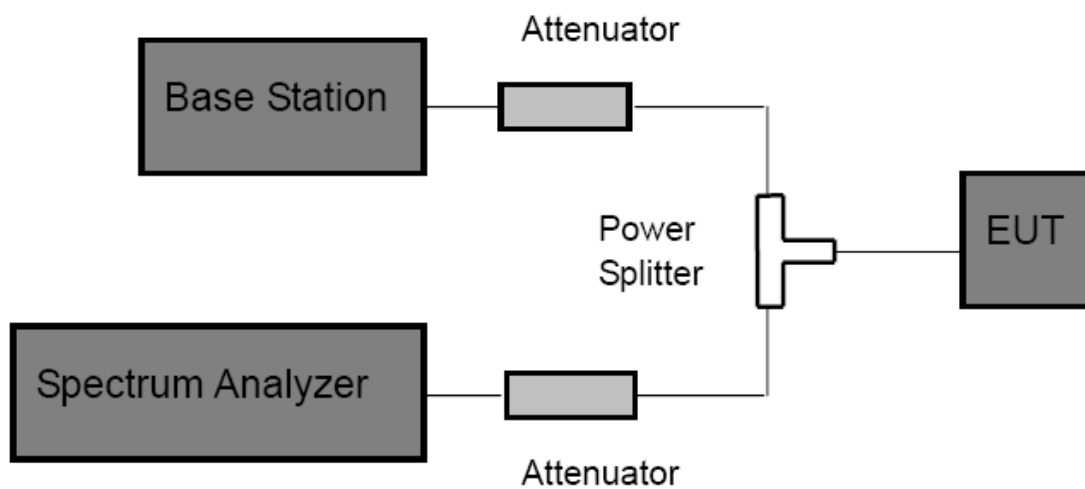

7.3 Test Procedure

- 1 The RF output of the transceiver was connected to a spectrum analyzer through appropriate attenuation.
- 2 The resolution bandwidth of the spectrum analyzer was set at 100 kHz when below 1GHz, 1MHz when above 1 GHz; sufficient scans were taken to show the out of band Emissions if any up to 10th harmonic.
- 3 For the out of band: Set the RBW=100 kHz, VBW=300 kHz when below 1 GHz, RBW =1 MHz, VBW=3 MHz when above 1 GHz, Start=30MHz, Stop= 10th harmonic.
- 4 Band Edge Requirements: In the 1 MHz bands immediately outside and adjacent to the frequency block, a resolution bandwidth of at least 1 percent of the emission bandwidth of the fundamental emission of the transmitter.

7.4 EUT Operating Condition

The EUT was continuously connected with the Base station and transmitting in the max power during the test.

7.5 Deviation From Test Standard

No deviation

7.6 Test Data

Please refer to the Attachment D.

8. Band Edge Test

8.1 Test Standard and Limit

8.1.1 Test Standard

FCC Part 2: 2.1051, 2.1057
FCC Part 22.917(a), FCC part 24.238(a)
FCC Part 27.53 (h), FCC Part 27.53(m)

8.1.2 Test Limit

Band 7: For mobile digital stations, the attenuation factor shall be not less than $40 + 10 \log (P)$ dB on all frequencies between the channel edge and 5 megahertz from the channel edge, $43 + 10 \log (P)$ dB on all frequencies between 5 megahertz and X megahertz from the channel edge, and $55 + 10 \log (P)$ dB on all frequencies more than X megahertz from the channel edge, where X is the greater of 6 megahertz or the actual emission bandwidth as defined in paragraph (m)(6) of this section. In addition, the attenuation factor shall not be less that $43 + 10 \log (P)$ dB on all frequencies between 2490.5 MHz and 2496 MHz and $55 + 10 \log (P)$ dB at or below 2490.5 MHz. The power of any emission outside of the authorized operating frequency ranges must be attenuated below the transmitting power(P) by a factor of at least $43+10\log(P)$ dB. For all power levels +30 dBm to 0 dBm, this becomes a constant specification limit of -13 dBm.

8.2 Test Setup

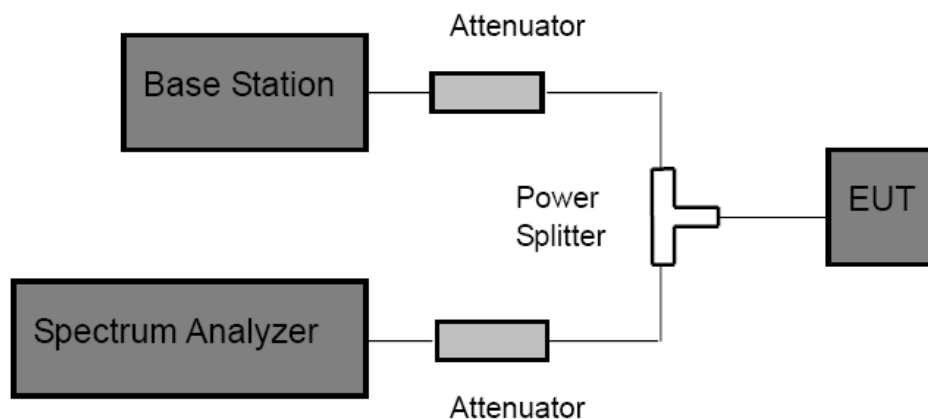

8.3 Test Procedure

- (1) The EUT was directly connected to the spectrum analyzer and Base station via power splitter as show in the block diagram above.
- (2) Band Edge Requirements: In the 1 MHz bands immediately outside and adjacent to the frequency block, a resolution bandwidth of at least 1 percent of the emission bandwidth of the fundamental emission of the transmitter.

8.4 EUT Operating Condition

The EUT was continuously connected with the Base station and transmitting in the max power during the test.

8.5 Deviation From Test Standard

No deviation

8.6 Test Data

Please refer to the Attachment E.

9. Radiated Output Power

9.1 Test Standard and Limit

9.1.1 Test Standard

FCC Part 2.1046, FCC Part 22.913(a)(2),
FCC part 24.232(c)
FCC part 27.50(c), FCC part 27.50(d)

9.1.2 Test Limit

| E.I.R.P | E.I.R.P | E.R.P | E.I.R.P |
|--------------|--------------|--------------|--------------|
| LTE Band 2 | LTE Band 4 | LTE Band 5 | LTE Band 7 |
| 2W(33 dBm) | 1W(30 dBm) | 7W(38.45dBm) | 2W(33 dBm) |
| E.R.P | E.R.P | E.I.R.P | E.R.P |
| LTE Band 12 | LTE Band 17 | LTE Band 25 | LTE Band 26 |
| 3W(34.77dBm) | 3W(34.77dBm) | 2W(33 dBm) | 7W(38.45dBm) |

9.2 Test Setup

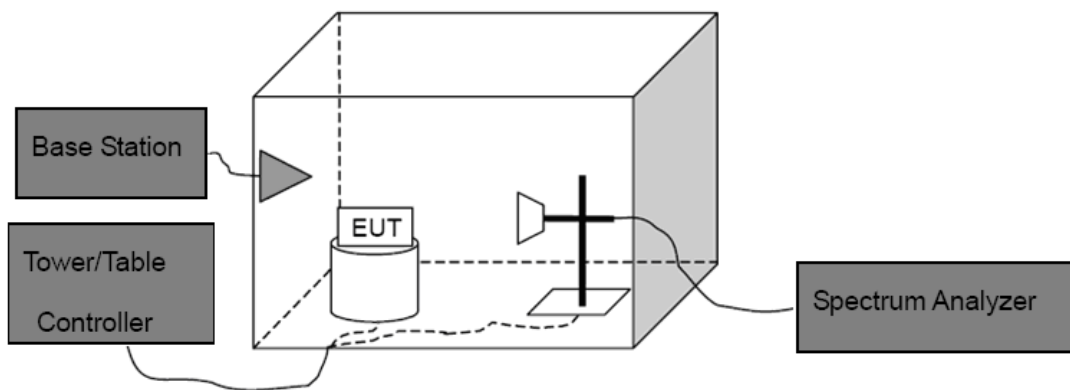

Above 1G

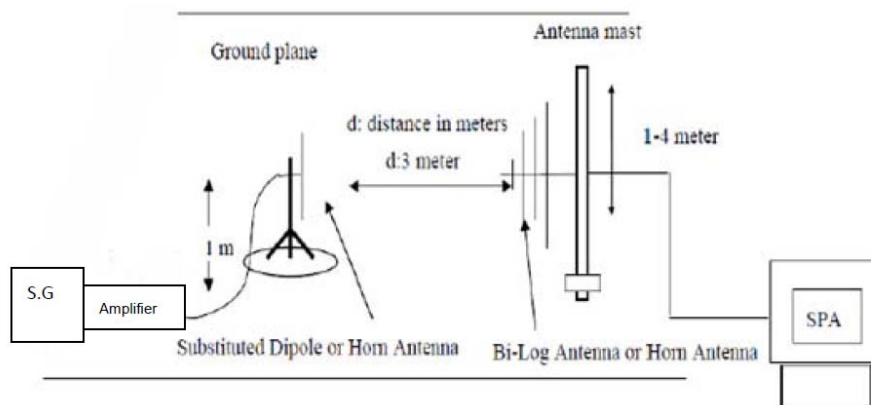

Substituted Method

9.3 Test Procedure

- (1) The EUT was placed on a non-conductive rotating platform with 0.8 meter height in an anechoic chamber. The radiated emission at the fundamental frequency was measured at 3 m with a test antenna and a spectrum analyzer with RBW=3 MHz, VBW=3 MHz and peak detector settings.
- (2) During the measurement, the EUT was enforced in maximum power and linked with the Base Station. The highest was recorded from analyzer power level (LVT) from the 360 degrees rotation of the turntable and the test antenna raised and lowered over a range from 1 to 4 meters in both horizontally and vertically polarized orientations.
- (3) Effective Isotropic Radiated Power (EIRP) was measured by substitution method according to C63.26. The EUT was replaced by dipole antenna (for frequency below 1 GHz) or Horn antenna (for frequency above 1 GHz) at same location with same polarize of receiver antenna and then a known power of each measure frequency from S.G. was applied into the dipole antenna or Horn antenna through a TX cable, and then recorded the maximum Analyzer reading through raised and lowered the test antenna.

Note: In test, the S.G Connect the Pre-amplifier(Sonoma 310N Pre-amplifier for frequency below 1 GHz, HP 8449B Pre-amplifier for frequency above 1 GHz)

Then the EUT's EIRP and ERP was calculated with the correction factor:

$ERP = S.G.Level + Antenna Gain Cord.(dB) - Cable Loss(dB)$

$EIRP = S.G.Level + Antenna Gain Cord.(dBi) - Cable Loss(dB)$

9.4 EUT Operating Condition

The EUT was continuously connected with the Base station and transmitting in the max power during the test.

9.5 Deviation From Test Standard

No deviation

9.6 Test Data

Please refer to the Attachment F.
Measurement Data (worst case)

10. Radiated Out Band of Emissions

10.1 Test Standard and Limit

10.1.1 Test Standard

FCC Part 2: 2.1053, FCC Part 22.917(a)

FCC part 24.238(a)

FCC Part 27.53 (h), FCC Part 27.53(m)

10.1.2 Test Limit

The power of any emission outside of the authorized operating frequency ranges must be attenuated below the transmitting power(P) by a factor of at least $43+10\log(P)$ dB. For all power levels +30 dBm to 0 dBm, this becomes a constant specification limit of -13 dBm.

10.2 Test Setup

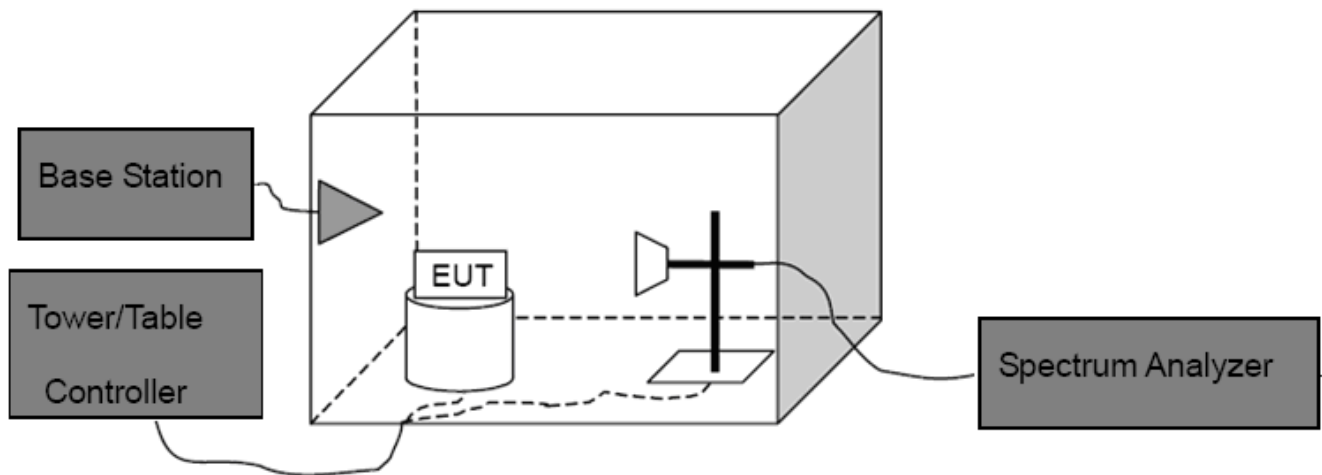

10.3 Test Procedure

- (1) The test system setup as show in the block diagram above.
- (2) The EUT was placed on an non-conductive rotating platform in an anechoic chamber. The radiated spurious emissions from 30MHz to 10th harmonious of fundamental frequency were measured at 3 m with a test antenna and a spectrum analyzer with RBW=1 MHz, VBW=1 MHz, peak detector settings.
- (3) During the measurement, the EUT was enforced in maximum power and linked with a base station. All the spurious emissions at 3m were measured by rotation of the turntable and the test antenna raised and lowered over a range from 1 to 4 meters in both horizontally and vertically polarized orientations.
- (4) When found the maximum level of emissions from the EUT. Remove the EUT and replace it with substitution antenna. A signal generator was connected to the substitution antenna by a non-radiating cable. The absolute levels of the spurious emissions were measured by the substitution.

Spurious emissions in dB=10 log(TX power in Watts/0.001)-the absolute level

Spurious attenuation limit in dB=43+10 log(power out in Watts)

10.4 EUT Operating Condition

The EUT was continuously connected with the Base station and transmitting in the max power during the test.

10.5 Deviation From Test Standard

No deviation

10.6 Test Data

Please refer to the Attachment G.
Measurement Data (worst case)

11. Frequency Stability

11.1 Test Standard and Limit

11.1.1 Test Standard

FCC Part 2.1055(a)(1)(b) FCC Part 22.355
FCC Part 24.235, Part 27.54

11.1.2 Limit

| Limit |
|---------------------|
| $\pm 2.5\text{ppm}$ |

11.2 Test Setup

For Temperature Test:

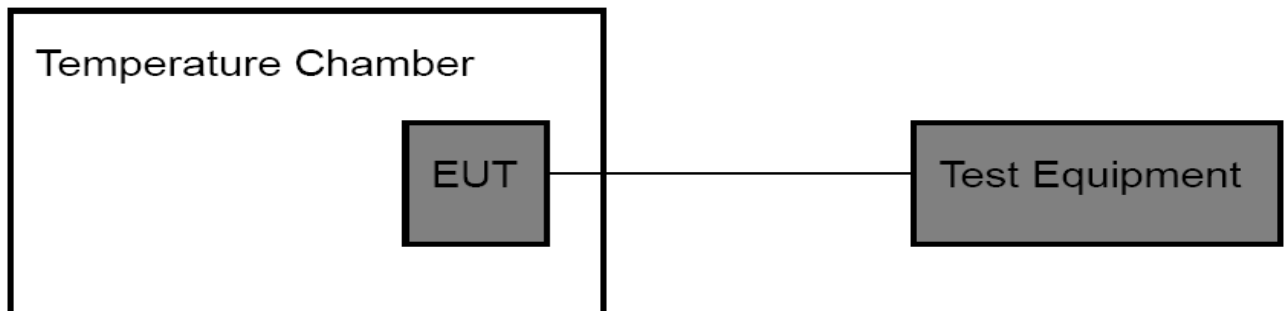

For Voltage Test:

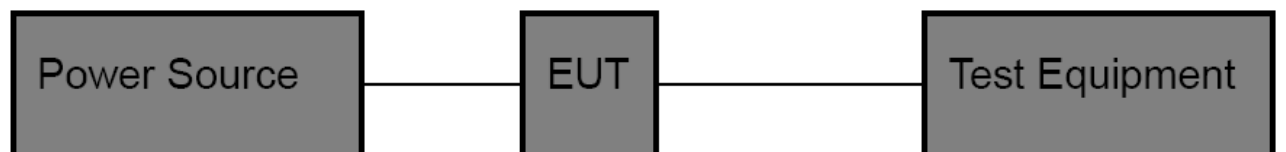

11.3 Test Procedure

Test Procedures for Temperature Variation:

- (1) The EUT was set up in the thermal chamber and connected with the base station.
- (2) With power off, the temperature was decreased to -30°C and the EUT was stabilized for three hours. Power was applied and the maximum change in frequency was recorded within one minute.
- (3) With power off, the temperature was raised in 10°C set up to 50°C and the EUT was stabilized for three hours. Power was applied and the maximum change in frequency was recorded within one minute.
- (4) If the EUT cannot be turned on at -30°C , the testing lowest temperature will be raised in 10°C step until the EUT can be turned on.

Test Procedures for Voltage Variation:

- (1) The EUT was placed in a temperature chamber at $25 \pm 5^{\circ}\text{C}$ and connected with the base station.
- (2) Reduce the input voltage to specify extreme voltage variation ($\pm 15\%$) and endpoint, record the maximum frequency change.
- (3) The variation in frequency was measured for the worst case.

11.4 EUT Operating Condition

The Equipment Under Test was set to Communication with the Base Station.

11.5 Deviation From Test Standard

No deviation

11.6 Test Data

Please refer to the Attachment H.

ATTACHMENT A--CONDUCTED RF OUTPUT POWER

| Band | Bandwidth | Modulation | Channel | RB Configuration | Result(dBm) | Verdict |
|-------|-----------|------------|---------|------------------|-------------|---------|
| Band2 | 1.4MHz | QPSK | 18607 | 1RB#0 | 23.35 | PASS |
| Band2 | 1.4MHz | QPSK | 18607 | 1RB#2 | 23.52 | PASS |
| Band2 | 1.4MHz | QPSK | 18607 | 1RB#5 | 23.24 | PASS |
| Band2 | 1.4MHz | QPSK | 18607 | 3RB#0 | 23.37 | PASS |
| Band2 | 1.4MHz | QPSK | 18607 | 3RB#1 | 23.25 | PASS |
| Band2 | 1.4MHz | QPSK | 18607 | 3RB#3 | 23.46 | PASS |
| Band2 | 1.4MHz | QPSK | 18607 | 6RB#0 | 22.54 | PASS |
| Band2 | 1.4MHz | QPSK | 18900 | 1RB#0 | 23.39 | PASS |
| Band2 | 1.4MHz | QPSK | 18900 | 1RB#2 | 23.45 | PASS |
| Band2 | 1.4MHz | QPSK | 18900 | 1RB#5 | 23.48 | PASS |
| Band2 | 1.4MHz | QPSK | 18900 | 3RB#0 | 23.37 | PASS |
| Band2 | 1.4MHz | QPSK | 18900 | 3RB#1 | 23.38 | PASS |
| Band2 | 1.4MHz | QPSK | 18900 | 3RB#3 | 23.38 | PASS |
| Band2 | 1.4MHz | QPSK | 18900 | 6RB#0 | 22.46 | PASS |
| Band2 | 1.4MHz | QPSK | 19193 | 1RB#0 | 23.34 | PASS |
| Band2 | 1.4MHz | QPSK | 19193 | 1RB#2 | 23.47 | PASS |
| Band2 | 1.4MHz | QPSK | 19193 | 1RB#5 | 23.25 | PASS |
| Band2 | 1.4MHz | QPSK | 19193 | 3RB#0 | 23.43 | PASS |
| Band2 | 1.4MHz | QPSK | 19193 | 3RB#1 | 23.33 | PASS |
| Band2 | 1.4MHz | QPSK | 19193 | 3RB#3 | 23.20 | PASS |
| Band2 | 1.4MHz | QPSK | 19193 | 6RB#0 | 22.37 | PASS |
| Band2 | 1.4MHz | 16QAM | 18607 | 1RB#0 | 22.35 | PASS |
| Band2 | 1.4MHz | 16QAM | 18607 | 1RB#2 | 22.35 | PASS |
| Band2 | 1.4MHz | 16QAM | 18607 | 1RB#5 | 22.04 | PASS |
| Band2 | 1.4MHz | 16QAM | 18607 | 3RB#0 | 22.38 | PASS |
| Band2 | 1.4MHz | 16QAM | 18607 | 3RB#1 | 22.37 | PASS |
| Band2 | 1.4MHz | 16QAM | 18607 | 3RB#3 | 22.41 | PASS |
| Band2 | 1.4MHz | 16QAM | 18607 | 6RB#0 | 21.23 | PASS |
| Band2 | 1.4MHz | 16QAM | 18900 | 1RB#0 | 22.57 | PASS |
| Band2 | 1.4MHz | 16QAM | 18900 | 1RB#2 | 22.23 | PASS |
| Band2 | 1.4MHz | 16QAM | 18900 | 1RB#5 | 22.55 | PASS |
| Band2 | 1.4MHz | 16QAM | 18900 | 3RB#0 | 22.33 | PASS |
| Band2 | 1.4MHz | 16QAM | 18900 | 3RB#1 | 22.25 | PASS |
| Band2 | 1.4MHz | 16QAM | 18900 | 3RB#3 | 22.14 | PASS |
| Band2 | 1.4MHz | 16QAM | 18900 | 6RB#0 | 21.59 | PASS |

| | | | | | | |
|-------|--------|-------|-------|--------|-------|------|
| Band2 | 1.4MHz | 16QAM | 19193 | 1RB#0 | 22.29 | PASS |
| Band2 | 1.4MHz | 16QAM | 19193 | 1RB#2 | 22.36 | PASS |
| Band2 | 1.4MHz | 16QAM | 19193 | 1RB#5 | 22.29 | PASS |
| Band2 | 1.4MHz | 16QAM | 19193 | 3RB#0 | 21.99 | PASS |
| Band2 | 1.4MHz | 16QAM | 19193 | 3RB#1 | 22.08 | PASS |
| Band2 | 1.4MHz | 16QAM | 19193 | 3RB#3 | 22.08 | PASS |
| Band2 | 1.4MHz | 16QAM | 19193 | 6RB#0 | 21.46 | PASS |
| Band2 | 3MHz | QPSK | 18615 | 1RB#0 | 23.53 | PASS |
| Band2 | 3MHz | QPSK | 18615 | 1RB#8 | 23.53 | PASS |
| Band2 | 3MHz | QPSK | 18615 | 1RB#14 | 23.58 | PASS |
| Band2 | 3MHz | QPSK | 18615 | 8RB#0 | 22.69 | PASS |
| Band2 | 3MHz | QPSK | 18615 | 8RB#4 | 22.56 | PASS |
| Band2 | 3MHz | QPSK | 18615 | 8RB#7 | 22.54 | PASS |
| Band2 | 3MHz | QPSK | 18615 | 15RB#0 | 22.64 | PASS |
| Band2 | 3MHz | QPSK | 18900 | 1RB#0 | 23.69 | PASS |
| Band2 | 3MHz | QPSK | 18900 | 1RB#8 | 23.63 | PASS |
| Band2 | 3MHz | QPSK | 18900 | 1RB#14 | 23.36 | PASS |
| Band2 | 3MHz | QPSK | 18900 | 8RB#0 | 22.67 | PASS |
| Band2 | 3MHz | QPSK | 18900 | 8RB#4 | 22.54 | PASS |
| Band2 | 3MHz | QPSK | 18900 | 8RB#7 | 22.58 | PASS |
| Band2 | 3MHz | QPSK | 18900 | 15RB#0 | 22.43 | PASS |
| Band2 | 3MHz | QPSK | 19185 | 1RB#0 | 23.29 | PASS |
| Band2 | 3MHz | QPSK | 19185 | 1RB#8 | 23.22 | PASS |
| Band2 | 3MHz | QPSK | 19185 | 1RB#14 | 23.20 | PASS |
| Band2 | 3MHz | QPSK | 19185 | 8RB#0 | 22.47 | PASS |
| Band2 | 3MHz | QPSK | 19185 | 8RB#4 | 22.47 | PASS |
| Band2 | 3MHz | QPSK | 19185 | 8RB#7 | 22.47 | PASS |
| Band2 | 3MHz | QPSK | 19185 | 15RB#0 | 22.51 | PASS |
| Band2 | 3MHz | 16QAM | 18615 | 1RB#0 | 22.66 | PASS |
| Band2 | 3MHz | 16QAM | 18615 | 1RB#8 | 22.64 | PASS |
| Band2 | 3MHz | 16QAM | 18615 | 1RB#14 | 22.56 | PASS |
| Band2 | 3MHz | 16QAM | 18615 | 8RB#0 | 21.52 | PASS |
| Band2 | 3MHz | 16QAM | 18615 | 8RB#4 | 21.50 | PASS |
| Band2 | 3MHz | 16QAM | 18615 | 8RB#7 | 21.48 | PASS |
| Band2 | 3MHz | 16QAM | 18615 | 15RB#0 | 21.59 | PASS |
| Band2 | 3MHz | 16QAM | 18900 | 1RB#0 | 22.64 | PASS |
| Band2 | 3MHz | 16QAM | 18900 | 1RB#8 | 22.83 | PASS |
| Band2 | 3MHz | 16QAM | 18900 | 1RB#14 | 22.65 | PASS |

| | | | | | | |
|-------|------|-------|-------|---------|-------|------|
| Band2 | 3MHz | 16QAM | 18900 | 8RB#0 | 21.42 | PASS |
| Band2 | 3MHz | 16QAM | 18900 | 8RB#4 | 21.42 | PASS |
| Band2 | 3MHz | 16QAM | 18900 | 8RB#7 | 21.35 | PASS |
| Band2 | 3MHz | 16QAM | 18900 | 15RB#0 | 21.31 | PASS |
| Band2 | 3MHz | 16QAM | 19185 | 1RB#0 | 22.13 | PASS |
| Band2 | 3MHz | 16QAM | 19185 | 1RB#8 | 22.28 | PASS |
| Band2 | 3MHz | 16QAM | 19185 | 1RB#14 | 22.06 | PASS |
| Band2 | 3MHz | 16QAM | 19185 | 8RB#0 | 21.62 | PASS |
| Band2 | 3MHz | 16QAM | 19185 | 8RB#4 | 21.58 | PASS |
| Band2 | 3MHz | 16QAM | 19185 | 8RB#7 | 21.48 | PASS |
| Band2 | 3MHz | 16QAM | 19185 | 15RB#0 | 21.53 | PASS |
| Band2 | 5MHz | QPSK | 18625 | 1RB#0 | 23.79 | PASS |
| Band2 | 5MHz | QPSK | 18625 | 1RB#12 | 23.69 | PASS |
| Band2 | 5MHz | QPSK | 18625 | 1RB#24 | 23.47 | PASS |
| Band2 | 5MHz | QPSK | 18625 | 12RB#0 | 22.71 | PASS |
| Band2 | 5MHz | QPSK | 18625 | 12RB#6 | 22.68 | PASS |
| Band2 | 5MHz | QPSK | 18625 | 12RB#13 | 22.59 | PASS |
| Band2 | 5MHz | QPSK | 18625 | 25RB#0 | 22.62 | PASS |
| Band2 | 5MHz | QPSK | 18900 | 1RB#0 | 23.38 | PASS |
| Band2 | 5MHz | QPSK | 18900 | 1RB#12 | 23.60 | PASS |
| Band2 | 5MHz | QPSK | 18900 | 1RB#24 | 23.49 | PASS |
| Band2 | 5MHz | QPSK | 18900 | 12RB#0 | 22.58 | PASS |
| Band2 | 5MHz | QPSK | 18900 | 12RB#6 | 22.49 | PASS |
| Band2 | 5MHz | QPSK | 18900 | 12RB#13 | 22.46 | PASS |
| Band2 | 5MHz | QPSK | 18900 | 25RB#0 | 22.53 | PASS |
| Band2 | 5MHz | QPSK | 19175 | 1RB#0 | 23.23 | PASS |
| Band2 | 5MHz | QPSK | 19175 | 1RB#12 | 23.55 | PASS |
| Band2 | 5MHz | QPSK | 19175 | 1RB#24 | 23.16 | PASS |
| Band2 | 5MHz | QPSK | 19175 | 12RB#0 | 22.38 | PASS |
| Band2 | 5MHz | QPSK | 19175 | 12RB#6 | 22.39 | PASS |
| Band2 | 5MHz | QPSK | 19175 | 12RB#13 | 22.47 | PASS |
| Band2 | 5MHz | QPSK | 19175 | 25RB#0 | 22.43 | PASS |
| Band2 | 5MHz | 16QAM | 18625 | 1RB#0 | 22.08 | PASS |
| Band2 | 5MHz | 16QAM | 18625 | 1RB#12 | 22.52 | PASS |
| Band2 | 5MHz | 16QAM | 18625 | 1RB#24 | 22.02 | PASS |
| Band2 | 5MHz | 16QAM | 18625 | 12RB#0 | 21.54 | PASS |
| Band2 | 5MHz | 16QAM | 18625 | 12RB#6 | 21.61 | PASS |
| Band2 | 5MHz | 16QAM | 18625 | 12RB#13 | 21.47 | PASS |

| | | | | | | |
|-------|-------|-------|-------|---------|-------|------|
| Band2 | 5MHz | 16QAM | 18625 | 25RB#0 | 21.66 | PASS |
| Band2 | 5MHz | 16QAM | 18900 | 1RB#0 | 22.45 | PASS |
| Band2 | 5MHz | 16QAM | 18900 | 1RB#12 | 22.36 | PASS |
| Band2 | 5MHz | 16QAM | 18900 | 1RB#24 | 22.54 | PASS |
| Band2 | 5MHz | 16QAM | 18900 | 12RB#0 | 21.52 | PASS |
| Band2 | 5MHz | 16QAM | 18900 | 12RB#6 | 21.61 | PASS |
| Band2 | 5MHz | 16QAM | 18900 | 12RB#13 | 21.70 | PASS |
| Band2 | 5MHz | 16QAM | 18900 | 25RB#0 | 21.47 | PASS |
| Band2 | 5MHz | 16QAM | 19175 | 1RB#0 | 22.43 | PASS |
| Band2 | 5MHz | 16QAM | 19175 | 1RB#12 | 22.50 | PASS |
| Band2 | 5MHz | 16QAM | 19175 | 1RB#24 | 22.25 | PASS |
| Band2 | 5MHz | 16QAM | 19175 | 12RB#0 | 21.20 | PASS |
| Band2 | 5MHz | 16QAM | 19175 | 12RB#6 | 21.47 | PASS |
| Band2 | 5MHz | 16QAM | 19175 | 12RB#13 | 21.40 | PASS |
| Band2 | 5MHz | 16QAM | 19175 | 25RB#0 | 21.35 | PASS |
| Band2 | 10MHz | QPSK | 18650 | 1RB#0 | 23.63 | PASS |
| Band2 | 10MHz | QPSK | 18650 | 1RB#24 | 23.73 | PASS |
| Band2 | 10MHz | QPSK | 18650 | 1RB#49 | 23.65 | PASS |
| Band2 | 10MHz | QPSK | 18650 | 25RB#0 | 22.59 | PASS |
| Band2 | 10MHz | QPSK | 18650 | 25RB#12 | 22.58 | PASS |
| Band2 | 10MHz | QPSK | 18650 | 25RB#25 | 22.59 | PASS |
| Band2 | 10MHz | QPSK | 18650 | 50RB#0 | 22.55 | PASS |
| Band2 | 10MHz | QPSK | 18900 | 1RB#0 | 23.11 | PASS |
| Band2 | 10MHz | QPSK | 18900 | 1RB#24 | 23.40 | PASS |
| Band2 | 10MHz | QPSK | 18900 | 1RB#49 | 23.37 | PASS |
| Band2 | 10MHz | QPSK | 18900 | 25RB#0 | 22.46 | PASS |
| Band2 | 10MHz | QPSK | 18900 | 25RB#12 | 22.46 | PASS |
| Band2 | 10MHz | QPSK | 18900 | 25RB#25 | 22.49 | PASS |
| Band2 | 10MHz | QPSK | 18900 | 50RB#0 | 22.44 | PASS |
| Band2 | 10MHz | QPSK | 19150 | 1RB#0 | 23.25 | PASS |
| Band2 | 10MHz | QPSK | 19150 | 1RB#24 | 23.71 | PASS |
| Band2 | 10MHz | QPSK | 19150 | 1RB#49 | 23.12 | PASS |
| Band2 | 10MHz | QPSK | 19150 | 25RB#0 | 22.50 | PASS |
| Band2 | 10MHz | QPSK | 19150 | 25RB#12 | 22.50 | PASS |
| Band2 | 10MHz | QPSK | 19150 | 25RB#25 | 22.51 | PASS |
| Band2 | 10MHz | QPSK | 19150 | 50RB#0 | 22.45 | PASS |
| Band2 | 10MHz | 16QAM | 18650 | 1RB#0 | 22.63 | PASS |
| Band2 | 10MHz | 16QAM | 18650 | 1RB#24 | 22.81 | PASS |

| | | | | | | |
|-------|-------|-------|-------|---------|-------|------|
| Band2 | 10MHz | 16QAM | 18650 | 1RB#49 | 22.72 | PASS |
| Band2 | 10MHz | 16QAM | 18650 | 25RB#0 | 21.45 | PASS |
| Band2 | 10MHz | 16QAM | 18650 | 25RB#12 | 21.41 | PASS |
| Band2 | 10MHz | 16QAM | 18650 | 25RB#25 | 21.50 | PASS |
| Band2 | 10MHz | 16QAM | 18650 | 50RB#0 | 21.35 | PASS |
| Band2 | 10MHz | 16QAM | 18900 | 1RB#0 | 22.14 | PASS |
| Band2 | 10MHz | 16QAM | 18900 | 1RB#24 | 22.62 | PASS |
| Band2 | 10MHz | 16QAM | 18900 | 1RB#49 | 22.18 | PASS |
| Band2 | 10MHz | 16QAM | 18900 | 25RB#0 | 21.44 | PASS |
| Band2 | 10MHz | 16QAM | 18900 | 25RB#12 | 21.44 | PASS |
| Band2 | 10MHz | 16QAM | 18900 | 25RB#25 | 21.46 | PASS |
| Band2 | 10MHz | 16QAM | 18900 | 50RB#0 | 21.42 | PASS |
| Band2 | 10MHz | 16QAM | 19150 | 1RB#0 | 22.56 | PASS |
| Band2 | 10MHz | 16QAM | 19150 | 1RB#24 | 22.99 | PASS |
| Band2 | 10MHz | 16QAM | 19150 | 1RB#49 | 22.40 | PASS |
| Band2 | 10MHz | 16QAM | 19150 | 25RB#0 | 21.60 | PASS |
| Band2 | 10MHz | 16QAM | 19150 | 25RB#12 | 21.49 | PASS |
| Band2 | 10MHz | 16QAM | 19150 | 25RB#25 | 21.51 | PASS |
| Band2 | 10MHz | 16QAM | 19150 | 50RB#0 | 21.47 | PASS |
| Band2 | 15MHz | QPSK | 18675 | 1RB#0 | 23.54 | PASS |
| Band2 | 15MHz | QPSK | 18675 | 1RB#38 | 23.33 | PASS |
| Band2 | 15MHz | QPSK | 18675 | 1RB#74 | 23.30 | PASS |
| Band2 | 15MHz | QPSK | 18675 | 38RB#0 | 22.29 | PASS |
| Band2 | 15MHz | QPSK | 18675 | 38RB#18 | 22.46 | PASS |
| Band2 | 15MHz | QPSK | 18675 | 38RB#37 | 22.28 | PASS |
| Band2 | 15MHz | QPSK | 18675 | 75RB#0 | 22.56 | PASS |
| Band2 | 15MHz | QPSK | 18900 | 1RB#0 | 23.31 | PASS |
| Band2 | 15MHz | QPSK | 18900 | 1RB#38 | 23.47 | PASS |
| Band2 | 15MHz | QPSK | 18900 | 1RB#74 | 23.28 | PASS |
| Band2 | 15MHz | QPSK | 18900 | 38RB#0 | 22.55 | PASS |
| Band2 | 15MHz | QPSK | 18900 | 38RB#18 | 23.27 | PASS |
| Band2 | 15MHz | QPSK | 18900 | 38RB#37 | 22.56 | PASS |
| Band2 | 15MHz | QPSK | 18900 | 75RB#0 | 22.36 | PASS |
| Band2 | 15MHz | QPSK | 19125 | 1RB#0 | 23.20 | PASS |
| Band2 | 15MHz | QPSK | 19125 | 1RB#38 | 23.18 | PASS |
| Band2 | 15MHz | QPSK | 19125 | 1RB#74 | 23.08 | PASS |
| Band2 | 15MHz | QPSK | 19125 | 38RB#0 | 22.04 | PASS |
| Band2 | 15MHz | QPSK | 19125 | 38RB#18 | 22.41 | PASS |

| | | | | | | |
|-------|-------|-------|-------|---------|-------|------|
| Band2 | 15MHz | QPSK | 19125 | 38RB#37 | 22.26 | PASS |
| Band2 | 15MHz | QPSK | 19125 | 75RB#0 | 22.47 | PASS |
| Band2 | 15MHz | 16QAM | 18675 | 1RB#0 | 22.60 | PASS |
| Band2 | 15MHz | 16QAM | 18675 | 1RB#38 | 22.67 | PASS |
| Band2 | 15MHz | 16QAM | 18675 | 1RB#74 | 22.32 | PASS |
| Band2 | 15MHz | 16QAM | 18675 | 38RB#0 | 22.60 | PASS |
| Band2 | 15MHz | 16QAM | 18675 | 38RB#18 | 22.61 | PASS |
| Band2 | 15MHz | 16QAM | 18675 | 38RB#37 | 22.27 | PASS |
| Band2 | 15MHz | 16QAM | 18675 | 75RB#0 | 21.44 | PASS |
| Band2 | 15MHz | 16QAM | 18900 | 1RB#0 | 22.56 | PASS |
| Band2 | 15MHz | 16QAM | 18900 | 1RB#38 | 22.80 | PASS |
| Band2 | 15MHz | 16QAM | 18900 | 1RB#74 | 22.57 | PASS |
| Band2 | 15MHz | 16QAM | 18900 | 38RB#0 | 22.55 | PASS |
| Band2 | 15MHz | 16QAM | 18900 | 38RB#18 | 23.26 | PASS |
| Band2 | 15MHz | 16QAM | 18900 | 38RB#37 | 22.57 | PASS |
| Band2 | 15MHz | 16QAM | 18900 | 75RB#0 | 21.51 | PASS |
| Band2 | 15MHz | 16QAM | 19125 | 1RB#0 | 22.52 | PASS |
| Band2 | 15MHz | 16QAM | 19125 | 1RB#38 | 22.99 | PASS |
| Band2 | 15MHz | 16QAM | 19125 | 1RB#74 | 22.45 | PASS |
| Band2 | 15MHz | 16QAM | 19125 | 38RB#0 | 22.50 | PASS |
| Band2 | 15MHz | 16QAM | 19125 | 38RB#18 | 22.41 | PASS |
| Band2 | 15MHz | 16QAM | 19125 | 38RB#37 | 22.37 | PASS |
| Band2 | 15MHz | 16QAM | 19125 | 75RB#0 | 21.31 | PASS |
| Band2 | 20MHz | QPSK | 18700 | 1RB#0 | 23.59 | PASS |
| Band2 | 20MHz | QPSK | 18700 | 1RB#49 | 23.74 | PASS |
| Band2 | 20MHz | QPSK | 18700 | 1RB#99 | 23.47 | PASS |
| Band2 | 20MHz | QPSK | 18700 | 50RB#0 | 22.62 | PASS |
| Band2 | 20MHz | QPSK | 18700 | 50RB#25 | 22.61 | PASS |
| Band2 | 20MHz | QPSK | 18700 | 50RB#50 | 22.53 | PASS |
| Band2 | 20MHz | QPSK | 18700 | 100RB#0 | 22.59 | PASS |
| Band2 | 20MHz | QPSK | 18900 | 1RB#0 | 23.09 | PASS |
| Band2 | 20MHz | QPSK | 18900 | 1RB#49 | 23.58 | PASS |
| Band2 | 20MHz | QPSK | 18900 | 1RB#99 | 23.18 | PASS |
| Band2 | 20MHz | QPSK | 18900 | 50RB#0 | 22.43 | PASS |
| Band2 | 20MHz | QPSK | 18900 | 50RB#25 | 22.43 | PASS |
| Band2 | 20MHz | QPSK | 18900 | 50RB#50 | 22.47 | PASS |
| Band2 | 20MHz | QPSK | 18900 | 100RB#0 | 22.50 | PASS |
| Band2 | 20MHz | QPSK | 19100 | 1RB#0 | 23.44 | PASS |

| | | | | | | |
|-------|--------|-------|-------|---------|-------|------|
| Band2 | 20MHz | QPSK | 19100 | 1RB#49 | 23.72 | PASS |
| Band2 | 20MHz | QPSK | 19100 | 1RB#99 | 23.30 | PASS |
| Band2 | 20MHz | QPSK | 19100 | 50RB#0 | 22.60 | PASS |
| Band2 | 20MHz | QPSK | 19100 | 50RB#25 | 22.61 | PASS |
| Band2 | 20MHz | QPSK | 19100 | 50RB#50 | 22.50 | PASS |
| Band2 | 20MHz | QPSK | 19100 | 100RB#0 | 22.51 | PASS |
| Band2 | 20MHz | 16QAM | 18700 | 1RB#0 | 23.14 | PASS |
| Band2 | 20MHz | 16QAM | 18700 | 1RB#49 | 23.63 | PASS |
| Band2 | 20MHz | 16QAM | 18700 | 1RB#99 | 22.99 | PASS |
| Band2 | 20MHz | 16QAM | 18700 | 50RB#0 | 21.50 | PASS |
| Band2 | 20MHz | 16QAM | 18700 | 50RB#25 | 21.57 | PASS |
| Band2 | 20MHz | 16QAM | 18700 | 50RB#50 | 21.50 | PASS |
| Band2 | 20MHz | 16QAM | 18700 | 100RB#0 | 21.56 | PASS |
| Band2 | 20MHz | 16QAM | 18900 | 1RB#0 | 22.18 | PASS |
| Band2 | 20MHz | 16QAM | 18900 | 1RB#49 | 22.66 | PASS |
| Band2 | 20MHz | 16QAM | 18900 | 1RB#99 | 22.23 | PASS |
| Band2 | 20MHz | 16QAM | 18900 | 50RB#0 | 21.60 | PASS |
| Band2 | 20MHz | 16QAM | 18900 | 50RB#25 | 21.46 | PASS |
| Band2 | 20MHz | 16QAM | 18900 | 50RB#50 | 21.50 | PASS |
| Band2 | 20MHz | 16QAM | 18900 | 100RB#0 | 21.42 | PASS |
| Band2 | 20MHz | 16QAM | 19100 | 1RB#0 | 22.47 | PASS |
| Band2 | 20MHz | 16QAM | 19100 | 1RB#49 | 23.04 | PASS |
| Band2 | 20MHz | 16QAM | 19100 | 1RB#99 | 22.43 | PASS |
| Band2 | 20MHz | 16QAM | 19100 | 50RB#0 | 21.67 | PASS |
| Band2 | 20MHz | 16QAM | 19100 | 50RB#25 | 21.56 | PASS |
| Band2 | 20MHz | 16QAM | 19100 | 50RB#50 | 21.47 | PASS |
| Band2 | 20MHz | 16QAM | 19100 | 100RB#0 | 21.57 | PASS |
| Band4 | 1.4MHz | QPSK | 19957 | 1RB#0 | 23.20 | PASS |
| Band4 | 1.4MHz | QPSK | 19957 | 1RB#2 | 23.30 | PASS |
| Band4 | 1.4MHz | QPSK | 19957 | 1RB#5 | 23.33 | PASS |
| Band4 | 1.4MHz | QPSK | 19957 | 3RB#0 | 23.19 | PASS |
| Band4 | 1.4MHz | QPSK | 19957 | 3RB#1 | 23.16 | PASS |
| Band4 | 1.4MHz | QPSK | 19957 | 3RB#3 | 23.18 | PASS |
| Band4 | 1.4MHz | QPSK | 19957 | 6RB#0 | 22.35 | PASS |
| Band4 | 1.4MHz | QPSK | 20175 | 1RB#0 | 23.52 | PASS |
| Band4 | 1.4MHz | QPSK | 20175 | 1RB#2 | 23.25 | PASS |
| Band4 | 1.4MHz | QPSK | 20175 | 1RB#5 | 23.46 | PASS |
| Band4 | 1.4MHz | QPSK | 20175 | 3RB#0 | 23.42 | PASS |

| | | | | | | |
|-------|--------|-------|-------|--------|-------|------|
| Band4 | 1.4MHz | QPSK | 20175 | 3RB#1 | 23.40 | PASS |
| Band4 | 1.4MHz | QPSK | 20175 | 3RB#3 | 23.36 | PASS |
| Band4 | 1.4MHz | QPSK | 20175 | 6RB#0 | 22.53 | PASS |
| Band4 | 1.4MHz | QPSK | 20393 | 1RB#0 | 23.23 | PASS |
| Band4 | 1.4MHz | QPSK | 20393 | 1RB#2 | 23.12 | PASS |
| Band4 | 1.4MHz | QPSK | 20393 | 1RB#5 | 23.25 | PASS |
| Band4 | 1.4MHz | QPSK | 20393 | 3RB#0 | 23.28 | PASS |
| Band4 | 1.4MHz | QPSK | 20393 | 3RB#1 | 23.36 | PASS |
| Band4 | 1.4MHz | QPSK | 20393 | 3RB#3 | 23.30 | PASS |
| Band4 | 1.4MHz | QPSK | 20393 | 6RB#0 | 22.37 | PASS |
| Band4 | 1.4MHz | 16QAM | 19957 | 1RB#0 | 22.22 | PASS |
| Band4 | 1.4MHz | 16QAM | 19957 | 1RB#2 | 22.54 | PASS |
| Band4 | 1.4MHz | 16QAM | 19957 | 1RB#5 | 22.46 | PASS |
| Band4 | 1.4MHz | 16QAM | 19957 | 3RB#0 | 21.96 | PASS |
| Band4 | 1.4MHz | 16QAM | 19957 | 3RB#1 | 22.07 | PASS |
| Band4 | 1.4MHz | 16QAM | 19957 | 3RB#3 | 22.09 | PASS |
| Band4 | 1.4MHz | 16QAM | 19957 | 6RB#0 | 21.42 | PASS |
| Band4 | 1.4MHz | 16QAM | 20175 | 1RB#0 | 22.31 | PASS |
| Band4 | 1.4MHz | 16QAM | 20175 | 1RB#2 | 22.98 | PASS |
| Band4 | 1.4MHz | 16QAM | 20175 | 1RB#5 | 22.50 | PASS |
| Band4 | 1.4MHz | 16QAM | 20175 | 3RB#0 | 22.19 | PASS |
| Band4 | 1.4MHz | 16QAM | 20175 | 3RB#1 | 22.18 | PASS |
| Band4 | 1.4MHz | 16QAM | 20175 | 3RB#3 | 22.12 | PASS |
| Band4 | 1.4MHz | 16QAM | 20175 | 6RB#0 | 21.37 | PASS |
| Band4 | 1.4MHz | 16QAM | 20393 | 1RB#0 | 22.50 | PASS |
| Band4 | 1.4MHz | 16QAM | 20393 | 1RB#2 | 22.27 | PASS |
| Band4 | 1.4MHz | 16QAM | 20393 | 1RB#5 | 22.09 | PASS |
| Band4 | 1.4MHz | 16QAM | 20393 | 3RB#0 | 22.23 | PASS |
| Band4 | 1.4MHz | 16QAM | 20393 | 3RB#1 | 22.03 | PASS |
| Band4 | 1.4MHz | 16QAM | 20393 | 3RB#3 | 22.28 | PASS |
| Band4 | 1.4MHz | 16QAM | 20393 | 6RB#0 | 21.27 | PASS |
| Band4 | 3MHz | QPSK | 19965 | 1RB#0 | 23.03 | PASS |
| Band4 | 3MHz | QPSK | 19965 | 1RB#8 | 23.32 | PASS |
| Band4 | 3MHz | QPSK | 19965 | 1RB#14 | 23.05 | PASS |
| Band4 | 3MHz | QPSK | 19965 | 8RB#0 | 22.20 | PASS |
| Band4 | 3MHz | QPSK | 19965 | 8RB#4 | 22.29 | PASS |
| Band4 | 3MHz | QPSK | 19965 | 8RB#7 | 22.31 | PASS |
| Band4 | 3MHz | QPSK | 19965 | 15RB#0 | 22.24 | PASS |

| | | | | | | |
|-------|------|-------|-------|--------|-------|------|
| Band4 | 3MHz | QPSK | 20175 | 1RB#0 | 23.50 | PASS |
| Band4 | 3MHz | QPSK | 20175 | 1RB#8 | 23.62 | PASS |
| Band4 | 3MHz | QPSK | 20175 | 1RB#14 | 23.21 | PASS |
| Band4 | 3MHz | QPSK | 20175 | 8RB#0 | 22.64 | PASS |
| Band4 | 3MHz | QPSK | 20175 | 8RB#4 | 22.55 | PASS |
| Band4 | 3MHz | QPSK | 20175 | 8RB#7 | 22.50 | PASS |
| Band4 | 3MHz | QPSK | 20175 | 15RB#0 | 22.50 | PASS |
| Band4 | 3MHz | QPSK | 20385 | 1RB#0 | 23.22 | PASS |
| Band4 | 3MHz | QPSK | 20385 | 1RB#8 | 23.45 | PASS |
| Band4 | 3MHz | QPSK | 20385 | 1RB#14 | 23.22 | PASS |
| Band4 | 3MHz | QPSK | 20385 | 8RB#0 | 22.42 | PASS |
| Band4 | 3MHz | QPSK | 20385 | 8RB#4 | 22.34 | PASS |
| Band4 | 3MHz | QPSK | 20385 | 8RB#7 | 22.32 | PASS |
| Band4 | 3MHz | QPSK | 20385 | 15RB#0 | 22.29 | PASS |
| Band4 | 3MHz | 16QAM | 19965 | 1RB#0 | 21.88 | PASS |
| Band4 | 3MHz | 16QAM | 19965 | 1RB#8 | 22.25 | PASS |
| Band4 | 3MHz | 16QAM | 19965 | 1RB#14 | 21.94 | PASS |
| Band4 | 3MHz | 16QAM | 19965 | 8RB#0 | 21.36 | PASS |
| Band4 | 3MHz | 16QAM | 19965 | 8RB#4 | 21.34 | PASS |
| Band4 | 3MHz | 16QAM | 19965 | 8RB#7 | 21.17 | PASS |
| Band4 | 3MHz | 16QAM | 19965 | 15RB#0 | 21.09 | PASS |
| Band4 | 3MHz | 16QAM | 20175 | 1RB#0 | 22.32 | PASS |
| Band4 | 3MHz | 16QAM | 20175 | 1RB#8 | 22.39 | PASS |
| Band4 | 3MHz | 16QAM | 20175 | 1RB#14 | 22.41 | PASS |
| Band4 | 3MHz | 16QAM | 20175 | 8RB#0 | 21.52 | PASS |
| Band4 | 3MHz | 16QAM | 20175 | 8RB#4 | 21.52 | PASS |
| Band4 | 3MHz | 16QAM | 20175 | 8RB#7 | 21.61 | PASS |
| Band4 | 3MHz | 16QAM | 20175 | 15RB#0 | 21.58 | PASS |
| Band4 | 3MHz | 16QAM | 20385 | 1RB#0 | 22.35 | PASS |
| Band4 | 3MHz | 16QAM | 20385 | 1RB#8 | 22.27 | PASS |
| Band4 | 3MHz | 16QAM | 20385 | 1RB#14 | 22.01 | PASS |
| Band4 | 3MHz | 16QAM | 20385 | 8RB#0 | 21.19 | PASS |
| Band4 | 3MHz | 16QAM | 20385 | 8RB#4 | 21.21 | PASS |
| Band4 | 3MHz | 16QAM | 20385 | 8RB#7 | 21.40 | PASS |
| Band4 | 3MHz | 16QAM | 20385 | 15RB#0 | 21.17 | PASS |
| Band4 | 5MHz | QPSK | 19975 | 1RB#0 | 22.98 | PASS |
| Band4 | 5MHz | QPSK | 19975 | 1RB#12 | 23.20 | PASS |
| Band4 | 5MHz | QPSK | 19975 | 1RB#24 | 22.93 | PASS |

| | | | | | | |
|-------|------|-------|-------|---------|-------|------|
| Band4 | 5MHz | QPSK | 19975 | 12RB#0 | 22.18 | PASS |
| Band4 | 5MHz | QPSK | 19975 | 12RB#6 | 22.25 | PASS |
| Band4 | 5MHz | QPSK | 19975 | 12RB#13 | 22.26 | PASS |
| Band4 | 5MHz | QPSK | 19975 | 25RB#0 | 22.23 | PASS |
| Band4 | 5MHz | QPSK | 20175 | 1RB#0 | 23.39 | PASS |
| Band4 | 5MHz | QPSK | 20175 | 1RB#12 | 23.65 | PASS |
| Band4 | 5MHz | QPSK | 20175 | 1RB#24 | 23.43 | PASS |
| Band4 | 5MHz | QPSK | 20175 | 12RB#0 | 22.54 | PASS |
| Band4 | 5MHz | QPSK | 20175 | 12RB#6 | 22.54 | PASS |
| Band4 | 5MHz | QPSK | 20175 | 12RB#13 | 22.57 | PASS |
| Band4 | 5MHz | QPSK | 20175 | 25RB#0 | 22.52 | PASS |
| Band4 | 5MHz | QPSK | 20375 | 1RB#0 | 23.53 | PASS |
| Band4 | 5MHz | QPSK | 20375 | 1RB#12 | 23.67 | PASS |
| Band4 | 5MHz | QPSK | 20375 | 1RB#24 | 23.57 | PASS |
| Band4 | 5MHz | QPSK | 20375 | 12RB#0 | 22.49 | PASS |
| Band4 | 5MHz | QPSK | 20375 | 12RB#6 | 22.51 | PASS |
| Band4 | 5MHz | QPSK | 20375 | 12RB#13 | 22.56 | PASS |
| Band4 | 5MHz | QPSK | 20375 | 25RB#0 | 22.53 | PASS |
| Band4 | 5MHz | 16QAM | 19975 | 1RB#0 | 21.93 | PASS |
| Band4 | 5MHz | 16QAM | 19975 | 1RB#12 | 22.20 | PASS |
| Band4 | 5MHz | 16QAM | 19975 | 1RB#24 | 22.11 | PASS |
| Band4 | 5MHz | 16QAM | 19975 | 12RB#0 | 21.23 | PASS |
| Band4 | 5MHz | 16QAM | 19975 | 12RB#6 | 21.30 | PASS |
| Band4 | 5MHz | 16QAM | 19975 | 12RB#13 | 21.30 | PASS |
| Band4 | 5MHz | 16QAM | 19975 | 25RB#0 | 21.19 | PASS |
| Band4 | 5MHz | 16QAM | 20175 | 1RB#0 | 22.26 | PASS |
| Band4 | 5MHz | 16QAM | 20175 | 1RB#12 | 22.37 | PASS |
| Band4 | 5MHz | 16QAM | 20175 | 1RB#24 | 22.42 | PASS |
| Band4 | 5MHz | 16QAM | 20175 | 12RB#0 | 21.40 | PASS |
| Band4 | 5MHz | 16QAM | 20175 | 12RB#6 | 21.38 | PASS |
| Band4 | 5MHz | 16QAM | 20175 | 12RB#13 | 21.46 | PASS |
| Band4 | 5MHz | 16QAM | 20175 | 25RB#0 | 21.47 | PASS |
| Band4 | 5MHz | 16QAM | 20375 | 1RB#0 | 22.34 | PASS |
| Band4 | 5MHz | 16QAM | 20375 | 1RB#12 | 22.62 | PASS |
| Band4 | 5MHz | 16QAM | 20375 | 1RB#24 | 22.61 | PASS |
| Band4 | 5MHz | 16QAM | 20375 | 12RB#0 | 21.63 | PASS |
| Band4 | 5MHz | 16QAM | 20375 | 12RB#6 | 21.43 | PASS |
| Band4 | 5MHz | 16QAM | 20375 | 12RB#13 | 21.60 | PASS |

| | | | | | | |
|-------|-------|-------|-------|---------|-------|------|
| Band4 | 5MHz | 16QAM | 20375 | 25RB#0 | 21.26 | PASS |
| Band4 | 10MHz | QPSK | 20000 | 1RB#0 | 22.95 | PASS |
| Band4 | 10MHz | QPSK | 20000 | 1RB#24 | 23.43 | PASS |
| Band4 | 10MHz | QPSK | 20000 | 1RB#49 | 23.11 | PASS |
| Band4 | 10MHz | QPSK | 20000 | 25RB#0 | 22.21 | PASS |
| Band4 | 10MHz | QPSK | 20000 | 25RB#12 | 22.28 | PASS |
| Band4 | 10MHz | QPSK | 20000 | 25RB#25 | 22.28 | PASS |
| Band4 | 10MHz | QPSK | 20000 | 50RB#0 | 22.30 | PASS |
| Band4 | 10MHz | QPSK | 20175 | 1RB#0 | 23.10 | PASS |
| Band4 | 10MHz | QPSK | 20175 | 1RB#24 | 23.73 | PASS |
| Band4 | 10MHz | QPSK | 20175 | 1RB#49 | 23.28 | PASS |
| Band4 | 10MHz | QPSK | 20175 | 25RB#0 | 22.54 | PASS |
| Band4 | 10MHz | QPSK | 20175 | 25RB#12 | 22.53 | PASS |
| Band4 | 10MHz | QPSK | 20175 | 25RB#25 | 22.51 | PASS |
| Band4 | 10MHz | QPSK | 20175 | 50RB#0 | 22.56 | PASS |
| Band4 | 10MHz | QPSK | 20350 | 1RB#0 | 23.41 | PASS |
| Band4 | 10MHz | QPSK | 20350 | 1RB#24 | 23.87 | PASS |
| Band4 | 10MHz | QPSK | 20350 | 1RB#49 | 23.43 | PASS |
| Band4 | 10MHz | QPSK | 20350 | 25RB#0 | 22.51 | PASS |
| Band4 | 10MHz | QPSK | 20350 | 25RB#12 | 22.52 | PASS |
| Band4 | 10MHz | QPSK | 20350 | 25RB#25 | 22.56 | PASS |
| Band4 | 10MHz | QPSK | 20350 | 50RB#0 | 22.47 | PASS |
| Band4 | 10MHz | 16QAM | 20000 | 1RB#0 | 21.93 | PASS |
| Band4 | 10MHz | 16QAM | 20000 | 1RB#24 | 22.64 | PASS |
| Band4 | 10MHz | 16QAM | 20000 | 1RB#49 | 21.97 | PASS |
| Band4 | 10MHz | 16QAM | 20000 | 25RB#0 | 21.35 | PASS |
| Band4 | 10MHz | 16QAM | 20000 | 25RB#12 | 21.23 | PASS |
| Band4 | 10MHz | 16QAM | 20000 | 25RB#25 | 21.26 | PASS |
| Band4 | 10MHz | 16QAM | 20000 | 50RB#0 | 21.12 | PASS |
| Band4 | 10MHz | 16QAM | 20175 | 1RB#0 | 22.41 | PASS |
| Band4 | 10MHz | 16QAM | 20175 | 1RB#24 | 23.04 | PASS |
| Band4 | 10MHz | 16QAM | 20175 | 1RB#49 | 22.48 | PASS |
| Band4 | 10MHz | 16QAM | 20175 | 25RB#0 | 21.57 | PASS |
| Band4 | 10MHz | 16QAM | 20175 | 25RB#12 | 21.56 | PASS |
| Band4 | 10MHz | 16QAM | 20175 | 25RB#25 | 21.48 | PASS |
| Band4 | 10MHz | 16QAM | 20175 | 50RB#0 | 21.60 | PASS |
| Band4 | 10MHz | 16QAM | 20350 | 1RB#0 | 22.34 | PASS |
| Band4 | 10MHz | 16QAM | 20350 | 1RB#24 | 22.82 | PASS |

| | | | | | | |
|-------|-------|-------|-------|---------|-------|------|
| Band4 | 10MHz | 16QAM | 20350 | 1RB#49 | 22.36 | PASS |
| Band4 | 10MHz | 16QAM | 20350 | 25RB#0 | 21.60 | PASS |
| Band4 | 10MHz | 16QAM | 20350 | 25RB#12 | 21.60 | PASS |
| Band4 | 10MHz | 16QAM | 20350 | 25RB#25 | 21.44 | PASS |
| Band4 | 10MHz | 16QAM | 20350 | 50RB#0 | 21.34 | PASS |
| Band4 | 15MHz | QPSK | 20025 | 1RB#0 | 23.02 | PASS |
| Band4 | 15MHz | QPSK | 20025 | 1RB#38 | 23.08 | PASS |
| Band4 | 15MHz | QPSK | 20025 | 1RB#74 | 23.22 | PASS |
| Band4 | 15MHz | QPSK | 20025 | 38RB#0 | 22.22 | PASS |
| Band4 | 15MHz | QPSK | 20025 | 38RB#18 | 22.23 | PASS |
| Band4 | 15MHz | QPSK | 20025 | 38RB#37 | 22.20 | PASS |
| Band4 | 15MHz | QPSK | 20025 | 75RB#0 | 22.31 | PASS |
| Band4 | 15MHz | QPSK | 20175 | 1RB#0 | 23.54 | PASS |
| Band4 | 15MHz | QPSK | 20175 | 1RB#38 | 23.50 | PASS |
| Band4 | 15MHz | QPSK | 20175 | 1RB#74 | 23.02 | PASS |
| Band4 | 15MHz | QPSK | 20175 | 38RB#0 | 22.51 | PASS |
| Band4 | 15MHz | QPSK | 20175 | 38RB#18 | 22.46 | PASS |
| Band4 | 15MHz | QPSK | 20175 | 38RB#37 | 22.54 | PASS |
| Band4 | 15MHz | QPSK | 20175 | 75RB#0 | 22.51 | PASS |
| Band4 | 15MHz | QPSK | 20325 | 1RB#0 | 23.52 | PASS |
| Band4 | 15MHz | QPSK | 20325 | 1RB#38 | 23.28 | PASS |
| Band4 | 15MHz | QPSK | 20325 | 1RB#74 | 23.18 | PASS |
| Band4 | 15MHz | QPSK | 20325 | 38RB#0 | 22.64 | PASS |
| Band4 | 15MHz | QPSK | 20325 | 38RB#18 | 22.42 | PASS |
| Band4 | 15MHz | QPSK | 20325 | 38RB#37 | 22.30 | PASS |
| Band4 | 15MHz | QPSK | 20325 | 75RB#0 | 22.53 | PASS |
| Band4 | 15MHz | 16QAM | 20025 | 1RB#0 | 22.20 | PASS |
| Band4 | 15MHz | 16QAM | 20025 | 1RB#38 | 22.00 | PASS |
| Band4 | 15MHz | 16QAM | 20025 | 1RB#74 | 22.35 | PASS |
| Band4 | 15MHz | 16QAM | 20025 | 38RB#0 | 22.21 | PASS |
| Band4 | 15MHz | 16QAM | 20025 | 38RB#18 | 22.23 | PASS |
| Band4 | 15MHz | 16QAM | 20025 | 38RB#37 | 22.39 | PASS |
| Band4 | 15MHz | 16QAM | 20025 | 75RB#0 | 21.38 | PASS |
| Band4 | 15MHz | 16QAM | 20175 | 1RB#0 | 22.46 | PASS |
| Band4 | 15MHz | 16QAM | 20175 | 1RB#38 | 22.48 | PASS |
| Band4 | 15MHz | 16QAM | 20175 | 1RB#74 | 22.55 | PASS |
| Band4 | 15MHz | 16QAM | 20175 | 38RB#0 | 22.51 | PASS |
| Band4 | 15MHz | 16QAM | 20175 | 38RB#18 | 22.45 | PASS |

| | | | | | | |
|-------|-------|-------|-------|---------|-------|------|
| Band4 | 15MHz | 16QAM | 20175 | 38RB#37 | 22.53 | PASS |
| Band4 | 15MHz | 16QAM | 20175 | 75RB#0 | 21.45 | PASS |
| Band4 | 15MHz | 16QAM | 20325 | 1RB#0 | 22.64 | PASS |
| Band4 | 15MHz | 16QAM | 20325 | 1RB#38 | 22.42 | PASS |
| Band4 | 15MHz | 16QAM | 20325 | 1RB#74 | 22.49 | PASS |
| Band4 | 15MHz | 16QAM | 20325 | 38RB#0 | 22.63 | PASS |
| Band4 | 15MHz | 16QAM | 20325 | 38RB#18 | 22.43 | PASS |
| Band4 | 15MHz | 16QAM | 20325 | 38RB#37 | 22.31 | PASS |
| Band4 | 15MHz | 16QAM | 20325 | 75RB#0 | 21.40 | PASS |
| Band4 | 20MHz | QPSK | 20050 | 1RB#0 | 22.95 | PASS |
| Band4 | 20MHz | QPSK | 20050 | 1RB#49 | 23.35 | PASS |
| Band4 | 20MHz | QPSK | 20050 | 1RB#99 | 23.39 | PASS |
| Band4 | 20MHz | QPSK | 20050 | 50RB#0 | 22.30 | PASS |
| Band4 | 20MHz | QPSK | 20050 | 50RB#25 | 22.31 | PASS |
| Band4 | 20MHz | QPSK | 20050 | 50RB#50 | 22.55 | PASS |
| Band4 | 20MHz | QPSK | 20050 | 100RB#0 | 22.48 | PASS |
| Band4 | 20MHz | QPSK | 20175 | 1RB#0 | 23.50 | PASS |
| Band4 | 20MHz | QPSK | 20175 | 1RB#49 | 23.79 | PASS |
| Band4 | 20MHz | QPSK | 20175 | 1RB#99 | 23.49 | PASS |
| Band4 | 20MHz | QPSK | 20175 | 50RB#0 | 22.58 | PASS |
| Band4 | 20MHz | QPSK | 20175 | 50RB#25 | 22.55 | PASS |
| Band4 | 20MHz | QPSK | 20175 | 50RB#50 | 22.60 | PASS |
| Band4 | 20MHz | QPSK | 20175 | 100RB#0 | 22.59 | PASS |
| Band4 | 20MHz | QPSK | 20300 | 1RB#0 | 23.64 | PASS |
| Band4 | 20MHz | QPSK | 20300 | 1RB#49 | 23.67 | PASS |
| Band4 | 20MHz | QPSK | 20300 | 1RB#99 | 23.47 | PASS |
| Band4 | 20MHz | QPSK | 20300 | 50RB#0 | 22.63 | PASS |
| Band4 | 20MHz | QPSK | 20300 | 50RB#25 | 22.62 | PASS |
| Band4 | 20MHz | QPSK | 20300 | 50RB#50 | 22.58 | PASS |
| Band4 | 20MHz | QPSK | 20300 | 100RB#0 | 22.62 | PASS |
| Band4 | 20MHz | 16QAM | 20050 | 1RB#0 | 22.67 | PASS |
| Band4 | 20MHz | 16QAM | 20050 | 1RB#49 | 23.34 | PASS |
| Band4 | 20MHz | 16QAM | 20050 | 1RB#99 | 22.99 | PASS |
| Band4 | 20MHz | 16QAM | 20050 | 50RB#0 | 21.34 | PASS |
| Band4 | 20MHz | 16QAM | 20050 | 50RB#25 | 21.18 | PASS |
| Band4 | 20MHz | 16QAM | 20050 | 50RB#50 | 21.42 | PASS |
| Band4 | 20MHz | 16QAM | 20050 | 100RB#0 | 21.35 | PASS |
| Band4 | 20MHz | 16QAM | 20175 | 1RB#0 | 22.12 | PASS |

| | | | | | | |
|-------|--------|-------|-------|---------|-------|------|
| Band4 | 20MHz | 16QAM | 20175 | 1RB#49 | 23.27 | PASS |
| Band4 | 20MHz | 16QAM | 20175 | 1RB#99 | 22.56 | PASS |
| Band4 | 20MHz | 16QAM | 20175 | 50RB#0 | 21.53 | PASS |
| Band4 | 20MHz | 16QAM | 20175 | 50RB#25 | 21.52 | PASS |
| Band4 | 20MHz | 16QAM | 20175 | 50RB#50 | 21.63 | PASS |
| Band4 | 20MHz | 16QAM | 20175 | 100RB#0 | 21.52 | PASS |
| Band4 | 20MHz | 16QAM | 20300 | 1RB#0 | 23.22 | PASS |
| Band4 | 20MHz | 16QAM | 20300 | 1RB#49 | 23.49 | PASS |
| Band4 | 20MHz | 16QAM | 20300 | 1RB#99 | 23.08 | PASS |
| Band4 | 20MHz | 16QAM | 20300 | 50RB#0 | 21.60 | PASS |
| Band4 | 20MHz | 16QAM | 20300 | 50RB#25 | 21.68 | PASS |
| Band4 | 20MHz | 16QAM | 20300 | 50RB#50 | 21.45 | PASS |
| Band4 | 20MHz | 16QAM | 20300 | 100RB#0 | 21.56 | PASS |
| Band5 | 1.4MHz | QPSK | 20407 | 1RB#0 | 22.68 | PASS |
| Band5 | 1.4MHz | QPSK | 20407 | 1RB#2 | 22.69 | PASS |
| Band5 | 1.4MHz | QPSK | 20407 | 1RB#5 | 22.79 | PASS |
| Band5 | 1.4MHz | QPSK | 20407 | 3RB#0 | 22.86 | PASS |
| Band5 | 1.4MHz | QPSK | 20407 | 3RB#1 | 22.84 | PASS |
| Band5 | 1.4MHz | QPSK | 20407 | 3RB#3 | 22.68 | PASS |
| Band5 | 1.4MHz | QPSK | 20407 | 6RB#0 | 21.96 | PASS |
| Band5 | 1.4MHz | QPSK | 20525 | 1RB#0 | 23.07 | PASS |
| Band5 | 1.4MHz | QPSK | 20525 | 1RB#2 | 23.03 | PASS |
| Band5 | 1.4MHz | QPSK | 20525 | 1RB#5 | 23.20 | PASS |
| Band5 | 1.4MHz | QPSK | 20525 | 3RB#0 | 23.06 | PASS |
| Band5 | 1.4MHz | QPSK | 20525 | 3RB#1 | 23.04 | PASS |
| Band5 | 1.4MHz | QPSK | 20525 | 3RB#3 | 23.04 | PASS |
| Band5 | 1.4MHz | QPSK | 20525 | 6RB#0 | 22.24 | PASS |
| Band5 | 1.4MHz | QPSK | 20643 | 1RB#0 | 22.93 | PASS |
| Band5 | 1.4MHz | QPSK | 20643 | 1RB#2 | 22.76 | PASS |
| Band5 | 1.4MHz | QPSK | 20643 | 1RB#5 | 22.90 | PASS |
| Band5 | 1.4MHz | QPSK | 20643 | 3RB#0 | 22.97 | PASS |
| Band5 | 1.4MHz | QPSK | 20643 | 3RB#1 | 22.94 | PASS |
| Band5 | 1.4MHz | QPSK | 20643 | 3RB#3 | 22.93 | PASS |
| Band5 | 1.4MHz | QPSK | 20643 | 6RB#0 | 22.10 | PASS |
| Band5 | 1.4MHz | 16QAM | 20407 | 1RB#0 | 21.83 | PASS |
| Band5 | 1.4MHz | 16QAM | 20407 | 1RB#2 | 22.27 | PASS |
| Band5 | 1.4MHz | 16QAM | 20407 | 1RB#5 | 21.81 | PASS |
| Band5 | 1.4MHz | 16QAM | 20407 | 3RB#0 | 21.69 | PASS |

| | | | | | | |
|-------|--------|-------|-------|--------|-------|------|
| Band5 | 1.4MHz | 16QAM | 20407 | 3RB#1 | 21.49 | PASS |
| Band5 | 1.4MHz | 16QAM | 20407 | 3RB#3 | 21.73 | PASS |
| Band5 | 1.4MHz | 16QAM | 20407 | 6RB#0 | 21.05 | PASS |
| Band5 | 1.4MHz | 16QAM | 20525 | 1RB#0 | 21.70 | PASS |
| Band5 | 1.4MHz | 16QAM | 20525 | 1RB#2 | 22.07 | PASS |
| Band5 | 1.4MHz | 16QAM | 20525 | 1RB#5 | 21.84 | PASS |
| Band5 | 1.4MHz | 16QAM | 20525 | 3RB#0 | 22.05 | PASS |
| Band5 | 1.4MHz | 16QAM | 20525 | 3RB#1 | 22.04 | PASS |
| Band5 | 1.4MHz | 16QAM | 20525 | 3RB#3 | 22.04 | PASS |
| Band5 | 1.4MHz | 16QAM | 20525 | 6RB#0 | 21.09 | PASS |
| Band5 | 1.4MHz | 16QAM | 20643 | 1RB#0 | 22.15 | PASS |
| Band5 | 1.4MHz | 16QAM | 20643 | 1RB#2 | 21.90 | PASS |
| Band5 | 1.4MHz | 16QAM | 20643 | 1RB#5 | 21.82 | PASS |
| Band5 | 1.4MHz | 16QAM | 20643 | 3RB#0 | 21.95 | PASS |
| Band5 | 1.4MHz | 16QAM | 20643 | 3RB#1 | 21.93 | PASS |
| Band5 | 1.4MHz | 16QAM | 20643 | 3RB#3 | 21.98 | PASS |
| Band5 | 1.4MHz | 16QAM | 20643 | 6RB#0 | 21.01 | PASS |
| Band5 | 3MHz | QPSK | 20415 | 1RB#0 | 22.69 | PASS |
| Band5 | 3MHz | QPSK | 20415 | 1RB#8 | 22.83 | PASS |
| Band5 | 3MHz | QPSK | 20415 | 1RB#14 | 22.79 | PASS |
| Band5 | 3MHz | QPSK | 20415 | 8RB#0 | 21.96 | PASS |
| Band5 | 3MHz | QPSK | 20415 | 8RB#4 | 21.83 | PASS |
| Band5 | 3MHz | QPSK | 20415 | 8RB#7 | 21.87 | PASS |
| Band5 | 3MHz | QPSK | 20415 | 15RB#0 | 22.05 | PASS |
| Band5 | 3MHz | QPSK | 20525 | 1RB#0 | 22.93 | PASS |
| Band5 | 3MHz | QPSK | 20525 | 1RB#8 | 23.03 | PASS |
| Band5 | 3MHz | QPSK | 20525 | 1RB#14 | 22.99 | PASS |
| Band5 | 3MHz | QPSK | 20525 | 8RB#0 | 22.13 | PASS |
| Band5 | 3MHz | QPSK | 20525 | 8RB#4 | 22.23 | PASS |
| Band5 | 3MHz | QPSK | 20525 | 8RB#7 | 22.14 | PASS |
| Band5 | 3MHz | QPSK | 20525 | 15RB#0 | 22.02 | PASS |
| Band5 | 3MHz | QPSK | 20635 | 1RB#0 | 22.99 | PASS |
| Band5 | 3MHz | QPSK | 20635 | 1RB#8 | 22.84 | PASS |
| Band5 | 3MHz | QPSK | 20635 | 1RB#14 | 22.93 | PASS |
| Band5 | 3MHz | QPSK | 20635 | 8RB#0 | 22.09 | PASS |
| Band5 | 3MHz | QPSK | 20635 | 8RB#4 | 22.11 | PASS |
| Band5 | 3MHz | QPSK | 20635 | 8RB#7 | 21.99 | PASS |
| Band5 | 3MHz | QPSK | 20635 | 15RB#0 | 22.00 | PASS |

| | | | | | | |
|-------|------|-------|-------|---------|-------|------|
| Band5 | 3MHz | 16QAM | 20415 | 1RB#0 | 21.40 | PASS |
| Band5 | 3MHz | 16QAM | 20415 | 1RB#8 | 22.29 | PASS |
| Band5 | 3MHz | 16QAM | 20415 | 1RB#14 | 21.99 | PASS |
| Band5 | 3MHz | 16QAM | 20415 | 8RB#0 | 21.06 | PASS |
| Band5 | 3MHz | 16QAM | 20415 | 8RB#4 | 20.75 | PASS |
| Band5 | 3MHz | 16QAM | 20415 | 8RB#7 | 20.96 | PASS |
| Band5 | 3MHz | 16QAM | 20415 | 15RB#0 | 20.89 | PASS |
| Band5 | 3MHz | 16QAM | 20525 | 1RB#0 | 21.93 | PASS |
| Band5 | 3MHz | 16QAM | 20525 | 1RB#8 | 22.23 | PASS |
| Band5 | 3MHz | 16QAM | 20525 | 1RB#14 | 21.78 | PASS |
| Band5 | 3MHz | 16QAM | 20525 | 8RB#0 | 21.30 | PASS |
| Band5 | 3MHz | 16QAM | 20525 | 8RB#4 | 21.17 | PASS |
| Band5 | 3MHz | 16QAM | 20525 | 8RB#7 | 21.24 | PASS |
| Band5 | 3MHz | 16QAM | 20525 | 15RB#0 | 21.02 | PASS |
| Band5 | 3MHz | 16QAM | 20635 | 1RB#0 | 21.96 | PASS |
| Band5 | 3MHz | 16QAM | 20635 | 1RB#8 | 22.03 | PASS |
| Band5 | 3MHz | 16QAM | 20635 | 1RB#14 | 22.07 | PASS |
| Band5 | 3MHz | 16QAM | 20635 | 8RB#0 | 20.87 | PASS |
| Band5 | 3MHz | 16QAM | 20635 | 8RB#4 | 20.88 | PASS |
| Band5 | 3MHz | 16QAM | 20635 | 8RB#7 | 20.85 | PASS |
| Band5 | 3MHz | 16QAM | 20635 | 15RB#0 | 21.00 | PASS |
| Band5 | 5MHz | QPSK | 20425 | 1RB#0 | 22.92 | PASS |
| Band5 | 5MHz | QPSK | 20425 | 1RB#12 | 23.09 | PASS |
| Band5 | 5MHz | QPSK | 20425 | 1RB#24 | 22.79 | PASS |
| Band5 | 5MHz | QPSK | 20425 | 12RB#0 | 21.91 | PASS |
| Band5 | 5MHz | QPSK | 20425 | 12RB#6 | 21.92 | PASS |
| Band5 | 5MHz | QPSK | 20425 | 12RB#13 | 21.97 | PASS |
| Band5 | 5MHz | QPSK | 20425 | 25RB#0 | 21.94 | PASS |
| Band5 | 5MHz | QPSK | 20525 | 1RB#0 | 22.93 | PASS |
| Band5 | 5MHz | QPSK | 20525 | 1RB#12 | 23.22 | PASS |
| Band5 | 5MHz | QPSK | 20525 | 1RB#24 | 22.84 | PASS |
| Band5 | 5MHz | QPSK | 20525 | 12RB#0 | 22.09 | PASS |
| Band5 | 5MHz | QPSK | 20525 | 12RB#6 | 22.16 | PASS |
| Band5 | 5MHz | QPSK | 20525 | 12RB#13 | 22.11 | PASS |
| Band5 | 5MHz | QPSK | 20525 | 25RB#0 | 22.12 | PASS |
| Band5 | 5MHz | QPSK | 20625 | 1RB#0 | 23.10 | PASS |
| Band5 | 5MHz | QPSK | 20625 | 1RB#12 | 22.86 | PASS |
| Band5 | 5MHz | QPSK | 20625 | 1RB#24 | 22.80 | PASS |

| | | | | | | |
|-------|-------|-------|-------|---------|-------|------|
| Band5 | 5MHz | QPSK | 20625 | 12RB#0 | 22.10 | PASS |
| Band5 | 5MHz | QPSK | 20625 | 12RB#6 | 22.13 | PASS |
| Band5 | 5MHz | QPSK | 20625 | 12RB#13 | 22.10 | PASS |
| Band5 | 5MHz | QPSK | 20625 | 25RB#0 | 22.00 | PASS |
| Band5 | 5MHz | 16QAM | 20425 | 1RB#0 | 21.79 | PASS |
| Band5 | 5MHz | 16QAM | 20425 | 1RB#12 | 22.07 | PASS |
| Band5 | 5MHz | 16QAM | 20425 | 1RB#24 | 21.61 | PASS |
| Band5 | 5MHz | 16QAM | 20425 | 12RB#0 | 21.07 | PASS |
| Band5 | 5MHz | 16QAM | 20425 | 12RB#6 | 21.06 | PASS |
| Band5 | 5MHz | 16QAM | 20425 | 12RB#13 | 21.10 | PASS |
| Band5 | 5MHz | 16QAM | 20425 | 25RB#0 | 21.01 | PASS |
| Band5 | 5MHz | 16QAM | 20525 | 1RB#0 | 21.90 | PASS |
| Band5 | 5MHz | 16QAM | 20525 | 1RB#12 | 22.54 | PASS |
| Band5 | 5MHz | 16QAM | 20525 | 1RB#24 | 22.00 | PASS |
| Band5 | 5MHz | 16QAM | 20525 | 12RB#0 | 21.19 | PASS |
| Band5 | 5MHz | 16QAM | 20525 | 12RB#6 | 20.97 | PASS |
| Band5 | 5MHz | 16QAM | 20525 | 12RB#13 | 21.15 | PASS |
| Band5 | 5MHz | 16QAM | 20525 | 25RB#0 | 21.19 | PASS |
| Band5 | 5MHz | 16QAM | 20625 | 1RB#0 | 22.15 | PASS |
| Band5 | 5MHz | 16QAM | 20625 | 1RB#12 | 22.09 | PASS |
| Band5 | 5MHz | 16QAM | 20625 | 1RB#24 | 21.76 | PASS |
| Band5 | 5MHz | 16QAM | 20625 | 12RB#0 | 20.98 | PASS |
| Band5 | 5MHz | 16QAM | 20625 | 12RB#6 | 20.99 | PASS |
| Band5 | 5MHz | 16QAM | 20625 | 12RB#13 | 21.06 | PASS |
| Band5 | 5MHz | 16QAM | 20625 | 25RB#0 | 20.99 | PASS |
| Band5 | 10MHz | QPSK | 20450 | 1RB#0 | 22.73 | PASS |
| Band5 | 10MHz | QPSK | 20450 | 1RB#24 | 22.89 | PASS |
| Band5 | 10MHz | QPSK | 20450 | 1RB#49 | 22.89 | PASS |
| Band5 | 10MHz | QPSK | 20450 | 25RB#0 | 22.07 | PASS |
| Band5 | 10MHz | QPSK | 20450 | 25RB#12 | 22.10 | PASS |
| Band5 | 10MHz | QPSK | 20450 | 25RB#25 | 22.12 | PASS |
| Band5 | 10MHz | QPSK | 20450 | 50RB#0 | 22.07 | PASS |
| Band5 | 10MHz | QPSK | 20525 | 1RB#0 | 22.95 | PASS |
| Band5 | 10MHz | QPSK | 20525 | 1RB#24 | 23.22 | PASS |
| Band5 | 10MHz | QPSK | 20525 | 1RB#49 | 23.27 | PASS |
| Band5 | 10MHz | QPSK | 20525 | 25RB#0 | 22.13 | PASS |
| Band5 | 10MHz | QPSK | 20525 | 25RB#12 | 22.09 | PASS |
| Band5 | 10MHz | QPSK | 20525 | 25RB#25 | 22.10 | PASS |

| | | | | | | |
|--------|--------|-------|-------|---------|-------|------|
| Band5 | 10MHz | QPSK | 20525 | 50RB#0 | 22.17 | PASS |
| Band5 | 10MHz | QPSK | 20600 | 1RB#0 | 22.93 | PASS |
| Band5 | 10MHz | QPSK | 20600 | 1RB#24 | 23.48 | PASS |
| Band5 | 10MHz | QPSK | 20600 | 1RB#49 | 22.84 | PASS |
| Band5 | 10MHz | QPSK | 20600 | 25RB#0 | 22.09 | PASS |
| Band5 | 10MHz | QPSK | 20600 | 25RB#12 | 22.06 | PASS |
| Band5 | 10MHz | QPSK | 20600 | 25RB#25 | 22.17 | PASS |
| Band5 | 10MHz | QPSK | 20600 | 50RB#0 | 22.23 | PASS |
| Band5 | 10MHz | 16QAM | 20450 | 1RB#0 | 21.84 | PASS |
| Band5 | 10MHz | 16QAM | 20450 | 1RB#24 | 22.33 | PASS |
| Band5 | 10MHz | 16QAM | 20450 | 1RB#49 | 22.21 | PASS |
| Band5 | 10MHz | 16QAM | 20450 | 25RB#0 | 21.03 | PASS |
| Band5 | 10MHz | 16QAM | 20450 | 25RB#12 | 21.04 | PASS |
| Band5 | 10MHz | 16QAM | 20450 | 25RB#25 | 20.99 | PASS |
| Band5 | 10MHz | 16QAM | 20450 | 50RB#0 | 20.93 | PASS |
| Band5 | 10MHz | 16QAM | 20525 | 1RB#0 | 21.89 | PASS |
| Band5 | 10MHz | 16QAM | 20525 | 1RB#24 | 22.48 | PASS |
| Band5 | 10MHz | 16QAM | 20525 | 1RB#49 | 22.10 | PASS |
| Band5 | 10MHz | 16QAM | 20525 | 25RB#0 | 21.12 | PASS |
| Band5 | 10MHz | 16QAM | 20525 | 25RB#12 | 21.19 | PASS |
| Band5 | 10MHz | 16QAM | 20525 | 25RB#25 | 21.21 | PASS |
| Band5 | 10MHz | 16QAM | 20525 | 50RB#0 | 21.10 | PASS |
| Band5 | 10MHz | 16QAM | 20600 | 1RB#0 | 22.11 | PASS |
| Band5 | 10MHz | 16QAM | 20600 | 1RB#24 | 22.84 | PASS |
| Band5 | 10MHz | 16QAM | 20600 | 1RB#49 | 22.12 | PASS |
| Band5 | 10MHz | 16QAM | 20600 | 25RB#0 | 21.03 | PASS |
| Band5 | 10MHz | 16QAM | 20600 | 25RB#12 | 21.05 | PASS |
| Band5 | 10MHz | 16QAM | 20600 | 25RB#25 | 20.91 | PASS |
| Band5 | 10MHz | 16QAM | 20600 | 50RB#0 | 21.00 | PASS |
| Band12 | 1.4MHz | QPSK | 23017 | 1RB#0 | 23.04 | PASS |
| Band12 | 1.4MHz | QPSK | 23017 | 1RB#2 | 23.44 | PASS |
| Band12 | 1.4MHz | QPSK | 23017 | 1RB#5 | 23.10 | PASS |
| Band12 | 1.4MHz | QPSK | 23017 | 3RB#0 | 23.17 | PASS |
| Band12 | 1.4MHz | QPSK | 23017 | 3RB#1 | 23.05 | PASS |
| Band12 | 1.4MHz | QPSK | 23017 | 3RB#3 | 23.08 | PASS |
| Band12 | 1.4MHz | QPSK | 23017 | 6RB#0 | 22.22 | PASS |
| Band12 | 1.4MHz | QPSK | 23095 | 1RB#0 | 23.19 | PASS |
| Band12 | 1.4MHz | QPSK | 23095 | 1RB#2 | 23.38 | PASS |

| | | | | | | |
|--------|--------|-------|-------|--------|-------|------|
| Band12 | 1.4MHz | QPSK | 23095 | 1RB#5 | 23.29 | PASS |
| Band12 | 1.4MHz | QPSK | 23095 | 3RB#0 | 23.35 | PASS |
| Band12 | 1.4MHz | QPSK | 23095 | 3RB#1 | 23.20 | PASS |
| Band12 | 1.4MHz | QPSK | 23095 | 3RB#3 | 23.24 | PASS |
| Band12 | 1.4MHz | QPSK | 23095 | 6RB#0 | 22.38 | PASS |
| Band12 | 1.4MHz | QPSK | 23173 | 1RB#0 | 23.03 | PASS |
| Band12 | 1.4MHz | QPSK | 23173 | 1RB#2 | 23.17 | PASS |
| Band12 | 1.4MHz | QPSK | 23173 | 1RB#5 | 23.06 | PASS |
| Band12 | 1.4MHz | QPSK | 23173 | 3RB#0 | 23.14 | PASS |
| Band12 | 1.4MHz | QPSK | 23173 | 3RB#1 | 23.11 | PASS |
| Band12 | 1.4MHz | QPSK | 23173 | 3RB#3 | 23.14 | PASS |
| Band12 | 1.4MHz | QPSK | 23173 | 6RB#0 | 22.29 | PASS |
| Band12 | 1.4MHz | 16QAM | 23017 | 1RB#0 | 21.92 | PASS |
| Band12 | 1.4MHz | 16QAM | 23017 | 1RB#2 | 22.15 | PASS |
| Band12 | 1.4MHz | 16QAM | 23017 | 1RB#5 | 22.12 | PASS |
| Band12 | 1.4MHz | 16QAM | 23017 | 3RB#0 | 22.09 | PASS |
| Band12 | 1.4MHz | 16QAM | 23017 | 3RB#1 | 22.10 | PASS |
| Band12 | 1.4MHz | 16QAM | 23017 | 3RB#3 | 22.10 | PASS |
| Band12 | 1.4MHz | 16QAM | 23017 | 6RB#0 | 21.25 | PASS |
| Band12 | 1.4MHz | 16QAM | 23095 | 1RB#0 | 22.11 | PASS |
| Band12 | 1.4MHz | 16QAM | 23095 | 1RB#2 | 22.21 | PASS |
| Band12 | 1.4MHz | 16QAM | 23095 | 1RB#5 | 22.12 | PASS |
| Band12 | 1.4MHz | 16QAM | 23095 | 3RB#0 | 22.17 | PASS |
| Band12 | 1.4MHz | 16QAM | 23095 | 3RB#1 | 22.25 | PASS |
| Band12 | 1.4MHz | 16QAM | 23095 | 3RB#3 | 22.19 | PASS |
| Band12 | 1.4MHz | 16QAM | 23095 | 6RB#0 | 21.32 | PASS |
| Band12 | 1.4MHz | 16QAM | 23173 | 1RB#0 | 22.05 | PASS |
| Band12 | 1.4MHz | 16QAM | 23173 | 1RB#2 | 22.12 | PASS |
| Band12 | 1.4MHz | 16QAM | 23173 | 1RB#5 | 21.89 | PASS |
| Band12 | 1.4MHz | 16QAM | 23173 | 3RB#0 | 22.12 | PASS |
| Band12 | 1.4MHz | 16QAM | 23173 | 3RB#1 | 22.13 | PASS |
| Band12 | 1.4MHz | 16QAM | 23173 | 3RB#3 | 22.07 | PASS |
| Band12 | 1.4MHz | 16QAM | 23173 | 6RB#0 | 21.14 | PASS |
| Band12 | 3MHz | QPSK | 23025 | 1RB#0 | 23.06 | PASS |
| Band12 | 3MHz | QPSK | 23025 | 1RB#8 | 23.20 | PASS |
| Band12 | 3MHz | QPSK | 23025 | 1RB#14 | 23.10 | PASS |
| Band12 | 3MHz | QPSK | 23025 | 8RB#0 | 22.16 | PASS |
| Band12 | 3MHz | QPSK | 23025 | 8RB#4 | 22.16 | PASS |

| | | | | | | |
|--------|------|-------|-------|--------|-------|------|
| Band12 | 3MHz | QPSK | 23025 | 8RB#7 | 22.31 | PASS |
| Band12 | 3MHz | QPSK | 23025 | 15RB#0 | 22.33 | PASS |
| Band12 | 3MHz | QPSK | 23095 | 1RB#0 | 23.07 | PASS |
| Band12 | 3MHz | QPSK | 23095 | 1RB#8 | 23.53 | PASS |
| Band12 | 3MHz | QPSK | 23095 | 1RB#14 | 23.23 | PASS |
| Band12 | 3MHz | QPSK | 23095 | 8RB#0 | 22.40 | PASS |
| Band12 | 3MHz | QPSK | 23095 | 8RB#4 | 22.38 | PASS |
| Band12 | 3MHz | QPSK | 23095 | 8RB#7 | 22.51 | PASS |
| Band12 | 3MHz | QPSK | 23095 | 15RB#0 | 22.43 | PASS |
| Band12 | 3MHz | QPSK | 23165 | 1RB#0 | 23.28 | PASS |
| Band12 | 3MHz | QPSK | 23165 | 1RB#8 | 23.32 | PASS |
| Band12 | 3MHz | QPSK | 23165 | 1RB#14 | 23.13 | PASS |
| Band12 | 3MHz | QPSK | 23165 | 8RB#0 | 22.38 | PASS |
| Band12 | 3MHz | QPSK | 23165 | 8RB#4 | 22.37 | PASS |
| Band12 | 3MHz | QPSK | 23165 | 8RB#7 | 22.23 | PASS |
| Band12 | 3MHz | QPSK | 23165 | 15RB#0 | 22.26 | PASS |
| Band12 | 3MHz | 16QAM | 23025 | 1RB#0 | 22.00 | PASS |
| Band12 | 3MHz | 16QAM | 23025 | 1RB#8 | 22.68 | PASS |
| Band12 | 3MHz | 16QAM | 23025 | 1RB#14 | 22.28 | PASS |
| Band12 | 3MHz | 16QAM | 23025 | 8RB#0 | 21.31 | PASS |
| Band12 | 3MHz | 16QAM | 23025 | 8RB#4 | 21.25 | PASS |
| Band12 | 3MHz | 16QAM | 23025 | 8RB#7 | 21.37 | PASS |
| Band12 | 3MHz | 16QAM | 23025 | 15RB#0 | 21.41 | PASS |
| Band12 | 3MHz | 16QAM | 23095 | 1RB#0 | 22.17 | PASS |
| Band12 | 3MHz | 16QAM | 23095 | 1RB#8 | 22.24 | PASS |
| Band12 | 3MHz | 16QAM | 23095 | 1RB#14 | 22.02 | PASS |
| Band12 | 3MHz | 16QAM | 23095 | 8RB#0 | 21.36 | PASS |
| Band12 | 3MHz | 16QAM | 23095 | 8RB#4 | 21.34 | PASS |
| Band12 | 3MHz | 16QAM | 23095 | 8RB#7 | 21.25 | PASS |
| Band12 | 3MHz | 16QAM | 23095 | 15RB#0 | 21.42 | PASS |
| Band12 | 3MHz | 16QAM | 23165 | 1RB#0 | 22.70 | PASS |
| Band12 | 3MHz | 16QAM | 23165 | 1RB#8 | 22.57 | PASS |
| Band12 | 3MHz | 16QAM | 23165 | 1RB#14 | 22.63 | PASS |
| Band12 | 3MHz | 16QAM | 23165 | 8RB#0 | 21.22 | PASS |
| Band12 | 3MHz | 16QAM | 23165 | 8RB#4 | 21.11 | PASS |
| Band12 | 3MHz | 16QAM | 23165 | 8RB#7 | 21.28 | PASS |
| Band12 | 3MHz | 16QAM | 23165 | 15RB#0 | 21.15 | PASS |
| Band12 | 5MHz | QPSK | 23035 | 1RB#0 | 23.20 | PASS |

| | | | | | | |
|--------|------|-------|-------|---------|-------|------|
| Band12 | 5MHz | QPSK | 23035 | 1RB#12 | 23.42 | PASS |
| Band12 | 5MHz | QPSK | 23035 | 1RB#24 | 23.36 | PASS |
| Band12 | 5MHz | QPSK | 23035 | 12RB#0 | 22.23 | PASS |
| Band12 | 5MHz | QPSK | 23035 | 12RB#6 | 22.24 | PASS |
| Band12 | 5MHz | QPSK | 23035 | 12RB#13 | 22.28 | PASS |
| Band12 | 5MHz | QPSK | 23035 | 25RB#0 | 22.28 | PASS |
| Band12 | 5MHz | QPSK | 23095 | 1RB#0 | 23.10 | PASS |
| Band12 | 5MHz | QPSK | 23095 | 1RB#12 | 23.35 | PASS |
| Band12 | 5MHz | QPSK | 23095 | 1RB#24 | 23.23 | PASS |
| Band12 | 5MHz | QPSK | 23095 | 12RB#0 | 22.33 | PASS |
| Band12 | 5MHz | QPSK | 23095 | 12RB#6 | 22.32 | PASS |
| Band12 | 5MHz | QPSK | 23095 | 12RB#13 | 22.40 | PASS |
| Band12 | 5MHz | QPSK | 23095 | 25RB#0 | 22.35 | PASS |
| Band12 | 5MHz | QPSK | 23155 | 1RB#0 | 23.21 | PASS |
| Band12 | 5MHz | QPSK | 23155 | 1RB#12 | 23.25 | PASS |
| Band12 | 5MHz | QPSK | 23155 | 1RB#24 | 23.04 | PASS |
| Band12 | 5MHz | QPSK | 23155 | 12RB#0 | 22.26 | PASS |
| Band12 | 5MHz | QPSK | 23155 | 12RB#6 | 22.33 | PASS |
| Band12 | 5MHz | QPSK | 23155 | 12RB#13 | 22.16 | PASS |
| Band12 | 5MHz | QPSK | 23155 | 25RB#0 | 22.25 | PASS |
| Band12 | 5MHz | 16QAM | 23035 | 1RB#0 | 22.31 | PASS |
| Band12 | 5MHz | 16QAM | 23035 | 1RB#12 | 22.12 | PASS |
| Band12 | 5MHz | 16QAM | 23035 | 1RB#24 | 22.36 | PASS |
| Band12 | 5MHz | 16QAM | 23035 | 12RB#0 | 21.27 | PASS |
| Band12 | 5MHz | 16QAM | 23035 | 12RB#6 | 21.13 | PASS |
| Band12 | 5MHz | 16QAM | 23035 | 12RB#13 | 21.30 | PASS |
| Band12 | 5MHz | 16QAM | 23035 | 25RB#0 | 21.31 | PASS |
| Band12 | 5MHz | 16QAM | 23095 | 1RB#0 | 22.12 | PASS |
| Band12 | 5MHz | 16QAM | 23095 | 1RB#12 | 22.42 | PASS |
| Band12 | 5MHz | 16QAM | 23095 | 1RB#24 | 22.22 | PASS |
| Band12 | 5MHz | 16QAM | 23095 | 12RB#0 | 21.11 | PASS |
| Band12 | 5MHz | 16QAM | 23095 | 12RB#6 | 21.18 | PASS |
| Band12 | 5MHz | 16QAM | 23095 | 12RB#13 | 21.30 | PASS |
| Band12 | 5MHz | 16QAM | 23095 | 25RB#0 | 21.37 | PASS |
| Band12 | 5MHz | 16QAM | 23155 | 1RB#0 | 22.21 | PASS |
| Band12 | 5MHz | 16QAM | 23155 | 1RB#12 | 22.22 | PASS |
| Band12 | 5MHz | 16QAM | 23155 | 1RB#24 | 22.03 | PASS |
| Band12 | 5MHz | 16QAM | 23155 | 12RB#0 | 21.19 | PASS |

| | | | | | | |
|--------|-------|-------|-------|---------|-------|------|
| Band12 | 5MHz | 16QAM | 23155 | 12RB#6 | 21.19 | PASS |
| Band12 | 5MHz | 16QAM | 23155 | 12RB#13 | 21.00 | PASS |
| Band12 | 5MHz | 16QAM | 23155 | 25RB#0 | 21.25 | PASS |
| Band12 | 10MHz | QPSK | 23060 | 1RB#0 | 22.91 | PASS |
| Band12 | 10MHz | QPSK | 23060 | 1RB#24 | 23.71 | PASS |
| Band12 | 10MHz | QPSK | 23060 | 1RB#49 | 23.28 | PASS |
| Band12 | 10MHz | QPSK | 23060 | 25RB#0 | 22.21 | PASS |
| Band12 | 10MHz | QPSK | 23060 | 25RB#12 | 22.22 | PASS |
| Band12 | 10MHz | QPSK | 23060 | 25RB#25 | 22.31 | PASS |
| Band12 | 10MHz | QPSK | 23060 | 50RB#0 | 22.26 | PASS |
| Band12 | 10MHz | QPSK | 23095 | 1RB#0 | 23.36 | PASS |
| Band12 | 10MHz | QPSK | 23095 | 1RB#24 | 23.51 | PASS |
| Band12 | 10MHz | QPSK | 23095 | 1RB#49 | 23.46 | PASS |
| Band12 | 10MHz | QPSK | 23095 | 25RB#0 | 22.24 | PASS |
| Band12 | 10MHz | QPSK | 23095 | 25RB#12 | 22.27 | PASS |
| Band12 | 10MHz | QPSK | 23095 | 25RB#25 | 22.44 | PASS |
| Band12 | 10MHz | QPSK | 23095 | 50RB#0 | 22.38 | PASS |
| Band12 | 10MHz | QPSK | 23130 | 1RB#0 | 23.07 | PASS |
| Band12 | 10MHz | QPSK | 23130 | 1RB#24 | 23.50 | PASS |
| Band12 | 10MHz | QPSK | 23130 | 1RB#49 | 23.01 | PASS |
| Band12 | 10MHz | QPSK | 23130 | 25RB#0 | 22.47 | PASS |
| Band12 | 10MHz | QPSK | 23130 | 25RB#12 | 22.47 | PASS |
| Band12 | 10MHz | QPSK | 23130 | 25RB#25 | 22.33 | PASS |
| Band12 | 10MHz | QPSK | 23130 | 50RB#0 | 22.46 | PASS |
| Band12 | 10MHz | 16QAM | 23060 | 1RB#0 | 21.92 | PASS |
| Band12 | 10MHz | 16QAM | 23060 | 1RB#24 | 22.58 | PASS |
| Band12 | 10MHz | 16QAM | 23060 | 1RB#49 | 22.28 | PASS |
| Band12 | 10MHz | 16QAM | 23060 | 25RB#0 | 21.32 | PASS |
| Band12 | 10MHz | 16QAM | 23060 | 25RB#12 | 21.31 | PASS |
| Band12 | 10MHz | 16QAM | 23060 | 25RB#25 | 21.28 | PASS |
| Band12 | 10MHz | 16QAM | 23060 | 50RB#0 | 21.24 | PASS |
| Band12 | 10MHz | 16QAM | 23095 | 1RB#0 | 22.20 | PASS |
| Band12 | 10MHz | 16QAM | 23095 | 1RB#24 | 22.85 | PASS |
| Band12 | 10MHz | 16QAM | 23095 | 1RB#49 | 22.25 | PASS |
| Band12 | 10MHz | 16QAM | 23095 | 25RB#0 | 21.28 | PASS |
| Band12 | 10MHz | 16QAM | 23095 | 25RB#12 | 21.30 | PASS |
| Band12 | 10MHz | 16QAM | 23095 | 25RB#25 | 21.40 | PASS |
| Band12 | 10MHz | 16QAM | 23095 | 50RB#0 | 21.43 | PASS |

| | | | | | | |
|--------|-------|-------|-------|---------|-------|------|
| Band12 | 10MHz | 16QAM | 23130 | 1RB#0 | 22.25 | PASS |
| Band12 | 10MHz | 16QAM | 23130 | 1RB#24 | 22.81 | PASS |
| Band12 | 10MHz | 16QAM | 23130 | 1RB#49 | 22.11 | PASS |
| Band12 | 10MHz | 16QAM | 23130 | 25RB#0 | 21.49 | PASS |
| Band12 | 10MHz | 16QAM | 23130 | 25RB#12 | 21.46 | PASS |
| Band12 | 10MHz | 16QAM | 23130 | 25RB#25 | 21.37 | PASS |
| Band12 | 10MHz | 16QAM | 23130 | 50RB#0 | 21.31 | PASS |
| Band17 | 5MHz | QPSK | 23755 | 1RB#0 | 23.36 | PASS |
| Band17 | 5MHz | QPSK | 23755 | 1RB#12 | 23.32 | PASS |
| Band17 | 5MHz | QPSK | 23755 | 1RB#24 | 23.28 | PASS |
| Band17 | 5MHz | QPSK | 23755 | 12RB#0 | 22.45 | PASS |
| Band17 | 5MHz | QPSK | 23755 | 12RB#6 | 22.44 | PASS |
| Band17 | 5MHz | QPSK | 23755 | 12RB#13 | 22.26 | PASS |
| Band17 | 5MHz | QPSK | 23755 | 25RB#0 | 22.27 | PASS |
| Band17 | 5MHz | QPSK | 23790 | 1RB#0 | 23.30 | PASS |
| Band17 | 5MHz | QPSK | 23790 | 1RB#12 | 23.42 | PASS |
| Band17 | 5MHz | QPSK | 23790 | 1RB#24 | 23.13 | PASS |
| Band17 | 5MHz | QPSK | 23790 | 12RB#0 | 22.29 | PASS |
| Band17 | 5MHz | QPSK | 23790 | 12RB#6 | 22.38 | PASS |
| Band17 | 5MHz | QPSK | 23790 | 12RB#13 | 22.38 | PASS |
| Band17 | 5MHz | QPSK | 23790 | 25RB#0 | 22.31 | PASS |
| Band17 | 5MHz | QPSK | 23825 | 1RB#0 | 23.29 | PASS |
| Band17 | 5MHz | QPSK | 23825 | 1RB#12 | 23.28 | PASS |
| Band17 | 5MHz | QPSK | 23825 | 1RB#24 | 23.06 | PASS |
| Band17 | 5MHz | QPSK | 23825 | 12RB#0 | 22.26 | PASS |
| Band17 | 5MHz | QPSK | 23825 | 12RB#6 | 22.20 | PASS |
| Band17 | 5MHz | QPSK | 23825 | 12RB#13 | 22.20 | PASS |
| Band17 | 5MHz | QPSK | 23825 | 25RB#0 | 22.22 | PASS |
| Band17 | 5MHz | 16QAM | 23755 | 1RB#0 | 22.22 | PASS |
| Band17 | 5MHz | 16QAM | 23755 | 1RB#12 | 22.22 | PASS |
| Band17 | 5MHz | 16QAM | 23755 | 1RB#24 | 22.14 | PASS |
| Band17 | 5MHz | 16QAM | 23755 | 12RB#0 | 21.42 | PASS |
| Band17 | 5MHz | 16QAM | 23755 | 12RB#6 | 21.41 | PASS |
| Band17 | 5MHz | 16QAM | 23755 | 12RB#13 | 21.11 | PASS |
| Band17 | 5MHz | 16QAM | 23755 | 25RB#0 | 21.37 | PASS |
| Band17 | 5MHz | 16QAM | 23790 | 1RB#0 | 22.34 | PASS |
| Band17 | 5MHz | 16QAM | 23790 | 1RB#12 | 22.16 | PASS |
| Band17 | 5MHz | 16QAM | 23790 | 1RB#24 | 22.39 | PASS |

| | | | | | | |
|--------|-------|-------|-------|---------|-------|------|
| Band17 | 5MHz | 16QAM | 23790 | 12RB#0 | 21.20 | PASS |
| Band17 | 5MHz | 16QAM | 23790 | 12RB#6 | 21.30 | PASS |
| Band17 | 5MHz | 16QAM | 23790 | 12RB#13 | 21.33 | PASS |
| Band17 | 5MHz | 16QAM | 23790 | 25RB#0 | 21.09 | PASS |
| Band17 | 5MHz | 16QAM | 23825 | 1RB#0 | 22.15 | PASS |
| Band17 | 5MHz | 16QAM | 23825 | 1RB#12 | 22.28 | PASS |
| Band17 | 5MHz | 16QAM | 23825 | 1RB#24 | 22.16 | PASS |
| Band17 | 5MHz | 16QAM | 23825 | 12RB#0 | 21.05 | PASS |
| Band17 | 5MHz | 16QAM | 23825 | 12RB#6 | 21.18 | PASS |
| Band17 | 5MHz | 16QAM | 23825 | 12RB#13 | 21.19 | PASS |
| Band17 | 5MHz | 16QAM | 23825 | 25RB#0 | 21.13 | PASS |
| Band17 | 10MHz | QPSK | 23780 | 1RB#0 | 23.33 | PASS |
| Band17 | 10MHz | QPSK | 23780 | 1RB#24 | 23.53 | PASS |
| Band17 | 10MHz | QPSK | 23780 | 1RB#49 | 23.01 | PASS |
| Band17 | 10MHz | QPSK | 23780 | 25RB#0 | 22.45 | PASS |
| Band17 | 10MHz | QPSK | 23780 | 25RB#12 | 22.42 | PASS |
| Band17 | 10MHz | QPSK | 23780 | 25RB#25 | 22.38 | PASS |
| Band17 | 10MHz | QPSK | 23780 | 50RB#0 | 22.40 | PASS |
| Band17 | 10MHz | QPSK | 23790 | 1RB#0 | 23.21 | PASS |
| Band17 | 10MHz | QPSK | 23790 | 1RB#24 | 23.55 | PASS |
| Band17 | 10MHz | QPSK | 23790 | 1RB#49 | 23.01 | PASS |
| Band17 | 10MHz | QPSK | 23790 | 25RB#0 | 22.37 | PASS |
| Band17 | 10MHz | QPSK | 23790 | 25RB#12 | 22.38 | PASS |
| Band17 | 10MHz | QPSK | 23790 | 25RB#25 | 22.35 | PASS |
| Band17 | 10MHz | QPSK | 23790 | 50RB#0 | 22.36 | PASS |
| Band17 | 10MHz | QPSK | 23800 | 1RB#0 | 23.19 | PASS |
| Band17 | 10MHz | QPSK | 23800 | 1RB#24 | 23.81 | PASS |
| Band17 | 10MHz | QPSK | 23800 | 1RB#49 | 23.12 | PASS |
| Band17 | 10MHz | QPSK | 23800 | 25RB#0 | 22.31 | PASS |
| Band17 | 10MHz | QPSK | 23800 | 25RB#12 | 22.32 | PASS |
| Band17 | 10MHz | QPSK | 23800 | 25RB#25 | 22.30 | PASS |
| Band17 | 10MHz | QPSK | 23800 | 50RB#0 | 22.34 | PASS |
| Band17 | 10MHz | 16QAM | 23780 | 1RB#0 | 22.39 | PASS |
| Band17 | 10MHz | 16QAM | 23780 | 1RB#24 | 22.60 | PASS |
| Band17 | 10MHz | 16QAM | 23780 | 1RB#49 | 22.21 | PASS |
| Band17 | 10MHz | 16QAM | 23780 | 25RB#0 | 21.39 | PASS |
| Band17 | 10MHz | 16QAM | 23780 | 25RB#12 | 21.43 | PASS |
| Band17 | 10MHz | 16QAM | 23780 | 25RB#25 | 21.22 | PASS |

| | | | | | | |
|--------|-------|-------|-------|---------|-------|------|
| Band17 | 10MHz | 16QAM | 23780 | 50RB#0 | 21.42 | PASS |
| Band17 | 10MHz | 16QAM | 23790 | 1RB#0 | 22.16 | PASS |
| Band17 | 10MHz | 16QAM | 23790 | 1RB#24 | 22.65 | PASS |
| Band17 | 10MHz | 16QAM | 23790 | 1RB#49 | 21.94 | PASS |
| Band17 | 10MHz | 16QAM | 23790 | 25RB#0 | 21.37 | PASS |
| Band17 | 10MHz | 16QAM | 23790 | 25RB#12 | 21.38 | PASS |
| Band17 | 10MHz | 16QAM | 23790 | 25RB#25 | 21.25 | PASS |
| Band17 | 10MHz | 16QAM | 23790 | 50RB#0 | 21.24 | PASS |
| Band17 | 10MHz | 16QAM | 23800 | 1RB#0 | 22.30 | PASS |
| Band17 | 10MHz | 16QAM | 23800 | 1RB#24 | 23.36 | PASS |
| Band17 | 10MHz | 16QAM | 23800 | 1RB#49 | 22.14 | PASS |
| Band17 | 10MHz | 16QAM | 23800 | 25RB#0 | 21.28 | PASS |
| Band17 | 10MHz | 16QAM | 23800 | 25RB#12 | 21.20 | PASS |
| Band17 | 10MHz | 16QAM | 23800 | 25RB#25 | 21.36 | PASS |
| Band17 | 10MHz | 16QAM | 23800 | 50RB#0 | 21.22 | PASS |

ATTACHMENT B--PEAK-AVERAGE RATIO

| Band | Bandwidth | Modulation | Channel | RB Configuration | Result(dB) | Limit(dB) | Verdict |
|-------|-----------|------------|---------|------------------|------------|-----------|---------|
| Band2 | 1.4MHz | QPSK | 18607 | 1RB#0 | 3.97 | 13 | PASS |
| Band2 | 1.4MHz | QPSK | 18607 | 6RB#0 | 5.16 | 13 | PASS |
| Band2 | 1.4MHz | QPSK | 18900 | 1RB#0 | 3.68 | 13 | PASS |
| Band2 | 1.4MHz | QPSK | 18900 | 6RB#0 | 4.75 | 13 | PASS |
| Band2 | 1.4MHz | QPSK | 19193 | 1RB#0 | 3.45 | 13 | PASS |
| Band2 | 1.4MHz | QPSK | 19193 | 6RB#0 | 4.61 | 13 | PASS |
| Band2 | 1.4MHz | 16QAM | 18607 | 1RB#0 | 5.07 | 13 | PASS |
| Band2 | 1.4MHz | 16QAM | 18607 | 6RB#0 | 6.06 | 13 | PASS |
| Band2 | 1.4MHz | 16QAM | 18900 | 1RB#0 | 4.64 | 13 | PASS |
| Band2 | 1.4MHz | 16QAM | 18900 | 6RB#0 | 5.68 | 13 | PASS |
| Band2 | 1.4MHz | 16QAM | 19193 | 1RB#0 | 4.52 | 13 | PASS |
| Band2 | 1.4MHz | 16QAM | 19193 | 6RB#0 | 5.59 | 13 | PASS |
| Band2 | 3MHz | QPSK | 18615 | 1RB#0 | 4.00 | 13 | PASS |
| Band2 | 3MHz | QPSK | 18615 | 15RB#0 | 5.28 | 13 | PASS |
| Band2 | 3MHz | QPSK | 18900 | 1RB#0 | 3.68 | 13 | PASS |
| Band2 | 3MHz | QPSK | 18900 | 15RB#0 | 4.87 | 13 | PASS |
| Band2 | 3MHz | QPSK | 19185 | 1RB#0 | 3.39 | 13 | PASS |
| Band2 | 3MHz | QPSK | 19185 | 15RB#0 | 4.55 | 13 | PASS |
| Band2 | 3MHz | 16QAM | 18615 | 1RB#0 | 4.87 | 13 | PASS |
| Band2 | 3MHz | 16QAM | 18615 | 15RB#0 | 6.14 | 13 | PASS |
| Band2 | 3MHz | 16QAM | 18900 | 1RB#0 | 4.70 | 13 | PASS |
| Band2 | 3MHz | 16QAM | 18900 | 15RB#0 | 5.74 | 13 | PASS |
| Band2 | 3MHz | 16QAM | 19185 | 1RB#0 | 4.35 | 13 | PASS |
| Band2 | 3MHz | 16QAM | 19185 | 15RB#0 | 5.57 | 13 | PASS |
| Band2 | 5MHz | QPSK | 18625 | 1RB#0 | 3.94 | 13 | PASS |
| Band2 | 5MHz | QPSK | 18625 | 25RB#0 | 5.22 | 13 | PASS |
| Band2 | 5MHz | QPSK | 18900 | 1RB#0 | 3.65 | 13 | PASS |
| Band2 | 5MHz | QPSK | 18900 | 25RB#0 | 4.75 | 13 | PASS |
| Band2 | 5MHz | QPSK | 19175 | 1RB#0 | 3.48 | 13 | PASS |
| Band2 | 5MHz | QPSK | 19175 | 25RB#0 | 4.49 | 13 | PASS |
| Band2 | 5MHz | 16QAM | 18625 | 1RB#0 | 4.96 | 13 | PASS |
| Band2 | 5MHz | 16QAM | 18625 | 25RB#0 | 6.12 | 13 | PASS |
| Band2 | 5MHz | 16QAM | 18900 | 1RB#0 | 4.55 | 13 | PASS |
| Band2 | 5MHz | 16QAM | 18900 | 25RB#0 | 5.68 | 13 | PASS |
| Band2 | 5MHz | 16QAM | 19175 | 1RB#0 | 4.38 | 13 | PASS |
| Band2 | 5MHz | 16QAM | 19175 | 25RB#0 | 5.42 | 13 | PASS |
| Band2 | 10MHz | QPSK | 18650 | 1RB#0 | 3.88 | 13 | PASS |
| Band2 | 10MHz | QPSK | 18650 | 50RB#0 | 5.28 | 13 | PASS |
| Band2 | 10MHz | QPSK | 18900 | 1RB#0 | 3.65 | 13 | PASS |
| Band2 | 10MHz | QPSK | 18900 | 50RB#0 | 4.81 | 13 | PASS |
| Band2 | 10MHz | QPSK | 19150 | 1RB#0 | 3.62 | 13 | PASS |

| | | | | | | | |
|-------|--------|-------|-------|---------|------|----|------|
| Band2 | 10MHz | QPSK | 19150 | 50RB#0 | 4.61 | 13 | PASS |
| Band2 | 10MHz | 16QAM | 18650 | 1RB#0 | 4.84 | 13 | PASS |
| Band2 | 10MHz | 16QAM | 18650 | 50RB#0 | 6.12 | 13 | PASS |
| Band2 | 10MHz | 16QAM | 18900 | 1RB#0 | 4.72 | 13 | PASS |
| Band2 | 10MHz | 16QAM | 18900 | 50RB#0 | 5.74 | 13 | PASS |
| Band2 | 10MHz | 16QAM | 19150 | 1RB#0 | 4.58 | 13 | PASS |
| Band2 | 10MHz | 16QAM | 19150 | 50RB#0 | 5.51 | 13 | PASS |
| Band2 | 15MHz | QPSK | 18675 | 1RB#0 | 3.86 | 13 | PASS |
| Band2 | 15MHz | QPSK | 18675 | 75RB#0 | 5.19 | 13 | PASS |
| Band2 | 15MHz | QPSK | 18900 | 1RB#0 | 3.59 | 13 | PASS |
| Band2 | 15MHz | QPSK | 18900 | 75RB#0 | 4.81 | 13 | PASS |
| Band2 | 15MHz | QPSK | 19125 | 1RB#0 | 3.88 | 13 | PASS |
| Band2 | 15MHz | QPSK | 19125 | 75RB#0 | 4.75 | 13 | PASS |
| Band2 | 15MHz | 16QAM | 18675 | 1RB#0 | 4.81 | 13 | PASS |
| Band2 | 15MHz | 16QAM | 18675 | 75RB#0 | 6.06 | 13 | PASS |
| Band2 | 15MHz | 16QAM | 18900 | 1RB#0 | 4.61 | 13 | PASS |
| Band2 | 15MHz | 16QAM | 18900 | 75RB#0 | 5.65 | 13 | PASS |
| Band2 | 15MHz | 16QAM | 19125 | 1RB#0 | 4.81 | 13 | PASS |
| Band2 | 15MHz | 16QAM | 19125 | 75RB#0 | 5.62 | 13 | PASS |
| Band2 | 20MHz | QPSK | 18700 | 1RB#0 | 3.88 | 13 | PASS |
| Band2 | 20MHz | QPSK | 18700 | 100RB#0 | 5.04 | 13 | PASS |
| Band2 | 20MHz | QPSK | 18900 | 1RB#0 | 3.68 | 13 | PASS |
| Band2 | 20MHz | QPSK | 18900 | 100RB#0 | 4.78 | 13 | PASS |
| Band2 | 20MHz | QPSK | 19100 | 1RB#0 | 3.88 | 13 | PASS |
| Band2 | 20MHz | QPSK | 19100 | 100RB#0 | 4.81 | 13 | PASS |
| Band2 | 20MHz | 16QAM | 18700 | 1RB#0 | 4.84 | 13 | PASS |
| Band2 | 20MHz | 16QAM | 18700 | 100RB#0 | 5.97 | 13 | PASS |
| Band2 | 20MHz | 16QAM | 18900 | 1RB#0 | 4.67 | 13 | PASS |
| Band2 | 20MHz | 16QAM | 18900 | 100RB#0 | 5.71 | 13 | PASS |
| Band2 | 20MHz | 16QAM | 19100 | 1RB#0 | 5.01 | 13 | PASS |
| Band2 | 20MHz | 16QAM | 19100 | 100RB#0 | 5.74 | 13 | PASS |
| Band4 | 1.4MHz | QPSK | 19957 | 6RB#0 | 4.90 | 13 | PASS |
| Band4 | 1.4MHz | QPSK | 20175 | 6RB#0 | 5.30 | 13 | PASS |
| Band4 | 1.4MHz | QPSK | 20393 | 6RB#0 | 5.13 | 13 | PASS |
| Band4 | 1.4MHz | 16QAM | 19957 | 6RB#0 | 5.94 | 13 | PASS |
| Band4 | 1.4MHz | 16QAM | 20175 | 6RB#0 | 6.26 | 13 | PASS |
| Band4 | 1.4MHz | 16QAM | 20393 | 6RB#0 | 6.09 | 13 | PASS |
| Band4 | 3MHz | QPSK | 19965 | 15RB#0 | 4.96 | 13 | PASS |
| Band4 | 3MHz | QPSK | 20175 | 15RB#0 | 5.39 | 13 | PASS |
| Band4 | 3MHz | QPSK | 20385 | 15RB#0 | 5.19 | 13 | PASS |
| Band4 | 3MHz | 16QAM | 19965 | 15RB#0 | 5.91 | 13 | PASS |
| Band4 | 3MHz | 16QAM | 20175 | 15RB#0 | 6.29 | 13 | PASS |
| Band4 | 3MHz | 16QAM | 20385 | 15RB#0 | 6.06 | 13 | PASS |
| Band4 | 5MHz | QPSK | 19975 | 25RB#0 | 4.93 | 13 | PASS |

| | | | | | | | |
|-------|--------|-------|-------|---------|------|----|------|
| Band4 | 5MHz | QPSK | 20175 | 25RB#0 | 5.30 | 13 | PASS |
| Band4 | 5MHz | QPSK | 20375 | 25RB#0 | 4.96 | 13 | PASS |
| Band4 | 5MHz | 16QAM | 19975 | 25RB#0 | 5.83 | 13 | PASS |
| Band4 | 5MHz | 16QAM | 20175 | 25RB#0 | 6.26 | 13 | PASS |
| Band4 | 5MHz | 16QAM | 20375 | 25RB#0 | 5.94 | 13 | PASS |
| Band4 | 10MHz | QPSK | 20000 | 50RB#0 | 5.01 | 13 | PASS |
| Band4 | 10MHz | QPSK | 20175 | 50RB#0 | 5.25 | 13 | PASS |
| Band4 | 10MHz | QPSK | 20350 | 50RB#0 | 4.87 | 13 | PASS |
| Band4 | 10MHz | 16QAM | 20000 | 50RB#0 | 5.94 | 13 | PASS |
| Band4 | 10MHz | 16QAM | 20175 | 50RB#0 | 6.23 | 13 | PASS |
| Band4 | 10MHz | 16QAM | 20350 | 50RB#0 | 5.86 | 13 | PASS |
| Band4 | 15MHz | QPSK | 20025 | 75RB#0 | 5.16 | 13 | PASS |
| Band4 | 15MHz | QPSK | 20175 | 75RB#0 | 5.30 | 13 | PASS |
| Band4 | 15MHz | QPSK | 20325 | 75RB#0 | 4.96 | 13 | PASS |
| Band4 | 15MHz | 16QAM | 20025 | 75RB#0 | 6.03 | 13 | PASS |
| Band4 | 15MHz | 16QAM | 20175 | 75RB#0 | 6.17 | 13 | PASS |
| Band4 | 15MHz | 16QAM | 20325 | 75RB#0 | 5.83 | 13 | PASS |
| Band4 | 20MHz | QPSK | 20050 | 100RB#0 | 5.01 | 13 | PASS |
| Band4 | 20MHz | QPSK | 20175 | 100RB#0 | 5.13 | 13 | PASS |
| Band4 | 20MHz | QPSK | 20300 | 100RB#0 | 4.87 | 13 | PASS |
| Band4 | 20MHz | 16QAM | 20050 | 100RB#0 | 6.00 | 13 | PASS |
| Band4 | 20MHz | 16QAM | 20175 | 100RB#0 | 6.09 | 13 | PASS |
| Band4 | 20MHz | 16QAM | 20300 | 100RB#0 | 5.80 | 13 | PASS |
| Band5 | 1.4MHz | QPSK | 20407 | 6RB#0 | 4.93 | 13 | PASS |
| Band5 | 1.4MHz | QPSK | 20525 | 6RB#0 | 4.90 | 13 | PASS |
| Band5 | 1.4MHz | QPSK | 20643 | 6RB#0 | 5.16 | 13 | PASS |
| Band5 | 1.4MHz | 16QAM | 20407 | 6RB#0 | 5.80 | 13 | PASS |
| Band5 | 1.4MHz | 16QAM | 20525 | 6RB#0 | 5.77 | 13 | PASS |
| Band5 | 1.4MHz | 16QAM | 20643 | 6RB#0 | 6.06 | 13 | PASS |
| Band5 | 3MHz | QPSK | 20415 | 15RB#0 | 5.04 | 13 | PASS |
| Band5 | 3MHz | QPSK | 20525 | 15RB#0 | 4.96 | 13 | PASS |
| Band5 | 3MHz | QPSK | 20635 | 15RB#0 | 5.33 | 13 | PASS |
| Band5 | 3MHz | 16QAM | 20415 | 15RB#0 | 5.91 | 13 | PASS |
| Band5 | 3MHz | 16QAM | 20525 | 15RB#0 | 5.86 | 13 | PASS |
| Band5 | 3MHz | 16QAM | 20635 | 15RB#0 | 6.14 | 13 | PASS |
| Band5 | 5MHz | QPSK | 20425 | 25RB#0 | 4.99 | 13 | PASS |
| Band5 | 5MHz | QPSK | 20525 | 25RB#0 | 4.87 | 13 | PASS |
| Band5 | 5MHz | QPSK | 20625 | 25RB#0 | 5.10 | 13 | PASS |
| Band5 | 5MHz | 16QAM | 20425 | 25RB#0 | 5.86 | 13 | PASS |
| Band5 | 5MHz | 16QAM | 20525 | 25RB#0 | 5.77 | 13 | PASS |
| Band5 | 5MHz | 16QAM | 20625 | 25RB#0 | 6.00 | 13 | PASS |
| Band5 | 10MHz | QPSK | 20450 | 50RB#0 | 4.99 | 13 | PASS |
| Band5 | 10MHz | QPSK | 20525 | 50RB#0 | 5.10 | 13 | PASS |
| Band5 | 10MHz | QPSK | 20600 | 50RB#0 | 4.84 | 13 | PASS |

| | | | | | | | |
|--------|--------|-------|-------|--------|------|----|------|
| Band5 | 10MHz | 16QAM | 20450 | 50RB#0 | 5.91 | 13 | PASS |
| Band5 | 10MHz | 16QAM | 20525 | 50RB#0 | 5.91 | 13 | PASS |
| Band5 | 10MHz | 16QAM | 20600 | 50RB#0 | 5.86 | 13 | PASS |
| Band12 | 1.4MHz | QPSK | 23017 | 6RB#0 | 5.36 | 13 | PASS |
| Band12 | 1.4MHz | QPSK | 23095 | 6RB#0 | 5.42 | 13 | PASS |
| Band12 | 1.4MHz | QPSK | 23173 | 6RB#0 | 5.33 | 13 | PASS |
| Band12 | 1.4MHz | 16QAM | 23017 | 6RB#0 | 6.23 | 13 | PASS |
| Band12 | 1.4MHz | 16QAM | 23095 | 6RB#0 | 6.35 | 13 | PASS |
| Band12 | 1.4MHz | 16QAM | 23173 | 6RB#0 | 6.26 | 13 | PASS |
| Band12 | 3MHz | QPSK | 23025 | 15RB#0 | 5.39 | 13 | PASS |
| Band12 | 3MHz | QPSK | 23095 | 15RB#0 | 5.45 | 13 | PASS |
| Band12 | 3MHz | QPSK | 23165 | 15RB#0 | 5.33 | 13 | PASS |
| Band12 | 3MHz | 16QAM | 23025 | 15RB#0 | 6.29 | 13 | PASS |
| Band12 | 3MHz | 16QAM | 23095 | 15RB#0 | 6.32 | 13 | PASS |
| Band12 | 3MHz | 16QAM | 23165 | 15RB#0 | 6.29 | 13 | PASS |
| Band12 | 5MHz | QPSK | 23035 | 25RB#0 | 5.28 | 13 | PASS |
| Band12 | 5MHz | QPSK | 23095 | 25RB#0 | 5.30 | 13 | PASS |
| Band12 | 5MHz | QPSK | 23155 | 25RB#0 | 5.22 | 13 | PASS |
| Band12 | 5MHz | 16QAM | 23035 | 25RB#0 | 6.23 | 13 | PASS |
| Band12 | 5MHz | 16QAM | 23095 | 25RB#0 | 6.20 | 13 | PASS |
| Band12 | 5MHz | 16QAM | 23155 | 25RB#0 | 6.17 | 13 | PASS |
| Band12 | 10MHz | QPSK | 23060 | 50RB#0 | 5.28 | 13 | PASS |
| Band12 | 10MHz | QPSK | 23095 | 50RB#0 | 5.33 | 13 | PASS |
| Band12 | 10MHz | QPSK | 23130 | 50RB#0 | 5.16 | 13 | PASS |
| Band12 | 10MHz | 16QAM | 23060 | 50RB#0 | 6.20 | 13 | PASS |
| Band12 | 10MHz | 16QAM | 23095 | 50RB#0 | 6.20 | 13 | PASS |
| Band12 | 10MHz | 16QAM | 23130 | 50RB#0 | 6.12 | 13 | PASS |
| Band17 | 5MHz | QPSK | 23755 | 1RB#0 | 4.84 | 13 | PASS |
| Band17 | 5MHz | QPSK | 23755 | 25RB#0 | 5.33 | 13 | PASS |
| Band17 | 5MHz | QPSK | 23790 | 1RB#0 | 4.81 | 13 | PASS |
| Band17 | 5MHz | QPSK | 23790 | 25RB#0 | 5.25 | 13 | PASS |
| Band17 | 5MHz | QPSK | 23825 | 1RB#0 | 4.70 | 13 | PASS |
| Band17 | 5MHz | QPSK | 23825 | 25RB#0 | 5.22 | 13 | PASS |
| Band17 | 5MHz | 16QAM | 23755 | 1RB#0 | 5.83 | 13 | PASS |
| Band17 | 5MHz | 16QAM | 23755 | 25RB#0 | 6.26 | 13 | PASS |
| Band17 | 5MHz | 16QAM | 23790 | 1RB#0 | 5.74 | 13 | PASS |
| Band17 | 5MHz | 16QAM | 23790 | 25RB#0 | 6.14 | 13 | PASS |
| Band17 | 5MHz | 16QAM | 23825 | 1RB#0 | 5.68 | 13 | PASS |
| Band17 | 5MHz | 16QAM | 23825 | 25RB#0 | 6.17 | 13 | PASS |
| Band17 | 10MHz | QPSK | 23780 | 1RB#0 | 4.75 | 13 | PASS |
| Band17 | 10MHz | QPSK | 23780 | 50RB#0 | 5.28 | 13 | PASS |
| Band17 | 10MHz | QPSK | 23790 | 1RB#0 | 4.81 | 13 | PASS |
| Band17 | 10MHz | QPSK | 23790 | 50RB#0 | 5.22 | 13 | PASS |
| Band17 | 10MHz | QPSK | 23800 | 1RB#0 | 4.75 | 13 | PASS |

| | | | | | | | |
|--------|-------|-------|-------|--------|------|----|------|
| Band17 | 10MHz | QPSK | 23800 | 50RB#0 | 5.16 | 13 | PASS |
| Band17 | 10MHz | 16QAM | 23780 | 1RB#0 | 5.74 | 13 | PASS |
| Band17 | 10MHz | 16QAM | 23780 | 50RB#0 | 6.14 | 13 | PASS |
| Band17 | 10MHz | 16QAM | 23790 | 1RB#0 | 5.94 | 13 | PASS |
| Band17 | 10MHz | 16QAM | 23790 | 50RB#0 | 6.14 | 13 | PASS |
| Band17 | 10MHz | 16QAM | 23800 | 1RB#0 | 5.74 | 13 | PASS |
| Band17 | 10MHz | 16QAM | 23800 | 50RB#0 | 6.12 | 13 | PASS |

Test Graphs

Band2-1.4MHz-QPSK-18607-1RB#0

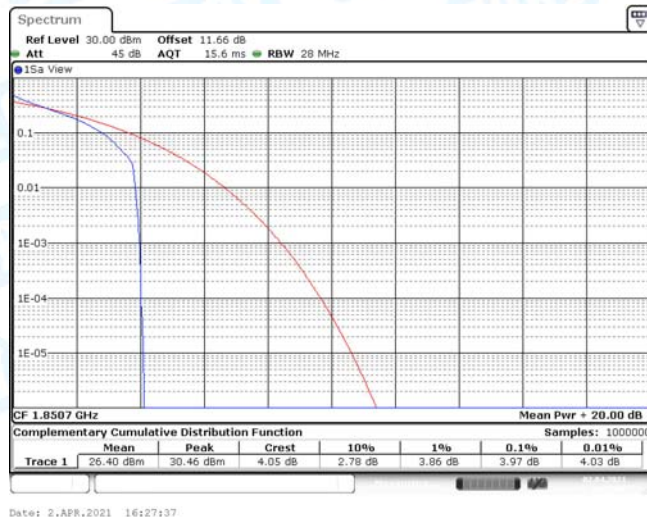

Band2-1.4MHz-QPSK-18607-6RB#0

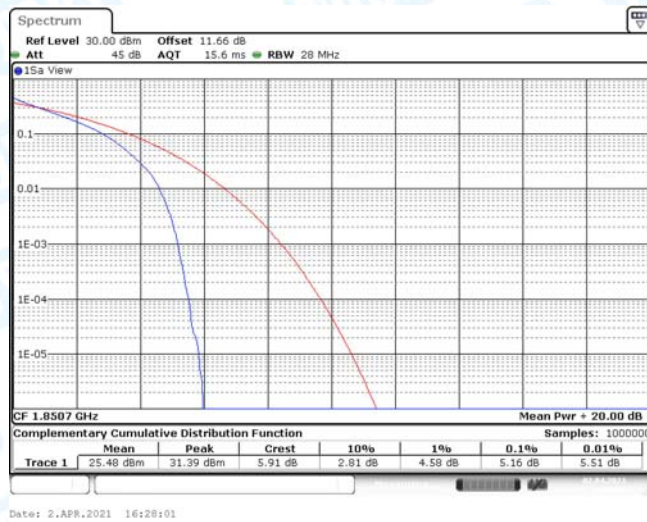

Band2-1.4MHz-QPSK-18900-1RB#0

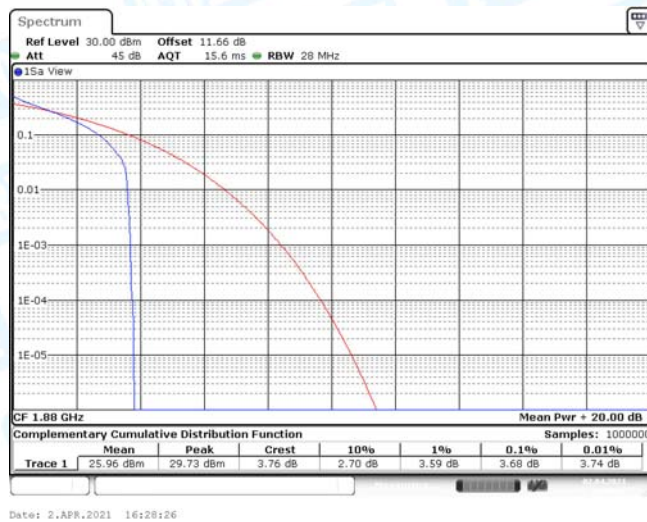

Band2-1.4MHz-QPSK-18900-6RB#0

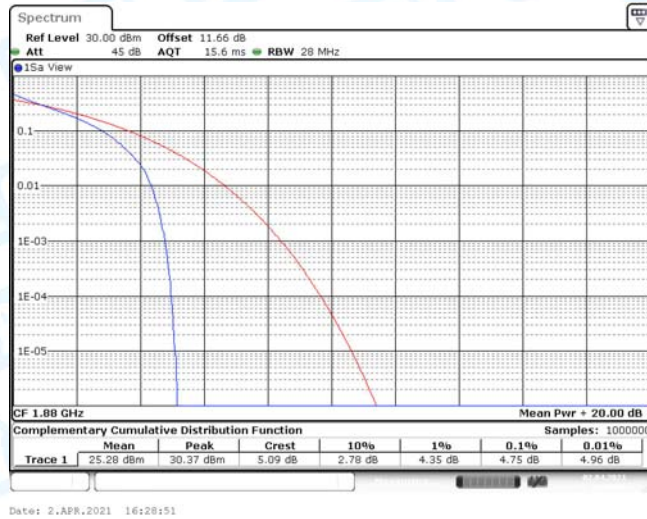

Band2-1.4MHz-QPSK-19193-1RB#0



Band2-1.4MHz-QPSK-19193-6RB#0

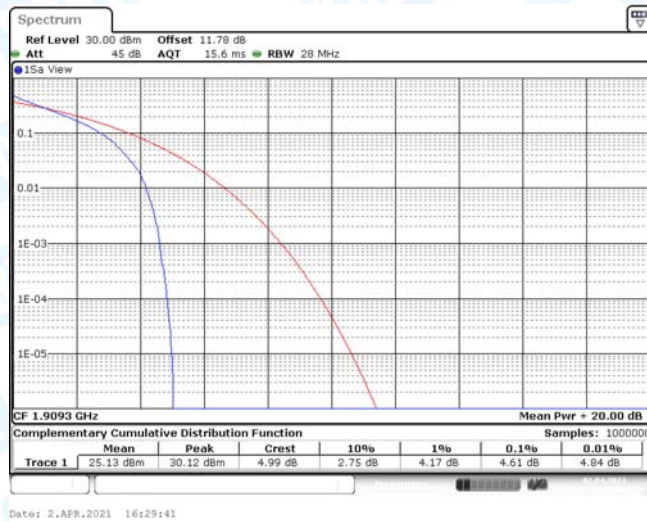

Band2-1.4MHz-16QAM-18607-1RB#0

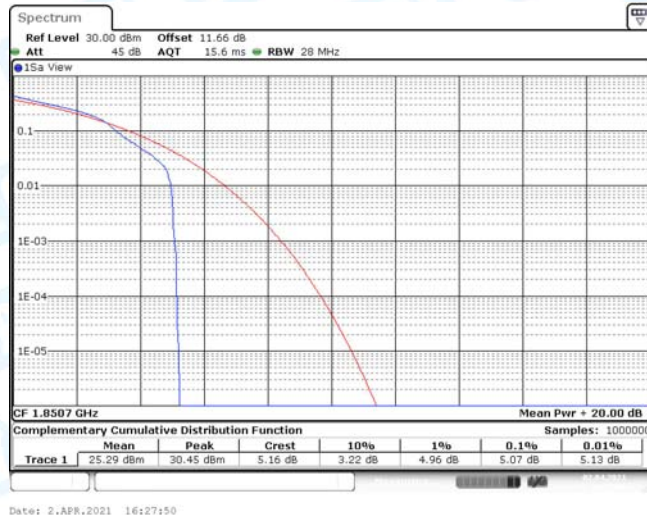

Band2-1.4MHz-16QAM-18607-6RB#0

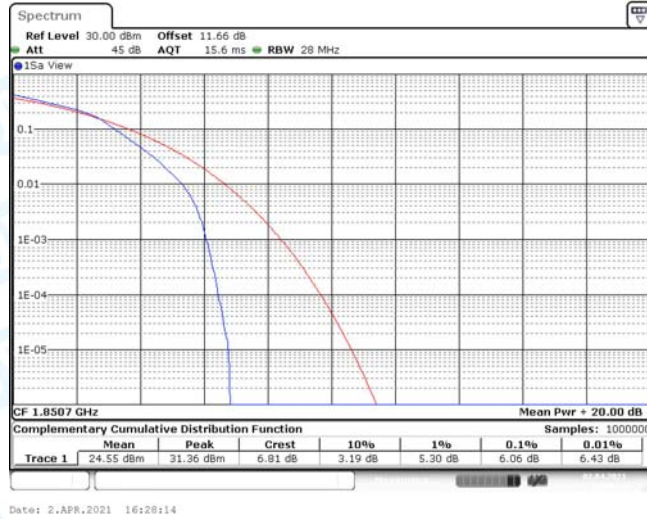

Band2-1.4MHz-16QAM-18900-1RB#0

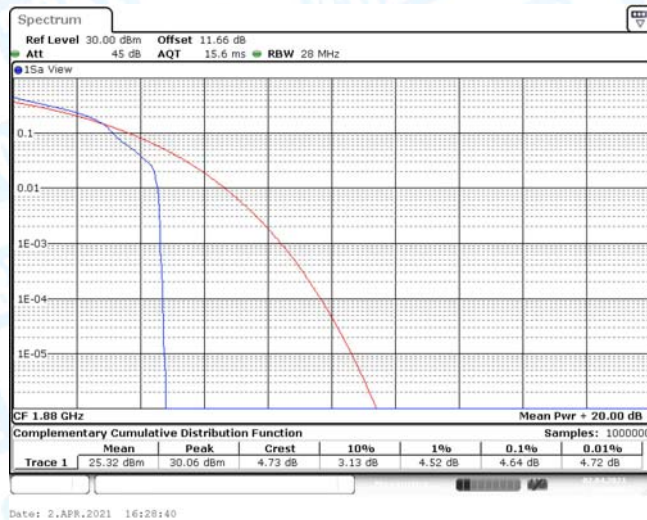

Band2-1.4MHz-16QAM-18900-6RB#0

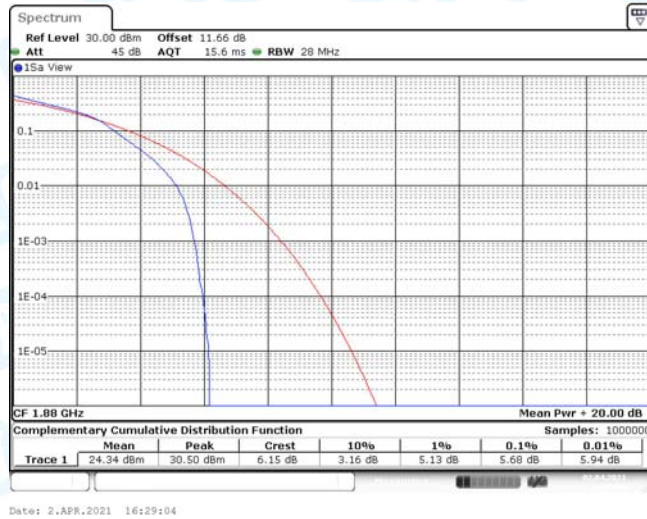

Band2-1.4MHz-16QAM-19193-1RB#0

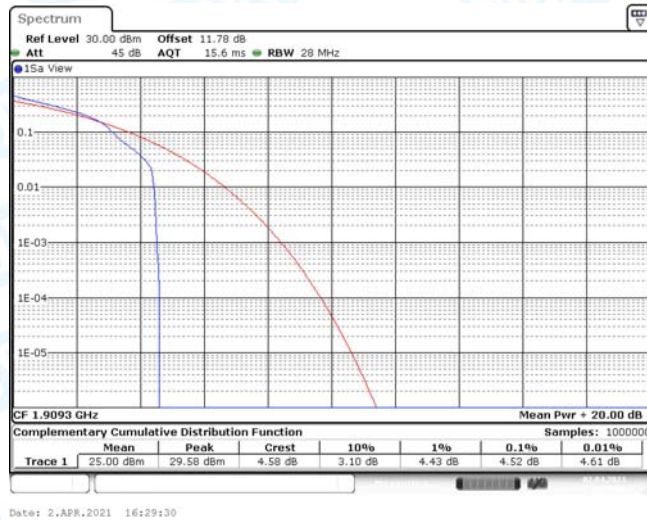

Band2-1.4MHz-16QAM-19193-6RB#0

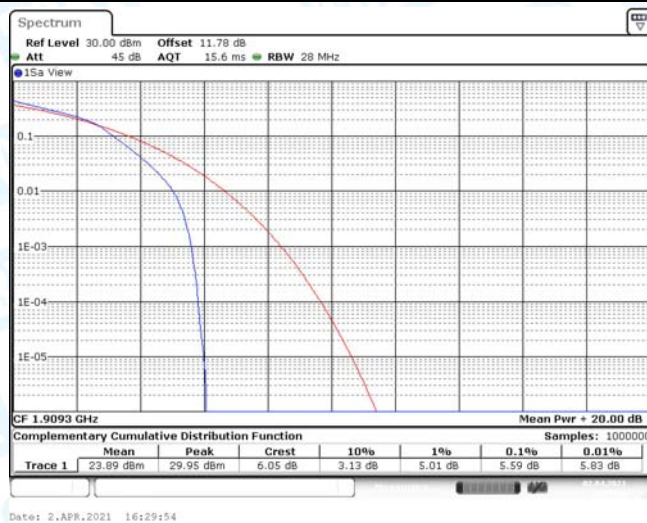

Band2-3MHz-QPSK-18615-1RB#0

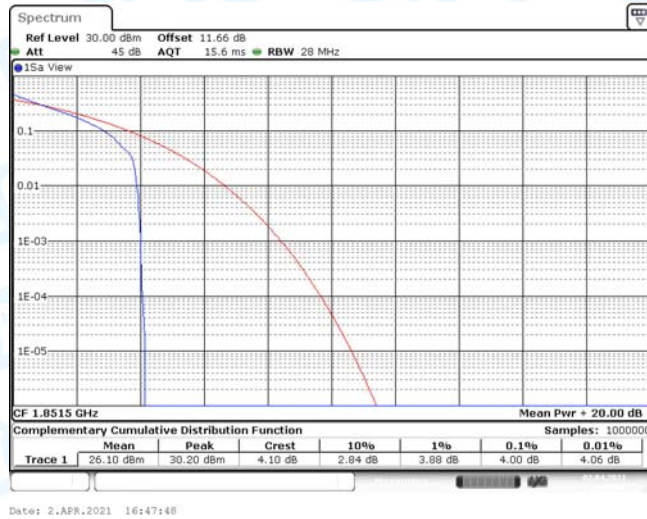

Band2-3MHz-QPSK-18615-15RB#0

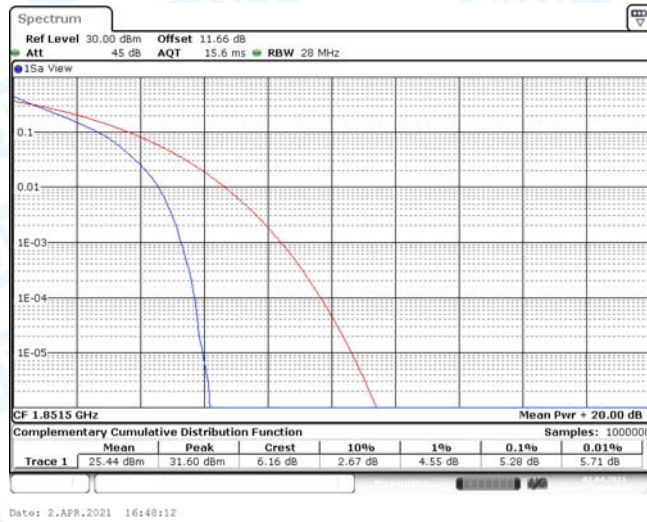

Band2-3MHz-QPSK-18900-1RB#0

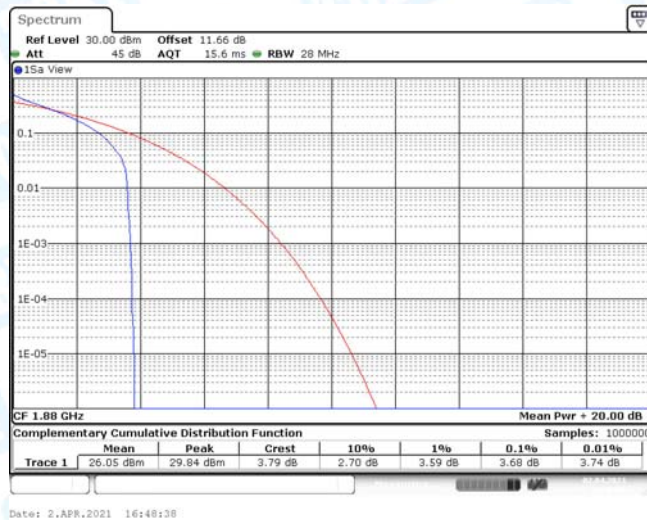

Band2-3MHz-QPSK-18900-15RB#0

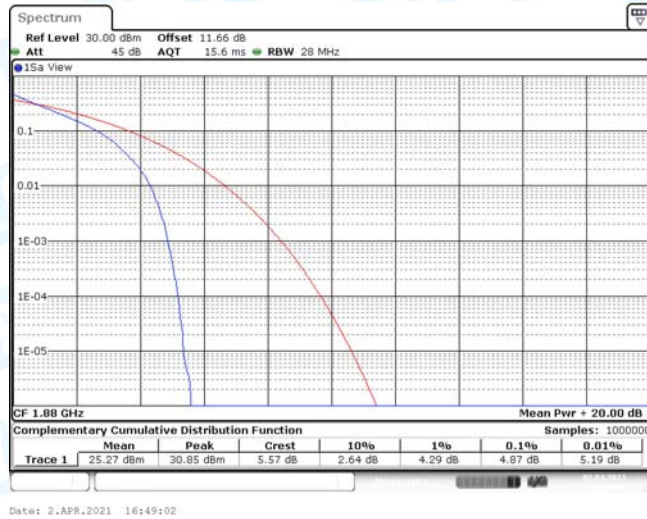

Band2-3MHz-QPSK-19185-1RB#0

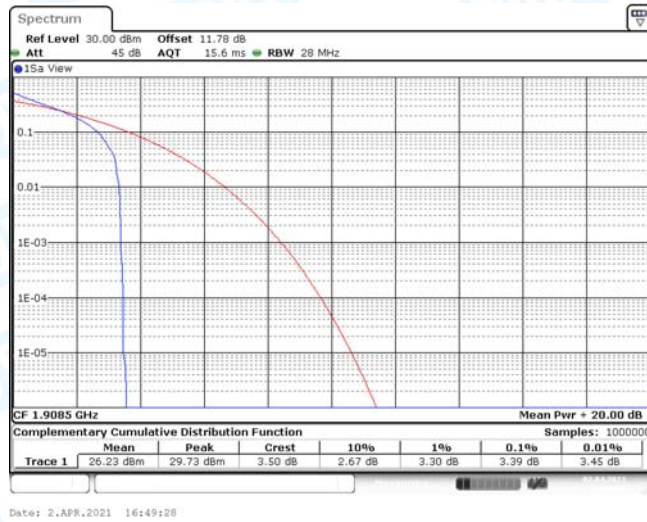

Band2-3MHz-QPSK-19185-15RB#0

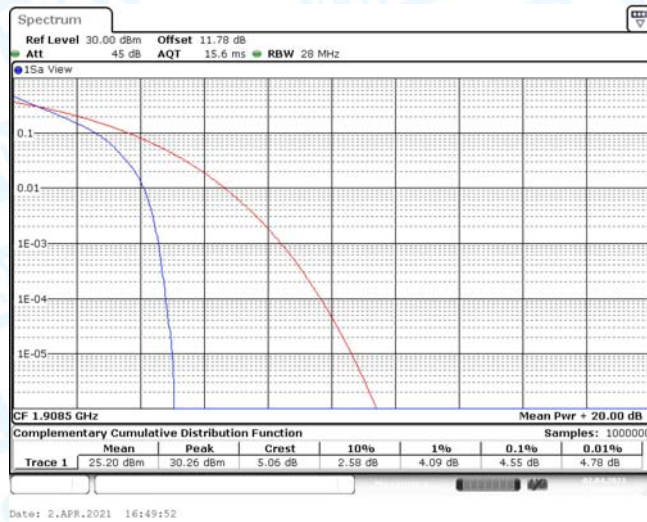

Band2-3MHz-16QAM-18615-1RB#0

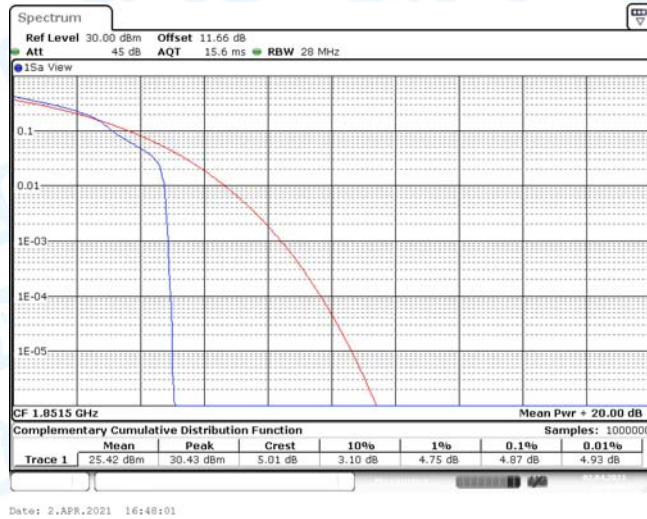

Band2-3MHz-16QAM-18615-15RB#0

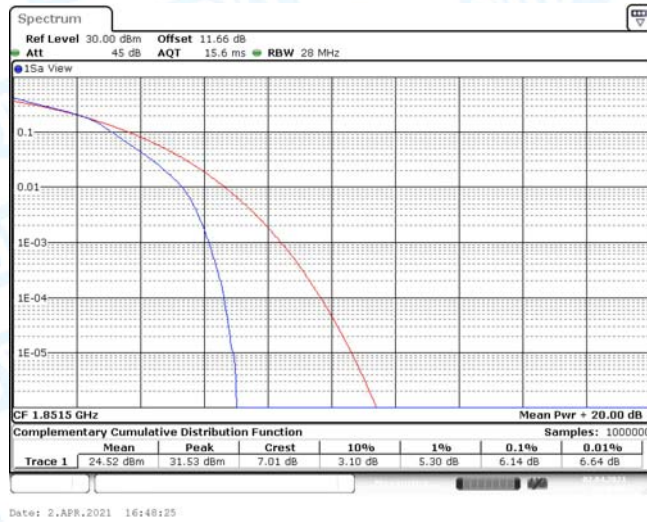

Band2-3MHz-16QAM-18900-1RB#0

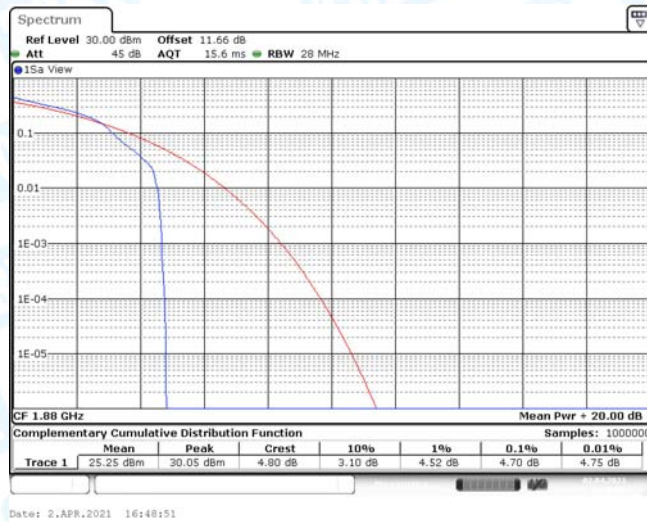

Band2-3MHz-16QAM-18900-15RB#0

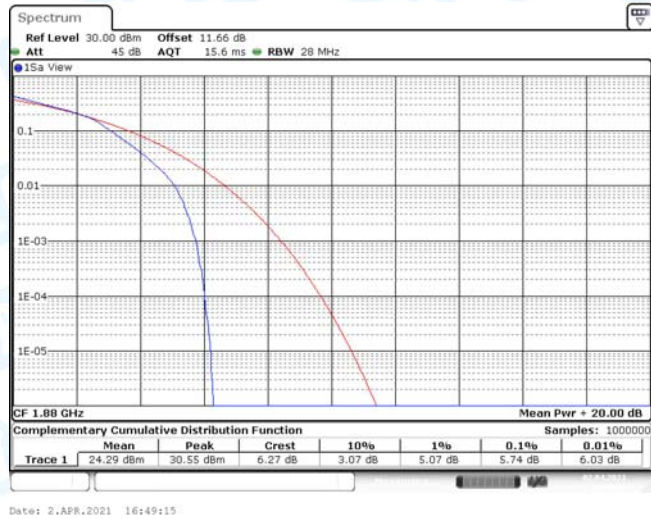

Band2-3MHz-16QAM-19185-1RB#0

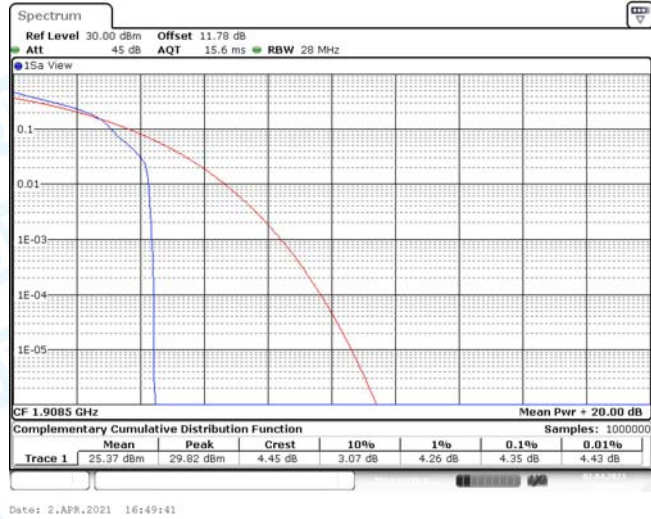

Band2-3MHz-16QAM-19185-15RB#0

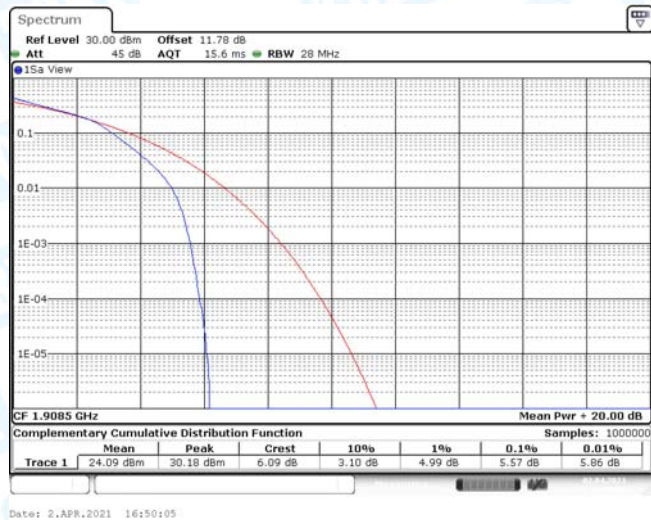

Band2-5MHz-QPSK-18625-1RB#0

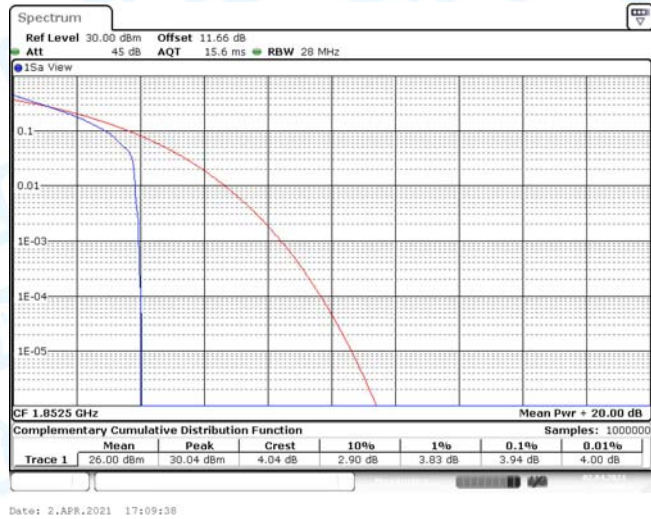

Band2-5MHz-QPSK-18625-25RB#0

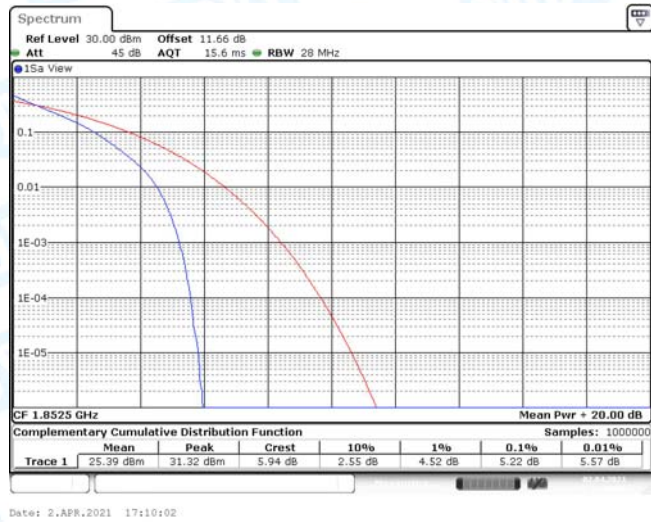

Band2-5MHz-QPSK-18900-1RB#0

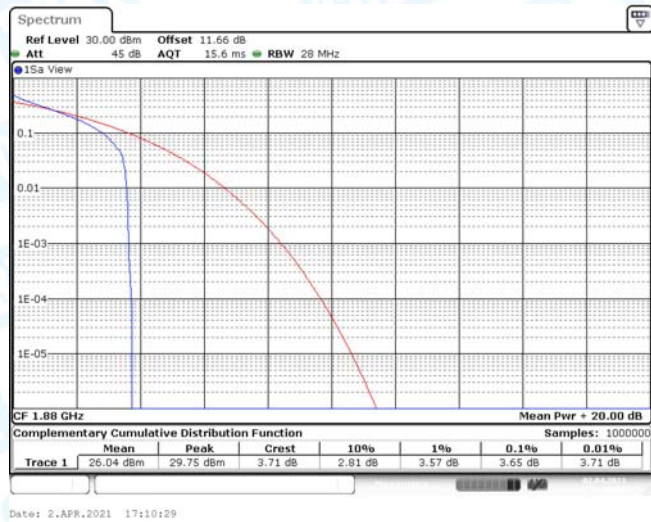

Band2-5MHz-QPSK-18900-25RB#0

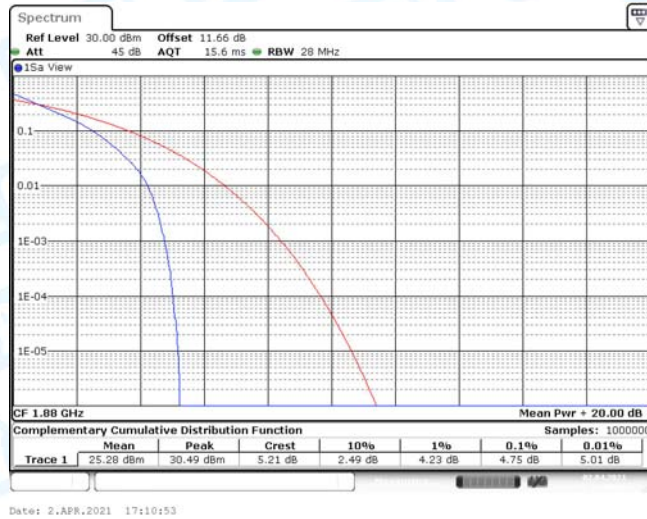

Band2-5MHz-QPSK-19175-1RB#0

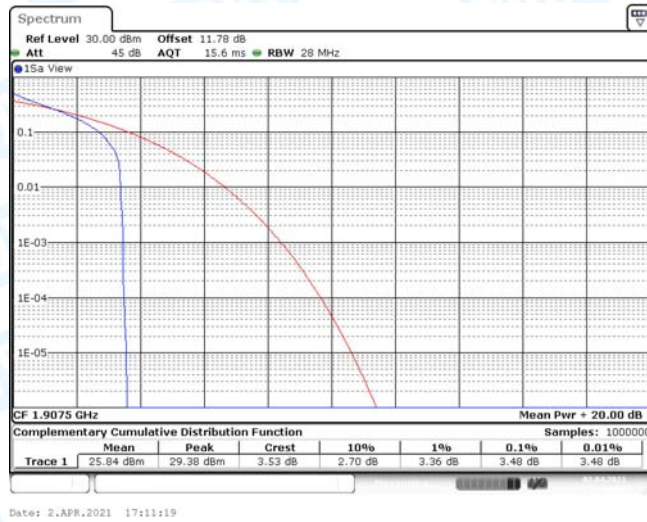

Band2-5MHz-QPSK-19175-25RB#0

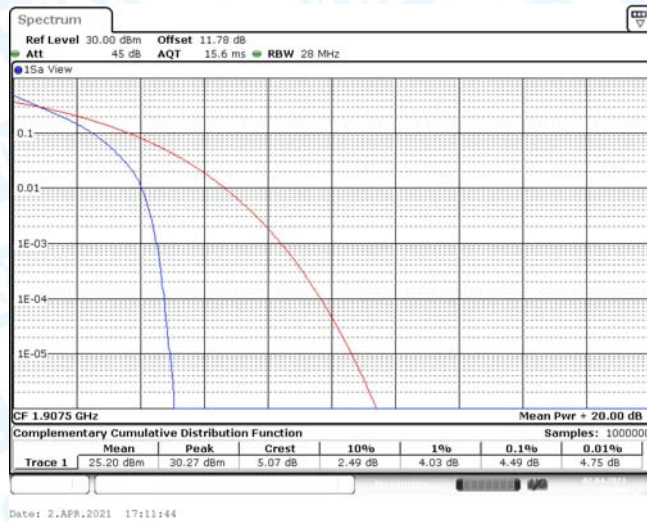

Band2-5MHz-16QAM-18625-1RB#0

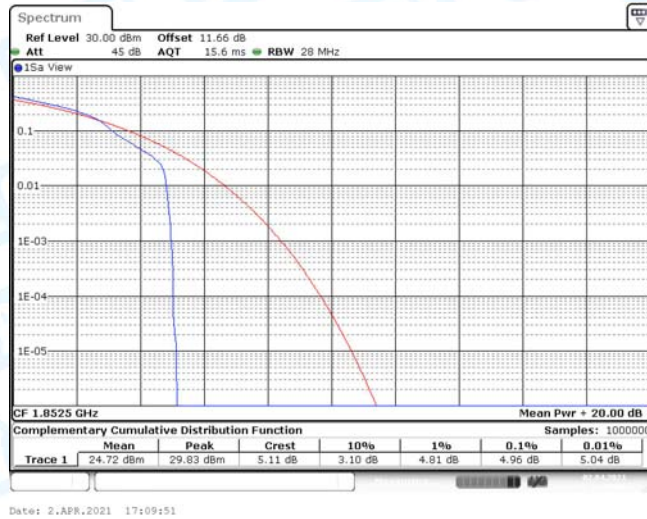

Band2-5MHz-16QAM-18625-25RB#0

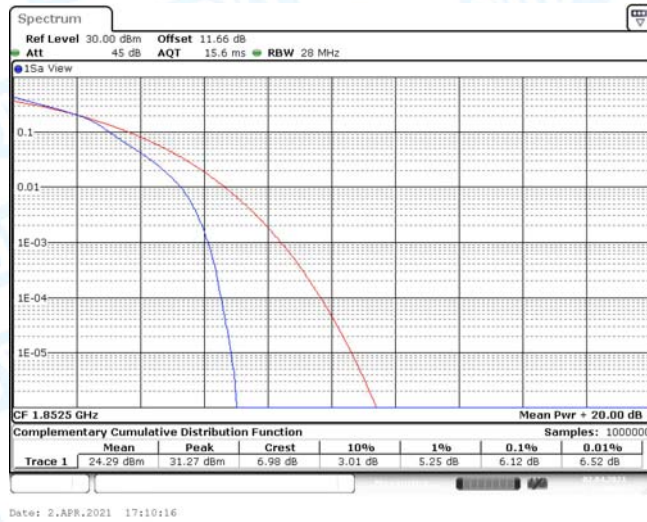

Band2-5MHz-16QAM-18900-1RB#0

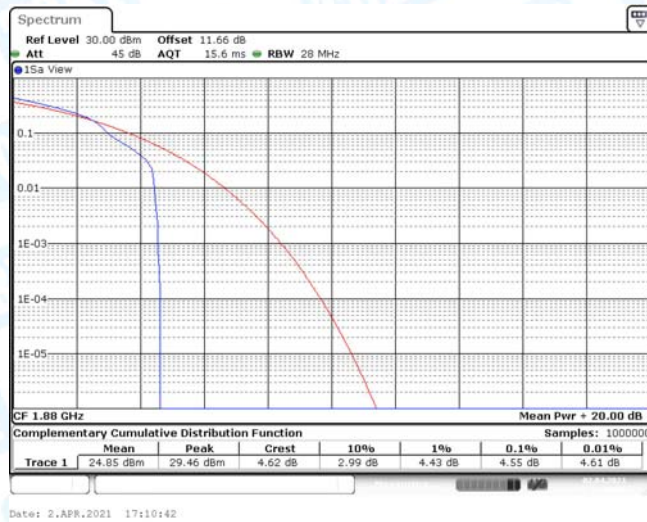

Band2-5MHz-16QAM-18900-25RB#0

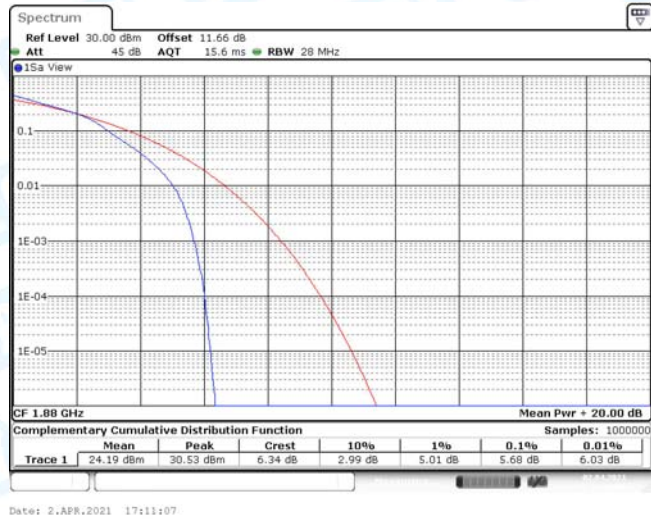

Band2-5MHz-16QAM-19175-1RB#0

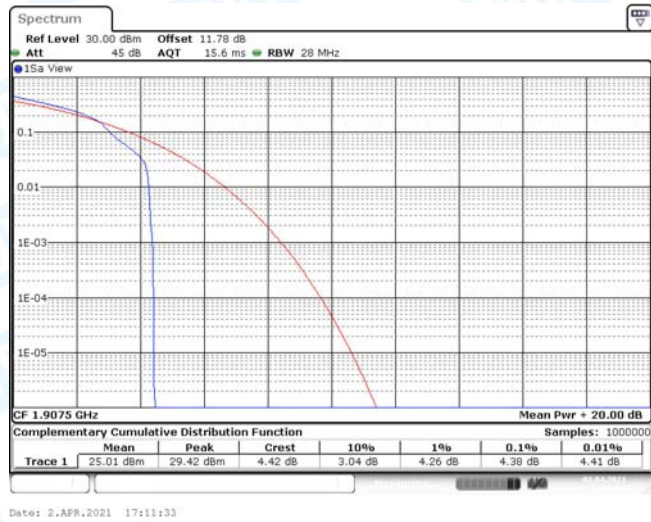

Band2-5MHz-16QAM-19175-25RB#0

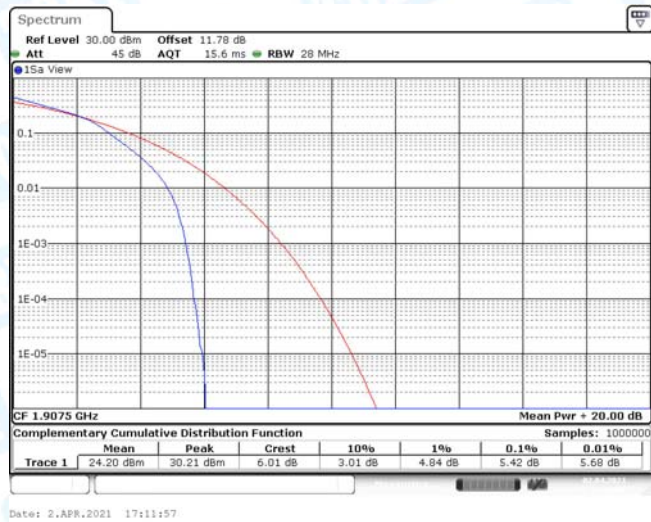

Band2-10MHz-QPSK-18650-1RB#0

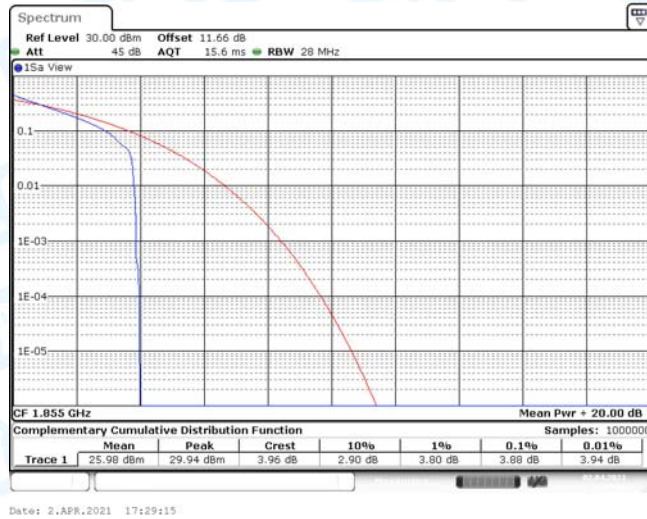

Band2-10MHz-QPSK-18650-50RB#0

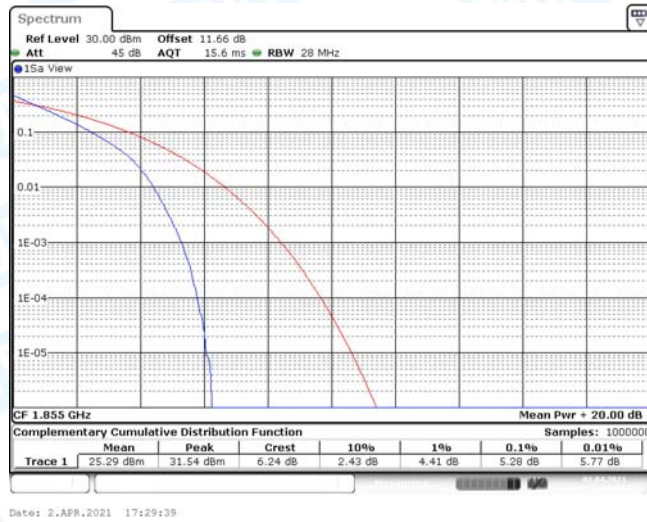

Band2-10MHz-QPSK-18900-1RB#0

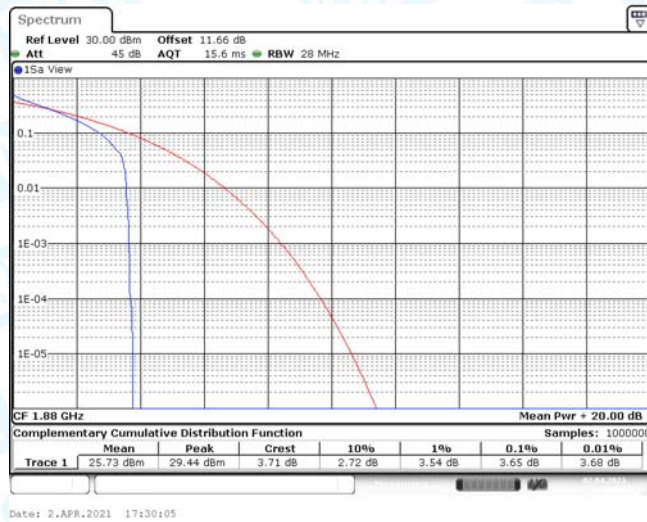

Band2-10MHz-QPSK-18900-50RB#0

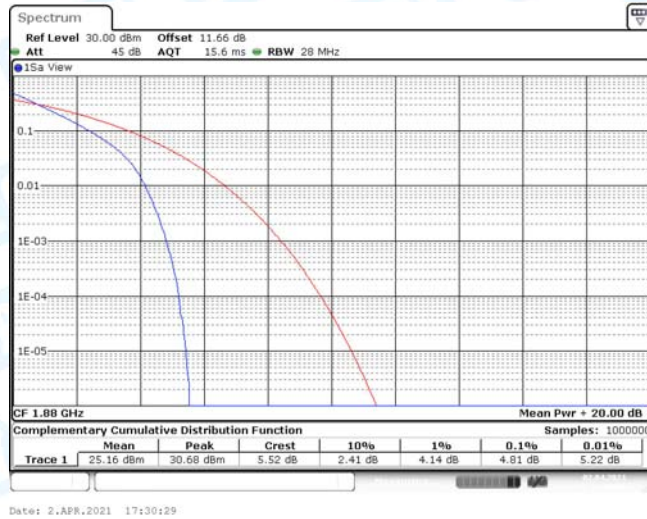

Band2-10MHz-QPSK-19150-1RB#0

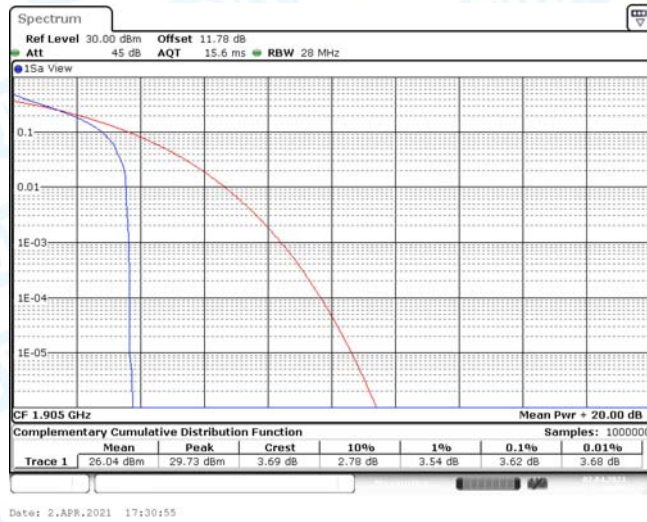

Band2-10MHz-QPSK-19150-50RB#0

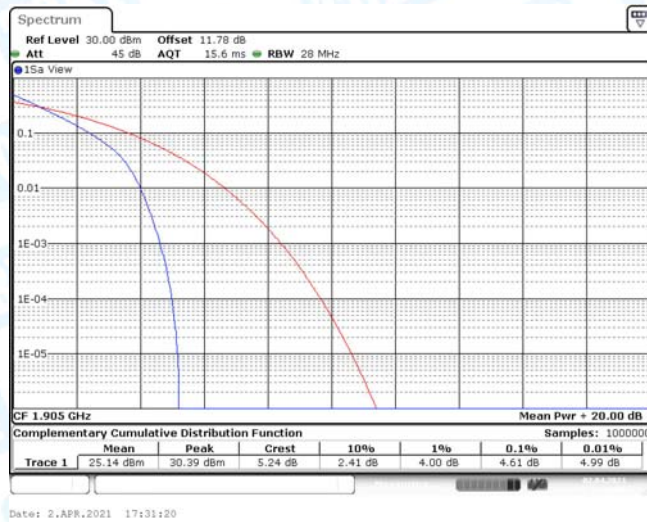

Band2-10MHz-16QAM-18650-1RB#0

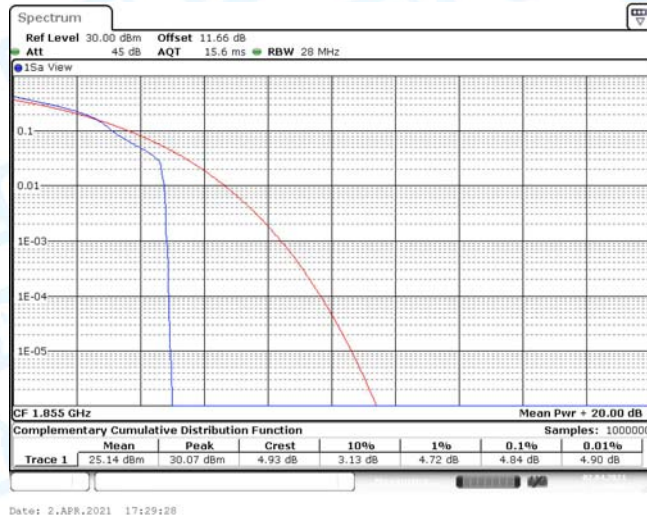

Band2-10MHz-16QAM-18650-50RB#0

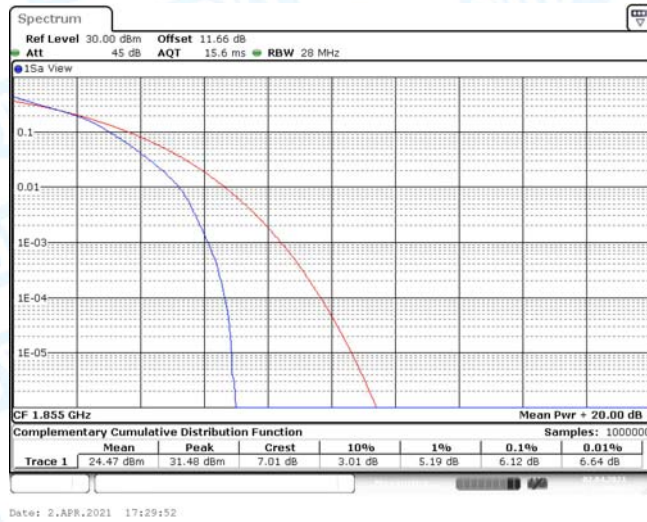

Band2-10MHz-16QAM-18900-1RB#0

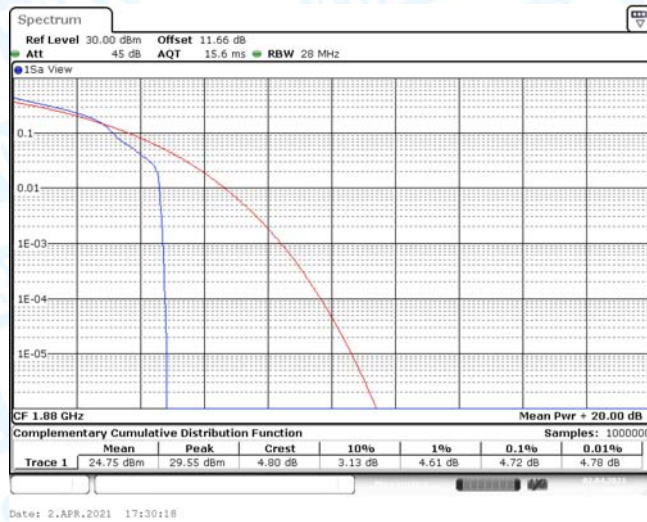

Band2-10MHz-16QAM-18900-50RB#0

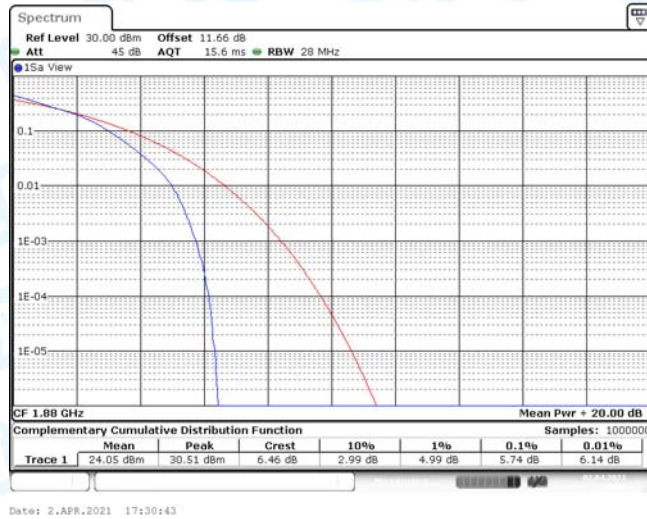

Band2-10MHz-16QAM-19150-1RB#0

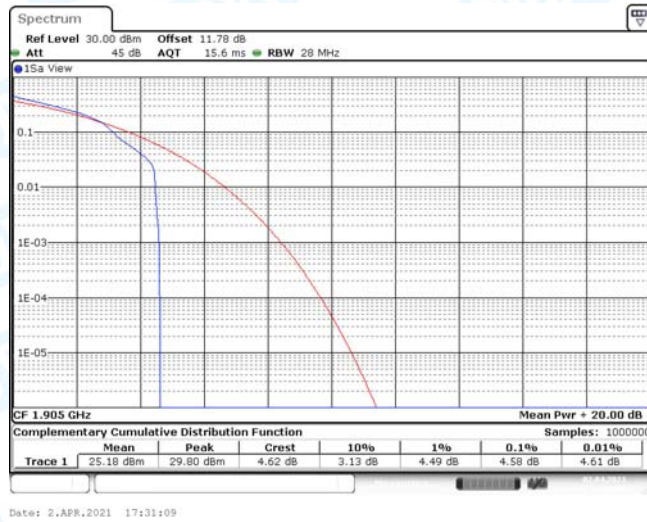

Band2-10MHz-16QAM-19150-50RB#0

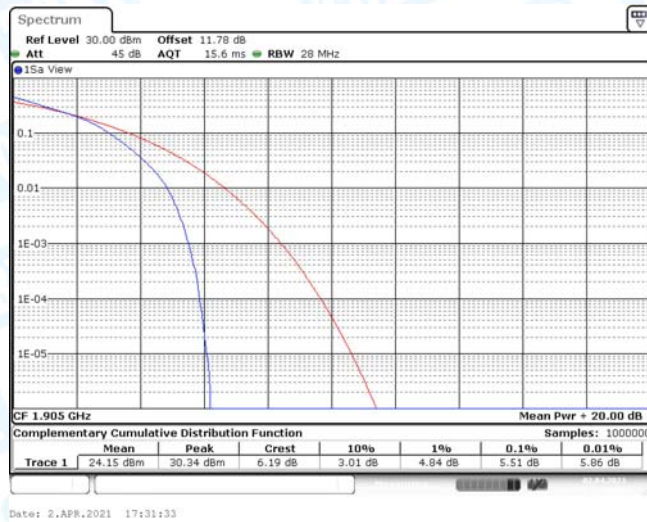

Band2-15MHz-QPSK-18675-1RB#0

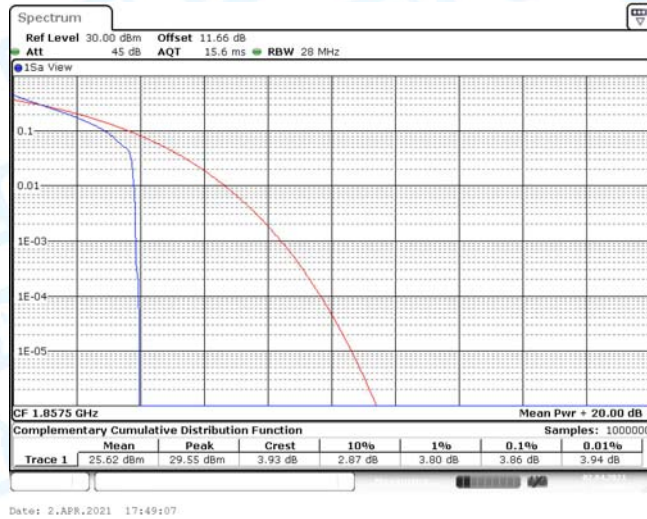

Band2-15MHz-QPSK-18675-75RB#0

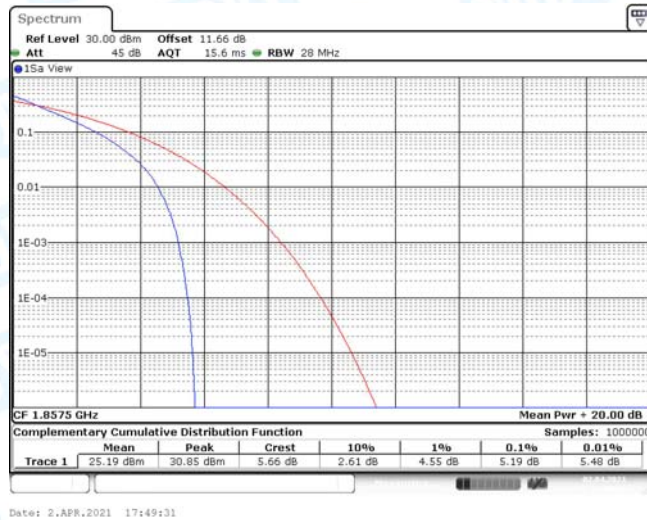

Band2-15MHz-QPSK-18900-1RB#0

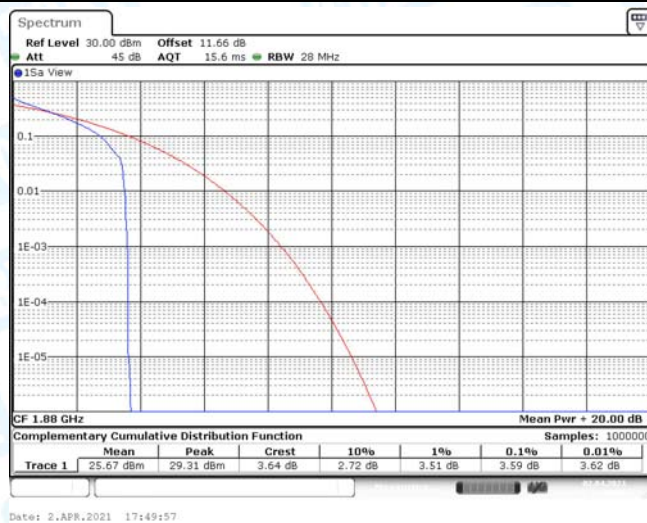

Band2-15MHz-QPSK-18900-75RB#0

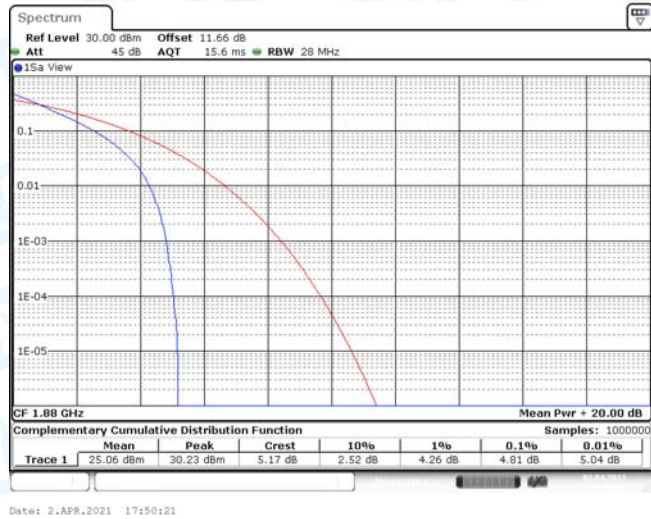

Band2-15MHz-QPSK-19125-1RB#0

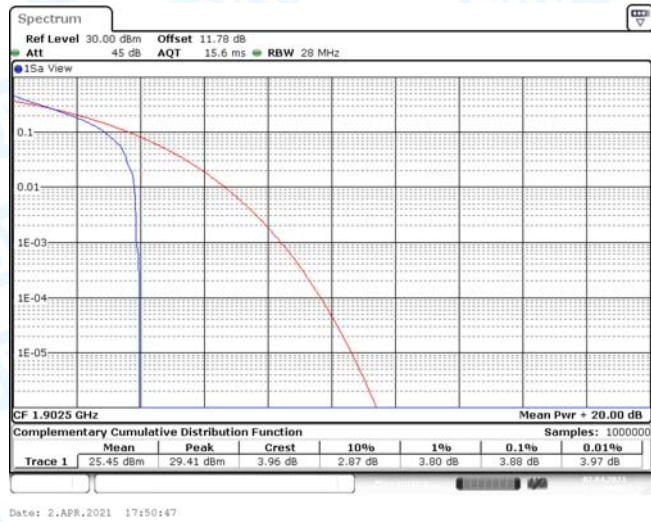

Band2-15MHz-QPSK-19125-75RB#0

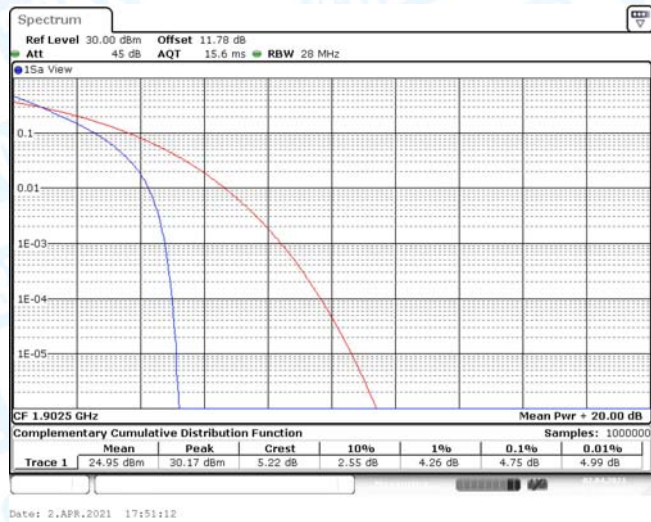

Band2-15MHz-16QAM-18675-1RB#0

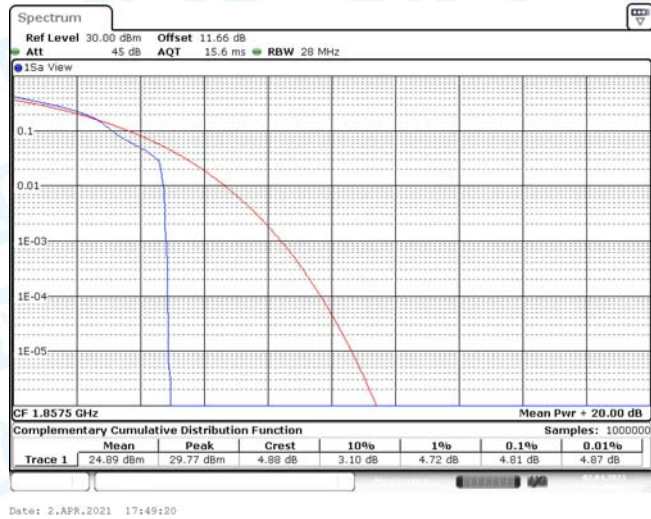

Band2-15MHz-16QAM-18675-75RB#0

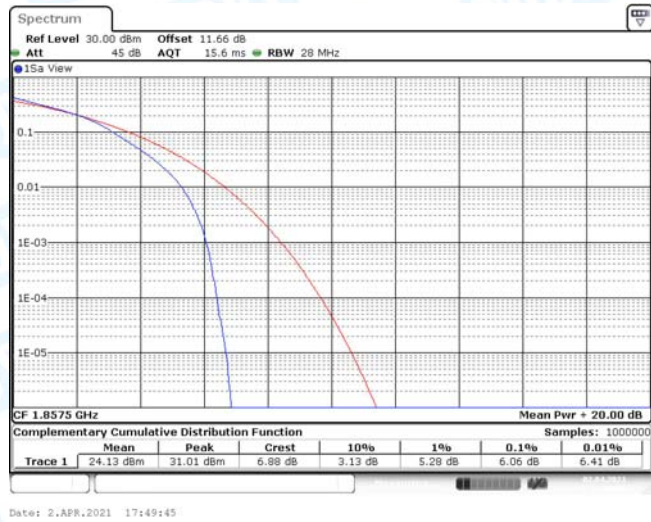

Band2-15MHz-16QAM-18900-1RB#0

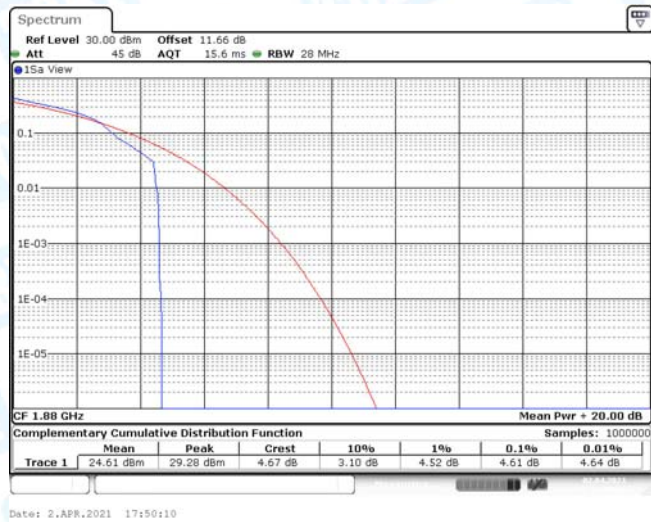

Band2-15MHz-16QAM-18900-75RB#0

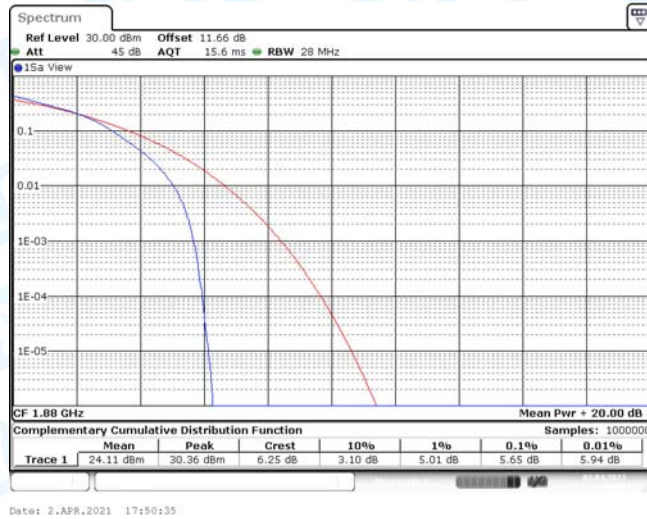

Band2-15MHz-16QAM-19125-1RB#0

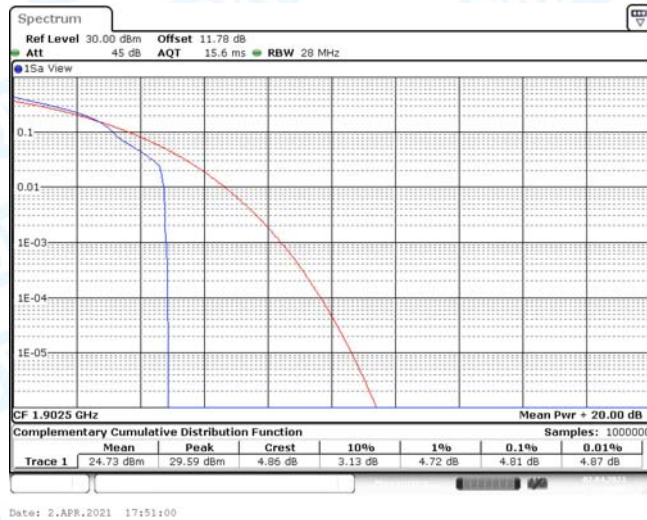

Band2-15MHz-16QAM-19125-75RB#0

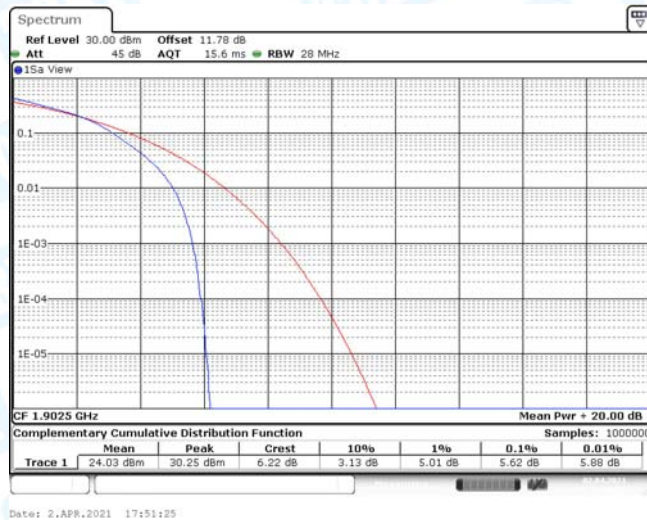

Band2-20MHz-QPSK-18700-1RB#0

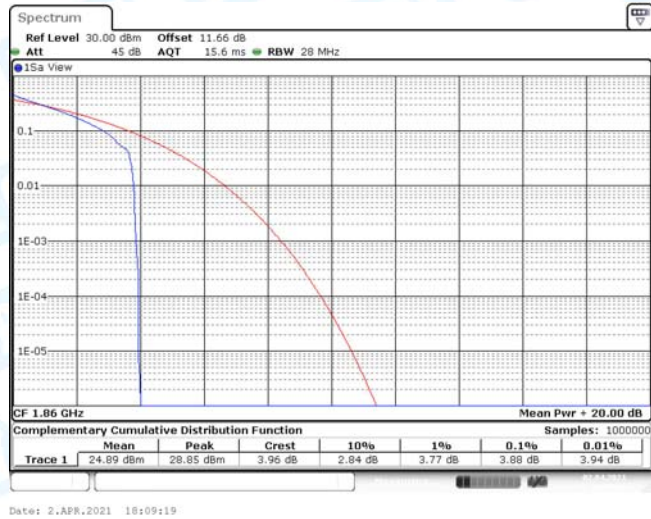

Band2-20MHz-QPSK-18700-100RB#0

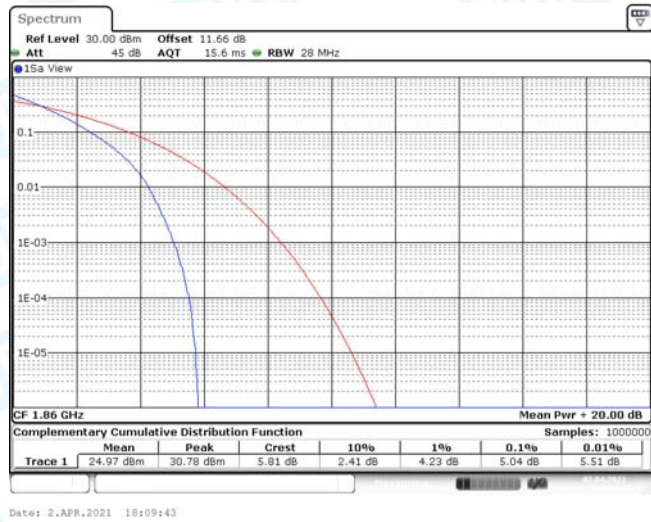

Band2-20MHz-QPSK-18900-1RB#0

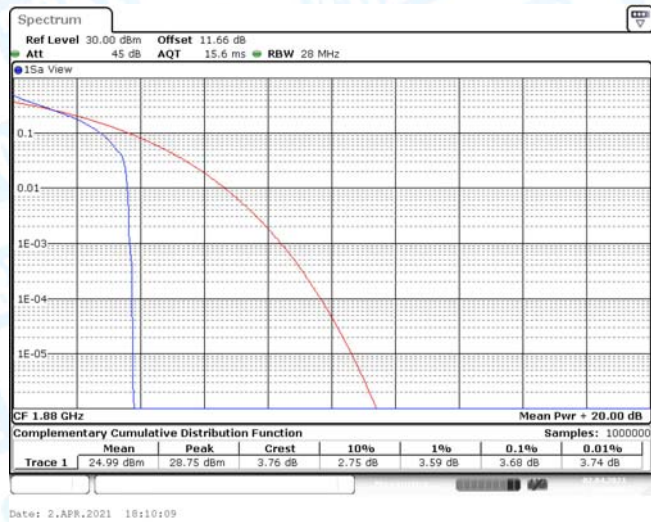

Band2-20MHz-QPSK-18900-100RB#0

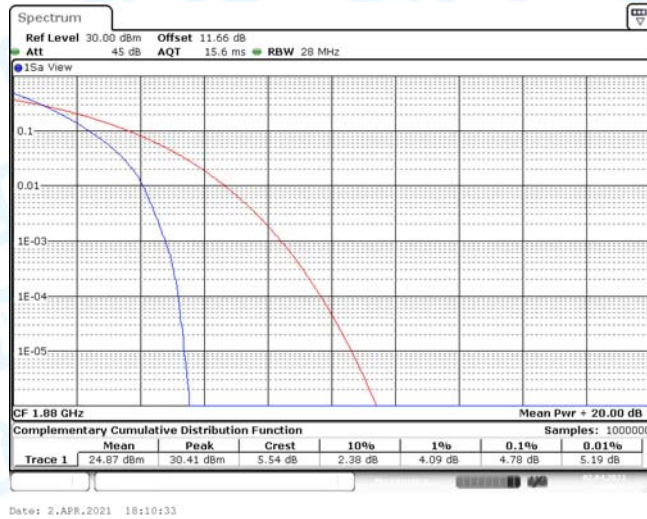

Band2-20MHz-QPSK-19100-1RB#0

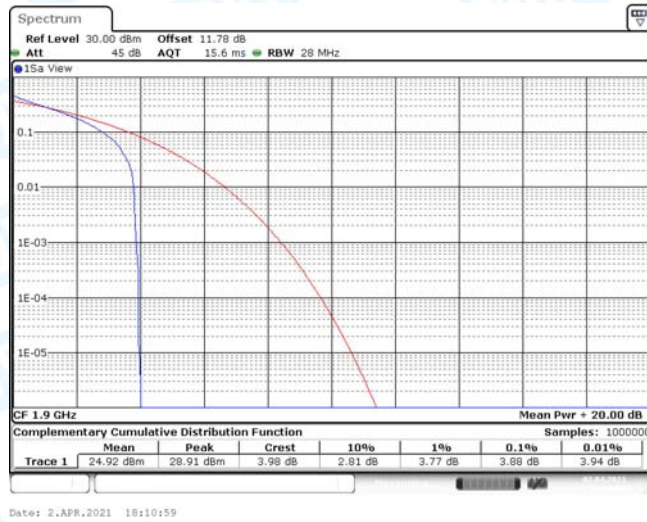

Band2-20MHz-QPSK-19100-100RB#0

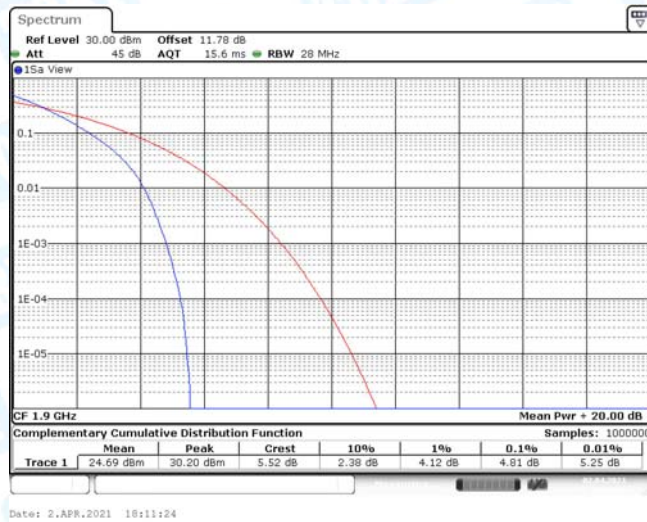

Band2-20MHz-16QAM-18700-1RB#0

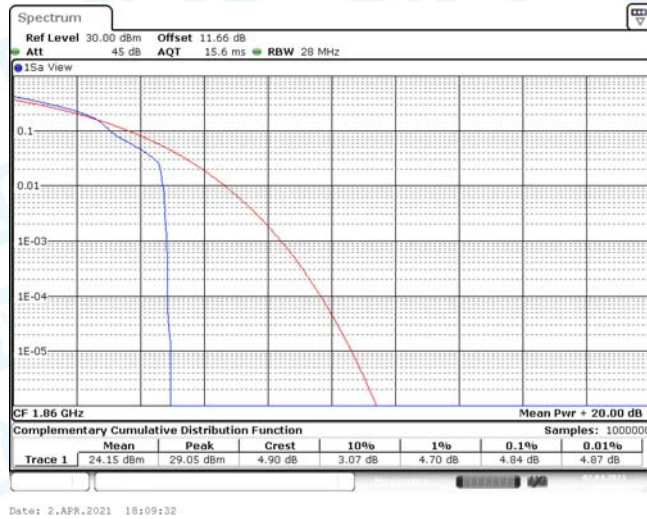

Band2-20MHz-16QAM-18700-100RB#0

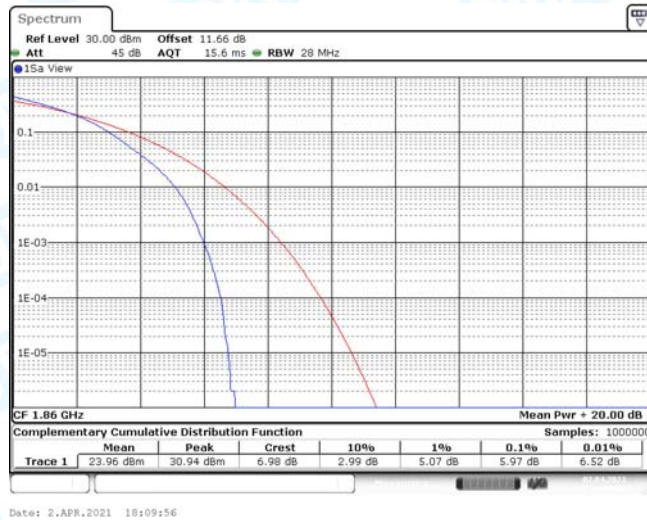

Band2-20MHz-16QAM-18900-1RB#0

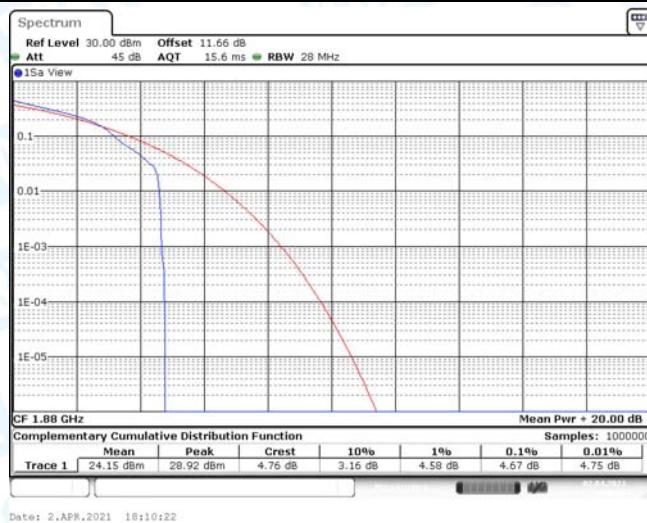

Band2-20MHz-16QAM-18900-100RB#0

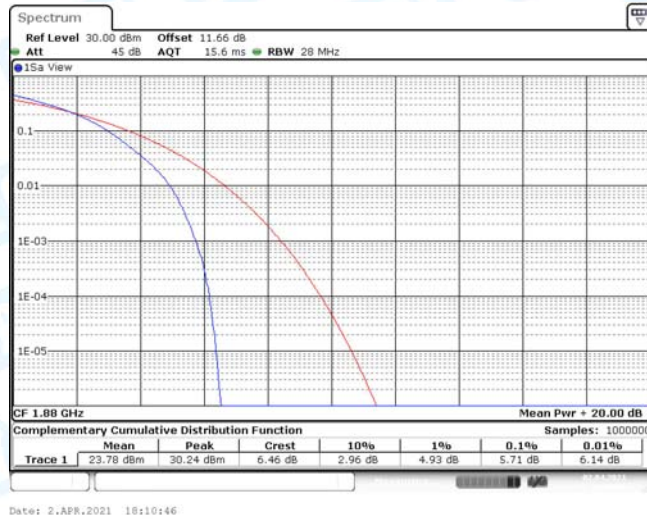

Band2-20MHz-16QAM-19100-1RB#0

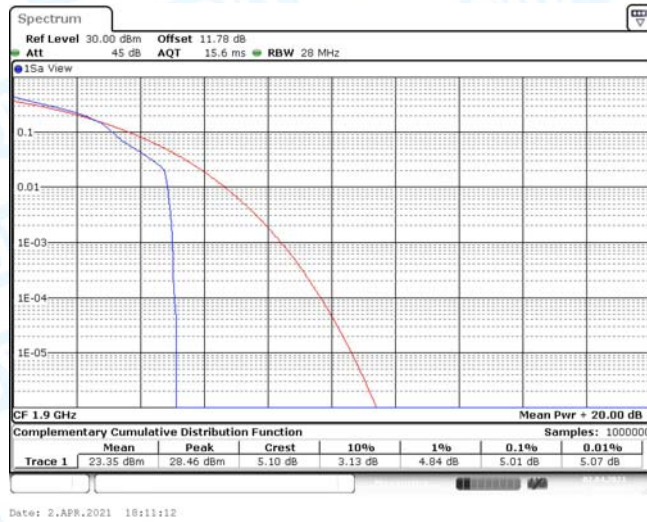

Band2-20MHz-16QAM-19100-100RB#0

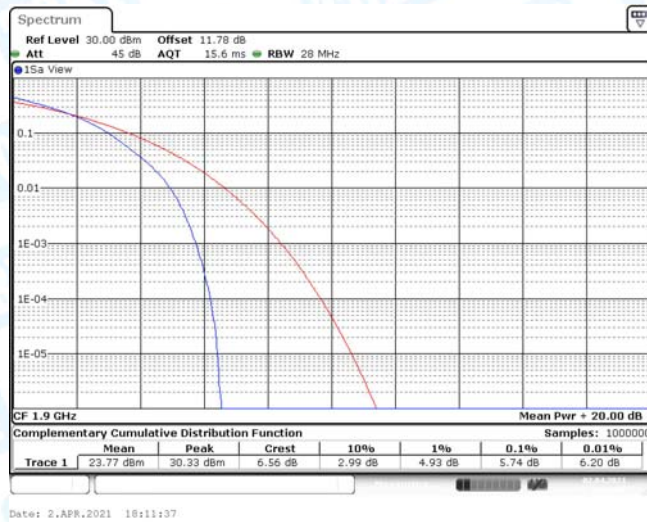

Band4-1.4MHz-QPSK-19957-6RB#0

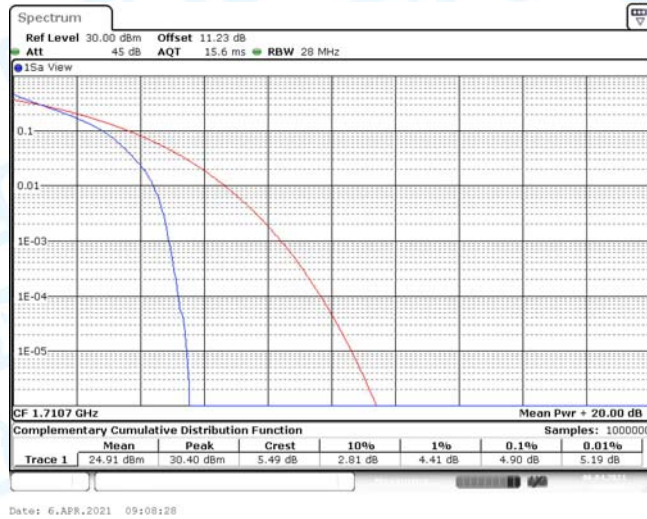

Band4-1.4MHz-QPSK-20175-6RB#0

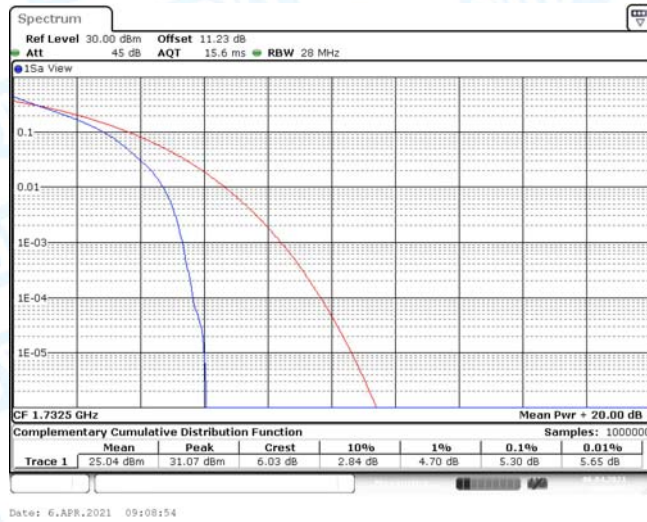

Band4-1.4MHz-QPSK-20393-6RB#0

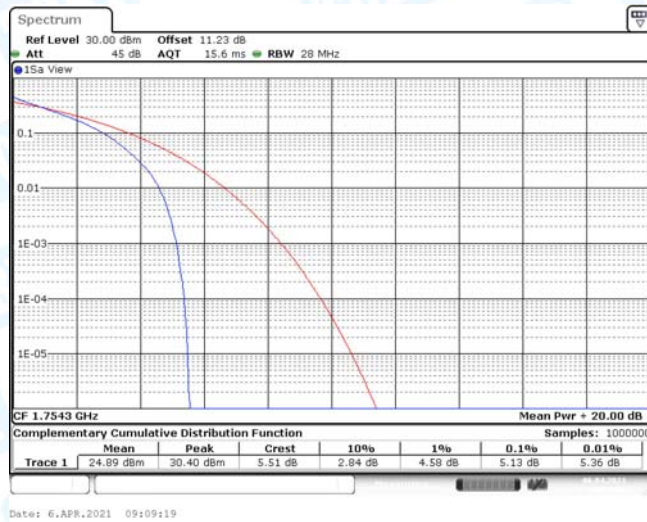

Band4-1.4MHz-16QAM-19957-6RB#0

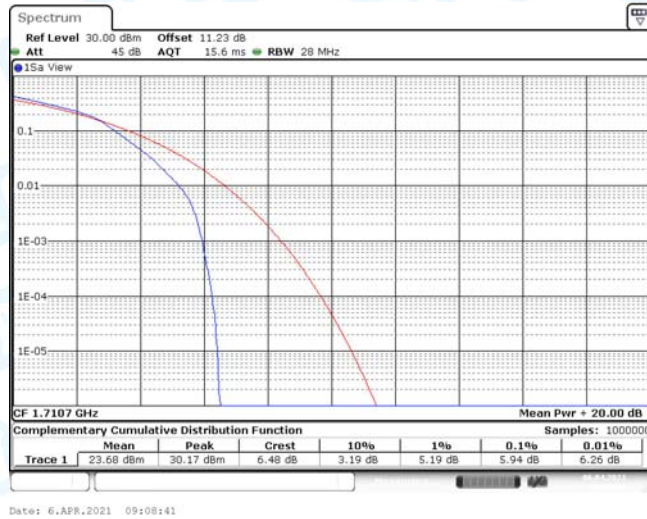

Band4-1.4MHz-16QAM-20175-6RB#0

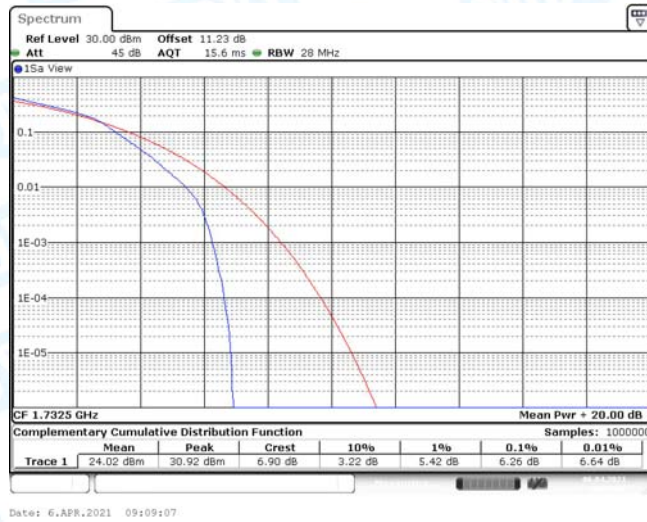

Band4-1.4MHz-16QAM-20393-6RB#0

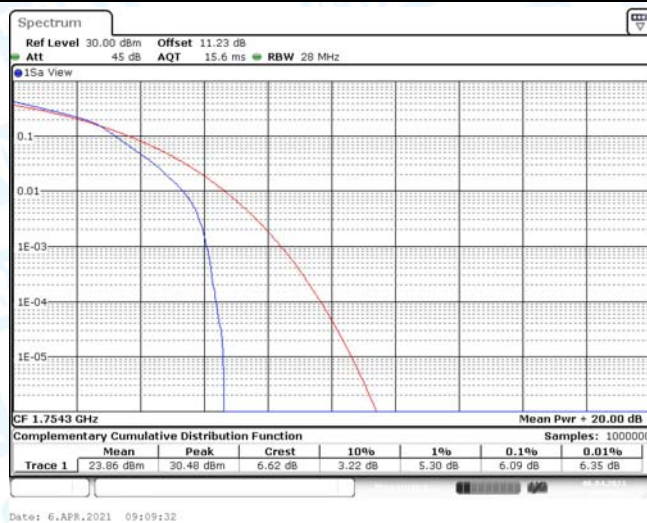

Band4-3MHz-QPSK-19965-15RB#0

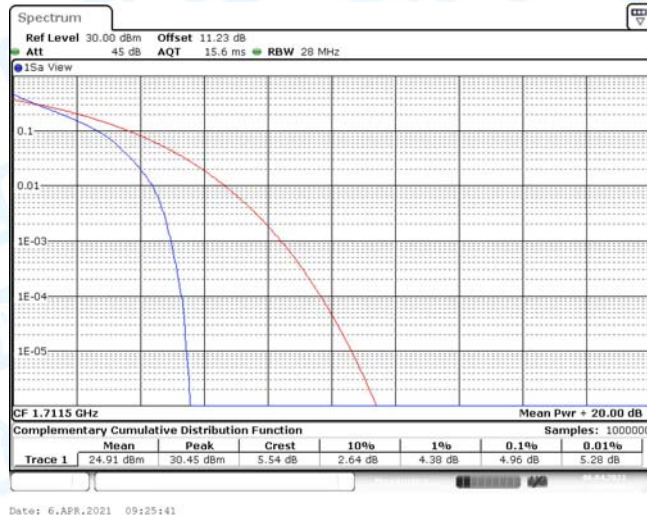

Band4-3MHz-QPSK-20175-15RB#0

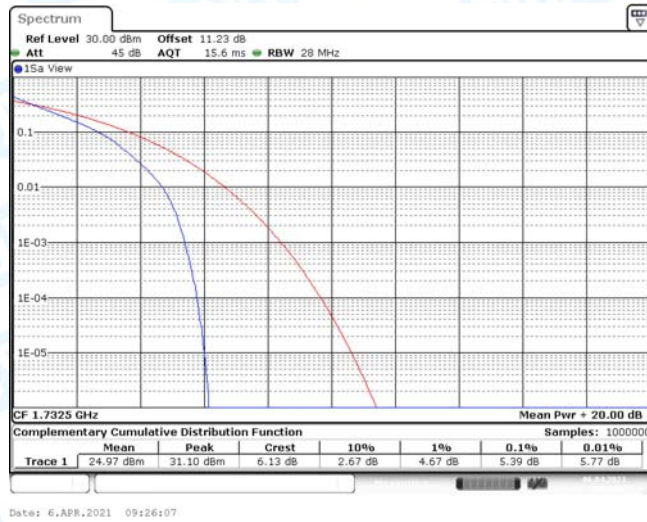

Band4-3MHz-QPSK-20385-15RB#0

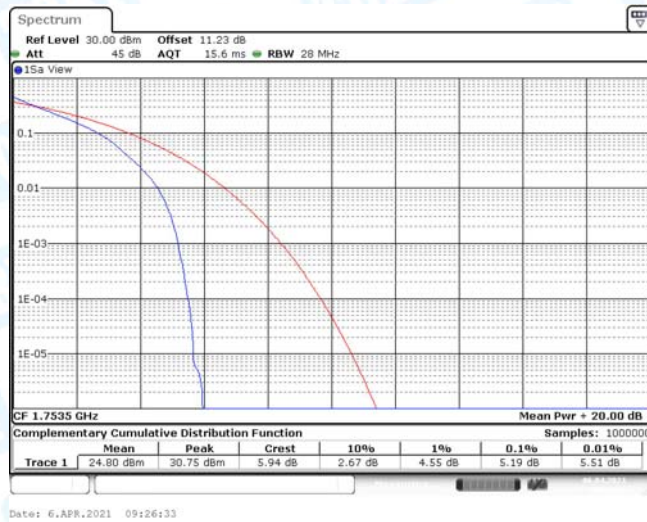

Band4-3MHz-16QAM-19965-15RB#0

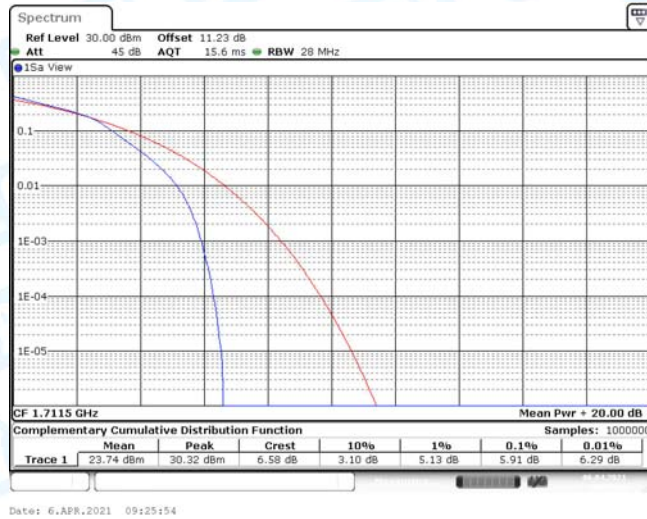

Band4-3MHz-16QAM-20175-15RB#0

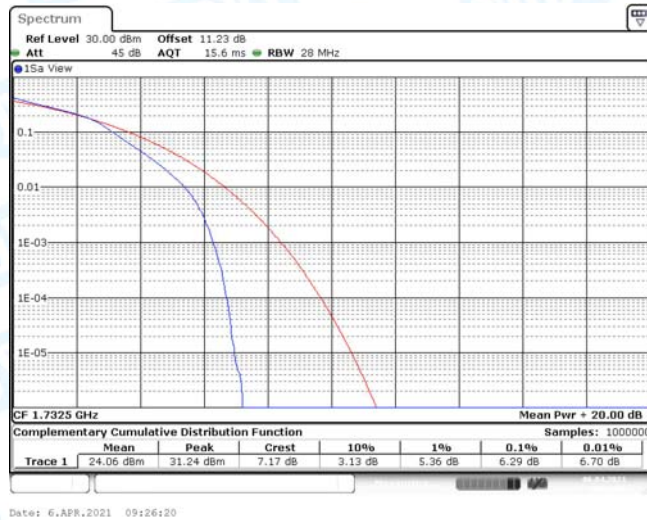

Band4-3MHz-16QAM-20385-15RB#0

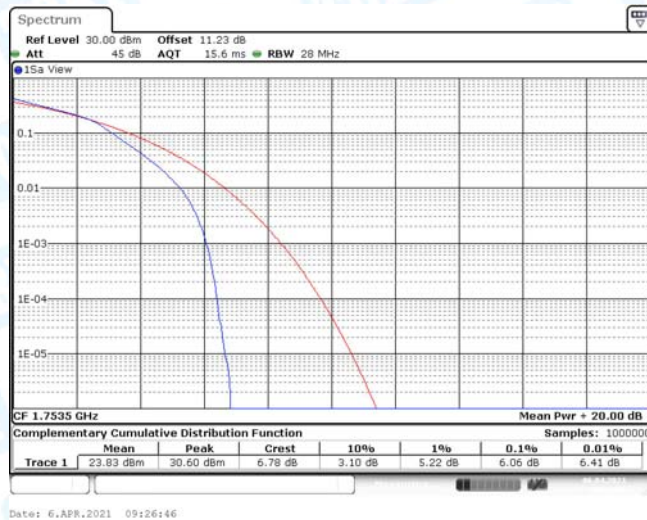

Band4-5MHz-QPSK-19975-25RB#0

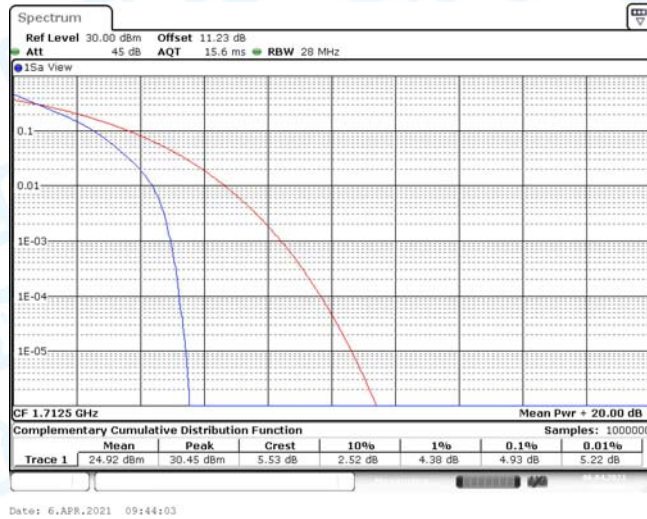

Band4-5MHz-QPSK-20175-25RB#0

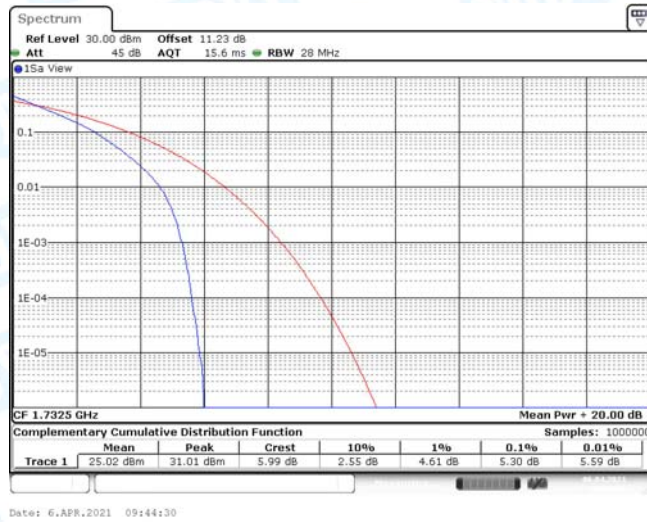

Band4-5MHz-QPSK-20375-25RB#0

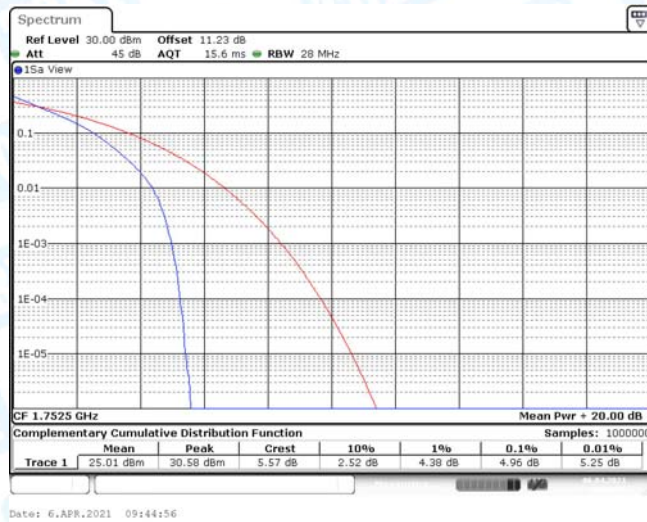

Band4-5MHz-16QAM-19975-25RB#0