

FCC Radio Test Report

FCC ID: 2APBP-CS30

Original Grant

Report No. : TB-FCC179356
Applicant : Ciontek Technology Corp.
Equipment Under Test (EUT)
EUT Name : Handheld Smart POS
Model No. : CS30
Series Model No. : CS30PRO, CS30LITE, CS30S, CS30V, CS30MINI, CS30A, CS30C, CS31, CS32
Brand Name : Ciontek
Sample ID : 20200916-08-01#& 20200916-08-02#
Receipt Date : 2021-03-22
Test Date : 2021-03-23 to 2021-05-25
Issue Date : 2021-05-28
Standards : FCC Part 2, FCC Part 22 Subpart H, FCC Part 24 Subpart E, FCC Part 27, ANSI/TIAC63.26: 2015
Conclusions : **PASS**
In the configuration tested, the EUT complied with the standards specified above.
The EUT technically complies with the FCC requirements

Test/Witness Engineer :

Rebecca

Rebecca

Engineer Supervisor :

IVAN SU

Ivan Su

Engineer Manager :

Ray Lai

Ray Lai



This report details the results of the testing carried out on one sample. The results contained in this test report do not relate to other samples of the same product. The manufacturer should ensure that all products in series production are in conformity with the product sample detailed in the report.

Contents

CONTENTS	2
1. GENERAL INFORMATION ABOUT EUT	5
1.1 Client Information.....	5
1.2 General Description of EUT (Equipment Under Test)	5
1.3 Block Diagram Showing the Configuration of System Tested.....	6
1.4 Description of Support Units	6
1.5 Description of Test Mode.....	7
1.6 Measurement Uncertainty	9
1.7 Test Facility.....	9
2. TEST SUMMARY	10
3. TEST EQUIPMENT	11
4. FREQUENCY STABILITY	12
4.1 Test Standard and Requirement	12
4.2 Test Setup.....	12
4.3 Test Procedure.....	13
4.4 EUT Operating Condition	13
4.5 Deviation From Test Standard.....	13
4.6 Test Data.....	13
5. CONDUCTED RF OUTPUT POWER	14
5.1 Test Standard and Limit.....	14
5.2 Test Setup.....	14
5.3 Test Procedure.....	14
5.4 EUT Operating Condition	14
5.5 Deviation From Test Standard.....	14
5.6 Test Data.....	14
6. PEAK-AVERAGE RATIO	15
6.1 Test Standard and Limit.....	15
6.2 Test Setup.....	15
6.3 Test Procedure.....	15
6.4 EUT Operating Condition	15
6.5 Deviation From Test Standard.....	15
6.6 Test Data.....	15
7. RADIATED OUTPUT POWER	16
7.1 Test Standard and Limit.....	16
7.2 Test Setup.....	16
7.3 Test Procedure.....	17
7.4 EUT Operating Condition	17
7.5 Deviation From Test Standard.....	17
7.6 Test Data.....	17
8. OCCUPIED BANDWIDTH	18

8.1 Test Standard and Limit.....	18
8.2 Test Setup.....	18
8.3 Test Procedure.....	18
8.4 EUT Operating Condition	19
8.5 Deviation From Test Standard.....	19
8.6 Test Data.....	19
9. CONDUCTED OUT OF BAND EMISSIONS.....	20
9.1 Test Standard and Limit.....	20
9.2 Test Setup.....	20
9.3 Test Procedure.....	20
9.4 EUT Operating Condition	20
9.5 Deviation From Test Standard.....	20
9.6 Test Data.....	20
10. BAND EDGE TEST.....	21
10.1 Test Standard and Limit	21
10.2 Test Setup.....	21
10.3 Test Procedure.....	21
10.4 EUT Operating Condition	21
10.5 Deviation From Test Standard.....	21
10.6 Test Data.....	21
11. RADIATED OUT BAND OF EMISSIONS.....	22
11.1 Test Standard and Limit	22
11.2 Test Setup.....	22
11.3 Test Procedure.....	22
11.4 EUT Operating Condition	23
11.5 Deviation From Test Standard.....	23
11.6 Test Data.....	23
ATTACHMENT A--FREQUENCY STABILITY	24
ATTACHMENT B--CONDUCTED RF OUTPUT POWER	33
ATTACHMENT C--PEAK-AVERAGE RATIO	38
ATTACHMENT D-- RADIATED OUTPUT POWER.....	51
ATTACHMENT E--OCCUPIED BANDWIDTH.....	54
ATTACHMENT F--CONDUCTED OUT OF BAND EMISSIONS.....	73
ATTACHMENT G-- BAND EDGE TEST.....	113
ATTACHMENT H--RADIATED OUT BAND OF EMISSIONS	130

1. General Information about EUT

1.1 Client Information

Applicant	:	Ciontek Technology Corp.
Address	:	B501, Chanxueyan Building Wuhan University, No.6 Of Yuexing 2nd Road, Yuehai Street, Nanshan District, Shenzhen, China
Manufacturer	:	Ciontek Technology Corp.
Address	:	B501, Chanxueyan Building Wuhan University, No.6 Of Yuexing 2nd Road, Yuehai Street, Nanshan District, Shenzhen, China

1.2 General Description of EUT (Equipment Under Test)

EUT Name	:	Handheld Smart POS
Models No.	:	CS30, CS30PRO, CS30LITE, CS30S, CS30V, CS30MINI, CS30A, CS30C, CS31, CS32
Model Difference	:	All these models are identical in the same PCB, layout and electrical circuit, The only difference is appearance color.
Product Description	FCC Operating Frequency:	GSM 850: 824.20MHz-848.80MHz PCS1900: 1850.20MHz-1909.80MHz UMTS Band II: 1852.40MHz-1907.60MHz UMTS Band IV: TX:1712.4MHz-1752.6MHz UMTS Band V:826.40MHz-846.60MHz
	Antenna Gain:	0.8dBi for GSM850/1900 0.8dBi WCDMA Band II/VI/V
	Modulation Type:	GSM/GPRS:GMSK EDGE: 8PSK UMTS:QPSK
Power Rating	:	Adapter(XS12-050200U) Input: 100-240V~, 50/60Hz, 0.5A Output: DC5V2A
Li-ion Polymer Battery	:	7.6V, 2600mAh, 19.76Wh
Software Version	:	a51_v0.01_20210316c
Hardware Version	:	CS30HWV2.0
Remark	:	The antenna gain and adapter provided by the applicant, the verified for the RF conduction test provided by TOBY test lab.

Note:

For a more detailed features description, please refer to the manufacturer's specifications or the User's Manual.

1.3 Block Diagram Showing the Configuration of System Tested

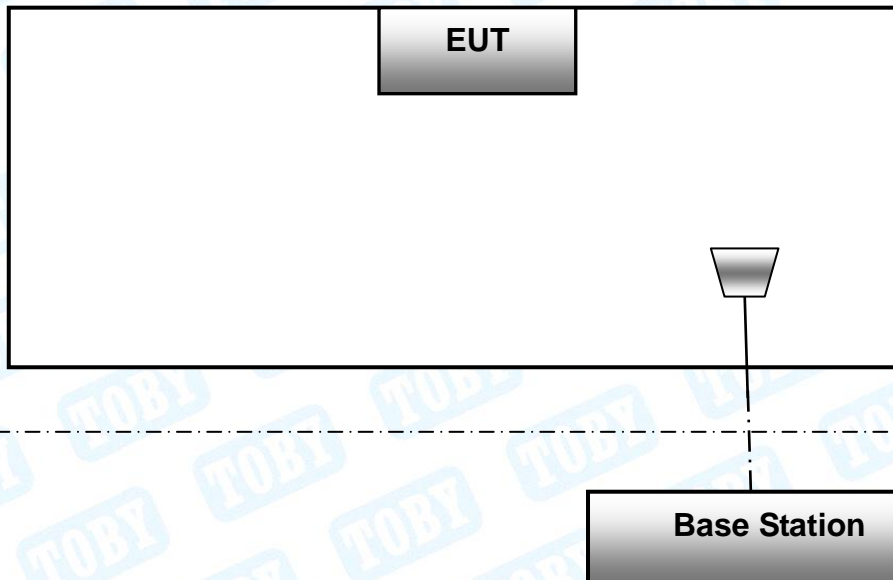

The above block diagram of setup is the normal mode. And more detail please refer to the test setup of each test item of bellow.

1.4 Description of Support Units

The EUT has been tested as an independent unit.

1.5 Description of Test Mode

To investigate the maximum EMI emission characteristics generates from EUT, the test system was pre-scanning tested base on the consideration of following EUT operation mode or test configuration mode which possible have effect on EMI emission level. Each of these EUT operation mode(s) or test configuration mode(s) mentioned follow was evaluated respectively.

During all testing, EUT is link mode with base station at maximum power level. The spurious emission measurements were carried out in semi-anechoic chamber with 3-meter test range. Frequency range investigated for radiated emission as below:

1. 9kHz~10GHz for GSM850 and UMTS Band V.
2. 9kHz~20GHz for PCS1900 and UMTS Band II/IV.

Test Channel		
Mode	Channel	Frequency(MHz)
GSM 850	128	824.20
	190	836.60
	251	848.80
PCS 1900	512	1850.20
	661	1880.00
	810	1909.80
UMTS Band II	9262	1852.40
	9400	1880.00
	9538	1907.60
UMTS Band IV	1312	1712.40
	1413	1732.60
	1513	1752.60
UMTS Band V	4132	826.40
	4183	836.60
	4233	846.60

Test Mode	Description
GSM 850	highest , middle, lowest channels
GPRS 850	highest , middle, lowest channels
EGPRS 850	highest , middle, lowest channels
GSM 1900	highest , middle, lowest channels
GPRS 1900	highest , middle, lowest channels
EGPRS 1900	highest , middle, lowest channels
RMC UMTS Band II	highest , middle, lowest channels
HSDPA UMTS Band II	highest , middle, lowest channels
HSUPA UMTS Band II	highest , middle, lowest channels
RMC UMTS Band IV	highest , middle, lowest channels
HSDPA UMTS Band IV	highest , middle, lowest channels
HSUPA UMTS Band IV	highest , middle, lowest channels
RMC UMTS Band V	highest , middle, lowest channels
HSDPA UMTS Band V	highest , middle, lowest channels
HSUPA UMTS Band V	highest , middle, lowest channels
For the Radiated test used the EUT-1(Sample ID: TBBJ-20200916-08_1-02).	
For the RF Conduction test used the EUT-2(Sample ID: TBBJ-20200916-08_1-01).	

Note:

- (1) The measurements are performed at the highest, middle, lowest available channels.
- (2) During the testing procedure, the EUT is in link mode with base station emulator at maximum power level in each test mode.
- (3) The EUT has GSM, GPRS, EDGE functions, and after pre-testing, GSM function is the worst case for all the emission tests.
- (4) The EUT has RMC, HSDPA, HSUPA functions in UMTS band II, UMTS band IV and UMTS band V, and after pre-testing, RMC mode is the worst case for all the emission tests.
- (5) The EUT is considered a portable unit; it was pre-tested on the positioned of each 3 axis, X-plane, Y-plane and Z-plane. The worst case was found positioned on Z-plane as the normal use. Therefore only the test data of this Z-plane was used for radiated emission measurement test.

1.6 Measurement Uncertainty

Test Item	Parameters	Expanded Uncertainty (U _{Lab})
Radiated Emission	Level Accuracy: 9kHz to 30 MHz	±4.60 dB
Radiated Emission	Level Accuracy: 30MHz to 1000 MHz	±4.50 dB
Radiated Emission	Level Accuracy: Above 1000MHz	±4.20 dB

1.7 Test Facility

The testing report were performed by the Shenzhen Toby Technology Co., Ltd., in their facilities located at 1A/F., Bldg.6, Yusheng Industrial Zone, The National Road No.107 Xixiang Section 467, Xixiang, Bao'an, Shenzhen, Guangdong, China. At the time of testing, the following bodies accredited the Laboratory:

CNAS (L5813)

The Laboratory has been accredited by CNAS to ISO/IEC 17025: 2017 General Requirements for the Competence of Testing and Calibration Laboratories for the competence in the field of testing. And the Registration No.: CNAS L5813.

A2LA Certificate No.: 4750.01

The laboratory has been accredited by American Association for Laboratory Accreditation(A2LA) to ISO/IEC 17025: 2017 General Requirements for the Competence of Testing and Calibration Laboratories for the technical competence in the field of Electrical Testing. And the A2LA Certificate No.: 4750.01. FCC Accredited Test Site Number: 854351.

IC Registration No.: (11950A)

The Laboratory has been registered by Certification and Engineering Bureau of Industry Canada for radio equipment testing. The site registration: Site# 11950A. CAB identifier: CN0056.

2. Test Summary

Test Standards and Test Results			
Standard	Document Title		
FCC Part 2 (10-1-05 Edition)	Frequency Allocations and Radio Treaty Matters; General Rules and Regulations		
FCC Part 22 (10-1-05 Edition)	Public Mobile Services		
FCC Part 24 (10-1-05 Edition)	Personal Communications Services		
FCC Part 27 (10-1-05 Edition)	Miscellaneous Wireless Communications Services		
Standard Section	Test Item	Judgment	Remark
2.1046;	Conducted RF Output Power	PASS	N/A
24.232(d); 27.50	Peak-Average Ratio	PASS	N/A
2.1049; 22.917; 24.238; 27.53	99% & -26 dB Occupied Bandwidth	PASS	N/A
2.1055; 22.355; 24.235; 27.54	Frequency Stability	PASS	N/A
2.1051; 2.1057; 22.917; 24.238; 27.53	Conducted Out of Band Emissions	PASS	N/A
2.1051; 2.1057; 22.917; 24.238; 27.53	Band Edge	PASS	N/A
22.913; 24.238; 27.50	Transmitter Radiated Power (EIRP/ERP)	PASS	N/A
2.1051; 2.1057; 22.917; 24.238; 27.53	Radiated Out of Band Emissions	PASS	N/A

Note: N/A is an abbreviation for Not Applicable.

3. Test Equipment

Radiation Emission Test					
Equipment	Manufacturer	Model No.	Serial No.	Last Cal.	Cal. Due Date
Spectrum Analyzer	Agilent	E4407B	MY45106456	Jul. 06, 2020	Jul. 05, 2021
EMI Test Receiver	Rohde & Schwarz	ESPI	100010/007	Jul. 06, 2020	Jul. 05, 2021
Spectrum Analyzer	Rohde & Schwarz	FSV40-N	102197	Jul. 06, 2020	Jul. 05, 2021
Wideband Radio Communication Tester	Rohde & Schwarz	CMW500	144382	Sep. 11, 2020	Sep. 10, 2021
Universal Radio Communication Tester	Rohde&Schwarz	CMU200	103903	Jul. 06, 2020	Jul. 05, 2021
Bilog Antenna	ETS-LINDGREN	3142E	00117537	Mar.01, 2020	Feb. 28, 2022
Horn Antenna	ETS-LINDGREN	3117	00143207	Mar.01, 2020	Feb. 28, 2022
Horn Antenna	ETS-LINDGREN	BBHA 9170	BBHA9170582	Mar.01, 2020	Feb. 28, 2022
Loop Antenna	SCHWARZBECK	FMZB 1519 B	1519B-059	Jul. 07, 2020	Jul. 06, 2021
Pre-amplifier	Sonoma	310N	185903	Feb. 25, 2021	Feb. 24, 2022
Pre-amplifier	HP	8449B	3008A00849	Feb. 25, 2021	Feb. 24, 2022
Pre-amplifier	SKET	LNPA_1840G-50	SK201904032	Feb. 25, 2021	Feb. 24, 2022
Cable	HUBER+SUHNER	100	SUCOFLEX	Feb. 25, 2021	Feb. 24, 2022
Positioning Controller	ETS-LINDGREN	2090	N/A	N/A	N/A
Antenna Conducted Emission					
Equipment	Manufacturer	Model No.	Serial No.	Last Cal.	Cal. Due Date
Spectrum Analyzer	Agilent	E4407B	MY45106456	Jul. 06, 2020	Jul. 05, 2021
Wideband Radio Communication Tester	Rohde & Schwarz	CMW500	144382	Sep. 11, 2020	Sep. 10, 2021
Universal Radio Communication Tester	Rohde&Schwarz	CMU200	103903	Jul. 06, 2020	Jul. 05, 2021
Spectrum Analyzer	Rohde & Schwarz	ESPI	100010/007	Jul. 06, 2020	Jul. 05, 2021
MXA Signal Analyzer	Agilent	N9020A	MY49100060	Sep. 11, 2020	Sep. 10, 2021
Vector Signal Generator	Agilent	N5182A	MY50141294	Sep. 11, 2020	Sep. 10, 2021
Analog Signal Generator	Agilent	N5181A	MY50141953	Sep. 11, 2020	Sep. 10, 2021
RF Power Sensor	DARE!! Instruments	RadiPowerRPR3006W	17100015SNO26	Sep. 11, 2020	Sep. 10, 2021
	DARE!! Instruments	RadiPowerRPR3006W	17100015SNO29	Sep. 11, 2020	Sep. 10, 2021
	DARE!! Instruments	RadiPowerRPR3006W	17100015SNO31	Sep. 11, 2020	Sep. 10, 2021
	DARE!! Instruments	RadiPowerRPR3006W	17100015SNO33	Sep. 11, 2020	Sep. 10, 2021

4. Frequency Stability

4.1 Test Standard and Requirement

4.1.1 Test Standard

- FCC Part 2.1055
- FCC Part 22.355
- FCC Part 24.235
- FCC Part 27.54

4.1.2 Requirement

According to FCC section 22.355 and FCC section 24.235, the frequency stability shall be sufficient to ensure that the fundamental emission stays within the authorized frequency block. According to FCC section 2.1055, the test conditions are:

(1) Temperature:

The temperature is varied from -30°C to $+50^{\circ}\text{C}$ at intervals of not more than 10°C .

(2) Primary Supply Voltage:

For hand carried battery powered equipment, the primary supply voltage is reduced to the battery operating end point which shall be specified by the manufacture. The supply voltage shall be measured at input to the cable normally provide with the equipment, or at the power supply terminals if cables are not normally provided.

4.2 Test Setup

For Temperature Test:

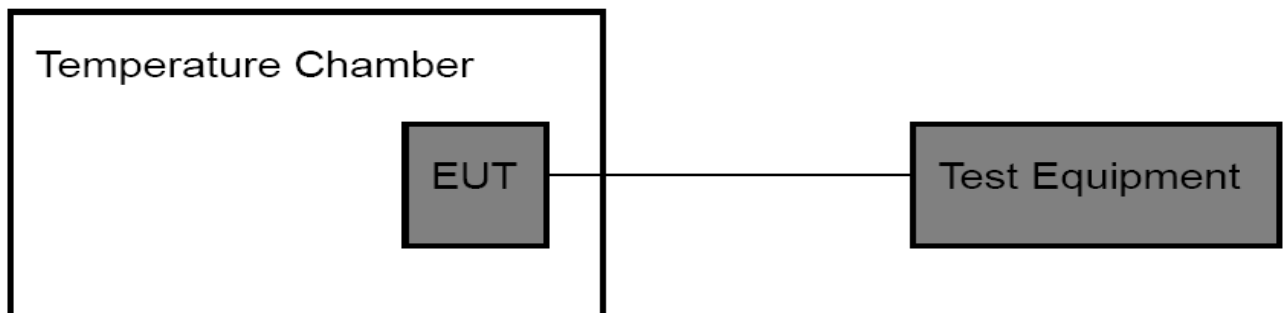

For Voltage Test:

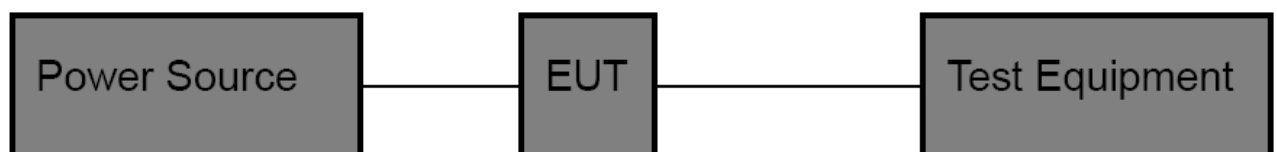

4.3 Test Procedure

Test Procedures for Temperature Variation:

- (1) The EUT was set up in the thermal chamber and connected with the base station.
- (2) With power off, the temperature was decreased to -30°C and the EUT was stabilized for three hours. Power was applied and the maximum change in frequency was recorded within one minute.
- (3) With power off, the temperature was raised in 10°C set up to 50°C and the EUT was stabilized for three hours. Power was applied and the maximum change in frequency was recorded within one minute.
- (4) If the EUT cannot be turned on at -30°C , the testing lowest temperature will be raised in 10°C step until the EUT can be turned on.

Test Procedures for Voltage Variation:

- (1) The EUT was placed in a temperature chamber at $25 \pm 5^{\circ}\text{C}$ and connected with the base station.
- (2) Reduce the input voltage to specify extreme voltage variation ($\pm 15\%$) and endpoint, record the maximum frequency change.
- (3) The variation in frequency was measured for the worst case.

4.4 EUT Operating Condition

The Equipment Under Test was set to Communication with the Base Station.

4.5 Deviation From Test Standard

No deviation

4.6 Test Data

Please refer to the Attachment A.

5. Conducted RF Output Power

5.1 Test Standard and Limit

5.1.1 Test Standard

FCC Part 2: 2.1046
FCC Part 22H : 22.913 (a)
FCC Part 24E: 24.232 (c)
FCC Part 27: 50

5.1.2 Test Limit

GSM850/UMTS Band V	UMTS Band IV	PCS 1900/UMTS Band II
38.5 dBm (ERP)	30 dBm (EIRP)	33 dBm (EIRP)

5.2 Test Setup

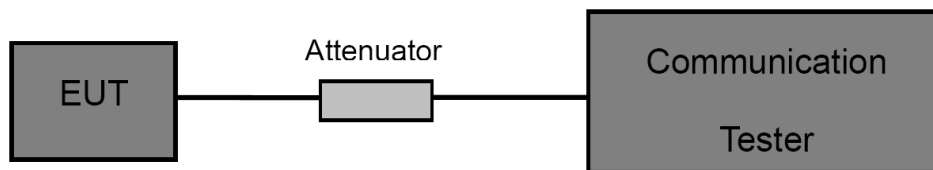

5.3 Test Procedure

- (1) The EUT is coupled to the Base Station with the suitable Attenuator, the path loss is calibrated to correct the reading.
- (2) A call is set up by the Base Station to the generic call set up procedure.
- (3) Set EUT at maximum power level through base station by power level command.
- (4) Then read record the power value from the Base Station in dBm.

5.4 EUT Operating Condition

The EUT was continuously connected with the Base station and transmitting in the max power during the test.

5.5 Deviation From Test Standard

No deviation

5.6 Test Data

Please refer to the Attachment B.

6. Peak-Average Ratio

6.1 Test Standard and Limit

- 6.1.1 Test Standard
 - FCC Part 24E: 24.232 (d)
 - FCC Part 27.50
- 6.1.2 Test Limit

Peak-to-Average Ratio

The peak-to-average ratio (PAR) of the transmission may not exceed 13 dB.

6.2 Test Setup

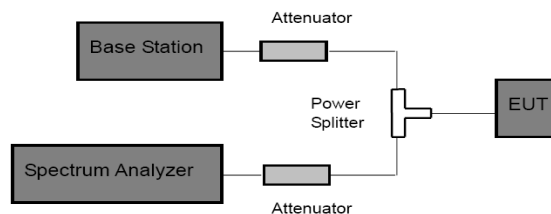

6.3 Test Procedure

According with KDB 971168

- (1) The signal analyzer's CCDF measurement profile is enabled.
- (2) Frequency = carrier center frequency.
- (3) Measurement BW > Emission bandwidth of signal.
- (4) The signal analyzer was set to collect one million samples to generate the CCDF curve.
- (5) The measurement interval was set depending on the type of signal analyzed. For continuous signals (>98% duty cycle), the measurement interval was set to 1ms. For burst transmissions, the spectrum analyzer is set to use an internal "RF Burst" trigger that is synced with an incoming pulse and the measurement interval is set to less than the duration of the "on time" of one burst to ensure that energy is only captured during a time in which of the transmitter is operating at maximum power.

6.4 EUT Operating Condition

The EUT was continuously connected with the Base station and transmitting in the max power during the test.

6.5 Deviation From Test Standard

No deviation

6.6 Test Data

Please refer to the Attachment C.

7. Radiated Output Power

7.1 Test Standard and Limit

7.1.1 Test Standard

FCC Part 22H: 22.913 (a)

FCC Part 24E: 24.232 (c)

FCC Part 27.50

7.1.2 Test Limit

According to FCC Part 22.913 (a), the ERP of Cellular mobile transmitters must not exceed 7 Watts(38.5 dBm).

According to FCC Part 24.232 (c), the Mobile/portable stations are limited to 2 Watts(33 dBm) EIRP peak power.

According to FCC Part 27.50 (d)(4), Fixed, mobile, and portable (hand-held) stations operating in the 1710-1755 MHz band and mobile and portable stations operating in the 1695-1710 MHz and 1755-1780 MHz bands are limited to 1 watt EIRP. Fixed stations operating in the 1710-1755 MHz band are limited to a maximum antenna height of 10 meters above ground. Mobile and portable stations operating in these bands must employ a means for limiting power to the minimum necessary for successful communications.

GSM850/UMTS Band V	UMTS Band IV	PCS 1900/UMTS Band II
38.5 dBm (ERP)	30 dBm (EIRP)	33 dBm (EIRP)

7.2 Test Setup

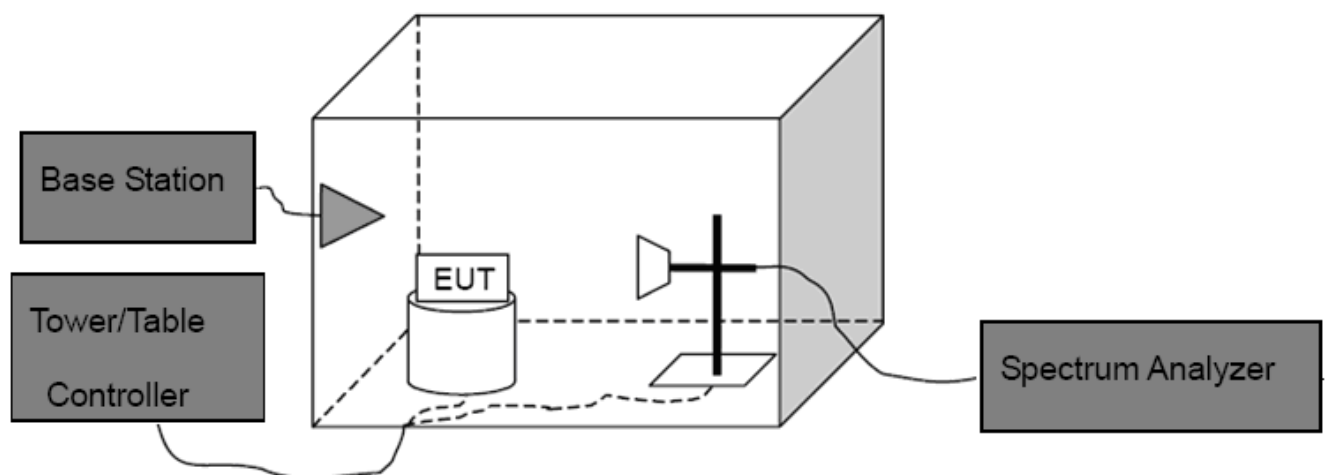

Above 1G

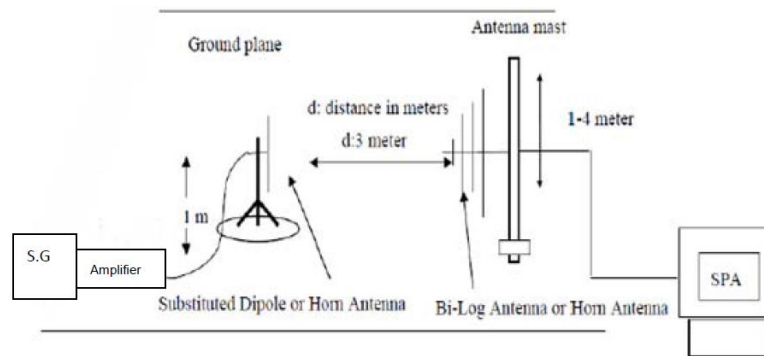

Substituted Method

7.3 Test Procedure

- (1) The EUT was placed on an non-conductive rotating platform with 0.8 meter height in an anechoic chamber. The radiated emission at the fundamental frequency was measured at 3 m with a test antenna and a spectrum analyzer with RBW=3 MHz, VBW=3 MHz and peak detector settings.
- (2) During the measurement, the EUT was enforced in maximum power and linked with the Base Station. The highest was recorded from analyzer power level (LVT) from the 360 degrees rotation of the turntable and the test antenna raised and lowered over a range from 1 to 4 meters in both horizontally and vertically polarized orientations.
- (3) Effective Isotropic Radiated Power (EIRP) was measured by substitution method according to C63.26. The EUT was replaced by dipole antenna (for frequency below 1 GHz) or Horn antenna (for frequency above 1 GHz) at same location with same polarize of receiver antenna and then a known power of each measure frequency from S.G. was applied into the dipole antenna or Horn antenna through a TX cable, and then recorded the maximum Analyzer reading through raised and lowered the test antenna.

Note: In test, the S.G Connect the Pre-amplifier(Sonoma 310N Pre-amplifier for frequency below 1 GHz, HP 8449B Pre-amplifier for frequency above 1 GHz)

Then the EUT’s EIRP and ERP was calculated with the correction factor:

$$ERP=S.G.Level +Antenna Gain Cord.(dBd)-Cable Loss(dB)$$

$$EIRP=S.G.Level+Antenna Gain Cord.(dBi)-Cable Loss(dB)$$

7.4 EUT Operating Condition

The EUT was continuously connected with the Base station and transmitting in the max power during the test.

7.5 Deviation From Test Standard

No deviation

7.6 Test Data

Please refer to the Attachment D.

8. Occupied Bandwidth

8.1 Test Standard and Limit

8.1.1 Test Standard

FCC Part 2: 2.1049

FCC Part 22H : 22.913 (a)

FCC Part 24E: 24.232 (c)

FCC Part 27.53

8.1.2 Test Requirement

According to FCC section 2.1049, the occupied bandwidth is the frequency bandwidth such that below its lower and above its upper frequency limits, the mean powers radiated are each equal to 0.5 percent of the total mean power radiated by a given emission.

Occupied bandwidth is also known as 99% power and -26dBC occupied bandwidths.

8.2 Test Setup

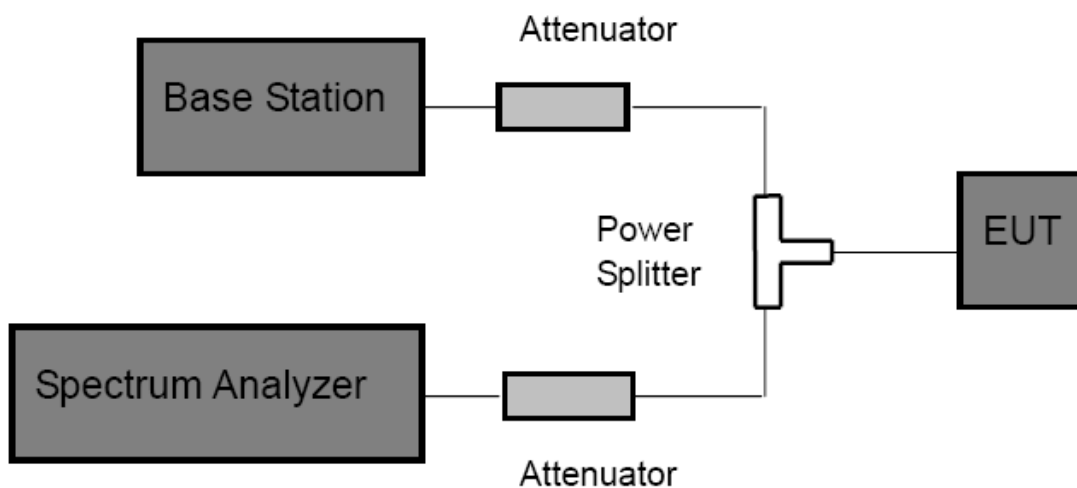

8.3 Test Procedure

- (1) The EUT was directly connected to the spectrum analyzer and Base station via power splitter as show in the block diagram above.
- (2) The resolution bandwidth of the Spectrum Analyzer is set to at least 1% of the occupied bandwidth.
- (3) The low, middle and the high channels are selected to perform tests respectively.
- (4) Set the frequency range of the Spectrum Analyzer suitably to capture the waveform; search peak; make a line whose value is 26dB lower than the peak; mark two points which the line intersected the waveform at; finally record the delta of the two points as the occupied bandwidth and the plot.
- (5) Set the Spectrum Analyzer Occupied bandwidth function to measure the 99% occupied bandwidth.

8.4 EUT Operating Condition

The EUT was continuously connected with the Base station and transmitting in the max power during the test.

8.5 Deviation From Test Standard

No deviation

8.6 Test Data

Please refer to the Attachment E.

9. Conducted Out of Band Emissions

9.1 Test Standard and Limit

9.1.1 Test Standard

FCC Part 2: 2.1051, 2.1057

FCC Part 22H: 22.917(a)

FCC Part 24E: 24.238(a)

FCC Part 27.53

9.1.2 Test Limit

The power of any emission outside of the authorized operating frequency ranges must be attenuated below the transmitting power(P) by a factor of at least $43+10\log(P)$ dB. For all power levels +30 dBm to 0 dBm, this becomes a constant specification limit of -13 dBm.

9.2 Test Setup

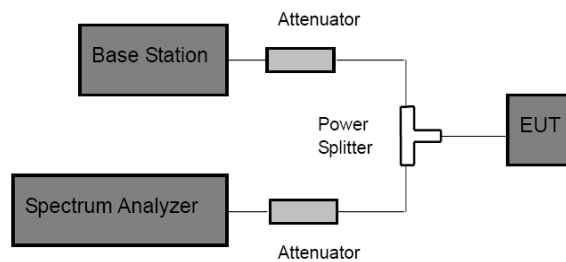

9.3 Test Procedure

- (1) The EUT was directly connected to the spectrum analyzer and Base station via power splitter as show in the block diagram above.
- (2) Spectrum Setting:
Frequency bellow 1 GHz: RBW=100 kHz, VBW=300 kHz.
Frequency above 1 GHz: RBW=1 MHz, VBW=3 MHz.
- (3) The low, middle and high channels of each band and mode's spurious emissions for 30 MHz to 10th Harmonic were measured by Spectrum analyzer.

9.4 EUT Operating Condition

The EUT was continuously connected with the Base station and transmitting in the max power during the test.

9.5 Deviation From Test Standard

No deviation

9.6 Test Data

Please refer to the Attachment F.

10. Band Edge Test

10.1 Test Standard and Limit

10.1.1 Test Standard

FCC Part 2: 2.1051, 2.1057

FCC Part 22H: 22.917(a)

FCC Part 24E: 24.238(a)

FCC Part 27.53

10.1.2 Test Limit

The power of any emission outside of the authorized operating frequency ranges must be attenuated below the transmitting power(P) by a factor of at least $43+10\log(P)$ dB. For all power levels +30 dBm to 0 dBm, this becomes a constant specification limit of -13 dBm.

10.2 Test Setup

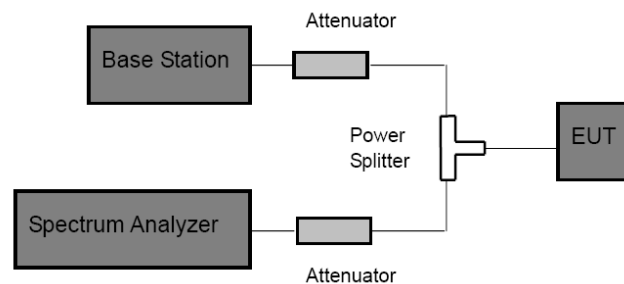

10.3 Test Procedure

(1) The EUT was directly connected to the spectrum analyzer and Base station via power splitter as show in the block diagram above.

(2) Spectrum Setting:

GSM and PCS: $RBW \geq 1\%$ 26db bandwidth, $VBW=3$ RBW, Span 1 MHz, Detector: Peak Mode.

WCDMA: $RBW \geq 1\%$ 26db bandwidth, $VBW=3$ RBW, Span 10 MHz, Detector: Peak Mode.

(3) The band edges of low and high channels for the highest RF powers were measured.

10.4 EUT Operating Condition

The EUT was continuously connected with the Base station and transmitting in the max power during the test.

10.5 Deviation From Test Standard

No deviation

10.6 Test Data

Please refer to the Attachment G.

11. Radiated Out Band of Emissions

11.1 Test Standard and Limit

11.1.1 Test Standard

FCC Part 2: 2.1053, 2.1057

FCC Part 22H: 22.917

FCC Part 24E: 24.238

FCC Part 27.53

11.1.2 Test Limit

The power of any emission outside of the authorized operating frequency ranges must be attenuated below the transmitting power(P) by a factor of at least $43+10\log(P)$ dB. For all power levels +30 dBm to 0 dBm, this becomes a constant specification limit of -13 dBm.

11.2 Test Setup

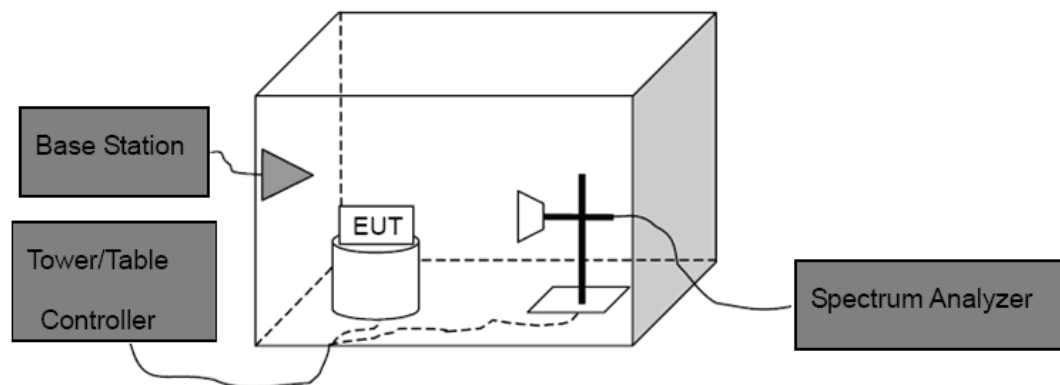

11.3 Test Procedure

- (1) The test system setup as show in the block diagram above.
- (2) The EUT was placed on an non-conductive rotating platform in an anechoic chamber. The radiated spurious emissions from 30MHz to 10th harmonious of fundamental frequency were measured at 3 m with a test antenna and a spectrum analyzer with RBW=1 MHz, VBW=1 MHz, peak detector settings.
- (3) During the measurement, the EUT was enforced in maximum power and linked with a base station. All the spurious emissions at 3m were measured by rotation of the turntable and the test antenna raised and lowered over a range from 1 to 4 meters in both horizontally and vertically polarized orientations.
- (4) When found the maximum level of emissions from the EUT. Remove the EUT and replace it with substitution antenna. A signal generator was connected to the substitution antenna by a non-radiating cable. The absolute levels of the spurious emissions were measured by the substitution.

Spurious emissions in dB=10 log(TX power in Watts/0.001)-the absolute level

Spurious attenuation limit in dB=43+10 log(power out in Watts)

11.4 EUT Operating Condition

The EUT was continuously connected with the Base station and transmitting in the max power during the test.

11.5 Deviation From Test Standard

No deviation

11.6 Test Data

Please refer to the Attachment H.

Attachment A--Frequency Stability

Voltage							
Band	Channel	Voltage [Vdc]	Temperature (°C)	Deviation (Hz)	Deviation (ppm)	Limit (ppm)	Verdict
GSM850	128	VL	NT	2.68	0.003252	±2.5	PASS
GSM850	128	VN	NT	4.71	0.005715	±2.5	PASS
GSM850	128	VH	NT	0.84	0.001019	±2.5	PASS
GSM850	190	VL	NT	2.20	0.002630	±2.5	PASS
GSM850	190	VN	NT	4.81	0.005749	±2.5	PASS
GSM850	190	VH	NT	2.71	0.003239	±2.5	PASS
GSM850	251	VL	NT	3.16	0.003723	±2.5	PASS
GSM850	251	VN	NT	4.46	0.005254	±2.5	PASS
GSM850	251	VH	NT	0.94	0.001107	±2.5	PASS
GPRS850	128	VL	NT	16.92	0.020529	±2.5	PASS
GPRS850	128	VN	NT	16.43	0.019934	±2.5	PASS
GPRS850	128	VH	NT	14.63	0.017751	±2.5	PASS
GPRS850	190	VL	NT	15.63	0.018683	±2.5	PASS
GPRS850	190	VN	NT	13.95	0.016675	±2.5	PASS
GPRS850	190	VH	NT	12.07	0.014427	±2.5	PASS
GPRS850	251	VL	NT	13.88	0.016352	±2.5	PASS
GPRS850	251	VN	NT	14.21	0.016741	±2.5	PASS
GPRS850	251	VH	NT	14.98	0.017648	±2.5	PASS
EGPRS850	128	VL	NT	16.79	0.020371	±2.5	PASS
EGPRS850	128	VN	NT	15.85	0.019231	±2.5	PASS
EGPRS850	128	VH	NT	15.63	0.018964	±2.5	PASS
EGPRS850	190	VL	NT	15.53	0.018563	±2.5	PASS
EGPRS850	190	VN	NT	13.40	0.016017	±2.5	PASS
EGPRS850	190	VH	NT	14.08	0.016830	±2.5	PASS
EGPRS850	251	VL	NT	11.88	0.013996	±2.5	PASS
EGPRS850	251	VN	NT	13.69	0.016129	±2.5	PASS
EGPRS850	251	VH	NT	15.98	0.018827	±2.5	PASS
GSM1900	512	VL	NT	-14.01	-0.007572	±2.5	PASS
GSM1900	512	VN	NT	-7.39	-0.003994	±2.5	PASS
GSM1900	512	VH	NT	-5.55	-0.003000	±2.5	PASS
GSM1900	661	VL	NT	-14.17	-0.007537	±2.5	PASS
GSM1900	661	VN	NT	-7.49	-0.003984	±2.5	PASS
GSM1900	661	VH	NT	-7.59	-0.004037	±2.5	PASS
GSM1900	810	VL	NT	-9.33	-0.004885	±2.5	PASS
GSM1900	810	VN	NT	-15.76	-0.008252	±2.5	PASS
GSM1900	810	VH	NT	-10.14	-0.005309	±2.5	PASS
GPRS1900	512	VL	NT	8.46	0.004572	±2.5	PASS
GPRS1900	512	VN	NT	5.46	0.002951	±2.5	PASS

GPRS1900	512	VH	NT	8.07	0.004362	±2.5	PASS
GPRS1900	661	VL	NT	5.97	0.003176	±2.5	PASS
GPRS1900	661	VN	NT	6.49	0.003452	±2.5	PASS
GPRS1900	661	VH	NT	1.13	0.000601	±2.5	PASS
GPRS1900	810	VL	NT	-0.81	-0.000424	±2.5	PASS
GPRS1900	810	VN	NT	2.71	0.001419	±2.5	PASS
GPRS1900	810	VH	NT	7.36	0.003854	±2.5	PASS
EGPRS1900	512	VL	NT	11.78	0.006367	±2.5	PASS
EGPRS1900	512	VN	NT	5.55	0.003000	±2.5	PASS
EGPRS1900	512	VH	NT	12.66	0.006843	±2.5	PASS
EGPRS1900	661	VL	NT	8.68	0.004617	±2.5	PASS
EGPRS1900	661	VN	NT	10.43	0.005548	±2.5	PASS
EGPRS1900	661	VH	NT	5.26	0.002798	±2.5	PASS
EGPRS1900	810	VL	NT	8.68	0.004545	±2.5	PASS
EGPRS1900	810	VN	NT	6.23	0.003262	±2.5	PASS
EGPRS1900	810	VH	NT	11.40	0.005969	±2.5	PASS

Temperature							
Band	Channel	Voltage [Vdc]	Temperature (°C)	Deviation (Hz)	Deviation (ppm)	Limit (ppm)	Verdict
GSM850	128	NV	-30	2.81	0.003409	±2.5	PASS
GSM850	128	NV	-20	3.13	0.003798	±2.5	PASS
GSM850	128	NV	-10	-1.84	-0.002232	±2.5	PASS
GSM850	128	NV	0	3.81	0.004623	±2.5	PASS
GSM850	128	NV	10	0.97	0.001177	±2.5	PASS
GSM850	128	NV	20	4.04	0.004902	±2.5	PASS
GSM850	128	NV	30	0.32	0.000388	±2.5	PASS
GSM850	128	NV	40	1.26	0.001529	±2.5	PASS
GSM850	128	NV	50	2.36	0.002863	±2.5	PASS
GSM850	190	NV	-30	-0.19	-0.000227	±2.5	PASS
GSM850	190	NV	-20	4.97	0.005941	±2.5	PASS
GSM850	190	NV	-10	1.74	0.002080	±2.5	PASS
GSM850	190	NV	0	4.58	0.005475	±2.5	PASS
GSM850	190	NV	10	0.26	0.000311	±2.5	PASS
GSM850	190	NV	20	0.94	0.001124	±2.5	PASS
GSM850	190	NV	30	-0.52	-0.000622	±2.5	PASS
GSM850	190	NV	40	2.62	0.003132	±2.5	PASS
GSM850	190	NV	50	2.42	0.002893	±2.5	PASS
GSM850	251	NV	-30	-0.10	-0.000118	±2.5	PASS
GSM850	251	NV	-20	-0.90	-0.001060	±2.5	PASS
GSM850	251	NV	-10	-0.26	-0.000306	±2.5	PASS
GSM850	251	NV	0	3.36	0.003959	±2.5	PASS
GSM850	251	NV	10	0.94	0.001107	±2.5	PASS
GSM850	251	NV	20	2.16	0.002545	±2.5	PASS
GSM850	251	NV	30	4.29	0.005054	±2.5	PASS
GSM850	251	NV	40	1.90	0.002238	±2.5	PASS
GSM850	251	NV	50	5.71	0.006727	±2.5	PASS
GPRS850	128	NV	-30	13.33	0.016173	±2.5	PASS
GPRS850	128	NV	-20	17.95	0.021779	±2.5	PASS
GPRS850	128	NV	-10	15.53	0.018843	±2.5	PASS
GPRS850	128	NV	0	15.98	0.019388	±2.5	PASS
GPRS850	128	NV	10	16.82	0.020408	±2.5	PASS
GPRS850	128	NV	20	12.04	0.014608	±2.5	PASS
GPRS850	128	NV	30	14.75	0.017896	±2.5	PASS
GPRS850	128	NV	40	18.76	0.022761	±2.5	PASS
GPRS850	128	NV	50	16.79	0.020371	±2.5	PASS
GPRS850	190	NV	-30	13.69	0.016364	±2.5	PASS
GPRS850	190	NV	-20	14.72	0.017595	±2.5	PASS

GPRS850	190	NV	-10	9.59	0.011463	±2.5	PASS
GPRS850	190	NV	0	15.01	0.017942	±2.5	PASS
GPRS850	190	NV	10	14.01	0.016746	±2.5	PASS
GPRS850	190	NV	20	13.08	0.015635	±2.5	PASS
GPRS850	190	NV	30	14.40	0.017213	±2.5	PASS
GPRS850	190	NV	40	13.17	0.015742	±2.5	PASS
GPRS850	190	NV	50	13.20	0.015778	±2.5	PASS
GPRS850	251	NV	-30	16.18	0.019062	±2.5	PASS
GPRS850	251	NV	-20	12.30	0.014491	±2.5	PASS
GPRS850	251	NV	-10	16.08	0.018944	±2.5	PASS
GPRS850	251	NV	0	16.53	0.019475	±2.5	PASS
GPRS850	251	NV	10	13.37	0.015752	±2.5	PASS
GPRS850	251	NV	20	16.08	0.018944	±2.5	PASS
GPRS850	251	NV	30	14.43	0.017000	±2.5	PASS
GPRS850	251	NV	40	11.62	0.013690	±2.5	PASS
GPRS850	251	NV	50	15.27	0.017990	±2.5	PASS
EGPRS850	128	NV	-30	17.66	0.021427	±2.5	PASS
EGPRS850	128	NV	-20	17.27	0.020954	±2.5	PASS
EGPRS850	128	NV	-10	16.37	0.019862	±2.5	PASS
EGPRS850	128	NV	0	18.66	0.022640	±2.5	PASS
EGPRS850	128	NV	10	18.85	0.022871	±2.5	PASS
EGPRS850	128	NV	20	19.92	0.024169	±2.5	PASS
EGPRS850	128	NV	30	18.47	0.022410	±2.5	PASS
EGPRS850	128	NV	40	18.95	0.022992	±2.5	PASS
EGPRS850	128	NV	50	17.24	0.020917	±2.5	PASS
EGPRS850	190	NV	-30	17.56	0.020990	±2.5	PASS
EGPRS850	190	NV	-20	16.69	0.019950	±2.5	PASS
EGPRS850	190	NV	-10	12.88	0.015396	±2.5	PASS
EGPRS850	190	NV	0	15.82	0.018910	±2.5	PASS
EGPRS850	190	NV	10	11.14	0.013316	±2.5	PASS
EGPRS850	190	NV	20	10.91	0.013041	±2.5	PASS
EGPRS850	190	NV	30	15.98	0.019101	±2.5	PASS
EGPRS850	190	NV	40	12.53	0.014977	±2.5	PASS
EGPRS850	190	NV	50	15.05	0.017989	±2.5	PASS
EGPRS850	251	NV	-30	16.50	0.019439	±2.5	PASS
EGPRS850	251	NV	-20	16.53	0.019475	±2.5	PASS
EGPRS850	251	NV	-10	17.34	0.020429	±2.5	PASS
EGPRS850	251	NV	0	15.76	0.018567	±2.5	PASS
EGPRS850	251	NV	10	14.85	0.017495	±2.5	PASS
EGPRS850	251	NV	20	16.11	0.018980	±2.5	PASS
EGPRS850	251	NV	30	14.85	0.017495	±2.5	PASS
EGPRS850	251	NV	40	16.37	0.019286	±2.5	PASS

EGPRS850	251	NV	50	15.53	0.018296	±2.5	PASS
GSM1900	512	NV	-30	-6.23	-0.003367	±2.5	PASS
GSM1900	512	NV	-20	-13.59	-0.007345	±2.5	PASS
GSM1900	512	NV	-10	-5.65	-0.003054	±2.5	PASS
GSM1900	512	NV	0	-6.52	-0.003524	±2.5	PASS
GSM1900	512	NV	10	-14.37	-0.007767	±2.5	PASS
GSM1900	512	NV	20	-13.98	-0.007556	±2.5	PASS
GSM1900	512	NV	30	-7.04	-0.003805	±2.5	PASS
GSM1900	512	NV	40	-8.68	-0.004691	±2.5	PASS
GSM1900	512	NV	50	-3.00	-0.001621	±2.5	PASS
GSM1900	661	NV	-30	-7.36	-0.003915	±2.5	PASS
GSM1900	661	NV	-20	-11.30	-0.006011	±2.5	PASS
GSM1900	661	NV	-10	-14.88	-0.007915	±2.5	PASS
GSM1900	661	NV	0	-14.75	-0.007846	±2.5	PASS
GSM1900	661	NV	10	-7.68	-0.004085	±2.5	PASS
GSM1900	661	NV	20	-9.65	-0.005133	±2.5	PASS
GSM1900	661	NV	30	-12.43	-0.006612	±2.5	PASS
GSM1900	661	NV	40	-13.69	-0.007282	±2.5	PASS
GSM1900	661	NV	50	-10.43	-0.005548	±2.5	PASS
GSM1900	810	NV	-30	-11.01	-0.005765	±2.5	PASS
GSM1900	810	NV	-20	-7.30	-0.003822	±2.5	PASS
GSM1900	810	NV	-10	-11.78	-0.006168	±2.5	PASS
GSM1900	810	NV	0	-9.52	-0.004985	±2.5	PASS
GSM1900	810	NV	10	-17.21	-0.009011	±2.5	PASS
GSM1900	810	NV	20	-12.79	-0.006697	±2.5	PASS
GSM1900	810	NV	30	-5.71	-0.002990	±2.5	PASS
GSM1900	810	NV	40	-16.18	-0.008472	±2.5	PASS
GSM1900	810	NV	50	-7.46	-0.003906	±2.5	PASS
GPRS1900	512	NV	-30	5.65	0.003054	±2.5	PASS
GPRS1900	512	NV	-20	10.30	0.005567	±2.5	PASS
GPRS1900	512	NV	-10	2.68	0.001448	±2.5	PASS
GPRS1900	512	NV	0	7.94	0.004291	±2.5	PASS
GPRS1900	512	NV	10	8.07	0.004362	±2.5	PASS
GPRS1900	512	NV	20	4.88	0.002638	±2.5	PASS
GPRS1900	512	NV	30	9.04	0.004886	±2.5	PASS
GPRS1900	512	NV	40	8.52	0.004605	±2.5	PASS
GPRS1900	512	NV	50	2.87	0.001551	±2.5	PASS
GPRS1900	661	NV	-30	6.36	0.003383	±2.5	PASS
GPRS1900	661	NV	-20	-0.32	-0.000170	±2.5	PASS
GPRS1900	661	NV	-10	5.59	0.002973	±2.5	PASS
GPRS1900	661	NV	0	7.78	0.004138	±2.5	PASS
GPRS1900	661	NV	10	7.26	0.003862	±2.5	PASS

GPRS1900	661	NV	20	4.58	0.002436	±2.5	PASS
GPRS1900	661	NV	30	6.68	0.003553	±2.5	PASS
GPRS1900	661	NV	40	0.90	0.000479	±2.5	PASS
GPRS1900	661	NV	50	1.03	0.000548	±2.5	PASS
GPRS1900	810	NV	-30	5.94	0.003110	±2.5	PASS
GPRS1900	810	NV	-20	5.55	0.002906	±2.5	PASS
GPRS1900	810	NV	-10	4.88	0.002555	±2.5	PASS
GPRS1900	810	NV	0	3.62	0.001895	±2.5	PASS
GPRS1900	810	NV	10	3.36	0.001759	±2.5	PASS
GPRS1900	810	NV	20	7.81	0.004089	±2.5	PASS
GPRS1900	810	NV	30	3.07	0.001607	±2.5	PASS
GPRS1900	810	NV	40	1.45	0.000759	±2.5	PASS
GPRS1900	810	NV	50	0.84	0.000440	±2.5	PASS
EGPRS1900	512	NV	-30	9.20	0.004972	±2.5	PASS
EGPRS1900	512	NV	-20	9.94	0.005372	±2.5	PASS
EGPRS1900	512	NV	-10	8.10	0.004378	±2.5	PASS
EGPRS1900	512	NV	0	6.97	0.003767	±2.5	PASS
EGPRS1900	512	NV	10	5.71	0.003086	±2.5	PASS
EGPRS1900	512	NV	20	7.72	0.004173	±2.5	PASS
EGPRS1900	512	NV	30	11.95	0.006459	±2.5	PASS
EGPRS1900	512	NV	40	11.78	0.006367	±2.5	PASS
EGPRS1900	512	NV	50	7.97	0.004308	±2.5	PASS
EGPRS1900	661	NV	-30	2.55	0.001356	±2.5	PASS
EGPRS1900	661	NV	-20	5.20	0.002766	±2.5	PASS
EGPRS1900	661	NV	-10	3.10	0.001649	±2.5	PASS
EGPRS1900	661	NV	0	4.42	0.002351	±2.5	PASS
EGPRS1900	661	NV	10	12.27	0.006527	±2.5	PASS
EGPRS1900	661	NV	20	8.52	0.004532	±2.5	PASS
EGPRS1900	661	NV	30	10.33	0.005495	±2.5	PASS
EGPRS1900	661	NV	40	3.49	0.001856	±2.5	PASS
EGPRS1900	661	NV	50	10.04	0.005340	±2.5	PASS
EGPRS1900	810	NV	-30	7.65	0.004006	±2.5	PASS
EGPRS1900	810	NV	-20	16.18	0.008472	±2.5	PASS
EGPRS1900	810	NV	-10	7.72	0.004042	±2.5	PASS
EGPRS1900	810	NV	0	6.04	0.003163	±2.5	PASS
EGPRS1900	810	NV	10	7.52	0.003938	±2.5	PASS
EGPRS1900	810	NV	20	6.88	0.003602	±2.5	PASS
EGPRS1900	810	NV	30	9.94	0.005205	±2.5	PASS
EGPRS1900	810	NV	40	7.43	0.003890	±2.5	PASS
EGPRS1900	810	NV	50	12.17	0.006372	±2.5	PASS

Voltage							
Band	Channel	Voltage (Vdc)	Temperature (°C)	Deviation (Hz)	Deviation (ppm)	Limit (ppm)	Verdict
Band2	9262	VL	NT	2.55	0.001377	±2.5	PASS
Band2	9262	VN	NT	2.29	0.001236	±2.5	PASS
Band2	9262	VH	NT	2.35	0.001269	±2.5	PASS
Band2	9400	VL	NT	-0.13	-0.000069	±2.5	PASS
Band2	9400	VN	NT	0.24	0.000128	±2.5	PASS
Band2	9400	VH	NT	-1.22	-0.000649	±2.5	PASS
Band2	9538	VL	NT	-4.36	-0.002286	±2.5	PASS
Band2	9538	VN	NT	-4.48	-0.002349	±2.5	PASS
Band2	9538	VH	NT	-4.43	-0.002322	±2.5	PASS
Temperature							
Band	Channel	Voltage (Vdc)	Temperature (°C)	Deviation (Hz)	Deviation (ppm)	Limit (ppm)	Verdict
Band2	9262	NV	-30	2.26	0.001220	±2.5	PASS
Band2	9262	NV	-20	3.45	0.001862	±2.5	PASS
Band2	9262	NV	-10	2.64	0.001425	±2.5	PASS
Band2	9262	NV	0	2.69	0.001452	±2.5	PASS
Band2	9262	NV	10	2.09	0.001128	±2.5	PASS
Band2	9262	NV	20	3.69	0.001992	±2.5	PASS
Band2	9262	NV	30	2.65	0.001431	±2.5	PASS
Band2	9262	NV	40	3.41	0.001841	±2.5	PASS
Band2	9262	NV	50	3.50	0.001889	±2.5	PASS
Band2	9400	NV	-30	-0.79	-0.000420	±2.5	PASS
Band2	9400	NV	-20	-0.60	-0.000319	±2.5	PASS
Band2	9400	NV	-10	-1.03	-0.000548	±2.5	PASS
Band2	9400	NV	0	-0.21	-0.000112	±2.5	PASS
Band2	9400	NV	10	-0.69	-0.000367	±2.5	PASS
Band2	9400	NV	20	0.18	0.000096	±2.5	PASS
Band2	9400	NV	30	-0.35	-0.000186	±2.5	PASS
Band2	9400	NV	40	-0.54	-0.000287	±2.5	PASS
Band2	9400	NV	50	0.48	0.000255	±2.5	PASS
Band2	9538	NV	-30	-4.68	-0.002453	±2.5	PASS
Band2	9538	NV	-20	-4.50	-0.002359	±2.5	PASS
Band2	9538	NV	-10	-4.19	-0.002196	±2.5	PASS
Band2	9538	NV	0	-3.91	-0.002050	±2.5	PASS
Band2	9538	NV	10	-5.56	-0.002915	±2.5	PASS
Band2	9538	NV	20	-3.25	-0.001704	±2.5	PASS
Band2	9538	NV	30	-5.01	-0.002626	±2.5	PASS
Band2	9538	NV	40	-4.58	-0.002401	±2.5	PASS
Band2	9538	NV	50	-4.40	-0.002307	±2.5	PASS

Voltage							
Band	Channel	Voltage (Vdc)	Temperature (°C)	Deviation (Hz)	Deviation (ppm)	Limit (ppm)	Verdict
Band4	1312	VL	NT	14.28	0.008339	±2.5	PASS
Band4	1312	VN	NT	13.22	0.007720	±2.5	PASS
Band4	1312	VH	NT	14.08	0.008222	±2.5	PASS
Band4	1413	VL	NT	-0.54	-0.000312	±2.5	PASS
Band4	1413	VN	NT	-0.62	-0.000358	±2.5	PASS
Band4	1413	VH	NT	-0.12	-0.000069	±2.5	PASS
Band4	1513	VL	NT	-13.97	-0.007971	±2.5	PASS
Band4	1513	VN	NT	-13.26	-0.007566	±2.5	PASS
Band4	1513	VH	NT	-13.50	-0.007703	±2.5	PASS
Temperature							
Band	Channel	Voltage (Vdc)	Temperature (°C)	Deviation (Hz)	Deviation (ppm)	Limit (ppm)	Verdict
Band4	1312	NV	-30	15.20	0.008876	±2.5	PASS
Band4	1312	NV	-20	15.49	0.009046	±2.5	PASS
Band4	1312	NV	-10	16.09	0.009396	±2.5	PASS
Band4	1312	NV	0	15.31	0.008941	±2.5	PASS
Band4	1312	NV	10	15.60	0.009110	±2.5	PASS
Band4	1312	NV	20	16.01	0.009349	±2.5	PASS
Band4	1312	NV	30	15.57	0.009093	±2.5	PASS
Band4	1312	NV	40	16.36	0.009554	±2.5	PASS
Band4	1312	NV	50	16.15	0.009431	±2.5	PASS
Band4	1413	NV	-30	0.82	0.000473	±2.5	PASS
Band4	1413	NV	-20	0.47	0.000271	±2.5	PASS
Band4	1413	NV	-10	0.27	0.000156	±2.5	PASS
Band4	1413	NV	0	0.67	0.000387	±2.5	PASS
Band4	1413	NV	10	0.11	0.000063	±2.5	PASS
Band4	1413	NV	20	-0.69	-0.000398	±2.5	PASS
Band4	1413	NV	30	0.36	0.000208	±2.5	PASS
Band4	1413	NV	40	0.21	0.000121	±2.5	PASS
Band4	1413	NV	50	0.64	0.000369	±2.5	PASS
Band4	1513	NV	-30	-13.21	-0.007537	±2.5	PASS
Band4	1513	NV	-20	-13.31	-0.007594	±2.5	PASS
Band4	1513	NV	-10	-13.60	-0.007760	±2.5	PASS
Band4	1513	NV	0	-13.93	-0.007948	±2.5	PASS
Band4	1513	NV	10	-13.27	-0.007572	±2.5	PASS
Band4	1513	NV	20	-13.46	-0.007680	±2.5	PASS
Band4	1513	NV	30	-13.04	-0.007440	±2.5	PASS
Band4	1513	NV	40	-13.63	-0.007777	±2.5	PASS
Band4	1513	NV	50	-13.42	-0.007657	±2.5	PASS

Voltage							
Band	Channel	Voltage (Vdc)	Temperature (°C)	Deviation (Hz)	Deviation (ppm)	Limit (ppm)	Verdict
Band5	4132	VL	NT	1.72	0.002081	±2.5	PASS
Band5	4132	VN	NT	2.09	0.002529	±2.5	PASS
Band5	4132	VH	NT	1.66	0.002009	±2.5	PASS
Band5	4183	VL	NT	0.11	0.000131	±2.5	PASS
Band5	4183	VN	NT	-0.06	-0.000072	±2.5	PASS
Band5	4183	VH	NT	-0.27	-0.000323	±2.5	PASS
Band5	4233	VL	NT	-1.47	-0.001736	±2.5	PASS
Band5	4233	VN	NT	-1.48	-0.001748	±2.5	PASS
Band5	4233	VH	NT	-1.79	-0.002114	±2.5	PASS
Temperature							
Band	Channel	Voltage (Vdc)	Temperature (°C)	Deviation (Hz)	Deviation (ppm)	Limit (ppm)	Verdict
Band5	4132	NV	-30	2.02	0.002444	±2.5	PASS
Band5	4132	NV	-20	1.76	0.002130	±2.5	PASS
Band5	4132	NV	-10	1.63	0.001972	±2.5	PASS
Band5	4132	NV	0	2.12	0.002565	±2.5	PASS
Band5	4132	NV	10	1.82	0.002202	±2.5	PASS
Band5	4132	NV	20	2.12	0.002565	±2.5	PASS
Band5	4132	NV	30	1.88	0.002275	±2.5	PASS
Band5	4132	NV	40	1.80	0.002178	±2.5	PASS
Band5	4132	NV	50	1.89	0.002287	±2.5	PASS
Band5	4183	NV	-30	0.01	0.000012	±2.5	PASS
Band5	4183	NV	-20	-0.01	-0.000012	±2.5	PASS
Band5	4183	NV	-10	0.05	0.000060	±2.5	PASS
Band5	4183	NV	0	0.17	0.000203	±2.5	PASS
Band5	4183	NV	10	0.22	0.000263	±2.5	PASS
Band5	4183	NV	20	0.31	0.000371	±2.5	PASS
Band5	4183	NV	30	0.10	0.000120	±2.5	PASS
Band5	4183	NV	40	-0.26	-0.000311	±2.5	PASS
Band5	4183	NV	50	-0.19	-0.000227	±2.5	PASS
Band5	4233	NV	-30	-1.97	-0.002327	±2.5	PASS
Band5	4233	NV	-20	-2.03	-0.002398	±2.5	PASS
Band5	4233	NV	-10	-2.10	-0.002481	±2.5	PASS
Band5	4233	NV	0	-1.77	-0.002091	±2.5	PASS
Band5	4233	NV	10	-1.64	-0.001937	±2.5	PASS
Band5	4233	NV	20	-1.87	-0.002209	±2.5	PASS
Band5	4233	NV	30	-1.87	-0.002209	±2.5	PASS
Band5	4233	NV	40	-1.80	-0.002126	±2.5	PASS
Band5	4233	NV	50	-1.64	-0.001937	±2.5	PASS

Attachment B--Conducted RF Output Power

Mode	Channel	Frequency (MHz)	Conducted Power (dBm)	Conducted Power (W)
GSM 850	128	824.2	32.82	1.914
	190	836.6	32.69	1.858
	251	848.8	32.88	1.941
GPRS 850 (1 Slot)	128	824.2	33.28	2.128
	190	836.6	33.17	2.075
	251	848.8	33.35	2.163
GPRS 850 (2 Slot)	128	824.2	31.93	1.560
	190	836.6	32.12	1.629
	251	848.8	32.29	1.694
GPRS 850 (3 Slot)	128	824.2	27.68	0.586
	190	836.6	27.93	0.621
	251	848.8	28.05	0.638
GPRS 850 (4 Slot)	128	824.2	25.44	0.350
	190	836.6	25.67	0.369
	251	848.8	25.60	0.363
EDGE 850 (1 Slot)	128	824.2	26.11	0.408
	190	836.6	25.98	0.396
	251	848.8	26.16	0.413
EDGE 850 (2 Slot)	128	824.2	24.67	0.293
	190	836.6	24.79	0.301
	251	848.8	24.76	0.299
EDGE 850 (3 Slot)	128	824.2	23.44	0.221
	190	836.6	23.37	0.217
	251	848.8	23.40	0.219
EDGE 850 (4 Slot)	128	824.2	22.55	0.180
	190	836.6	22.48	0.177
	251	848.8	22.68	0.185

Mode	Channel	Frequency (MHz)	Conducted Power (dBm)	Conducted Power (W)
GSM 1900	512	1850.2	30.16	1.038
	661	1880	29.95	0.989
	810	1909.8	29.97	0.993
GPRS 1900 (1 Slot)	512	1850.2	29.49	0.889
	661	1880	29.33	0.857
	810	1909.8	29.31	0.853
GPRS 1900 (2 Slot)	512	1850.2	28.06	0.640
	661	1880	28.43	0.697
	810	1909.8	28.28	0.673
GPRS 1900 (3 Slot)	512	1850.2	26.90	0.490
	661	1880	26.69	0.467
	810	1909.8	26.44	0.441
GPRS 1900 (4 Slot)	512	1850.2	24.61	0.289
	661	1880	24.30	0.269
	810	1909.8	24.13	0.259
EDGE 1900 (1 Slot)	512	1850.2	25.02	0.318
	661	1880	24.56	0.286
	810	1909.8	24.20	0.263
EDGE 1900 (2 Slot)	512	1850.2	23.78	0.239
	661	1880	23.22	0.210
	810	1909.8	23.09	0.204
EDGE 1900 (3 Slot)	512	1850.2	21.40	0.138
	661	1880	20.89	0.123
	810	1909.8	20.61	0.115
EDGE 1900 (4 Slot)	512	1850.2	20.29	0.107
	661	1880	19.64	0.092
	810	1909.8	19.27	0.085

Mode	Channel	Frequency (MHz)	Conducted Power (dBm)	Conducted Power (W)
Band II RMC	9262	1852.4	23.40	0.219
	9400	1880	23.47	0.222
	9538	1907.6	23.48	0.223
HSDPA Subtest 1	9262	1852.4	22.75	0.188
	9400	1880	22.49	0.177
	9538	1907.6	22.61	0.182
HSDPA Subtest 2	9262	1852.4	22.25	0.168
	9400	1880	20.55	0.114
	9538	1907.6	20.45	0.111
HSDPA Subtest 3	9262	1852.4	22.21	0.166
	9400	1880	20.15	0.104
	9538	1907.6	22.04	0.160
HSDPA Subtest 4	9262	1852.4	22.13	0.163
	9400	1880	22.09	0.162
	9538	1907.6	22.04	0.160
HSUPA Subtest 1	9262	1852.4	22.06	0.161
	9400	1880	22.15	0.164
	9538	1907.6	22.07	0.161
HSUPA Subtest 2	9262	1852.4	21.98	0.158
	9400	1880	21.78	0.151
	9538	1907.6	21.64	0.146
HSUPA Subtest 3	9262	1852.4	21.54	0.143
	9400	1880	21.46	0.140
	9538	1907.6	21.38	0.137
HSUPA Subtest 4	9262	1852.4	21.68	0.147
	9400	1880	21.48	0.141
	9538	1907.6	21.67	0.147
HSUPA Subtest 5	9262	1852.4	22.28	0.169
	9400	1880	22.54	0.179
	9538	1907.6	22.47	0.177

Mode	Channel	Frequency (MHz)	Conducted Power (dBm)	Conducted Power (W)
Band IV RMC	1312	1712.4	23.55	0.226
	1413	1732.6	23.77	0.238
	1513	1752.6	23.54	0.226
HSDPA Subtest 1	1312	1712.4	22.46	0.176
	1413	1732.6	22.67	0.185
	1513	1752.6	22.57	0.181
HSDPA Subtest 2	1312	1712.4	20.51	0.112
	1413	1732.6	22.32	0.171
	1513	1752.6	22.15	0.164
HSDPA Subtest 3	1312	1712.4	20.08	0.102
	1413	1732.6	22.29	0.169
	1513	1752.6	22.08	0.161
HSDPA Subtest 4	1312	1712.4	20.11	0.103
	1413	1732.6	22.21	0.166
	1513	1752.6	22.20	0.166
HSUPA Subtest 1	1312	1712.4	22.14	0.164
	1413	1732.6	22.16	0.164
	1513	1752.6	22.64	0.184
HSUPA Subtest 2	1312	1712.4	22.06	0.161
	1413	1732.6	22.07	0.161
	1513	1752.6	22.19	0.166
HSUPA Subtest 3	1312	1712.4	21.68	0.147
	1413	1732.6	21.79	0.151
	1513	1752.6	21.86	0.153
HSUPA Subtest 4	1312	1712.4	21.35	0.136
	1413	1732.6	21.46	0.140
	1513	1752.6	21.48	0.141
HSUPA Subtest 5	1312	1712.4	22.45	0.176
	1413	1732.6	22.35	0.172
	1513	1752.6	22.15	0.164

Mode	Channel	Frequency (MHz)	Conducted Power (dBm)	Conducted Power (W)
Band V RMC	4132	826.4	23.17	0.207
	4175	836.6	23.33	0.215
	4233	846.6	23.26	0.212
HSDPA Subtest 1	4132	826.4	22.20	0.166
	4175	836.6	22.27	0.169
	4233	846.6	22.12	0.163
HSDPA Subtest 2	4132	826.4	20.33	0.108
	4175	836.6	20.41	0.110
	4233	846.6	20.23	0.105
HSDPA Subtest 3	4132	826.4	21.67	0.147
	4175	836.6	21.90	0.155
	4233	846.6	19.82	0.096
HSDPA Subtest 4	4132	826.4	19.80	0.095
	4175	836.6	19.90	0.098
	4233	846.6	19.78	0.095
HSUPA Subtest 1	4132	826.4	22.15	0.164
	4175	836.6	22.31	0.170
	4233	846.6	21.26	0.134
HSUPA Subtest 2	4132	826.4	22.65	0.184
	4175	836.6	22.34	0.171
	4233	846.6	22.15	0.164
HSUPA Subtest 3	4132	826.4	21.45	0.140
	4175	836.6	21.68	0.147
	4233	846.6	21.67	0.147
HSUPA Subtest 4	4132	826.4	21.56	0.143
	4175	836.6	21.49	0.141
	4233	846.6	21.67	0.147
HSUPA Subtest 5	4132	826.4	22.15	0.164
	4175	836.6	22.64	0.184
	4233	846.6	22.15	0.164

Attachment C--Peak-Average Ratio

Mode	Channel	Frequency (MHz)	Peak Power (dBm)	AVG Power (dBm)	PAPR (dB)	Limit (dB)	Result
GSM 850	128	824.2	33.52	32.82	0.70	13	PASS
	190	836.6	33.42	32.69	0.73	13	PASS
	251	848.8	33.62	32.88	0.74	13	PASS
GPRS 850	128	824.2	33.60	33.28	0.32	13	PASS
	190	836.6	33.49	33.17	0.32	13	PASS
	251	848.8	33.67	33.35	0.32	13	PASS
EGPRS 850	128	824.2	29.38	26.11	3.27	13	PASS
	190	836.6	29.28	25.98	3.30	13	PASS
	251	848.8	29.36	26.16	3.20	13	PASS
PCS 1900	512	1850.2	30.82	30.16	0.66	13	PASS
	661	1880.0	30.70	29.95	0.75	13	PASS
	810	1909.8	30.69	29.97	0.72	13	PASS
GPRS 1900	512	1850.2	29.94	29.49	0.45	13	PASS
	661	1880.0	29.80	29.33	0.47	13	PASS
	810	1909.8	29.80	29.31	0.49	13	PASS
EGPRS 1900	512	1850.2	28.25	25.02	3.23	13	PASS
	661	1880.0	27.88	24.56	3.32	13	PASS
	810	1909.8	27.68	24.20	3.48	13	PASS

Test Result(WCDMA)

Band	Channel	Peak-to-Average Ratio(dB)	Limit(dB)	Verdict
Band2	9262	3.33	13	PASS
Band2	9400	3.13	13	PASS
Band2	9538	3.01	13	PASS

Test Result(HSDPA)

Band	Channel	Peak-to-Average Ratio(dB)	Limit(dB)	Verdict
Band2	9262	3.54	13	PASS
Band2	9400	3.39	13	PASS
Band2	9538	3.33	13	PASS

Test Result(HSUPA)

Band	Channel	Peak-to-Average Ratio(dB)	Limit(dB)	Verdict
Band2	9262	4.64	13	PASS
Band2	9400	4.38	13	PASS
Band2	9538	4.64	13	PASS

Test Graphs(WCDMA)

Band2-9262

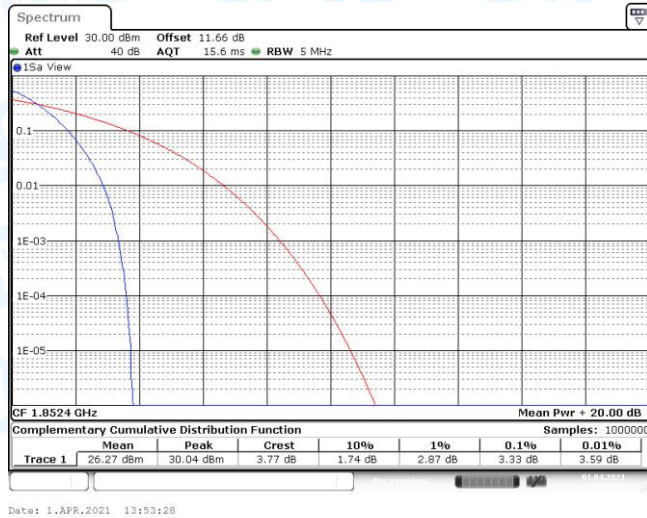

Band2-9400

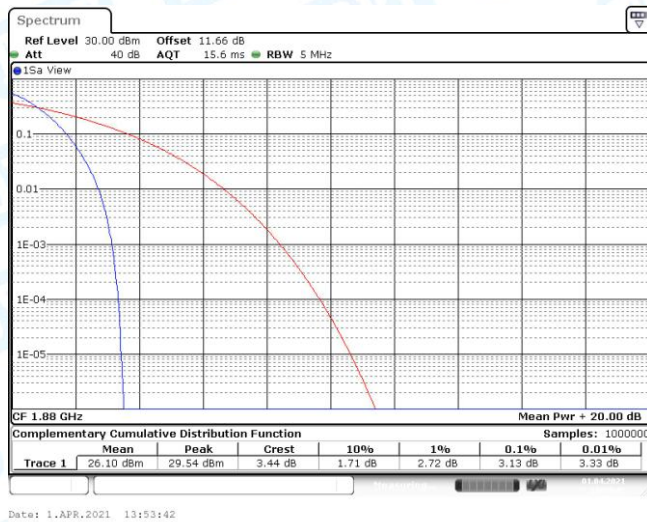

Band2-9538

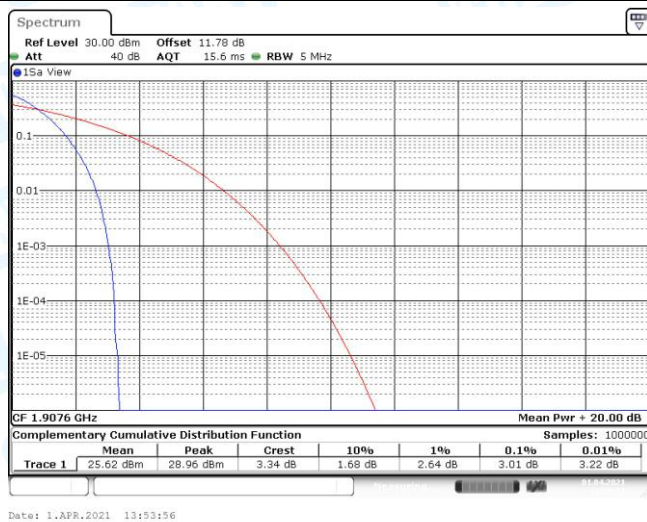

Test Graphs(HSDPA)

Band2-9262

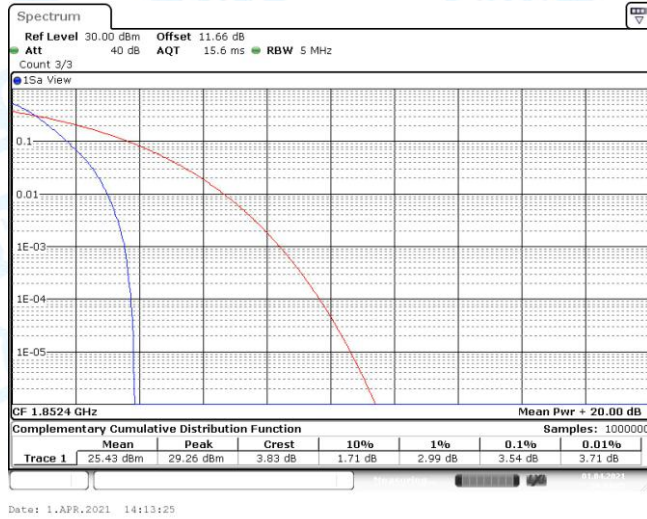

Band2-9400

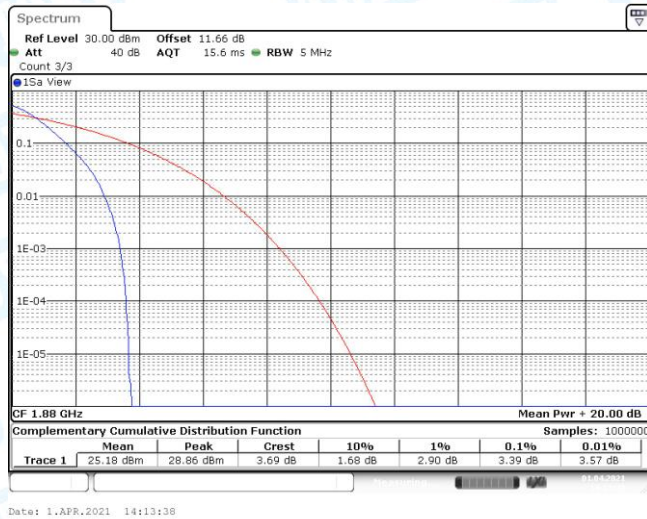

Band2-9538

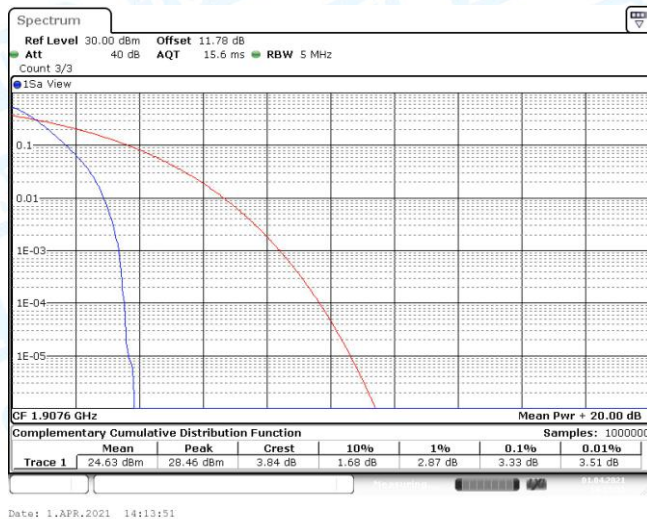

Test Graphs(HSUPA)

Band2-9262

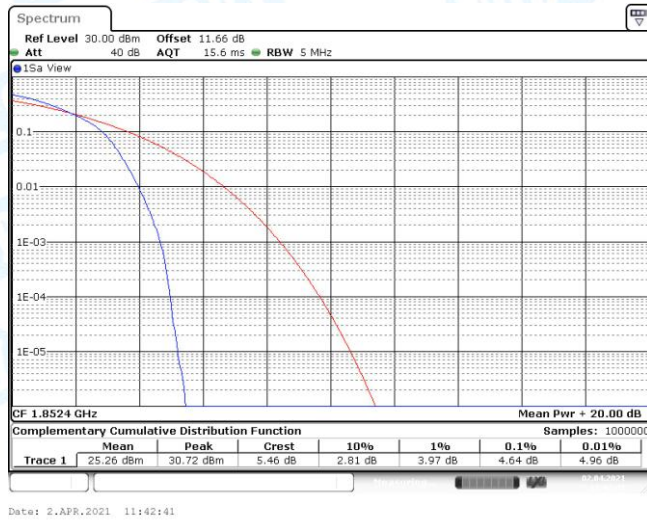

Band2-9400

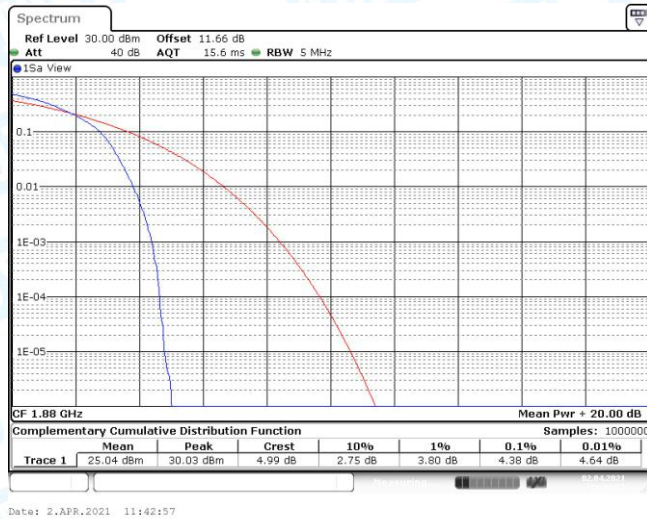

Band2-9538

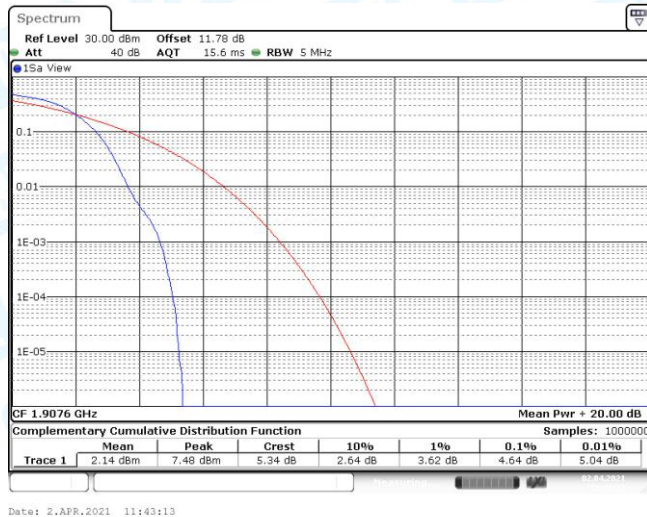

Test Result(WCDMA)

Band	Channel	Peak-to-Average Ratio(dB)	Limit(dB)	Verdict
Band4	1312	3.13	13	PASS
Band4	1413	3.3	13	PASS
Band4	1513	3.19	13	PASS

Test Result(HSDPA)

Band	Channel	Peak-to-Average Ratio(dB)	Limit(dB)	Verdict
Band4	1312	3.45	13	PASS
Band4	1413	3.54	13	PASS
Band4	1513	3.45	13	PASS

Test Result(HSUPA)

Band	Channel	Peak-to-Average Ratio(dB)	Limit(dB)	Verdict
Band4	1312	4.43	13	PASS
Band4	1413	4.64	13	PASS
Band4	1513	4.67	13	PASS