

TEST REPORT



Test report no.: 1-5414/17-01-02

BNetzA-CAB-02/21-102

Testing laboratory

CTC advanced GmbH

Untertuerkheimer Strasse 6 – 10

66117 Saarbruecken / Germany

Phone: + 49 681 5 98 - 0

Fax: + 49 681 5 98 - 9075

Internet: <http://www.ctcadvanced.com>

e-mail: mail@ctcadvanced.com

Accredited Testing Laboratory:

The testing laboratory (area of testing) is accredited according to DIN EN ISO/IEC 17025 (2005) by the Deutsche Akkreditierungsstelle GmbH (DAkkS)

The accreditation is valid for the scope of testing procedures as stated in the accreditation certificate with the registration number: D-PL-12076-01-03

Applicant

CCV Deutschland GmbH

Gewerbering 1

84072 Au in der Hallertau / GERMANY

Phone: +49 8752 8 64-0

Fax: +49 (8752) 864 100

Contact: Markus Fischer

e-mail: m.fischer@de.ccv.eu

Phone: +49 (8752) 864 514

Manufacturer

CCV Deutschland GmbH

Gewerbering 1

84072 Au in der Hallertau / GERMANY

Test standard/s

47 CFR Part 15

Title 47 of the Code of Federal Regulations; Chapter I; Part 15 - Radio frequency devices

For further applied test standards please refer to section 3 of this test report.

Test Item

Kind of test item: POS Terminal

Model name: OPP-C60, OPM-C60, SCR-C60, COR

FCC ID: 2APBE-720001

Frequency: 13.56 MHz

Technology tested: RFID

Antenna: Integrated PCB antenna

Power supply: 9 V to 25 V DC by power supply

Temperature range: -20°C to +70°C



This test report is electronically signed and valid without handwritten signature. For verification of the electronic signatures, the public keys can be requested at the testing laboratory.

Test report authorized:

Christoph Schneider
Lab Manager
Radio Communications & EMC

Test performed:

p.o.
Tobias Wittenmeier
Testing Manager
Radio Communications & EMC

1 Table of contents

1	Table of contents	2
2	General information	3
2.1	Notes and disclaimer	3
2.2	Application details.....	3
2.3	Test laboratories sub-contracted	3
3	Test standard/s and references	4
4	Test environment.....	5
5	Test item.....	5
5.1	General description.....	5
5.2	Additional information	5
6	Description of the test setup.....	6
6.1	Shielded semi anechoic chamber.....	7
6.2	Shielded fully anechoic chamber	8
6.3	Frequency error	9
6.4	AC conducted	10
7	Sequence of testing	11
7.1	Sequence of testing radiated spurious 9 kHz to 30 MHz.....	11
7.2	Sequence of testing radiated spurious 30 MHz to 1 GHz.....	12
8	Measurement uncertainty	13
9	Summary of measurement results	14
10	Additional comments	14
11	Measurement results	15
11.1	Occupied bandwidth.....	15
11.2	Field strength of the fundamental	17
11.3	Field strength of the harmonics and spurious	18
11.4	Conducted limits	21
11.5	Frequency error	24
12	Observations	30
Annex A	Glossary.....	31
Annex B	Document history	32
Annex C	Accreditation Certificate	32

2 General information

2.1 Notes and disclaimer

The test results of this test report relate exclusively to the test item specified in this test report. CTC advanced GmbH does not assume responsibility for any conclusions and generalizations drawn from the test results with regard to other specimens or samples of the type of the equipment represented by the test item.

The test report may only be reproduced or published in full. Reproduction or publication of extracts from the report requires the prior written approval of CTC advanced GmbH.

The testing service provided by CTC advanced GmbH has been rendered under the current "General Terms and Conditions for CTC advanced GmbH".

CTC advanced GmbH will not be liable for any loss or damage resulting from false, inaccurate, inappropriate or incomplete product information provided by the customer.

Under no circumstances does the CTC advanced GmbH test report include any endorsement or warranty regarding the functionality, quality or performance of any other product or service provided.

Under no circumstances does the CTC advanced GmbH test report include or imply any product or service warranties from CTC advanced GmbH, including, without limitation, any implied warranties of merchantability, fitness for purpose, or non-infringement, all of which are expressly disclaimed by CTC advanced GmbH.

All rights and remedies regarding vendor's products and services for which CTC advanced GmbH has prepared this test report shall be provided by the party offering such products or services and not by CTC advanced GmbH. In no case this test report can be considered as a Letter of Approval.

This test report is electronically signed and valid without handwritten signature. For verification of the electronic signatures, the public keys can be requested at the testing laboratory.

2.2 Application details

Date of receipt of order:	2018-03-05
Date of receipt of test item:	2018-03-06
Start of test:	2018-03-08
End of test:	2018-03-09
Person(s) present during the test:	-/-

2.3 Test laboratories sub-contracted

None

3 Test standard/s and references

Test standard	Date	Description
47 CFR Part 15	-/-	Title 47 of the Code of Federal Regulations; Chapter I; Part 15 - Radio frequency devices

Guidance	Version	Description
ANSI C63.4-2014	-/-	American national standard for methods of measurement of radio-noise emissions from low-voltage electrical and electronic equipment in the range of 9 kHz to 40 GHz
ANSI C63.10-2013	-/-	American national standard of procedures for compliance testing of unlicensed wireless devices

6 Description of the test setup

Typically, the calibrations of the test apparatus are commissioned to and performed by an accredited calibration laboratory. The calibration intervals are determined in accordance with the DIN EN ISO/IEC 17025. In addition to the external calibrations, the laboratory executes comparison measurements with other calibrated test systems or effective verifications. Weekly chamber inspections and range calibrations are performed. Where possible, RF generating and signaling equipment as well as measuring receivers and analyzers are connected to an external high-precision 10 MHz reference (GPS-based or rubidium frequency standard).

In order to simplify the identification of the equipment used at some special tests, some items of test equipment and ancillaries can be provided with an identifier or number in the equipment list below (Lab/Item).

Agenda: Kind of Calibration

k	calibration / calibrated	EK	limited calibration
ne	not required (k, ev, izw, zw not required)	zw	cyclical maintenance (external cyclical maintenance)
ev	periodic self verification	izw	internal cyclical maintenance
Ve	long-term stability recognized	g	blocked for accredited testing
v/k!	Attention: extended calibration interval		
NK!	Attention: not calibrated	*)	next calibration ordered / currently in progress

6.1 Shielded semi anechoic chamber

The radiated measurements are performed in vertical and horizontal plane in the frequency range from 30 MHz to 1 GHz in semi-anechoic chambers. The EUT is positioned on a non-conductive support with a height of 0.80 m above a conductive ground plane that covers the whole chamber. The receiving antennas are conform to specifications ANSI C63. These antennas can be moved over the height range between 1.0 m and 4.0 m in order to search for maximum field strength emitted from EUT. The measurement distances between EUT and receiving antennas are indicated in the test setups for the various frequency ranges. For each measurement, the EUT is rotated in all three axes until the maximum field strength is received. The wanted and unwanted emissions are received by spectrum analyzers where the detector modes and resolution bandwidths over various frequency ranges are set according to requirement ANSI C63.



Measurement distance: tri-log antenna 10 meter

$$FS = UR + CL + AF$$

(FS-field strength; UR-voltage at the receiver; CL-loss of the cable; AF-antenna factor)

Example calculation:

$$FS [dB\mu V/m] = 12.35 [dB\mu V/m] + 1.90 [dB] + 16.80 [dB/m] = 31.05 [dB\mu V/m] (35.69 \mu V/m)$$

Equipment table:

No.	Lab / Item	Equipment	Type	Manufacturer	Serial No.	INV. No.	Kind of Calibration	Last Calibration	Next Calibration
1	A	Switch-Unit	3488A	HP	2719A14505	300000368	ev	-/-	-/-
2	A	Meßkabine 1	HF-Absorberhalle	MWB AG 300023		300000551	ne	-/-	-/-
3	A	Antenna Tower	Model 2175	ETS-Lindgren	64762	300003745	izw	-/-	-/-
4	A	Positioning Controller	Model 2090	ETS-Lindgren	64672	300003746	izw	-/-	-/-
5	A	Turntable Interface-Box	Model 105637	ETS-Lindgren	44583	300003747	izw	-/-	-/-
6	A	TRILOG Broadband Test-Antenna 30 MHz - 3 GHz	VULB9163	Schwarzbeck	295	300003787	k	25.04.2016	25.04.2018
7	A	Spectrum-Analyzer	FSU26	R&S	200809	300003874	k	20.12.2017	19.12.2018

6.2 Shielded fully anechoic chamber

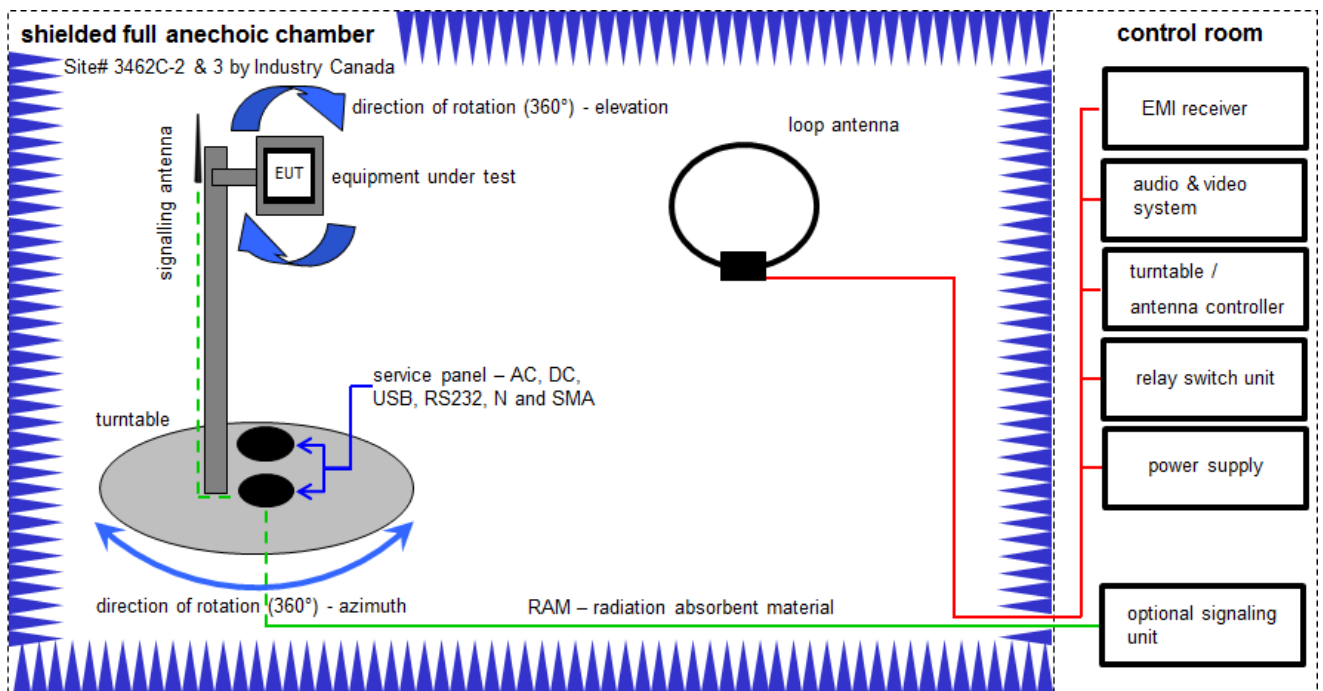

Measurement distance: loop antenna 3 meter.

$$FS = UR + CA + AF$$

(FS-field strength; UR-voltage at the receiver; CA-loss of the signal path; AF-antenna factor)

Example calculation:

$$FS [dB\mu V/m] = 40.0 [dB\mu V/m] + (-35.8) [dB] + 32.9 [dB/m] = 37.1 [dB\mu V/m] (71.61 \mu V/m)$$

Equipment table:

No.	Lab / Item	Equipment	Type	Manufacturer	Serial No.	INV. No.	Kind of Calibration	Last Calibration	Next Calibration
1	A	Active Loop Antenna 9 kHz to 30 MHz	6502	EMCO	2210	300001015	k	07.07.2017	06.07.2019
2	A	Anechoic chamber	FAC 3/5m	MWB / TDK	87400/02	300000996	ev	-/-	-/-
3	A	Switch / Control Unit	3488A	HP	*	300000199	ne	-/-	-/-
4	A	EMI Test Receiver 20Hz- 26,5GHz	ESU26	R&S	100037	300003555	k	20.12.2017	19.12.2018
5	A	4U RF Switch Platform	L4491A	Agilent Technologies	MY50000037	300004509	ne	-/-	-/-
6	A	NEXIO EMV-Software	BAT EMC V3.16.0.49	EMCO		300004682	ne	-/-	-/-
7	A	PC	ExOne	F+W		300004703	ne	-/-	-/-

6.3 Frequency error

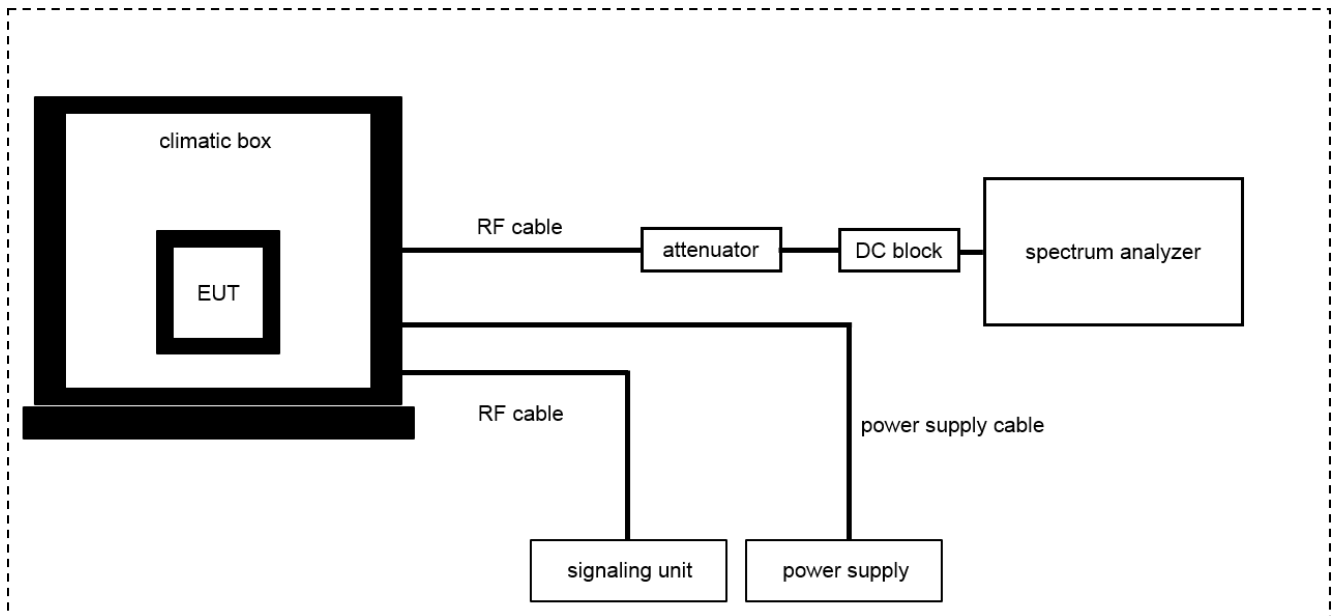

OP = AV + CA
(OP-output power; AV-analyzer value; CA-loss signal path)

Example calculation:
OP [dBm] = 6.0 [dBm] + 11.7 [dB] = 17.7 [dBm] (58.88 mW)

Equipment table:

No.	Lab / Item	Equipment	Type	Manufacturer	Serial No.	INV. No.	Kind of Calibration	Last Calibration	Next Calibration
1	A	DC Power Supply, 60V, 10A	6038A	HP	3122A11097	300001204	vKII	12.12.2017	11.12.2020
2	A	Signal- and Spectrum Analyzer	FSW26	R&S	101455	300004528	k	20.12.2017	19.12.2018
3	A	Loop Antenna		ZEG TS Steinfurt		400001208	ev	-/-	-/-
4	A	RF Cable BNC	RG58	Huber & Suhner		400001209	ev	-/-	-/-
5	A	Climatic Box	VT 4011	Voetsch Industrietechnik	58566230600010	300005363	ev	01.06.2017	31.05.2019

6.4 AC conducted

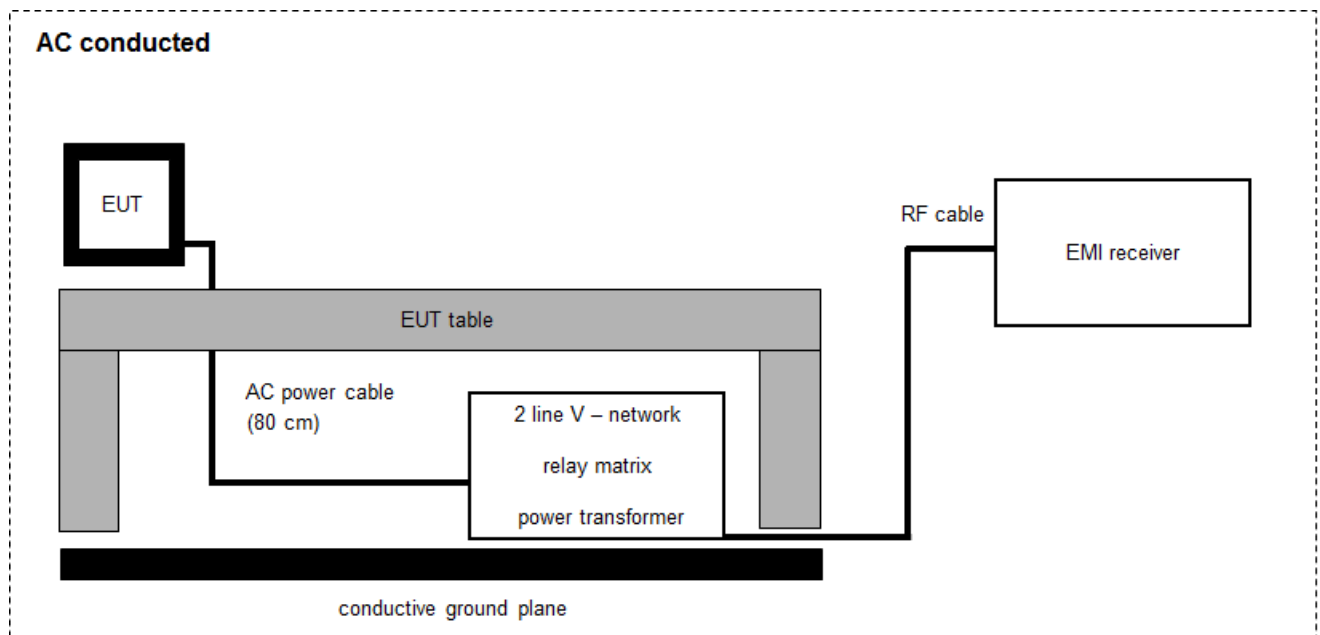

$$FS = UR + CF + VC$$

(FS-field strength; UR-voltage at the receiver; CR-loss of the cable and filter; VC-correction factor of the ISN)

Example calculation:

$$FS [dB\mu V/m] = 37.62 [dB\mu V/m] + 9.90 [dB] + 0.23 [dB] = 47.75 [dB\mu V/m] (244.06 \mu V/m)$$

Equipment table:

No.	Lab / Item	Equipment	Type	Manufacturer	Serial No.	INV. No.	Kind of Calibration	Last Calibration	Next Calibration
1	A	Two-line V-Network (LISN) 9 kHz to 30 MHz	ESH3-Z5	R&S	893045/004	300000584	k	13.12.2017	12.12.2018
2	A	RF-Filter-section	85420E	HP	3427A00162	300002214	k	27.11.2006	-/-
3	A	EM-Injection Clamp	FCC-203i	emv	232	300000626	ev	18.05.2001	-/-
4	A	Magnetfeldantenne	MS 100	EM-Test	-----	300002659	ev	24.04.2000	-/-
5	A	AC-Spannungsquelle variabel	MV2616-V	EM-Test	0397-12	300003259	vIKI!	18.12.2017	17.12.2019
6	A	Analyzer-Reference-System (Harmonics and Flicker)	ARS 16/1	SPS	A3509 07/0 0205	300003314	vIKI!	15.01.2018	14.01.2020
7	A	Hochpass 150 kHz	EZ-25	R&S	100010	300003798	ev	08.04.2008	-/-
8	A	Power Supply	NGSM 32/10	R&S	3939	400000192	vIKI!	31.01.2017	30.01.2020
9	A	MXE EMI Receiver 20 Hz to 26,5 GHz	N9038A	Agilent Technologies	MY51210197	300004405	k	18.12.2017	17.12.2018

7 Sequence of testing

7.1 Sequence of testing radiated spurious 9 kHz to 30 MHz

Setup

- The equipment is set up to simulate normal operation mode as described in the user manual or defined by the manufacturer.
- If the EUT is a tabletop system, it is placed on a table with 0.8 m height.
- If the EUT is a floor standing device, it is placed directly on the turn table.
- Auxiliary equipment and cables are positioned to simulate normal operation conditions as described in ANSI C 63.4.
- The AC power port of the EUT (if available) is connected to a power outlet below the turntable.
- Measurement distance is 3 m (see ANSI C 63.4) – see test details.
- EUT is set into operation.

Premeasurement*

- The turntable rotates from 0° to 315° using 45° steps.
- The antenna height is 1 m.
- At each turntable position the analyzer sweeps with positive-peak detector to find the maximum of all emissions.

Final measurement

- Identified emissions during the pre-measurement are maximized by the software by rotating the turntable from 0° to 360°.
- Loop antenna is rotated about its vertical axis for maximum response at each azimuth about the EUT. (For certain applications, the loop antenna plane may also need to be positioned horizontally at the specified distance from the EUT)
- The final measurement is done in the position (turntable and elevation) causing the highest emissions with quasi-peak (as described in ANSI C 63.4).
- Final levels, frequency, measuring time, bandwidth, turntable position, correction factor, margin to the limit and limit will be recorded. A plot with the graph of the premeasurement and the limit is stored.

*)Note: The sequence will be repeated three times with different EUT orientations.

7.2 Sequence of testing radiated spurious 30 MHz to 1 GHz

Setup

- The equipment is set up to simulate normal operation mode as described in the user manual or defined by the manufacturer.
- If the EUT is a tabletop system, a table with 0.8 m height is used, which is placed on the ground plane.
- If the EUT is a floor standing device, it is placed on the ground plane with insulation between both.
- Auxiliary equipment and cables are positioned to simulate normal operation conditions as described in ANSI C 63.4.
- The AC power port of the EUT (if available) is connected to a power outlet below the turntable.
- Measurement distance is 10 m or 3 m (see ANSI C 63.4) – see test details.
- EUT is set into operation.

Premeasurement

- The turntable rotates from 0° to 315° using 45° steps.
- The antenna is polarized vertical and horizontal.
- The antenna height changes from 1 m to 3 m.
- At each turntable position, antenna polarization and height the analyzer sweeps three times in peak to find the maximum of all emissions.

Final measurement

- The final measurement is performed for at least six highest peaks according to the requirements of the ANSI C63.4.
- Based on antenna and turntable positions at which the peak values are measured the software maximize the peaks by changing turntable position $\pm 45^\circ$ and antenna height between 1 and 4 m.
- The final measurement is done with quasi-peak detector (as described in ANSI C 63.4).
- Final levels, frequency, measuring time, bandwidth, antenna height, antenna polarization, turntable angle, correction factor, margin to the limit and limit are recorded. A plot with the graph of the premeasurement with marked maximum final results and the limit is stored.

8 Measurement uncertainty

Measurement uncertainty	
Test case	Uncertainty
Occupied bandwidth	± used RBW
Field strength of the fundamental	± 3 dB
Field strength of the harmonics and spurious	± 3 dB
Receiver spurious emissions and cabinet radiations	± 3 dB
Conducted limits	± 2.6 dB

9 Summary of measurement results

<input checked="" type="checkbox"/>	No deviations from the technical specifications were ascertained
<input type="checkbox"/>	There were deviations from the technical specifications ascertained
<input type="checkbox"/>	This test report is only a partial test report. The content and verdict of the performed test cases are listed below.

TC Identifier	Description	Verdict	Date	Remark
RF-Testing	CFR Part 15	See table!	2018-06-18	-/-

Test specification clause	Test case	Temperature conditions	Power source conditions	C	NC	NA	NP	Remark
-/-	Occupied bandwidth	Nominal	Nominal	<input checked="" type="checkbox"/>	<input type="checkbox"/>	<input type="checkbox"/>	<input type="checkbox"/>	-/-
§ 15.225 (a)	Field strength of the fundamental	Nominal	Nominal	<input checked="" type="checkbox"/>	<input type="checkbox"/>	<input type="checkbox"/>	<input type="checkbox"/>	-/-
§ 15.209 & § 15.225 (b-d)	Field strength of the harmonics and spurious	Nominal	Nominal	<input checked="" type="checkbox"/>	<input type="checkbox"/>	<input type="checkbox"/>	<input type="checkbox"/>	-/-
§ 15.109	Receiver spurious emissions and cabinet radiations	Nominal	Nominal	<input type="checkbox"/>	<input type="checkbox"/>	<input checked="" type="checkbox"/>	<input type="checkbox"/>	-/-
§15.107 & §15.207	Conducted limits	Nominal	Nominal	<input checked="" type="checkbox"/>	<input type="checkbox"/>	<input type="checkbox"/>	<input type="checkbox"/>	-/-
§ 15.225 (a)	Frequency tolerance	Normal & extreme conditions	Normal & extreme conditions	<input checked="" type="checkbox"/>	<input type="checkbox"/>	<input type="checkbox"/>	<input type="checkbox"/>	-/-

Note:

- C Compliant
- NC Not compliant
- NA Not applicable
- NP Not performed

10 Additional comments

Reference documents: None

Special test descriptions: None

Configuration descriptions: None

11 Measurement results

11.1 Occupied bandwidth

Measurement:

The emission bandwidth (x dB) is defined as the frequency range between two points, one above and one below the carrier frequency, at which the spectral density of the emission is attenuated x dB below the maximum in-band spectral density of the modulated signal.

Measurement parameters	
Detector:	Peak
Resolution bandwidth:	1 % – 5 % of the occupied bandwidth
Video bandwidth:	≥ 3x RBW
Trace mode:	Max hold
Analyser function:	99 % power function
Used equipment:	See chapter 6.3 A
Measurement uncertainty:	See chapter 8

Limit:

FCC
-/-

Result:

99% emission bandwidth
733.56 kHz

Plot:

Plot 1: 99 % emission bandwidth

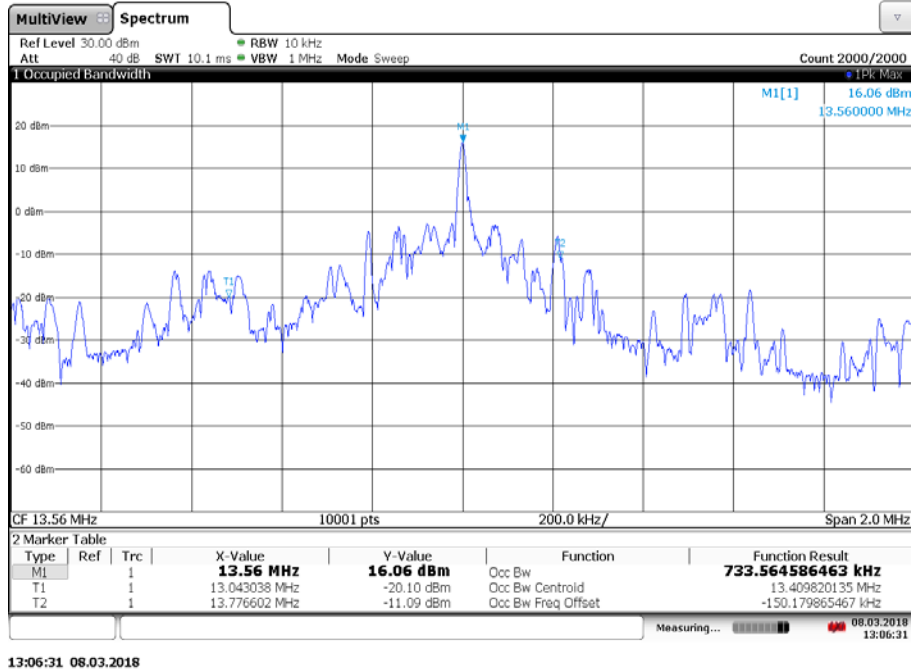

11.2 Field strength of the fundamental

Measurement:

The maximum detected field strength for the carrier signal.

Measurement parameters	
Detector:	Quasi peak / peak (worst case)
Resolution bandwidth:	120 kHz
Video bandwidth:	≥ 3x RBW
Trace mode:	Max hold
Used equipment:	See chapter 6.2 A
Measurement uncertainty:	See chapter 8

Limit:

FCC		
Frequency (MHz)	Field strength (µV/m)	Measurement distance (m)
13.553 to 13.567	15,848 (84 dBµV/m)	30

Recalculation:

According to ANSI C63.10		
Frequency	Formula	Correction value
13.56 MHz	$FS_{\text{limit}} = FS_{\text{max}} - 40 \log\left(\frac{d_{\text{nearfield}}}{d_{\text{measure}}}\right) - 20 \log\left(\frac{d_{\text{limit}}}{d_{\text{nearfield}}}\right)$ <p> FS_{limit} is the calculation of field strength at the limit distance, expressed in dBµV/m FS_{max} is the measured field strength, expressed in dBµV/m $d_{\text{nearfield}}$ is the $\lambda/2\pi$ distance d_{measure} is the distance of the measurement point from EUT d_{limit} is the reference limit distance </p>	-21.4 from 3m to 30m

Result:

Field strength of the fundamental		
Frequency	13.56 MHz	
Distance	@ 3 m	@ 30 m
Measured / calculated value (QP)	57.06 dBµV/m	35.66 dBµV/m
Measured / calculated value (Peak)	59.14 dBµV/m	37.74 dBµV/m

11.3 Field strength of the harmonics and spurious

Measurement:

The maximum detected field strength for the harmonics and spurious.

Measurement parameters	
Detector:	Quasi peak / average or peak (worst case – pre-scan)
Resolution bandwidth:	F < 150 kHz: 200 Hz 150 kHz < F < 30 MHz: 9 kHz 30 MHz < F < 1 GHz: 120 kHz
Video bandwidth:	F < 150 kHz: 1 kHz 150 kHz < F < 30 MHz: 100 kHz 30 MHz < F < 1 GHz: 300 kHz
Trace mode:	Max hold
Used equipment:	See chapter 6.1 A / 6.2 A / 6.3 A
Measurement uncertainty:	See chapter 8

Limit:

FCC		
Frequency (MHz)	Field strength (dB μ V/m)	Measurement distance (m)
0.009 – 0.490	2400/F(kHz)	300
0.490 – 1.705	24000/F(kHz)	30
1.705 – 30	30 (29.5 dB μ V/m)	30
30 – 88	100 (40 dB μ V/m)	3
88 – 216	150 (43.5 dB μ V/m)	3
216 – 960	200 (46 dB μ V/m)	3

Note: For a reduced measurement distance, please take a look at the limit line and the ANSI C63.10-2013 sub clause 6.4 radiated emissions from unlicensed wireless devices below 30 MHz.

Result:

Detected emissions			
Frequency (MHz)	Detector	Resolution bandwidth (kHz)	Detected value (dB μ V/m @ 3m)
See table below Plots.			

Plots:

Plot 1: 9 kHz – 30 MHz, magnetic emissions

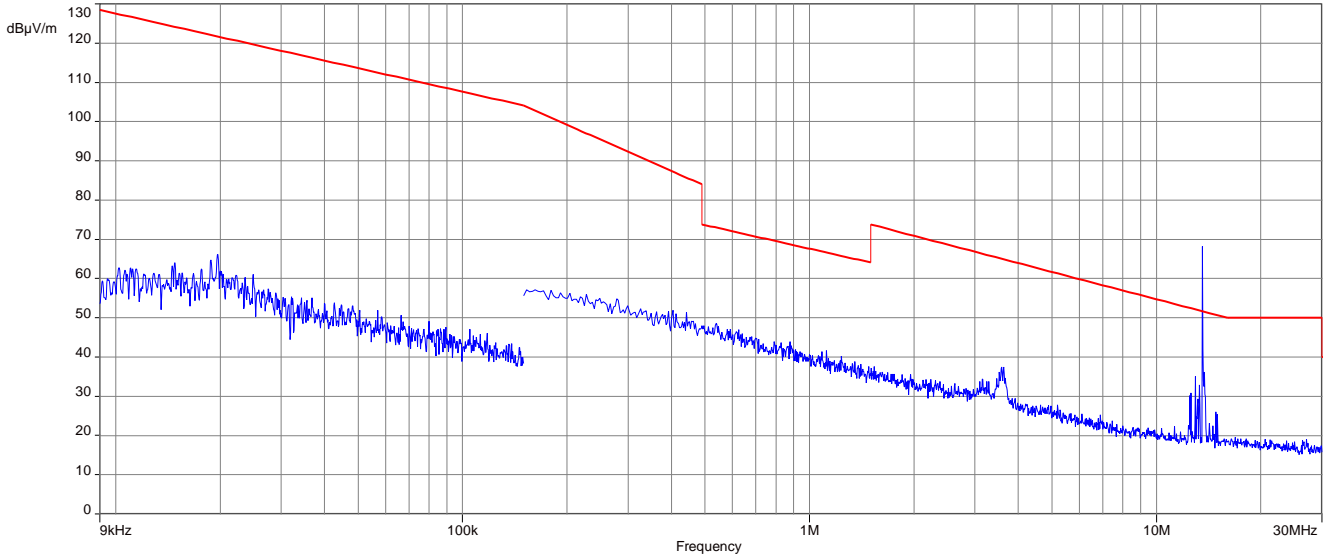

Plot 2: Spectrum mask (the limits are recalculated according to the ANSI C63.10-2013 sub clause 6.4)

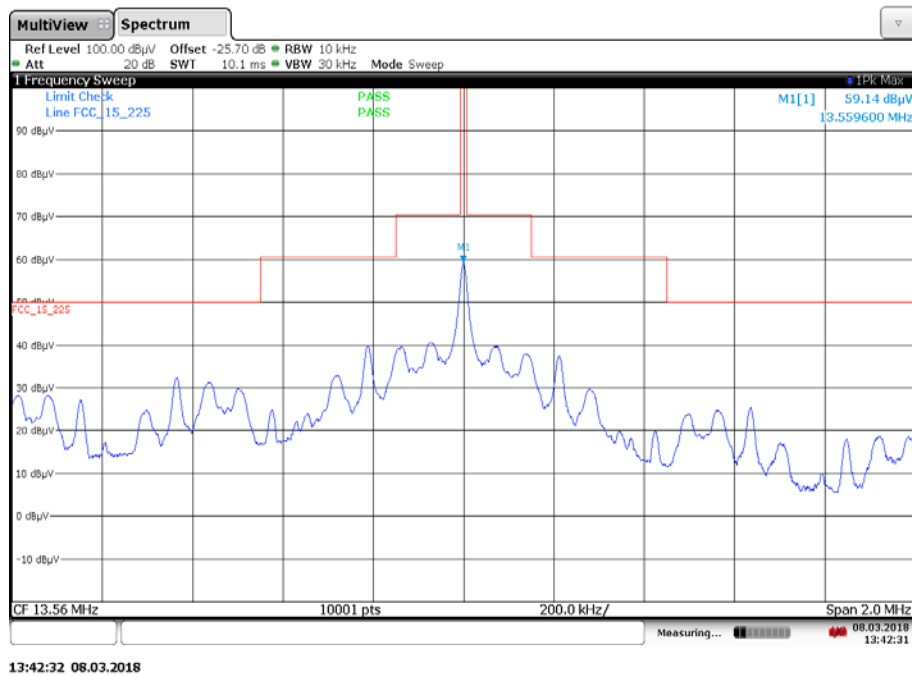

Plot 3: 30 MHz – 1 GHz, vertical and horizontal polarization

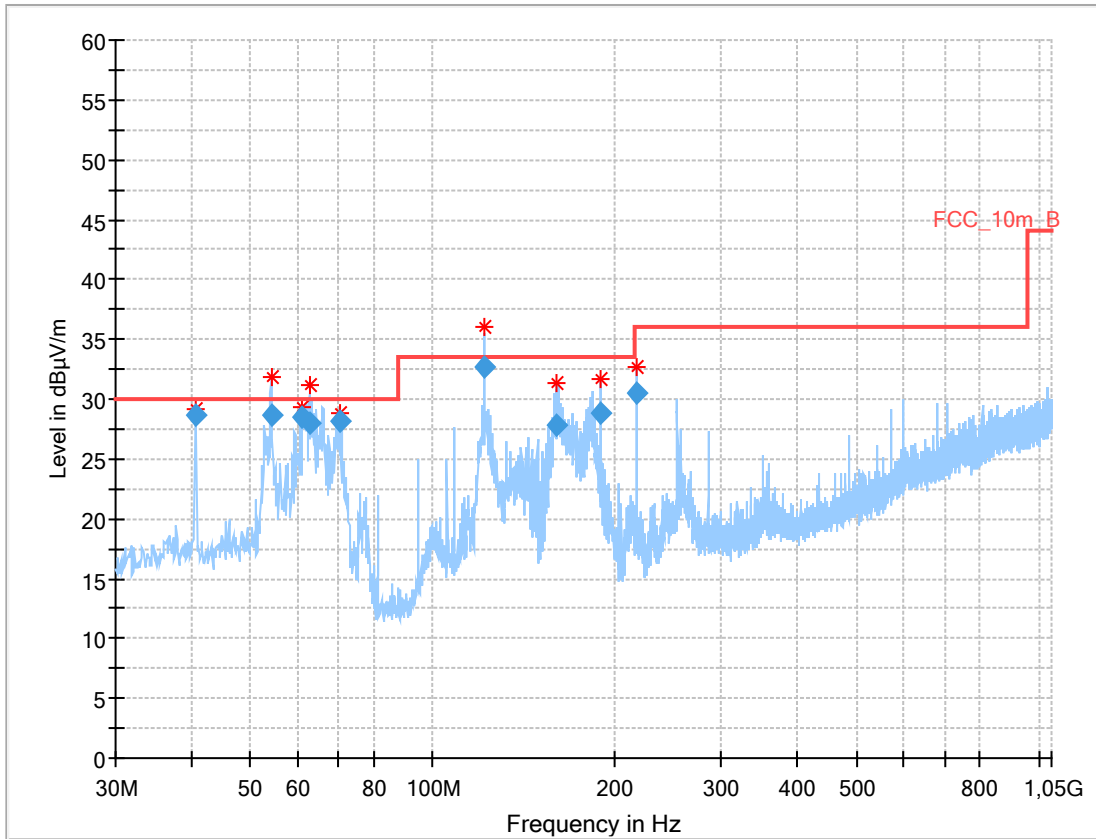

Final_Result

Frequency (MHz)	QuasiPeak (dBµV/m)	Limit (dBµV/m)	Margin (dB)	Meas. Time (ms)	Bandwidth (kHz)	Height (cm)	Pol	Azimuth (deg)	Corr. (dB)
40.664	28.60	30.0	1.40	1000	120	100.0	V	121.0	13.3
54.231	28.63	30.0	1.37	1000	120	103.0	V	8.0	13.2
60.994	28.42	30.0	1.58	1000	120	98.0	V	15.0	11.6
62.678	28.06	30.0	1.94	1000	120	98.0	V	-14.0	11.3
70.335	28.13	30.0	1.87	1000	120	98.0	V	121.0	9.7
122.052	32.68	33.5	0.32	1000	120	98.0	V	-6.0	10.1
160.337	27.76	33.5	5.74	1000	120	98.0	V	278.0	9.7
189.836	28.85	33.5	4.65	1000	120	98.0	V	-14.0	11.4
216.965	30.46	36.0	5.54	1000	120	98.0	V	-14.0	12.5

11.4 Conducted limits

Measurement:

Measurement of the conducted spurious emissions for an intentional radiator that is designed to be connected to the public utility (AC) power line.

Measurement parameters	
Detector:	Quasi peak / average or peak (worst case – pre-scan)
Resolution bandwidth:	F < 150 kHz: 200 Hz F > 150 kHz: 9 kHz
Video bandwidth:	F < 150 kHz: 1 kHz F > 150 kHz: 100 kHz
Trace mode:	Max hold
Used equipment:	See chapter 6.4 A
Measurement uncertainty:	See chapter 8

Limit:

FCC		
Frequency (MHz)	Quasi-peak (dBµV/m)	Average (dBµV/m)
0.15 – 0.5	66 to 56*	56 to 46*
0.5 – 5	56	46
5 – 30.0	60	50

Result: See table below the plots.

Plots:

Plot 1: 150 kHz to 30 MHz, phase line

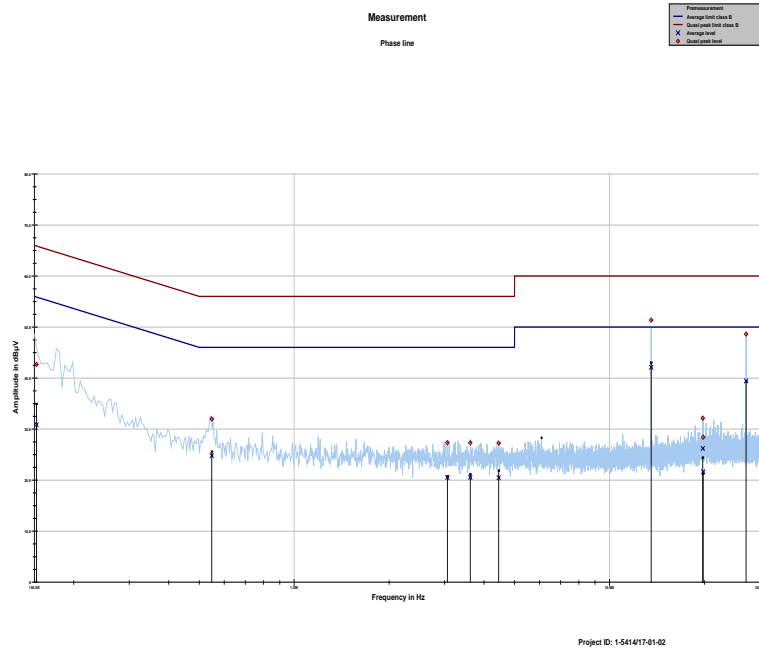

Final_Result

Frequency	Quasi peak level	Margin quasi peak	Limit QP	Average level	Margin average	Limit AV
MHz	dBµV	dB	dBµV	dBµV	dB	dBµV
0.152384	42.69	23.18	65.869	30.84	25.09	55.932
0.547798	31.97	24.03	56	24.79	21.21	46
3.062185	27.34	28.66	56	20.51	25.49	46
3.619664	27.31	28.69	56	20.53	25.47	46
4.453406	27.25	28.75	56	20.45	25.55	46
13.559441	51.36	8.64	60	42.1	7.9	50
19.758725	32.15	27.85	60	26.19	23.81	50
19.824996	28.41	31.59	60	21.64	28.36	50
27.119014	48.61	11.39	60	39.44	10.56	50

Plot 2: 150 kHz to 30 MHz, neutral line

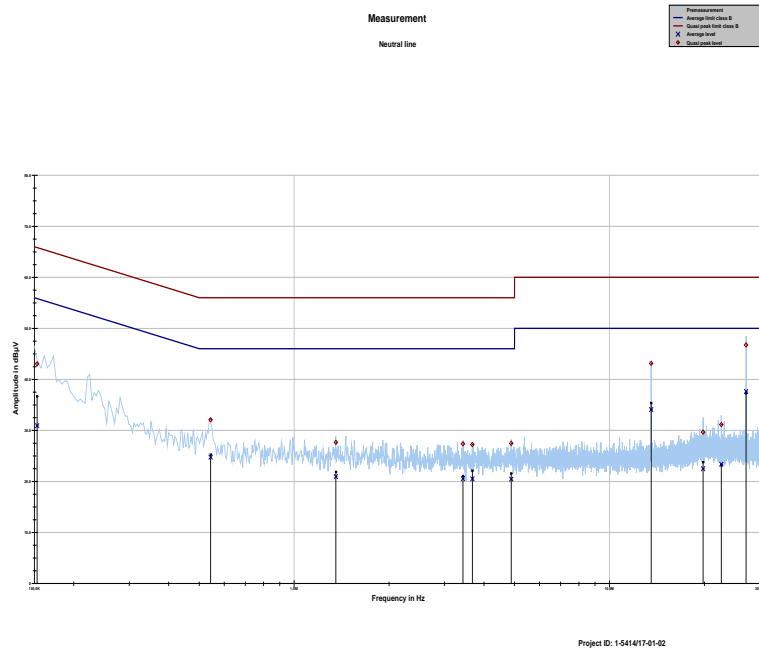

Final_Result

Frequency	Quasi peak level	Margin quasi peak	Limit QP	Average level	Margin average	Limit AV
MHz	dBµV	dB	dBµV	dBµV	dB	dBµV
0.153053	43.05	22.78	65.833	30.93	24.99	55.913
0.543398	32.08	23.92	56	24.76	21.24	46
1.355698	27.67	28.33	56	20.95	25.05	46
3.430097	27.37	28.63	56	20.55	25.45	46
3.673903	27.24	28.76	56	20.5	25.5	46
4.880291	27.47	28.53	56	20.45	25.55	46
13.56027	43.13	16.87	60	34.1	15.9	50
19.814728	29.66	30.34	60	22.5	27.5	50
22.629382	31.14	28.86	60	23.36	26.64	50
27.120111	46.74	13.26	60	37.62	12.38	50

11.5 Frequency error

Measurement:

The maximum detected field strength for the spurious.

Measurement parameters	
Detector:	Peak detector
Resolution bandwidth:	10 Hz / 100 Hz
Video bandwidth:	> RBW
Trace mode:	Max hold
Used equipment:	See chapter 6.3 A
Measurement uncertainty:	See chapter 8

Limit:

FCC
<p>The frequency tolerance of the carrier signal shall be maintained within +/- 0.01% of the operating frequency over a temperature variation of -20 degrees to +50 degrees C at normal supply voltage, and for a variation in the primary supply voltage from 85% to 115% of the rated supply voltage at a temperature of 20 degrees C. (± 1.356 kHz)</p> <p>Carrier frequency stability shall be maintained to $\pm 0.01\%$ (± 100 ppm)</p>

Result: Temperature variation

Frequency tolerance			
Measured frequency (MHz)	Frequency error (kHz)	Conditions	Result
13.559838	-0.162	-20 °C & 100% voltage	compliant
13.559887	-0.113	-10 °C & 100% voltage	compliant
13.559903	-0.097	0 °C & 100% voltage	compliant
13.559893	-0.107	+10 °C & 100% voltage	compliant
13.559868	-0.132	+20 °C & 100% voltage	compliant
13.559835	-0.165	+30 °C & 100% voltage	compliant
13.559810	-0.190	+40 °C & 100% voltage	compliant
13.559795	-0.205	+50 °C & 100% voltage	compliant

Result: Voltage variation

Frequency tolerance			
Measured frequency (MHz)	Frequency error (kHz)	Conditions	Result
13.559847	-0.153	+20 °C & 85% voltage	compliant
13.559848	-0.152	+20 °C & 100% voltage	compliant
13.559853	-0.147	+20 °C & 115% voltage	compliant

Plots:

Plot 1: -20° C, V_{nom}

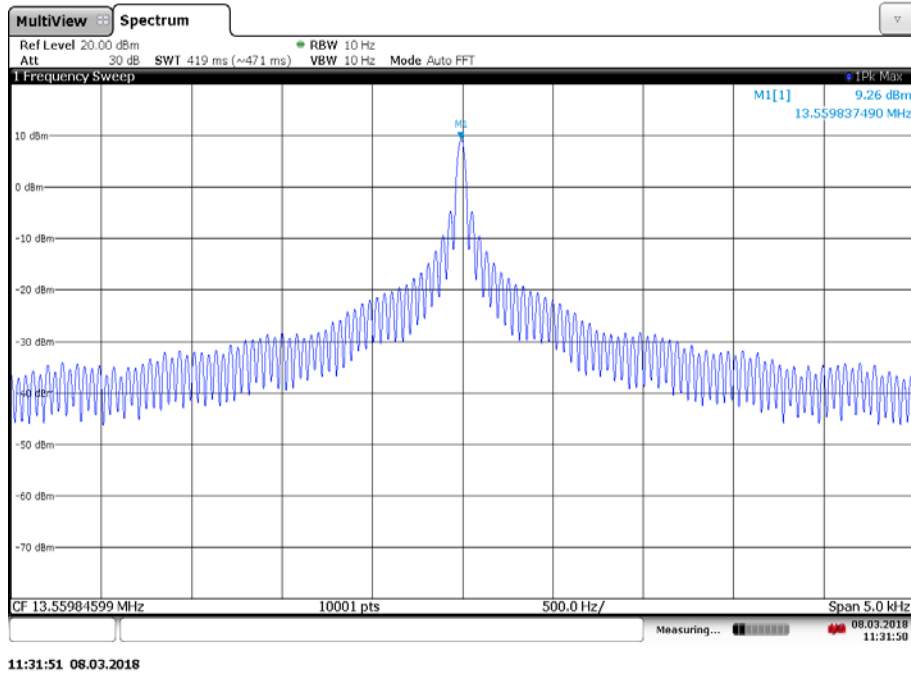

Plot 3: -10° C, V_{nom}

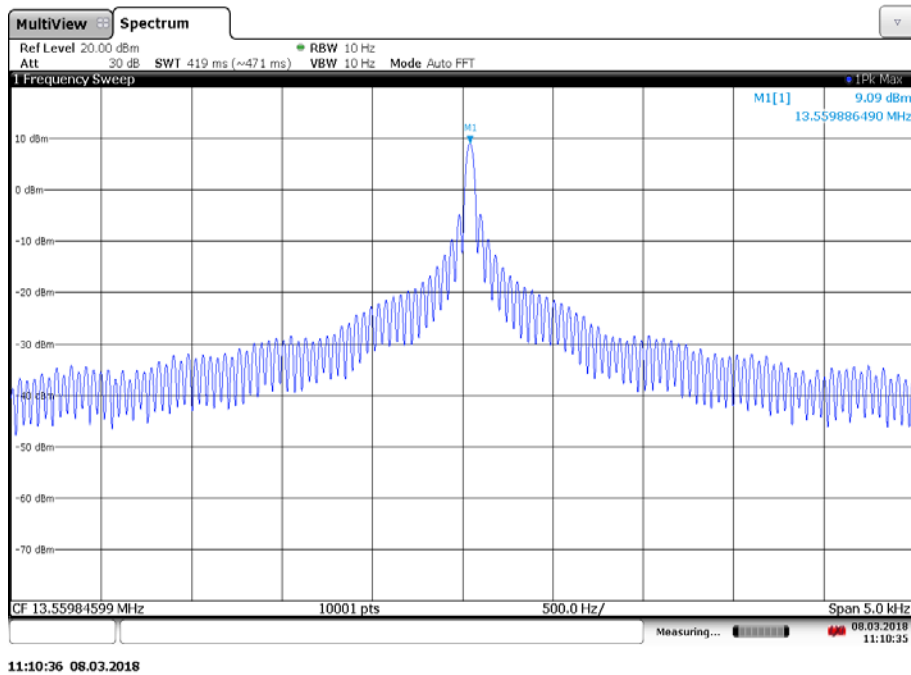

Plot 4: 0° C, V_{nom}

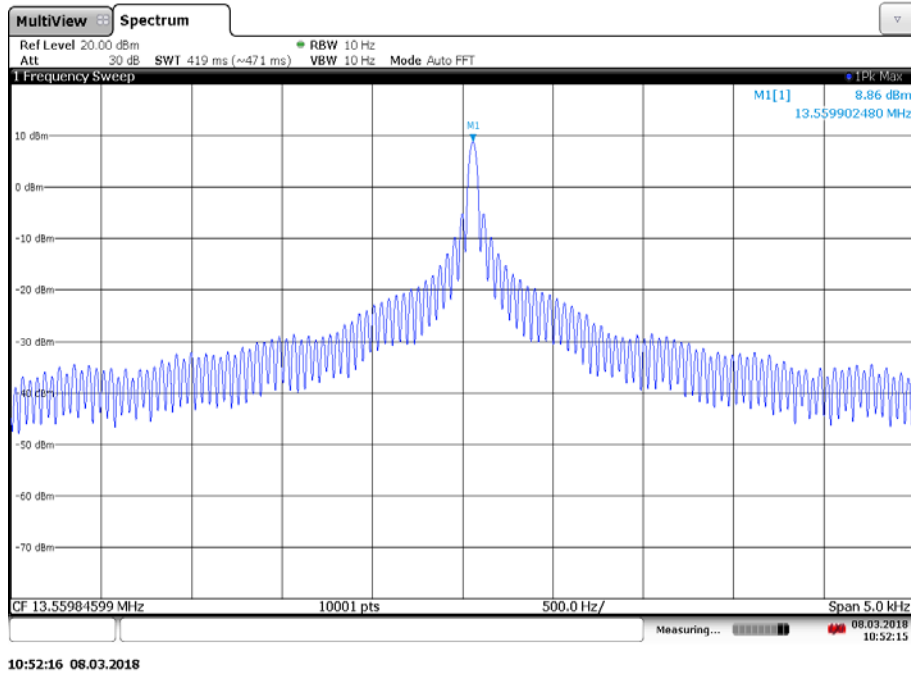

Plot 5: 10° C, V_{nom}

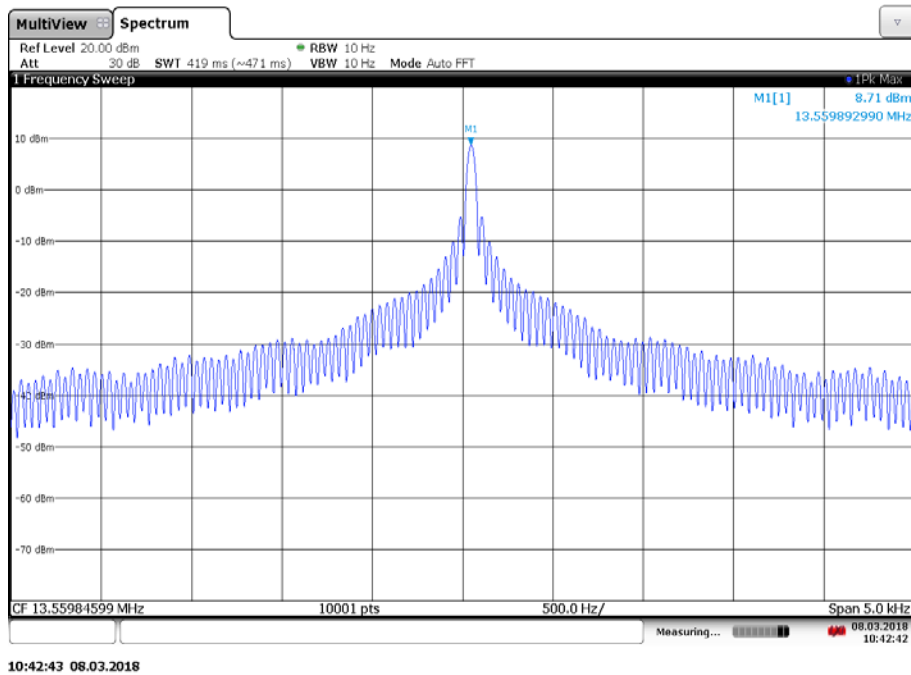

Plot 6: 20° C, V_{nom}

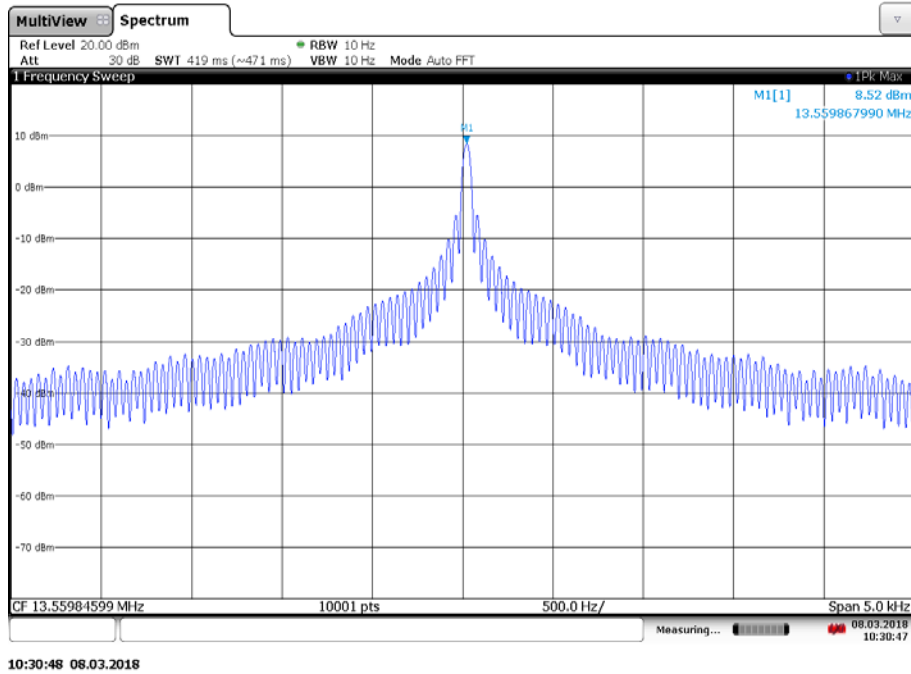

Plot 7: 30° C, V_{nom}

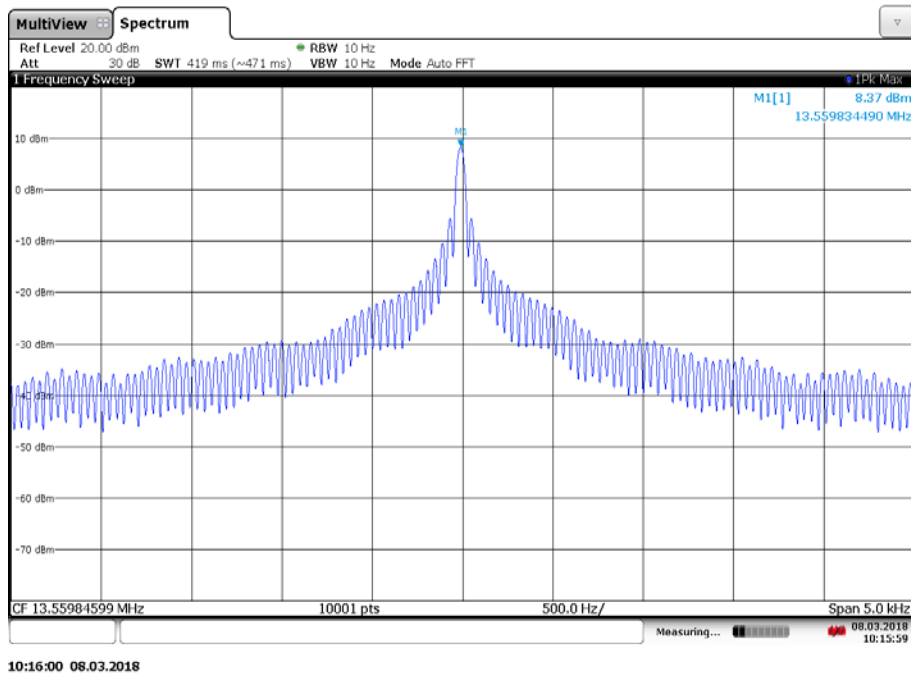

Plot 8: 40° C, V_{nom}

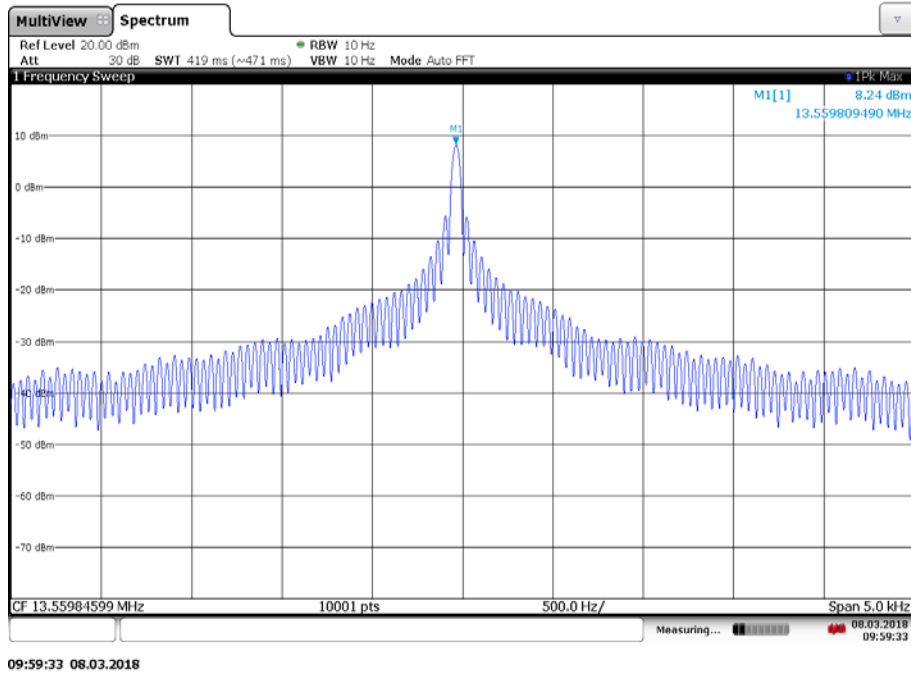

Plot 9: 50° C, V_{nom}

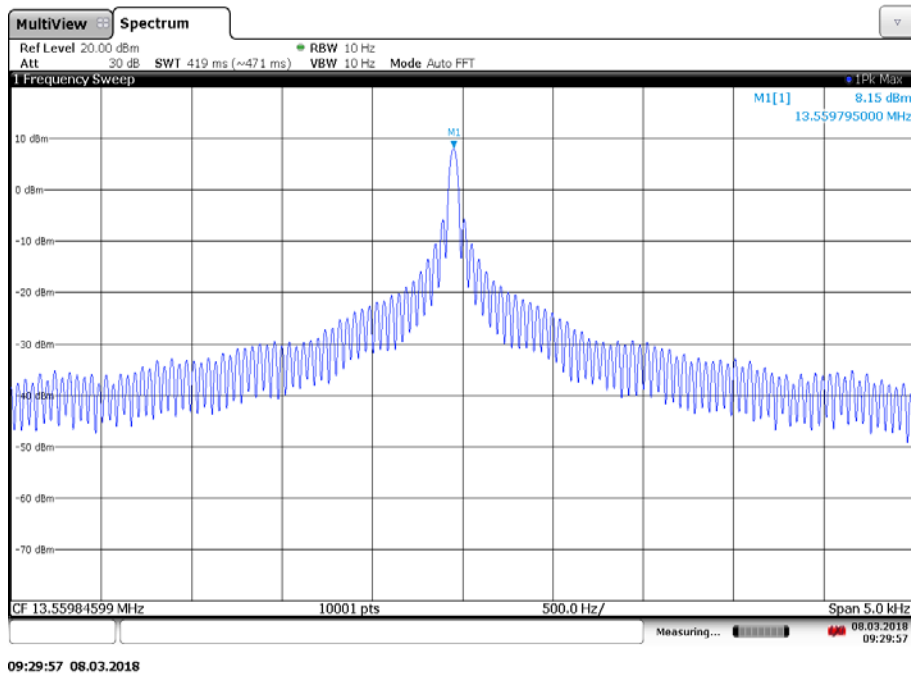

Plot 10: 20° C, V_{low}

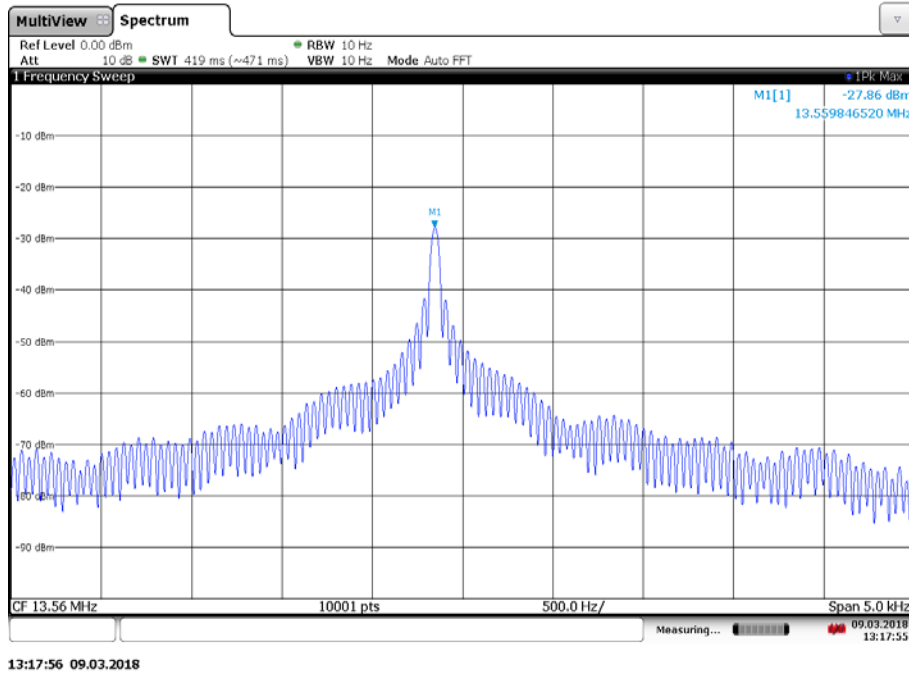

Plot 11: 20° C, V_{high}

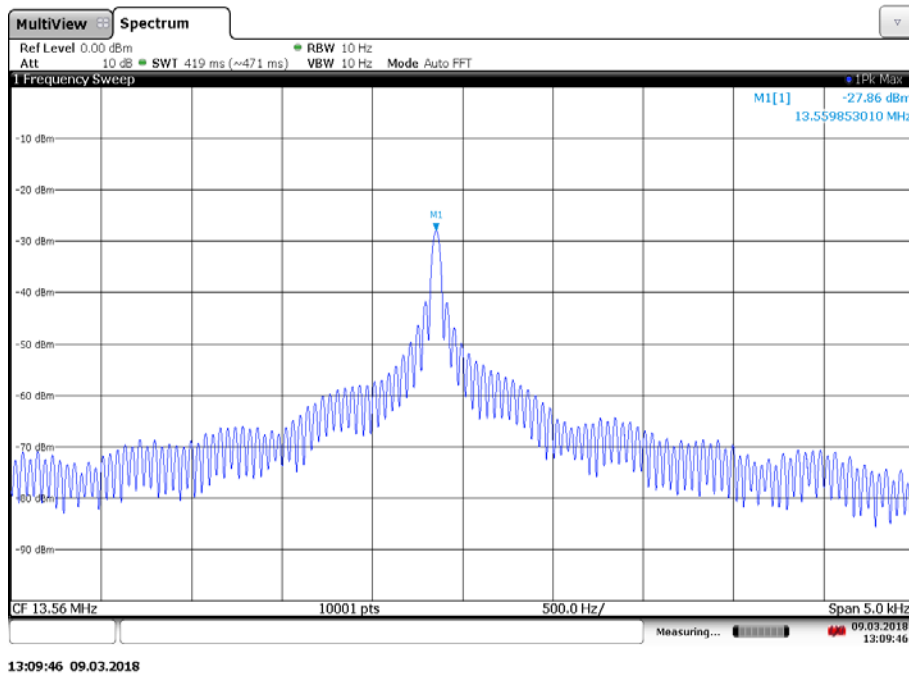

12 Observations

No observations except those reported with the single test cases have been made.

Annex A Glossary

EUT	Equipment under test
DUT	Device under test
UUT	Unit under test
GUE	GNSS User Equipment
ETSI	European Telecommunications Standards Institute
EN	European Standard
FCC	Federal Communications Commission
FCC ID	Company Identifier at FCC
IC	Industry Canada
PMN	Product marketing name
HMN	Host marketing name
HVIN	Hardware version identification number
FVIN	Firmware version identification number
EMC	Electromagnetic Compatibility
HW	Hardware
SW	Software
Inv. No.	Inventory number
S/N or SN	Serial number
C	Compliant
NC	Not compliant
NA	Not applicable
NP	Not performed
PP	Positive peak
QP	Quasi peak
AVG	Average
OC	Operating channel
OCW	Operating channel bandwidth
OBW	Occupied bandwidth
OOB	Out of band
DFS	Dynamic frequency selection
CAC	Channel availability check
OP	Occupancy period
NOP	Non occupancy period
DC	Duty cycle
PER	Packet error rate
CW	Clean wave
MC	Modulated carrier
WLAN	Wireless local area network
RLAN	Radio local area network
DSSS	Dynamic sequence spread spectrum
OFDM	Orthogonal frequency division multiplexing
FHSS	Frequency hopping spread spectrum
GNSS	Global Navigation Satellite System
C/N₀	Carrier to noise-density ratio, expressed in dB-Hz

Annex B Document history

Version	Applied changes	Date of release
-/-	Initial release	2018-06-18

Annex C Accreditation Certificate

first page	last page
 <p>The first page of the accreditation certificate features the DAkKS logo (Deutsche Akkreditierungsstelle) and the text: 'Deutsche Akkreditierungsstelle GmbH. Entrusted according to Section 8 subsection 1 AkkStelleG in connection with Section 1 subsection 1 AkkStelleGBV. Signatory to the Multilateral Agreements of EA, ILAC and IAF for Mutual Recognition.' It includes the German national emblem and the word 'Accreditation'. The certificate attests that CTC advanced GmbH, located at Untertürkheimer Straße 6-10, 66117 Saarbrücken, is competent under DIN EN ISO/IEC 17025:2005 for telecommunication tests. It also mentions the registration number D-PL-12076-01-03 and the date of accreditation (02.06.2017).</p>	 <p>The last page of the certificate lists the office addresses: Berlin (Spittelmarkt 10), Frankfurt am Main (Europa-Allee 52), and Braunschweig (Bundesallee 100). It contains a disclaimer: 'The publication of extracts of the accreditation certificate is subject to the prior written approval by Deutsche Akkreditierungsstelle GmbH (DAKKS). Exempted is the unchanged form of separate disseminations of the cover sheet by the conformity assessment body mentioned overleaf.' It also states that the accreditation was granted pursuant to the Act on the Accreditation Body (AkkStelleG) of 31 July 2009 and lists the websites for up-to-date membership information: EA, ILAC, and IAF.</p>

Note: The current certificate annex is published on the website (link see below) of the Accreditation Body DAkKS or may be received by CTC advanced GmbH on request

<https://www.dakks.de/as/ast/d/D-PL-12076-01-03e.pdf>