

FCC REPORT (LTE)

Applicant: Neutron Holdings, Inc.
Address of Applicant: 85 2nd St, San Francisco, CA 94105 USA
Equipment Under Test (EUT)
Product Name: Central controller
Model No.: Lime-4.0-US
Trade mark: Lime
FCC ID: 2APB2LIME-V4-US
Applicable standards: FCC CFR Title 47 Part 2
FCC CFR Title 47 Part 24 Subpart E
FCC CFR Title 47 Part 27 Subpart L
FCC CFR Title 47 Part 27 Subpart F
FCC CFR Title 47 Part 27 Subpart H
Date of sample receipt: 08 May, 2021
Date of Test: 08 May, to 04 Jun., 2021
Date of report issued: 04 Jun., 2021
Test Result: PASS*

*In the configuration tested, the EUT complied with the standards specified above.

Authorized Signature:



Bruce Zhang
Laboratory Manager

This report details the results of the testing carried out on one sample. The results contained in this test report do not relate to other samples of the same product and does not permit the use of the JYT product certification mark. The manufacturer should ensure that all products in series production are in conformity with the product sample detailed in this report.

This report may only be reproduced and distributed in full. If the product in this report is used in any configuration other than that detailed in the report, the manufacturer must ensure the new system complies with all relevant standards.

This document cannot be reproduced except in full, without prior written approval of the Company. Any unauthorized alteration, forgery or falsification of the content or appearance of this document is unlawful, and offenders may be prosecuted to the fullest extent of the law. Unless otherwise stated the results shown in this test report refer only to the sample(s) tested and such sample(s) are retained for 90 days only.

2. Version

Version No.	Date	Description
00	04 Jun., 2021	Original

Tested by: YT Yang **Date:** 04 Jun., 2021
Test Engineer

Reviewed by: Winner Zhang **Date:** 04 Jun., 2021
Project Engineer

3. Contents

Page

1.	COVER PAGE.....	1
2.	VERSION.....	2
3.	CONTENTS.....	3
4.	TEST SUMMARY.....	4
5.	GENERAL INFORMATION.....	5
5.1	CLIENT INFORMATION.....	5
5.2	GENERAL DESCRIPTION OF E.U.T.....	5
5.3	TEST ENVIRONMENT AND MODE, AND TEST SAMPLES PLANS.....	11
5.4	DESCRIPTION OF SUPPORT UNITS.....	11
5.5	MEASUREMENT UNCERTAINTY.....	11
5.6	RELATED SUBMITTAL(S) / GRANT (S).....	11
5.7	ADDITIONS TO, DEVIATIONS, OR EXCLUSIONS FROM THE METHOD.....	11
5.8	LABORATORY FACILITY.....	12
5.9	LABORATORY LOCATION.....	12
5.10	TEST INSTRUMENTS LIST.....	12
6.	TEST RESULTS.....	13
6.1	CONDUCTED OUTPUT POWER, ERP AND EIRP.....	13
6.2	PEAK-TO-AVERAGE RATIO.....	24
6.3	OCCUPY BANDWIDTH.....	25
6.4	OUT OF BAND EMISSION AT ANTENNA TERMINALS.....	26
6.5	FIELD STRENGTH OF SPURIOUS RADIATION MEASUREMENT.....	48
6.6	FREQUENCY STABILITY V.S. TEMPERATURE MEASUREMENT.....	61
6.7	FREQUENCY STABILITY V.S. VOLTAGE MEASUREMENT.....	62
7	TEST SETUP PHOTO.....	63
8	EUT CONSTRUCTIONAL DETAILS.....	64

4. Test Summary

Test Items	Section in CFR 47	Result
RF Exposure (SAR)	Part 1.1307 Part 2.1093	Passed (Please refer to SAR Report)
RF Output Power	Part 2.1046 Part 24.232 (c) Part 27.50 (c)(10) Part 27.50 (d)(4)	Pass
Peak-to-Average Ratio	Part 24.232 (d) Part 27.50(d)(5)	Appendix B – LTE
Modulation Characteristics	Part 2.1047	Pass
99% & -26 dB Occupied Bandwidth	Part 2.1049 Part 24.238(b) Part 27.53(g) Part 27.53(h)	Appendix C – LTE
Out of band emission at antenna terminals	Part 2.1053 Part 24.238 (a) Part 27.53 (g) Part 27.53 (h)	Appendix E – LTE
Field strength of spurious radiation	Part 24.238 (a) Part 27.53 (g) Part 27.53 (h)	Pass
Frequency stability vs. temperature	Part 22.355 Part 24.235 Part 27.54 Part 2.1055(a)(1)(b)	Appendix F – LTE
Frequency stability vs. voltage	Part 22.355 Part 24.235 Part 27.54 Part 2.1055(d)(2)	Appendix F – LTE
Remark: 1. Pass: The EUT complies with the essential requirements in the standard. 2. The cable insertion loss used by "RF Output Power" and other conduction measurement items is 0.5dB(Fundamental Frequency below 1GHz)/1.0dB(Fundamental Frequency above 1GHz) (provided by the customer).		
Test Method:	ANSI/TIA-603-E-2016 ANSI C63.26-2015	

5. General Information

5.1 Client Information

Applicant:	Neutron Holdings, Inc.
Address:	85 2nd St, San Francisco, CA 94105 USA
Manufacturer:	Quectel Wireless Solutions Co., Ltd.
Address:	Building 5, Shanghai Business Park Phase III (Area B), No.1016 Tianlin Road, Minhang District, Shanghai 200233, China
Factory:	MeiG Smart Technology Co., Ltd.
Address:	1/2/3F A, Building A, B, No.5 Lingxia Road, 4th Fenghuang Industrial Park, Fuyong Street, Baoan District, Shenzhen, Guangdong, China

5.2 General Description of E.U.T.

Product Name:	Central controller		
Model No.:	Lime-4.0-US		
Operation Frequency range:	LTE Band 2:	TX: 1850MHz-1910MHz	RX: 1930MHz-1990MHz
	LTE Band 4:	TX: 1710MHz-1755MHz	RX: 2110MHz-2155MHz
	LTE Band 12:	TX: 699MHz-716MHz	RX: 729MHz-746MHz
	LTE Band 13:	TX: 777MHz-787MHz	RX: 746MHz-756MHz
	LTE Band 17:	TX: 704MHz-716MHz	RX: 734MHz-746MHz
Modulation type:	<input checked="" type="checkbox"/> QPSK	<input checked="" type="checkbox"/> 16QAM	<input checked="" type="checkbox"/> 64QAM
Antenna type:	Internal Antenna		
Antenna gain:	LTE Band 2:	2 dBi(declare by Applicant)	
	LTE Band 4:	2 dBi(declare by Applicant)	
	LTE Band 12:	2 dBi(declare by Applicant)	
	LTE Band 13:	2 dBi(declare by Applicant)	
	LTE Band 17:	2 dBi(declare by Applicant)	
Power supply:	Rechargeable Li-ion Battery DC3.7V, 1250mAh		
External power supply:	DC 36V		
Test Sample Condition:	The applicant provided engineering samples for staying in continuously transmitting for testing.		

Operation Frequency List:

LTE Band 2 (1.4MHz)		LTE Band 2 (3MHz)	
Channel	Frequency (MHz)	Channel	Frequency (MHz)
18607	1850.70	18615	1851.50
18608	1850.80	18616	1851.60
....
18899	1879.90	18899	1879.90
18900	1880.00	18900	1880.00
18901	1880.10	18901	1880.10
...
19193	1909.20	19185	1908.40
19194	1909.30	19186	1908.50
LTE Band 2 (5MHz)		LTE Band 2 (10MHz)	
Channel	Frequency (MHz)	Channel	Frequency (MHz)
18625	1852.50	18650	1855.00
18626	1852.60	18651	1855.10
....
18899	1879.90	18899	1879.90
18900	1880.00	18900	1880.00
18901	1880.10	18901	1880.10
...
19175	1907.40	19150	1904.90
19176	1907.50	19151	1905.00
LTE Band 2 (15MHz)		LTE Band 2 (20MHz)	
Channel	Frequency (MHz)	Channel	Frequency (MHz)
18675	1857.50	18700	1860.00
18676	1857.60	18701	1860.10
....
18899	1879.90	18899	1879.90
18900	1880.00	18900	1880.00
18901	1880.10	18901	1880.10
...
19125	1902.40	19100	1899.90
19126	1902.50	19101	1900.00

LTE Band 4 (1.4MHz)		LTE Band 4 (3MHz)	
Channel	Frequency (MHz)	Channel	Frequency (MHz)
19957	1710.70	19965	1711.50
19958	1710.80	19966	1711.60
....
20174	1732.40	20174	1732.40
20175	1732.50	20175	1732.50
20176	1732.60	20176	1732.60
...
20392	1754.20	20384	1753.40
20393	1754.30	20385	1753.50
LTE Band 4 (5MHz)		LTE Band 4 (10MHz)	
Channel	Frequency (MHz)	Channel	Frequency (MHz)
19975	1712.50	20000	1715.00
19976	1712.60	20001	1715.10
....
20174	1732.40	20174	1732.40
20175	1732.50	20175	1732.50
20176	1732.60	20176	1732.60
...
20374	1752.40	20349	1749.90
20375	1752.50	20350	1750.00
LTE Band 4 (15MHz)		LTE Band 4 (20MHz)	
Channel	Frequency (MHz)	Channel	Frequency (MHz)
20025	1717.50	20050	1720.00
20026	1717.60	20051	1720.10
....
20174	1732.40	20174	1732.40
20175	1732.50	20175	1732.50
20176	1732.60	20176	1732.60
...
20324	1747.40	20299	1744.90
20325	1747.50	20300	1745.00

LTE Band 12 (1.4MHz)		LTE Band 12 (3MHz)	
Channel	Frequency (MHz)	Channel	Frequency (MHz)
23017	699.70	23025	700.50
23756	699.80	23026	700.60
....
23094	707.40	23094	707.40
23095	707.50	23095	707.50
23096	707.60	23096	707.60
...
23172	715.20	23164	714.40
23173	715.30	23165	714.50
LTE Band 12 (5MHz)		LTE Band 12 (10MHz)	
Channel	Frequency (MHz)	Channel	Frequency (MHz)
23035	701.50	23060	704.00
23036	701.60	23061	704.10
....
23094	707.40	23094	707.40
23095	707.50	23095	707.50
23096	707.60	23096	707.60
...
23154	713.40	23129	710.90
23155	713.50	23130	711.00

LTE Band 13 (5MHz)		LTE Band 13 (10MHz)	
Channel	Frequency (MHz)	Channel	Frequency (MHz)
23205	779.50	/	/
23206	779.60	/	/
....	/	/
23229	781.90	/	/
23230	782.00	23230	782.00
23231	782.10	/	/
...	...	/	/
23255	784.50	/	/
23256	784.60	/	/

LTE Band 17 (5MHz)		LTE Band 17 (10MHz)	
Channel	Frequency (MHz)	Channel	Frequency (MHz)
23755	706.50	23780	709.00
23756	706.60	23781	709.10
....
23789	709.90	23789	709.90
23790	710.00	23790	710.00
23791	710.10	23791	710.10
...
23824	713.40	23799	710.90
23825	713.50	23800	711.00

Regards to the operating frequency range, the lowest frequency, the middle frequency, and the highest frequency of channel were selected to perform the test, and the selected channels as below:

LTE Band 2 (1.4MHz)			LTE Band 2 (3MHz)		
Channel	Frequency (MHz)		Channel	Frequency (MHz)	
Lowest channel	18607	1850.70	Lowest channel	18615	1851.50
Middle channel	18900	1880.00	Middle channel	18900	1880.00
Highest channel	19193	1909.30	Highest channel	19185	1908.50
LTE Band 2 (5MHz)			LTE Band 2 (10MHz)		
Channel	Frequency (MHz)		Channel	Frequency (MHz)	
Lowest channel	18625	1852.50	Lowest channel	18650	1855.00
Middle channel	18900	1880.00	Middle channel	18900	1880.00
Highest channel	19175	1907.50	Highest channel	19150	1905.00
LTE Band 2 (15MHz)			LTE Band 2 (20MHz)		
Channel	Frequency (MHz)		Channel	Frequency (MHz)	
Lowest channel	18675	1857.50	Lowest channel	18700	1860.00
Middle channel	18900	1880.00	Middle channel	18900	1880.00
Highest channel	19125	1902.50	Highest channel	19100	1900.00

LTE Band 4 (1.4MHz)			LTE Band 4 (3MHz)		
Channel:	Frequency (MHz)		Channel	Frequency (MHz)	
Lowest channel	19957	1710.70	Lowest channel	19965	1711.50
Middle channel	20175	1732.50	Middle channel	20175	1732.50
Highest channel	20393	1754.30	Highest channel	20385	1753.50
LTE Band 4 (5MHz)			LTE Band 4 (10MHz)		
Channel	Frequency (MHz)		Channel	Frequency (MHz)	
Lowest channel	19975	1712.50	Lowest channel	20000	1715.00
Middle channel	20175	1732.50	Middle channel	20175	1732.50
Highest channel	20375	1752.50	Highest channel	20350	1750.00
LTE Band 4 (15MHz)			LTE Band 4 (20MHz)		
Channel	Frequency (MHz)		Channel	Frequency (MHz)	
Lowest channel	20025	1717.50	Lowest channel	20050	1720.00
Middle channel	20175	1732.50	Middle channel	20175	1732.50
Highest channel	20325	1747.50	Highest channel	20300	1745.00

LTE Band 12(1.4MHz)			LTE Band 12(3MHz)		
Channel	Frequency (MHz)		Channel	Frequency (MHz)	
Lowest channel	23017	699.70	Lowest channel	23025	700.50
Middle channel	23095	707.50	Middle channel	23095	707.50
Highest channel	23173	715.30	Highest channel	23165	714.50
LTE Band 12(5MHz)			LTE Band 12(10MHz)		
Channel	Frequency (MHz)		Channel	Frequency (MHz)	
Lowest channel	23035	701.50	Lowest channel	23060	704.00
Middle channel	23095	707.50	Middle channel	23095	707.50
Highest channel	23155	713.50	Highest channel	23130	711.00

LTE Band 13(5MHz)			LTE Band 13(10MHz)		
Channel		Frequency (MHz)	Channel		Frequency (MHz)
Lowest channel	23205	779.5	Lowest channel	/	/
Middle channel	23230	782.0	Middle channel	23230	782.00
Highest channel	23255	784.5	Highest channel	/	/

LTE Band 17(5MHz)			LTE Band 17(10MHz)		
Channel		Frequency (MHz)	Channel		Frequency (MHz)
Lowest channel	23755	706.50	Lowest channel	23780	709.00
Middle channel	23790	710.00	Middle channel	23790	710.00
Highest channel	23825	713.50	Highest channel	23800	711.00

5.3 Test environment and mode, and test samples plans

Operating Environment:	
Temperature:	Normal: 15°C ~ 35°C, Extreme: -30°C ~ +50°C
Humidity:	20 % ~ 75 % RH
Atmospheric Pressure:	1008 mbar
Voltage:	Nominal: 3.7Vdc, Extreme: Low 3.5Vdc, High 4.2Vdc
Test mode:	
LTE QPSK mode	Keep the EUT communication with simulated station in QPSK mode
LTE 16-QAM mode	Keep the EUT communication with simulated station in 16-QAM mode
Remark: Each Band 1.4MH bandwidth of LTE supports 1RB 0, 3RB0, 6RB0; 3MHz bandwidth supports 1RB 0, 8RB0, 15RB0; 5MHzBandwidth support 1RB 0, 12RB0, 25RB0; 10MHz bandwidth QPSK supports 1RB 0, 25RB0, 50RB0; 16QAM supports 1RB 0, 12RB0, does not support FULL RB, 15MHz bandwidth QPSK Support 1RB 0, 36RB0, 75RB0; 16QAM supports 1RB 0, 16RB0, does not support FULL RB, 20MHz bandwidth QPSK Support 1RB 0, 50RB0, 100RB0; 16QAM supports 1RB 0, 18RB0, does not support FULL RB, cannot pass Software adjustment.	
Remark: The EUT has been tested under continuous transmitting mode. Channel Low, Mid and High for each type band with rated data rate were chosen for full testing. The field strength of spurious radiation emission was measured as EUT stand-up position (H mode) and lie down position (E1, E2 mode) for these modes. Just the worst case position (H mode) shown in report.	
Test Samples Plans:	
Samples Number	Used for Test Items
1#	Conducted measurements test method
2#	Radiated measurements test method
3#	EUT constructional details
Remark: JianYan Testing Group Shenzhen Co., Ltd. is only responsible for the test project data of the above samples, and will keep the above samples for a month.	

5.4 Description of Support Units

Test Equipment	Manufacturer	Model No.	Serial No.
Simulated Station	Anritsu	MT8820C	6201026545

5.5 Measurement Uncertainty

Parameters	Expanded Uncertainty
Radiated Emission (9kHz ~ 30MHz)	±3.12 dB (k=2)
Radiated Emission (30MHz ~ 1000MHz)	±4.32 dB (k=2)
Radiated Emission (1GHz ~ 18GHz)	±5.16 dB (k=2)
Radiated Emission (18GHz ~ 40GHz)	±3.20 dB (k=2)

5.6 Related Submittal(s) / Grant (s)

This is an original grant, no related submittals and grants.
--

5.7 Additions to, deviations, or exclusions from the method

No

5.8 Laboratory Facility

The test facility is recognized, certified, or accredited by the following organizations:

● **FCC - Designation No.: CN1211**

JianYan Testing Group Shenzhen Co., Ltd. has been accredited as a testing laboratory by FCC (Federal Communications Commission). The test firm Registration No. is 727551.

● **ISED – CAB identifier.: CN0021**

The 3m Semi-anechoic chamber of JianYan Testing Group Shenzhen Co., Ltd. has been Registered by Certification and Engineering Bureau of Industry Canada for radio equipment testing with Registration No.: 10106A-1.

● **A2LA - Registration No.: 4346.01**

This laboratory is accredited in accordance with the recognized International Standard ISO/IEC 17025:2005 General requirements for the competence of testing and calibration laboratories. The test scope can be found as below link: <https://portal.a2la.org/scopepdf/4346-01.pdf>

5.9 Laboratory Location

JianYan Testing Group Shenzhen Co., Ltd.

Address: No.101, Building 8, Innovation Wisdom Port, No.155 Hongtian Road, Huangpu Community, Xinqiao Street, Bao'an District, Shenzhen, Guangdong, People's Republic of China.

Tel: +86-755-23118282, Fax: +86-755-23116366

Email: info@ccis-cb.com, Website: <http://www.ccis-cb.com>

5.10 Test Instruments list

Test Equipment	Manufacturer	Model No.	Serial No.	Cal. Date (mm-dd-yy)	Cal. Due date (mm-dd-yy)
3m SAC	ETS	9m*6m*6m	966	01-19-2021	01-18-2024
BiConiLog Antenna	SCHWARZBECK	VULB9163	497	03-03-2021	03-02-2022
Biconical Antenna	SCHWARZBECK	VUBA9117	359	06-18-2020	06-17-2021
Horn Antenna	SCHWARZBECK	BBHA9120D	916	03-03-2021	03-02-2022
Horn Antenna	SCHWARZBECK	BBHA9120D	1805	06-18-2020	06-17-2021
Horn Antenna	SCHWARZBECK	BBHA 9170	BBHA9170582	11-18-2020	11-17-2021
EMI Test Software	AUDIX	E3	Version: 6.110919b		
Pre-amplifier	HP	8447D	2944A09358	03-03-2021	03-02-2022
Pre-amplifier	CD	PAP-1G18	11804	03-03-2021	03-02-2022
Spectrum analyzer	Rohde & Schwarz	FSP30	101454	03-03-2021	03-02-2022
Spectrum analyzer	Rohde & Schwarz	FSP40	100363	11-18-2020	11-17-2021
EMI Test Receiver	Rohde & Schwarz	ESRP7	101070	03-03-2021	03-02-2022
Spectrum Analyzer	Agilent	N9020A	MY50510123	11-18-2020	11-17-2021
Signal Generator	Rohde & Schwarz	SMX	835454/016	03-03-2021	03-02-2022
Signal Generator	R&S	SMR20	1008100050	03-03-2021	03-02-2022
RF Switch Unit	MWRFTTEST	MW200	N/A	N/A	N/A
Test Software	MWRFTTEST	MTS8200	Version: 2.0.0.0		
Cable	ZDECL	Z108-NJ-NJ-81	1608458	03-03-2021	03-02-2022
Cable	MICRO-COAX	MFR64639	K10742-5	03-03-2021	03-02-2022
Cable	SUHNER	SUCOFLEX100	58193/4PE	03-03-2021	03-02-2022
DC Power Supply	XinNuoEr	WYK-10020K	1409050110020	09-25-2020	09-24-2021
Temperature Humidity Chamber	HengPu	HPGDS-500	20140828008	11-01-2020	10-31-2021
Simulated Station	Rohde & Schwarz	CMW500	140493	07-22-2020	07-21-2021

6. Test results

6.1 Conducted Output Power, ERP and EIRP

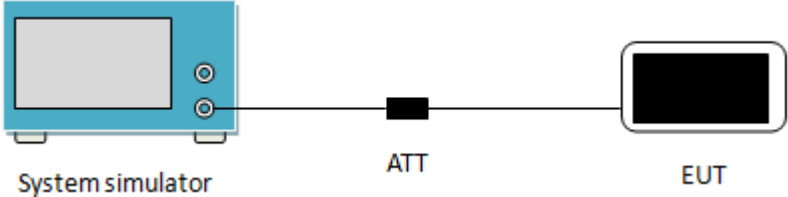
Test Requirement:	Part 24.232(c), part 27.50(c)(10), Part 27.50(d)(4)
Limit:	LTE Band 2: 2W, LTE Band 4: 1W, LTE Band 12: 3W, LTE Band 13: 3W, LTE Band 17: 3W
Test Setup:	 <p>The diagram illustrates the test setup. On the left is a blue 'System simulator' with a screen and two ports. A line connects it to a black 'ATT' (attenuator) block. Another line connects the 'ATT' to a black 'EUT' (Equipment Under Test) device.</p>
Test Procedure:	The transmitter output was connected to a calibrated attenuator, the other end of which was connected to the CMW500. Transmitter output power was read off in dBm.
Test Instruments:	Refer to section 5.10 for details
Test mode:	Refer to section 5.3 for details
Test results:	Passed

Measurement Data:

LTE Band	Bandwidth (MHz)	Modulation	RB Size	RB Offset	Average Power (dBm)				
					18607	18900	19193		
					1850.7MHz	1880.0MHz	1909.3MHz		
2	1.4	QPSK	1	0	24.15	24.06	24.27		
			1	2	24.25	24.26	24.45		
			1	5	24.15	24.06	24.32		
			3	0	24.29	24.18	24.26		
			3	1	24.28	24.16	24.27		
			3	2	24.28	24.22	24.26		
			6	0	23.24	23.17	23.45		
		Antenna Gain (dBi):					2.00		
		Max. EIRP (dBm):					26.45		
		EIRP Limit (dBm):					33.00		
		16QAM	1	0	22.94	23.01	23.09		
			1	2	23.14	23.18	23.28		
			1	5	22.93	22.99	23.08		
			3	0	23.01	22.96	23.09		
			3	1	23.03	22.98	23.07		
			3	2	23.03	23.00	23.11		
			6	0	22.19	22.13	22.28		
		Antenna Gain (dBi):					2.00		
		Max. EIRP (dBm):					25.28		
		EIRP Limit (dBm):					33.00		

LTE Band	Bandwidth (MHz)	Modulation	RB Size	RB Offset	Average Power (dBm)				
					18615	18900	19185		
					1851.5MHz	1880.0MHz	1908.5MHz		
2	3	QPSK	1	0	24.19	24.15	24.20		
			1	7	24.17	24.12	24.33		
			1	14	24.08	24.11	24.38		
			8	0	23.19	23.14	23.27		
			8	4	23.15	23.11	23.27		
			8	7	23.12	23.05	23.30		
			15	0	23.08	23.07	23.23		
		Antenna Gain (dBi):					2.00		
		Max. EIRP (dBm):					26.38		
		EIRP Limit (dBm):					33.00		
		16QAM	1	0	22.95	23.14	23.05		
			1	7	22.91	23.08	23.04		
			1	14	22.86	23.09	23.04		
			8	0	22.18	22.12	22.22		
			8	4	22.15	22.13	22.19		
			8	7	22.12	22.13	22.26		
			15	0	22.02	22.12	22.14		
		Antenna Gain (dBi):					2.00		
		Max. EIRP (dBm):					25.14		
		EIRP Limit (dBm):					33.00		

Note: EIRP (dBm) = Average power (dBm) + Antenna Gain (dBi).

LTE Band	Bandwidth (MHz)	Modulation	RB Size	RB Offset	Average Power (dBm)				
					18625	18900	19175		
					1852.5MHz	1880.0MHz	1907.5MHz		
2	5	QPSK	1	0	24.15	24.04	24.07		
			1	12	24.23	24.13	24.27		
			1	24	24.08	24.03	24.30		
			12	0	23.12	23.14	23.17		
			12	6	23.13	23.13	23.16		
			12	11	23.16	23.14	23.18		
			25	0	23.13	23.13	23.23		
		Antenna Gain (dBi):					2.00		
		Max. EIRP (dBm):					26.30		
		EIRP Limit (dBm):					33.00		
		16QAM	1	0	23.10	23.11	23.02		
			1	12	23.11	23.14	23.16		
			1	24	23.03	23.11	23.13		
			12	0	22.08	22.15	22.16		
			12	6	22.10	22.10	22.15		
			12	11	22.06	22.17	22.17		
			25	0	22.12	22.08	22.24		
		Antenna Gain (dBi):					2.00		
		Max. EIRP (dBm):					25.16		
		EIRP Limit (dBm):					33.00		
		LTE Band	Bandwidth (MHz)	Modulation	RB Size	RB Offset	Average Power (dBm)		
18650	18900						19150		
1855.0MHz	1880.0MHz						1905.0MHz		
2	10	QPSK	1	0	24.14	24.22	23.96		
			1	24	24.16	24.18	24.25		
			1	49	24.11	23.99	24.27		
			25	0	23.06	23.18	23.26		
			25	12	23.09	23.18	23.22		
			25	24	23.07	23.18	23.25		
			50	0	23.09	23.16	23.26		
		Antenna Gain (dBi):					2.00		
		Max. EIRP (dBm):					26.27		
		EIRP Limit (dBm):					33.00		
		16QAM	1	0	23.19	22.99	22.76		
			1	24	23.15	23.09	23.04		
			1	49	23.05	22.81	23.06		
			12	0	23.07	23.11	23.01		
			12	19	23.05	23.09	22.97		
			12	38	23.11	22.98	23.13		
			50	0	/	/	/		
		Antenna Gain (dBi):					2.00		
		Max. EIRP (dBm):					25.19		
		EIRP Limit (dBm):					33.00		
		<i>Note: EIRP (dBm) = Average power (dBm) + Antenna Gain (dBi).</i>							

LTE Band	Bandwidth (MHz)	Modulation	RB Size	RB Offset	Average Power (dBm)				
					18675	18900	19125		
					1857.5MHz	1880.0MHz	1902.5MHz		
2	15	QPSK	1	0	24.08	24.01	23.82		
			1	37	24.10	24.06	24.07		
			1	74	24.05	23.80	24.17		
			36	0	23.18	23.20	23.09		
			36	16	23.13	23.22	23.10		
			36	35	23.16	23.22	23.10		
			75	0	23.14	23.20	23.22		
		Antenna Gain (dBi):					2.00		
		Max. EIRP (dBm):					26.17		
		EIRP Limit (dBm):					33.00		
		16QAM	1	0	23.14	23.13	22.62		
			1	37	23.09	23.17	22.84		
			1	74	23.09	22.98	22.90		
			16	0	23.02	23.12	22.81		
			16	30	23.03	23.07	22.81		
			16	59	22.99	23.02	23.09		
			75	0	/	/	/		
		Antenna Gain (dBi):					2.00		
		Max. EIRP (dBm):					25.17		
		EIRP Limit (dBm):					33.00		
		LTE Band	Bandwidth (MHz)	Modulation	RB Size	RB Offset	Average Power (dBm)		
18700	18900						19100		
1860.0MHz	1880.0MHz						1900.0MHz		
2	20	QPSK	1	0	23.94	23.99	23.57		
			1	49	24.29	24.26	23.94		
			1	99	24.03	23.73	23.99		
			50	0	23.13	23.25	23.01		
			50	24	23.10	23.24	23.04		
			50	49	23.10	23.19	23.01		
			100	0	23.15	23.19	23.12		
		Antenna Gain (dBi):					2.00		
		Max. EIRP (dBm):					26.29		
		EIRP Limit (dBm):					33.00		
		16QAM	1	0	22.81	23.09	22.48		
			1	49	23.11	23.35	22.99		
			1	99	22.92	22.85	22.85		
			18	0	22.93	23.04	22.76		
			18	41	22.89	23.04	22.76		
			18	82	23.00	22.85	23.12		
			100	0	/	/	/		
		Antenna Gain (dBi):					2.00		
		Max. EIRP (dBm):					25.35		
		EIRP Limit (dBm):					33.00		
		<i>Note: EIRP (dBm) = Average power (dBm) + Antenna Gain (dBi).</i>							

LTE Band	Bandwidth (MHz)	Modulation	RB Size	RB Offset	Average Power (dBm)				
					19957	20175	20393		
					1710.7MHz	1732.5MHz	1754.3MHz		
4	1.4	QPSK	1	0	24.40	24.33	24.66		
			1	2	24.63	24.34	24.91		
			1	5	24.40	24.34	24.70		
			3	0	24.42	24.40	24.67		
			3	1	24.43	24.40	24.68		
			3	2	24.45	24.38	24.72		
			6	0	23.44	23.37	23.70		
		Antenna Gain (dBi):					2.00		
		Max. EIRP (dBm):					26.91		
		EIRP Limit (dBm):					30.00		
		16QAM	1	0	23.14	23.23	23.46		
			1	2	23.27	23.35	23.68		
			1	5	23.19	23.18	23.46		
			3	0	23.25	23.18	23.49		
			3	1	23.25	23.18	23.48		
			3	2	23.26	23.17	23.50		
			6	0	22.27	22.33	22.55		
		Antenna Gain (dBi):					2.00		
		Max. EIRP (dBm):					25.68		
		EIRP Limit (dBm):					30.00		
LTE Band	Bandwidth (MHz)	Modulation	RB Size	RB Offset	Average Power (dBm)				
					19965	20175	20385		
					1711.5MHz	1732.5MHz	1753.5MHz		
4	3	QPSK	1	0	24.34	24.31	24.64		
			1	7	24.33	24.30	24.71		
			1	14	24.39	24.27	24.73		
			8	0	23.35	23.33	23.64		
			8	4	23.33	23.32	23.65		
			8	7	23.36	23.33	23.62		
			15	0	23.32	23.30	23.61		
		Antenna Gain (dBi):					2.00		
		Max. EIRP (dBm):					26.73		
		EIRP Limit (dBm):					30.00		
		16QAM	1	0	23.35	23.35	23.46		
			1	7	23.39	23.33	23.46		
			1	14	23.38	23.32	23.46		
			8	0	22.31	22.35	22.61		
			8	4	22.31	22.36	22.61		
			8	7	22.36	22.34	22.64		
			15	0	22.37	22.31	22.57		
		Antenna Gain (dBi):					2.00		
		Max. EIRP (dBm):					25.46		
		EIRP Limit (dBm):					30.00		
<i>Note: EIRP (dBm) = Average power (dBm) + Antenna Gain (dBi).</i>									

LTE Band	Bandwidth (MHz)	Modulation	RB Size	RB Offset	Average Power (dBm)				
					19975	20175	20375		
					1712.5MHz	1732.5MHz	1752.5MHz		
4	5	QPSK	1	0	24.25	24.32	24.47		
			1	12	24.49	24.38	24.68		
			1	24	24.41	24.28	24.58		
			12	0	23.32	23.34	23.59		
			12	6	23.30	23.37	23.57		
			12	11	23.35	23.34	23.59		
			25	0	23.38	23.30	23.69		
		Antenna Gain (dBi):					2.00		
		Max. EIRP (dBm):					26.68		
		EIRP Limit (dBm):					30.00		
		16QAM	1	0	23.22	23.27	23.58		
			1	12	23.33	23.29	23.72		
			1	24	23.31	23.21	23.64		
			12	0	22.31	22.29	22.65		
			12	6	22.25	22.29	22.58		
			12	11	22.27	22.30	22.61		
			25	0	22.38	22.29	22.63		
		Antenna Gain (dBi):					2.00		
		Max. EIRP (dBm):					25.72		
		EIRP Limit (dBm):					30.00		
		LTE Band	Bandwidth (MHz)	Modulation	RB Size	RB Offset	Average Power (dBm)		
20000	20175						20350		
1715.0MHz	1732.5MHz						1750.0MHz		
4	10	QPSK	1	0	24.30	24.33	24.47		
			1	24	24.48	24.47	24.76		
			1	49	24.42	24.30	24.69		
			25	0	23.39	23.42	23.57		
			25	12	23.41	23.42	23.58		
			25	24	23.39	23.39	23.60		
			50	0	23.47	23.36	23.63		
		Antenna Gain (dBi):					2.00		
		Max. EIRP (dBm):					26.76		
		EIRP Limit (dBm):					30.00		
		16QAM	1	0	23.31	23.43	23.24		
			1	24	23.61	23.46	23.44		
			1	49	23.45	23.32	23.47		
			23	0	23.32	23.38	23.39		
			23	19	23.29	23.38	23.41		
			23	38	23.46	23.32	23.60		
			50	0	/	/	/		
		Antenna Gain (dBi):					2.00		
		Max. EIRP (dBm):					25.61		
		EIRP Limit (dBm):					30.00		
		<i>Note: EIRP (dBm) = Average power (dBm) + Antenna Gain (dBi).</i>							

LTE Band	Bandwidth (MHz)	Modulation	RB Size	RB Offset	Average Power (dBm)				
					20025	20175	20325		
					1717.5MHz	1732.5MHz	1747.5MHz		
4	15	QPSK	1	0	24.28	24.39	24.15		
			1	37	24.46	24.33	24.51		
			1	74	24.35	24.23	24.53		
			36	0	23.47	23.44	23.55		
			36	16	23.51	23.47	23.53		
			36	35	23.51	23.49	23.58		
			75	0	23.49	23.44	23.65		
		Antenna Gain (dBi):					2.00		
		Max. EIRP (dBm):					26.53		
		EIRP Limit (dBm):					30.00		
		16QAM	1	0	23.28	23.42	23.28		
			1	37	23.47	23.36	23.62		
			1	74	23.35	23.28	23.65		
			16	0	23.27	23.34	23.37		
			16	30	23.25	23.35	23.34		
			16	59	23.31	23.25	23.59		
			75	0	/	/	/		
		Antenna Gain (dBi):					2.00		
		Max. EIRP (dBm):					25.65		
		EIRP Limit (dBm):					30.00		
		LTE Band	Bandwidth (MHz)	Modulation	RB Size	RB Offset	Average Power (dBm)		
20050	20175						20300		
1720.0MHz	1732.5MHz						1745.0MHz		
4	20	QPSK	1	0	24.10	24.29	24.07		
			1	49	24.60	24.45	24.58		
			1	99	24.17	24.19	24.47		
			50	0	23.39	23.41	23.44		
			50	24	23.39	23.41	23.51		
			50	49	23.41	23.39	23.47		
			100	0	23.43	23.37	23.57		
		Antenna Gain (dBi):					2.00		
		Max. EIRP (dBm):					26.60		
		EIRP Limit (dBm):					30.00		
		16QAM	1	0	22.98	23.18	23.19		
			1	49	23.47	23.40	23.77		
			1	99	23.04	23.01	23.59		
			18	0	23.16	23.29	23.15		
			18	41	23.18	23.26	23.22		
			18	82	23.22	23.19	23.53		
			100	0	/	/	/		
		Antenna Gain (dBi):					2.00		
		Max. EIRP (dBm):					25.77		
		EIRP Limit (dBm):					30.00		
		Note: EIRP (dBm) = Average power (dBm) + Antenna Gain (dBi).							

LTE Band	Bandwidth (MHz)	Modulation	RB Size	RB Offset	Average Power (dBm)				
					23017	23095	23173		
					699.7MHz	707.5MHz	715.3MHz		
12	1.4	QPSK	1	0	24.32	24.37	24.20		
			1	2	24.43	24.50	24.29		
			1	5	24.35	24.40	24.16		
			3	0	24.40	24.44	24.28		
			3	1	24.35	24.39	24.27		
			3	2	24.38	24.41	24.28		
			6	0	23.40	23.41	23.23		
		Antenna Gain(dBi):					2.00		
		Max. ERP (dBm):					24.35		
		ERP Limit (dBm):					34.77		
		16QAM	1	0	23.29	23.20	22.93		
			1	2	23.40	23.40	23.12		
			1	5	23.31	23.17	22.96		
			3	0	23.20	23.23	23.03		
			3	1	23.19	23.24	23.01		
			3	2	23.17	23.24	23.03		
			6	0	22.34	22.23	22.19		
		Antenna Gain(dBi):					2.00		
		Max. ERP (dBm):					23.25		
		ERP Limit (dBm):					34.77		
		LTE Band	Bandwidth (MHz)	Modulation	RB Size	RB Offset	Average Power (dBm)		
23025	23095						23165		
700.5MHz	707.5MHz						714.5MHz		
12	3	QPSK	1	0	24.42	24.42	24.27		
			1	7	24.41	24.36	24.29		
			1	14	24.43	24.34	24.29		
			8	0	23.38	23.42	23.22		
			8	4	23.36	23.41	23.27		
			8	7	23.42	23.37	23.21		
			15	0	23.40	23.33	23.18		
		Antenna Gain(dBi):					2.00		
		Max. ERP (dBm):					24.28		
		ERP Limit (dBm):					34.77		
		16QAM	1	0	23.10	23.43	23.17		
			1	7	23.17	23.35	23.05		
			1	14	23.18	23.29	23.02		
			8	0	22.31	22.39	22.23		
			8	4	22.36	22.36	22.22		
			8	7	22.42	22.39	22.17		
			15	0	22.25	22.35	22.13		
		Antenna Gain(dBi):					2.00		
		Max. ERP (dBm):					23.28		
		ERP Limit (dBm):					34.77		
		Note: EIRP (dBm) = Average power (dBm) + Antenna Gain (dBi). ERP (dBm) = EIRP (dBm) - 2.15 (dB).							

LTE Band	Bandwidth (MHz)	Modulation	RB Size	RB Offset	Average Power (dBm)				
					23035	23095	23155		
					701.5MHz	707.5MHz	713.5MHz		
12	5	QPSK	1	0	24.37	24.35	24.23		
			1	12	24.48	24.40	24.33		
			1	24	24.43	24.23	24.19		
			12	0	23.33	23.39	23.37		
			12	6	23.35	23.46	23.26		
			12	11	23.31	23.37	23.36		
			25	0	23.37	23.38	23.29		
		Antenna Gain(dBi):					2.00		
		Max. ERP (dBm):					24.33		
		ERP Limit (dBm):					34.77		
		16QAM	1	0	23.29	23.41	23.10		
			1	12	23.43	23.50	23.24		
			1	24	23.33	23.38	23.11		
			12	0	22.28	22.47	22.28		
			12	6	22.33	22.41	22.28		
			12	11	22.29	22.42	22.29		
			25	0	22.38	22.37	22.20		
		Antenna Gain(dBi):					2.00		
		Max. ERP (dBm):					23.35		
ERP Limit (dBm):					34.77				
LTE Band	Bandwidth (MHz)	Modulation	RB Size	RB Offset	Average Power (dBm)				
					23060	23095	23130		
					704.0MHz	707.5MHz	711.0MHz		
12	10	QPSK	1	0	24.37	24.42	24.37		
			1	24	24.52	24.54	24.42		
			1	49	24.39	24.37	24.28		
			25	0	23.44	23.44	23.34		
			25	12	23.45	23.42	23.34		
			25	24	23.44	23.44	23.33		
			50	0	23.41	23.42	23.24		
		Antenna Gain(dBi):					2.00		
		Max. ERP (dBm):					24.39		
		ERP Limit (dBm):					34.77		
		16QAM	1	0	23.35	23.22	23.16		
			1	24	23.54	23.39	23.18		
			1	49	23.40	23.18	23.00		
			12	0	23.34	23.36	23.25		
			12	19	23.41	23.42	23.25		
			12	38	23.39	23.37	23.13		
			50	0	/	/	/		
		Antenna Gain(dBi):					2.00		
		Max. ERP (dBm):					23.39		
ERP Limit (dBm):					34.77				
<i>Note: EIRP (dBm) = Average power (dBm) + Antenna Gain (dBi).</i> <i>ERP (dBm) = EIRP (dBm) - 2.15 (dB).</i>									

LTE Band	Bandwidth (MHz)	Modulation	RB Size	RB Offset	Average Power (dBm)				
					23205	23230	23255		
					779.5MHz	782.0MHz	784.5MHz		
13	5	QPSK	1	0	24.59	24.65	24.52		
			1	12	24.72	24.72	24.59		
			1	24	24.59	24.50	24.45		
			12	0	23.70	23.65	23.47		
			12	6	23.72	23.64	23.49		
			12	11	23.64	23.63	23.53		
			25	0	23.70	23.72	23.51		
		Antenna Gain(dBi):					2.00		
		Max. ERP (dBm):					24.57		
		ERP Limit (dBm):					34.77		
		16QAM	1	0	23.52	23.55	23.48		
			1	12	23.69	23.62	23.61		
			1	24	23.54	23.41	23.34		
			12	0	22.62	22.68	22.42		
			12	6	22.61	22.61	22.43		
			12	11	22.61	22.62	22.43		
			25	0	22.70	22.72	22.54		
		Antenna Gain(dBi):					2.00		
		Max. ERP (dBm):					23.54		
		ERP Limit (dBm):					34.77		
LTE Band	Bandwidth (MHz)	Modulation	RB Size	RB Offset	Average Power (dBm)				
					23230	23230	23230		
					782.0MHz	782.0MHz	782.0MHz		
13	10	QPSK	1	0	/	24.64	/		
			1	24	/	24.75	/		
			1	49	/	24.15	/		
			25	0	/	23.52	/		
			25	12	/	23.32	/		
			25	24	/	23.28	/		
			50	0	/	23.28	/		
		Antenna Gain(dBi):					2.00		
		Max. ERP (dBm):					24.60		
		ERP Limit (dBm):					34.77		
		16QAM	1	0	/	22.98	/		
			1	24	/	23.09	/		
			1	49	/	22.87	/		
			12	0	/	23.20	/		
			12	19	/	23.17	/		
			12	38	/	23.07	/		
			50	0	/	/	/		
		Antenna Gain(dBi):					2.00		
		Max. ERP (dBm):					23.05		
		ERP Limit (dBm):					34.77		
<i>Note: EIRP (dBm) = Average power (dBm) + Antenna Gain (dBi).</i> <i>ERP (dBm) = EIRP (dBm) - 2.15 (dB).</i>									

LTE Band	Bandwidth (MHz)	Modulation	RB Size	RB Offset	Average Power (dBm)				
					23755	23790	23825		
					706.50MHz	710.00MHz	713.50MHz		
17	5	QPSK	1	0	24.50	24.49	24.38		
			1	12	24.43	24.46	24.54		
			1	24	24.08	24.42	24.36		
			12	0	23.06	23.4	23.45		
			12	6	23.01	23.46	23.4		
			12	11	23.36	23.46	23.46		
			25	0	23.44	23.44	23.41		
		Antenna Gain(dBi):					2.00		
		Max. ERP (dBm):					24.39		
		ERP Limit (dBm):					34.77		
		16QAM	1	0	23.53	23.26	23.3		
			1	12	23.34	23.15	23.4		
			1	24	23.02	23.29	23.25		
			12	0	22.07	22.43	22.37		
			12	6	22.08	22.45	22.37		
			12	11	22.31	22.43	22.4		
			25	0	22.17	22.49	22.4		
		Antenna Gain(dBi):					2.00		
		Max. ERP (dBm):					23.38		
		ERP Limit (dBm):					34.77		
		LTE Band	Bandwidth (MHz)	Modulation	RB Size	RB Offset	Average Power (dBm)		
23780	23790						23800		
709.00MHz	710.00MHz						711.00MHz		
17	10	QPSK	1	0	24.52	24.51	24.51		
			1	24	24.63	24.63	24.46		
			1	49	24.39	24.45	24.41		
			25	0	23.55	23.53	23.47		
			25	12	23.61	23.51	23.52		
			25	24	23.56	23.54	23.50		
			50	0	23.49	23.45	23.39		
		Antenna Gain(dBi):					2.00		
		Max. ERP (dBm):					24.48		
		ERP Limit (dBm):					34.77		
		16QAM	1	0	23.47	23.34	23.27		
			1	24	23.59	23.44	23.34		
			1	49	23.43	23.24	23.21		
			12	0	23.47	23.48	23.44		
			12	19	23.53	23.52	23.44		
			12	38	23.39	23.41	23.26		
			50	0	/	/	/		
		Antenna Gain(dBi):					2.00		
		Max. ERP (dBm):					23.44		
		ERP Limit (dBm):					34.77		
		Note: EIRP (dBm) = Average power (dBm) + Antenna Gain (dBi). ERP (dBm) = EIRP (dBm) - 2.15 (dB).							

6.2 Peak-to-Average Ratio

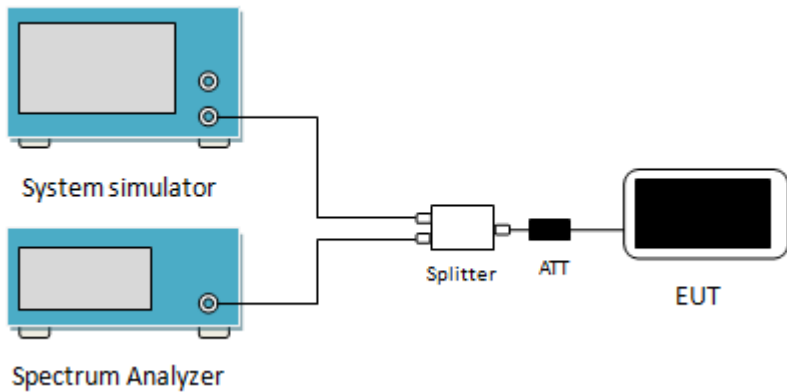
Test Requirement:	Part 24.232 (d), Part 27.50(d)(5)
Limit:	The peak-to-average ratio (PAR) of the transmission may not exceed 13 dB.
Test Setup:	 <p>The diagram shows a test setup for measuring Peak-to-Average Ratio (PAR). It consists of a System simulator and a Spectrum Analyzer connected to a Splitter. The Splitter is connected to an ATT (Attenuator), which is then connected to the EUT (Equipment Under Test).</p>
Test Procedure:	<ol style="list-style-type: none"> 1 The RF output of the transceiver was connected to a spectrum analyzer through appropriate attenuation. 2 Set the CCDF option in spectrum analyzer, $RBW \geq OBW$, 3 Set the EUT working in highest power level, measured and recorded the 0.1% as PAPR level. 4 Repeat step 1~3 at other frequency and modulations.
Test Instruments:	Refer to section 5.10 for details
Test mode:	Refer to section 5.3 for details
Test results:	Passed

Measurement Data: Refer to Appendix B – LTE

6.3 Occupy Bandwidth

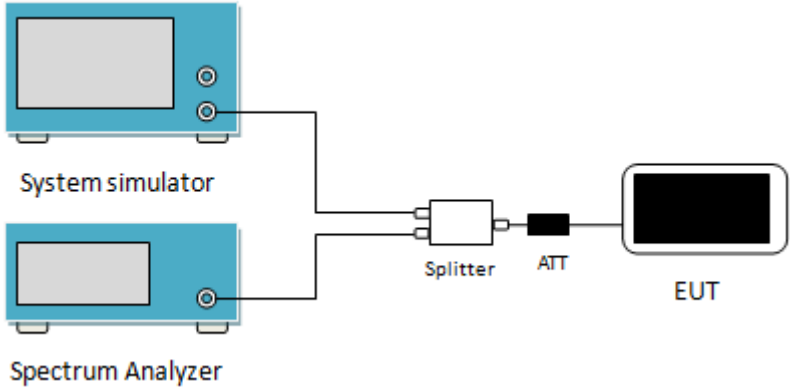
Test Requirement:	Part 24.238(b), Part 27.53(g), Part 27.53(h)
Test Setup:	 <p>The diagram shows a test setup for measuring Occupied Bandwidth. On the left, there are two blue rectangular units: the top one is labeled 'System simulator' and the bottom one is labeled 'Spectrum Analyzer'. Both have a single circular connector on their right side. These two connectors are connected to a single input of a white rectangular 'Splitter'. The other two outputs of the 'Splitter' are connected to a black rectangular 'ATT' (Attenuator) and a white rectangular 'EUT' (Equipment Under Test) respectively.</p>
Test Procedure:	<ol style="list-style-type: none"> 1. The EUT's output RF connector was connected with a short cable to the spectrum analyzer 2. RBW was set to about 1% ~ 5% of emission BW, VBW= 3 times RBW. 3. -26dBc display line was placed on the screen (or 99% bandwidth), the occupied bandwidth is the delta frequency between the two points where the display line intersects the signal trace.
Test Instruments:	Refer to section 5.10 for details
Test mode:	Refer to section 5.3 for details
Test results:	Passed

Measurement Data: Refer to Appendix C – LTE

6.4 Out of band emission at antenna terminals

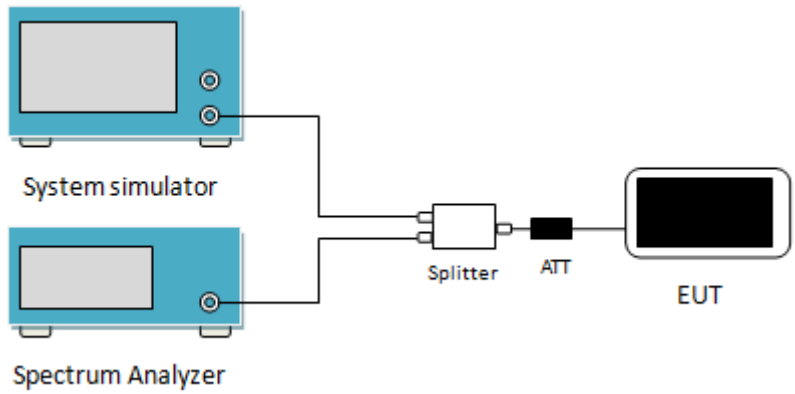
Test Requirement:	Part 22.917(a), Part 24.238 (a), part 27.53(g), part 27.53(h), Part 27.53(m)
Limit:	LTE Band 2 & 4 & 5 & 12 & 13 & 17: The power of any emission outside a licensee's frequency block shall be attenuated below the transmitter power (P) in watts by at least $43 + 10 \log_{10}(P)$ dB (-13 dBm).
Test Setup:	 <p>The diagram illustrates the test setup. On the left, there are two blue rectangular units: the top one is labeled 'System simulator' and the bottom one is labeled 'Spectrum Analyzer'. A cable connects the output of the System simulator to a white 'Splitter' box. From the splitter, one cable goes to the Spectrum Analyzer and another goes to a black 'ATT' (attenuator) block. Finally, a cable connects the ATT block to a black rectangular 'EUT' (Equipment Under Test) device.</p>
Test Procedure:	<ol style="list-style-type: none"> 1 The RF output of the transceiver was connected to a spectrum analyzer through appropriate attenuation. 2 For the out of band: For Band 5 & 12 & 17 set the RBW=100 kHz, VBW=300 kHz and for Band 2 & 4 & 7 set the RBW=1 MHz, VBW=3 MHz when below 1 GHz, RBW =1 MHz, VBW=3 MHz when above 1 GHz, Start=30MHz, Stop= 10th harmonic. 3 Band Edge Requirements: In the 1 MHz bands immediately outside and adjacent to the frequency block, a resolution bandwidth of at least 1 percent of the emission bandwidth of the fundamental emission of the transmitter may be employed to measure the out of band Emissions.
Test Instruments:	Refer to section 5.10 for details
Test mode:	Refer to section 5.3 for details
Test results:	Passed
Remark:	Pre-scan all RB Size and offset, and found the RB Size and offset of worst case, so the report shows only the worst case test data.

Measurement Data:

Spurious emission: Refer to Appendix E – LTE

**Band edge emission:
LTE Band 2 part:**

**LTE Band 2, BW: 1.4MHz
16QAM & RB Size 1**

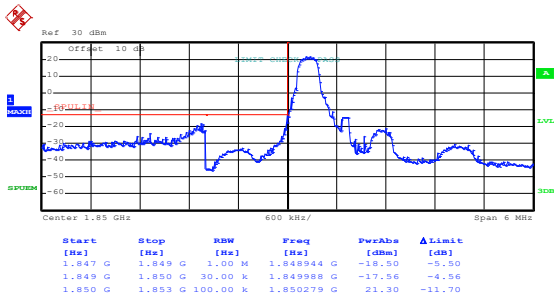

Lowest channel

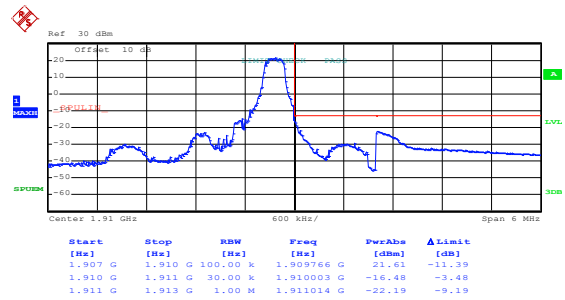

Highest channel

16QAM & RB Size 6

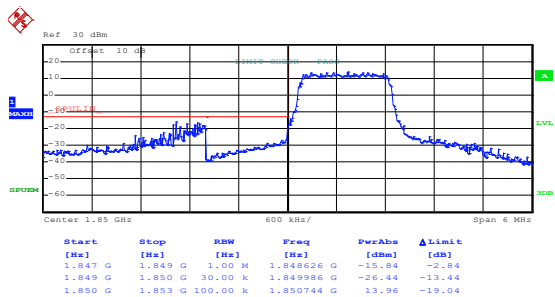

Lowest channel

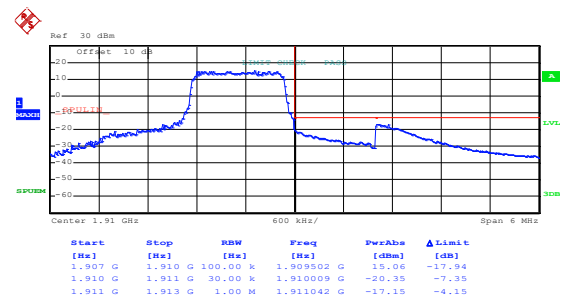

Highest channel

LTE Band 2, BW: 1.4MHz QPSK & RB Size 1

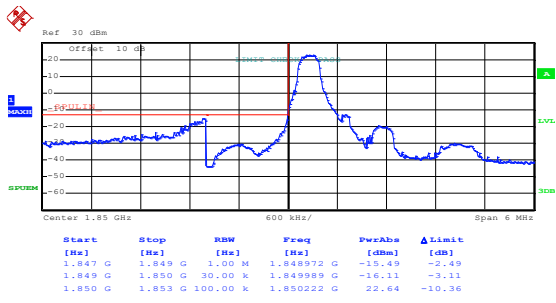

Lowest channel

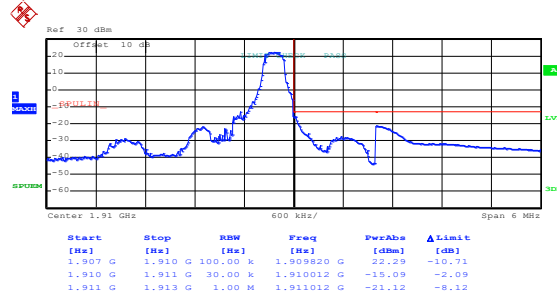

Highest channel

QPSK & RB Size 6

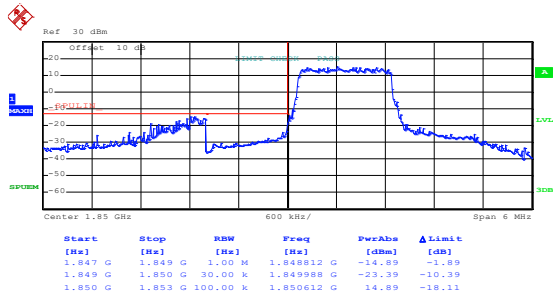

Lowest channel

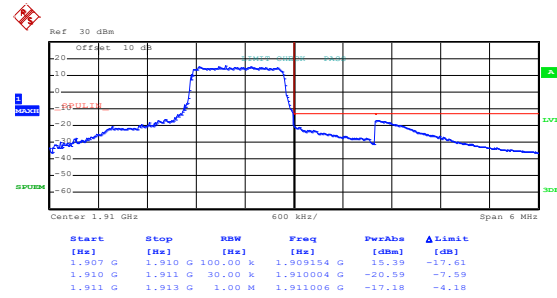

Highest channel

LTE Band 2, BW: 20MHz 16QAM & RB Size 1

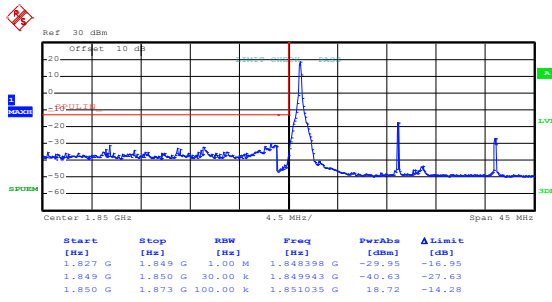

Lowest channel

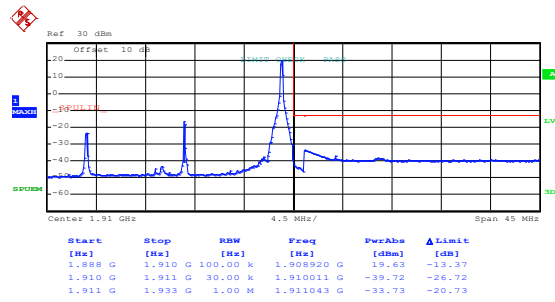

Highest channel

16QAM & RB Size 100

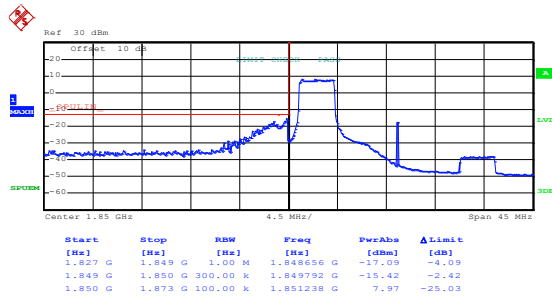

Lowest channel

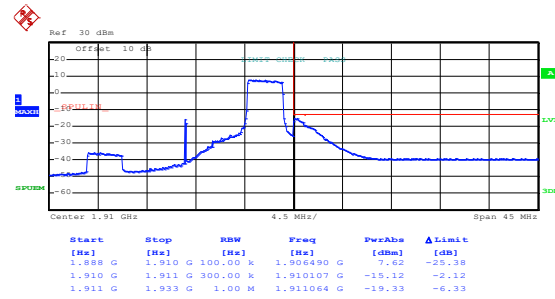

Highest channel

LTE Band 2, BW: 20MHz QPSK & RB Size 1

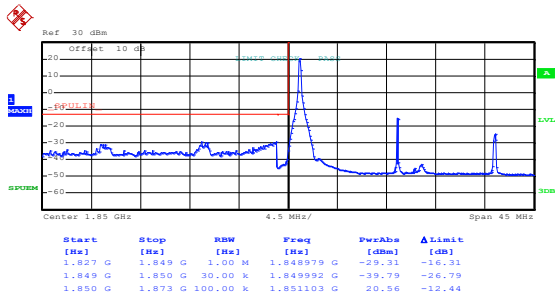

Lowest channel

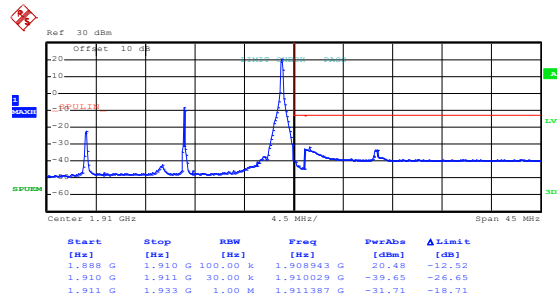

Highest channel

QPSK & RB Size 100

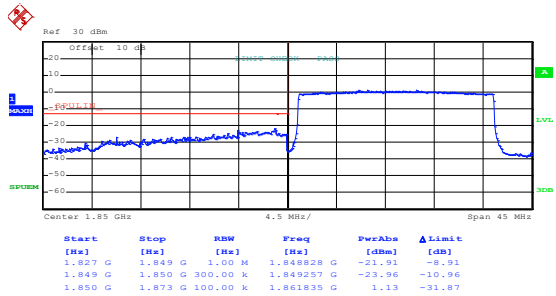

Lowest channel

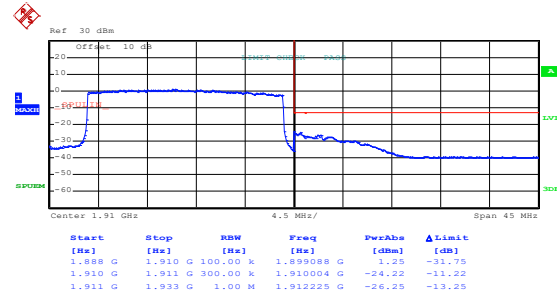

Highest channel

LTE Band 4 part:

LTE Band 4, BW: 1.4MHz
16QAM & RB Size 1

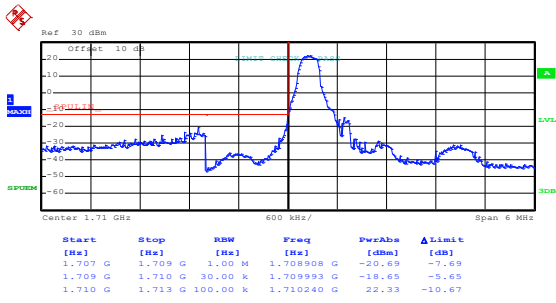

Lowest channel

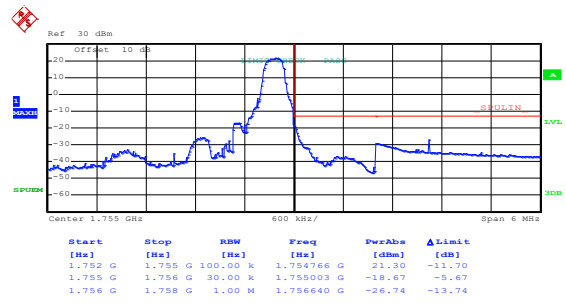

Highest channel

16QAM & RB Size 6

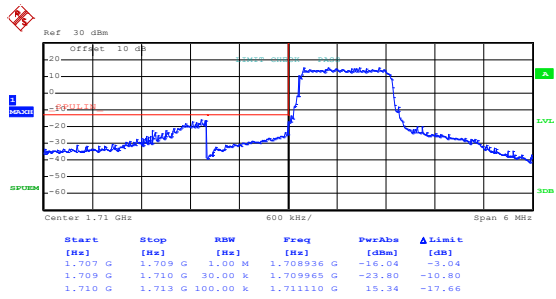

Lowest channel

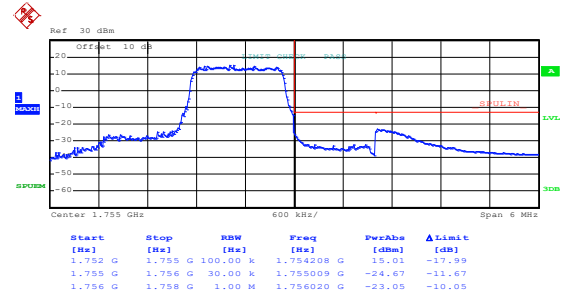

Highest channel

LTE Band 4, BW: 1.4MHz QPSK & RB Size 1

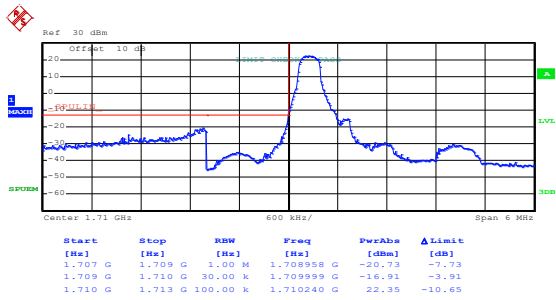

Lowest channel

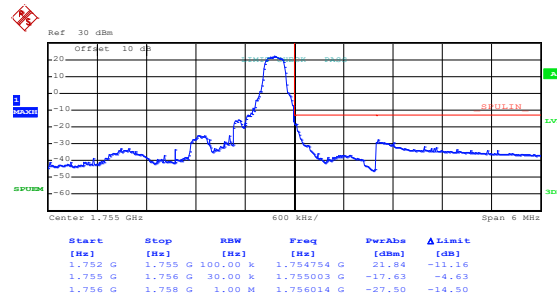

Highest channel

QPSK & RB Size 6

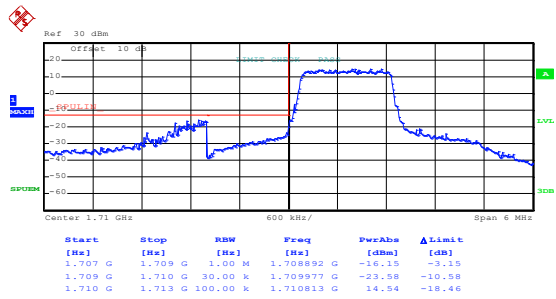

Lowest channel

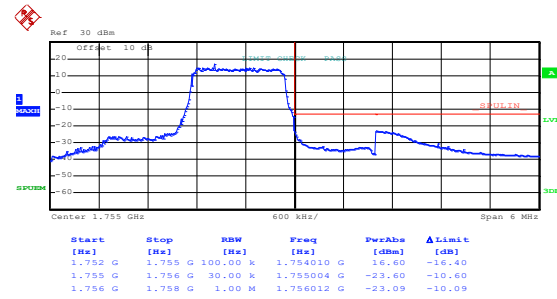

Highest channel

LTE Band 4, BW: 20MHz 16QAM & RB Size 1

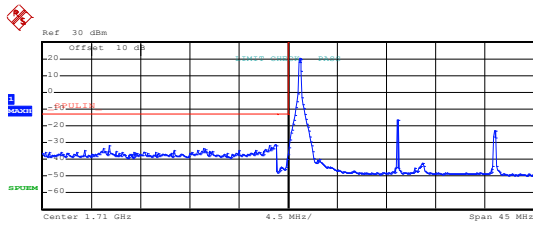

Start [Hz]	Stop [Hz]	RBW [Hz]	Freq [Hz]	PwrAbs [dBm]	ΔLimit [dB]
1.688 G	1.709 G	1.00 M	1.708828 G	-31.31	-18.31
1.709 G	1.710 G	30.00 k	1.709941 G	-39.98	-26.98
1.710 G	1.732 G	100.00 k	1.711057 G	20.53	-12.47

Lowest channel

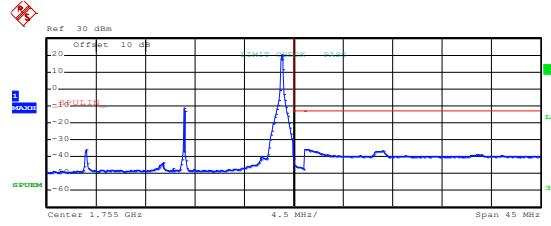

Start [Hz]	Stop [Hz]	RBW [Hz]	Freq [Hz]	PwrAbs [dBm]	ΔLimit [dB]
1.732 G	1.755 G	100.00 k	1.753943 G	20.37	-12.63
1.755 G	1.756 G	30.00 k	1.755022 G	-39.67	-26.67
1.756 G	1.778 G	1.00 M	1.756064 G	-35.52	-22.52

Highest channel

16QAM & RB Size 100

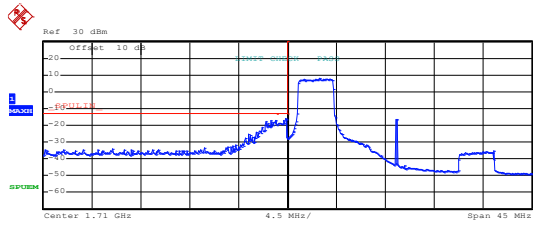

Start [Hz]	Stop [Hz]	RBW [Hz]	Freq [Hz]	PwrAbs [dBm]	ΔLimit [dB]
1.688 G	1.709 G	1.00 M	1.709000 G	-16.79	-2.79
1.709 G	1.710 G	300.00 k	1.709819 G	-15.92	-2.92
1.710 G	1.732 G	100.00 k	1.712925 G	8.02	-24.98

Lowest channel

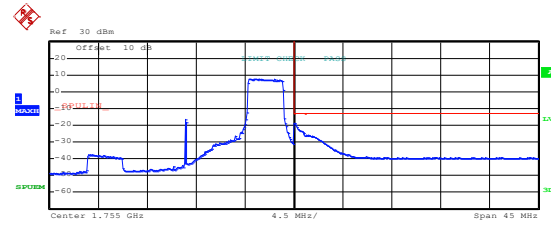

Start [Hz]	Stop [Hz]	RBW [Hz]	Freq [Hz]	PwrAbs [dBm]	ΔLimit [dB]
1.732 G	1.755 G	100.00 k	1.750328 G	7.75	-25.55
1.755 G	1.756 G	300.00 k	1.755053 G	-18.89	-5.89
1.756 G	1.778 G	1.00 M	1.756172 G	-25.88	-12.88

Highest channel

LTE Band 4, BW: 20MHz QPSK & RB Size 1

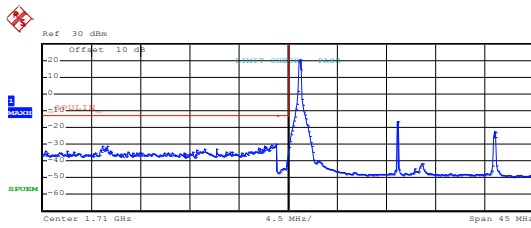

Start [Hz]	Stop [Hz]	RBW [Hz]	Freq [Hz]	PwrAbs [dBm]	ΔLimit [dB]
1.688 G	1.709 G	1.00 M	1.708871 G	-29.87	-16.87
1.709 G	1.710 G	30.00 K	1.709941 G	-40.54	-27.54
1.710 G	1.732 G	100.00 K	1.711057 G	20.43	-12.57

Lowest channel

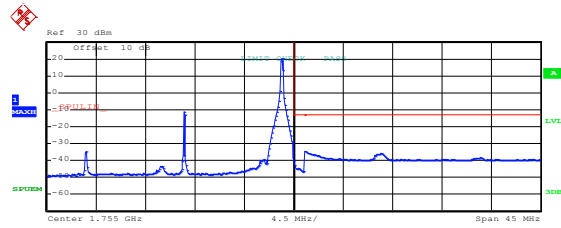

Start [Hz]	Stop [Hz]	RBW [Hz]	Freq [Hz]	PwrAbs [dBm]	ΔLimit [dB]
1.732 G	1.755 G	100.00 K	1.753920 G	20.46	-12.54
1.755 G	1.756 G	30.00 K	1.755006 G	-39.47	-26.47
1.756 G	1.778 G	1.00 M	1.756021 G	-34.42	-21.42

Highest channel

QPSK & RB Size 100

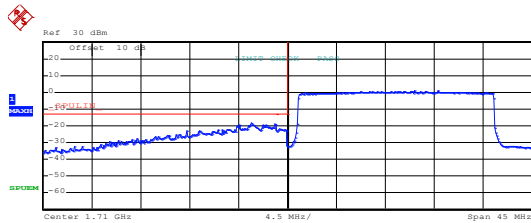

Start [Hz]	Stop [Hz]	RBW [Hz]	Freq [Hz]	PwrAbs [dBm]	ΔLimit [dB]
1.688 G	1.709 G	1.00 M	1.708835 G	-18.03	-5.03
1.709 G	1.710 G	300.00 K	1.709844 G	-21.03	-8.03
1.710 G	1.732 G	100.00 K	1.723883 G	0.79	-32.21

Lowest channel

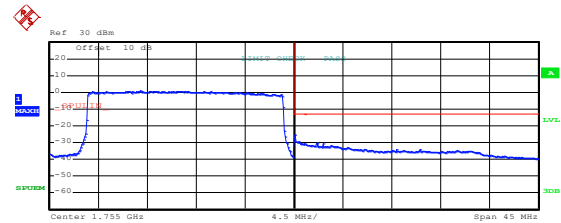

Start [Hz]	Stop [Hz]	RBW [Hz]	Freq [Hz]	PwrAbs [dBm]	ΔLimit [dB]
1.732 G	1.755 G	100.00 K	1.748870 G	1.00	-32.00
1.755 G	1.756 G	300.00 K	1.755069 G	-25.93	-12.93
1.756 G	1.778 G	1.00 M	1.757140 G	-29.93	-16.93

Highest channel

LTE band 12 part:

LTE Band 12, BW: 1.4MHz
16QAM & RB Size 1

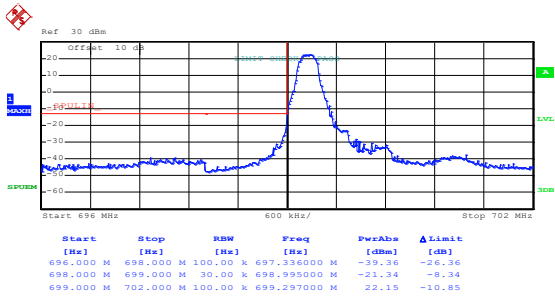

Lowest channel

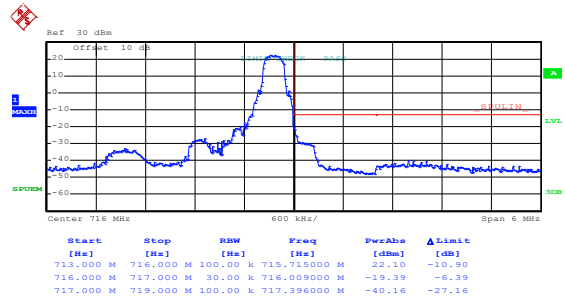

Highest channel

16QAM & RB Size 6

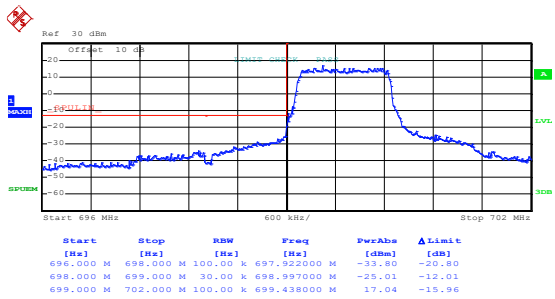

Lowest channel

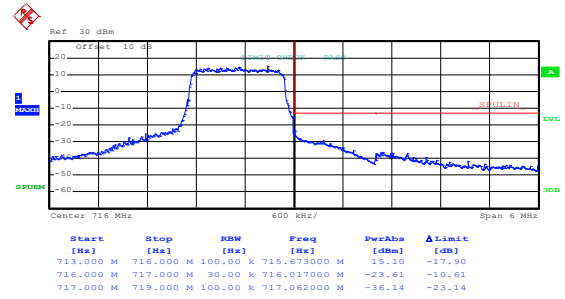

Highest channel

LTE Band 12, BW: 1.4MHz QPSK & RB Size 1

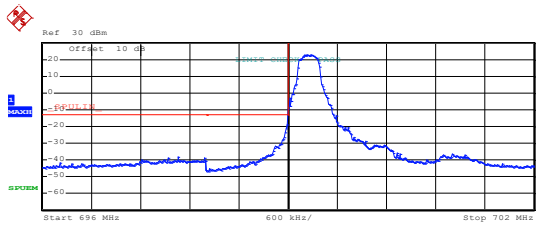

Start [Hz]	Stop [Hz]	RBW [Hz]	Freq [Hz]	PwrAbs [dBm]	ΔLimit [dB]
696.000 M	698.000 M	100.00 k	697.658000 M	-38.01	-25.01
698.000 M	699.000 M	30.00 k	698.991000 M	-18.72	-5.72
699.000 M	702.000 M	100.00 k	699.234000 M	22.88	-10.12

Lowest channel

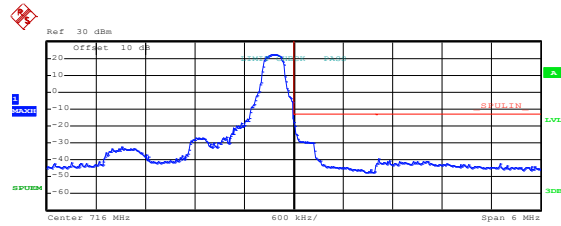

Start [Hz]	Stop [Hz]	RBW [Hz]	Freq [Hz]	PwrAbs [dBm]	ΔLimit [dB]
713.000 M	716.000 M	100.00 k	716.763000 M	22.37	-10.63
716.000 M	717.000 M	30.00 k	716.005000 M	-18.06	-5.06
717.000 M	719.000 M	100.00 k	717.028000 M	-39.33	-26.33

Highest channel

QPSK & RB Size 6

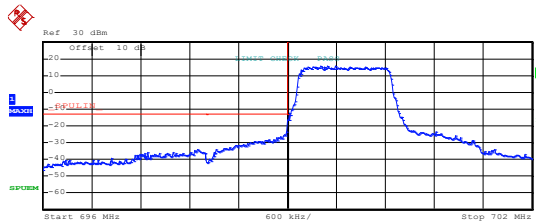

Start [Hz]	Stop [Hz]	RBW [Hz]	Freq [Hz]	PwrAbs [dBm]	ΔLimit [dB]
696.000 M	698.000 M	100.00 k	697.894000 M	-34.32	-21.32
698.000 M	699.000 M	30.00 k	698.999000 M	-23.64	-10.64
699.000 M	702.000 M	100.00 k	699.486000 M	15.83	-17.17

Lowest channel

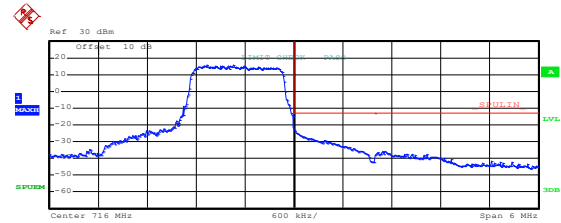

Start [Hz]	Stop [Hz]	RBW [Hz]	Freq [Hz]	PwrAbs [dBm]	ΔLimit [dB]
713.000 M	716.000 M	100.00 k	716.929000 M	15.81	-17.19
716.000 M	717.000 M	30.00 k	716.003000 M	-22.34	-9.34
717.000 M	719.000 M	100.00 k	717.094000 M	-35.91	-22.91

Highest channel

LTE Band 12, BW: 10MHz 16QAM & RB Size 1

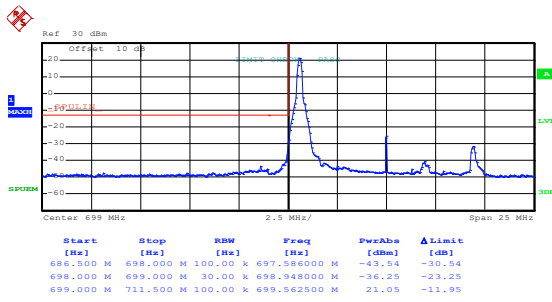

Lowest channel

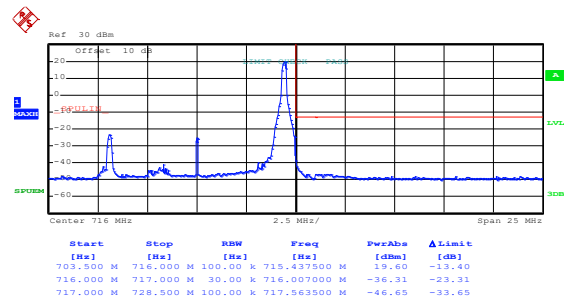

Highest channel

16QAM & RB Size 50

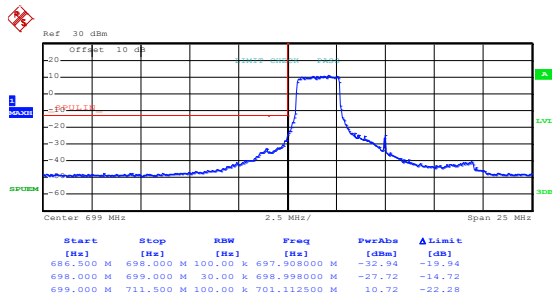

Lowest channel

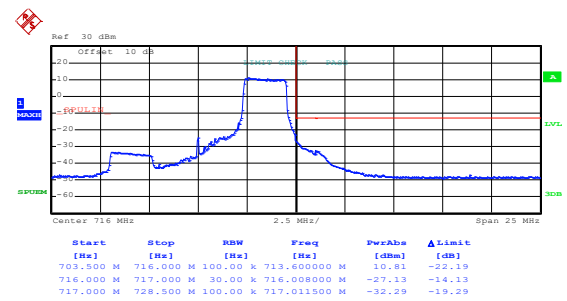

Highest channel

LTE Band 12, BW: 10MHz QPSK & RB Size 1

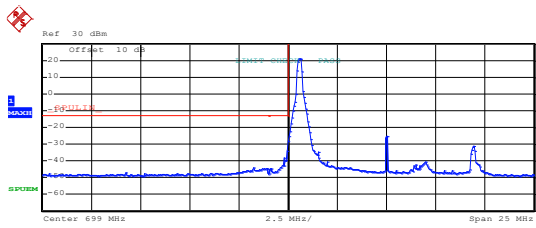

Start [Hz]	Stop [Hz]	RBW [Hz]	Freq [Hz]	PwrAbs [dBm]	ΔLimit [dB]
696.500 M	698.000 M	100.00 k	697.218000 M	-44.11	-31.11
698.000 M	699.000 M	30.00 k	698.990000 M	-24.25	-21.25
699.000 M	711.500 M	100.00 k	699.612500 M	21.12	-11.88

Lowest channel

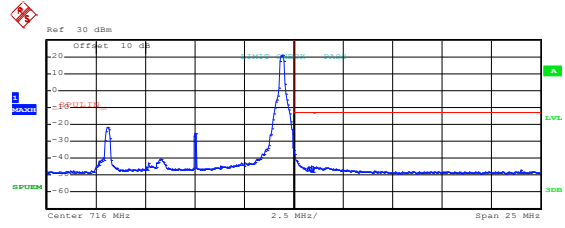

Start [Hz]	Stop [Hz]	RBW [Hz]	Freq [Hz]	PwrAbs [dBm]	ΔLimit [dB]
703.500 M	716.000 M	100.00 k	719.429000 M	21.14	-11.86
716.000 M	717.000 M	30.00 k	716.006000 M	-34.89	-21.89
717.000 M	728.500 M	100.00 k	717.126500 M	-44.95	-31.95

Highest channel

QPSK & RB Size 50

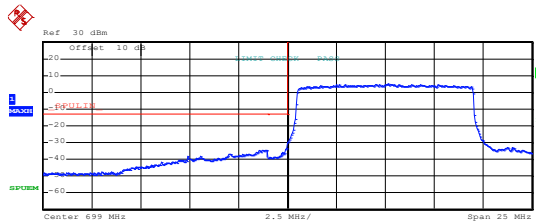

Start [Hz]	Stop [Hz]	RBW [Hz]	Freq [Hz]	PwrAbs [dBm]	ΔLimit [dB]
696.500 M	698.000 M	100.00 k	697.908000 M	-34.36	-21.36
698.000 M	699.000 M	30.00 k	698.985000 M	-32.41	-20.41
699.000 M	711.500 M	100.00 k	704.150000 M	5.06	-27.94

Lowest channel

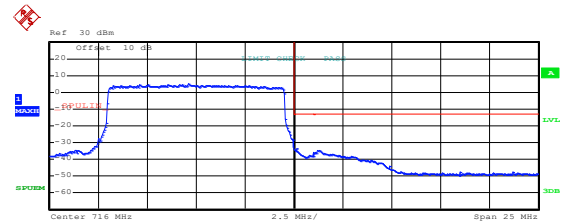

Start [Hz]	Stop [Hz]	RBW [Hz]	Freq [Hz]	PwrAbs [dBm]	ΔLimit [dB]
703.500 M	716.000 M	100.00 k	710.600000 M	4.86	-28.14
716.000 M	717.000 M	30.00 k	716.004000 M	-33.28	-20.28
717.000 M	728.500 M	100.00 k	717.207000 M	-34.45	-21.45

Highest channel

LTE band 13 part:

LTE Band 13, BW: 1.4MHz
16QAM & RB Size 1

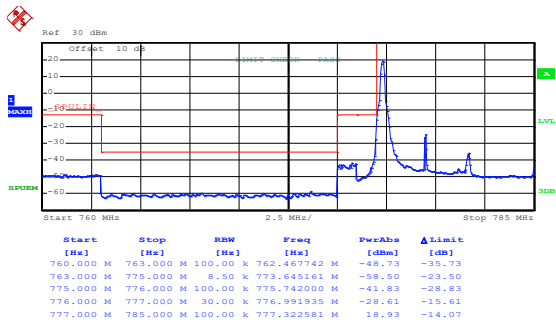

Lowest channel

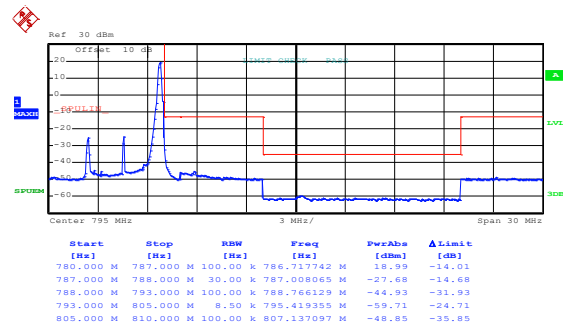

Highest channel

16QAM & RB Size 25

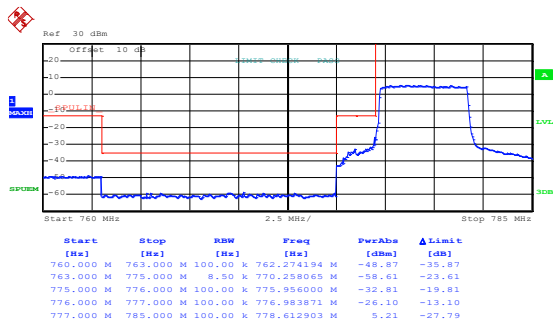

Lowest channel

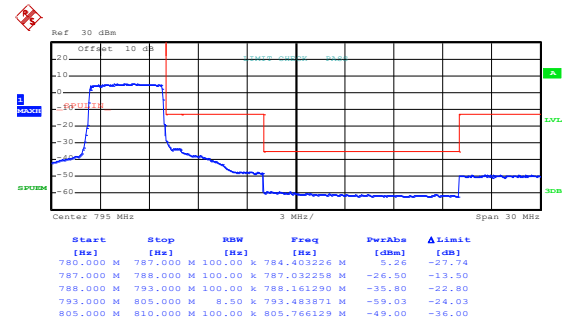

Highest channel

LTE Band 13, BW: 1.4MHz QPSK & RB Size 1

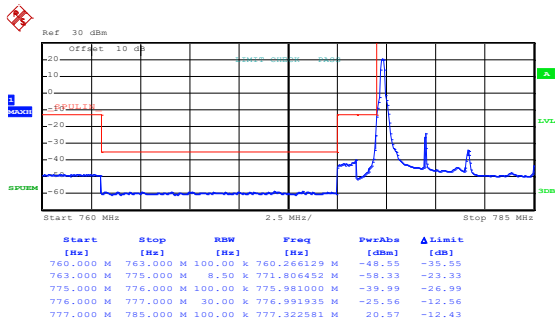

Lowest channel

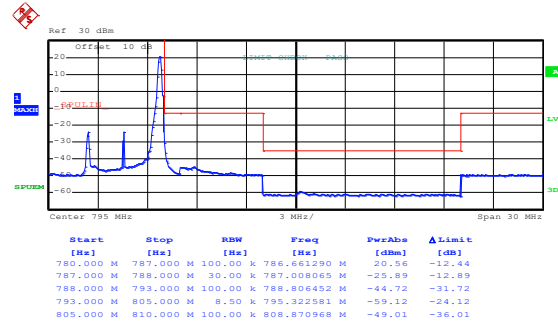

Highest channel

QPSK & RB Size 25

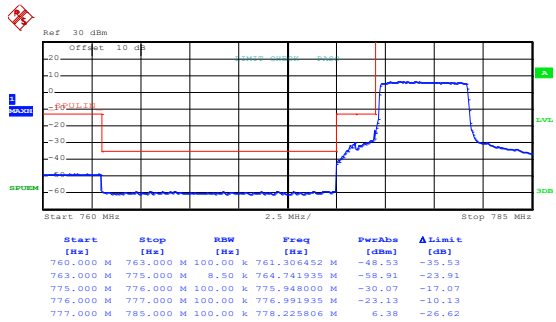

Lowest channel

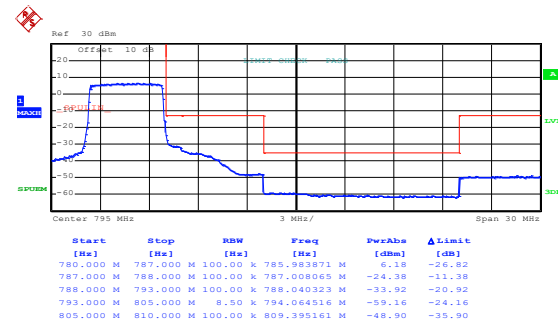

Highest channel

LTE Band 13, BW: 10MHz

16QAM & RB Size 1

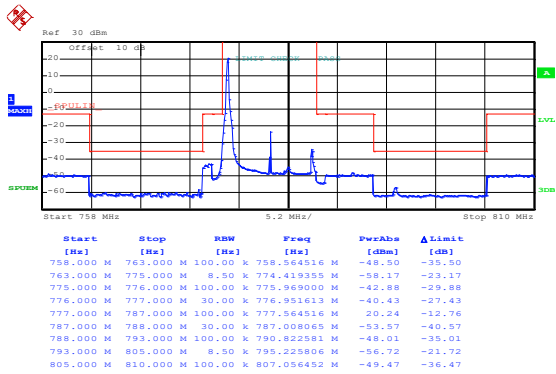

Middle channel

16QAM & RB Size 49

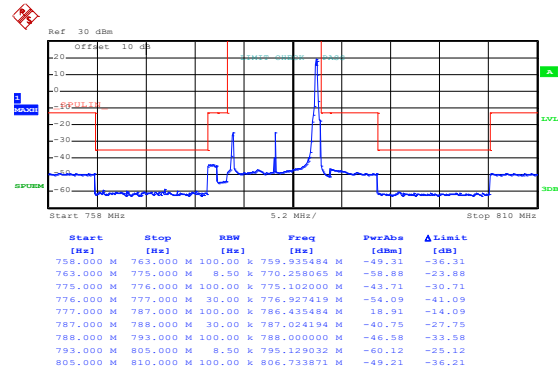

Middle channel

16QAM & RB Size 12

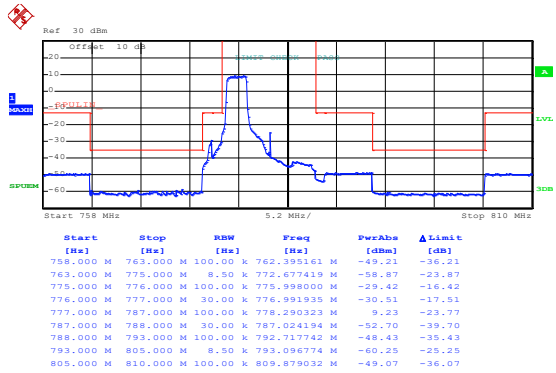

Middle channel

16QAM & RB Size 38

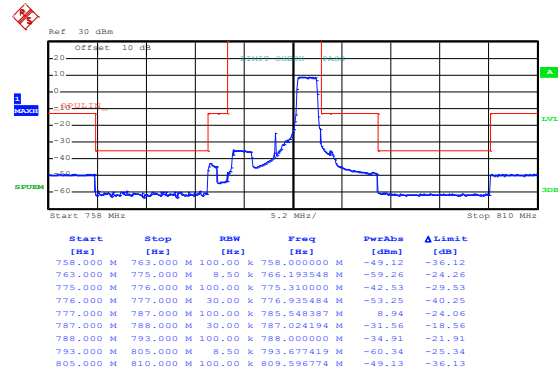

Middle channel

LTE Band 13, BW: 10MHz

QPSK & RB Size 1

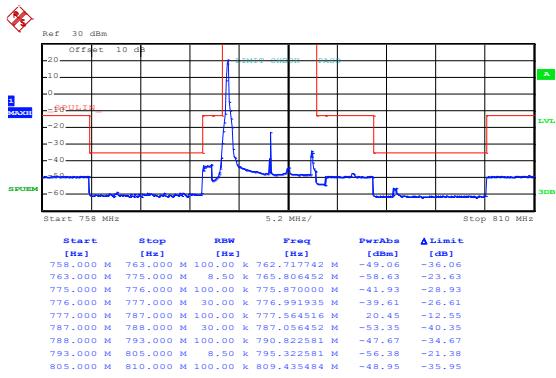

Middle channel

QPSK & RB Size 49

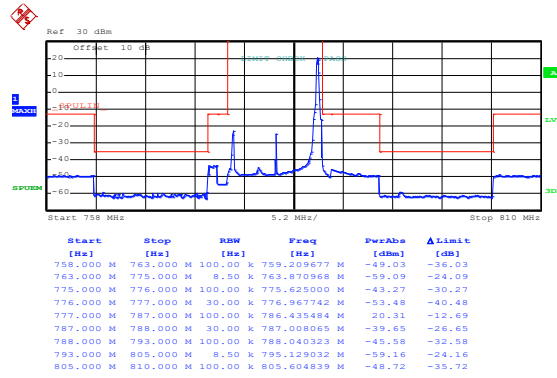

Middle channel

QPSK & RB Size 50

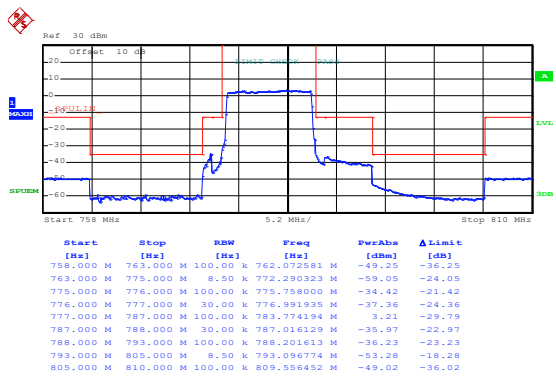

Middle channel

LTE band 17 part:

LTE Band 17, BW: 5MHz
16QAM & RB Size 1

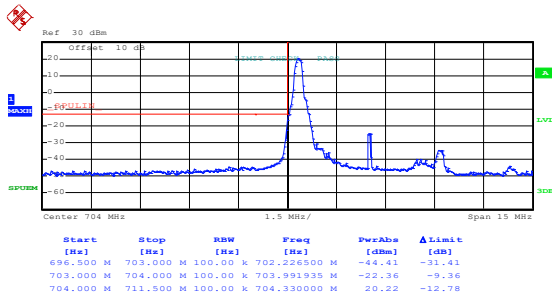

Lowest channel

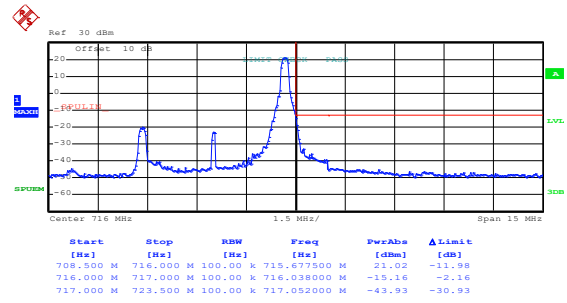

Highest channel

16QAM & RB Size 25

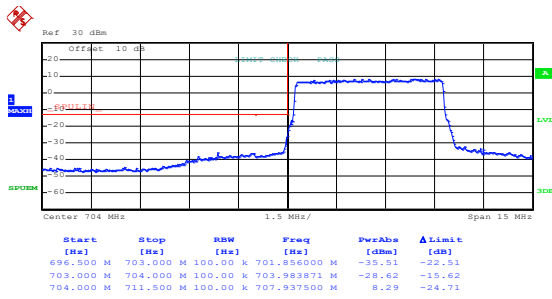

Lowest channel

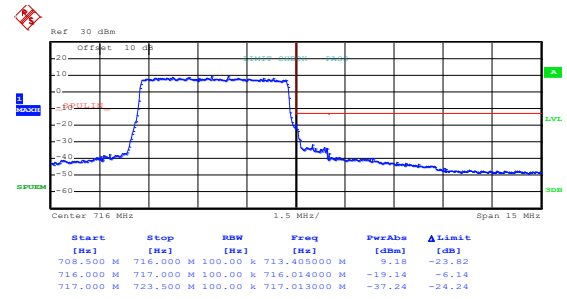

Highest channel

LTE Band 17, BW: 5MHz QPSK & RB Size 1

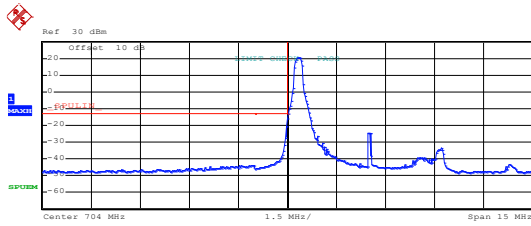

Start [Hz]	Stop [Hz]	RBW [Hz]	Freq [Hz]	PwrAbs [dBm]	ΔLimit [dB]
696.500 M	703.000 M	100.00 k	702.512500 M	-43.82	-30.82
703.000 M	704.000 M	100.00 k	703.991935 M	-21.89	-8.89
704.000 M	711.500 M	100.00 k	704.345000 M	20.53	-12.47

Lowest channel

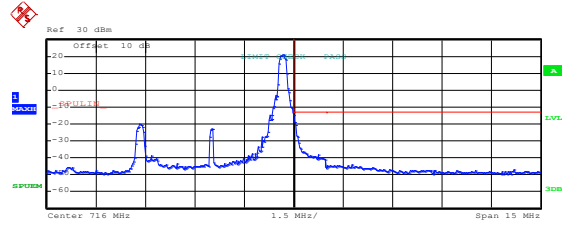

Start [Hz]	Stop [Hz]	RBW [Hz]	Freq [Hz]	PwrAbs [dBm]	ΔLimit [dB]
708.500 M	716.000 M	100.00 k	715.685000 M	20.79	-12.21
716.000 M	717.000 M	100.00 k	716.005000 M	-14.11	-1.11
717.000 M	723.500 M	100.00 k	717.754000 M	-44.12	-31.12

Highest channel

QPSK & RB Size 25

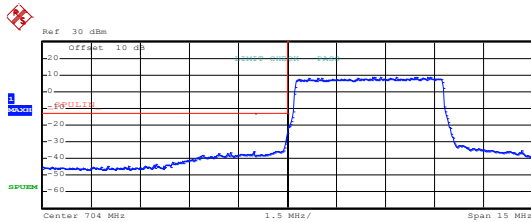

Start [Hz]	Stop [Hz]	RBW [Hz]	Freq [Hz]	PwrAbs [dBm]	ΔLimit [dB]
696.500 M	703.000 M	100.00 k	702.980500 M	-35.78	-22.78
703.000 M	704.000 M	100.00 k	703.991935 M	-28.44	-15.44
704.000 M	711.500 M	100.00 k	706.850000 M	8.82	-24.18

Lowest channel

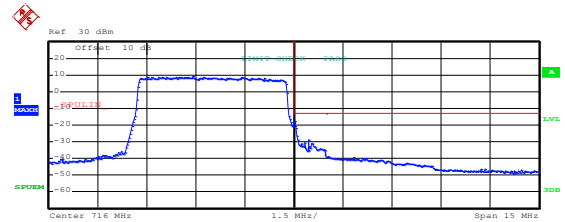

Start [Hz]	Stop [Hz]	RBW [Hz]	Freq [Hz]	PwrAbs [dBm]	ΔLimit [dB]
708.500 M	716.000 M	100.00 k	712.895000 M	9.06	-23.94
716.000 M	717.000 M	100.00 k	716.016000 M	-17.51	-4.51
717.000 M	723.500 M	100.00 k	717.058500 M	-38.32	-25.32

Highest channel

LTE Band 17, BW: 10MHz 16QAM & RB Size 1

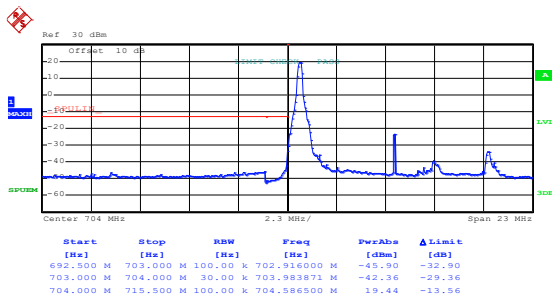

Lowest channel

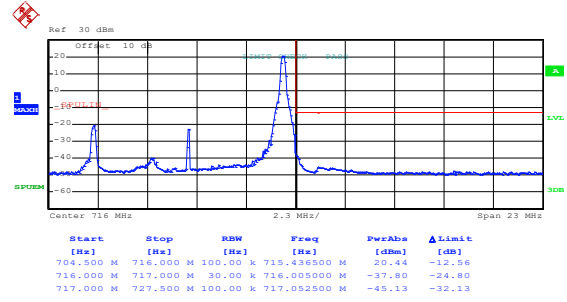

Highest channel

16QAM & RB Size 12

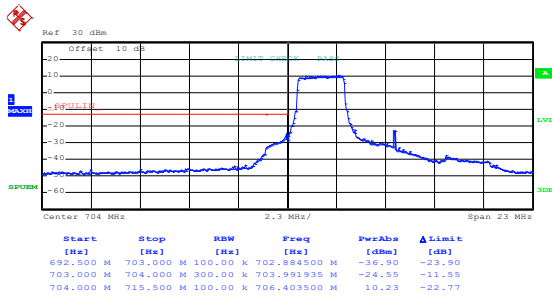

Lowest channel

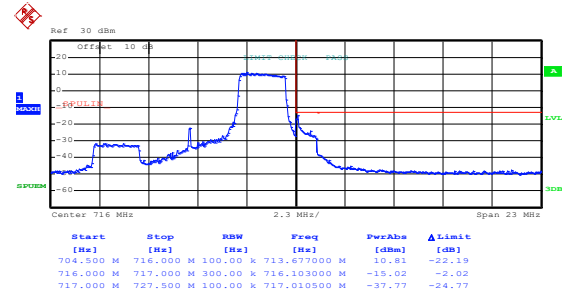

Highest channel

LTE Band 17, BW: 10MHz QPSK & RB Size 1

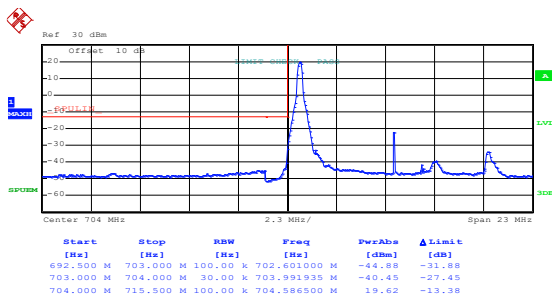

Lowest channel

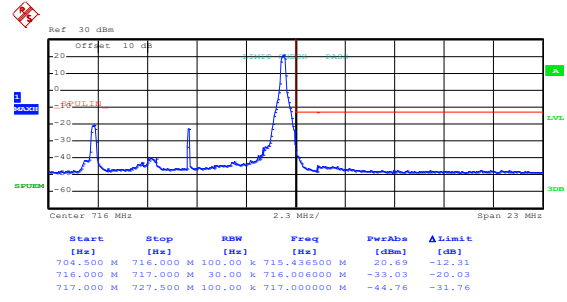

Highest channel

QPSK & RB Size 50

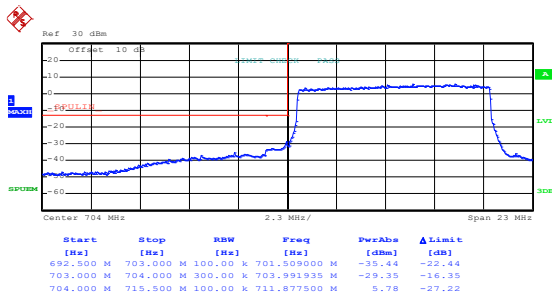

Lowest channel

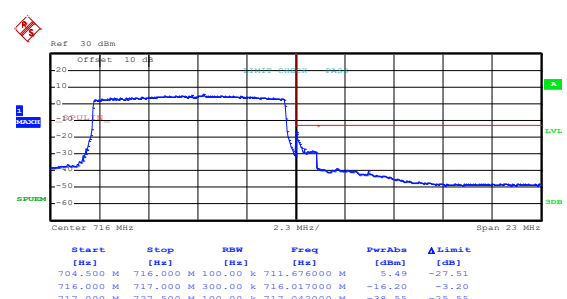

Highest channel

6.5 Field strength of spurious radiation measurement

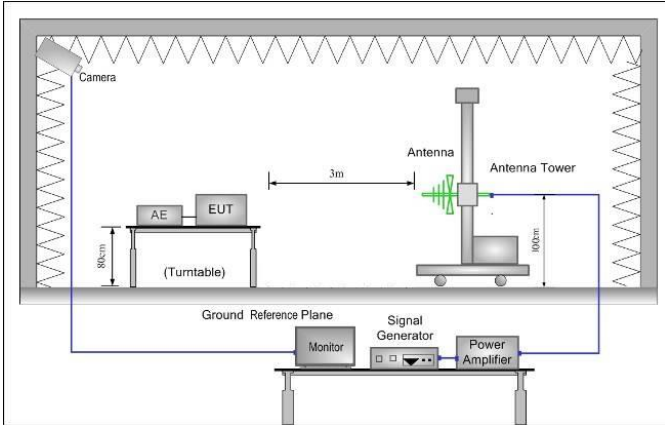
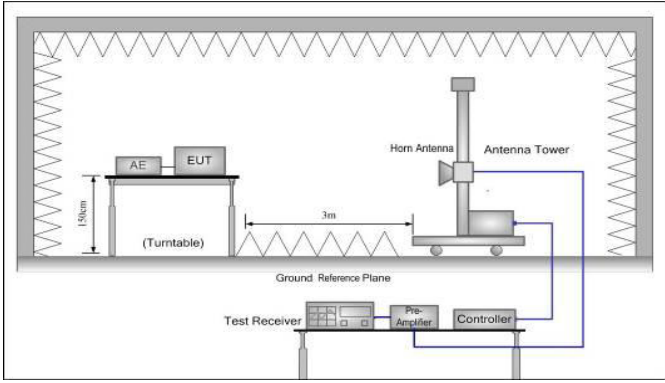
<p>Test Requirement:</p>	<p>Part 24.238 (a), Part 27.53(g), Part 27.53(m),</p>
<p>Limit:</p>	<p>LTE Band 2 & 4 & 12 & 17: The power of any emission outside a licensee's frequency block shall be attenuated below the transmitter power (P) in watts by at least $43 + 10 \log_{10}(P)$ dB (-13 dBm). LTE Band 13: The power of any emission shall be attenuated outside the band below the transmitter power (P) by at least $43 + 10 \log(P)$ dB(-13 dBm). For operations in the 746-758 MHz, 775-788 MHz, and 805-806 MHz bands, emissions in the band 1559-1610 MHz shall be limited to -70 dBW/MHz equivalent isotropically radiated power (EIRP) for wideband signals.</p>
<p>Test setup:</p>	<p>Below 1GHz</p>  <p>Above 1GHz</p> 
<p>Test Procedure:</p>	<ol style="list-style-type: none"> 1. The EUT was placed on the top of a rotating table 0.8m(below 1GHz)/1.5m(above 1GHz) above the ground at a 3 meter camber. The radiated emission at the fundamental frequency was measured at 3 m with a test antenna and EMI spectrum analyzer. 2. During the tests, the antenna height and the EUT azimuth were varied in order to identify the maximum level of emissions from the EUT. This maximization process was repeated with the EUT positioned in each of its three orthogonal orientations. 3. The frequency range up to tenth harmonic was investigated for each of three fundamental frequency (low, middle and high channels). Once spurious emission was identified, the power of the emission was determined using the substitution method. 4. The spurious emissions attenuation was calculated as the difference between radiated power at the fundamental frequency and the spurious emissions frequency. $ERP / EIRP = S.G. \text{ output (dBm)} + \text{Antenna Gain(dB/dBi)} - \text{Cable}$

	Loss (dB)
Test Instruments:	Refer to section 5.10 for details
Test mode:	Refer to section 5.3 for details.
Test results:	Passed

Measurement Data:

Band 2 (1.4MHz)							
Lowest channel							
Frequency (MHz)	Level at antenna terminals (dBm)	Substitute antenna gain (dBi)	Cable Loss (dBi)	Spurious Emission level (dBm)	Limit Line (dBm)	Over Limit (dBm)	Polarization
3701.40	-57.41	12.64	0.75	-45.52	-13.00	-32.52	Vertical
5552.10	-58.02	12.76	1.13	-46.39	-13.00	-33.39	Vertical
7402.00	-48.58	11.44	1.63	-38.77	-13.00	-25.77	Vertical
3701.40	-57.40	12.64	0.75	-45.51	-13.00	-32.51	Horizontal
5552.10	-58.92	12.76	1.13	-47.29	-13.00	-34.29	Horizontal
7402.00	-46.33	11.44	1.63	-36.52	-13.00	-23.52	Horizontal
Middle channel							
Frequency (MHz)	Level at antenna terminals (dBm)	Substitute antenna gain (dBi)	Cable Loss (dBi)	Spurious Emission level (dBm)	Limit Line (dBm)	Over Limit (dBm)	Polarization
3760.00	-59.07	12.71	0.79	-47.15	-13.00	-34.15	Vertical
5640.00	-55.24	12.87	1.15	-43.52	-13.00	-30.52	Vertical
7520.00	-49.77	11.48	1.66	-39.95	-13.00	-26.95	Vertical
3760.00	-57.43	12.71	0.79	-45.51	-13.00	-32.51	Horizontal
5640.00	-59.60	12.87	1.15	-47.88	-13.00	-34.88	Horizontal
7520.00	-48.41	11.48	1.66	-38.59	-13.00	-25.59	Horizontal
Highest channel							
Frequency (MHz)	Level at antenna terminals (dBm)	Substitute antenna gain (dBi)	Cable Loss (dBi)	Spurious Emission level (dBm)	Limit Line (dBm)	Over Limit (dBm)	Polarization
3816.60	-58.62	12.78	0.81	-46.65	-13.00	-33.65	Vertical
5724.90	-58.96	12.97	1.19	-47.18	-13.00	-34.18	Vertical
7633.20	-49.58	11.34	1.71	-39.95	-13.00	-26.95	Vertical
3816.60	-59.83	12.78	0.81	-47.86	-13.00	-34.86	Horizontal
5724.90	-60.29	12.97	1.19	-48.51	-13.00	-35.51	Horizontal
7633.20	-51.89	11.34	1.71	-42.26	-13.00	-29.26	Horizontal
<i>Remark:</i> The emission levels of below 1 GHz are lower than the limit 20dB and not show in test report.							

Band 2 (20MHz)							
Lowest channel							
Frequency (MHz)	Level at antenna terminals (dBm)	Substitute antenna gain (dBi)	Cable Loss (dBi)	Spurious Emission level (dBm)	Limit Line (dBm)	Over Limit (dBm)	Polarization
3720.00	-58.54	12.66	0.77	-46.65	-13.00	-33.65	Vertical
5580.00	-59.46	12.80	1.15	-47.81	-13.00	-34.81	Vertical
7440.00	-48.47	11.46	1.64	-38.65	-13.00	-25.65	Vertical
3720.00	-58.51	12.66	0.77	-46.62	-13.00	-33.62	Horizontal
5580.00	-53.83	12.80	1.15	-42.18	-13.00	-29.18	Horizontal
7440.00	-48.52	11.46	1.64	-38.70	-13.00	-25.70	Horizontal
Middle channel							
Frequency (MHz)	Level at antenna terminals (dBm)	Substitute antenna gain (dBi)	Cable Loss (dBi)	Spurious Emission level (dBm)	Limit Line (dBm)	Over Limit (dBm)	Polarization
3760.00	-58.57	12.71	0.79	-46.65	-13.00	-33.65	Vertical
5640.00	-59.24	12.87	1.15	-47.52	-13.00	-34.52	Vertical
7520.00	-54.01	11.48	1.66	-44.19	-13.00	-31.19	Vertical
3760.00	-60.77	12.71	0.79	-48.85	-13.00	-35.85	Horizontal
5640.00	-57.29	12.87	1.15	-45.57	-13.00	-32.57	Horizontal
7520.00	-53.18	11.48	1.66	-43.36	-13.00	-30.36	Horizontal
Highest channel							
Frequency (MHz)	Level at antenna terminals (dBm)	Substitute antenna gain (dBi)	Cable Loss (dBi)	Spurious Emission level (dBm)	Limit Line (dBm)	Over Limit (dBm)	Polarization
3800.00	-57.49	12.76	0.79	-45.52	-13.00	-32.52	Vertical
5700.00	-56.87	12.94	1.18	-45.11	-13.00	-32.11	Vertical
7600.00	-55.21	11.38	1.69	-45.52	-13.00	-32.52	Vertical
3800.00	-59.82	12.76	0.79	-47.85	-13.00	-34.85	Horizontal
5700.00	-58.29	12.94	1.18	-46.53	-13.00	-33.53	Horizontal
7600.00	-54.86	11.38	1.69	-45.17	-13.00	-32.17	Horizontal
<i>Remark:</i>							
<i>The emission levels of below 1 GHz are lower than the limit 20dB and not show in test report.</i>							

LTE Band 4 part:

Band 4 (1.4MHz)							
Lowest channel							
Frequency (MHz)	Level at antenna terminals (dBm)	Substitute antenna gain (dBi)	Cable Loss (dBi)	Spurious Emission level (dBm)	Limit Line (dBm)	Over Limit (dBm)	Polarization
3421.40	-58.23	12.24	0.70	-46.69	-13.00	-33.69	Vertical
5132.10	-59.76	12.92	1.01	-47.85	-13.00	-34.85	Vertical
6842.80	-51.01	11.42	1.53	-41.12	-13.00	-28.12	Vertical
3421.40	-57.42	12.24	0.70	-45.88	-13.00	-32.88	Horizontal
5132.10	-56.64	12.92	1.01	-44.73	-13.00	-31.73	Horizontal
6842.80	-48.18	11.42	1.53	-38.29	-13.00	-25.29	Horizontal
Middle channel							
Frequency (MHz)	Level at antenna terminals (dBm)	Substitute antenna gain (dBi)	Cable Loss (dBi)	Spurious Emission level (dBm)	Limit Line (dBm)	Over Limit (dBm)	Polarization
3465.00	-61.46	12.33	0.72	-49.85	-13.00	-36.85	Vertical
5197.50	-57.36	12.88	1.04	-45.52	-13.00	-32.52	Vertical
6930.00	-47.20	11.30	1.56	-37.46	-13.00	-24.46	Vertical
3465.00	-59.76	12.33	0.72	-48.15	-13.00	-35.15	Horizontal
5197.50	-57.61	12.88	1.04	-45.77	-13.00	-32.77	Horizontal
6930.00	-46.03	11.30	1.56	-36.29	-13.00	-23.29	Horizontal
Highest channel							
Frequency (MHz)	Level at antenna terminals (dBm)	Substitute antenna gain (dBi)	Cable Loss (dBi)	Spurious Emission level (dBm)	Limit Line (dBm)	Over Limit (dBm)	Polarization
3508.60	-57.19	12.41	0.74	-45.52	-13.00	-32.52	Vertical
5262.90	-58.92	12.84	1.07	-47.15	-13.00	-34.15	Vertical
7017.20	-49.58	11.21	1.58	-39.95	-13.00	-26.95	Vertical
3508.60	-57.54	12.41	0.74	-45.87	-13.00	-32.87	Horizontal
5262.90	-58.10	12.84	1.07	-46.33	-13.00	-33.33	Horizontal
7017.20	-52.14	11.21	1.58	-42.51	-13.00	-29.51	Horizontal
<p><i>Remark:</i> The emission levels of below 1 GHz are lower than the limit 20dB and not show in test report.</p>							

Band 4 (20MHz)							
Lowest channel							
Frequency (MHz)	Level at antenna terminals (dBm)	Substitute antenna gain (dBi)	Cable Loss (dBi)	Spurious Emission level (dBm)	Limit Line (dBm)	Over Limit (dBm)	Polarization
3440.00	-60.83	12.28	0.71	-49.26	-13.00	-36.26	Vertical
5160.00	-57.52	12.90	1.03	-45.65	-13.00	-32.65	Vertical
6880.00	-52.34	11.37	1.54	-42.51	-13.00	-29.51	Vertical
3440.00	-55.82	12.28	0.71	-44.25	-13.00	-31.25	Horizontal
5160.00	-53.05	12.90	1.03	-41.18	-13.00	-28.18	Horizontal
6880.00	-49.80	11.37	1.54	-39.97	-13.00	-26.97	Horizontal
Middle channel							
Frequency (MHz)	Level at antenna terminals (dBm)	Substitute antenna gain (dBi)	Cable Loss (dBi)	Spurious Emission level (dBm)	Limit Line (dBm)	Over Limit (dBm)	Polarization
3465.00	-57.13	12.33	0.72	-45.52	-13.00	-32.52	Vertical
5197.50	-58.03	12.88	1.04	-46.19	-13.00	-33.19	Vertical
6930.00	-55.51	11.30	1.56	-45.77	-13.00	-32.77	Vertical
3465.00	-56.90	12.33	0.72	-45.29	-13.00	-32.29	Horizontal
5197.50	-55.13	12.88	1.04	-43.29	-13.00	-30.29	Horizontal
6930.00	-49.52	11.30	1.56	-39.78	-13.00	-26.78	Horizontal
Highest channel							
Frequency (MHz)	Level at antenna terminals (dBm)	Substitute antenna gain (dBi)	Cable Loss (dBi)	Spurious Emission level (dBm)	Limit Line (dBm)	Over Limit (dBm)	Polarization
3490.00	-61.17	12.38	0.73	-49.52	-13.00	-36.52	Vertical
5235.00	-59.61	12.86	1.06	-47.81	-13.00	-34.81	Vertical
6980.00	-55.18	11.23	1.57	-45.52	-13.00	-32.52	Vertical
3490.00	-58.27	12.38	0.73	-46.62	-13.00	-33.62	Horizontal
5235.00	-56.99	12.86	1.06	-45.19	-13.00	-32.19	Horizontal
6980.00	-48.43	11.23	1.57	-38.77	-13.00	-25.77	Horizontal
<i>Remark:</i>							
<i>The emission levels of below 1 GHz are lower than the limit 20dB and not show in test report.</i>							

Band 5 (1.4MHz)							
Lowest channel							
Frequency (MHz)	Level at antenna terminals (dBm)	Substitute antenna gain (dBi)	Cable Loss (dBi)	Spurious Emission level (dBm)	Limit Line (dBm)	Over Limit (dBm)	Polarization
1649.40	-56.02	9.57	0.20	-46.65	-13.00	-33.65	Vertical
2474.10	-58.28	10.86	0.43	-47.85	-13.00	-34.85	Vertical
3298.80	-46.53	12.00	0.64	-35.17	-13.00	-22.17	Vertical
1649.40	-54.14	9.57	0.20	-44.77	-13.00	-31.77	Horizontal
2474.10	-53.01	10.86	0.43	-42.58	-13.00	-29.58	Horizontal
3298.80	-51.27	12.00	0.64	-39.91	-13.00	-26.91	Horizontal
Middle channel							
Frequency (MHz)	Level at antenna terminals (dBm)	Substitute antenna gain (dBi)	Cable Loss (dBi)	Spurious Emission level (dBm)	Limit Line (dBm)	Over Limit (dBm)	Polarization
1673.30	-56.06	9.66	0.22	-46.62	-13.00	-33.62	Vertical
2509.50	-56.26	10.91	0.46	-45.81	-13.00	-32.81	Vertical
3346.00	-51.20	12.09	0.66	-39.77	-13.00	-26.77	Vertical
1673.30	-58.00	9.66	0.22	-48.56	-13.00	-35.56	Horizontal
2509.50	-55.18	10.91	0.46	-44.73	-13.00	-31.73	Horizontal
3346.00	-50.35	12.09	0.66	-38.92	-13.00	-25.92	Horizontal
Highest channel							
Frequency (MHz)	Level at antenna terminals (dBm)	Substitute antenna gain (dBi)	Cable Loss (dBi)	Spurious Emission level (dBm)	Limit Line (dBm)	Over Limit (dBm)	Polarization
1696.60	-57.36	9.74	0.23	-47.85	-13.00	-34.85	Vertical
2544.90	-59.78	10.94	0.49	-49.33	-13.00	-36.33	Vertical
3393.20	-53.09	12.19	0.68	-41.58	-13.00	-28.58	Vertical
1696.60	-56.30	9.74	0.23	-46.79	-13.00	-33.79	Horizontal
2544.90	-56.26	10.94	0.49	-45.81	-13.00	-32.81	Horizontal
3393.20	-53.08	12.19	0.68	-41.57	-13.00	-28.57	Horizontal
Remark: The emission levels of below 1 GHz are lower than the limit 20dB and not show in test report.							

Band 5 (10MHz)							
Lowest channel							
Frequency (MHz)	Level at antenna terminals (dBm)	Substitute antenna gain (dBi)	Cable Loss (dBi)	Spurious Emission level (dBm)	Limit Line (dBm)	Over Limit (dBm)	Polarization
1658.00	-57.20	9.60	0.21	-47.81	-13.00	-34.81	Vertical
2487.00	-55.98	10.88	0.45	-45.55	-13.00	-32.55	Vertical
3316.00	-50.00	12.03	0.65	-38.62	-13.00	-25.62	Vertical
1658.00	-54.58	9.60	0.21	-45.19	-13.00	-32.19	Horizontal
2487.00	-52.16	10.88	0.45	-41.73	-13.00	-28.73	Horizontal
3316.00	-51.23	12.03	0.65	-39.85	-13.00	-26.85	Horizontal
Middle channel							
Frequency (MHz)	Level at antenna terminals (dBm)	Substitute antenna gain (dBi)	Cable Loss (dBi)	Spurious Emission level (dBm)	Limit Line (dBm)	Over Limit (dBm)	Polarization
1673.30	-56.10	9.66	0.21	-46.65	-13.00	-33.65	Vertical
2509.50	-55.96	10.91	0.46	-45.51	-13.00	-32.51	Vertical
3346.00	-49.32	12.09	0.66	-37.89	-13.00	-24.89	Vertical
1673.30	-54.96	9.66	0.21	-45.51	-13.00	-32.51	Horizontal
2509.50	-53.84	10.91	0.46	-43.39	-13.00	-30.39	Horizontal
3346.00	-52.30	12.09	0.66	-40.87	-13.00	-27.87	Horizontal
Highest channel							
Frequency (MHz)	Level at antenna terminals (dBm)	Substitute antenna gain (dBi)	Cable Loss (dBi)	Spurious Emission level (dBm)	Limit Line (dBm)	Over Limit (dBm)	Polarization
1688.00	-59.33	9.71	0.23	-49.85	-13.00	-36.85	Vertical
2532.00	-56.97	10.93	0.48	-46.52	-13.00	-33.52	Vertical
3376.00	-50.99	12.15	0.67	-39.51	-13.00	-26.51	Vertical
1688.00	-57.29	9.71	0.23	-47.81	-13.00	-34.81	Horizontal
2532.00	-56.00	10.93	0.48	-45.55	-13.00	-32.55	Horizontal
3376.00	-49.37	12.15	0.67	-37.89	-13.00	-24.89	Horizontal
<i>Remark:</i>							
<i>The emission levels of below 1 GHz are lower than the limit 20dB and not show in test report.</i>							

LTE Band 12 part:

Band 12 (1.4MHz)							
Lowest channel							
Frequency (MHz)	Level at antenna terminals (dBm)	Substitute antenna gain (dBi)	Cable Loss (dBi)	Spurious Emission level (dBm)	Limit Line (dBm)	Over Limit (dBm)	Polarization
1399.40	-55.54	7.80	0.11	-47.85	-13.00	-34.85	Vertical
2099.10	-56.67	10.34	0.29	-46.62	-13.00	-33.62	Vertical
2798.80	-47.86	11.20	0.53	-37.19	-13.00	-24.19	Vertical
1399.40	-54.34	7.80	0.11	-46.65	-13.00	-33.65	Horizontal
2099.10	-57.56	10.34	0.29	-47.51	-13.00	-34.51	Horizontal
2798.80	-49.14	11.20	0.53	-38.47	-13.00	-25.47	Horizontal
Middle channel							
Frequency (MHz)	Level at antenna terminals (dBm)	Substitute antenna gain (dBi)	Cable Loss (dBi)	Spurious Emission level (dBm)	Limit Line (dBm)	Over Limit (dBm)	Polarization
1415.00	-54.48	7.92	0.13	-46.69	-13.00	-33.69	Vertical
2122.50	-58.57	10.37	0.32	-48.52	-13.00	-35.52	Vertical
2830.00	-47.87	11.23	0.55	-37.19	-13.00	-24.19	Vertical
1415.00	-53.66	7.92	0.13	-45.87	-13.00	-32.87	Horizontal
2122.50	-52.24	10.37	0.32	-42.19	-13.00	-29.19	Horizontal
2830.00	-46.20	11.23	0.55	-35.52	-13.00	-22.52	Horizontal
Highest channel							
Frequency (MHz)	Level at antenna terminals (dBm)	Substitute antenna gain (dBi)	Cable Loss (dBi)	Spurious Emission level (dBm)	Limit Line (dBm)	Over Limit (dBm)	Polarization
1430.60	-54.57	8.04	0.16	-46.69	-13.00	-33.69	Vertical
2145.90	-57.86	10.40	0.35	-47.81	-13.00	-34.81	Vertical
2861.20	-53.26	11.26	0.58	-42.58	-13.00	-29.58	Vertical
1430.60	-55.79	8.04	0.16	-47.91	-13.00	-34.91	Horizontal
2145.90	-55.94	10.40	0.35	-45.89	-13.00	-32.89	Horizontal
2861.20	-50.09	11.26	0.58	-39.41	-13.00	-26.41	Horizontal
<i>Remark:</i>							
<i>The emission levels of below 1 GHz are lower than the limit 20dB and not show in test report.</i>							

Band 12 (10MHz)							
Lowest channel							
Frequency (MHz)	Level at antenna terminals (dBm)	Substitute antenna gain (dBi)	Cable Loss (dBi)	Spurious Emission level (dBm)	Limit Line (dBm)	Over Limit (dBm)	Polarization
1408.00	-53.72	7.86	0.12	-45.98	-13.00	-32.98	Vertical
2112.00	-57.22	10.36	0.30	-47.16	-13.00	-34.16	Vertical
2816.00	-50.53	11.22	0.54	-39.85	-13.00	-26.85	Vertical
1408.00	-56.26	7.86	0.12	-48.52	-13.00	-35.52	Horizontal
2112.00	-54.21	10.36	0.30	-44.15	-13.00	-31.15	Horizontal
2816.00	-48.47	11.22	0.54	-37.79	-13.00	-24.79	Horizontal
Middle channel							
Frequency (MHz)	Level at antenna terminals (dBm)	Substitute antenna gain (dBi)	Cable Loss (dBi)	Spurious Emission level (dBm)	Limit Line (dBm)	Over Limit (dBm)	Polarization
1415.00	-53.31	7.92	0.13	-45.52	-13.00	-32.52	Vertical
2122.50	-59.23	10.37	0.32	-49.18	-13.00	-36.18	Vertical
2830.00	-53.25	11.23	0.55	-42.57	-13.00	-29.57	Vertical
1415.00	-54.98	7.92	0.13	-47.19	-13.00	-34.19	Horizontal
2122.50	-55.32	10.37	0.32	-45.27	-13.00	-32.27	Horizontal
2830.00	-55.79	11.23	0.55	-45.11	-13.00	-32.11	Horizontal
Highest channel							
Frequency (MHz)	Level at antenna terminals (dBm)	Substitute antenna gain (dBi)	Cable Loss (dBi)	Spurious Emission level (dBm)	Limit Line (dBm)	Over Limit (dBm)	Polarization
1422.00	-53.35	7.98	0.15	-45.52	-13.00	-32.52	Vertical
2133.00	-53.44	10.39	0.34	-43.39	-13.00	-30.39	Vertical
2844.00	-49.41	11.24	0.57	-38.74	-13.00	-25.74	Vertical
1422.00	-54.52	7.98	0.15	-46.69	-13.00	-33.69	Horizontal
2133.00	-57.16	10.39	0.34	-47.11	-13.00	-34.11	Horizontal
2844.00	-49.24	11.24	0.57	-38.57	-13.00	-25.57	Horizontal
Remark: <i>The emission levels of below 1 GHz are lower than the limit 20dB and not show in test report.</i>							

LTE Band 13 part:

Band 13 (5MHz)							
Lowest channel							
Frequency (MHz)	Level at antenna terminals (dBm)	Substitute antenna gain (dBi)	Cable Loss (dBi)	Spurious Emission level (dBm)	Limit Line (dBm)	Over Limit (dBm)	Polarization
1559.00	-54.08	9.07	0.17	-45.18	-40.00	-5.18	Vertical
2338.50	-54.46	10.67	0.40	-44.19	-13.00	-31.19	Vertical
3118.00	-46.74	11.64	0.59	-35.69	-13.00	-22.69	Vertical
1559.00	-54.41	9.07	0.17	-45.51	-40.00	-5.51	Horizontal
2338.50	-56.93	10.67	0.40	-46.66	-13.00	-33.66	Horizontal
3118.00	-50.83	11.64	0.59	-39.78	-13.00	-26.78	Horizontal
Middle channel							
Frequency (MHz)	Level at antenna terminals (dBm)	Substitute antenna gain (dBi)	Cable Loss (dBi)	Spurious Emission level (dBm)	Limit Line (dBm)	Over Limit (dBm)	Polarization
1564.00	-53.45	9.11	0.18	-44.52	-40.00	-4.52	Vertical
2346.00	-57.47	10.68	0.40	-47.19	-13.00	-34.19	Vertical
3128.00	-46.35	11.66	0.60	-35.29	-13.00	-22.29	Vertical
1564.00	-57.22	9.11	0.18	-48.29	-40.00	-8.29	Horizontal
2346.00	-58.05	10.68	0.40	-47.77	-13.00	-34.77	Horizontal
3128.00	-46.23	11.66	0.60	-35.17	-13.00	-22.17	Horizontal
Highest channel							
Frequency (MHz)	Level at antenna terminals (dBm)	Substitute antenna gain (dBi)	Cable Loss (dBi)	Spurious Emission level (dBm)	Limit Line (dBm)	Over Limit (dBm)	Polarization
1569.00	-56.78	9.15	0.18	-47.81	-40.00	-7.81	Vertical
2353.50	-56.87	10.69	0.41	-46.59	-13.00	-33.59	Vertical
3138.00	-49.83	11.68	0.61	-38.76	-13.00	-25.76	Vertical
1569.00	-56.12	9.15	0.18	-47.15	-40.00	-7.15	Horizontal
2353.50	-55.80	10.69	0.41	-45.52	-13.00	-32.52	Horizontal
3138.00	-47.26	11.68	0.61	-36.19	-13.00	-23.19	Horizontal
Remark: The emission levels of below 1 GHz are lower than the limit 20dB and not show in test report.							

Band 13 (10MHz)							
Middle channel							
Frequency (MHz)	Level at antenna terminals (dBm)	Substitute antenna gain (dBi)	Cable Loss (dBi)	Spurious Emission level (dBm)	Limit Line (dBm)	Over Limit (dBm)	Polarization
1564.00	-56.58	9.11	0.18	-47.65	-40.00	-7.65	Vertical
2346.00	-55.80	10.68	0.40	-45.52	-13.00	-32.52	Vertical
3128.00	-48.62	11.66	0.60	-37.56	-13.00	-24.56	Vertical
1564.00	-50.81	9.11	0.18	-41.88	-40.00	-1.88	Horizontal
2346.00	-49.43	10.68	0.40	-39.15	-13.00	-26.15	Horizontal
3128.00	-41.24	11.66	0.60	-30.18	-13.00	-17.18	Horizontal

Remark:
The emission levels of below 1 GHz are lower than the limit 20dB and not show in test report.

Band 17 (5MHz)							
Lowest channel							
Frequency (MHz)	Level at antenna terminals (dBm)	Substitute antenna gain (dBi)	Cable Loss (dBi)	Spurious Emission level (dBm)	Limit Line (dBm)	Over Limit (dBm)	Polarization
1413.00	-54.03	7.90	0.12	-46.25	-13.00	-33.25	Vertical
2119.50	-55.17	10.37	0.31	-45.11	-13.00	-32.11	Vertical
2826.00	-47.27	11.23	0.54	-36.58	-13.00	-23.58	Vertical
1413.00	-52.97	7.90	0.12	-45.19	-13.00	-32.19	Horizontal
2119.50	-52.83	10.37	0.31	-42.77	-13.00	-29.77	Horizontal
2826.00	-46.38	11.23	0.54	-35.69	-13.00	-22.69	Horizontal
Middle channel							
Frequency (MHz)	Level at antenna terminals (dBm)	Substitute antenna gain (dBi)	Cable Loss (dBi)	Spurious Emission level (dBm)	Limit Line (dBm)	Over Limit (dBm)	Polarization
1420.00	-54.47	7.96	0.14	-46.65	-13.00	-33.65	Vertical
2130.00	-55.56	10.38	0.33	-45.51	-13.00	-32.51	Vertical
2840.00	-47.26	11.24	0.56	-36.58	-13.00	-23.58	Vertical
1420.00	-55.33	7.96	0.14	-47.51	-13.00	-34.51	Horizontal
2130.00	-54.27	10.38	0.33	-44.22	-13.00	-31.22	Horizontal
2840.00	-45.87	11.24	0.56	-35.19	-13.00	-22.19	Horizontal
Highest channel							
Frequency (MHz)	Level at antenna terminals (dBm)	Substitute antenna gain (dBi)	Cable Loss (dBi)	Spurious Emission level (dBm)	Limit Line (dBm)	Over Limit (dBm)	Polarization
1427.00	-54.48	8.02	0.16	-46.62	-13.00	-33.62	Vertical
2140.50	-57.95	10.40	0.34	-47.89	-13.00	-34.89	Vertical
2854.00	-50.81	11.25	0.57	-40.13	-13.00	-27.13	Vertical
1427.00	-54.81	8.02	0.16	-46.95	-13.00	-33.95	Horizontal
2140.50	-52.57	10.40	0.34	-42.51	-13.00	-29.51	Horizontal
2854.00	-49.45	11.25	0.57	-38.77	-13.00	-25.77	Horizontal
<i>Remark:</i>							
<i>The emission levels of below 1 GHz are lower than the limit 20dB and not show in test report.</i>							

Band 17 (10MHz)							
Lowest channel							
Frequency (MHz)	Level at antenna terminals (dBm)	Substitute antenna gain (dBi)	Cable Loss (dBi)	Spurious Emission level (dBm)	Limit Line (dBm)	Over Limit (dBm)	Polarization
1418.00	-55.97	7.94	0.13	-48.16	-13.00	-35.16	Vertical
2127.00	-56.39	10.38	0.32	-46.33	-13.00	-33.33	Vertical
2836.00	-48.53	11.24	0.56	-37.85	-13.00	-24.85	Vertical
1418.00	-53.50	7.94	0.13	-45.69	-13.00	-32.69	Horizontal
2127.00	-55.94	10.38	0.32	-45.88	-13.00	-32.88	Horizontal
2836.00	-50.47	11.24	0.56	-39.79	-13.00	-26.79	Horizontal
Middle channel							
Frequency (MHz)	Level at antenna terminals (dBm)	Substitute antenna gain (dBi)	Cable Loss (dBi)	Spurious Emission level (dBm)	Limit Line (dBm)	Over Limit (dBm)	Polarization
1420.00	-53.34	7.96	0.14	-45.52	-13.00	-32.52	Vertical
2130.00	-54.21	10.38	0.33	-44.16	-13.00	-31.16	Vertical
2840.00	-49.63	11.24	0.56	-38.95	-13.00	-25.95	Vertical
1420.00	-53.04	7.96	0.14	-45.22	-13.00	-32.22	Horizontal
2130.00	-52.74	10.38	0.33	-42.69	-13.00	-29.69	Horizontal
2840.00	-52.48	11.24	0.56	-41.80	-13.00	-28.80	Horizontal
Highest channel							
Frequency (MHz)	Level at antenna terminals (dBm)	Substitute antenna gain (dBi)	Cable Loss (dBi)	Spurious Emission level (dBm)	Limit Line (dBm)	Over Limit (dBm)	Polarization
1422.00	-54.48	7.98	0.15	-46.65	-13.00	-33.65	Vertical
2133.00	-57.90	10.39	0.34	-47.85	-13.00	-34.85	Vertical
2844.00	-46.78	11.24	0.57	-36.11	-13.00	-23.11	Vertical
1422.00	-56.68	7.98	0.15	-48.85	-13.00	-35.85	Horizontal
2133.00	-52.70	10.39	0.34	-42.65	-13.00	-29.65	Horizontal
2844.00	-46.77	11.24	0.57	-36.10	-13.00	-23.10	Horizontal
<i>Remark:</i>							
<i>The emission levels of below 1 GHz are lower than the limit 20dB and not show in test report.</i>							

6.6 Frequency stability V.S. Temperature measurement

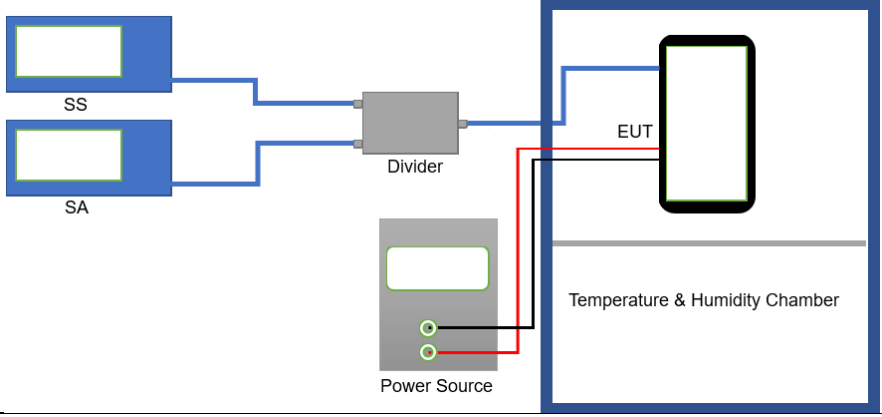
Test Requirement:	Part 22.355, Part 24.235, Part 27.54, Part 2.1055(a)(1)(b)
Limit:	Within authorized band for Band 2 & 4 & 12 & 13 & 17
Test setup:	
Test procedure:	<ol style="list-style-type: none"> 1. The equipment under test was connected to an external DC power supply and input rated voltage. 2. RF output was connected to a frequency counter or spectrum analyzer via feed through attenuators. 3. The EUT was placed inside the temperature chamber. 4. Set the spectrum analyzer RBW low enough to obtain the desired frequency resolution and measure EUT 25°C operating frequency as reference frequency. 5. Turn EUT off and set the chamber temperature to -30°C. After the temperature stabilized for approximately 30 minutes recorded the frequency. 6. Repeat step measure with 10°C increased per stage until the highest temperature of +50°C reached
Test Instruments:	Refer to section 5.10 for details
Test mode:	Refer to section 5.3 for details
Test results:	Passed

Measurement Data: Refer to Appendix F – LTE

6.7 Frequency stability V.S. Voltage measurement

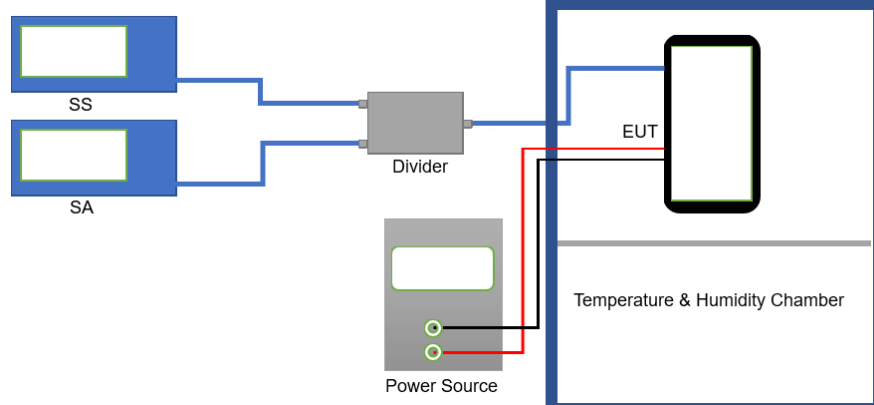
Test Requirement:	Part 22.355, Part 24.235, Part 27.54, Part 2.1055(d)(2)
Limit:	Within authorized band for Band 2 & 4 & 12 & 13 & 17
Test setup:	
Test procedure:	<ol style="list-style-type: none"> 1. Set chamber temperature to 25°C. Use a variable DC power source to power the EUT and set the voltage to rated voltage. 2. Set the spectrum analyzer RBW low enough to obtain the desired frequency resolution and recorded the frequency. 3. Reduce the input voltage to specify extreme voltage variation (+/- 15%) and endpoint, record the maximum frequency change.
Test Instruments:	Refer to section 5.10 for details
Test mode:	Refer to section 5.3 for details
Test results:	Passed

Measurement Data: Refer to Appendix F – LTE

8 EUT Constructional Details

Reference to the test report No. JYTSZB-R12-2100762

-----End of report-----