

Smart Dual Water Timer

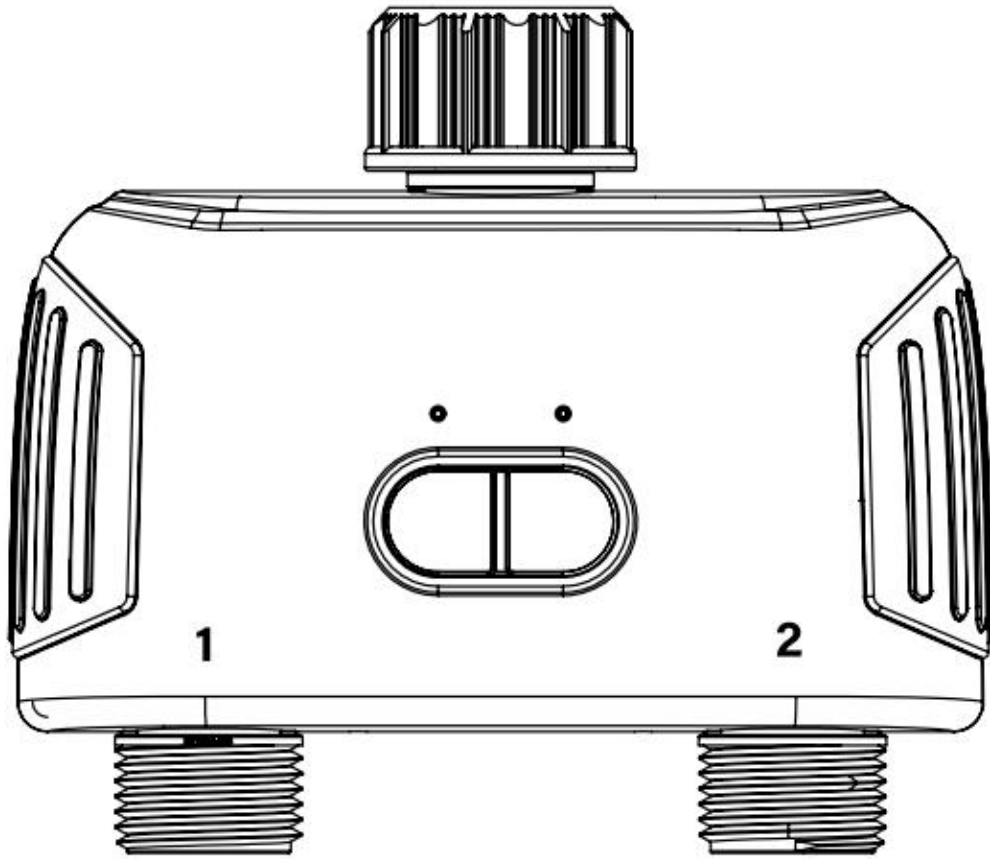

1. Meet the Dual Hose Faucet Timer

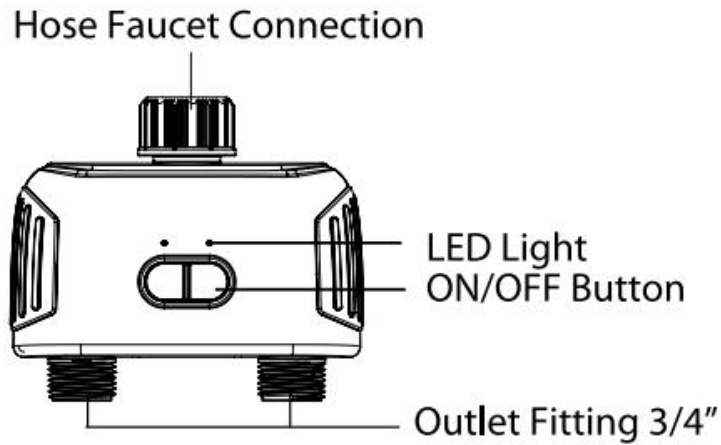

Specification:

Bluetooth Range	49.2ft without interference
Working Water Pressure	7.25-116 psi
Working Temperature	40.1°F-113°F (4.5°C-45°C)
Rain Delay Time	1 day and up to 7 days
Waterproof	IPX5
Battery	4x AA alkaline batteries

2. Initial Water Timer Setup

1 Insert 4x AA Batteries

1. Remove the tray on the back of the timer by sliding or pulling it out.
2. Insert four AA (1.5V) alkaline batteries and replace the tray.

ⓘ Note:

Please do not mix alkaline, standard (carbon-zinc), or rechargeable batteries.

2 Install the Timer

Connect the timer to an outdoor hose faucet. Your timer is now ready to be used with any product that can be attached to a standard hose faucet.

ⓘ Note:

Do not place the timer in an underground valve box or anywhere your Bluetooth signal will be obstructed.

3 Turn on Your Water

The water must remain on for the timer to work properly.

3. Initial Smart Life App Setup

1 Download the Smart Life App

Scan the QR code and download the free Android or IOS app, then install the APP. If you have already installed the Smart Life APP, go to step 2.



2 Enter configuration Mode

Long press either of the "On/OFF button" for 6s until the two green lights flash quickly at the same time to keep the water timer in pairing mode.

3

3 Open the Smart Life App

Create an account or login with an existing account to begin timer setup.

4 Add a Device

Tap "Add device" or "+" to add the smart device in app.
Select "Industry&Agriculture" > "Water valve controller(BLE)".
Waiting for connecting to be 100%. Edit the name of your water timer completed.

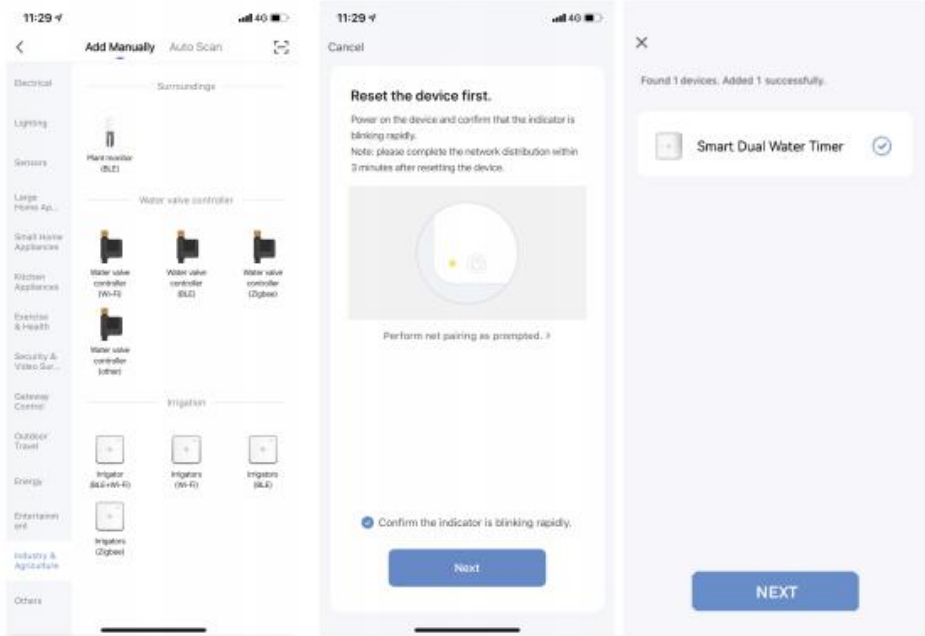

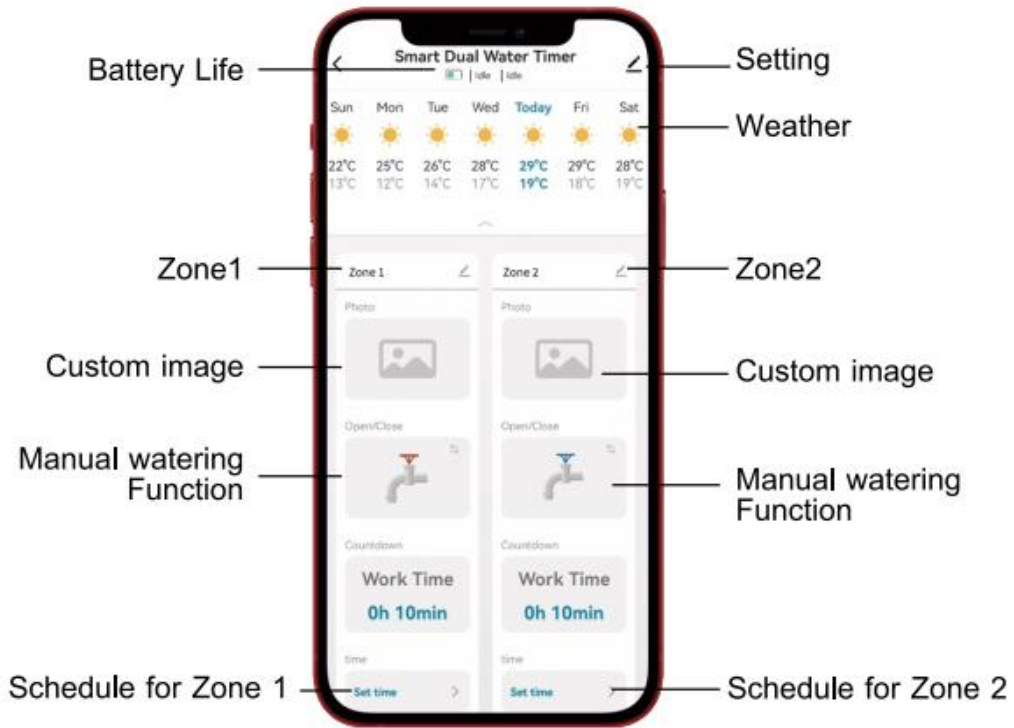

4. Meet the Smartlife App Home Screen





5. Additional Water Timer Features

1 Manual Watering

Your timer has the ability to allow you to manually water without disturbing the programmed schedule. Manual is used to test equipment, run an extra watering cycle in an area, or to use the hose faucet without removing the timer.

Click the   button to activate manual watering. Using the app you can click  to set how long you want manual watering time to run for the "work time", also remaining watering time will be displayed.

2 Stop Watering

You can stop the flow of water at any time whether it is during manual watering, or during a programmed time. Click the   button once again to stop watering. (NOTE: icon without water droplets)

3 Rain Delay Function

The rain delay function allows you to postpone watering for 1 day and up to 7 days due to rain or when the ground is already wet. Click the button to activate manual watering. Using the app you can click set how long you want the preset rain delay feature.

6. Troubleshooting

Q1: Why the Bluetooth water timer didn't turn on/off at preset time?

A1:

- Programming is incorrect
- Water pressure is too low
- Particles of dirt or debris stuck in valve
- More than one start time is programmed with overlapping schedules
- Manual watering is on
- Faulty valve
- The batteries were low
- The faucet is off.

Q2: Why Bluetooth keeps dropping connection?

A2:

- The Bluetooth of water timer is currently in sleep mode, please wait 5-10 seconds, the device will automatically reconnect. Or scroll down to refresh the home page of the APP, or disconnect the Bluetooth from your phone and turn it on again
- If the device has been connected by other mobile phones, please disconnect first.
- Make sure the device battery is charged and place the phone as close to the device as possible.
- Please note that you don't need to stay connect once you setup your schedule. The device will always keep your watering settings and work automatically according to the schedule.

Q3: Why is the water valve out of little water?

A3:

If your are gravity feed system such as rain barrel system, then it won't work and will keep low water pressure. Gravity feed has no real pressure when dealing with a rain barrel. It needs pressure measuring.

7. Warm Tips :

- The best range for connection and control is within 49.2ft in the open area.
- The bluetooth water timer does not support Alexa & Google voice or remote control.
- Do not use your timer when the air temperature is below 40°F(4.5°C), the timers should be removed from the hose faucet and stored indoors to avoid potential frozen damage.
- Filter can trap dirt particles, please clean filter regularly and replace if worn.
- Please replace batteries when the low battery indicator appears the display. When replacing the power unit, please make sure that the water timer is dry.
- To prevent leakage, make sure that the water timer is tightly attached to the faucet and hose, add rubber washer and thread seal tape if necessary.

! Note:

(1) The water flow is reduced by half when the two zones are turned on at the same time.

(2)The water flow in two zones may be different if you turn on one zone first and then turn on the other zone.

FCC Warning Statement:

Changes or modifications to this unit not expressly approved by the party responsible for compliance could void the user's authority to operate the equipment. : This equipment has been tested and found to comply with the limits for a Class B digital device, pursuant to Part 15 of the FCC Rules. These limits are designed to provide reasonable protection against harmful interference in a residential installation. This equipment generates, uses and can radiate radio frequency energy and, if not installed and used in accordance with the instructions, may cause harmful interference to radio communications. However, there is no guarantee that interference will not occur in a particular installation. If this equipment does cause harmful interference to radio or television reception, which can be determined by turning the equipment off and on, the user is encouraged to try to correct the interference by one or more of the following measures:

- Reorient or relocate the receiving antenna.
- Increase the separation between the equipment and receiver.
- Connect the equipment into an outlet on a circuit different from that to which the receiver is connected.
- Consult the dealer or an experienced radio/TV technician for help.

This device complies with Part 15 of the FCC Rules. Operation is subject to the following two conditions: (1) this device may not cause harmful interference, and (2) this device must accept any interference received, including interference that may cause undesired operation.

FCC Radiation Exposure Statement

The antennas used for this transmitter must be installed to provide a separation distance of at least 20 cm from all persons and must not be co - located for operating in conjunction with any other antenna or transmitter.