

# Test Report

FCC ID: 2AP9S-GW-W-SIRC

Date of issue: Jan. 04, 2019

Report Number:	MTi190104E027
Sample Description:	WiFi String Light
Model(s):	GW-W-SIRC, MG-WF-RGB-02, BH19-093-599-84
Applicant:	Gateway Plastic Hardware & Lighting Co., Ltd.
Address:	Jingfu Road, Xincheng Industrial Area, Hengli Town, Dongguan, Guangdong, China
Date of Test:	Dec. 28, 2018 to Jan. 04, 2019

Shenzhen Microtest Co., Ltd.  
<http://www.mtitest.com>

## Table of Contents

<b>1</b>	<b>GENERAL INFORMATION</b>	<b>5</b>
1.1	DESCRIPTION OF EUT	5
1.2	OPERATION CHANNEL LIST	6
1.3	TEST CHANNEL LIST	6
1.4	ANCILLARY EQUIPMENT LIST	6
1.5	DESCRIPTION OF SUPPORT UNITS	6
<b>2</b>	<b>SUMMARY OF TEST RESULTS</b>	<b>7</b>
<b>3</b>	<b>TEST FACILITIES AND ACCREDITATIONS</b>	<b>8</b>
3.1	TEST LABORATORY	8
3.2	ENVIRONMENTAL CONDITIONS	8
3.3	MEASUREMENT UNCERTAINTY	8
3.4	TEST SOFTWARE	8
<b>4</b>	<b>EQUIPMENT LIST</b>	<b>9</b>
<b>5</b>	<b>TEST RESULT</b>	<b>10</b>
5.1	ANTENNA REQUIREMENT	10
5.1.1	<i>Standard requirement</i>	10
5.1.2	<i>EUT Antenna</i>	10
5.2	PEAK OUTPUT POWER	11
5.2.1	<i>Limit</i>	11
5.2.2	<i>Test setup</i>	11
5.2.3	<i>Test procedure</i>	11
5.2.4	<i>Test results</i>	12
5.3	POWER SPECTRAL DENSITY	13
5.3.1	<i>Limit</i>	13
5.3.2	<i>Test Setup</i>	13
5.3.3	<i>Test Procedure</i>	13
5.3.4	<i>Test Results</i>	14
5.4	CONDUCTED EMISSION	17
5.4.1	<i>Limits</i>	17
5.4.2	<i>Test setup</i>	17
5.4.3	<i>Test procedure</i>	18
5.4.4	<i>Test results</i>	19
5.5	RADIATED SPURIOUS	23
5.5.1	<i>Limits</i>	23
5.5.2	<i>Test setup</i>	24
5.5.3	<i>Test procedure</i>	25
5.5.4	<i>Test results</i>	26
5.5.4.1	<i>Radiation emission</i>	26
5.5.4.2	<i>Band edge - radiated</i>	30
5.5.4.3	<i>Spurious Emission in Restricted Band 3260MMHz-18000MHz</i>	32
5.6	CONDUCTION SPURIOUS EMISSION	33
5.6.1	<i>Limits</i>	33
5.6.2	<i>Test setup</i>	33
5.6.3	<i>Test procedure</i>	33
5.6.4	<i>Test results</i>	34
5.7	6dB BANDWIDTH	37
5.7.1	<i>Limit</i>	37
5.7.2	<i>Test setup</i>	37
5.7.3	<i>Test procedure</i>	37
5.7.4	<i>Test results</i>	38
5.8	SPURIOUS RF CONDUCTED EMISSIONS	44
5.8.1	<i>Conformance Limit</i>	44
5.8.2	<i>Measuring Instruments</i>	44

5.8.3 Test Setup ..... 44  
5.8.4 Test Procedure ..... 44  
5.8.5 Test Results ..... 44

**PHOTOGRAPHS OF THE TEST SETUP ..... 48**

**PHOTOGRAPHS OF THE EUT ..... 49**

# Test Result Certification

Applicant's name: Gateway Plastic Hardware & Lighting Co., Ltd.

Address: Jingfu Road, Xincheng Industrial Area, Hengli Town, Dongguan, Guangdong, China

Manufacture's Name: Gateway Plastic Hardware & Lighting Co., Ltd.

Address: Jingfu Road, Xincheng Industrial Area, Hengli Town, Dongguan, Guangdong, China

Product name: WiFi String Light

Trademark: Gateway

Model name: GW-W-SIRC, MG-WF-RGB-02, BH19-093-599-84

Standards: FCC Part 15.247

Test Procedure: ANSI C63.10-2013  
KDB 558074 D01 DTS Meas Guidance v05  
KDB 174176 D01 Line Conducted FAQ v01r01

*This device described above has been tested by Shenzhen Microtest Co., Ltd. and the test results show that the equipment under test (EUT) compliance with the FCC requirements. And it is applicable only to the tested sample identified in the report.*

Tested by: Jack Le  
Jack Le Jan. 04, 2019

Reviewed by: Blue Zheng  
Blue Zheng Jan. 04, 2019

Approved by: Smith Chen  
Smith Chen Jan. 04, 2019

## 1 General information

### 1.1 Description of EUT

Product name:	WiFi String Light
Model name:	GW-W-SIRC
Serial Model:	MG-WF-RGB-02, BH19-093-599-84
Model difference:	All the model are the same circuit and RF module, except the model No.
Operation frequency:	802.11b/g/n20:2412~2462 MHz
Modulation type:	IEEE 802.11b : DSSS (DBPSK, DQPSK, CCK) IEEE 802.11g/n (HT20) : OFDM (64QAM, 16QAM, QPSK, BPSK)
Bit Rate of transmitter:	802.11b:11/5.5/2/1 Mbps 802.11g:54/48/36/24/18/12/9/6Mbps 802.11n(20MHz) use 800 ns GI: 65.0/58.5/52.0/39.0/26.0/19.5/13.0/6.5 Mbps (MCS0~MCS7)
Antenna type:	PCB antenna
Antenna gain:	1.2dBi
Max. output power:	11.72dBm
Power supply:	DC 12V from adapter
Battery:	N/A
Adapter information:	Model: S030A1202000U Input: 100-240V~50/60Hz 800mA Max Output: 12V 2A
Hardware version:	V1.0
Software version:	N/A

## 1.2 Operation channel list

### Channel List for 802.11b/g/n(20)

Channel	Frequency (MHz)	Channel	Frequency (MHz)
01	2412	07	2442
02	2417	08	2447
03	2422	09	2452
04	2427	10	2457
05	2432	11	2462
06	2437	\	\

## 1.3 Test channel list

### Channel List for 802.11b/g/n(20)

Channel	Channel	Frequency (MHz)
Low	01	2412
Middle	06	2437
High	11	2462

## 1.4 Ancillary equipment list

Equipment	Model	S/N	Manufacturer	Certificate type
Adapter	S030A1202000U	/	/	/

## 1.5 Description of Support Units

The EUT has been tested as an independent unit together with other necessary accessories or support units. The following support units or accessories were used to form a representative test configuration during the tests.

Item	Equipment	Brand	Model/Type No.	Series No.	Note
/	/	/	/	/	/

### Note:

- (1)The support equipment was authorized by Declaration of Confirmation.
- (2)For detachable type I/O cable should be specified the length in cm in 『Length』 column.

## 2 Summary of Test Results

Test procedures according to the technical standards:

No.	Standard Section	Test Item	Result	Remark
1	15.203	Antenna Requirement	Pass	
2	15.247 (b)	Peak Output Power	Pass	
3	15.247 (e)	Power Spectral Density	Pass	
4	15.207	Conducted Emission	Pass	
5	15.247 (d) & 15.209	Radiated Spurious Emission	Pass	
6	15.205	Band Edge Emission	Pass	
7	15.247 (a)(2)	6dB Bandwidth	Pass	
8	15.205	Spurious RF Conducted Emissions	Pass	

### 3 Test Facilities and Accreditations

#### 3.1 Test laboratory

Test Laboratory	Shenzhen Microtest Co., Ltd
Location	No.102A & 302A, East Block, Hengfang Industrial Park, Xingye Road, Xixiang, Bao'an District, Shenzhen, Guangdong, China
FCC Registration No.:	448573

#### 3.2 Environmental conditions

Temperature:	20°C~30°C
Humidity	30%~70%
Atmospheric pressure	98kPa~101kPa

#### 3.3 Measurement uncertainty

The reported uncertainty of measurement  $y \pm U$  where expanded uncertainty  $U$  is based on a standard uncertainty multiplied by a coverage factor of  $k=2$  providing a level of confidence of approximately 95 %

No.	Item	Uncertainty
1	Conducted Emission Test	$\pm 1.38\text{dB}$
2	RF power, conducted	$\pm 0.16\text{dB}$
3	Spurious emissions, conducted	$\pm 0.21\text{dB}$
4	All emissions, radiated(<1G)	$\pm 4.68\text{dB}$
5	All emissions, radiated(>1G)	$\pm 4.89\text{dB}$
6	Temperature	$\pm 0.5\text{C}$
7	Humidity	$\pm 2\%$

#### 3.4 Test software

Software Name	Manufacturer	Model	Version
RF Test System	Farad	LZ-RF	Lz_Rf 3A3

Note: Test voltage was tuned from 85% to 115% of the nominal rated supply voltage, and found that the worst case was under the nominal rated supply condition. So only the worst condition' s result is reported.



## 4 Equipment list

Equipment No.	Equipment Name	Manufacturer	Model	Serial No.	Calibration date	Due date
MTI-E001	Spectrum Analyzer	Agilent	E4407B	MY41441082	2018/09/18	2019/09/17
MTI-E002	CMU 200 universal radio communication tester	Rohde&schwarz	CMU 200	114587	2018/09/18	2019/09/17
MTI-E003	Spectrum Analyzer	R&S	ESCI	MTI-E003	2018/09/18	2019/09/17
MTI-E004	EMI Test Receiver	Rohde&schwarz	ESPI	1000314	2018/09/18	2019/09/17
MTI-E006	Broadband antenna	schwarzbeck	VULB9163	872	2018/09/18	2019/09/17
MTI-E007	Horn antenna	schwarzbeck	BBHA9120D	1201	2018/09/18	2019/09/17
MTI-E014	amplifier	America	8447D	3113A06150	2018/09/18	2019/09/17
MTI-E015	Conduction Immunity Signal Generator	Schloder	CDG6000	126A1343/2015	2018/09/18	2019/09/17
MTI-E016	Coupled decoupling network	Schloder	CDA M2/M3	A2210332/2015	2018/09/18	2019/09/17
MTI-E032	Comprehensive test instrument	Rohde&schwarz	CMW500	124192	2018/09/18	2019/09/17
MTI-E034	amplifier	Agilent	8449B	3008A02400	2018/09/18	2019/09/17
MTI-E037	Artificial power network	Schwarzbeck	NSLK8127	#841	2018/09/18	2019/09/17
MTI-E040	Spectrum analyzer	Agilent	N9020A	MY49100060	2018/09/18	2019/09/17
MTI-E041	Signal generator	Agilent	N5182A	MY49060455	2018/09/18	2019/09/17
MTI-E042	Analog signal generator	Agilent	E4421B	GB40051240	2018/09/18	2019/09/17
MTI-E043	Power sensor	Dare Instruments	RPR3006W	16I00054SN016	2018/09/18	2019/09/17
MTI-E047	10dB attenuator	Mini-Circuits	UNAT-10+	15542	2018/09/18	2019/09/17
MTI-E049	spectrum analyzer	Rohde&schwarz	FSP-38	100019	2018/09/18	2019/09/17
MTI-E050	PSG Signal generator	Agilent	E8257D	MY46520873	2018/09/18	2019/09/17
MTI-E051	Active Loop Antenna 9kHz - 30MHz	Schwarzbeck	FMZB 1519 B	00044	2018/09/18	2019/09/17
MTI-E052	18-40GHz amplifier	Chengdu step Micro Technology	ZLNA-18-40G-21	1608001	2018/09/18	2019/09/17
MTI-E053	15-40G Antenna	Schwarzbeck	BBHA9170	BBHA9170582	2018/09/18	2019/09/17
MTI-E058	Artificial power network	Schwarzbeck	NSLK8127	#841	2018/09/18	2019/09/17

Note: the calibration interval of the above test instruments is 12 months and the calibrations are traceable to international system unit (SI).

## 5 Test Result

### 5.1 Antenna requirement

#### 5.1.1 Standard requirement

15.203 requirement: For intentional device, according to 15.203: an intentional radiator shall be designed to ensure that no antenna other than that furnished by the responsible party shall be used with the device

#### 5.1.2 EUT Antenna

The EUT antenna is PCB antenna (1.2dBi). It comply with the standard requirement. In case of replacement of broken antenna the same antenna type must be used.

## 5.2 Peak output power

### 5.2.1 Limit

FCC Part15 Subpart C				
Section	Test Item	Limit	Frequency Range (MHz)	Result
15.247(b)(3)	Peak output power	1 watt or 30dBm	2400-2483.5	Pass

### 5.2.2 Test setup

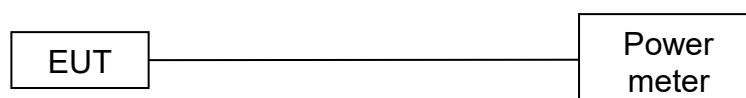

### 5.2.3 Test procedure

The EUT was directly connected to the Power meter.

5.2.4 Test results

802.11b

Test Channel	Frequency (MHz)	Maximum Peak Conducted Output Power(dBm)	Limit (dBm)
CH01	2412	11.72	30
CH06	2437	11.48	30
CH11	2462	11.69	30

802.11g

Test Channel	Frequency (MHz)	Maximum Peak Conducted Output Power(dBm)	Limit (dBm)
CH01	2412	11.16	30
CH06	2437	10.89	30
CH11	2462	11.30	30

802.11n20

Test Channel	Frequency (MHz)	Maximum Peak Conducted Output Power(dBm)	Limit (dBm)
CH01	2412	10.46	30
CH06	2437	11.37	30
CH11	2462	10.96	30

### 5.3 Power spectral density

#### 5.3.1 Limit

FCC Part15 Subpart C				
Section	Test Item	Limit	Frequency Range (MHz)	Result
15.247	Power Spectral Density	8dBm (in any 3kHz)	2400-2483.5	Pass

#### 5.3.2 Test Setup

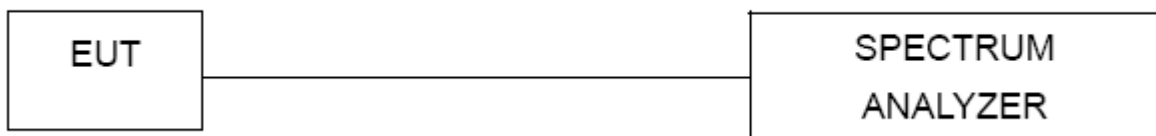

#### 5.3.3 Test Procedure

- a. The EUT tested system was configured as the statements of 2.1 unless otherwise a special operating condition is specified in the follows during the testing.
- b. Set analyzer center frequency to DTS channel center frequency.
- c. Set the span to 1.5 times the DTS channel bandwidth.
- d. Set the RBW  $\geq 3$  kHz.
- e. Set the VBW  $\geq 3 \times$  RBW.
- f. Detector = peak.
- g. Sweep time = auto couple.
- h. Trace mode = max hold.
- i. Allow trace to fully stabilize.
- j. Use the peak marker function to determine the maximum amplitude level.
- k. If measured value exceeds limit, reduce RBW (no less than 3 kHz) and repeat.

5.3.4 Test Results

802.11b			
Frequency	Power Density (dBm/3kHz)	Limit (dBm/3kHz)	Result
2412 MHz	-10.475	8	Pass
2437 MHz	-9.692	8	Pass
2462 MHz	-9.312	8	Pass

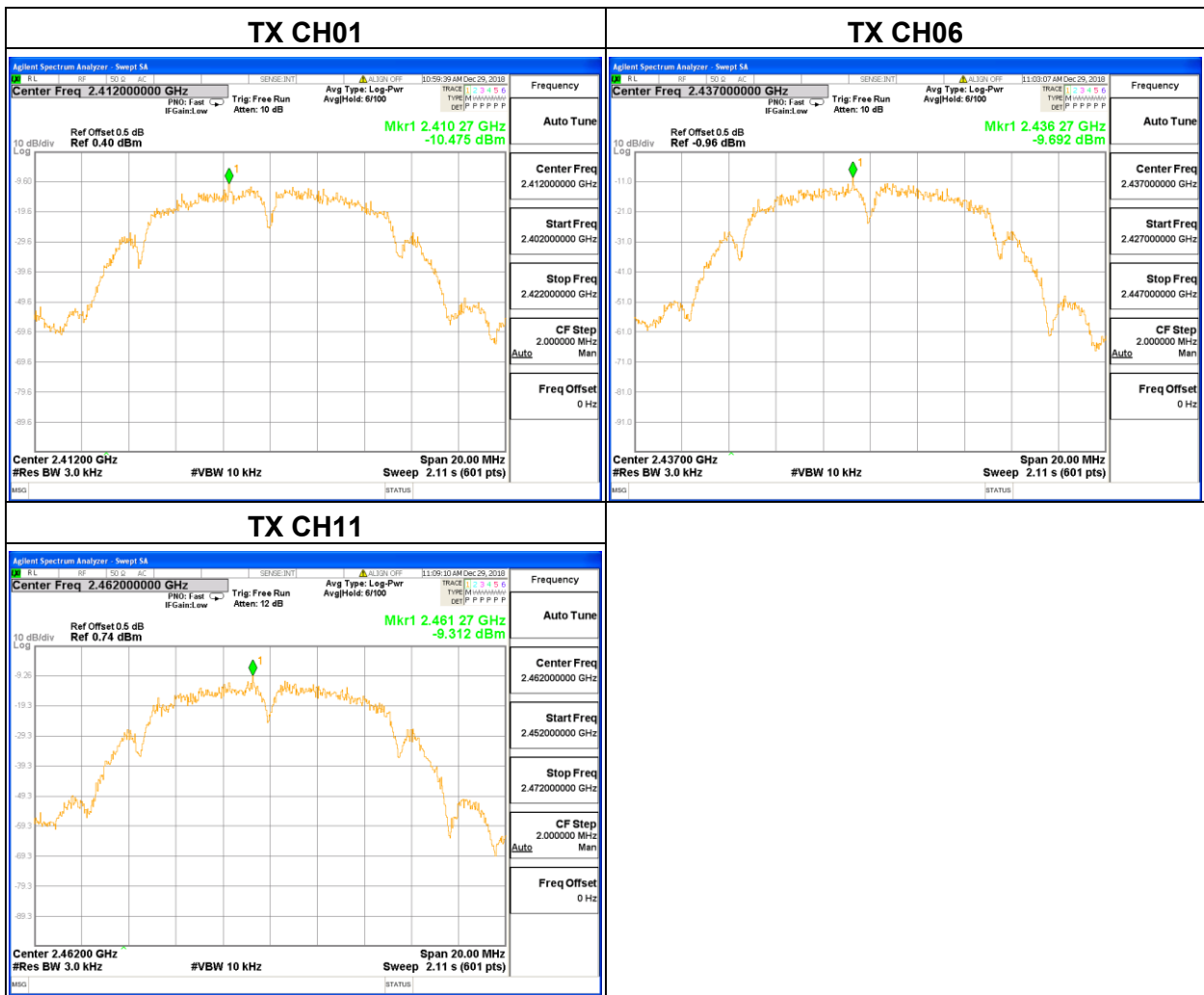

802.11g			
Frequency	Power Density (dBm/3kHz)	Limit (dBm/3kHz)	Result
2412 MHz	-14.661	8	Pass
2437 MHz	-13.909	8	Pass
2462 MHz	-14.055	8	Pass

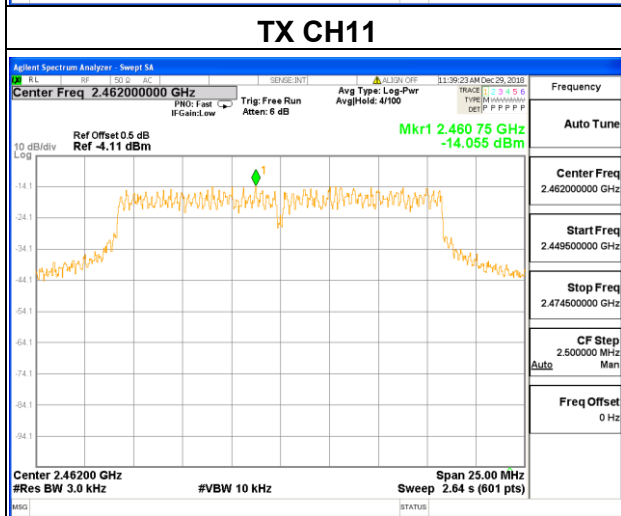
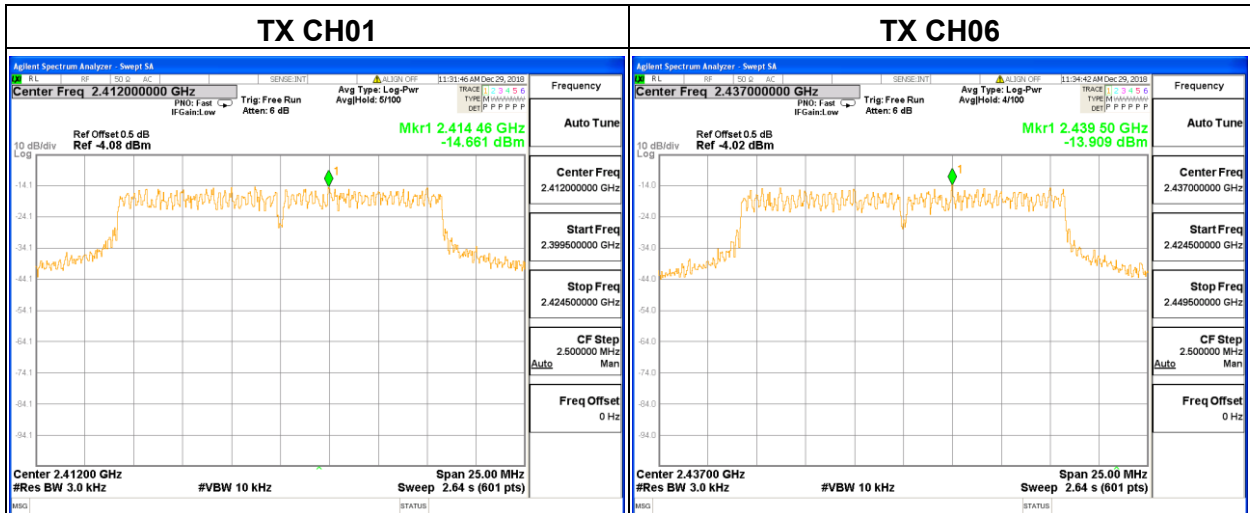

802.11n20			
Frequency	Power Density (dBm/3kHz)	Limit (dBm/3kHz)	Result
2412 MHz	-14.231	8	Pass
2437 MHz	-12.854	8	Pass
2462 MHz	-13.240	8	Pass

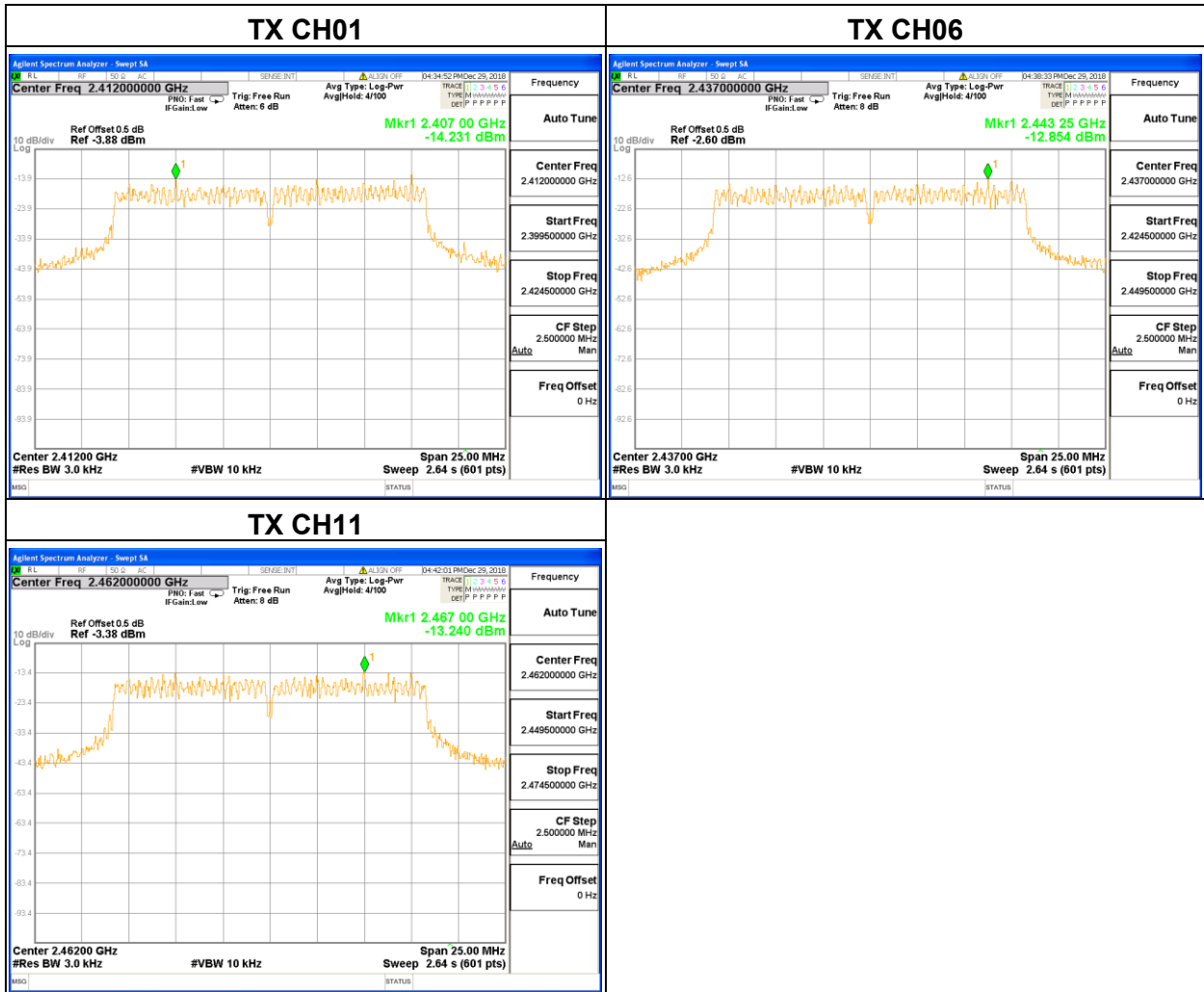



## 5.4 Conducted emission

### 5.4.1 Limits

According to FCC Part 15.207(a) and KDB 174176 D01 Line Conducted FAQ v01r01.

FREQUENCY (MHz)	Class B (dBuV)	
	Quasi-peak	Average
0.15 -0.5	66 - 56 *	56 - 46 *
0.50 -5.0	56.00	46.00
5.0 -30.0	60.00	50.00

#### Note

(1)The tighter limit applies at the band edges.

(2)The limit of " \* " marked band means the limitation decreases linearly with the logarithm of the frequency in the range.

### 5.4.2 Test setup

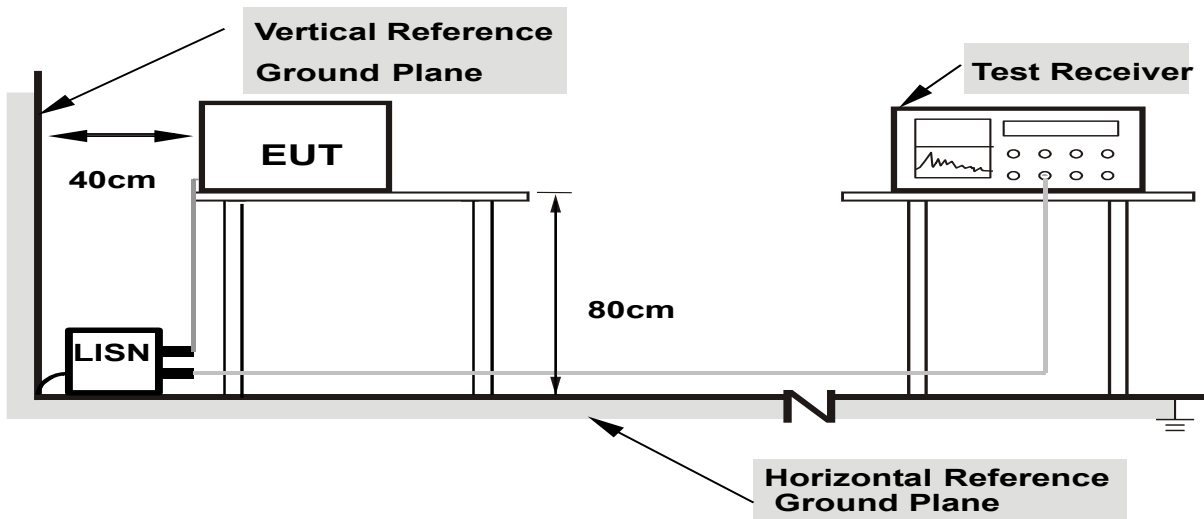

**Note: 1.Support units were connected to second LISN.**

**2.Both of LISNs (AMN) are 80 cm from EUT and at least 80 from other units and other metal planes**

### 5.4.3 Test procedure

#### a. EUT Operating Conditions

The EUT was configured for testing in a typical fashion (as a customer would normally use it). The EUT has been programmed to continuously transmit during test. This operating condition was tested and used to collect the included data.

#### b. The following table is the setting of the receiver

Receiver Parameters	Setting
Attenuation	10 dB
Start Frequency	0.15 MHz
Stop Frequency	30 MHz
IF Bandwidth	9 kHz

- c. The EUT was placed 0.8 meters from the horizontal ground plane with EUT being connected to the power mains through a line impedance stabilization network (LISN). All other support equipments powered from additional LISN(s). The LISN provide 50 Ohm/ 50uH of coupling impedance for the measuring instrument.
- d. Interconnecting cables that hang closer than 40 cm to the ground plane shall be folded back and forth in the center forming a bundle 30 to 40 cm long.
- e. I/O cables that are not connected to a peripheral shall be bundled in the center. The end of the cable may be terminated, if required, using the correct terminating impedance. The overall length shall not exceed 1 m.
- f. LISN at least 80 cm from nearest part of EUT chassis.

For the actual test configuration, please refer to the related Item –EUT Test Photos.

5.4.4 Test results

EUT :	WiFi String Light	Model Name. :	GW-W-SIRC
Temperature :	26 °C	Relative Humidity :	54%
Pressure :	1010hPa	Phase :	L
Test Voltage :	DC 12V from adapter AC120V/60Hz	Test Mode:	Normal Working

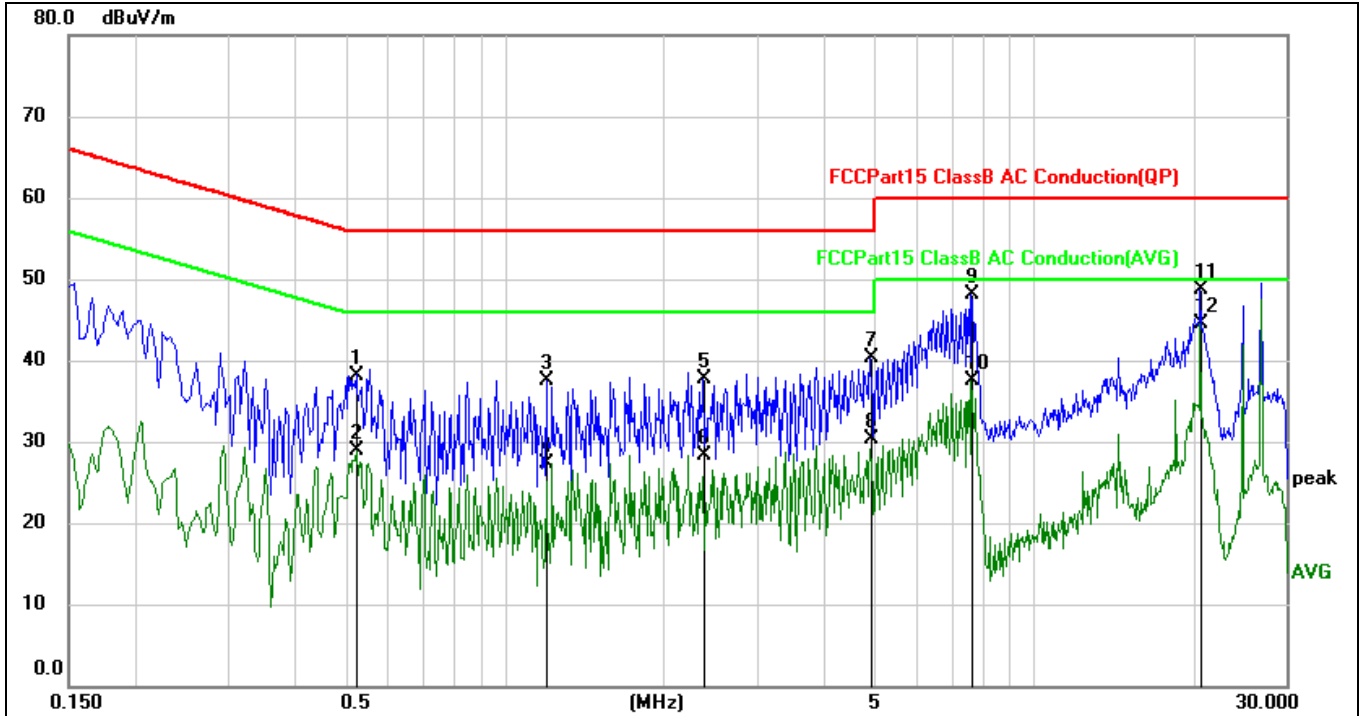

No.	Mk.	Freq. MHz	Reading Level dBuV/m	Correct Factor dB	Measure- ment dBuV/m	Limit dBuV/m	Over dB	Detector	Comment
1		0.5260	36.63	1.57	38.20	56.00	-17.80	QP	
2		0.5260	27.27	1.57	28.84	46.00	-17.16	AVG	
3		1.2020	35.91	1.58	37.49	56.00	-18.51	QP	
4		1.2020	25.66	1.58	27.24	46.00	-18.76	AVG	
5		2.3740	36.42	1.33	37.75	56.00	-18.25	QP	
6		2.3740	26.96	1.33	28.29	46.00	-17.71	AVG	
7		4.9220	39.95	0.37	40.32	56.00	-15.68	QP	
8		4.9220	30.02	0.37	30.39	46.00	-15.61	AVG	
9		7.6460	47.81	0.38	48.19	60.00	-11.81	QP	
10		7.6460	37.03	0.38	37.41	50.00	-12.59	AVG	
11		20.6620	48.38	0.31	48.69	60.00	-11.31	QP	
12	*	20.6620	44.21	0.31	44.52	50.00	-5.48	AVG	

EUT :	WiFi String Light	Model Name. :	GW-W-SIRC
Temperature :	26 °C	Relative Humidity :	54%
Pressure :	1010hPa	Phase :	N
Test Voltage :	DC 12V from adapter AC120V/60Hz	Test Mode:	Normal Working

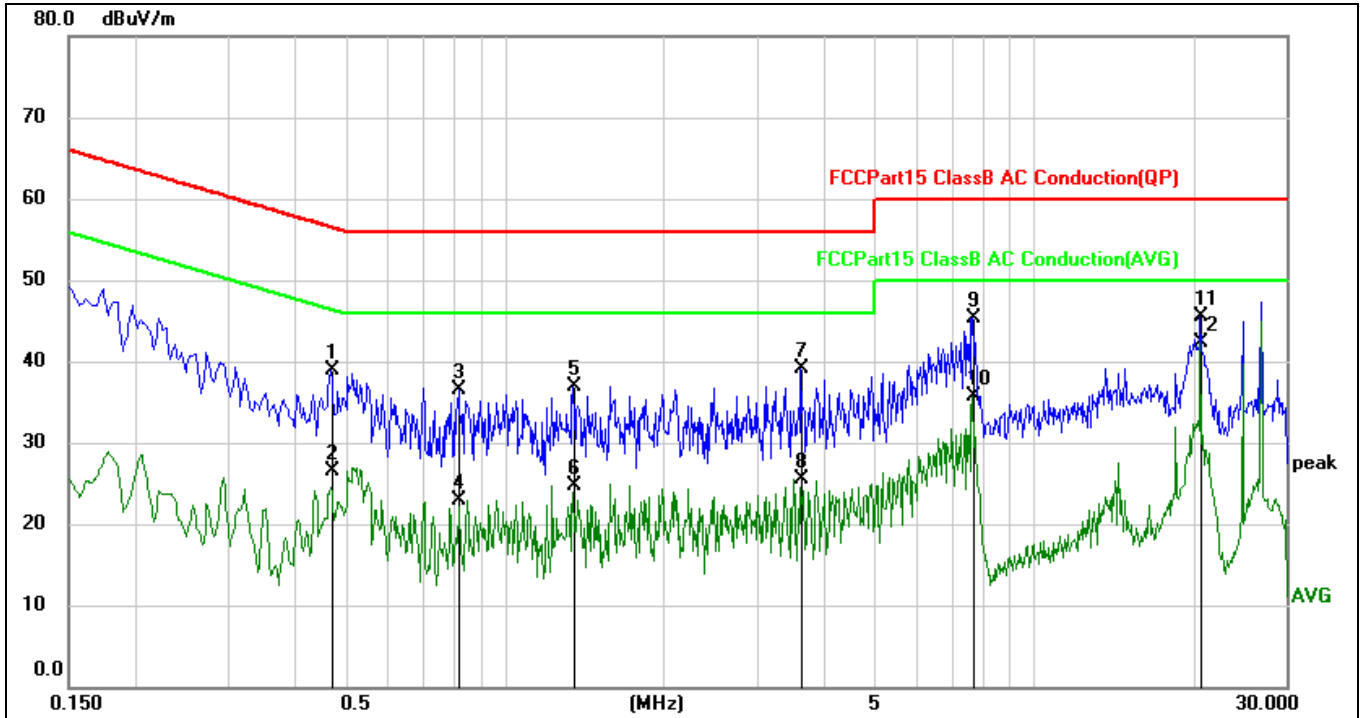

No.	Mk.	Freq. MHz	Reading Level dBuV/m	Correct Factor dB	Measure- ment dBuV/m	Limit dBuV/m	Over dB	Detector	Comment
1		0.4700	37.28	1.57	38.85	56.51	-17.66	QP	
2		0.4700	24.87	1.57	26.44	46.51	-20.07	AVG	
3		0.8180	35.03	1.57	36.60	56.00	-19.40	QP	
4		0.8180	21.38	1.57	22.95	46.00	-23.05	AVG	
5		1.3460	35.30	1.58	36.88	56.00	-19.12	QP	
6		1.3460	23.21	1.58	24.79	46.00	-21.21	AVG	
7		3.6340	38.12	0.94	39.06	56.00	-16.94	QP	
8		3.6340	24.59	0.94	25.53	46.00	-20.47	AVG	
9		7.6500	44.94	0.38	45.32	60.00	-14.68	QP	
10		7.6500	35.24	0.38	35.62	50.00	-14.38	AVG	
11		20.6740	45.26	0.31	45.57	60.00	-14.43	QP	
12	*	20.6740	42.08	0.31	42.39	50.00	-7.61	AVG	

EUT :	WiFi String Light	Model Name. :	GW-W-SIRC
Temperature :	26 °C	Relative Humidity :	54%
Pressure :	1010hPa	Phase :	L
Test Voltage :	DC 12V from adapter AC 240V/60Hz	Test Mode:	Normal Working

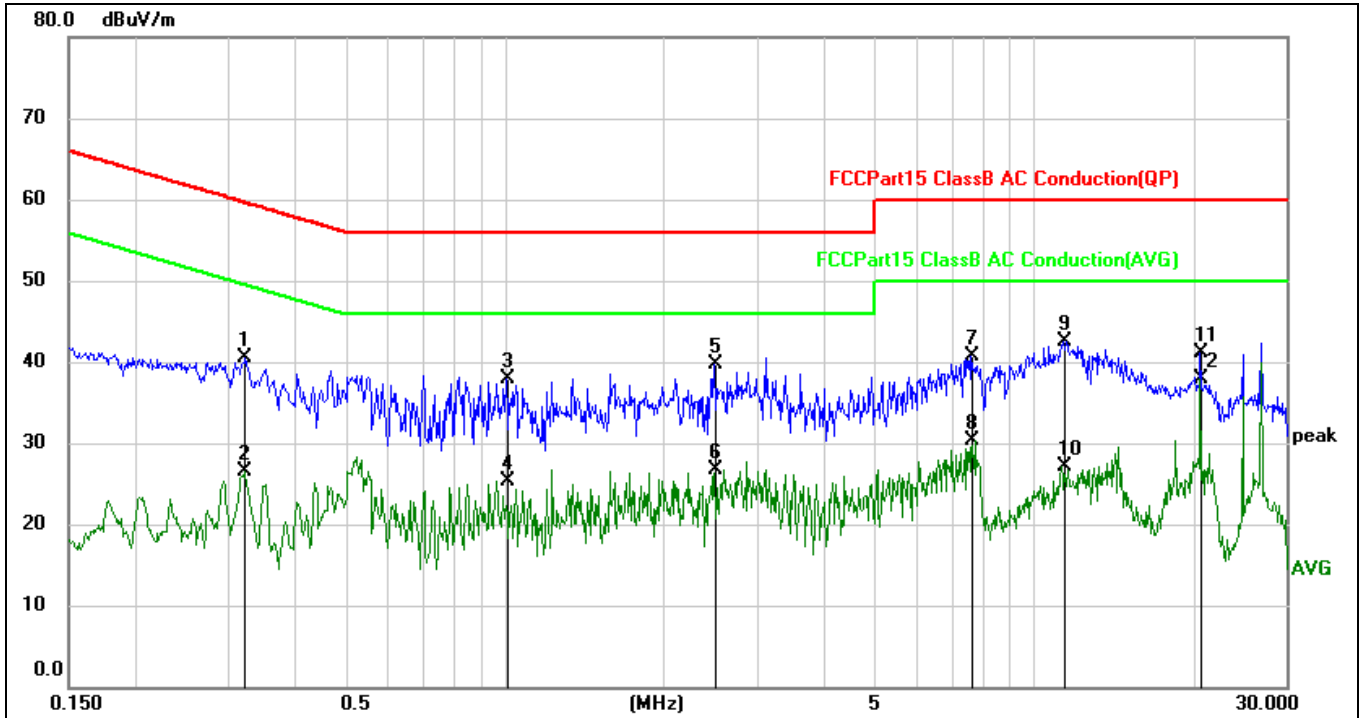

No. Mk.	Freq. MHz	Reading Level dBuV/m	Correct Factor dB	Measurement dBuV/m	Limit dBuV/m	Over dB	Detector	Comment
1	0.3234	38.98	1.57	40.55	59.62	-19.07	QP	
2	0.3234	24.90	1.57	26.47	49.62	-23.15	AVG	
3	1.0100	36.24	1.58	37.82	56.00	-18.18	QP	
4	1.0100	23.74	1.58	25.32	46.00	-20.68	AVG	
5	2.4900	38.39	1.25	39.64	56.00	-16.36	QP	
6	2.4900	25.45	1.25	26.70	46.00	-19.30	AVG	
7	7.6459	40.36	0.38	40.74	60.00	-19.26	QP	
8	7.6459	29.84	0.38	30.22	50.00	-19.78	AVG	
9	11.4259	42.22	0.37	42.59	60.00	-17.41	QP	
10	11.4259	26.74	0.37	27.11	50.00	-22.89	AVG	
11	20.6739	40.76	0.31	41.07	60.00	-18.93	QP	
12 *	20.6739	37.58	0.31	37.89	50.00	-12.11	AVG	

EUT :	WiFi String Light	Model Name. :	GW-W-SIRC
Temperature :	26 °C	Relative Humidity :	54%
Pressure :	1010hPa	Phase :	N
Test Voltage :	DC 12V from adapter AC 240V/60Hz	Test Mode:	Normal Working

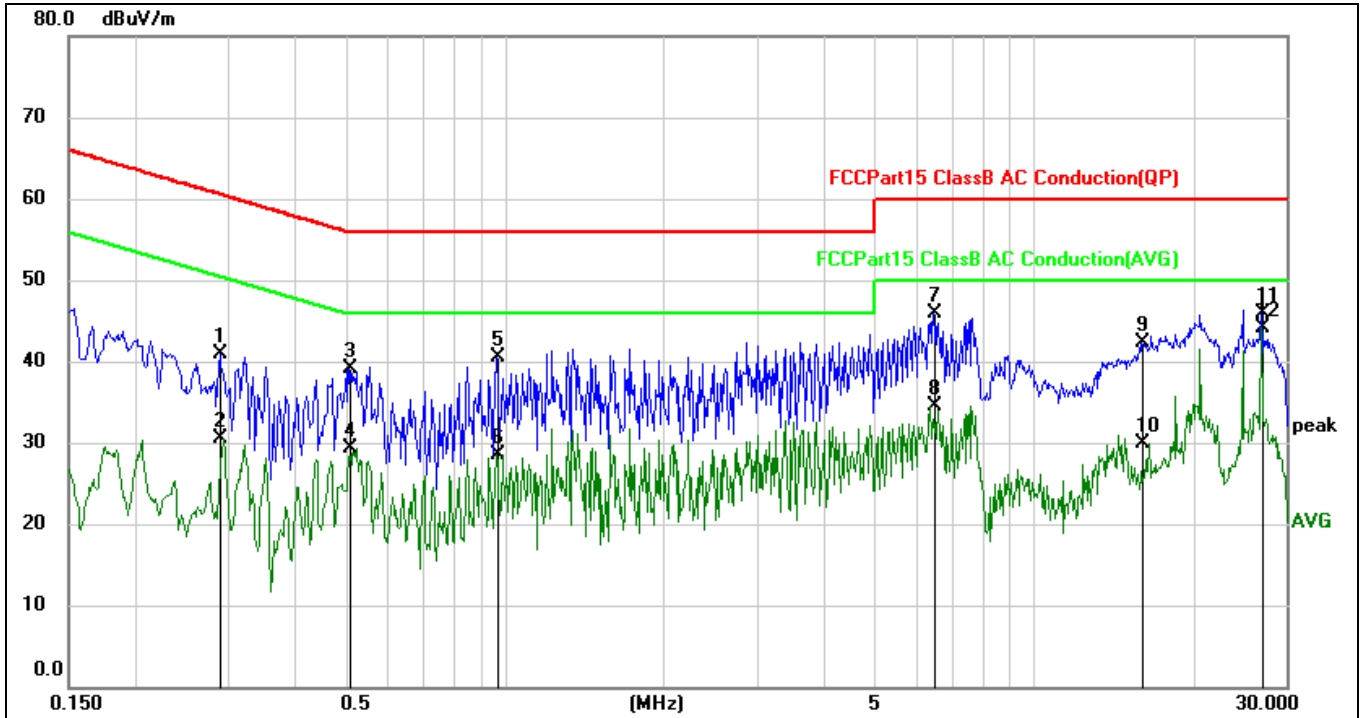

No.	Mk.	Freq. MHz	Reading Level dBuV/m	Correct Factor dB	Measure- ment dBuV/m	Limit dBuV/m	Over dB	Detector	Comment
1		0.2900	39.40	1.57	40.97	60.52	-19.55	QP	
2		0.2900	28.85	1.57	30.42	50.52	-20.10	AVG	
3		0.5100	37.44	1.57	39.01	56.00	-16.99	QP	
4		0.5100	27.77	1.57	29.34	46.00	-16.66	AVG	
5		0.9660	38.97	1.58	40.55	56.00	-15.45	QP	
6		0.9660	26.98	1.58	28.56	46.00	-17.44	AVG	
7		6.4739	45.47	0.37	45.84	60.00	-14.16	QP	
8		6.4739	34.04	0.37	34.41	50.00	-15.59	AVG	
9		16.0300	41.91	0.30	42.21	60.00	-17.79	QP	
10		16.0300	29.60	0.30	29.90	50.00	-20.10	AVG	
11		26.8660	45.61	0.35	45.96	60.00	-14.04	QP	
12	*	26.8660	43.73	0.35	44.08	50.00	-5.92	AVG	

## 5.5 Radiated spurious

### 5.5.1 Limits

20dBc in any 100 kHz bandwidth outside the operating frequency band. In case the emission fall within the restricted band specified on 15.205(a), then the 15.209(a) limit in the table below has to be followed.

Frequency (MHz)	Field Strength (micovolts/meter)	Measurement Distance (meters)
0.009~0.490	2400/F(KHz)	300
0.490~1.705	24000/F(KHz)	30
1.705~30.0	30	30
30~88	100	3
88~216	150	3
216~960	200	3
Above 960	500	3

Spectrum Parameter	Setting
Attenuation	Auto
Start Frequency	1000 MHz
Stop Frequency	10th carrier harmonic
RB / VB (emission in restricted band)	1 MHz / 1 MHz for Peak, 1 MHz / 10Hz for Average

Receiver Parameter	Setting
Attenuation	Auto
Start ~ Stop Frequency	9kHz~150kHz / RB 200Hz for QP
Start ~ Stop Frequency	150kHz~30MHz / RB 9kHz for QP
Start ~ Stop Frequency	30MHz~1000MHz / RB 120kHz for QP

5.5.2 Test setup

Radiated emission test-up frequency below 30MHz

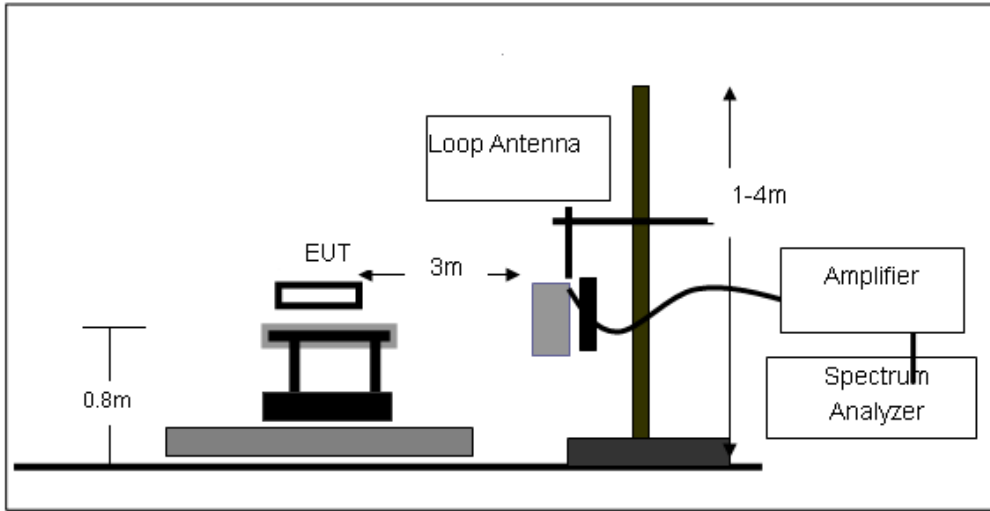

Radiated emission test-up frequency 30MHz~1GHz

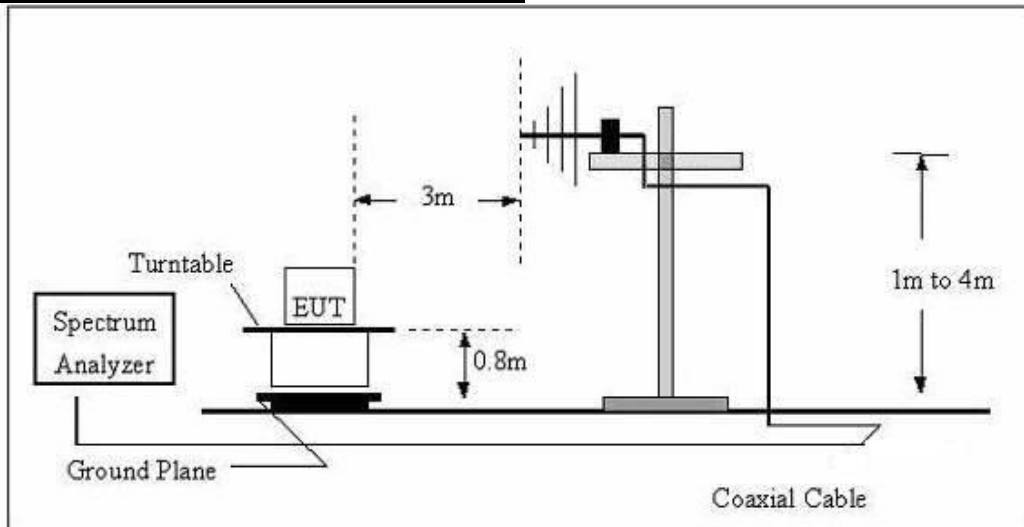

Radiated emission test-up frequency above 1GHz

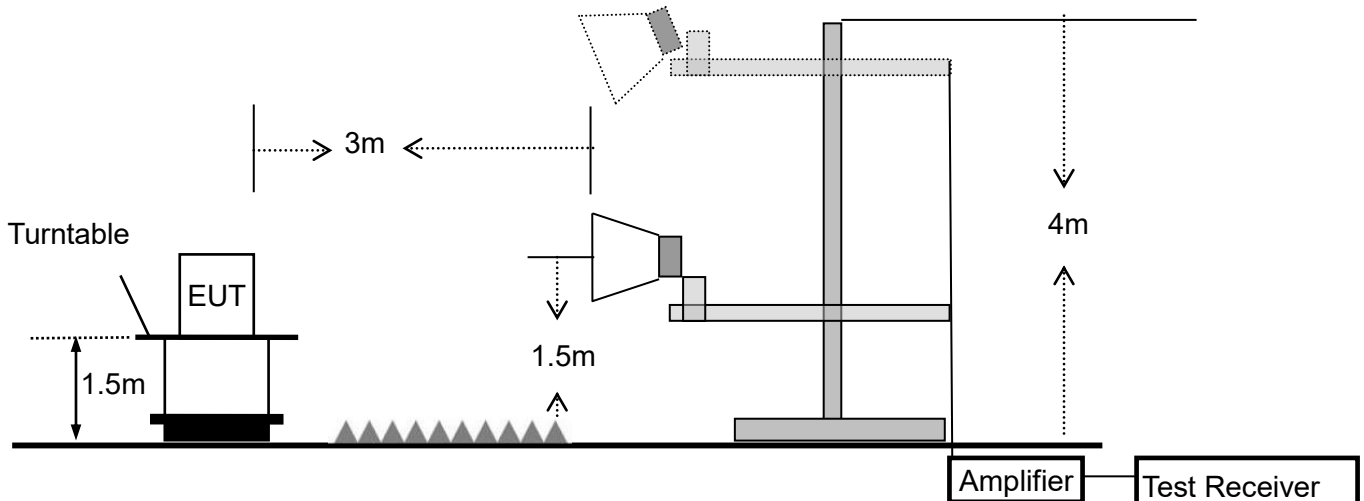



### 5.5.3 Test procedure

- a. EUT operating conditions. The EUT tested system was configured as the statements of 2.4 unless otherwise a special operating condition is specified in the follows during the testing.
- b. The measuring distance of at 3 m shall be used for measurements at frequency up to 1GHz. For frequencies above 1GHz, any suitable measuring distance may be used.
- c. The EUT was placed on the top of a rotating table 0.8 meters above the ground at a 3 meter open area test site. The table was rotated 360 degrees to determine the position of the highest radiation.
- d. The height of the equipment or of the substitution antenna shall be 0.8 m; the height of the test antenna shall vary between 1 m to 4 m. Both horizontal and vertical polarizations of the antenna are set to make the measurement.
- e. The initial step in collecting conducted emission data is a spectrum analyzer peak detector mode pre-scanning the measurement frequency range. Significant peaks are then marked and then Quasi Peak detector mode re-measured.
- f. If the Peak Mode measured value compliance with and lower than Quasi Peak Mode Limit, the EUT shall be deemed to meet QP Limits and then no additional QP Mode measurement performed.
- g. For the actual test configuration, please refer to the related Item –EUT Test photos.

Note: Both horizontal and vertical antenna polarities were tested and performed pretest to three orthogonal axis. The worst case emissions were reported

#### 5.5.4 Test results

##### 5.5.4.1 Radiation emission

###### Below 30MHz

EUT :	WiFi String Light	Model Name :	GW-W-SIRC
Relative Humidity:	52%	Phase:	H
Pressure:	1010 hPa	Test Voltage :	DC 12V from adapter AC 120V/60Hz
Test Mode :	TX		

Freq. (MHz)	Reading (dBuV/m)	Limit (dBuV/m)	Margin (dB)	State P/F
--	--	--	--	Pass
--	--	--	--	Pass

**Note:**

The amplitude of spurious emissions which are attenuated by more than 20dB below the permissible value has no need to be reported.

Distance extrapolation factor =  $40 \log(\text{specific distance}/\text{test distance})$ (dB);

Limit line = specific limits (dBuV) + distance extrapolation factor.

**Between 30MHz – 1GHz**

Note: all modes of EUT have been tested; only the data of worst case mode is reported.

The worst case mode is 802.11b CH01

EUT :	WiFi String Light	Model Name :	GW-W-SIRC
Relative Humidity:	52%	Phase:	H
Pressure:	1010 hPa	Test Voltage :	DC 12V from adapter AC 120V/60Hz
Test Mode :	TX+ Charging		

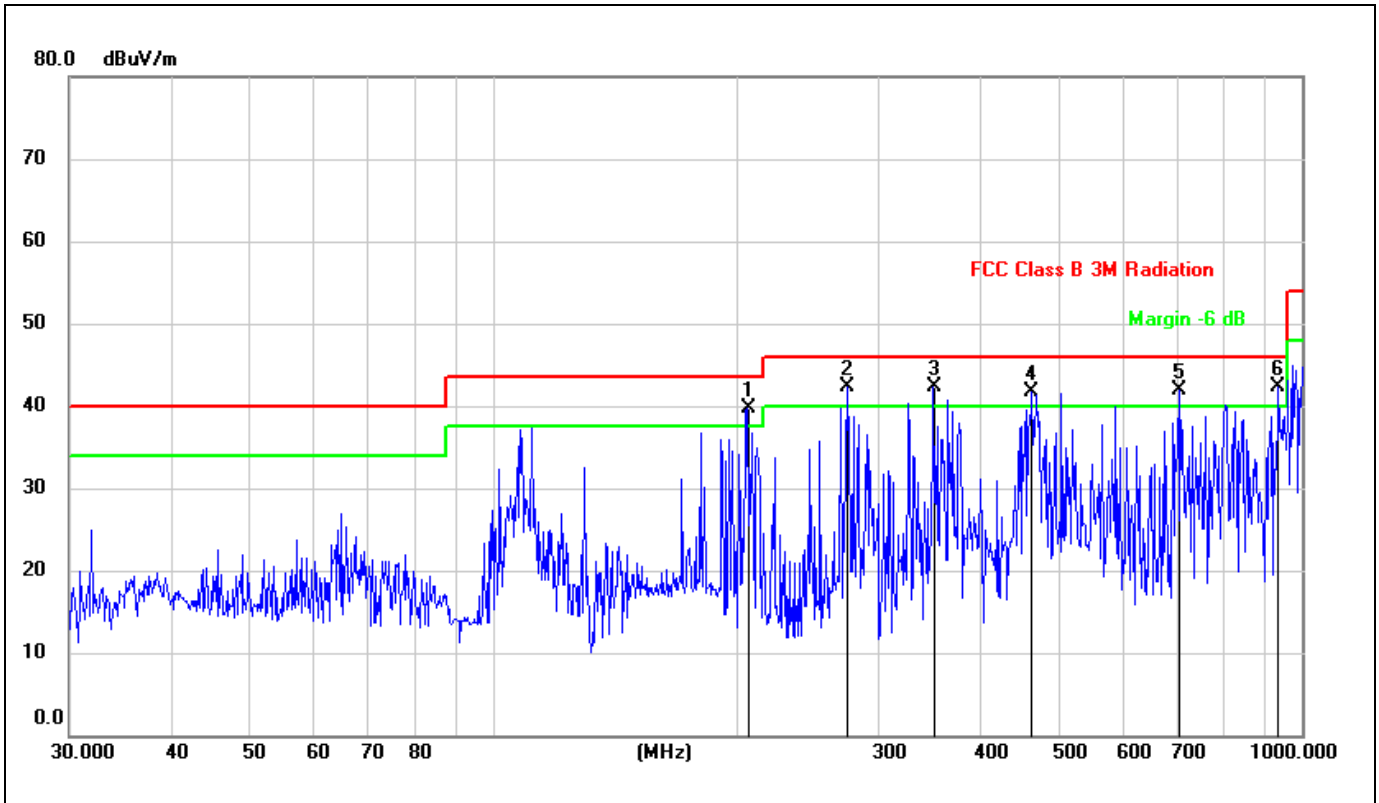

No.	Mk.	Freq. MHz	Reading Level dBuV	Correct Factor dBuV/m	Measure- ment dBuV/m	Limit dBuV/m	Over dB	Detector
1	!	206.3976	51.24	-11.50	39.74	43.50	-3.76	QP
2	!	274.1938	51.63	-9.34	42.29	46.00	-3.71	QP
3	!	350.4768	49.90	-7.58	42.32	46.00	-3.68	QP
4	!	463.9696	47.30	-5.61	41.69	46.00	-4.31	QP
5	!	704.2259	46.14	-4.16	41.98	46.00	-4.02	QP
6	*	935.5461	43.33	-0.95	42.38	46.00	-3.62	QP

EUT :	WiFi String Light	Model Name :	GW-W-SIRC
Relative Humidity:	52%	Phase:	V
Pressure:	1010 hPa	Test Voltage :	DC 12V from adapter AC 120V/60Hz
Test Mode :	TX+ Charging		

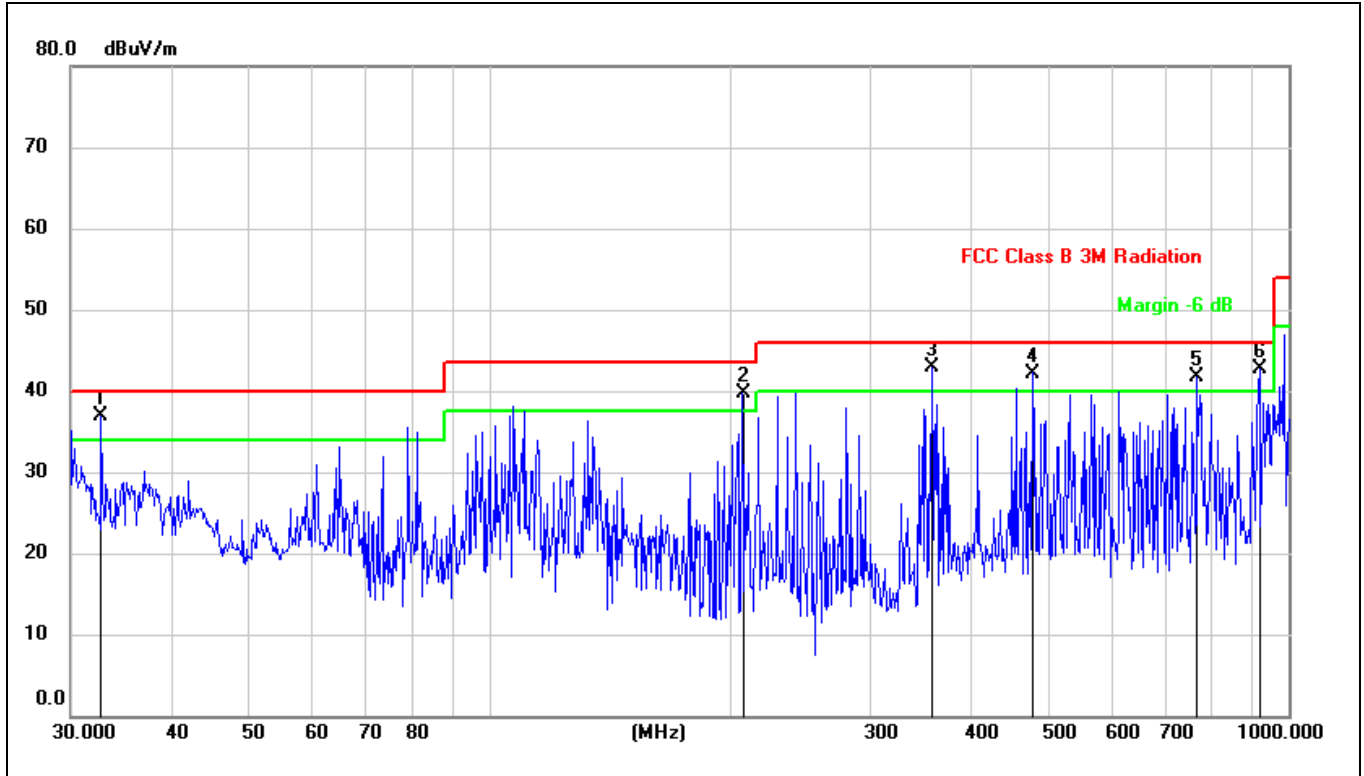

No.	Mk.	Freq.	Reading Level	Correct Factor	Measurement	Limit	Over	Detector
		MHz	dBuV	dBuV/m	dBuV/m	dBuV/m	dB	
1	*	32.7486	48.34	-11.39	36.95	40.00	-3.05	QP
2	!	207.1226	50.24	-10.48	39.76	43.50	-3.74	QP
3	!	357.9286	50.25	-7.43	42.82	46.00	-3.18	QP
4	!	478.8455	47.59	-5.39	42.20	46.00	-3.80	QP
5	!	768.7481	44.88	-3.24	41.64	46.00	-4.36	QP
6	!	919.2866	43.86	-1.10	42.76	46.00	-3.24	QP

**1G-25GHz**

Note: (1) All Readings are Peak Value (VBW=3MHz) and AV Value (VBW=10Hz).  
(2) Emission Level= Antenna Factor + Cable Loss + Read Level - Preamp Factor  
(3) All other emissions more than 20dB below the limit.

All the modulation modes have been tested, and the worst result was report as below:

Frequency	Read Level	Cable loss	Antenna Factor	Preamp Factor	Emission Level	Limits	Margin	Remark	Comment
(MHz)	(dBμV)	(dB)	dB/m	(dB)	(dBμV/m)	(dBμV/m)	(dB)		
Low Channel (2412 MHz)(802.11b)--Above 1G									
4824.161	62.62	4.36	32.92	45.53	54.37	74.00	-19.63	Pk	Vertical
4824.161	40.48	4.36	32.92	45.53	32.23	54.00	-21.77	AV	Vertical
7236.396	60.26	5.02	37.63	45.56	57.35	74.00	-16.65	Pk	Vertical
7236.396	43.59	5.02	37.63	45.56	40.68	54.00	-13.32	AV	Vertical
4824.154	60.81	4.36	32.92	45.53	52.56	74.00	-21.44	Pk	Horizontal
4824.154	42.81	4.36	32.92	45.53	34.56	54.00	-19.44	AV	Horizontal
7236.168	62.75	5.02	37.63	45.56	59.84	74.00	-14.16	Pk	Horizontal
7236.168	46.80	5.02	37.63	45.56	43.89	54.00	-10.11	AV	Horizontal
Middle Channel (2437 MHz)(802.11b)--Above 1G									
4874.112	62.36	4.41	33.01	45.76	54.02	74.00	-19.98	Pk	Vertical
4874.112	42.96	4.41	33.01	45.76	34.62	54.00	-19.38	AV	Vertical
7311.247	59.81	5.02	37.68	45.59	56.92	74.00	-17.08	Pk	Vertical
7311.247	47.50	5.02	37.68	45.59	44.61	54.00	-9.39	AV	Vertical
4874.132	61.07	4.41	33.01	45.76	52.73	74.00	-21.27	Pk	Horizontal
4874.132	48.16	4.41	33.01	45.76	39.82	54.00	-14.18	AV	Horizontal
7311.085	59.20	5.02	37.68	45.59	56.31	74.00	-17.69	Pk	Horizontal
7311.085	41.87	5.02	37.68	45.59	38.98	54.00	-15.02	AV	Horizontal
High Channel (2462 MHz)(802.11b)--Above 1G									
4924.169	65.59	4.50	33.26	46.07	57.28	74.00	-16.72	Pk	Vertical
4924.169	42.28	4.50	33.26	46.07	33.97	54.00	-20.03	AV	Vertical
7386.215	61.21	5.02	37.78	45.77	58.24	74.00	-15.76	Pk	Vertical
7386.215	44.43	5.02	37.78	45.77	41.46	54.00	-12.54	AV	Vertical
4924.045	66.58	4.50	33.26	46.07	58.27	74.00	-15.73	Pk	Horizontal
4924.045	46.86	4.50	33.26	46.07	38.55	54.00	-15.45	AV	Horizontal
7386.132	60.81	5.02	37.78	45.77	57.84	74.00	-16.16	Pk	Horizontal
7386.132	44.41	5.02	37.78	45.77	41.44	54.00	-12.56	AV	Horizontal

5.5.4.2 Band edge - radiated

Note: (1) All Readings are Peak Value (VBW=3MHz) and AV Value (VBW=10Hz).  
 (2) Emission Level= Antenna Factor + Cable Loss + Read Level - Preamp Factor  
 (3) All other emissions more than 20dB below the limit.

Frequency	Meter Reading	Cable Loss	Antenna Factor	Preamp Factor	Emission Level	Limits	Margin	Detector	Comment
(MHz)	(dBμV)	(dB)	dB/m	(dB)	(dBμV/m)	(dBμV/m)	(dB)	Type	
802.11b									
2310.00	56.32	2.40	27.70	40.40	46.02	74	-27.98	Pk	Horizontal
2310.00	43.51	2.40	27.70	40.40	33.21	54	-20.79	AV	Horizontal
2310.00	59.02	2.40	27.70	40.40	48.72	74	-25.28	Pk	Vertical
2310.00	41.89	2.40	27.70	40.40	31.59	54	-22.41	AV	Vertical
2390.00	57.77	2.44	28.30	40.10	48.41	74	-25.59	Pk	Vertical
2390.00	41.75	2.44	28.30	40.10	32.39	54	-21.61	AV	Vertical
2390.00	57.16	2.44	28.30	40.10	47.80	74	-26.20	Pk	Horizontal
2390.00	41.89	2.44	28.30	40.10	32.53	54	-21.47	AV	Horizontal
2483.50	57.85	2.48	28.70	39.80	49.23	74	-24.77	Pk	Vertical
2483.50	42.99	2.48	28.70	39.80	34.37	54	-19.63	AV	Vertical
2483.50	58.91	2.48	28.70	39.80	50.29	74	-23.71	Pk	Horizontal
2483.50	42.11	2.48	28.70	39.80	33.49	54	-20.51	AV	Horizontal
802.11g									
2310.00	58.66	2.40	27.70	40.40	48.36	74	-25.64	Pk	Horizontal
2310.00	44.30	2.40	27.70	40.40	34.00	54	-20.00	AV	Horizontal
2310.00	56.58	2.40	27.70	40.40	46.28	74	-27.72	Pk	Vertical
2310.00	43.09	2.40	27.70	40.40	32.79	54	-21.21	AV	Vertical
2390.00	57.36	2.44	28.30	40.10	48.00	74	-26.00	Pk	Vertical
2390.00	41.77	2.44	28.30	40.10	32.41	54	-21.59	AV	Vertical
2390.00	58.16	2.44	28.30	40.10	48.80	74	-25.20	Pk	Horizontal
2390.00	43.62	2.44	28.30	40.10	34.26	54	-19.74	AV	Horizontal
2483.50	59.05	2.48	28.70	39.80	50.43	74	-23.57	Pk	Vertical
2483.50	44.00	2.48	28.70	39.80	35.38	54	-18.62	AV	Vertical
2483.50	58.67	2.48	28.70	39.80	50.05	74	-23.95	Pk	Horizontal
2483.50	41.73	2.48	28.70	39.80	33.11	54	-20.89	AV	Horizontal

802.11n20									
2310.00	57.53	2.40	27.70	40.40	47.23	74	-26.77	Pk	Horizontal
2310.00	43.93	2.40	27.70	40.40	33.63	54	-20.37	AV	Horizontal
2310.00	58.42	2.40	27.70	40.40	48.12	74	-25.88	Pk	Vertical
2310.00	42.14	2.40	27.70	40.40	31.84	54	-22.16	AV	Vertical
2390.00	57.54	2.44	28.30	40.10	48.18	74	-25.82	Pk	Vertical
2390.00	41.85	2.44	28.30	40.10	32.49	54	-21.51	AV	Vertical
2390.00	57.04	2.44	28.30	40.10	47.68	74	-26.32	Pk	Horizontal
2390.00	41.88	2.44	28.30	40.10	32.52	54	-21.48	AV	Horizontal
2483.50	57.62	2.48	28.70	39.80	49.00	74	-25.00	Pk	Vertical
2483.50	42.54	2.48	28.70	39.80	33.92	54	-20.08	AV	Vertical
2483.50	58.96	2.48	28.70	39.80	50.34	74	-23.66	Pk	Horizontal
2483.50	42.54	2.48	28.70	39.80	33.92	54	-20.08	AV	Horizontal

5.5.4.3 Spurious Emission in Restricted Band 3260MMHz-18000MHz

All the modulation modes have been tested, and the worst result (802.11b at 2412MHz)was report as below:

Frequency	Reading	Cable	Antenna	Preamp	Emission	Limits	Margin	Detector	Comment
(MHz)	(dB $\mu$ V)	(dB)	dB/m	(dB)	(dB $\mu$ V/m)	(dB $\mu$ V/m)	(dB)	Type	
3260	60.75	3.27	30.02	38.05	55.99	74	-18.01	Pk	Vertical
3260	55.75	3.27	30.02	38.05	50.99	54	-3.01	AV	Vertical
3260	61.61	3.27	30.02	38.05	56.85	74	-17.15	Pk	Horizontal
3260	56.33	3.27	30.02	38.05	51.57	54	-2.43	AV	Horizontal
3332	65.13	3.31	30.00	37.91	60.53	74	-13.47	Pk	Vertical
3332	53.44	3.31	30.00	37.91	48.84	54	-5.16	AV	Vertical
3332	62.58	3.31	30.00	37.91	57.98	74	-16.02	Pk	Horizontal
3332	52.40	3.31	30.00	37.91	47.80	54	-6.20	AV	Horizontal
17797	43.08	8.63	44.23	39.60	56.34	74	-17.66	Pk	Vertical
17797	32.74	8.63	44.23	39.60	46.00	54	-8.00	AV	Vertical
17788	43.83	8.63	44.23	39.60	57.09	74	-16.91	Pk	Horizontal
17788	32.04	8.63	44.23	39.60	45.30	54	-8.70	AV	Horizontal



## 5.6 Conduction spurious emission

### 5.6.1 Limits

In any 100 kHz bandwidth outside the frequency band in which the spread spectrum or digitally modulated intentional radiator is operating, the radio frequency power that is produced by the intentional radiator shall be at least 20 dB below that in the 100 kHz bandwidth within the band that contains the highest level of the desired power, based on either an RF conducted or a radiated measurement, provided the transmitter demonstrates compliance with the peak conducted power limits. If the transmitter complies with the conducted power limits based on the use of RMS averaging over a time interval, as permitted under paragraph (b)(3) of this section, the attenuation required under this paragraph shall be 30 dB instead of 20 dB. Attenuation below the general limits specified in §15.209(a) is not required. In addition, radiated emissions which fall in the restricted bands, as defined in §15.205(a), must also comply with the radiated emission limits specified in §15.209(a) (see §15.205(c)).

### 5.6.2 Test setup



### 5.6.3 Test procedure

- a) Check the calibration of the measuring instrument using either an internal calibrator or a known signal from an external generator.
- b) Position the EUT without connection to measurement instrument. Turn on the EUT and connect its antenna terminal to measurement instrument via a low loss cable. Then set it to any one measured frequency within its operating range, and make sure the instrument is operated in its linear range.
- c) Set RBW to 100 kHz and VBW of spectrum analyzer to 300 kHz with a convenient frequency span including 100 kHz bandwidth from band edge.
- d) Measure the highest amplitude appearing on spectral display and set it as a reference level. Plot the graph with marking the highest point and edge frequency.
- e) Repeat above procedures until all measured frequencies were complete.

#### EUT OPERATION CONDITIONS

The EUT tested system was configured as the statements of 2.4 unless otherwise a special operating condition is specified in the follows during the testing.

5.6.4 Test results

Test plots:

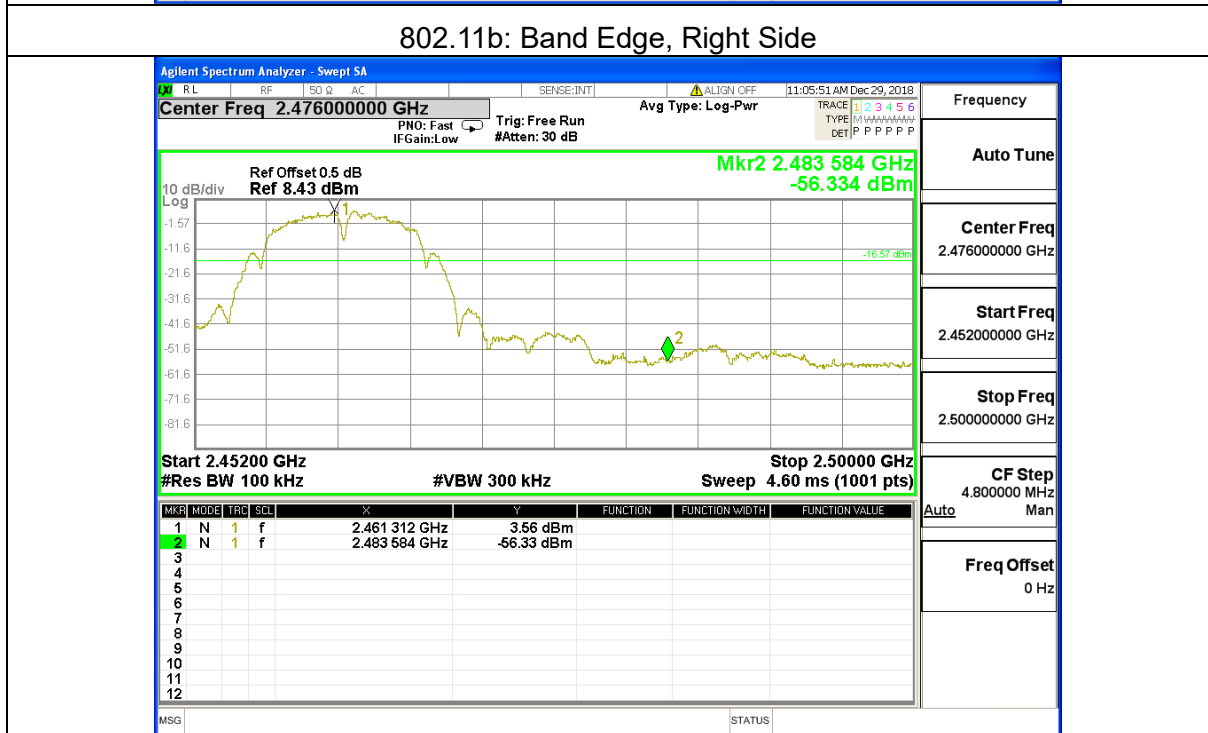
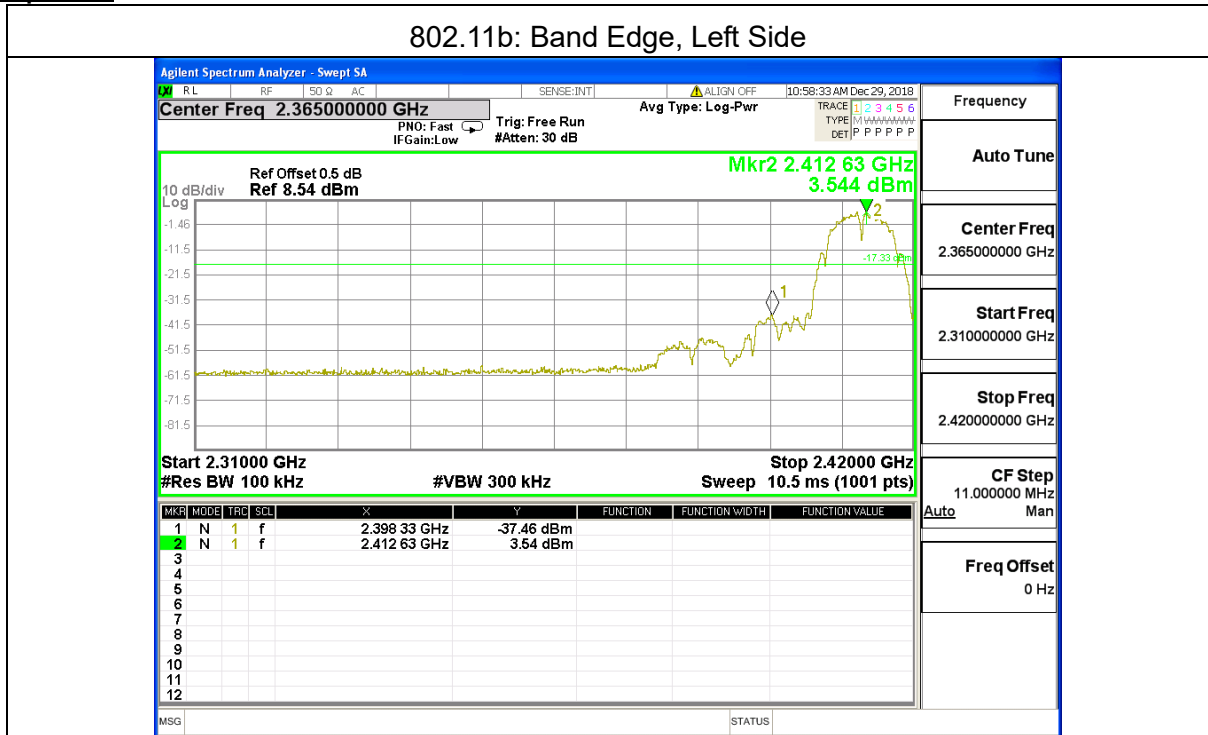

802.11g: Band Edge, Left Side

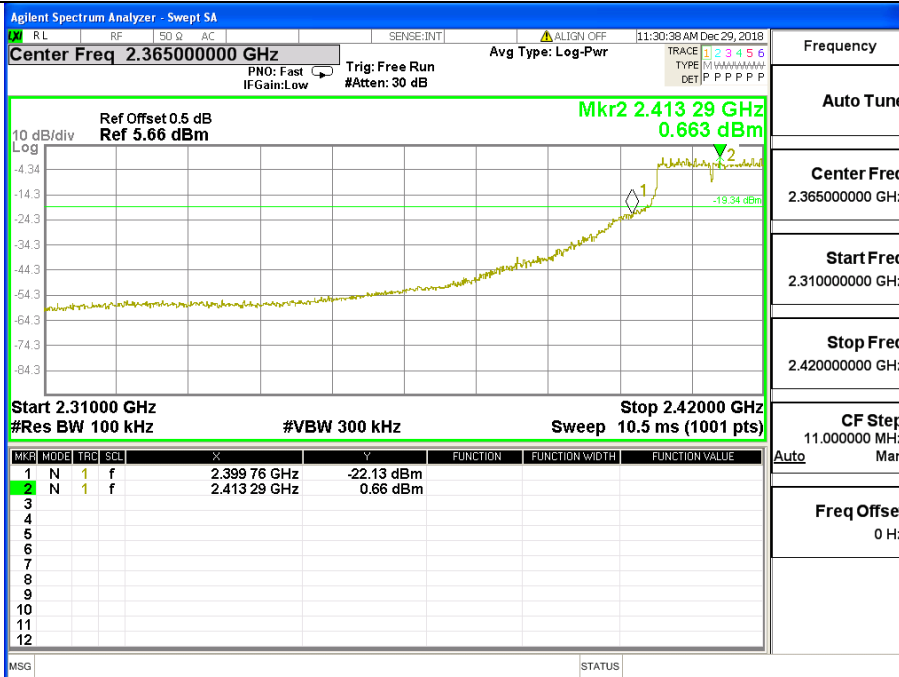

802.11g: Band Edge, Right Side

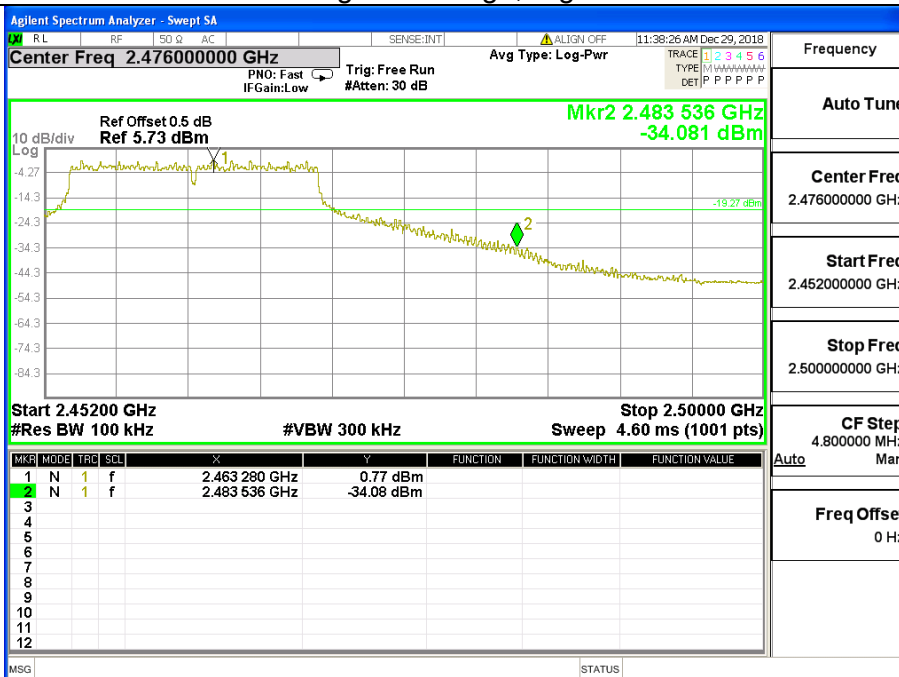

802.11n20: Band Edge, Left Side

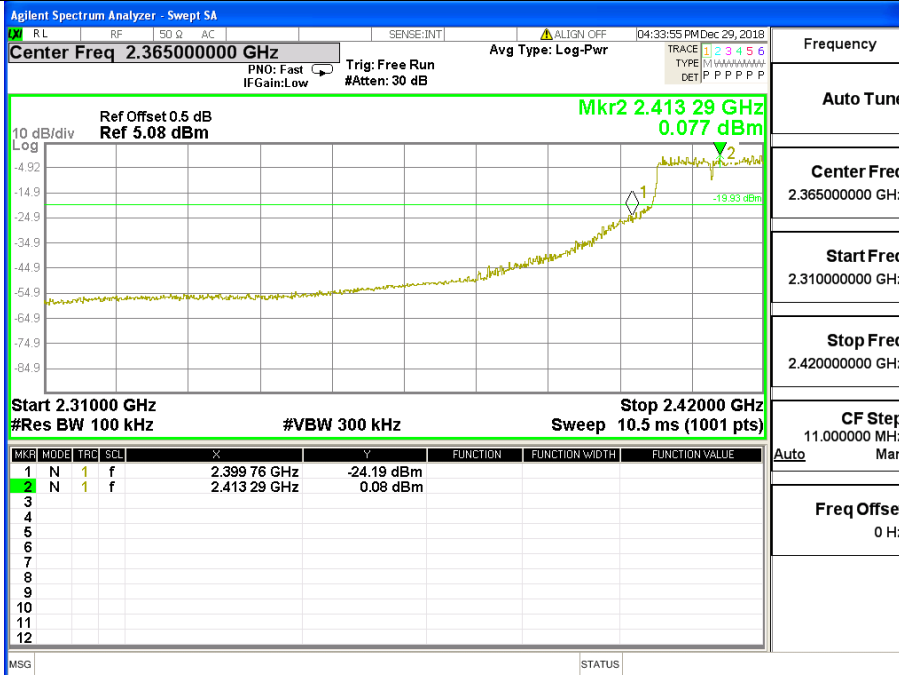

802.11n20: Band Edge, Right Side

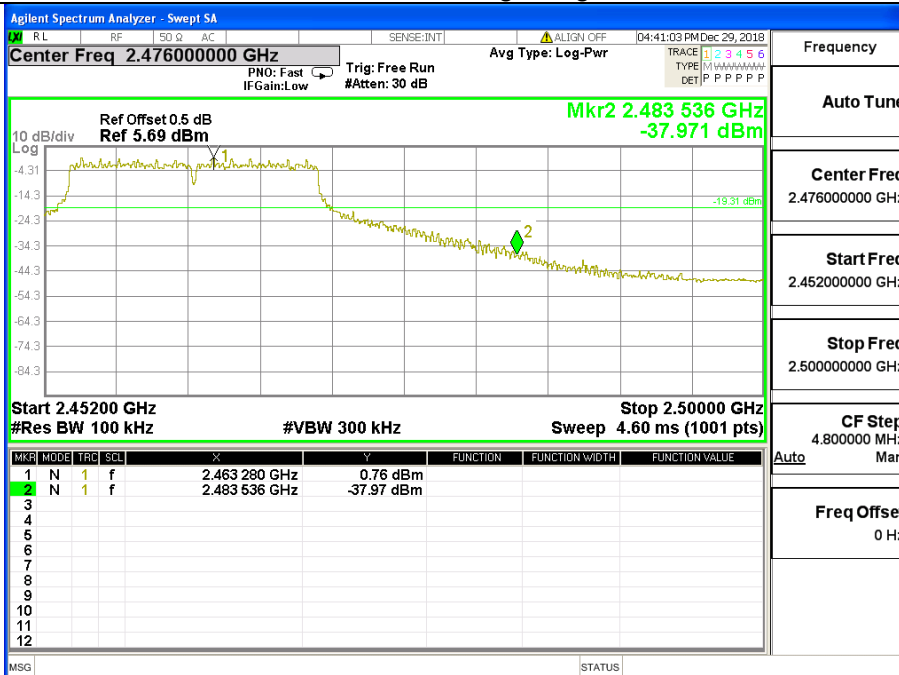

5.7 6dB bandwidth

5.7.1 Limit

FCC Part15 Subpart C				
Section	Test Item	Limit	Frequency Range (MHz)	Result
15.247(a)(2)	Bandwidth	$\geq 500\text{KHz}$ (6dB bandwidth)	2400-2483.5	Pass

5.7.2 Test setup



5.7.3 Test procedure

- a. Set RBW= 100 kHz.
- b. Set the video bandwidth (VBW)  $\geq 3 \times$  RBW.
- c. Detector = Peak.
- d. Trace mode = max hold.
- e. Sweep = auto couple.
- f. Allow the trace to stabilize.
- g. Measure the maximum width of the emission that is constrained by the frequencies associated with the two outermost amplitude points (upper and lower) that are attenuated by 6 dB relative to the maximum level measured in the fundamental emission.

5.7.4 Test results

EUT :	WiFi String Light	Model Name :	GW-W-SIRC
Temperature :	25 °C	Relative Humidity :	60%
Pressure :	1012 hPa	Test Voltage :	DC 12V from adapter
Test Mode :	TX b Mode /CH01, CH06, CH11		

Channel	Frequency (MHz)	6dB bandwidth (MHz)	Limit (kHz)	Result
Low	2412	7.695	500	Pass
Middle	2437	7.849	500	Pass
High	2462	7.610	500	Pass

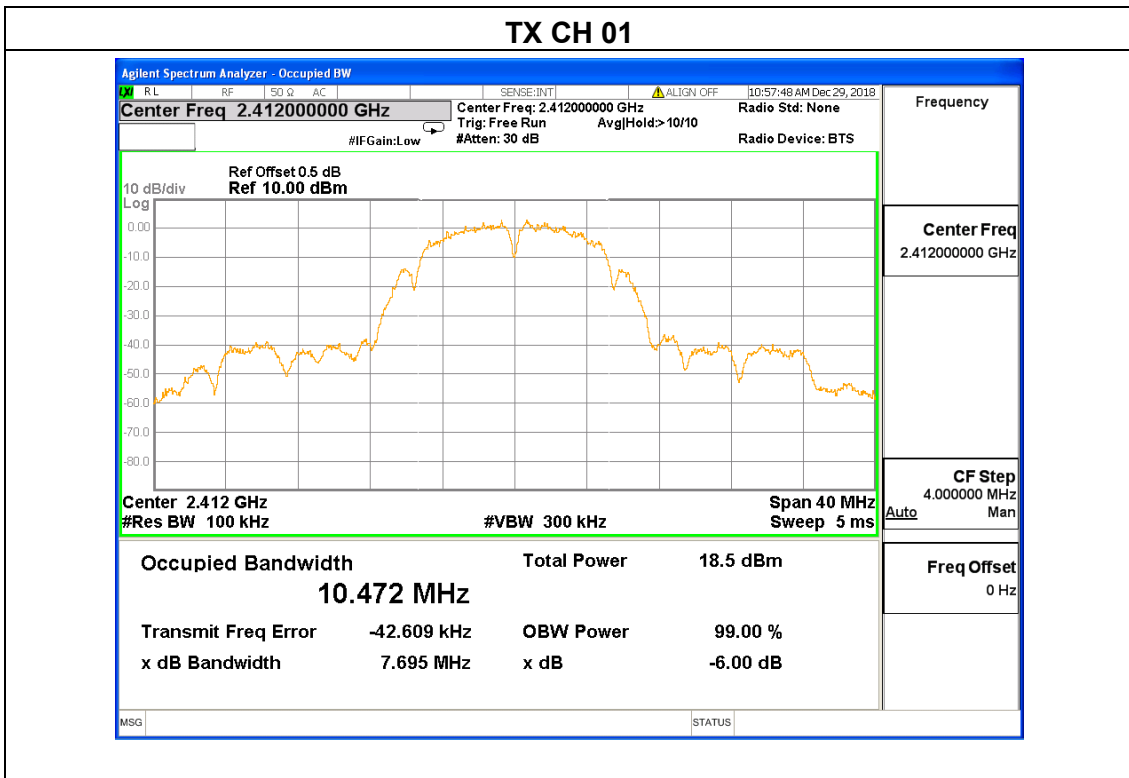

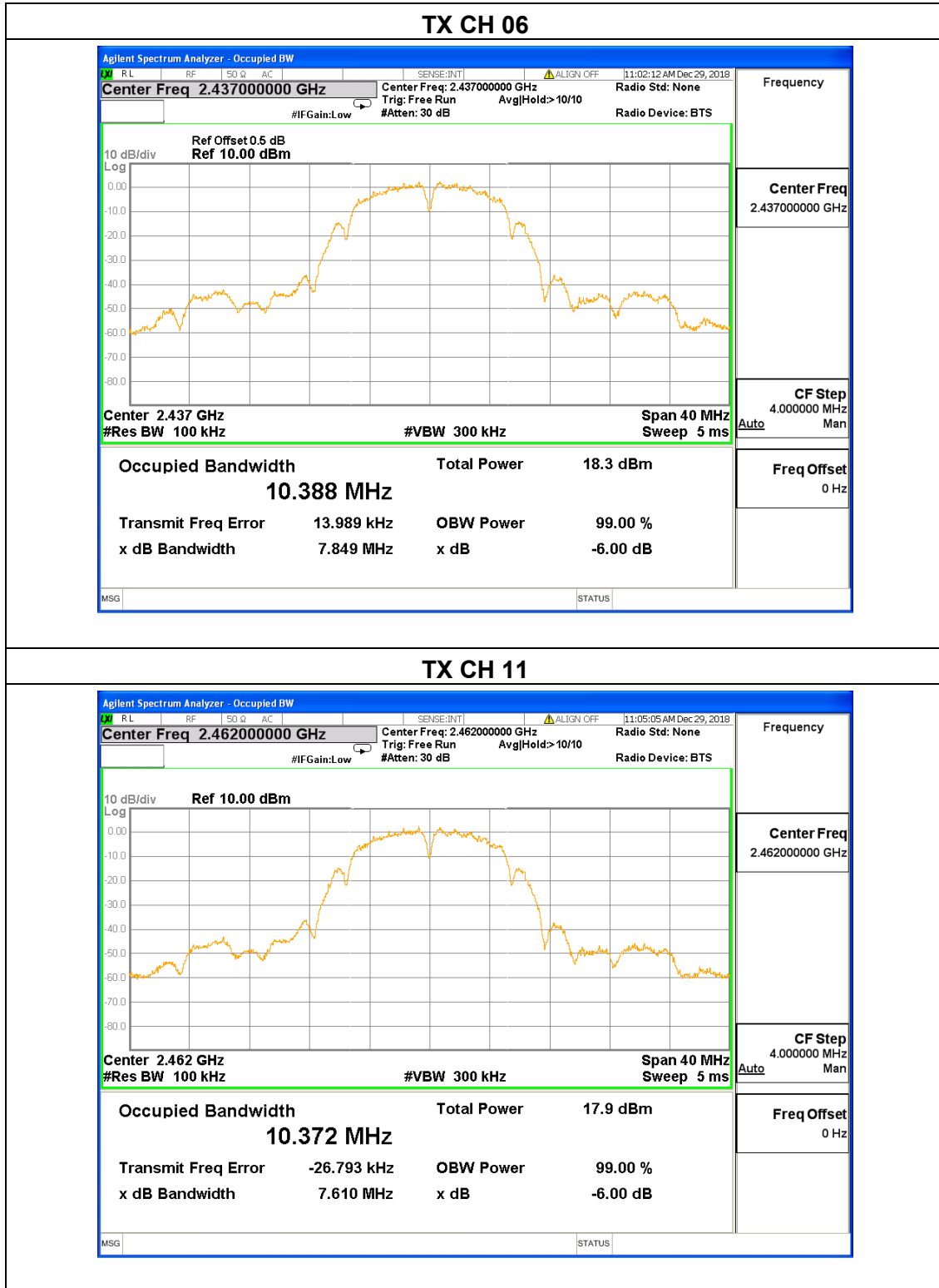

EUT :	WiFi String Light	Model Name :	GW-W-SIRC
Temperature :	25 °C	Relative Humidity :	60%
Pressure :	1012 hPa	Test Voltage :	DC 12V from adapter
Test Mode :	TX g Mode /CH01, CH06, CH11		

Channel	Frequency (MHz)	6dB bandwidth (MHz)	Limit (kHz)	Result
Low	2412	16.51	500	Pass
Middle	2437	16.50	500	Pass
High	2462	16.51	500	Pass

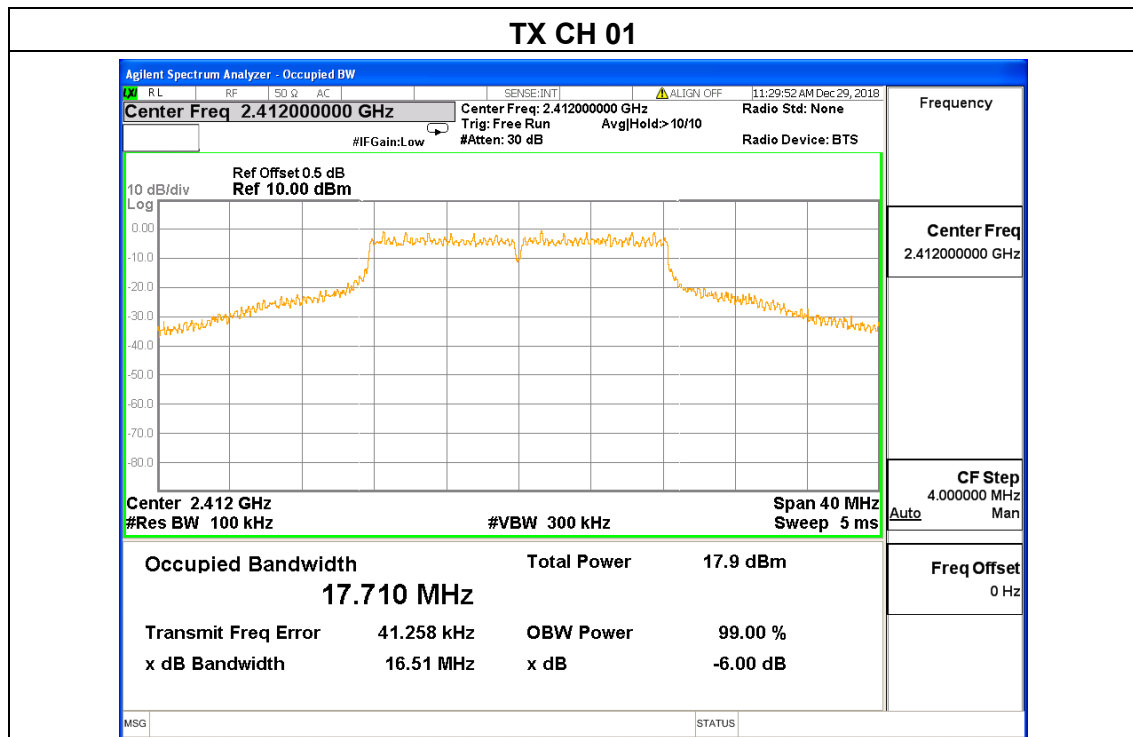



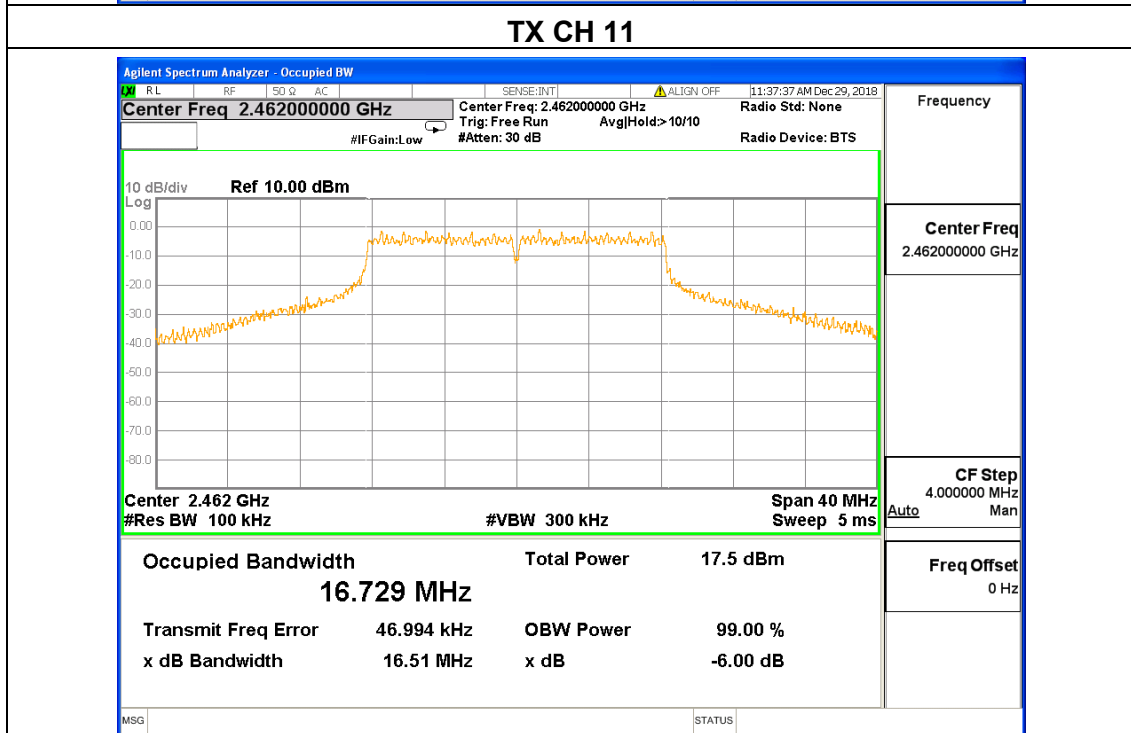
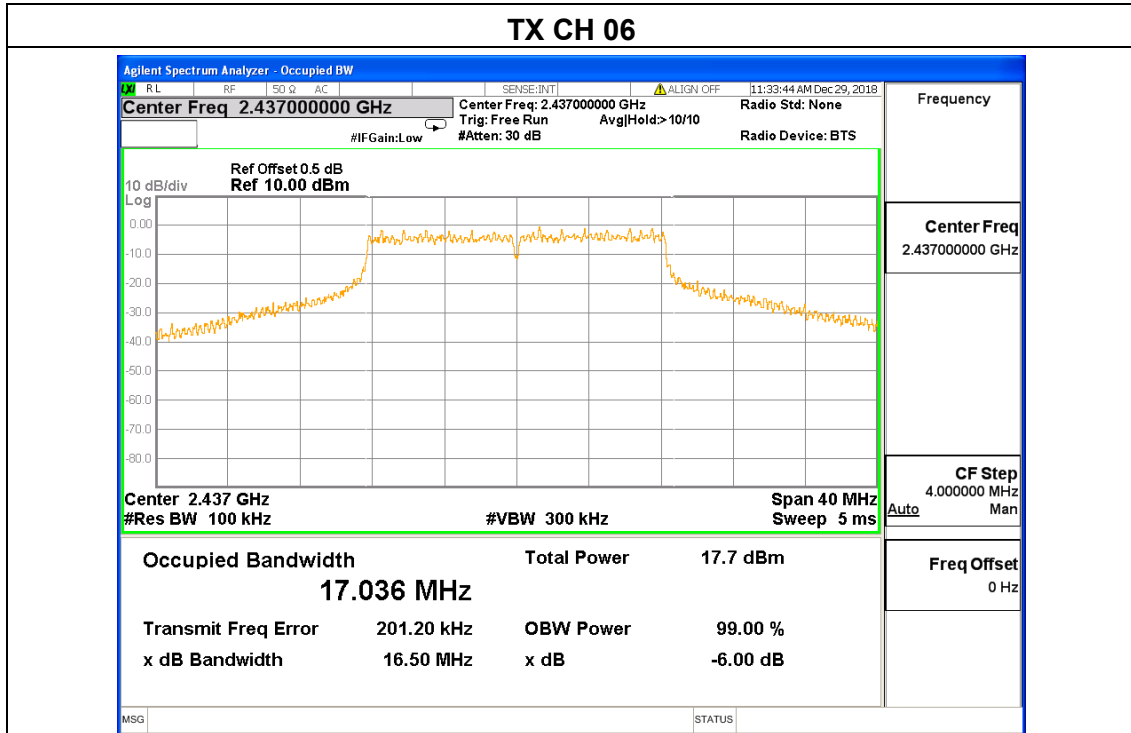

EUT :	WiFi String Light	Model Name :	GW-W-SIRC
Temperature :	25 °C	Relative Humidity :	60%
Pressure :	1012 hPa	Test Voltage :	DC 12V from adapter
Test Mode :	TX n20 Mode /CH01, CH06, CH11		

Channel	Frequency (MHz)	6dB bandwidth (MHz)	Limit (kHz)	Result
Low	2412	16.50	500	Pass
Middle	2437	16.49	500	Pass
High	2462	16.50	500	Pass

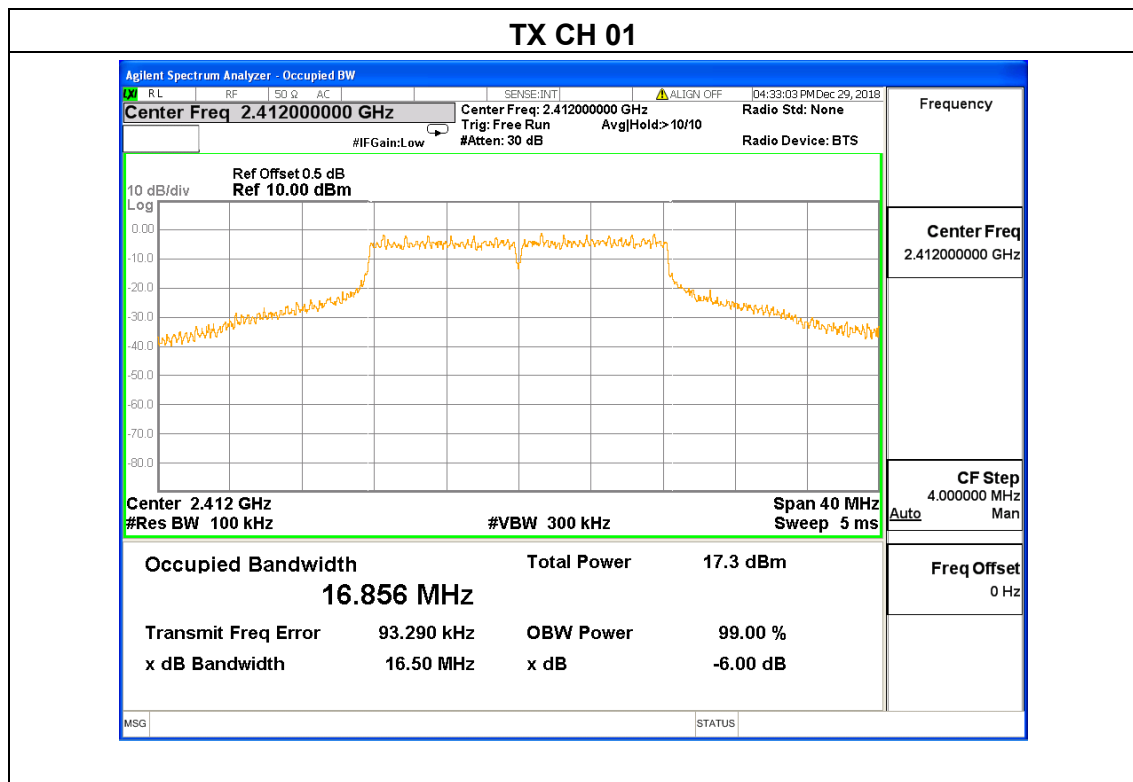

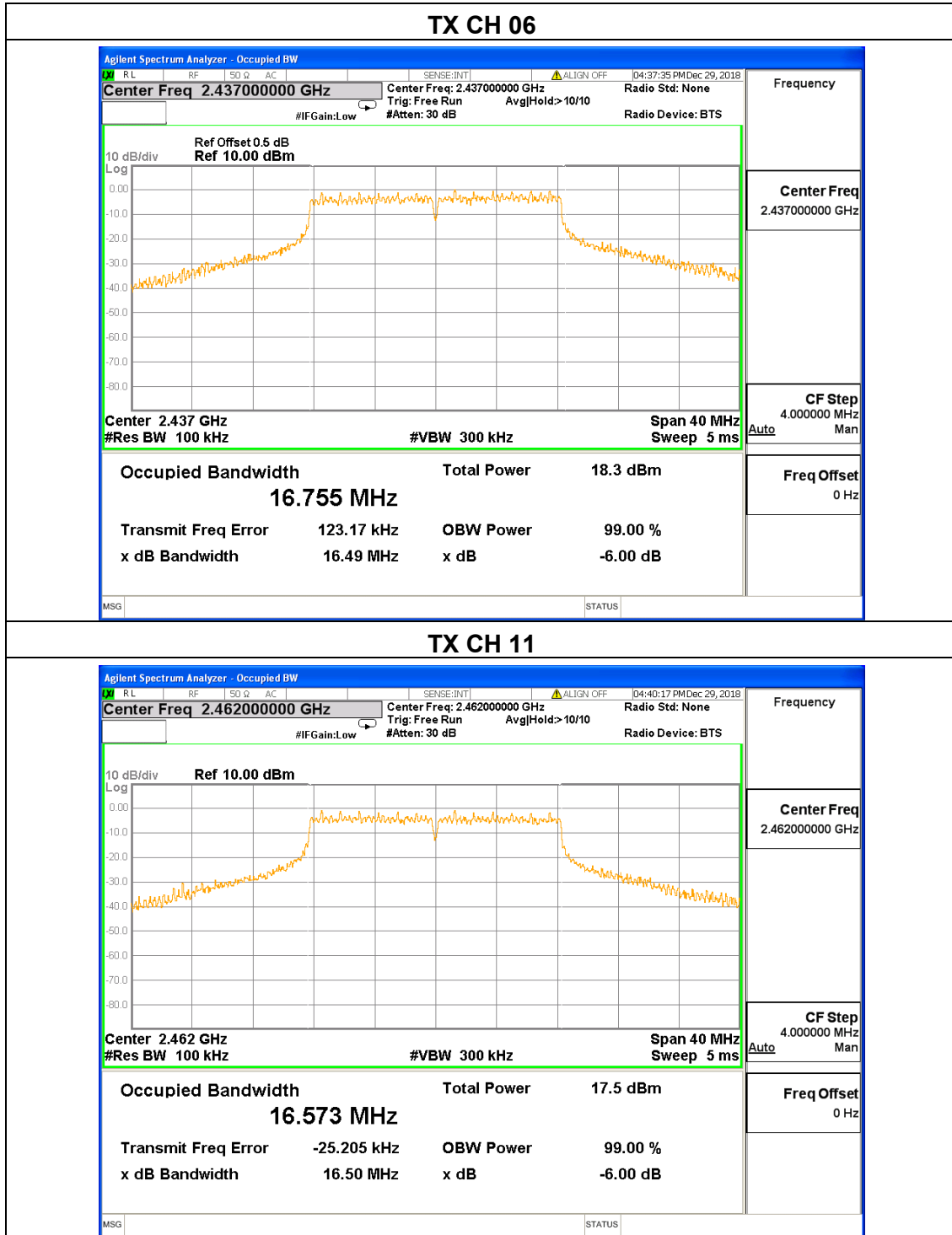

## 5.8 Spurious RF Conducted Emissions

### 5.8.1 Conformance Limit

1. Below -20dB of the highest emission level in operating band.

### 5.8.2 Measuring Instruments

The Measuring equipment is listed in the section 6.3 of this test report.

### 5.8.3 Test Setup

Please refer to Section 6.1 of this test report.

### 5.8.4 Test Procedure

The Spurious RF conducted emissions compliance of RF radiated emission should be measured by following the guidance in ANSI C63.10-2013 with respect to maximizing the emission by rotating the EUT, measuring the emission while the EUT is situated in three orthogonal planes (if appropriate), adjusting the measurement antenna height and polarization etc. Set RBW=100kHz and VBW=300kHz to measure the peak field strength, and measure frequency range from 9kHz to 26.5GHz.

### 5.8.5 Test Results

Remark: The measurement frequency range is from 9kHz to the 10th harmonic of the fundamental frequency. The lowest, middle and highest channels are tested to verify the spurious emissions and bandedge measurement data.

Note: all modes of EUT have been tested; only the data of worst case mode is reported.  
The worst case mode is 802.11b

802.11b on Channel 01

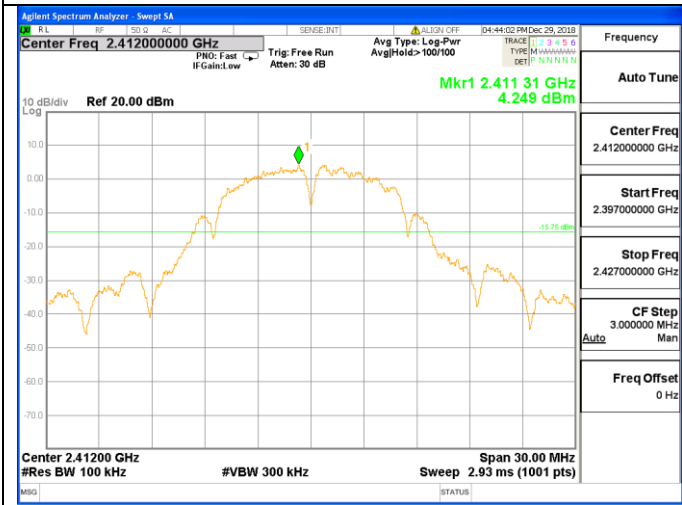

802.11b on Channel 01

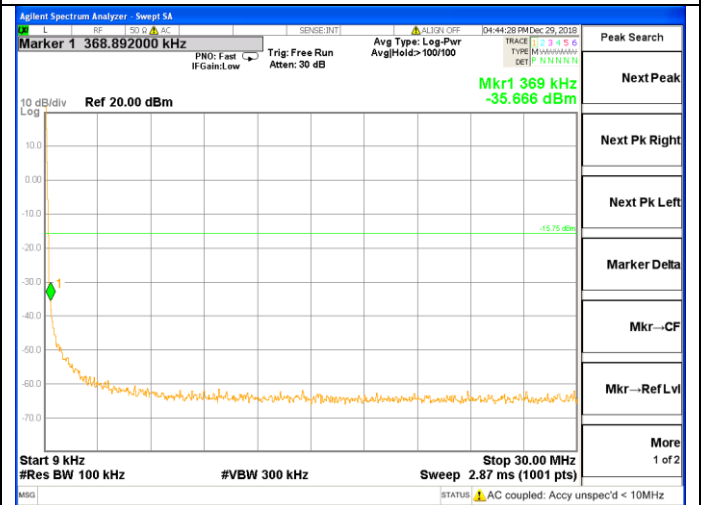

802.11b on Channel 01

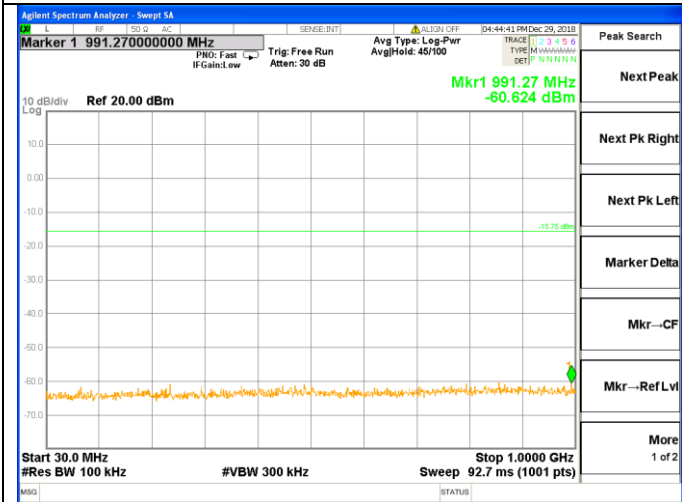

802.11b on Channel 01

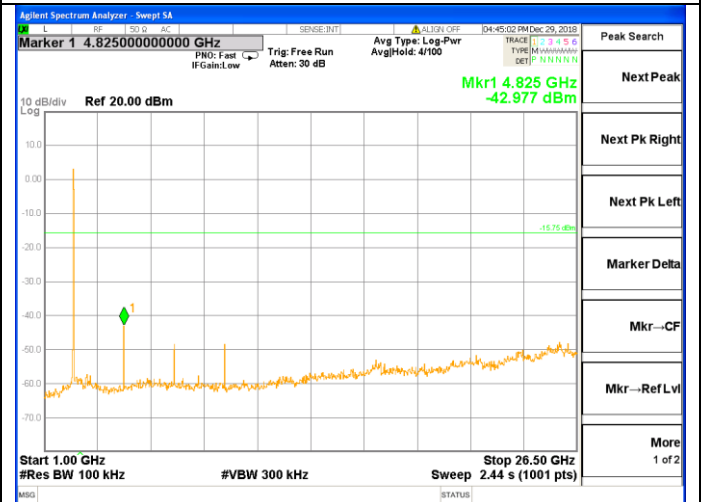

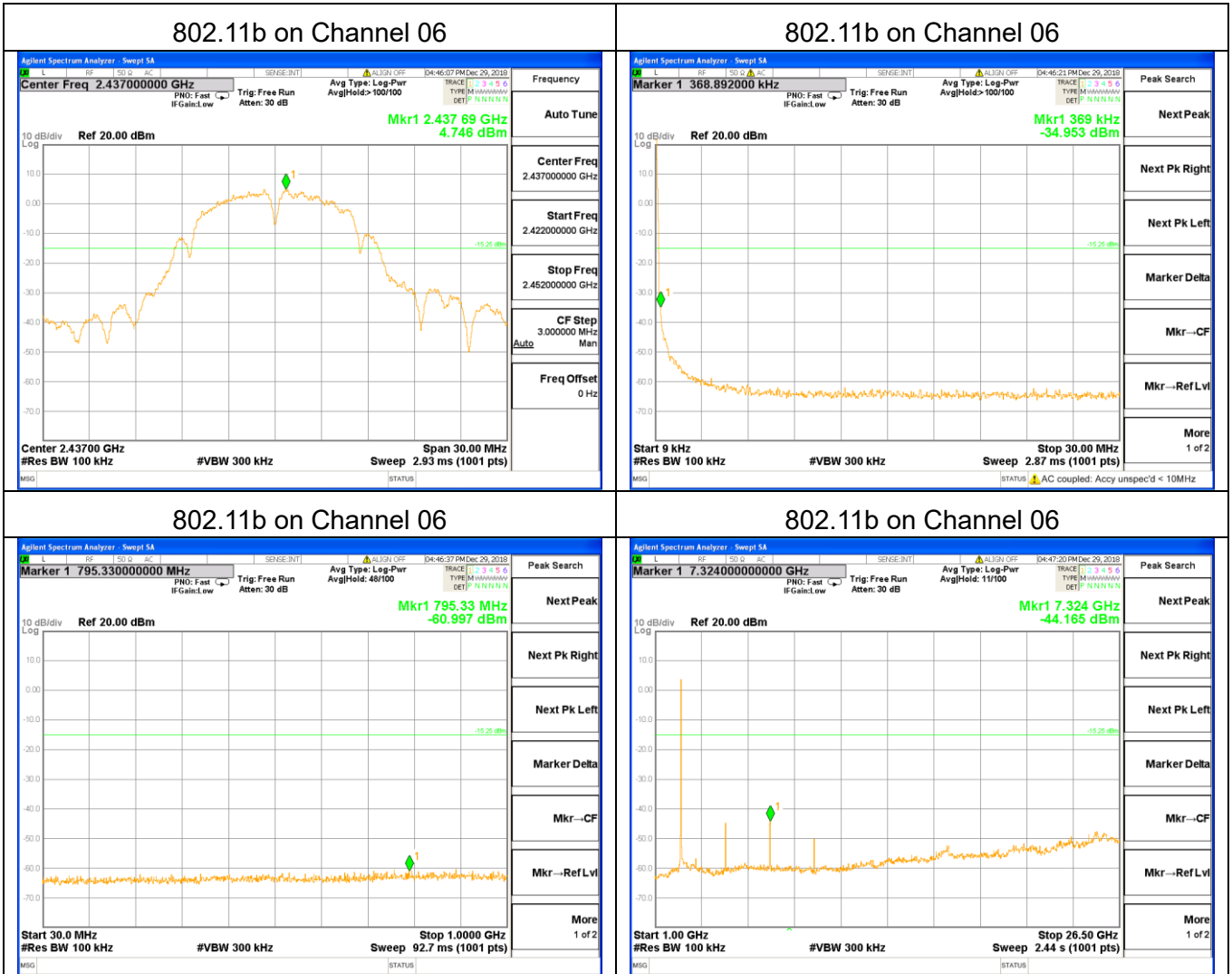

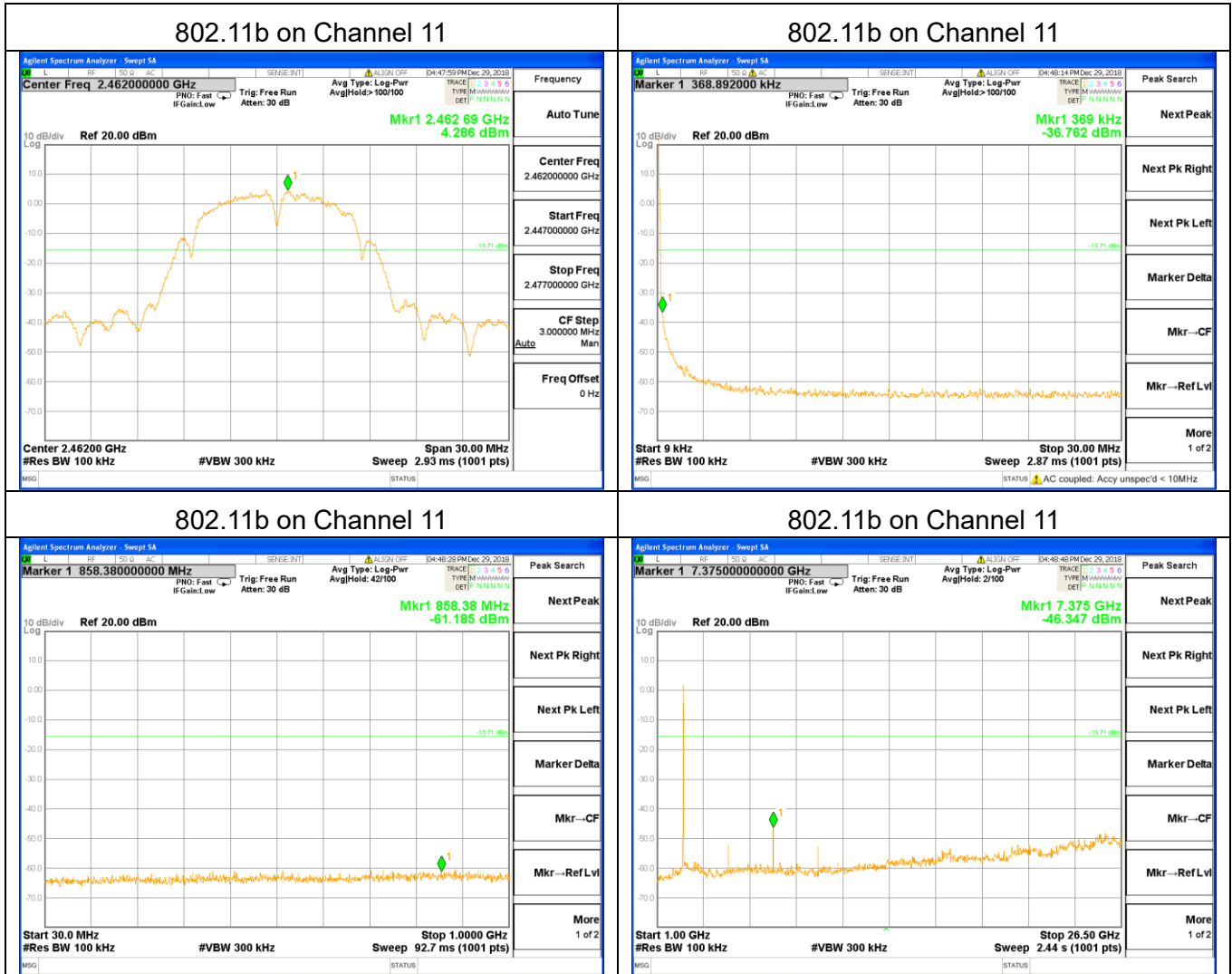

**Photographs of the Test Setup**

Radiated emission

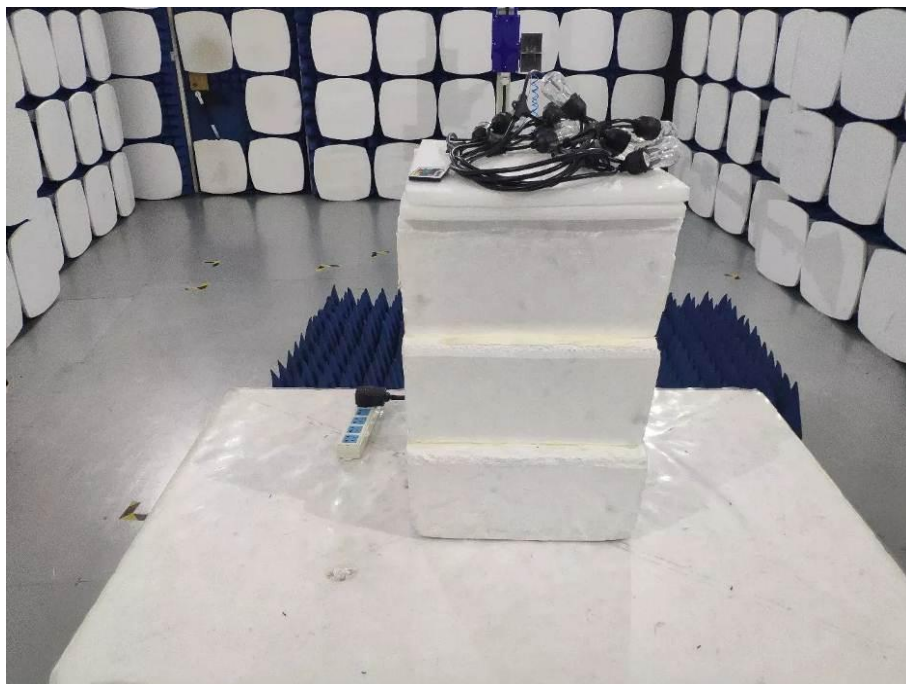
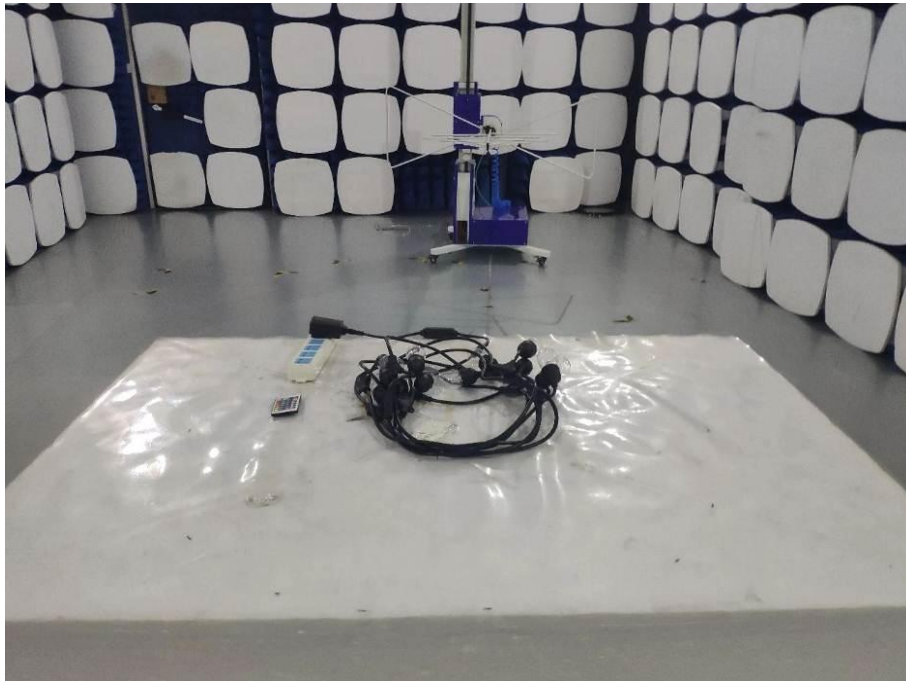



**Photographs of the EUT**

See the APPENDIX 1: EUT PHOTO in the report No.: MTi190104E027-1.

**---END OF REPORT---**