

FCC 47 CFR PART 15 SUBPART C
CERTIFICATION TEST REPORT

Remote Control Puck light

MODEL No.: 39154

Trademark: N/A

FCC ID: 2AP9MNDF- 39154

REPORT NO: ES180612039W

ISSUE DATE: July 13, 2018

Prepared for

NINGHAI NEWORIENTAL PLASTICS INDUSTRY CO., LTD
BINHAI INDUSTRIAL ESTATE, XIDIAN TOWN, NINGHAI, ZHEJIANG, CHINA

Prepared by

EMTEK (SHENZHEN) CO., LTD.

Bldg 69, Majialong Industry Zone, Nanshan District,
Shenzhen, Guangdong, China
TEL: 86-755-26954280
FAX: 86-755-26954282

TEST RESULT CERTIFICATION

Applicant:	NINGHAI NEWORIENTAL PLASTICS INDUSTRY CO., LTD BINHAI INDUSTRIAL ESTATE, XIDIAN TOWN, NINGHAI, ZHEJIANG, CHINA
Manufacturer:	NINGHAI NEWORIENTAL PLASTICS INDUSTRY CO., LTD BINHAI INDUSTRIAL ESTATE, XIDIAN TOWN, NINGHAI, ZHEJIANG, CHINA
Product Description:	Remote Control Puck light
Model Number:	39154
Trade Mark:	N/A
File Number:	ES180612039W

Measurement Procedure Used:

APPLICABLE STANDARDS	
STANDARD	TEST RESULT
FCC 47 CFR Part 2, Subpart J FCC 47 CFR Part 15, Subpart C	PASS

We hereby certify that:

The above equipment was tested by EMTEK (SHENZHEN) CO., LTD. The test data, data evaluation, test procedures, and equipment configurations shown in this report were made in accordance with the procedures given in ANSI C63.10 (2013) and the energy emitted by the sample EUT tested as described in this report is in compliance with the requirements of FCC Rules Part 2 and Part 15.231 REQUIREMENTS.

The test results of this report relate only to the tested sample identified in this report.

Date of Test : June 12, 2018 to July 12, 2018

Prepared by : 
Doris Su/Editor

Reviewer : 
Yaping Shen/Supervisor

Approve & Authorized Signer : 
Lisa Wang/Manager



Table of Contents

1	EUT TECHNICAL DESCRIPTION.....	4
2	SUMMARY OF TEST RESULT	5
3	TEST METHODOLOGY.....	6
3.1	GENERAL DESCRIPTION OF APPLIED STANDARDS.....	6
3.2	MEASUREMENT EQUIPMENT USED	6
3.3	DESCRIPTION OF TEST MODES.....	6
4	FACILITIES AND ACCREDITATIONS.....	8
4.1	FACILITIES	8
4.2	LABORATORY ACCREDITATIONS AND LISTINGS	8
5	TEST SYSTEM UNCERTAINTY.....	9
6	SETUP OF EQUIPMENT UNDER TEST	10
6.1	RADIO FREQUENCY TEST SETUP 1	10
6.2	RADIO FREQUENCY TEST SETUP 2	10
6.3	BLOCK DIAGRAM CONFIGURATION OF TEST SYSTEM.....	12
6.4	SUPPORT EQUIPMENT	12
7	TEST REQUIREMENTS	13
7.1	20DB BANDWIDTH.....	13
7.2	FREQUENCY STABILITY	15
7.3	RADIATED SPURIOUS EMISSION	17
7.4	TRANSMISSION TIME REQUIREMENT	28
7.5	CONDUCTED EMISSION TEST	30
7.6	ANTENNA APPLICATION	31
8	SETUP PHOTOS	32
8.1	RADIATED EMISSION TEST	32

1 EUT TECHNICAL DESCRIPTION

Characteristics	Description
Product specification	433.92MHz Transmitter
Modulation	ASK modulation
Operating Frequency Range	433.92MHz
Number of Channels	1 channel
Antenna Type	PCB antenna
Antenna Gain	0 dBi
Power supply	DC 12V by battery
Temperature Range	-10°C ~ +50°C

Note: for more details, please refer to the User's manual of the EUT.

2 SUMMARY OF TEST RESULT

FCC Part Clause	Test Parameter	Verdict	Remark
15.231(c)	20dB Bandwidth	PASS	
15.231(d)	Frequency stability	N/A	
15.231(b)	Radiated Spurious Emissions	PASS	
15.231(a) 15.231(e)	Transmission Time Requirement	PASS	
15.203	Antenna Requirement	PASS	
15.207(a)	Conducted Emission	N/A	
NOTE1: N/A (Not Applicable)			

RELATED SUBMITTAL(S) / GRANT(S):

This submittal(s) (test report) is intended for FCC ID: 2AP9MNDF-39154 filing to comply with Section 15.231 of the FCC Part 15, Subpart C Rules

3 TEST METHODOLOGY

3.1 GENERAL DESCRIPTION OF APPLIED STANDARDS

According to its specifications, the EUT must comply with the requirements of the following standards:

FCC 47 CFR Part 2, Subpart J

FCC 47 CFR Part 15, Subpart C

3.2 MEASUREMENT EQUIPMENT USED

Radiated Emission Test Equipment

EQUIPMENT TYPE	MFR	MODEL NUMBER	SERIAL NUMBER	LAST CAL.	DUE CAL.
EMI Test Receiver	Rohde & Schwarz	ESU	1302.6005.26	May 20, 2018	May 21, 2019
Pre-Amplifier	HP	8447F	2944A07999	May 19, 2018	May 20, 2019
Bilog Antenna	Schwarzbeck	VULB9163	142	May 19, 2018	May 20, 2019
Cable	Schwarzbeck	AK9513	ACRX1	May 20, 2018	May 21, 2019
Cable	Rosenberger	N/A	FP2RX2	May 20, 2018	May 21, 2019
Cable	Schwarzbeck	AK9513	CRPX1	May 20, 2018	May 21, 2019
EMI Test Receiver	Rohde & Schwarz	ESU	1302.6005.26	May 20, 2018	May 21, 2019
Pre-Amplifier	A.H.	PAM-0126	1415261	May 19, 2018	May 20, 2019
Horn Antenna	Schwarzbeck	BBHA 9120	707	May 19, 2018	May 20, 2019
Loop Antenna	Laplace Instrument Ltd	RF300	8006	May 20, 2018	May 21, 2019
Cable	H+B	0.5M SF104-26.5	289147/4	May 20, 2018	May 21, 2019
Cable	H+B	3M SF104-26.5	295838/4	May 20, 2018	May 21, 2019
Cable	H+B	6M SF104-26.5	295840/4	May 20, 2018	May 21, 2019

Radio Frequency Test Equipment

EQUIPMENT TYPE	MFR	MODEL NUMBER	SERIAL NUMBER	LAST CAL.	DUE CAL.
Spectrum Analyzer	Agilent	E4407B	88156318	May 20, 2018	May 21, 2019
Signal Analyzer	Agilent	N9010A	My53470879	May 20, 2018	May 21, 2019
Power meter	Anritsu	ML2495A	0824006	May 20, 2018	May 21, 2019
Power sensor	Anritsu	MA2411B	0738172	May 20, 2018	May 21, 2019
Spectrum Analyzer	Rohde & Schwarz	FSV40	100967	May 20, 2018	May 21, 2019

Remark: Each piece of equipment is scheduled for calibration once a year.

3.3 DESCRIPTION OF TEST MODES

The EUT has been tested under its typical operating condition.

The EUT configuration for testing is installed on RF field strength measurement to meet the Commissions requirement and operating in a manner which intends to maximize its emission characteristics

The Transmitter was operated in the normal operating mode. The TX frequency was fixed which was for the purpose of the measurements.

Pre-defined engineering program for regulatory testing used to control the EUT for staying in continuous transmitting mode is programmed.

The new batteries were used in the test

Frequency and Channel list:

Channel	Frequency (MHz)	Channel	Frequency (MHz)	Channel	Frequency (MHz)
0	433.92		

Test Frequency and Channel list:

Lowest Frequency		Middle Frequency		Highest Frequency	
Channel	Frequency (MHz)	Channel	Frequency (MHz)	Channel	Frequency (MHz)
0	433.92				

4 FACILITIES AND ACCREDITATIONS

4.1 FACILITIES

All measurement facilities used to collect the measurement data are located at

Bldg 69, Majialong Industry Zone District, Nanshan District, Shenzhen, China

The sites are constructed in conformance with the requirements of ANSI C63.7, ANSI C63.10 and CISPR Publication 22.

4.2 LABORATORY ACCREDITATIONS AND LISTINGS

Site Description

EMC Lab.

: Accredited by CNAS, 2016.10.24
The certificate is valid until 2022.10.28
The Laboratory has been assessed and proved to be in compliance with
CNAS-CL01:2006 (identical to ISO/IEC 17025:2005)
The Certificate Registration Number is L2291.

Accredited by TUV Rheinland Shenzhen 2016.05.19
The Laboratory has been assessed according to the requirements
ISO/IEC 17025.

Accredited by FCC, Valid until 2018.08.31
A2LA Designation Number is CN1204
Test Firm Registration Number: 882943

Accredited by Industry Canada, November 29, 2015
The Certificate Registration Number is 4480A.

Name of Firm

Site Location

: EMTEK (SHENZHEN) CO., LTD.
: Bldg 69, Majialong Industry Zone,
Nanshan District, Shenzhen, Guangdong, China

5 TEST SYSTEM UNCERTAINTY

The following measurement uncertainty levels have been estimated for tests performed on the apparatus:

Parameter	Uncertainty
Radio Frequency	$\pm 1 \times 10^{-5}$
Conducted Emissions Test	$\pm 2.0\text{dB}$
Radiated Emission Test	$\pm 2.0\text{dB}$
20dB Bandwidth Test	$\pm 1.0\text{dB}$
All emission, radiated	$\pm 3\text{dB}$
Temperature	$\pm 0.5^\circ\text{C}$
Humidity	$\pm 3\%$

Measurement Uncertainty for a level of Confidence of 95%

6 SETUP OF EQUIPMENT UNDER TEST

6.1 RADIO FREQUENCY TEST SETUP 1

The component's antenna port(s) of the EUT are connected to the measurement instrument per an appropriate attenuator. The EUT is controlled by PC/software to emit the specified signals for the purpose of measurements.

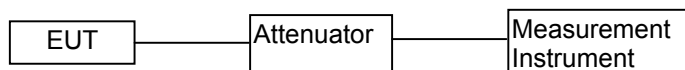

6.2 RADIO FREQUENCY TEST SETUP 2

The test site semi-anechoic chamber has met the requirement of NSA tolerance 4 dB according to the standards: ANSI C63.10. The test distance is 3m. The setup is according to the requirements in Section 13.1.4.1 of ANSI C63.10-2013 and CAN/CSA-CEI/IEC CISPR 22.

The maximal emission value is acquired by adjusting the antenna height, polarisation and turntable azimuth. Normally, the height range of antenna is 1 m to 4 m, the azimuth range of turntable is 0° to 360°, and the receive antenna has two polarizations Vertical (V) and Horizontal (H).

Below 30MHz:

The EUT is placed on a turntable 0.8 meters above the ground in the chamber, 3 meter away from the antenna (loop antenna). The Antenna should be positioned with its plane vertical at the specified distance from the EUT and rotated about its vertical axis for maximum response at each azimuth about the EUT. The center of the loop shall be 1 m above the ground. For certain applications, the loop antenna plane may also need to be positioned horizontally at the specified distance from the EUT.

Above 30MHz:

The EUT is placed on a turntable 0.8 meters above the ground in the chamber, 3 meter away from the antenna. The maximal emission value is acquired by adjusting the antenna height, polarisation and turntable azimuth. Normally, the height range of antenna is 1 m to 4 m, the azimuth range of turntable is 0° to 360°, and the receive antenna has two polarizations Vertical (V) and Horizontal (H).

Above 1GHz:

(Note: the FCC's permission to use 1.5m as an alternative per TCBC Conf call of Dec. 2, 2014.)

The EUT is placed on a turntable 1.5 meters above the ground in the chamber, 3 meter away from the antenna. The maximal emission value is acquired by adjusting the antenna height, polarisation and turntable azimuth. Normally, the height range of antenna is 1 m to 4 m, the azimuth range of turntable is 0° to 360°, and the receive antenna has two polarizations Vertical (V) and Horizontal (H).

(a) Radiated Emission Test Set-Up, Frequency Below 30MHz

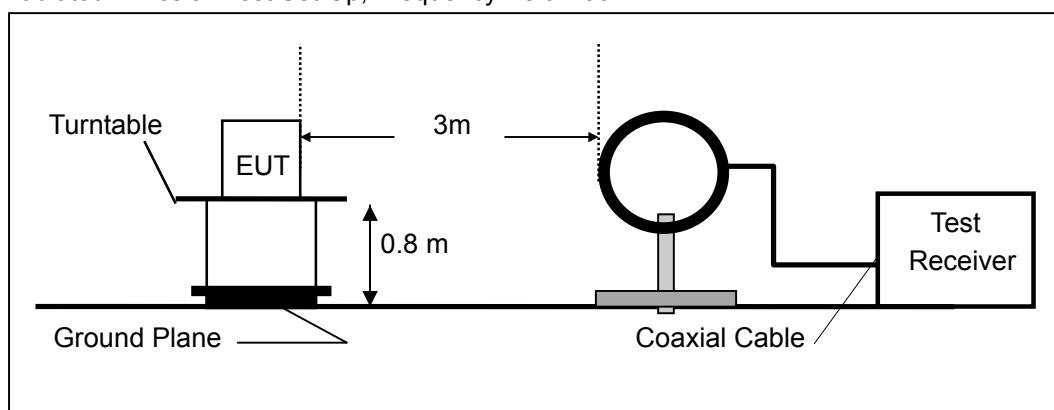

(b) Radiated Emission Test Set-Up, Frequency Below 1000MHz

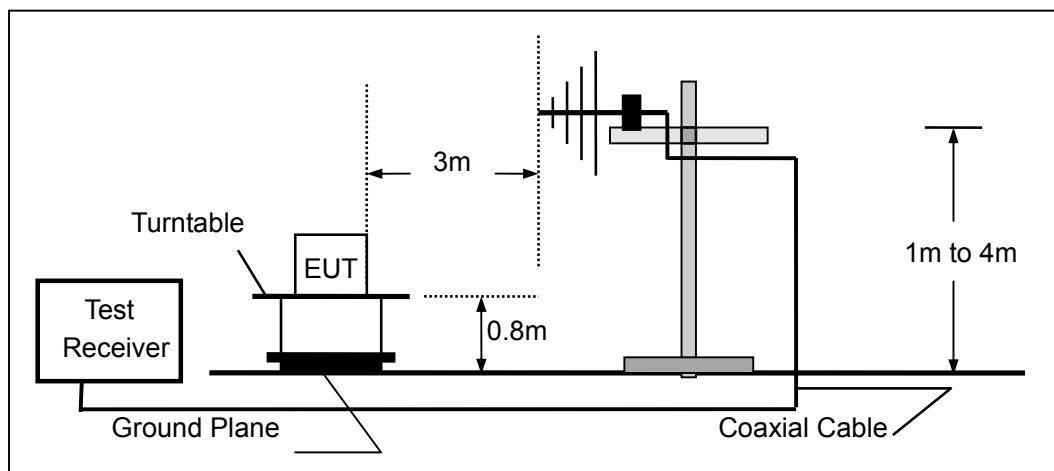

(c) Radiated Emission Test Set-Up, Frequency above 1000MHz

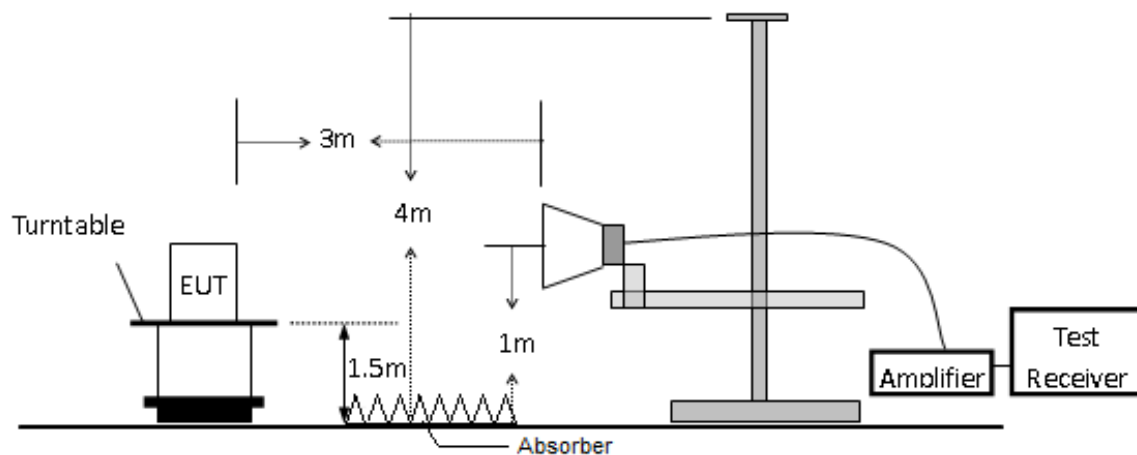

6.3 BLOCK DIAGRAM CONFIGURATION OF TEST SYSTEM

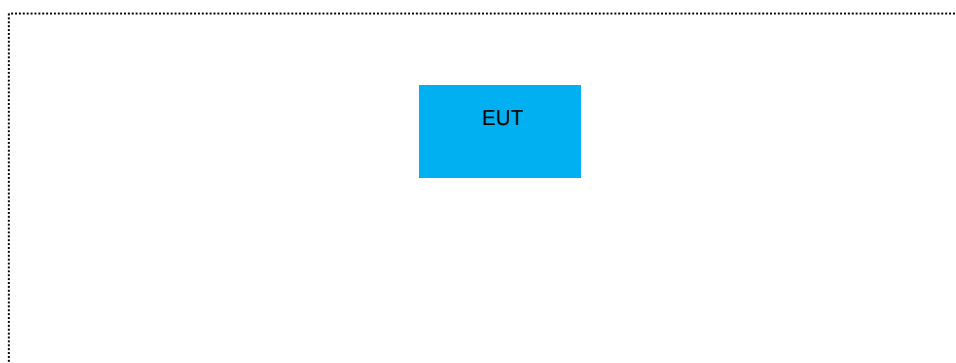

6.4 SUPPORT EQUIPMENT

Item	Equipment	Mfr/Brand	Model/Type No.	Series No.	Note
--	---	---	---	---	---

Notes:

1. All the equipment/cables were placed in the worst-case configuration to maximize the emission during the test.
2. Grounding was established in accordance with the manufacturer's requirements and conditions for the intended use.

7 TEST REQUIREMENTS

7.1 20DB BANDWIDTH

7.1.1 Applicable Standard

According to FCC Part 2.1049 and part 15.231(c)

7.1.2 Conformance Limit

The bandwidth of the emission shall be no wider than 0.25% of the center frequency for devices operating above 70 MHz and below 900 MHz. For devices operating above 900 MHz, the emission shall be no wider than 0.5% of the center frequency. Bandwidth is determined at the points 20 dB down from the modulated carrier.

7.1.3 Test Configuration

Test according to clause 6.1 radio frequency test setup 1

7.1.4 Test Procedure

The EUT was operating in transmit mode and controlled its channel. Printed out the test result from the spectrum by hard copy function.

The RF output of EUT was connected to the spectrum analyzer by RF cable and attenuator. The path loss was compensated to the results for each measurement.

Set to the maximum power setting and enable the EUT transmit continuously

Set RBW =100 kHz.

Set the video bandwidth (VBW) ≥ 3 RBW.

Set Span= approximately 2 to 3 times the occupied bandwidth

Set Detector = Peak.

Set Trace mode = max hold.

Set Sweep = auto couple.

The EUT should be transmitting at its maximum data rate. Allow the trace to stabilize. Use the marker-to-peak function to set the marker to the peak of the emission. Use the marker-delta function to measure 20 dB down one side of the emission. Reset the markerdelta function, and move the marker to the other side of the emission, until it is (as close as possible to) even with the reference marker level. The marker-delta reading at this point is the 20 dB bandwidth of the emission.

If this value varies with different modes of operation (e.g., data rate, modulation format, etc.), repeat this test for each variation.

Measure and record the results in the test report.

Test Results

Temperature:	24°C	Test Date:	June 15, 2018
Humidity:	53 %	Test By:	King Kong

Modulation Mode	Channel Number	Channel Frequency (MHz)	Measurement Bandwidth (kHz)	Limit (kHz)	Verdict
ASK	00	433.92	4.599	≤ 1084.8	PASS
Note: Limit=0.25% of the center frequency=433.92MHz * 0.25% = 1084.8kHz					

Test Model Occupied Bandwidth ASK Modulation
Channel 0: 433.92MHz



15.Jun 18 16:55 *RBW 100 Hz Marker 1 [T1]
Ref 10 dBm *Att 20 dB *VBW 300 Hz -9.32 dBm
SWT 1.2 s 433.928150000 MHz

1 PK
VIEW

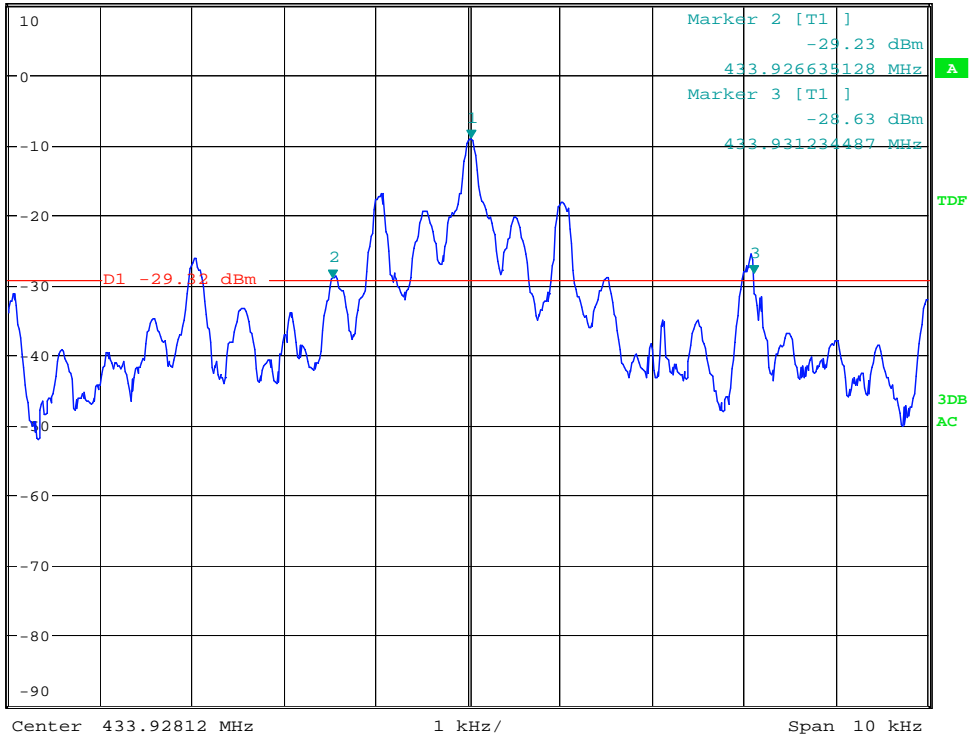

Date: 15.JUN.2018 16:55:36

7.2 FREQUENCY STABILITY

7.2.1 Applicable Standard

According to FCC Part 2.1055 and part 15.231(d)

7.2.2 Conformance Limit

According to part 15.231(d), For devices operating within the frequency band 40.66-40.70 MHz, the bandwidth of the emission shall be confined within the band edges and the frequency tolerance of the carrier shall be $\pm 0.01\%$. This frequency tolerance shall be maintained for a temperature variation of -20 degrees to $+50$ degrees C at normal supply voltage, and for a variation in the primary supply voltage from 85% to 115% of the rated supply voltage at a temperature of 20 degrees C. For battery operated equipment, the equipment tests shall be performed using a new battery

7.2.3 Test Configuration

Test according to clause 6.1 radio frequency test setup

7.2.4 Test Procedures

Connect the EUT to frequency analyzer via the antenna connector.

EUT was placed at temperature chamber and connected to an external power supply.

Temperature and voltage condition shall be tested to confirm frequency stability.

(a) Frequency measurements shall be made at the extremes of the specified temperature range and at intervals of not more than 10° centigrade through the range. A period of time sufficient to stabilize all of the components of the oscillator circuit at each temperature level shall be allowed prior to frequency measurement. The short-term transient effects on the frequency of the transmitter due to keying (except for broadcast transmitters) and any heating element cycling normally occurring at each ambient temperature level also shall be shown. Only the portion or portions of the transmitter containing the frequency determining and stabilizing circuitry need be subjected to the temperature variation test.

(b) The frequency stability shall be measured with variation of primary supply voltage as follows:

(1) Vary primary supply voltage from 85 to 115 percent of the nominal value for other than hand carried battery equipment.

(2) For hand carried, battery powered equipment, reduce primary supply voltage to the battery operating end point, which shall be specified by the manufacturer.

7.2.5 Test Results

Operation Mode	Channel Number	Test Condition		Channel Frequency (MHz)	Freq.Dev. (Hz)	Deviation (ppm)	Limit (ppm)
		Voltage (V)	Temp (°C)				
ASK	CH0	Vnom	-20	-	-	-	10
			-10	-	-	-	10
			0	-	-	-	10
			10	-	-	-	10
			20	-	-	-	10
			30	-	-	-	10
			40	-	-	-	10
			50	-	-	-	10
		85% Vnom	20	-	-	-	10
		115% Vnom	20	-	-	-	10
VERDICT				PASS			
Note: Not applicable, the device operating without the frequency band 40.66-40.70MHz.							

7.3 RADIATED SPURIOUS EMISSION

7.3.1 Applicable Standard

According to FCC Part 15.231(b) and 15.209

7.3.2 Conformance Limit

In addition to the provisions of §15.205, the field strength of emissions from intentional radiators operated under this section shall not exceed the following:

Frequencies (MHz)	Field strength of fundamental @3m		Effective limit for 433.92MHz	
	(uV/m)	dB(uV/m)	(uV/m)	dB(uV/m)
40.66-40.70	2250	67		
70-130	1250	62		
130-174	1250 to 3750*	62 to 71.5*		
174-260	3750	71.5		
260-470	3750 to 12500*	71.5 to 81.9*	6043.1	80.8
Above 470	12500	81.94		

* Linear interpolation

Frequencies (MHz)	Field strength of Spurious emissions @3m		Effective limit for 433.92MHz	
	(uV/m)	dB(uV/m)	(uV/m)	dB(uV/m)
40.66-40.70	225	47		
70-130	125	41.9		
130-174	125 to 375*	41.9 to 51.5*		
174-260	375	51.5		
260-470	375 to 1250*	51.5 to 61.9*	604.2	60.8
Above 470	1250	61.94		

* Linear interpolation

The above field strength limits are specified at a distance of 3 meters. The tighter limits apply at the band edges.

Intentional radiators operating under the provisions of this section shall demonstrate compliance with the limits on the field strength of emissions, as shown in the above table, based on the average value of the measured emissions

The FCC specified emission limits were calculated according to the EUT operating frequency and obtained by following linear interpolation equations:

(a) For fundamental frequency:

$$f_{EUT} : \text{EUT Operating Frequency Emission Limit (uV/m)}$$

$$= [f_{EUT}(\text{MHz}) - 260(\text{MHz})] \times \frac{12500(\text{uV/m}) - 3750(\text{uV/m})}{470(\text{MHz}) - 260(\text{MHz})} + 3750(\text{uV/m})$$

(b) For spurious frequencies:

$$f_{EUT} : \text{EUT Operating Frequency Emission Limit (V/m)}$$

$$= [f_{EUT}(\text{MHz}) - 260(\text{MHz})] \times \frac{1250(\text{uV/m}) - 375(\text{uV/m})}{470(\text{MHz}) - 260(\text{MHz})} + 375(\text{uV/m})$$

Other emissions radiated outside of the specified frequency bands, except for harmonics, shall be attenuated by at least 20 dB below the level of the fundamental or comply with the radiated emissions limits specified in section 15.209(a) limit in the table below has to be followed.

Note:

- (1) The tighter limit applies at the band edges.
- (2) Emission level (dBuV/m)=20log Emission level (uV/m).

FCC Part15 (15.231) , Subpart C		
Fundamental Frequency	Field Strength Of Fundamental	Field Strength of Spurious Emissions
433.92MHz	AV:80.8 dBuV/m at 3m distance	AV:60.8 dBuV/m at 3m distance
	PK:100.8 dBuV/m at 3m distance	PK:80.8 dBuV/m at 3m distance

According to FCC Part15.205, Restricted bands

MHz	MHz	MHz	GHz
0.090-0.110	16.42-16.423	399.9-410	4.5-5.15
10.495-0.505	16.69475-16.69525	608-614	5.35-5.46
2.1735-2.1905	16.80425-16.80475	960-1240	7.25-7.75
4.125-4.128	25.5-25.67	1300-1427	8.025-8.5
4.17725-4.17775	37.5-38.25	1435-1626.5	9.0-9.2
4.20725-4.20775	73-74.6	1645.5-1646.5	9.3-9.5
6.215-6.218	74.8-75.2	1660-1710	10.6-12.7
6.26775-6.26825	123-138	2200-2300	14.47-14.5
8.291-8.294	149.9-150.05	2310-2390	15.35-16.2
8.362-8.366	156.52475-156.52525	2483.5-2500	17.7-21.4
8.37625-8.38675	156.7-156.9	2690-2900	22.01-23.12
8.41425-8.41475	162.0125-167.17	3260-3267	23.6-24.0
12.29-12.293	167.72-173.2	3332-3339	31.2-31.8
12.51975-12.52025	240-285	3345.8-3358	36.43-36.5
12.57675-12.57725	322-335.4	3600-4400	(2)
13.36-13.41			

According to FCC Part15.205, the level of any transmitter spurious emission in Restricted bands shall not exceed the level of the emission specified in the following table

Restricted Frequency(MHz)	Field Strength (μ V/m)	Field Strength (dB μ V/m)	Measurement Distance
0.009~0.490	2400/F(KHz)	300	See the remark
0.490~1.705	24000/F(KHz)	30	
1.705~30.0	30	30	
30-88	100	40	3
88-216	150	43.5	3
216-960	200	46	3
Above 960	500	54	3

Remark :1. Emission level in dBuV/m=20 log (uV/m)
 2. Measurement was performed at an antenna to the closed point of EUT distance of meters.
 3. Distance extrapolation factor =40log(Specific distance/ test distance)(dB);
 Limit line=Specific limits(dBuV) + distance extrapolation factor.
 for the frequency ranges below 30 MHz, a narrower RBW is used for these ranges but the measured value should add a RBW correction factor (RBWCF) where RBWCF [dB] =10*lg(100 [kHz]/narrower RBW [kHz]). , the narrower RBW is 1 kHz and RBWCF is 20 dB for the frequency 9 kHz to 150 kHz, and the narrower RBW is 10 kHz and RBWCF is 10 dB for the frequency 150 kHz to 30 MHz.

7.3.3 Test Configuration

Test according to clause 6.2 radio frequency test setup 2

7.3.4 Test Procedure

This test is required for any spurious emission that falls in a Restricted Band, as defined in Section 15.205. It must be performed with the highest gain of each type of antenna proposed for use with the EUT. Use the following spectrum analyzer settings:

The EUT was placed on a turn table which is 0.8m above ground plane.

Maximum procedure was performed on the highest emissions to ensure EUT compliance.

Span = wide enough to fully capture the emission being measured

RBW = 100 kHz for $f < 1$ GHz(30MHz to 1GHz), 200Hz for $f < 150$ KHz(9KHz to 150KHz), 9KHz for $f < 30$ MHz(150KHz to 30MHz), 1MHz for $f < 5$ GHz

VBW \geq RBW Sweep = auto

Detector function = peak

Trace = max hold

Follow the guidelines in ANSI C63.10-2013 with respect to maximizing the emission by rotating the EUT, measuring the emission while the EUT is situated in three orthogonal planes (if appropriate), adjusting the measurement antenna height and polarization, etc. A pre-amp and a high pass filter are required for this test, in order to provide the measuring system with sufficient sensitivity. Allow the trace to stabilize. The peak reading of the emission, after being corrected by the antenna factor, cable loss, pre-amp gain, etc., is the peak field strength, which must comply with the limit specified in Section 15.35(b). Submit this data.

Now set the VBW to 10 Hz, while maintaining all of the other instrument settings. This peak level, once corrected, must comply with the limit specified in Section 15.209. If the dwell time per channel of the hopping signal is less than 100 ms, then the reading obtained with the 10 Hz VBW may be further adjusted by a "duty cycle correction factor", derived from $20\log(\text{dwell time}/100 \text{ ms})$, in an effort to demonstrate compliance with the 15.209 limit. Submit this data.

- Calculation of Average factor

The output field strengths of specification in accordance with the FCC rules specify measurements with an average detector. During the test, a spectrum analyzer incorporating a peak detector was used. Therefore, a reduction factor can be applied to the resultant peak signal level and compared to the limit for measurement instrumentation incorporating an average detector.

The duty cycle is measured in 100ms or the repetition cycle period, whichever is a shorter time frame, the duty cycle is measured by placing the spectrum analyzer to set zero span at 100kHz resolution bandwidth.

Averaging factor in dB= $20\log(\text{duty cycle})$

Where the duty factor is calculated from following formula:

$$20\log(\text{Duty cycle})= 20\log[(3.013 * 1 + 0.513 * 16 + 1.474 * 16)\text{ms} / 58.015\text{ms}]=-4.44\text{dB}$$

Therefore, the averaging factor is -4.44dB.

Repeat above procedures until all frequency measured was complete.

7.3.5 Test Results

■ Duty cycle measure

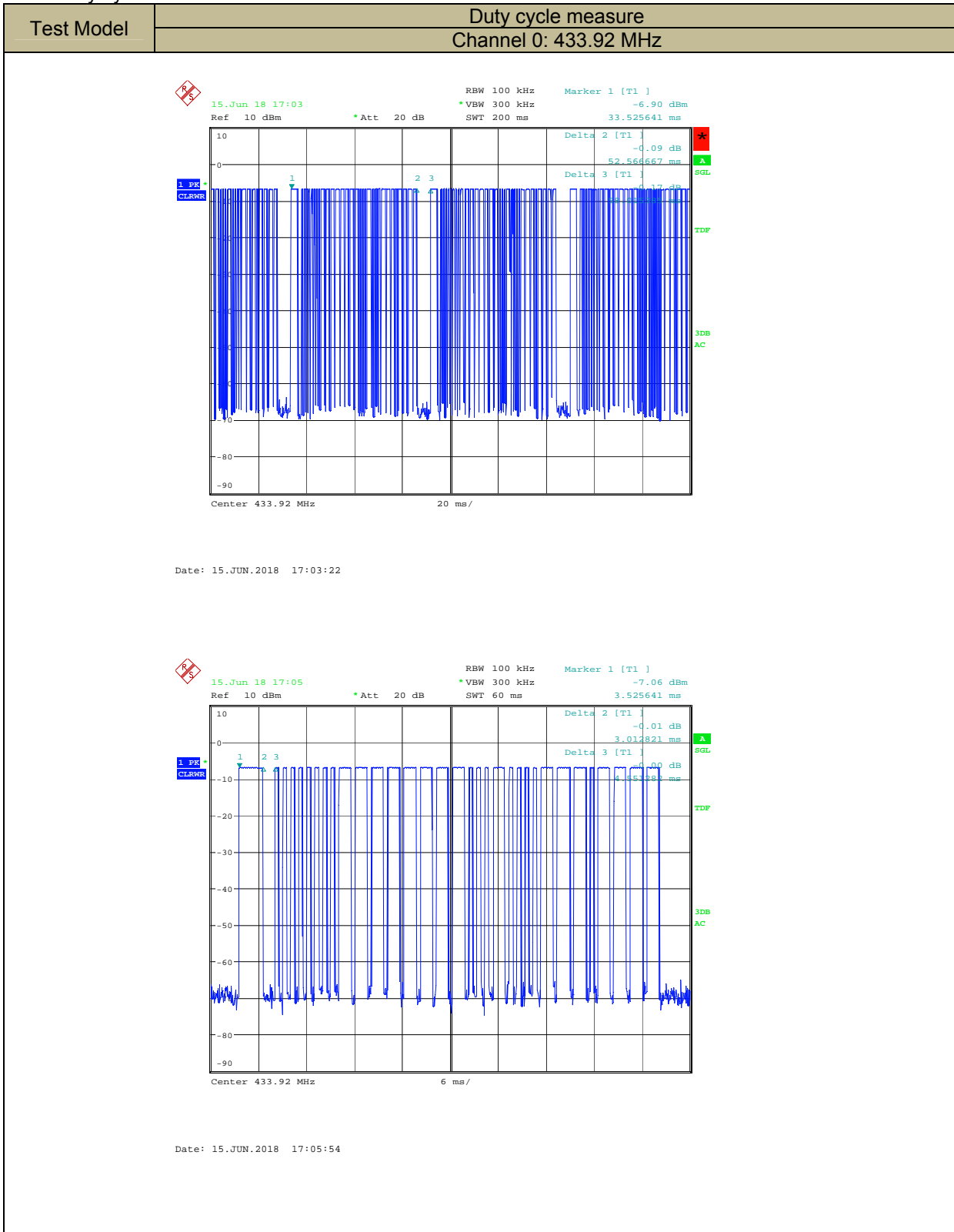

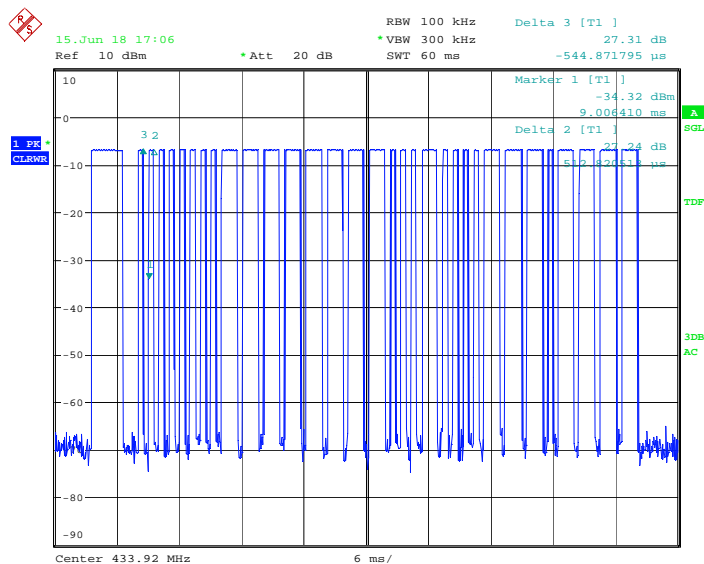

Date: 15.JUN.2018 17:06:54

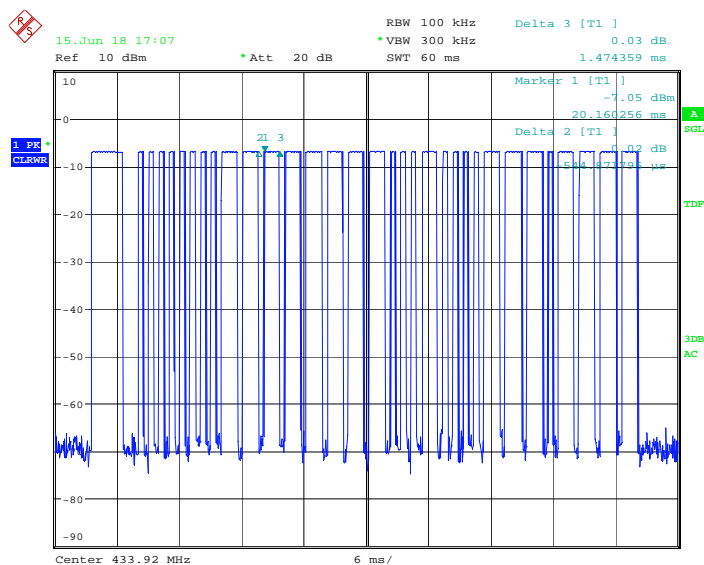

Date: 15.JUN.2018 17:07:44

■ Field Strength of the fundamental signal

Temperature:	24 °C	Test Date:	July 02, 2018
Humidity:	53 %	Test By:	KK
Test mode:	TX Mode		

Freq. (MHz)	Ant.Pol. H/V	Emission Level(dBuV/m)			Limit 3m(dBuV/m)		Over(dB)	
		PK	AV Factor	AV	PK	AV	PK	AV
433.92	V	74.47	-4.44	70.03	100.8	80.8	-26.33	-10.77
433.92	H	75.40	-4.44	70.96	100.8	80.8	-25.40	-9.84

- Note: (1) Correct Factor= Antenna Factor +Cable Loss- Amplifier Gain
 (2) Emission Level= Reading Level+Probe Factor +Cable Loss
 (3) True Value = Emission Level + Duty Cycle Correction Factor
 (4) DF= Duty Cycle Correction Factor
 (5) Duty Cycle Correction Factor (dB) = $20\log(\text{Duty cycle}) = -4.44\text{dB}$
 (6) average results= peak results + DF
 (7) The EUT has been evaluated in xyz orientation, and the worst result have been recorded in the report.

Fundamental signal-H

80.0 dBuV/m

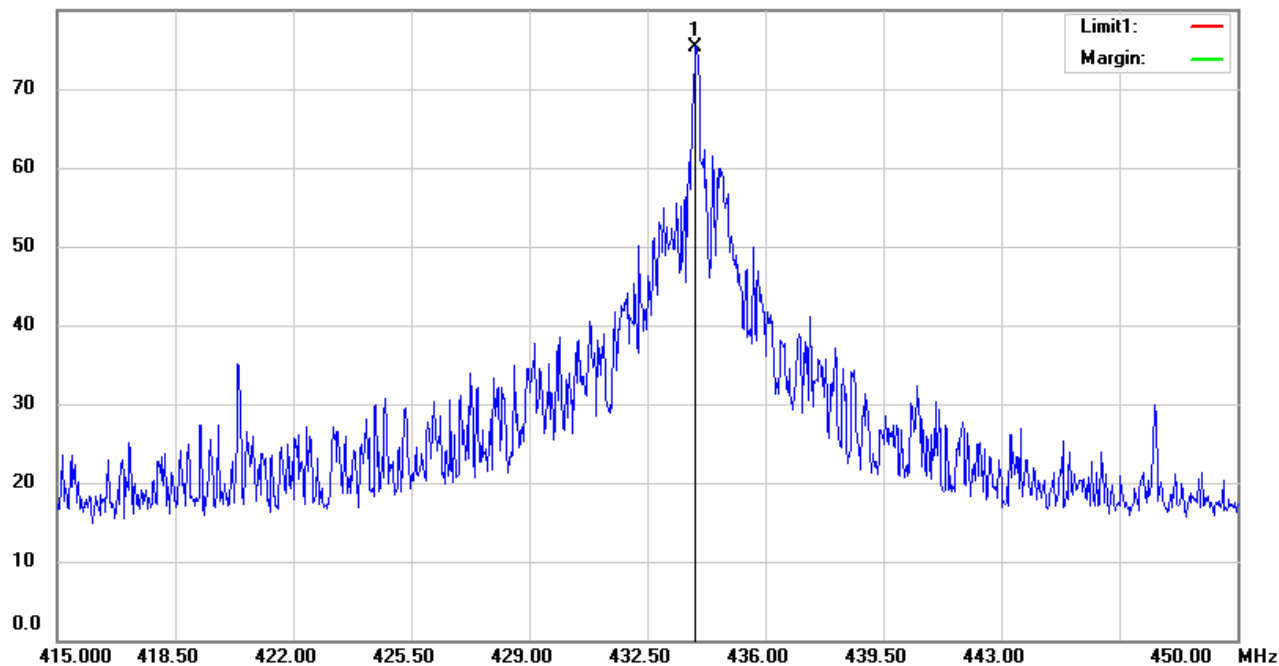

Fundamental signal-V

80.0 dBuV/m

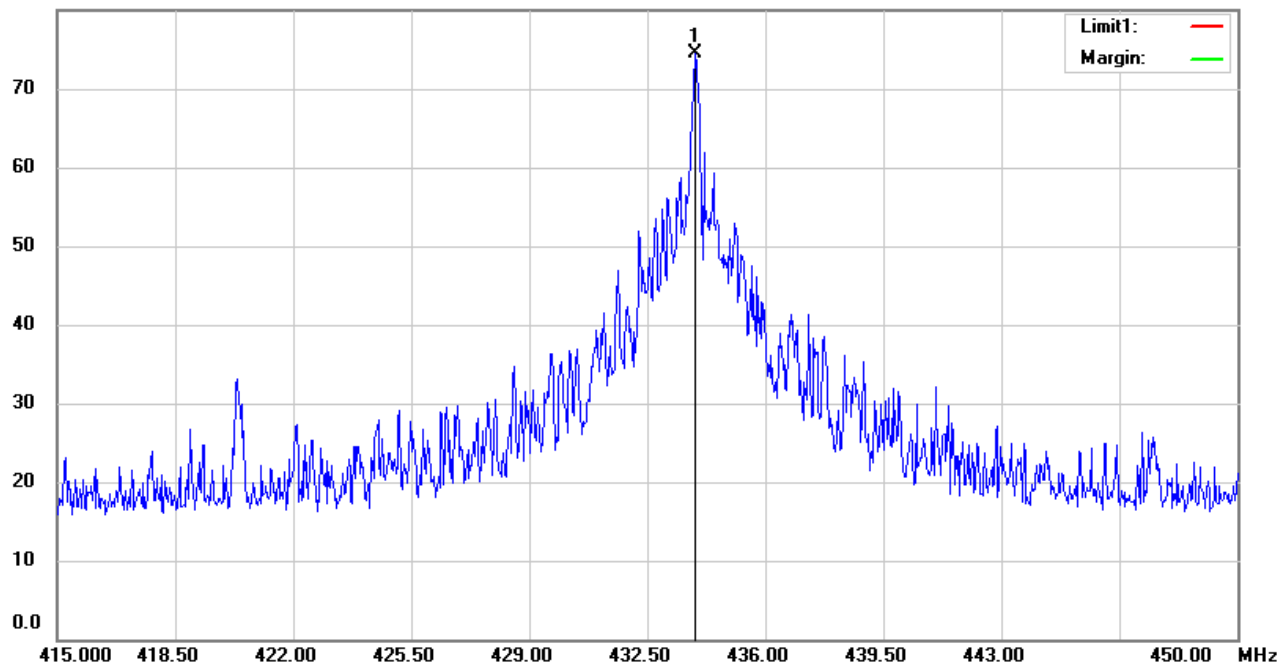

■ Spurious Emission below 30MHz (9KHz to30MHz)

Temperature:	24 °C	Test Date:	July 02, 2018
Humidity:	53 %	Test By:	KK
Test mode:	TX Mode		

Freq. (MHz)	Ant.Pol. H/V	Emission Level(dBuV/m)		Limit 3m(dBuV/m)		Over(dB)	
		PK	AV	PK	AV	PK	AV
--	--	--	--	--	--	--	--

Note: the amplitude of spurious emission that is attenuated by more than 20dB below the permissible limit has no need to be reported.

Distance extrapolation factor =40log(Specific distance/ test distance)(dB);

Limit line=Specific limits(dBuV) + distance extrapolation factor

■ Radiated spurious emission above 1GHz

Operation Mode:	433.92MHz	Test Date :	July 02, 2018
Frequency Range:	1000~5000MHz	Temperature :	24 °C
Test Result:	PASS	Humidity :	53 %
Measured Distance:	3m	Test By:	King Kong

Freq. (MHz)	Ant.Pol. H/V	Emission Level (dBuV/m) PK	AV factor dB	Emission Level (dBuV/m) AV	Limit 3m(dBuV/m)		Margin (dB)	
					PK	AV	PK	AV
1090.758*	V	44.01	-4.44	39.57	74.0	54.0	-29.99	-14.43
1301.798	V	55.00	-4.44	50.56	80.8	60.8	-25.8	-10.24
1735.390	V	52.16	-4.44	47.72	80.8	60.8	-28.64	-13.08
2169.598	V	51.75	-4.44	47.31	80.8	60.8	-29.05	-13.49
2603.486	V	45.33	-4.44	40.89	80.8	60.8	-35.47	-19.91
3037.550	V	42.05	-4.44	37.61	80.8	60.8	-38.75	-23.19
1085.107*	H	43.21	-4.44	38.77	74.0	54.0	-29.99	-14.43
1301.798	H	55.65	-4.44	51.21	80.8	60.8	-25.15	-9.59
1735.390	H	58.82	-4.44	54.38	80.8	60.8	-21.98	-6.42
2170.035	H	53.82	-4.44	49.38	80.8	60.8	-26.98	-11.42
2602.857	H	49.85	-4.44	45.41	80.8	60.8	-30.95	-15.39
3037.135	H	46.32	-4.44	41.88	80.8	60.8	-34.48	-18.92

- Note:
- (1) All Readings are Peak Value.
 - (2) Correct Factor= Antenna Factor +Cable Loss- Amplifier Gain
 - (3) Emission Level= Reading Level+Probe Factor +Cable Loss
 - (4) True Value = Emission Level + Duty Cycle Correction Factor
 - (5) DF= Duty Cycle Correction Factor
 - (6) Duty Cycle Correction Factor (dB) = 20log(Duty cycle)=] = -4.44dB
 - (7) Margin = PK Level – AV limit
 - (8) The "*" means restricted bands
 - (9) All the x/y/z orientation has been investigated, and only worst case is presented in this report.
 - (10) The EUT has been evaluated in xyz orientation, and the worst result have been recorded in the report.

■ Radiated spurious emission below 1GHz

Operation Mode:	433.92MHz	Test Date :	June 19, 2018
Frequency Range:	30~1000MHz	Temperature :	24℃
Test Result:	PASS	Humidity :	53 %
Measured Distance:	3m	Test By:	King Kong

Freq. (MHz)	Ant.Pol. H/V	Emission Level (dBuV/m) PK	AV factor dB	Emission Level (dBuV/m) AV	Limit	Limit	Margin	Margin
					3m(dBuV/m) PK	3m(dBuV/m) AV	(dB) PK	(dB) AV
869.13	H	57.68	-4.44	53.24	80.80	60.80	-23.12	-7.56
869.13	V	56.30	-4.44	51.86	80.80	60.80	-24.50	-8.940

- Note:
- (1) All Readings are Peak Value.
 - (2) Correct Factor= Antenna Factor +Cable Loss- Amplifier Gain
 - (3) Emission Level= Reading Level+Probe Factor +Cable Loss
 - (4) True Value = Emission Level + Duty Cycle Correction Factor
 - (5) DF= Duty Cycle Correction Factor
 - (6) Duty Cycle Correction Factor (dB) = $20\log(\text{Duty cycle}) = -4.44\text{dB}$
 - (7) Margin = PK Level – AV limit
 - (8) The “*” means restricted bands
 - (9) All the x/y/z orientation has been investigated, and only worst case is presented in this report.
 - (10) The EUT has been evaluated in xyz orientation, and the worst result have been recorded in the report.

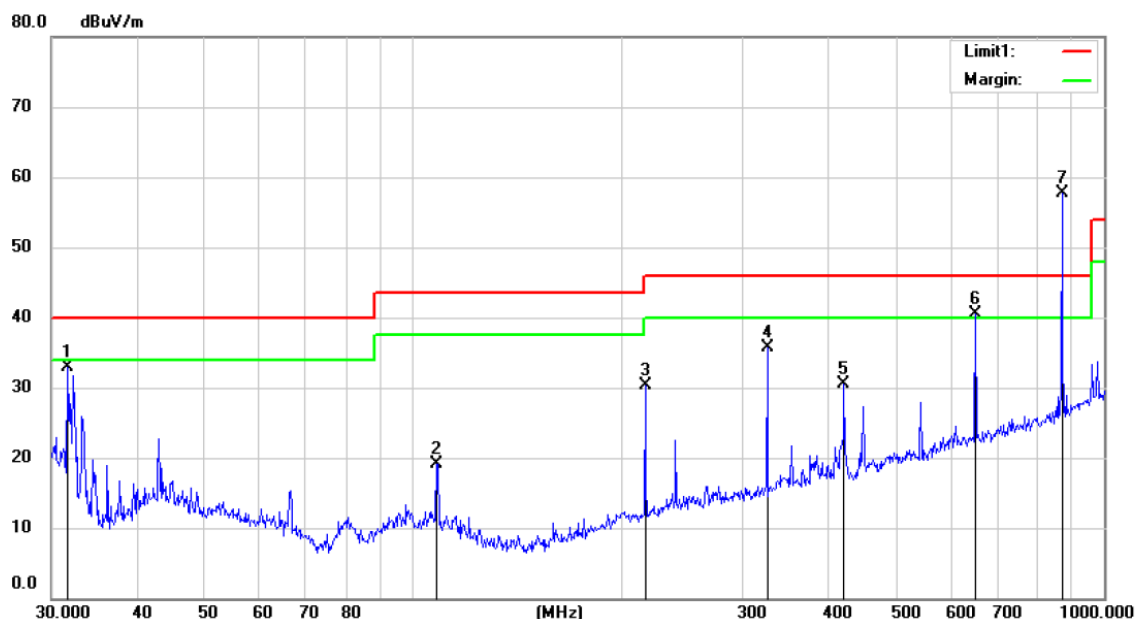

Site 3m Chamber #3 Polarization: **Horizontal** Temperature: 23 C
 Limit: (RE)FCC PART 15 C Power: DC 12V Humidity: 51 %
 Mode: ON
 Note:

No.	Mk.	Freq.	Reading Level	Correct Factor	Measurement	Limit	Over	Antenna Height	Table Degree	
		MHz	dBuV	dB	dBuV/m	dBuV/m	dB	cm	degree	Comment
1		31.6201	49.86	-17.01	32.85	40.00	-7.15	QP		
2		108.2666	35.04	-15.89	19.15	43.50	-24.35	QP		
3		216.7828	45.84	-15.61	30.23	46.00	-15.77	QP		
4		325.5958	47.71	-12.05	35.66	46.00	-10.34	QP		
5		420.5803	39.69	-9.24	30.45	46.00	-15.55	QP		
6	!	651.9417	45.40	-4.98	40.42	46.00	-5.58	QP		
7	*	869.1302	58.91	-1.23	57.68	46.00	11.68	peak		

*:Maximum data x:Over limit !:over margin

Operator: KK

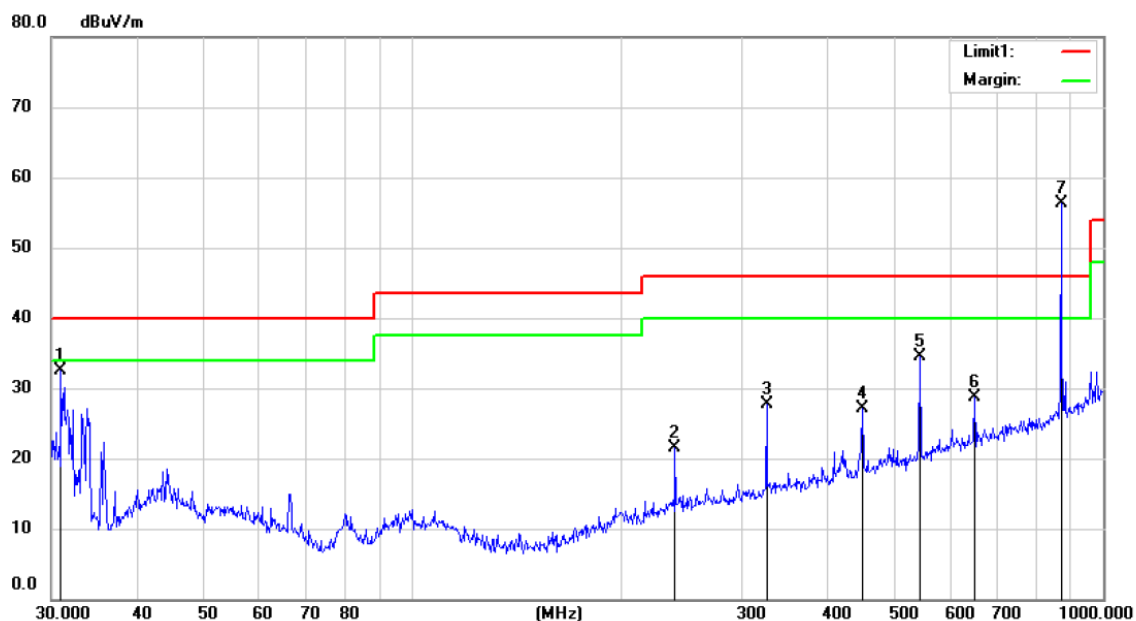

Site 3m Chamber #3 Polarization: **Vertical** Temperature: 23 C
 Limit: (RE)FCC PART 15 C Power: DC 12V Humidity: 51 %
 Mode:ON
 Note:

No.	Mk.	Freq.	Reading Level	Correct Factor	Measurement	Limit	Over	Antenna Height	Table Degree	
		MHz	dBuV	dB	dBuV/m	dBuV/m	dB	cm	degree	Comment
1		30.9618	49.51	-16.98	32.53	40.00	-7.47			QP
2		239.9873	35.83	-14.26	21.57	46.00	-24.43			QP
3		325.5958	39.74	-12.05	27.69	46.00	-18.31			QP
4		447.9822	36.31	-9.12	27.19	46.00	-18.81			QP
5		543.2742	41.75	-7.25	34.50	46.00	-11.50			QP
6		651.9417	33.72	-4.98	28.74	46.00	-17.26			QP
7	*	869.1302	57.53	-1.23	56.30	46.00	10.30			peak

*:Maximum data x:Over limit !:over margin

Operator: KK

Note: The frequency point 868 MHz is the second harmonic signal. Please find the verdict on page 25.

7.4 TRANSMISSION TIME REQUIREMENT

7.4.1 Applicable Standard

According to FCC Part 15.231(e)

7.4.2 Conformance Limit

The devices operated under 15.231(a) shall be provided with a means for manually operated transmitter. A transmitter activated automatically shall cease transmission within 5 seconds after activation.

7.4.3 Test Configuration

Test according to clause 6.2 radio frequency test setup 2

7.4.4 Test Procedure

The following table is the setting of spectrum analyzer.

Spectrum analyzer	Setting
Attenuation	Auto
Span Frequency	0Hz
RB	3MHz
VB	3MHz
Detector	Peak
Trace	Max hold
Sweep Time	5S

- a. The transmitter output (antenna port) was connected to the spectrum analyzer.
- b. Set RBW of spectrum analyzer to 1MHz and VBW to 3MHz, Set Detector to Peak, Trace to Max Hold.
- c. Set the span to 0Hz and the sweep time to 5s and record the value.

7.4.5 Test Results

Temperature:	24°C	Test Date:	June 19, 2018
Humidity:	53 %	Test By:	KK
Test mode:	TX Mode		

Frequency.(MHz)	Transmitting time	Limit	Verdict
433.92	3.478s	<5s	PASS

Note1: The signal bandwidth was measured $(2/PW=2/(3.013 * 1 + 0.513 * 16 + 1.474 * 16)=0.057$ kHz) and less than 100kHz RBW so PDCF factor is not required

Note2: The PW data see the page 20.

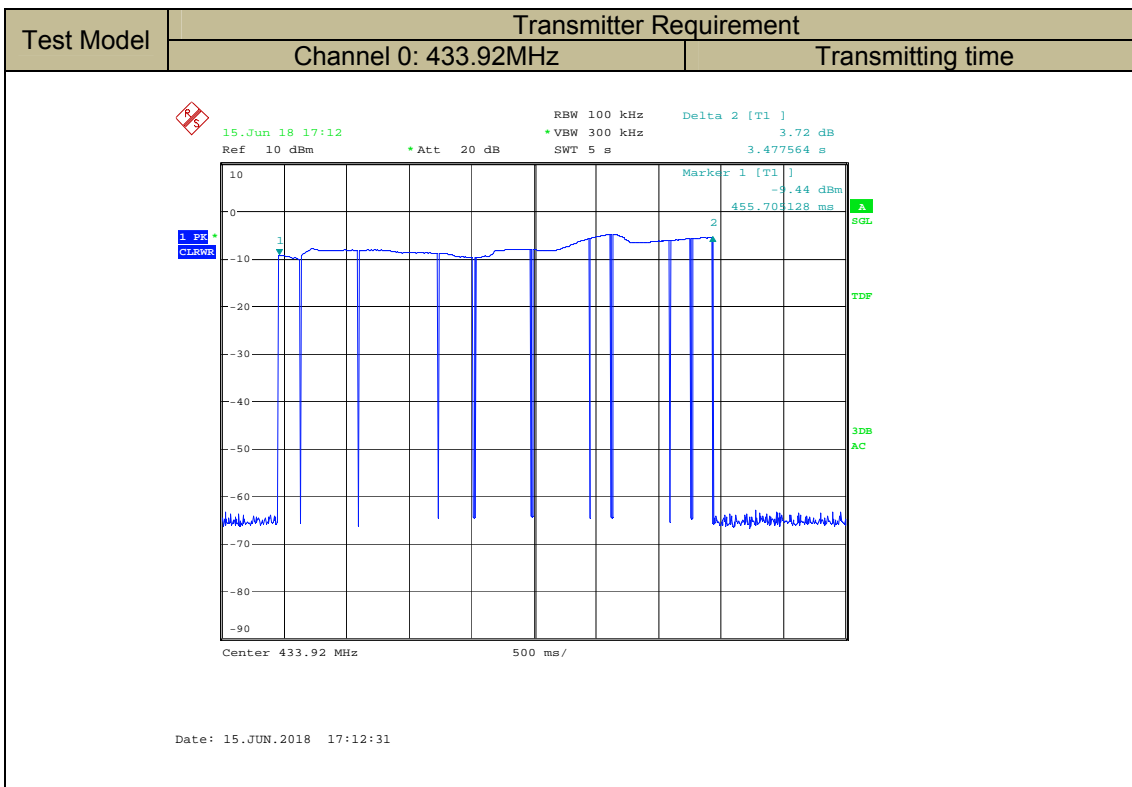

7.5 CONDUCTED EMISSION TEST

7.5.1 Applicable Standard

According to FCC Part 15.207(a)

7.5.2 Conformance Limit

Conducted Emission Limit		
Frequency(MHz)	Quasi-peak	Average
0.15-0.5	66-56	56-46
0.5-5.0	56	46
5.0-30.0	60	50

Note: 1. The lower limit shall apply at the transition frequencies
2. The limit decreases in line with the logarithm of the frequency in the range of 0.15 to 0.50MHz.

7.5.3 Test Configuration

Test according to clause 7.3 conducted emission test setup

7.5.4 Test Procedure

The EUT was placed on a table which is 0.8m above ground plane.
Maximum procedure was performed on the highest emissions to ensure EUT compliance.
Repeat above procedures until all frequency measured were complete.

7.5.5 Test Results

Not Applicable (EUT power supply is DC 12V)

7.6 Antenna Application

7.6.1 Antenna Requirement

Standard	Requirement
FCC CRF Part 15.203	An intentional radiator shall be designed to ensure that no antenna other than that furnished by the responsible party shall be used with the device. The use of a permanently attached antenna or of an antenna that uses a unique coupling to the intentional radiator shall be considered sufficient to comply with the provisions of this section. The manufacturer may design the unit so that a broken antenna can be replaced by the user, but the use of a standard antenna jack or electrical connector is prohibited. This requirement does not apply to carrier current devices or to devices operated under the provisions of §15.211, §15.213, §15.217, §15.219, or §15.221. Further, this requirement does not apply to intentional radiators that must be professionally installed, such as perimeter protection systems and some field disturbance sensors, or to other intentional radiators which, in accordance with §15.31(d), must be measured at the installation site. However, the installer shall be responsible for ensuring that the proper antenna is employed so that the limits in this part are not exceeded.

For intentional device, according to FCC 47 CFR Section 15.203, an intentional radiator shall be designed to ensure that no antenna other than that furnished by the responsible party shall be used with the device.

7.6.2 Result

PASS.

The EUT has 1 antenna: PCB Antenna, the gain is 0 dBi;

- Note:
- Antenna use a permanently attached antenna which is not replaceable.
 - Not using a standard antenna jack or electrical connector for antenna replacement
 - The antenna has to be professionally installed (please provide method of installation)

which in accordance to section 15.203, please refer to the internal photos.

8 Setup photos

8.1 RADIATED EMISSION TEST

