

FCC & ISED Radio Test Report

FCC ID: 2AP8SK301MR
IC: 24032-K301MR

The report concerns: Original Grant

Report Reference No.....: 20EFAS11132 1451

Date Sample(s) Received.....: 2020-11-28

Date of Tested.....: From 2020-11-28 to 2021-03-15

Date of issue.....: 2021-03-15

Testing Laboratory: DongGuan ShuoXin Electronic Technology Co., Ltd.
Zone A, 1F, No. 6, XinGang Road YuanGang Street,
Address: XinAn District, ChangAn Town, DongGuan City,
GuangDong, China

Applicant's name: SIG SAUER INC.

Address: 27100 SW Parkway Avenue, Wilsonville, Oregon
97070, USA.

Manufacturer.....: SIG SAUER INC.

Equipment.....: Laser range finder

Trade Mark: 

Model: KILO3000BDX

Ratings: I/P: DC 3V

HVIN: KILO3000BDX-R

Test Engineer: 
Blue Qiu

Responsible Engineer : 
Smile Wang

Authorized Signatory: 
King Wang

Table of Contents	Page
1 TEST REPORT DECLARE	4
2 SUMMARY OF TEST RESULTS	5
2.1 MEASUREMENT UNCERTAINTY	6
3 GENERAL INFORMATION	7
3.1 GENERAL DESCRIPTION OF EUT	7
3.2 DESCRIPTION OF TEST MODES	9
3.3 PARAMETERS OF TEST SOFTWARE	9
3.4 BLOCK DIAGRAM SHOWING THE CONFIGURATION OF SYSTEM TESTED	10
3.5 SUPPORT UNITS	10
3.6 TEST ENVIRONMENT CONDITIONS	10
4 RADIATED EMISSION TEST	11
4.1 LIMIT	11
4.2 TEST PROCEDURE	12
4.3 MEASUREMENT INSTRUMENTS LIST	13
4.4 TEST SETUP	13
4.5 EUT OPERATING CONDITIONS	14
4.6 TEST RESULT- 9KHZ TO 30MHZ	15
4.7 TEST RESULT- 30MHZ TO 1000MHZ	16
4.8 TEST RESULT- ABOVE 1000MHZ(BAND EDGE)	18
4.9 TEST RESULTS - ABOVE 1000MHZ(HARMONIC)	26
5 BANDWIDTH TEST	38
5.1 LIMIT	38
5.2 TEST PROCEDURE AND SETTING	38
5.3 MEASUREMENT INSTRUMENTS LIST	38
5.4 TEST SETUP	38
5.5 EUT OPERATION CONDITIONS	38
5.6 TEST RESULTS	39
6 MAXIMUM OUTPUT POWER	41
6.1 LIMIT	41
6.2 TEST PROCEDURE	41
6.3 MEASUREMENT INSTRUMENTS LIST	41
6.4 TEST SETUP	41
6.5 EUT OPERATION CONDITIONS	41

Table of Contents	Page
6.6 TESTRESULTS	42
7 CONDUCTED SPURIOUS EMISSION	43
7.1 LIMIT	43
7.2 TEST PROCEDURE	43
7.3 MEASUREMENT INSTRUMENTS LIST	43
7.4 TEST SETUP	43
7.5 EUT OPERATION CONDITIONS	43
7.6 TEST RESULTS	44
8 POWER SPECTRAL DENSITY TEST	45
8.1 LIMIT	45
8.2 TEST PROCEDURE	45
8.3 MEASUREMENT INSTRUMENTS LIST	45
8.4 TEST SETUP	45
8.5 EUT OPERATION CONDITIONS	45
8.6 TEST RESULTS	46
9 FREQUENCY STABILITY MEASUREMENT	47
9.1 LIMIT	47
9.2 TEST PROCEDURE	47
9.3 MEASUREMENT INSTRUMENTS LIST	47
9.4 TEST SETUP	47
9.5 EUT OPERATION CONDITIONS	47
9.6 TEST RESULTS	48

1 TEST REPORT DECLARE

Applicant	SIG SAUER INC.
Address	27100 SW Parkway Avenue, Wilsonville, Oregon 97070, USA.
Manufacturer	SIG SAUER INC.
Address	27100 SW Parkway Avenue, Wilsonville, Oregon 97070, USA.
Factory	BURST TRANSMISSION CO., LTD
Address	Mandalay - Lashio Road, Yatanarpon Myothit, Plot No. 3,4,11, Pyin Oo Lwin Township, Mandalay Region, Myanmar.
Equipment	Laser range finder
Model No.	KILO3000BDX
Trade Mark	
Standard	FCC Part15, Subpart C (15.247) RSS-247 Issue 2, Feb. 2017 RSS-Gen Issue 5, Mar. 2019 ANSI C63.10-2013

We Declare:

The equipment described above is tested by DongGuan ShuoXin Electronic Technology Co., Ltd(ATT). and in the configuration tested the equipment complied with the standards specified above. The test results are contained in this test report and DongGuan ShuoXin Electronic Technology Co., Ltd.(ATT) is assumed of full responsibility for the accuracy and completeness of these tests.

ATT is not responsible for the sampling stage, so the results only apply to the sample as received.

ATT's reports apply only to the specific samples tested under conditions. It is manufacture's responsibility to ensure that additional production units of this model are manufactured with the identical electrical and mechanical components. ATT shall have no liability for any declarations, inferences or generalizations drawn by the client or others from ATT issued reports.

2 SUMMARY OF TEST RESULTS

The EUT have been tested according to the applicable standards as referenced below:

Standard(s) Section		Test Item	Judgment	Remark
FCC	ISED			
15.207	RSS-Gen8.8	AC Power Line Conducted Emissions	N/A	-----
15.247(d) 15.205(a) 15.209(a)	RSS-247 5.5 RSS-Gen8.9 RSS-Gen8.10	Radiated Emissions	PASS	-----
15.247(a)(2)	RSS-247 5.2 (a) RSS-Gen6.7	Bandwidth	PASS	-----
15.247(b)(3)	RSS-247 5.4 (d)	Maximum Output Power	PASS	-----
15.247(d)	RSS-247 5.5	ConductedSpurious Emission	PASS	-----
15.247(e)	RSS-247 5.2 (b)	Power Spectral Density	PASS	-----
-	RSS-Gen 6.11	Frequency Stability	PASS	-----
15.203	-	Antenna Requirement	PASS	Note(2)

Note:

- (1) "N/A" denotes test is not applicable to this device.
- (2) The device what use a permanently attached antenna were considered sufficient to comply with the provisions of 15.203.

2.1 MEASUREMENT UNCERTAINTY

Test Item	Uncertainty
Uncertainty for Conduction emission test (9kHz-150kHz)	3.7 dB
Uncertainty for Conduction emission test (150kHz-30MHz)	3.3 dB
Uncertainty for Radiation Emission test (30MHz-200MHz)	4.60 dB (Polarize: V)
	4.60 dB (Polarize: H)
Uncertainty for Radiation Emission test (200MHz-1GHz)	6.10 dB (Polarize: V)
	5.08 dB (Polarize: H)
Uncertainty for Radiation Emission test (1GHz-6GHz)	5.01 dB (Polarize: V)
	5.01 dB (Polarize: H)
Uncertainty for Radiation Emission test (6GHz-18GHz)	5.26 dB (Polarize: V)
	5.26 dB (Polarize: H)
Uncertainty for Radiation Emission test (18GHz-40GHz)	5.06 dB (Polarize: V)
	5.06 dB (Polarize: H)
Uncertainty for radio frequency	±0.048kHz
Uncertainty for conducted RF Power	±0.32dB

Note:

This uncertainty represents an expanded uncertainty expressed at approximately the 95%confidence level using a coverage factor of k=2.

Test Facility:

The Test site used by DongGuan ShuoXin Electronic Technology Co., Ltd. to collect test data is located on the Zone A, 1F, No. 6, XinGang Road YuanGang Street, XinAn District, ChangAn Town, DongGuan City, GuangDong, China

The test facility is recognized, certified, or accredited by the following organizations:

Item	Registration No.	Expiration Date
CNAS	L3098	2024-08-27
A2LA	4893.01	2022-06-30
Innovation, Science and Economic Development Canada (ISED)	11033A	2022-06-30
Federal Communications Commission (FCC)	171688 Designation No.:CN1235	2022-06-30

3 GENERAL INFORMATION

3.1 GENERAL DESCRIPTION OF EUT

Equipment	Laser range finder	
Brand Name		
Test Model	KILO3000BDX	
Series Model	N/A	
Model Difference(s)	N/A	
Hardware Version	V1.0	
Software Version	V1.0	
Power Source	Supplied from Battery.	
Power Rating	DC 3V	
Operation Frequency	2402 MHz ~ 2480 MHz	
Modulation Technology	GFSK	
Bit Rate of Transmitter	1Mbps /2Mbps	
Antenna Information	Antenna Type: FPCB	Maximum Peak Gain: 1.55dBi
Max. Output Power	3.172dBm(0.00197 W) 1Mbps 2.843dBm(0.00192 W) 2Mbps	

Note:

1. For a more detailed features description, please refer to the manufacturer’s specifications or the user’s manual.

2. Channel List:

Channel	Frequency (MHz)	Channel	Frequency (MHz)
00	2402	20	2442
01	2404	21	2444
02	2406	22	2446
03	2408	23	2448
04	2410	24	2450
05	2412	25	2452
06	2414	26	2454
07	2416	27	2456
08	2418	28	2458
09	2420	29	2460
10	2422	30	2462
11	2424	31	2464
12	2426	32	2466
13	2428	33	2468
14	2430	34	2470
15	2432	35	2472
16	2434	36	2474
17	2436	37	2476
18	2438	38	2478
19	2440	39	2480

3.2 DESCRIPTION OF TEST MODES

The test system was pre-tested based on the consideration of all possible combinations of EUT operation mode.

Pretest Mode	Description
Mode 1	BLE 1M TX Mode NOTE (1)
Mode 2	BLE 2M TX Mode NOTE (1)

Following mode(s) as (were) found to be the worst case(s) and selected for the final test.

Radiated emissions test - Below 1GHz	
Final Test Mode	Description
Mode 3	BLE 1M TX Mode Channel 19

Radiated emissions test - Above 1GHz	
Final Test Mode	Description
Mode 1	BLE 1M TX Mode NOTE (1)
Mode 2	BLE 2M TX Mode NOTE (1)

Conducted test	
Final Test Mode	Description
Mode 1	BLE 1M TX Mode NOTE (1)
Mode 2	BLE 2M TX Mode NOTE (1)

Note:

- (1) The measurements are performed at the high, middle, low available channels.
- (2) Full battery is used during all test.
- (3) For radiated emission test ,X,Y,Z axis of EUT all have been tested, only worse case is reported.

3.3 PARAMETERS OF TEST SOFTWARE

During testing channel & power controlling software provided by the customer was used to control the operating channel as well as the output power level. The RF output power selection is for the setting of RF output power expected by the customer and is going to be fixed on the firmware of the final end product power parameters of BT LE

Test Software	nRFgo		
Frequency (MHz)	2402	2440	2480
Parameters-1Mbps	N/A	N/A	N/A
Parameters-2Mbps	N/A	N/A	N/A

3.4 BLOCK DIAGRAM SHOWING THE CONFIGURATION OF SYSTEM TESTED

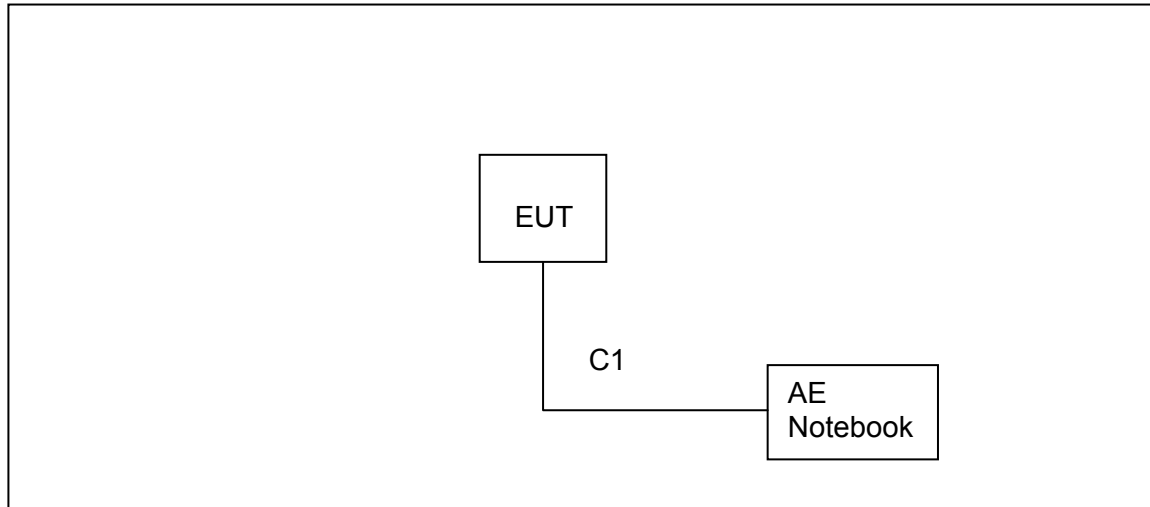

3.5 SUPPORT UNITS

Item	Equipment	Brand	Model No.	Series No.
AE	Notebook	ACER	MS2367	32807810766

Item	Cable Type	Shielded Type	Ferrite Core	Length
C1	DC Cable	NO	NO	0.8m

3.6 TEST ENVIRONMENT CONDITIONS

Test Item	Temperature	Humidity	Test Voltage
AC Power Line Conducted Emissions	23.1°C	52%	DC 3V
Radiated Emissions-9K-30MHz	22°C	60%	DC 3V
Radiated Emissions-30 MHz to 1GHz	23°C	54%	DC 3V
Radiated Emissions-Above 1000 MHz	23°C	54%	DC 3V
Bandwidth	20.6°C	51%	DC 3V
Maximum Output Power	20.6°C	51%	DC 3V
Conducted Spurious Emission	20.6°C	51%	DC 3V
Power Spectral Density	20.6°C	51%	DC 3V

4 RADIATED EMISSION TEST

4.1 LIMIT

In case the emission fall within the restricted band specified on 15.205(a) and RSS-Gen 8.10, then the 15.209(a) and RSS-Gen 8.9limit in the table below has to be followed.

LIMITS OF RADIATED EMISSION MEASUREMENT (9 kHz-1000MHz)

Frequency (MHz)	Field Strength (microvolts/meter)	Measurement Distance (meters)
0.009-0.490	2400/F(kHz)	300
0.490-1.705	24000/F(kHz)	30
1.705-30.0	30	30
30-88	100	3
88-216	150	3
216-960	200	3
Above 960	500	3

LIMITS OF RADIATED EMISSION MEASUREMENT (9 kHz-30 MHz)

Frequency (MHz)	Magnetic field strength (H-Field) (μA/m)	Measurement Distance (meters)
0.009-0.490	6.37/F(kHz)	300
0.490-1.705	6.37/F(kHz)	30
1.705-30.0	0.08	30

LIMITS OF RADIATED EMISSION MEASUREMENT (30 MHz-1000MHz)

Frequency (MHz)	Field Strength (μV/m at 3m)
30-88	100
88-216	150
216-960	200
Above 960	500

LIMITS OF RADIATED EMISSION MEASUREMENT (Above 1000MHz)

Frequency (MHz)	(dBuV/m at 3 m)	
	Peak	Average
Above 1000	74	54

Note:

- (1) The limit for radiated test was performed according to FCC PART 15C and RSS-247.
- (2) The tighter limit applies at the band edges.
- (3) Emission level (dBuV/m)=20log Emission level (uV/m).

4.2 TEST PROCEDURE

- a. The measuring distance of 3 m shall be used for measurements. The EUT was placed on the top of a rotating table 0.8 meter above the ground at a 3 meter semi-anechoic chamber. The table was rotated 360 degrees to determine the position of the highest radiation.(below 1GHz)
- b. The measuring distance of 3 m or 1.5m shall be used for measurements. The EUT was placed on the top of a rotating table 1.5 meter above the ground at a 3 meter semi-anechoic chamber. The table was rotated 360 degrees to determine the position of the highest radiation.(above 1GHz)
- c. The height of the equipment or of the substitution antenna shall be 0.8m or 1.5m; the height of the test antenna shall vary between 1 m to 4 m. Both horizontal and vertical polarizations of the antenna are set to make the measurement.
- d. For each suspected emission, the EUT was arranged to its worst case and then the antenna was tuned to heights find the maximum reading (used Bore sight function).
- e. The receiver system was set to peak and average detect function and specified bandwidth with maximum hold mode when the test frequency is above 1GHz.
- f. The initial step in collecting radiated emission data is a receiver peak detector mode pre-scanning the measurement frequency range. Significant peaks are then marked and then Quasi Peak detector mode re-measured.
- g. All readings are Peak unless otherwise stated QP in column of Note. Peak denotes that the Peak reading compliance with the QP Limits and then QP Mode measurement didn't perform. (below 1GHz)
- h. All readings are Peak Mode value unless otherwise stated AVG in column of Note. If the Peak Mode Measured value compliance with the Peak Limits and lower than AVG Limits, the EUT shall be deemed to meet both Peak & AVG Limits and then only Peak Mode was measured, but AVG Mode didn't perform. (above 1GHz)
- i. The test result is calculated as the following:
 - (1) Result = Reading + Correct Factor
 - (2) Correct Factor = Antenna Factor + Cable Loss – Amplifier Gain + Attenuator
 - (3) Margin = Result - Limit

Spectrum Parameter	Setting
Attenuation	Auto
Start Frequency	1000 MHz
Stop Frequency	10th carrier harmonic
RBW / VBW (Emission in restricted band)	RBW 1MHz VBW 3MHz peak detector for Pk value RMS detector for AV value

Receiver Parameter	Setting
Attenuation	Auto
Start ~ Stop Frequency	9 kHz~90 kHz for PK/AVG detector
Start ~ Stop Frequency	90 kHz~110 kHz for QP detector
Start ~ Stop Frequency	110 kHz~490 kHz for PK/AVG detector
Start ~ Stop Frequency	490 kHz~30 MHz for QP detector
Start ~ Stop Frequency	30MHz~1000MHz for QP detector

4.3 MEASUREMENT INSTRUMENTS LIST

Item	Equipment	Manufacturer	Model No.	Serial No.	Calibrated until
1	EMI Test Receiver	R&S	ESCI	101307	12/12/2021
2	Spectrum Analyzer	Agilent	E4407B	US40240708	11/17/2021
3	Loop antenna	SCHWARZBECK K	FMZB1519	1519-062	12/14/2021
4	Broadband antenna	SCHWARZBECK	VULB9168	VULB9168-192	08/06/2021
5	HORN ANTENNA	SCHWARZBECK	BBHA9120D	9120D 1065	04/21/2021
6	Preamplifier Amplifier	HP	8447F	3113A05680	12/11/2021
7	PRE-AMPLIFIER	CY	EMC011830	980136	12/11/2021
8	RF Cable	R&S	Test Cable 4	4	12/11/2021
9	RF Cable	R&S	Test Cable 5	5	12/11/2021
10	RF Cable	R&S	Test Cable 9	9	04/21/2021
11	RF Cable	R&S	Test Cable 10	10	12/11/2021
12	Measurement Software	Farad	EZ-EMC (Ver.ATT-03A)	N/A	N/A

4.4 TESTSETUP

9 kHz-30 MHz

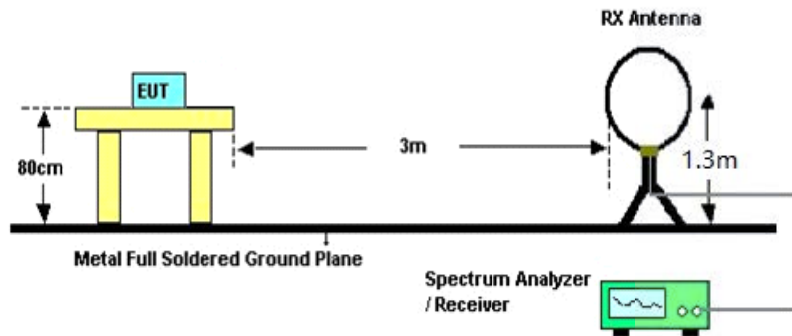

30 MHz to 1 GHz

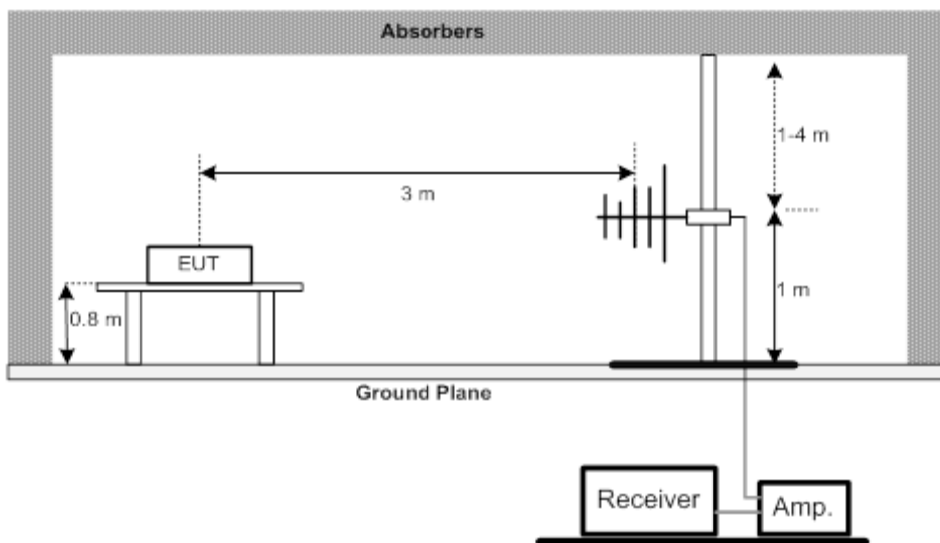

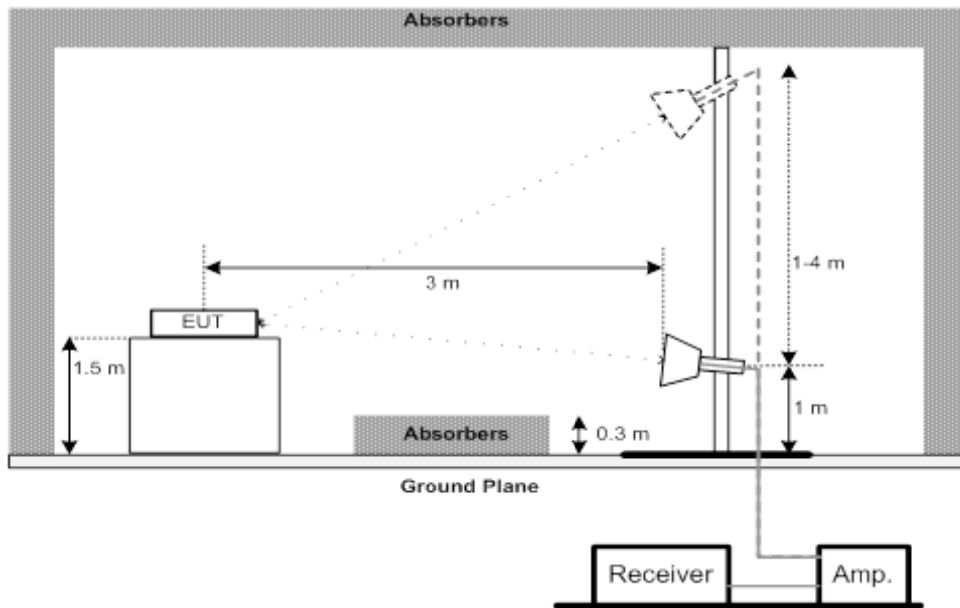
Above 1 GHz**4.5 EUT OPERATING CONDITIONS**

The EUT was programmed to be in continuously transmitting mode.

4.6 TEST RESULT- 9kHz TO 30MHz

Test Mode:	BLE 1M TX Mode Channel 19
------------	---------------------------

Freq. (MHz)	Reading (dBuV/m)	Limit (dBuV/m)	Margin (dB)	State P/F
--	--	--	--	P
--	--	--	--	P

Note:

The amplitude of spurious emissions which are attenuated by more than 20dB below the permissible value has no need to be reported.

Distance extrapolation factor = $20 \log (\text{specific distance}/\text{test distance})(\text{dB})$;

Limit line = specific limits(dBuv) + distance extrapolation factor

4.7 TEST RESULT- 30MHz TO 1000MHz

Test Mode : BLE 1M TX Mode Channel 19

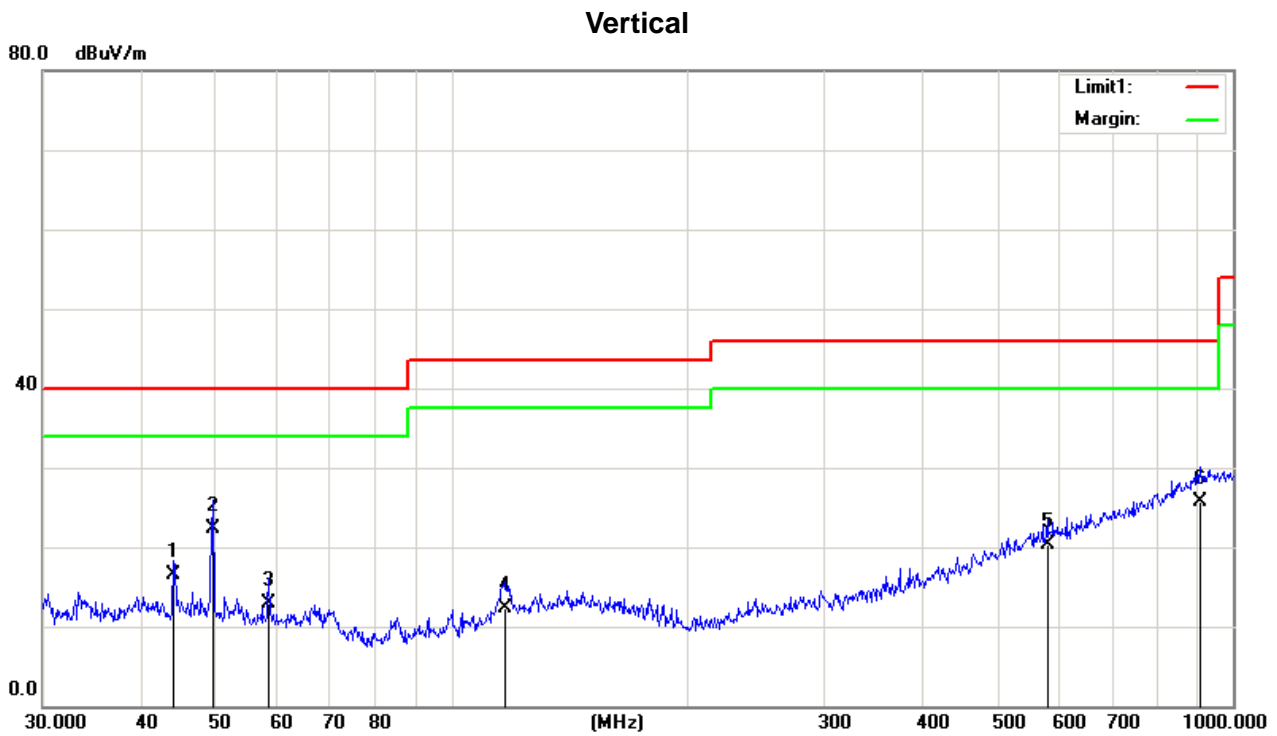

No.	Frequency (MHz)	Reading (dBuV/m)	Correct Factor(dB/m)	Result (dBuV/m)	Limit (dBuV/m)	Margin (dB)	Remark
1	44.1202	29.50	-12.97	16.53	40.00	-23.47	QP
2	49.5328	35.37	-13.11	22.26	40.00	-17.74	QP
3	58.4074	26.79	-13.84	12.95	40.00	-27.05	QP
4	116.9495	25.61	-13.26	12.35	43.50	-31.15	QP
5	578.6699	24.18	-3.88	20.30	46.00	-25.70	QP
6	906.4824	22.18	3.47	25.65	46.00	-20.35	QP

Test Mode : BLE 1M TX Mode Channel 19

Horizontal

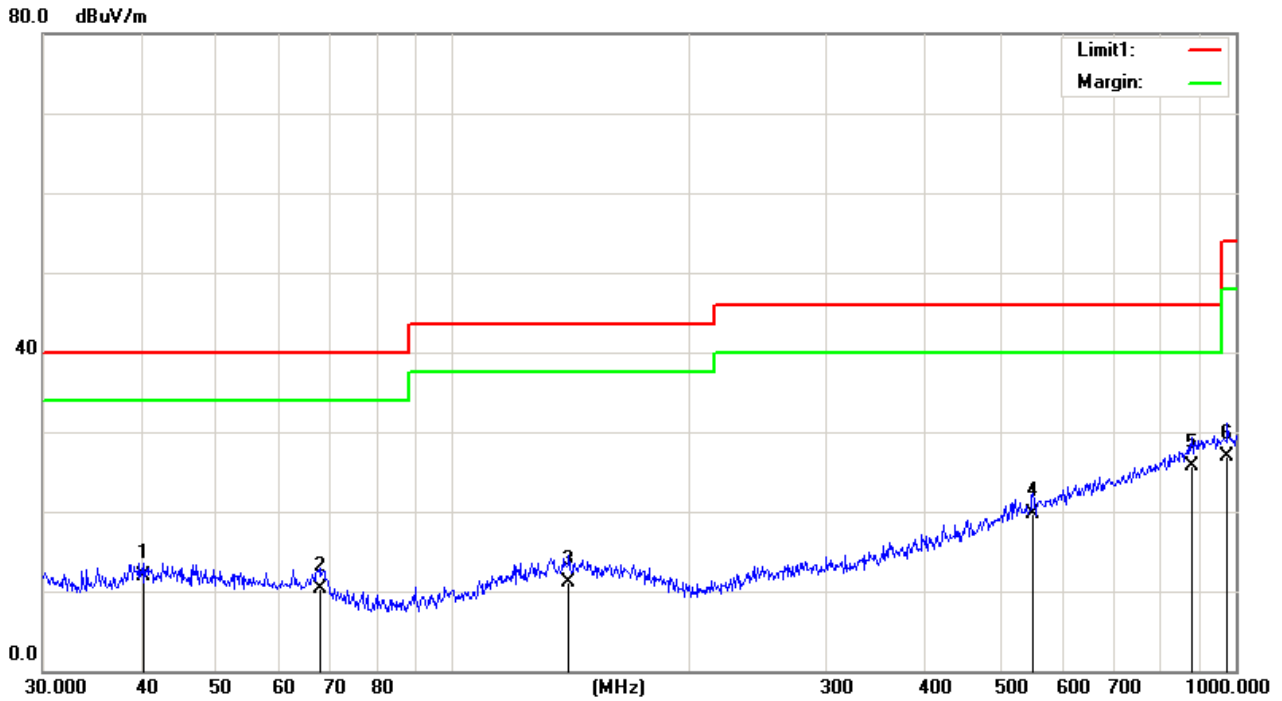

No.	Frequency (MHz)	Reading (dBuV/m)	Correct Factor(dB/m)	Result (dBuV/m)	Limit (dBuV/m)	Margin (dB)	Remark
1	40.2757	24.85	-12.85	12.00	40.00	-28.00	QP
2	67.6751	24.93	-14.63	10.30	40.00	-29.70	QP
3	140.8351	22.60	-11.49	11.11	43.50	-32.39	QP
4	550.9480	24.18	-4.55	19.63	46.00	-26.37	QP
5	878.3214	22.82	2.83	25.65	46.00	-20.35	QP
6	975.7529	22.73	4.27	27.00	54.00	-27.00	QP

4.8 TEST RESULT- ABOVE 1000MHz(BAND EDGE)

Test Mode: TX 2402 MHz_CH00_1Mbps

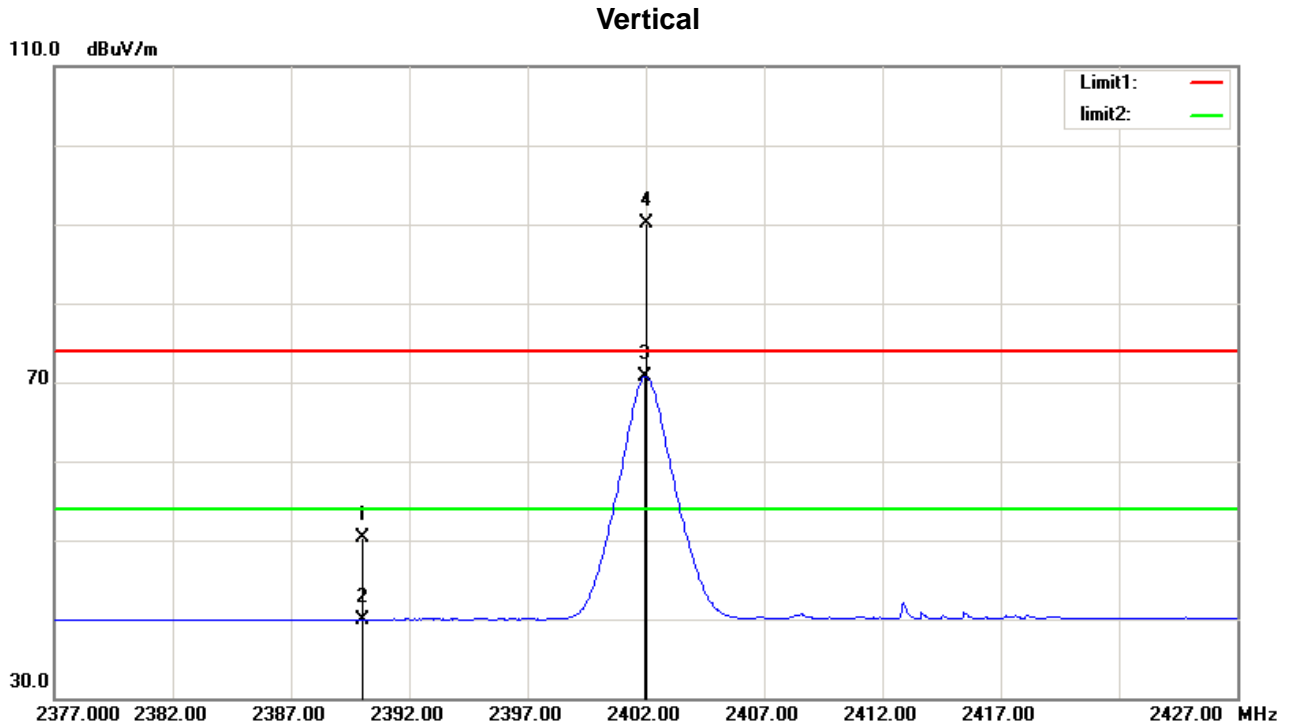

No.	Frequency (MHz)	Reading (dBuV/m)	Correct Factor(dB/m)	Result (dBuV/m)	Limit (dBuV/m)	Margin (dB)	Remark
1	2390.000	20.19	30.06	50.25	74.00	-23.75	peak
2	2390.000	9.90	30.06	39.96	54.00	-14.04	AVG
3	2401.950	40.57	30.10	70.67	/	/	AVG
4	2402.050	60.10	30.10	90.20	/	/	peak

Test Mode: TX 2402 MHz_CH00_1Mbps

Horizontal

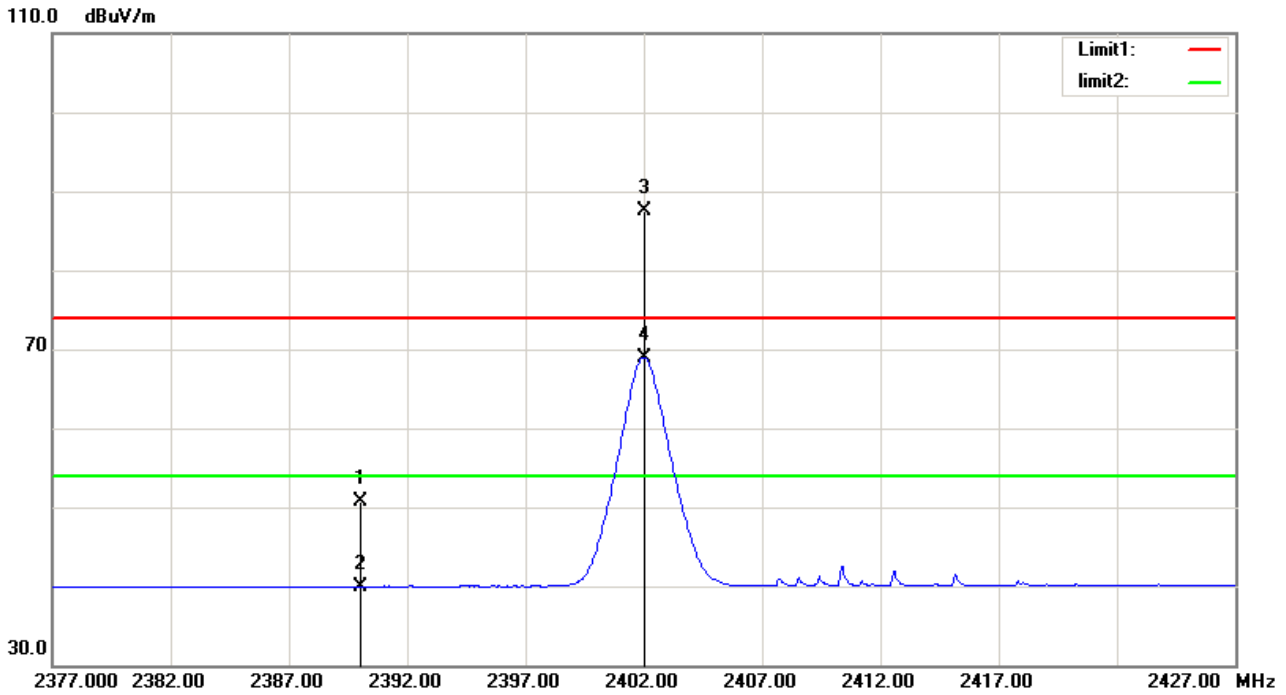

No.	Frequency (MHz)	Reading (dBuV/m)	Correct Factor(dB/m)	Result (dBuV/m)	Limit (dBuV/m)	Margin (dB)	Remark
1	2390.000	20.63	30.06	50.69	74.00	-23.31	peak
2	2390.000	9.89	30.06	39.95	54.00	-14.05	AVG
3	2402.000	57.50	30.10	87.60	/	/	peak
4	2402.000	38.90	30.10	69.00	/	/	AVG

Test Mode: TX 2480 MHz_CH39_1Mbps

Vertical

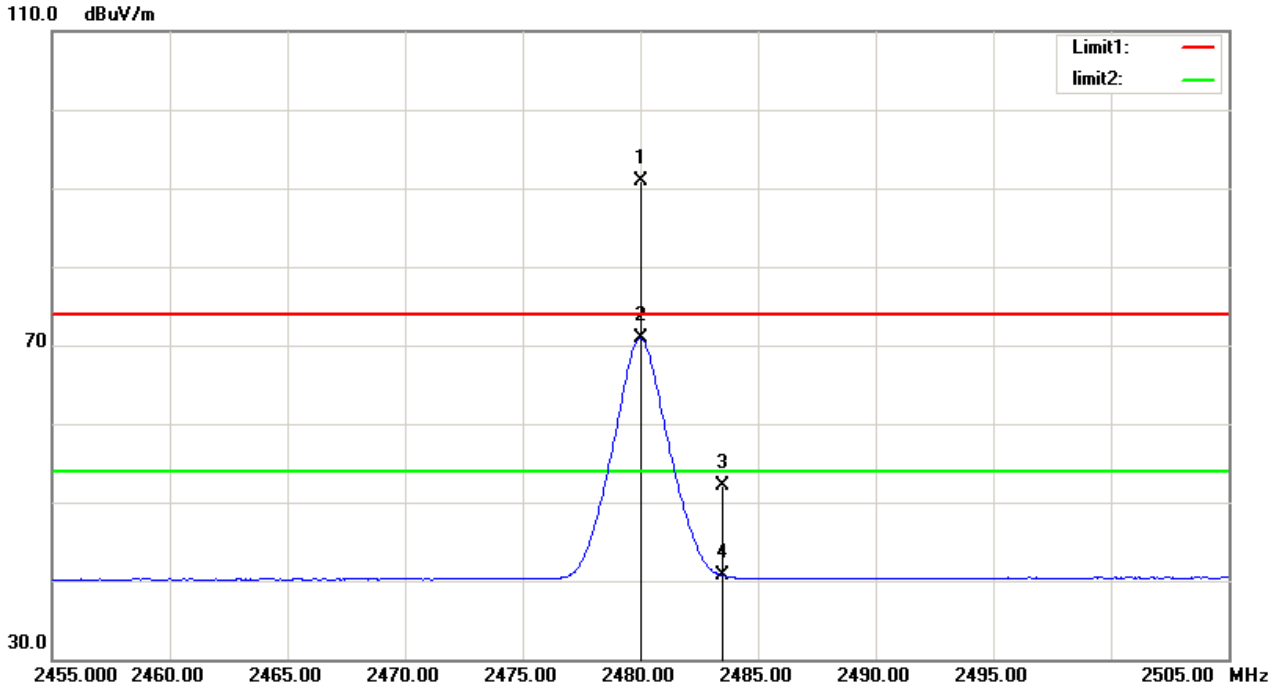

No.	Frequency (MHz)	Reading (dBuV/m)	Correct Factor(dB/m)	Result (dBuV/m)	Limit (dBuV/m)	Margin (dB)	Remark
1	2480.000	60.63	30.32	90.95	/	/	peak
2	2480.000	40.58	30.32	70.90	/	/	AVG
3	2483.500	21.82	30.33	52.15	74.00	-21.85	peak
4	2483.500	10.29	30.33	40.62	54.00	-13.38	AVG

Test Mode: TX 2480 MHz_CH39_1Mbps

Horizontal

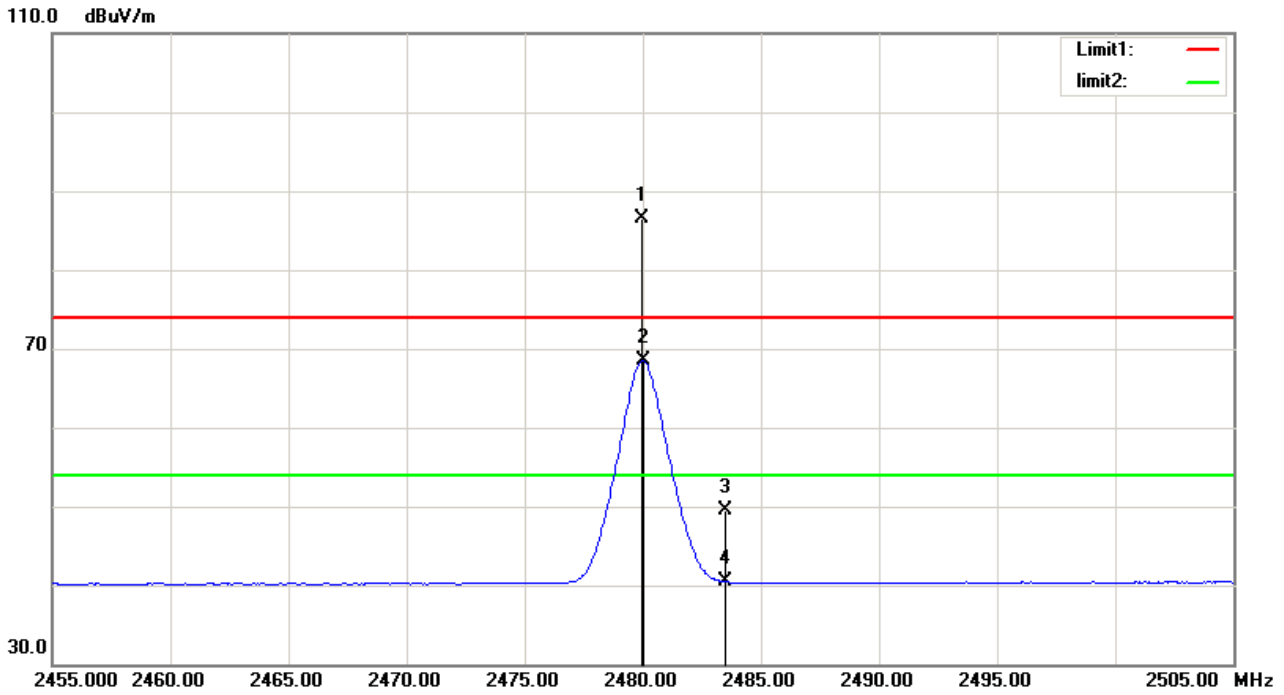

No.	Frequency (MHz)	Reading (dBuV/m)	Correct Factor(dB/m)	Result (dBuV/m)	Limit (dBuV/m)	Margin (dB)	Remark
1	2479.950	56.09	30.32	86.41	/	/	peak
2	2480.000	38.12	30.32	68.44	/	/	AVG
3	2483.500	19.08	30.33	49.41	74.00	-24.59	peak
4	2483.500	10.14	30.33	40.47	54.00	-13.53	AVG

Test Mode: TX 2402 MHz_CH00_2Mbps

Vertical

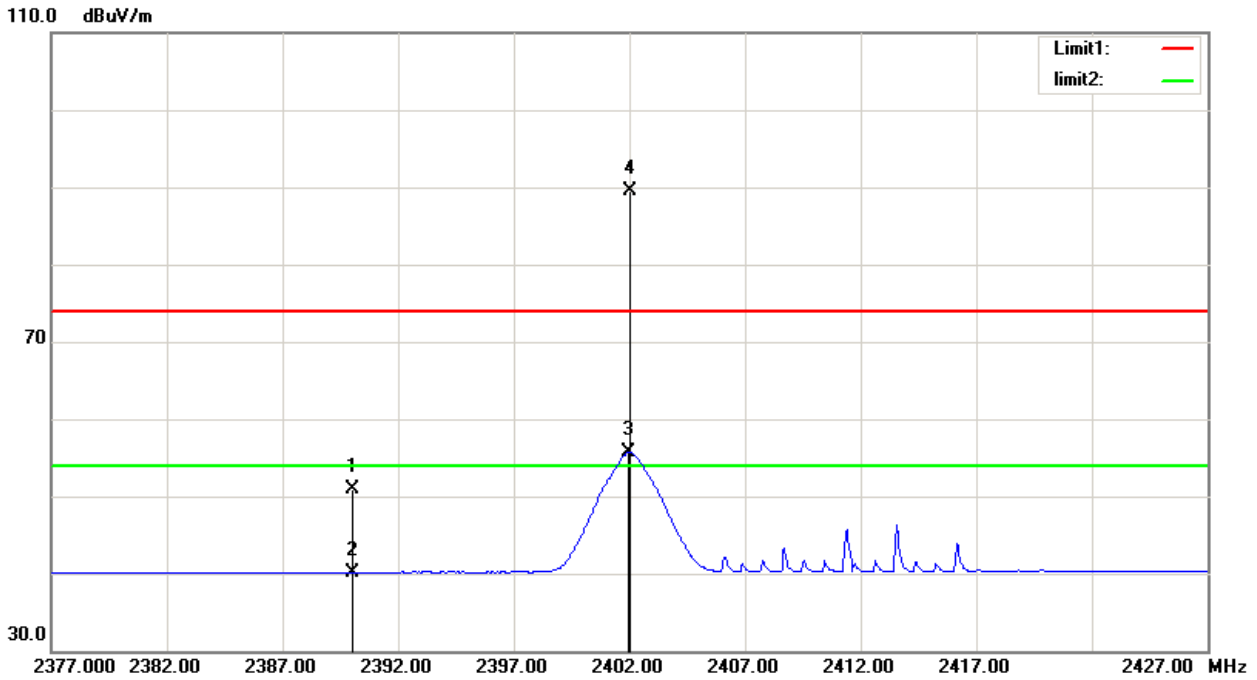

No.	Frequency (MHz)	Reading (dBuV/m)	Correct Factor(dB/m)	Result (dBuV/m)	Limit (dBuV/m)	Margin (dB)	Remark
1	2390.000	20.87	30.06	50.93	74.00	-23.07	peak
2	2390.000	10.07	30.06	40.13	54.00	-13.87	AVG
3	2401.950	25.58	30.10	55.68	/	/	AVG
4	2402.000	59.33	30.10	89.43	/	/	peak

Test Mode: TX 2402 MHz_CH00_2Mbps

Horizontal

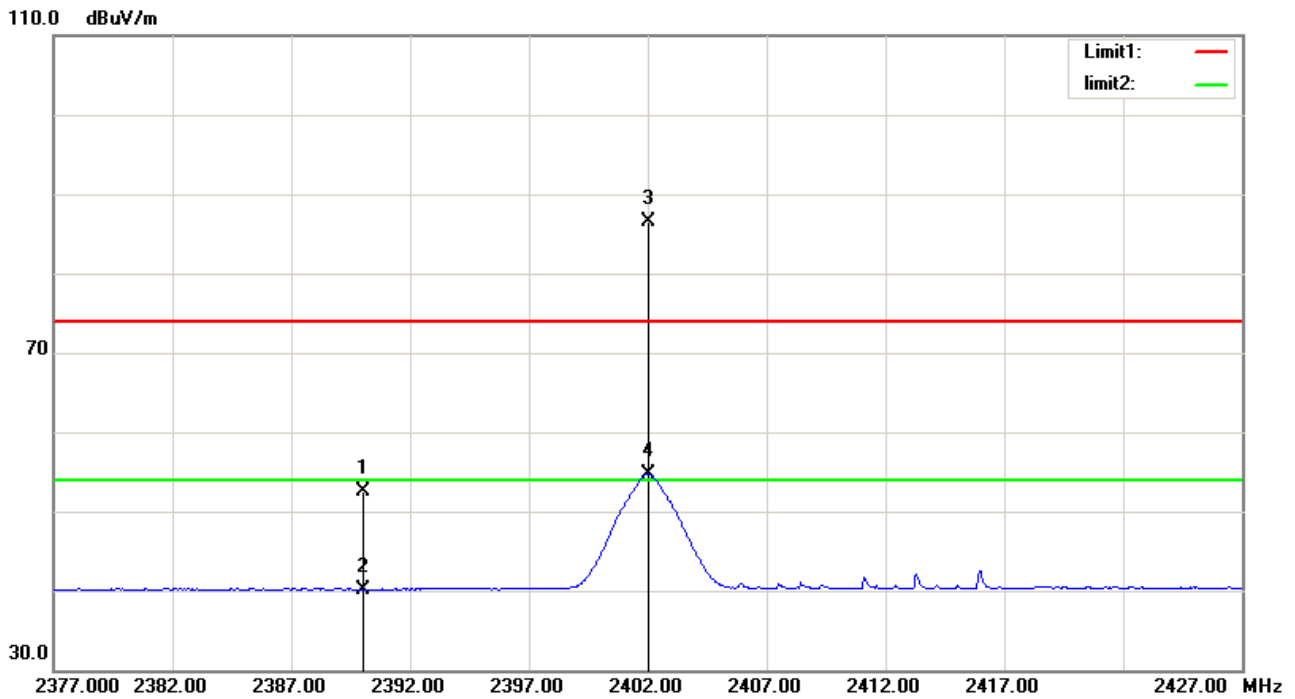

No.	Frequency (MHz)	Reading (dBuV/m)	Correct Factor(dB/m)	Result (dBuV/m)	Limit (dBuV/m)	Margin (dB)	Remark
1	2390.000	22.36	30.06	52.42	74.00	-21.58	peak
2	2390.000	10.11	30.06	40.17	54.00	-13.83	AVG
3	2402.050	56.36	30.10	86.46	/	/	peak
4	2402.050	24.62	30.10	54.72	/	/	AVG

Test Mode: TX 2480 MHz_CH39_2Mbps

Vertical

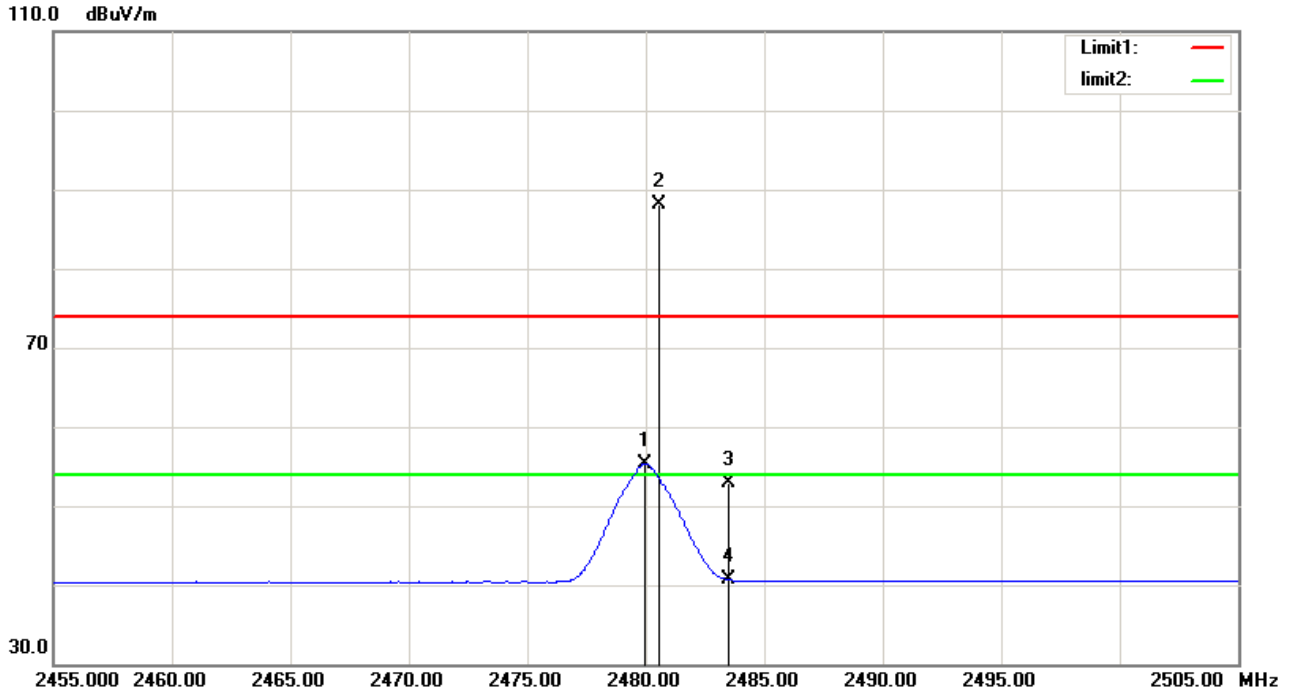

No.	Frequency (MHz)	Reading (dBuV/m)	Correct Factor(dB/m)	Result (dBuV/m)	Limit (dBuV/m)	Margin (dB)	Remark
1	2479.950	25.04	30.32	55.36	/	/	AVG
2	2480.550	57.68	30.33	88.01	/	/	peak
3	2483.500	22.49	30.33	52.82	74.00	-21.18	peak
4	2483.500	10.32	30.33	40.65	54.00	-13.35	AVG

Test Mode: TX 2480 MHz_CH39_2Mbps

Horizontal

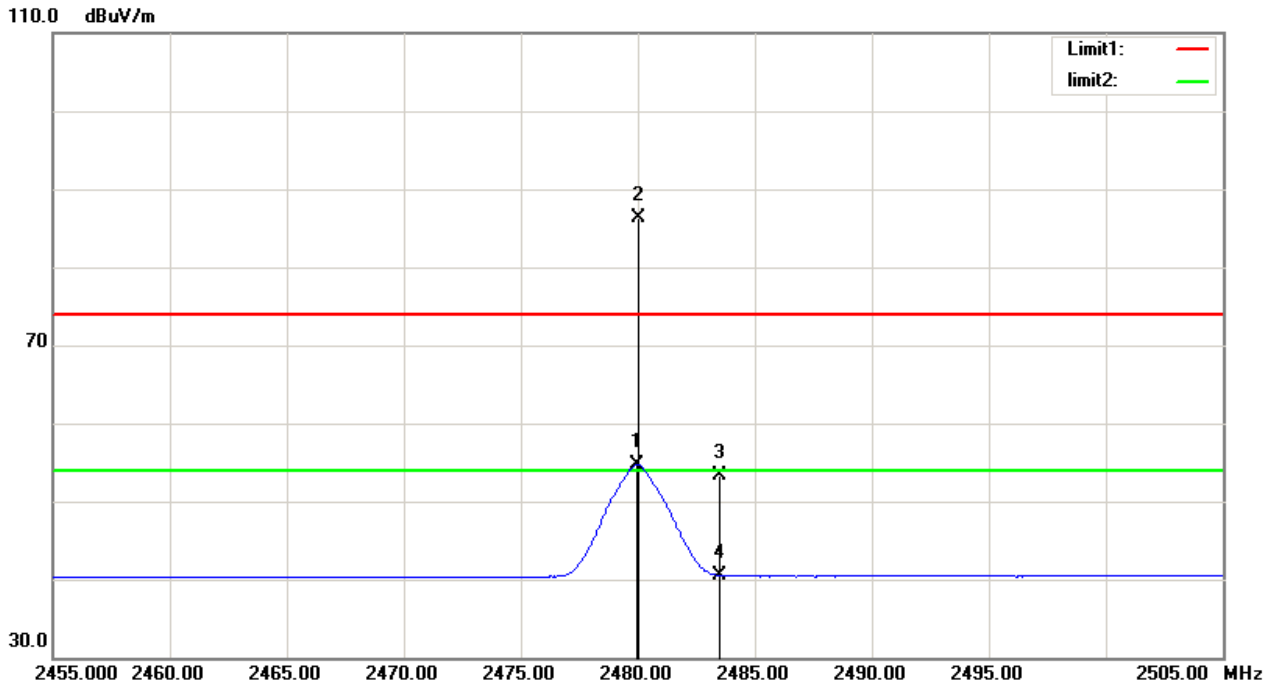

No.	Frequency (MHz)	Reading (dBuV/m)	Correct Factor(dB/m)	Result (dBuV/m)	Limit (dBuV/m)	Margin (dB)	Remark
1	2479.950	24.36	30.32	54.68	/	/	AVG
2	2480.050	55.92	30.32	86.24	/	/	peak
3	2483.500	22.92	30.33	53.25	74.00	-20.75	peak
4	2483.500	10.18	30.33	40.51	54.00	-13.49	AVG

4.9 TEST RESULTS - ABOVE 1000MHz(HARMONIC)

Test Mode: TX 2402 MHz_CH00_1Mbps

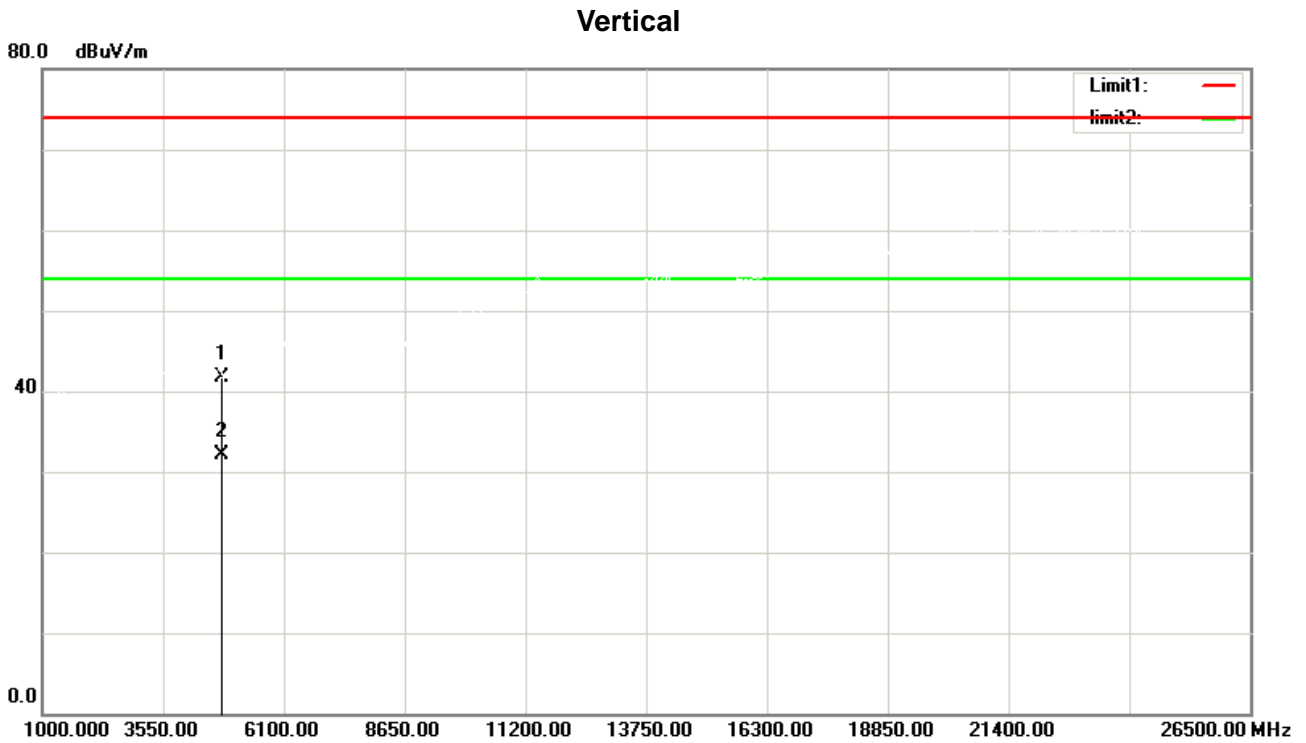

No.	Frequency (MHz)	Reading (dBuV/m)	Correct Factor(dB/m)	Result (dBuV/m)	Limit (dBuV/m)	Margin (dB)	Remark
1	4804.000	49.32	-7.53	41.79	74.00	-32.21	peak
2	4804.000	39.65	-7.53	32.12	54.00	-21.88	AVG

Test Mode: TX 2402 MHz_CH00_1Mbps

Horizontal

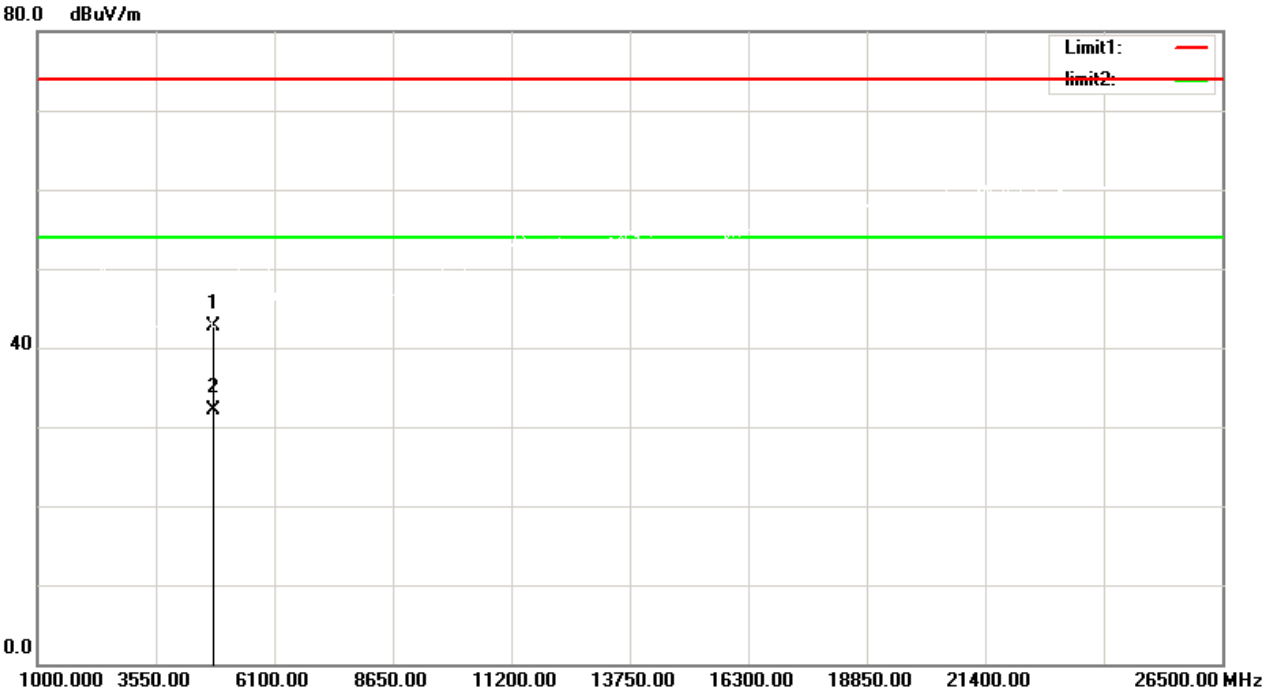

No.	Frequency (MHz)	Reading (dBuV/m)	Correct Factor (dB/m)	Result (dBuV/m)	Limit (dBuV/m)	Margin (dB)	Remark
1	4804.000	50.26	-7.53	42.73	74.00	-31.27	peak
2	4804.000	39.65	-7.53	32.12	54.00	-21.88	AVG

Test Mode: TX 2440 MHz_CH19_1Mbps

Vertical

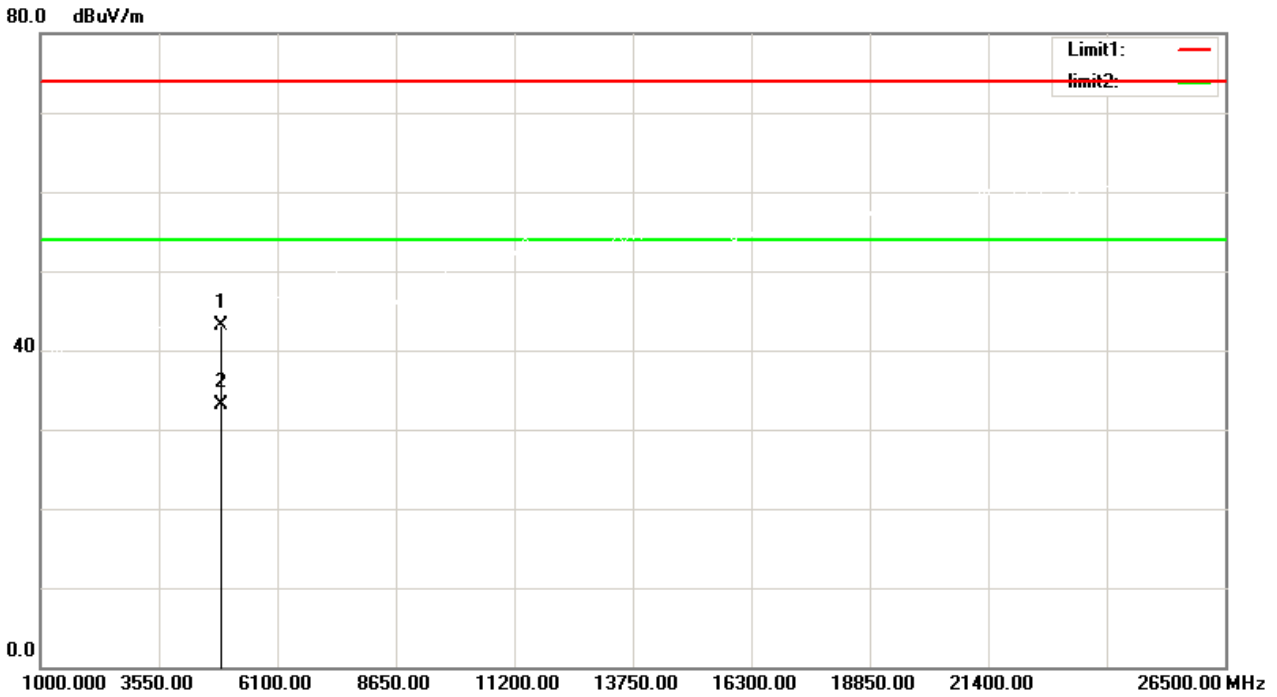

No.	Frequency (MHz)	Reading (dBuV/m)	Correct Factor(dB/m)	Result (dBuV/m)	Limit (dBuV/m)	Margin (dB)	Remark
1	4880.000	50.42	-7.31	43.11	74.00	-30.89	peak
2	4880.000	40.39	-7.31	33.08	54.00	-20.92	AVG

Test Mode: TX 2440 MHz_CH19_1Mbps

Horizontal

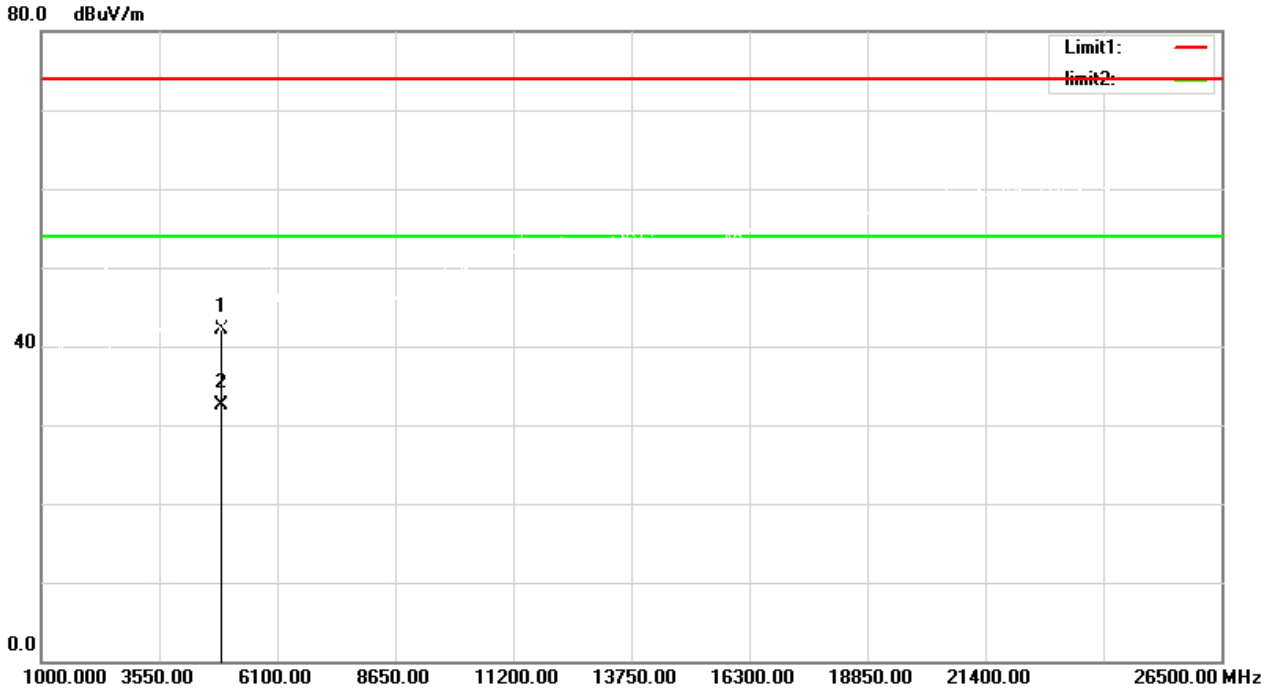

No.	Frequency (MHz)	Reading (dBuV/m)	Correct Factor(dB/m)	Result (dBuV/m)	Limit (dBuV/m)	Margin (dB)	Remark
1	4880.500	49.46	-7.31	42.15	74.00	-31.85	peak
2	4880.500	39.90	-7.31	32.59	54.00	-21.41	AVG

Test Mode: TX 2480 MHz_CH39_1Mbps

Vertical

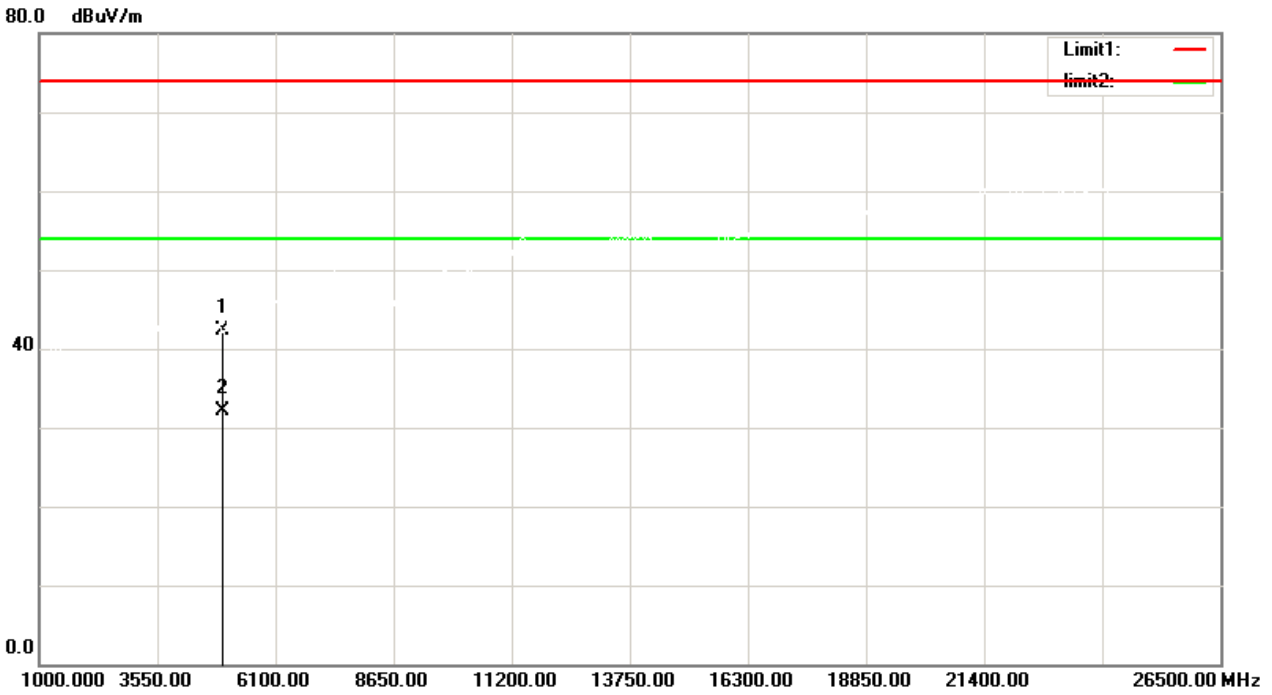

No.	Frequency (MHz)	Reading (dBuV/m)	Correct Factor(dB/m)	Result (dBuV/m)	Limit (dBuV/m)	Margin (dB)	Remark
1	4960.000	49.48	-7.09	42.39	74.00	-31.61	peak
2	4960.000	39.15	-7.09	32.06	54.00	-21.94	AVG

Test Mode: TX 2480 MHz_CH39_1Mbps

Horizontal

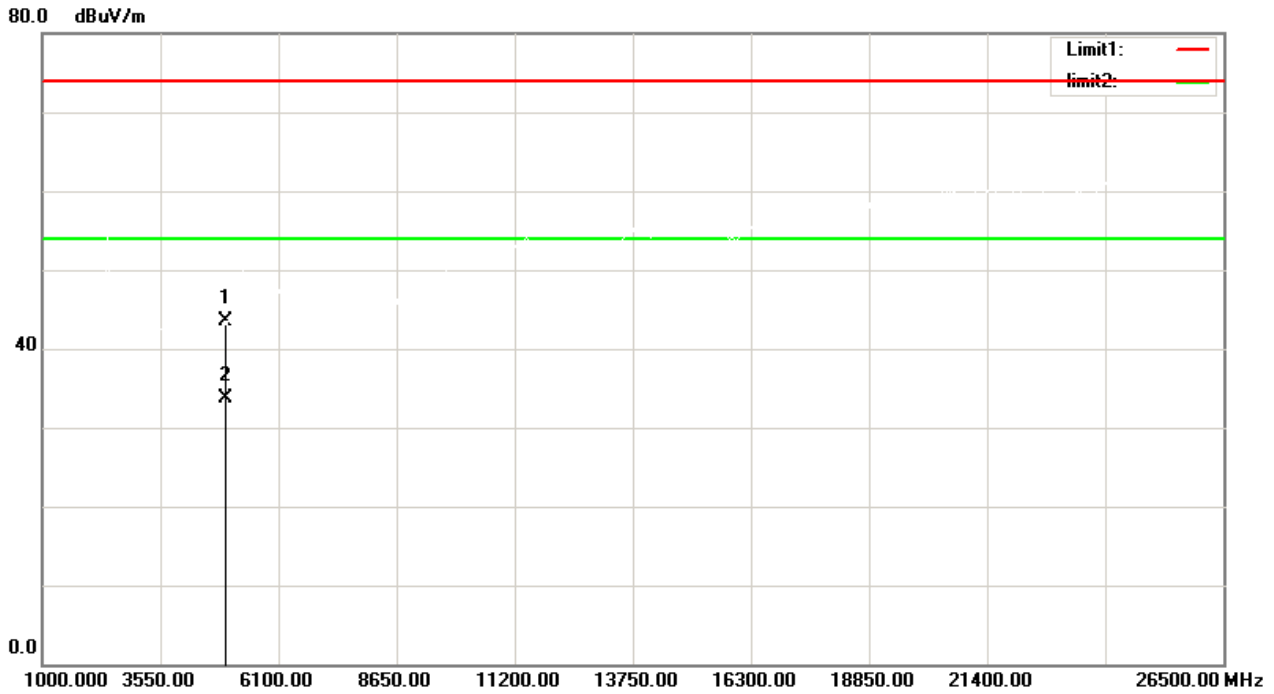

No.	Frequency (MHz)	Reading (dBuV/m)	Correct Factor(dB/m)	Result (dBuV/m)	Limit (dBuV/m)	Margin (dB)	Remark
1	4960.000	50.62	-7.09	43.53	74.00	-30.47	peak
2	4960.000	40.75	-7.09	33.66	54.00	-20.34	AVG

Test Mode: TX 2402 MHz_CH00_2Mbps

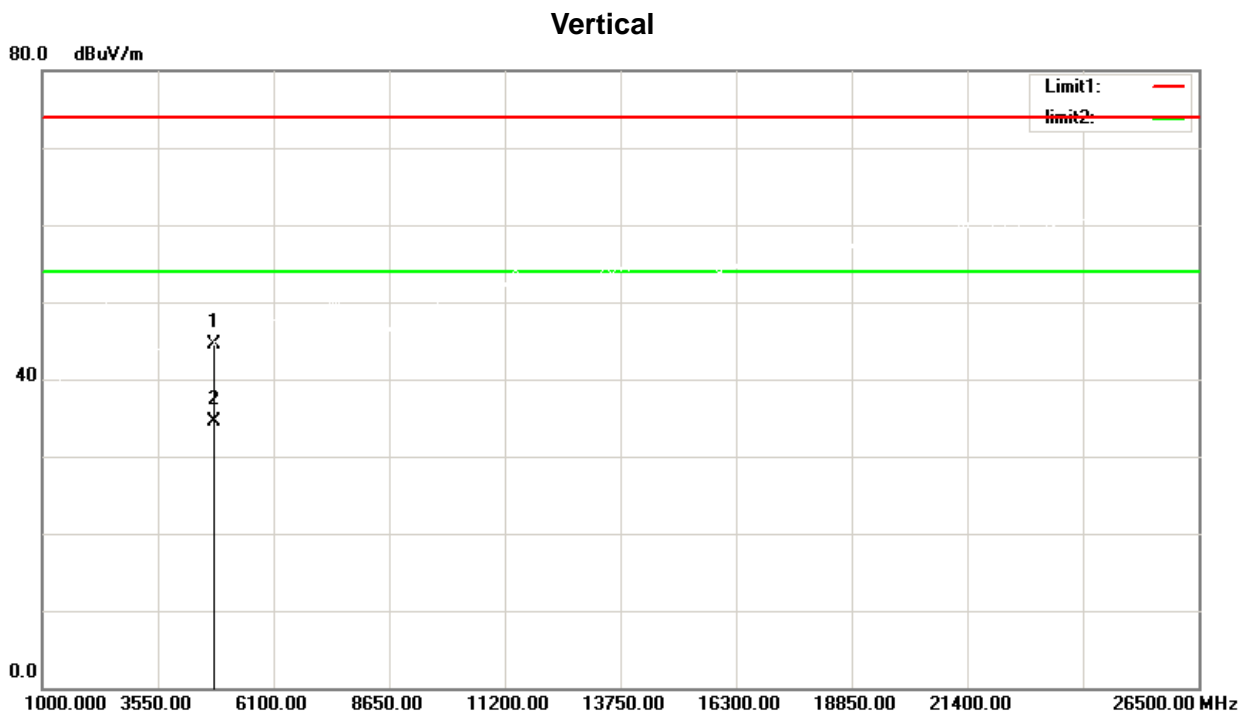

No.	Frequency (MHz)	Reading (dBuV/m)	Correct Factor (dB/m)	Result (dBuV/m)	Limit (dBuV/m)	Margin (dB)	Remark
1	4804.000	52.09	-7.53	44.56	74.00	-29.44	peak
2	4804.000	42.12	-7.53	34.59	54.00	-19.41	AVG

Test Mode: TX 2402 MHz_CH00_2Mbps

Horizontal

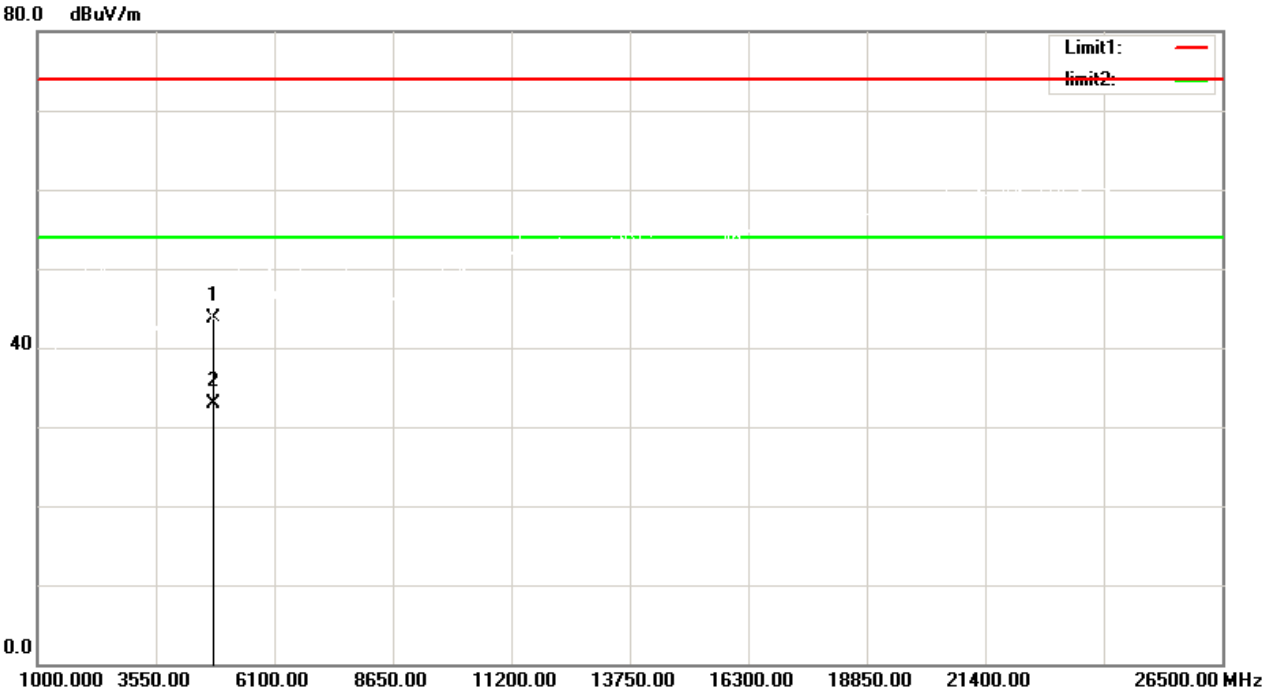

No.	Frequency (MHz)	Reading (dBuV/m)	Correct Factor(dB/m)	Result (dBuV/m)	Limit (dBuV/m)	Margin (dB)	Remark
1	4804.000	51.18	-7.53	43.65	74.00	-30.35	peak
2	4804.000	40.45	-7.53	32.92	54.00	-21.08	AVG

Test Mode: TX 2440 MHz_CH19_2Mbps

Vertical

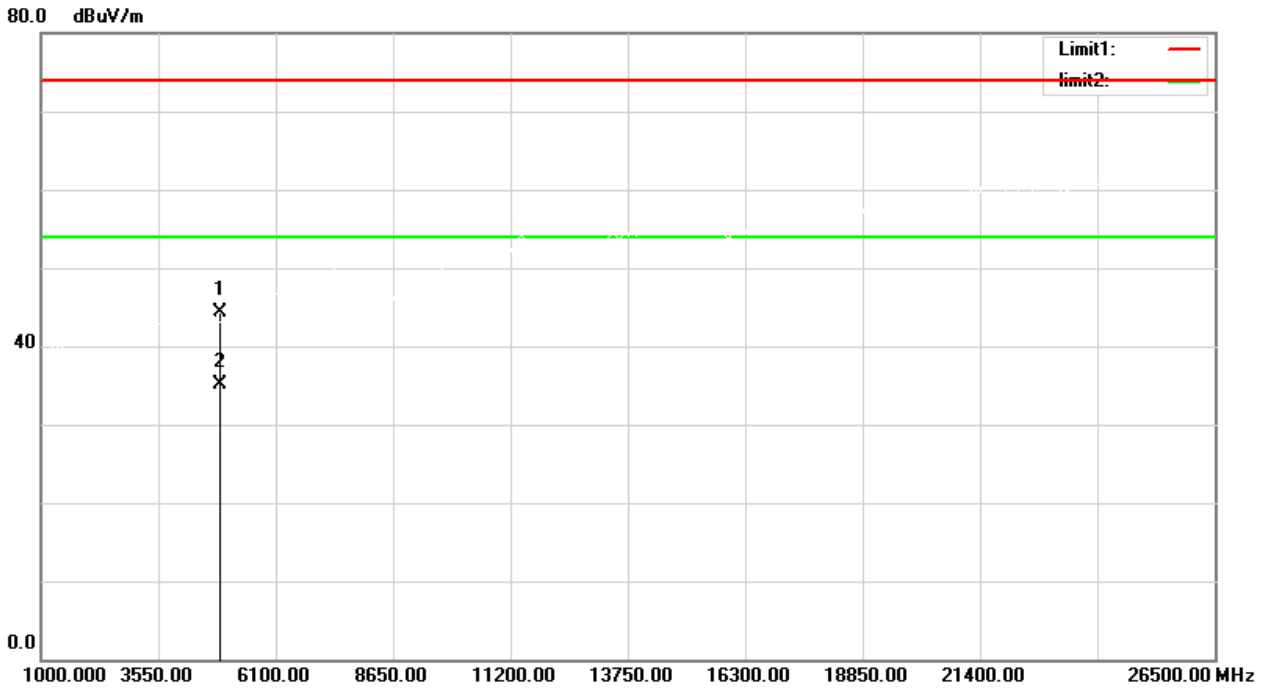

No.	Frequency (MHz)	Reading (dBuV/m)	Correct Factor(dB/m)	Result (dBuV/m)	Limit (dBuV/m)	Margin (dB)	Remark
1	4880.000	51.53	-7.31	44.22	74.00	-29.78	peak
2	4880.000	42.43	-7.31	35.12	54.00	-18.88	AVG

Test Mode: TX 2440 MHz_CH19_2Mbps

Horizontal

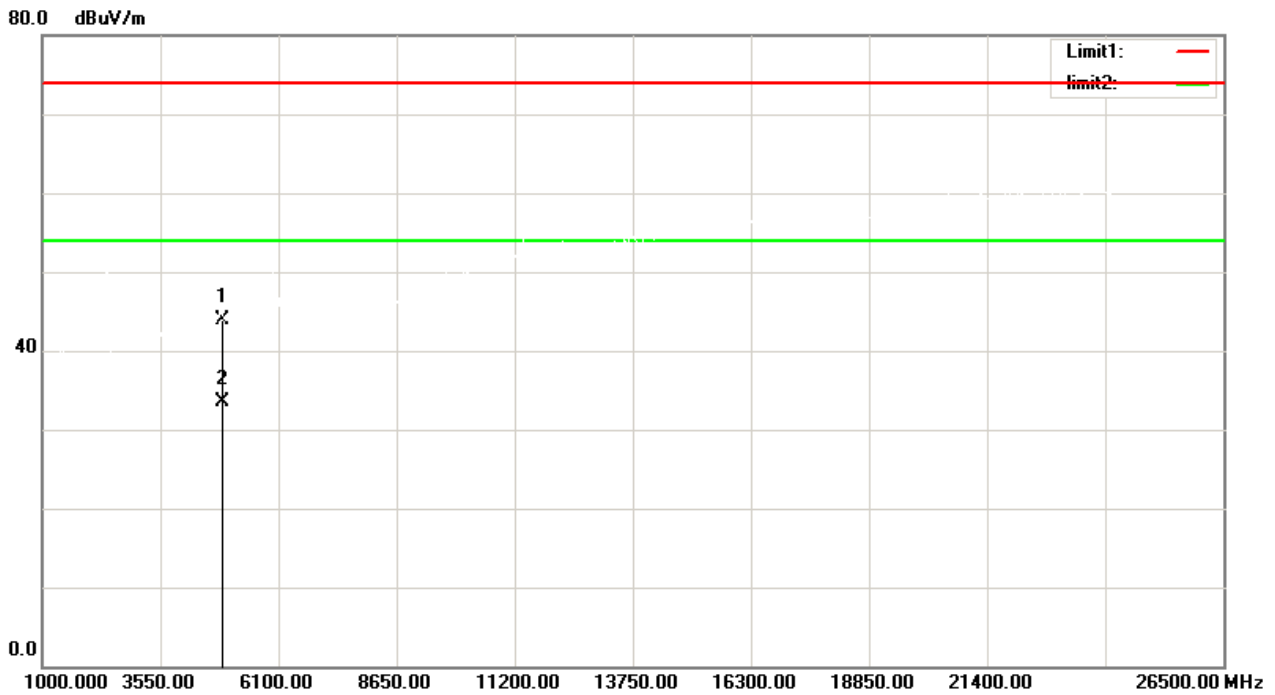

No.	Frequency (MHz)	Reading (dBuV/m)	Correct Factor(dB/m)	Result (dBuV/m)	Limit (dBuV/m)	Margin (dB)	Remark
1	4880.500	51.23	-7.31	43.92	74.00	-30.08	peak
2	4880.500	40.83	-7.31	33.52	54.00	-20.48	AVG

Test Mode: TX 2480 MHz_CH39_2Mbps

Vertical

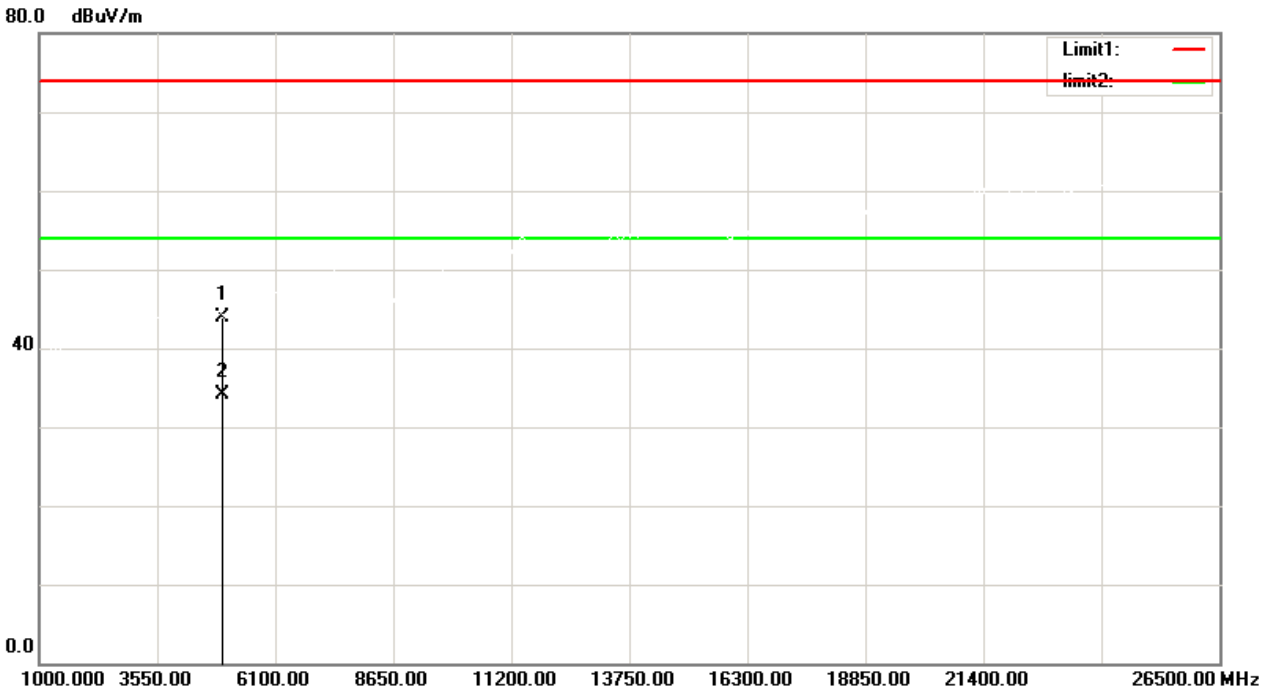

No.	Frequency (MHz)	Reading (dBuV/m)	Correct Factor(dB/m)	Result (dBuV/m)	Limit (dBuV/m)	Margin (dB)	Remark
1	4960.000	50.95	-7.09	43.86	74.00	-30.14	peak
2	4960.000	41.24	-7.09	34.15	54.00	-19.85	AVG

Test Mode: TX 2480 MHz_CH39_2Mbps

Horizontal

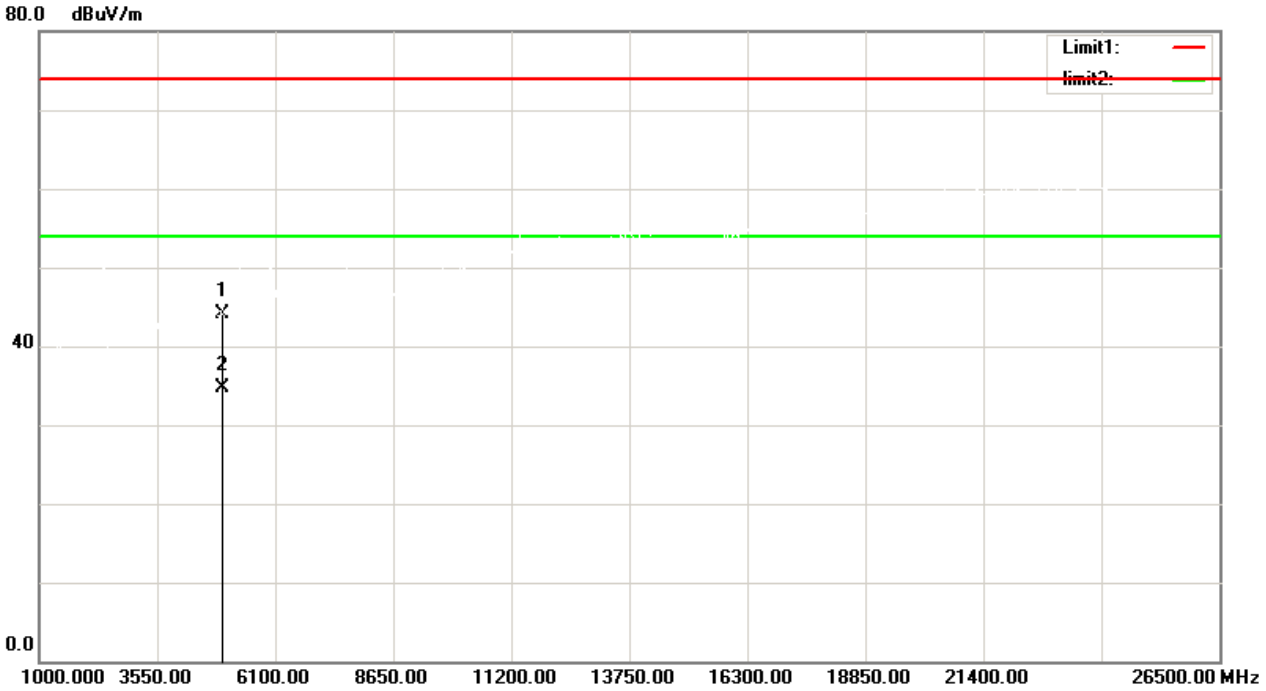

No.	Frequency (MHz)	Reading (dBuV/m)	Correct Factor(dB/m)	Result (dBuV/m)	Limit (dBuV/m)	Margin (dB)	Remark
1	4960.000	51.18	-7.09	44.09	74.00	-29.91	peak
2	4960.000	41.81	-7.09	34.72	54.00	-19.28	AVG

5 BANDWIDTH TEST

5.1 LIMIT

FCC Part15, Subpart C (15.247)& RSS-Gen/ RSS-247		
Section	Test Item	Limit
15.247(a)(2) RSS-Gen6.7 RSS-247 5.2 (a)	Bandwidth	>= 500 kHz (6dB bandwidth)

5.2 TEST PROCEDURE AND SETTING

- a. The EUT was directly connected to the spectrum analyzer and antenna output port as show in the block diagram below.
- b. Spectrum Setting:
 For 6dB Bandwidth RBW= 100 kHz, VBW=300 kHz, Sweep time =Auto.
 For 99% Bandwidth RBW=30kHz, VBW=100kHz, Sweep time =Auto for 1Mbps.
 RBW=100kHz, VBW=300kHz, Sweep time =Auto for 2Mbps.

5.3 MEASUREMENT INSTRUMENTS LIST

Item	Kind of Equipment	Manufacturer	Type No.	Serial No.	Calibrated until
1	Spectrum analyzer	KEYSIGHT	N9010A	MY55150427	2021/05/24
2	Attenuator	Mini-Circuits	BW-S10W2	101109	N/A
3	RF Cable	Mi-cable	C10-01-01-1	100309	N/A

5.4 TEST SETUP

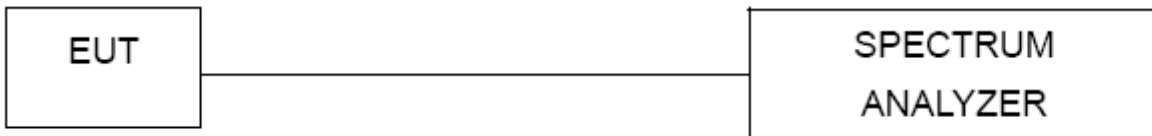

5.5 EUT OPERATION CONDITIONS

The EUT tested system was configured as the statements of 4.5 unless otherwise a special operating condition is specified in the follows during the testing.

5.6 TESTRESULTS

TX Mode_1Mbps				
Channel	Frequency (MHz)	6 dB bandwidth (MHz)	99%OBW (MHz)	Result
CH00	2402	0.661	1.0305	PASS
CH19	2440	0.661	1.0245	PASS
CH39	2480	0.660	1.0305	PASS

6dB

2402MHz

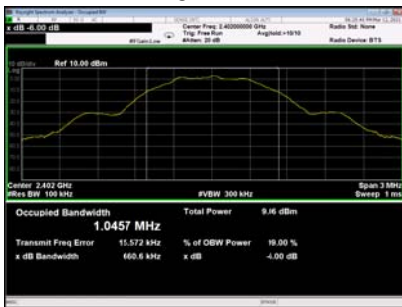

2440MHz



2480MHz



99%

2402MHz



2440MHz



2480MHz



TX Mode_2Mbps				
Channel	Frequency (MHz)	6 dB bandwidth (MHz)	99%OBW (MHz)	Result
CH00	2402	1.108	2.0610	PASS
CH19	2440	0.961	2.0517	PASS
CH39	2480	1.147	2.0387	PASS

6dB

2402MHz



2440MHz



2480MHz



99%

2402MHz



2440MHz



2480MHz



6 MAXIMUM OUTPUT POWER

6.1 LIMIT

FCC Part15, Subpart C (15.247)&RSS-247		
Section	Test Item	Limit
15.247(b)(3) RSS-2475.4 (d)	Maximum Output Power	1 watt or 30dBm

6.2 TEST PROCEDURE

- a. The EUT was directly connected to the spectrum analyzer and antenna output port as show in the block diagram below.
- b. The maximum conducted output power was performed in accordance with method 11.9.1.3(for peak power)ofANSI C63.10-2013.

6.3 MEASUREMENT INSTRUMENTS LIST

Item	Kind of Equipment	Manufacturer	Type No.	Serial No.	Calibrated until
1	Spectrum analyzer	KEYSIGHT	N9010A	MY55150427	2021/05/24
2	Attenuator	Mini-Circuits	BW-S10W2	101109	N/A
3	RF Cable	Mi-cable	C10-01-01-1	100309	N/A

6.4 TEST SETUP



6.5 EUT OPERATION CONDITIONS

The EUT tested system was configured as the statements of 4.5 unless otherwise a special operating condition is specified in the follows during the testing.

6.6 TESTRESULTS

TX Mode_1Mbps				
Channel	Frequency (MHz)	Output Power (dBm)	Output Power (W)	Result
CH00	2402	2.936	0.00197	PASS
CH19	2440	3.172	0.00208	PASS
CH39	2480	2.951	0.00197	PASS
Limit	30dBm / 1W			

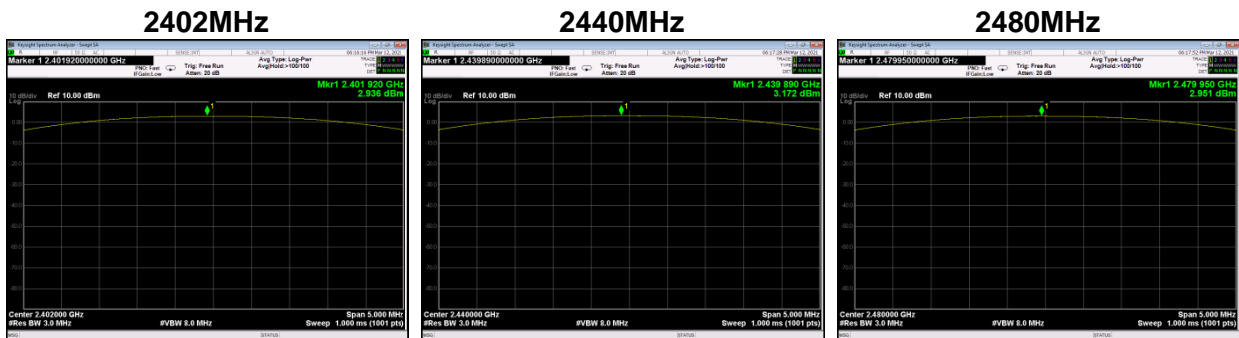

TX Mode_2Mbps				
Channel	Frequency (MHz)	Output Power (dBm)	Output Power (W)	Result
CH00	2402	2.562	0.00180	PASS
CH19	2440	2.843	0.00192	PASS
CH39	2480	2.597	0.00182	PASS
Limit	30dBm / 1W			

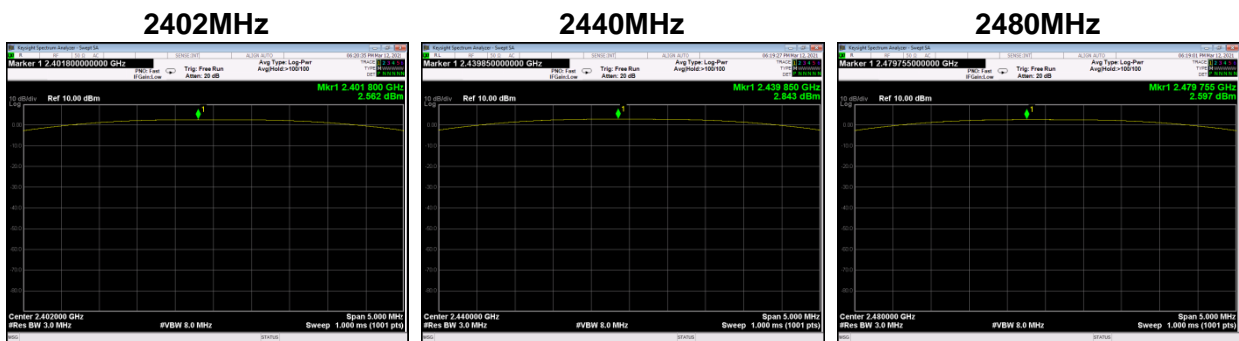

7 CONDUCTED SPURIOUS EMISSION

7.1 LIMIT

For FCC

In any 100 kHz bandwidth outside the frequency band in which the spread spectrum or digitally modulated intentional radiator is operating, the radio frequency power that is produced by the intentional radiator shall be at least 20 dB below that in the 100 kHz bandwidth within the band that contains the highest level of the desired power, based on either an RF conducted or a radiated measurement, provided the transmitter demonstrates compliance with the peak Output Power limits. If the transmitter complies with the Output Power limits based on the use of RMS averaging over a time interval, as permitted under paragraph (b)(3) of this section, the attenuation required under this paragraph shall be 30 dB instead of 20 dB. Attenuation below the general limits specified in Section 15.209(a) is not required.

For ISED

In any 100 kHz bandwidth outside the frequency band in which the spread spectrum or digitally modulated device is operating, the RF power that is produced shall be at least 20 dB below that in the 100 kHz bandwidth within the band that contains the highest level of the desired power, based on either an RF conducted or a radiated measurement, provided that the transmitter demonstrates compliance with the peak Output Power limits. If the transmitter complies with the Output Power limits based on the use of root-mean-square averaging over a time interval, as permitted under section 5.4(d), the attenuation required shall be 30 dB instead of 20 dB. Attenuation below the general field strength limits specified in RSS-Gen is not required.

7.2 TEST PROCEDURE

- a. The EUT was directly connected to the spectrum analyzer and antenna output port as show in the block diagram below.
- b. Spectrum Setting : RBW= 100 kHz, VBW=300 kHz, Sweep time = Auto.

7.3 MEASUREMENT INSTRUMENTS LIST

Item	Kind of Equipment	Manufacturer	Type No.	Serial No.	Calibrated until
1	Spectrum analyzer	KEYSIGHT	N9010A	MY55150427	2021/05/24
2	Attenuator	Mini-Circuits	BW-S10W2	101109	N/A
3	RF Cable	Mi-cable	C10-01-01-1	100309	N/A

7.4 TEST SETUP



7.5 EUT OPERATION CONDITIONS

The EUT tested system was configured as the statements of 4.5 unless otherwise a special operating condition is specified in the follows during the testing.

7.6 TEST RESULTS

TX Mode_1Mbps

Bandedge- CH00 (Lower)

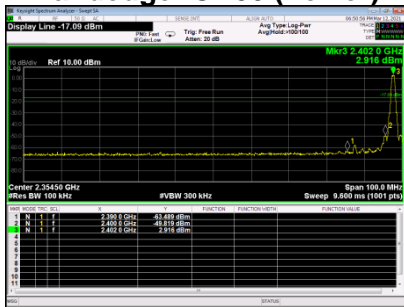

Bandedge CH39 (Upper)

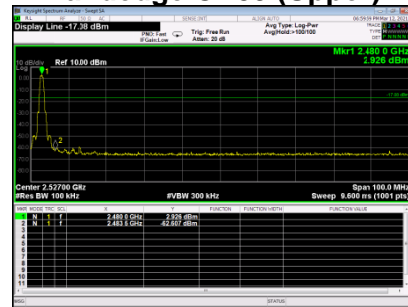

CH00 – 10th Harmonic of the fundamental frequency

2402MHz

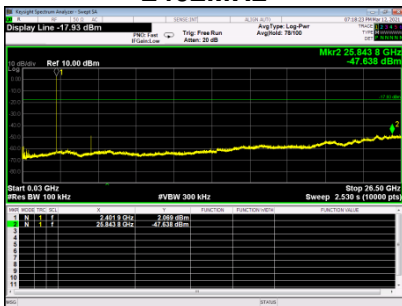

2440MHz

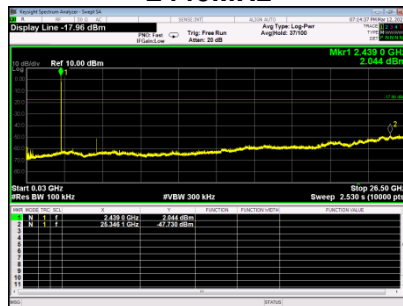

2480MHz

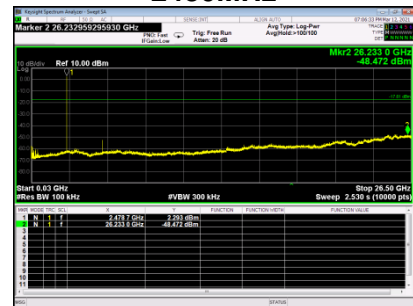

TX Mode_2Mbps

Bandedge- CH00 (Lower)

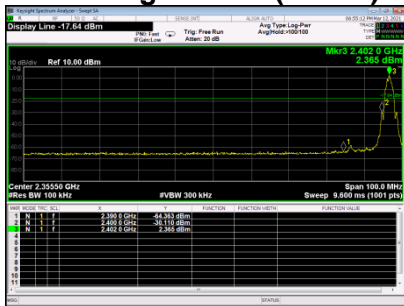

Bandedge CH39 (Upper)

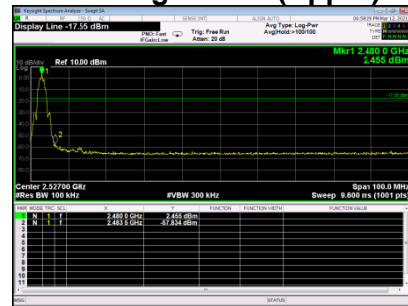

CH00 – 10th Harmonic of the fundamental frequency

2402MHz

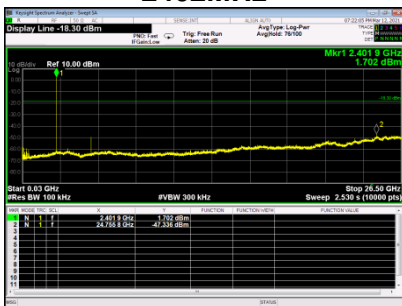

2440MHz



2480MHz

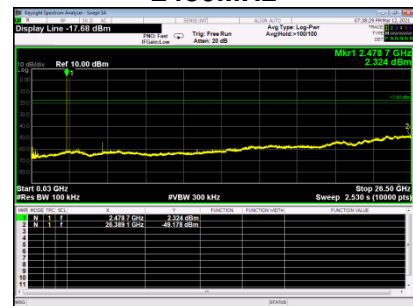

8 POWER SPECTRAL DENSITY TEST

8.1 LIMIT

FCC Part15, Subpart C (15.247)&RSS-247		
Section	Test Item	Limit
15.247(e) RSS-2475.2 (b)	Power Spectral Density	8 dBm (in any 3 kHz)

8.2 TEST PROCEDURE

- a. The EUT was directly connected to the spectrum analyzer and antenna output port as show in the block diagram below.
- b. Spectrum Setting: RBW=3 kHz, VBW=10kHz, Sweep time = auto.

8.3 MEASUREMENT INSTRUMENTS LIST

Item	Kind of Equipment	Manufacturer	Type No.	Serial No.	Calibrated until
1	Spectrum analyzer	KEYSIGHT	N9010A	MY55150427	2021/05/24
2	Attenuator	Mini-Circuits	BW-S10W2	101109	N/A
3	RF Cable	Mi-cable	C10-01-01-1	100309	N/A

8.4 TEST SETUP

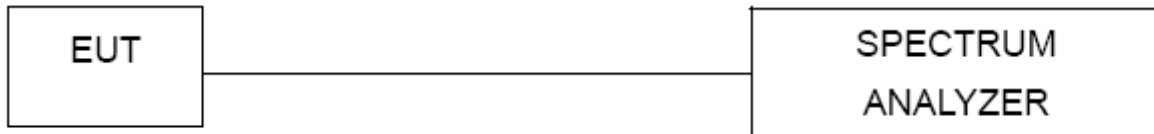

8.5 EUT OPERATION CONDITIONS

The EUT tested system was configured as the statements of 3.5 unless otherwise a special operating condition is specified in the follows during the testing.

8.6 TEST RESULTS

TX Mode_1Mbps				
Channel	Frequency (MHz)	Power SpectralDensity (dBm/3 kHz)	Limit: <dBm/3KHz	Result
CH00	2402	-12.916	8	PASS
CH19	2440	-10.937	8	PASS
CH39	2480	-13.037	8	PASS

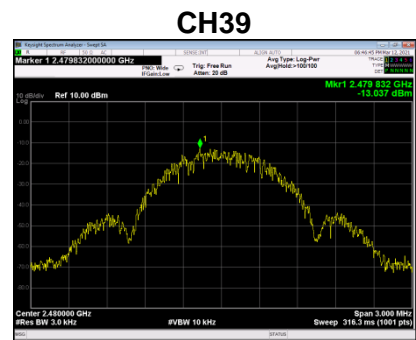
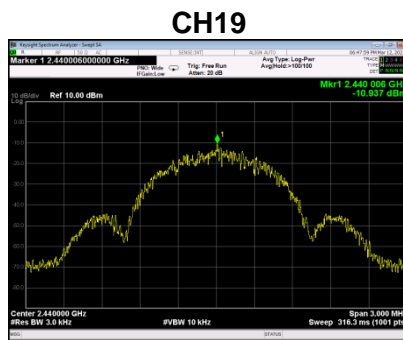
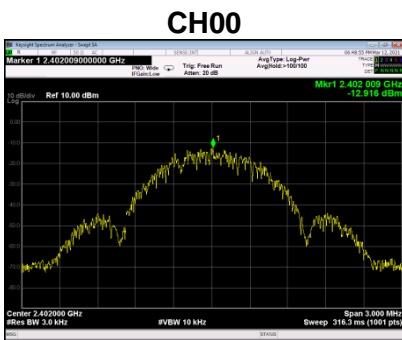

TX Mode_2Mbps				
Channel	Frequency (MHz)	Power SpectralDensity (dBm/3 kHz)	Limit: <dBm/3KHz	Result
CH00	2402	-13.374	8	PASS
CH19	2440	-14.077	8	PASS
CH39	2480	-14.727	8	PASS

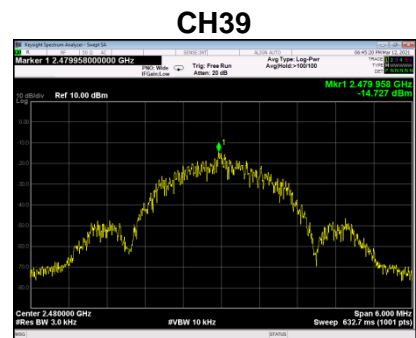
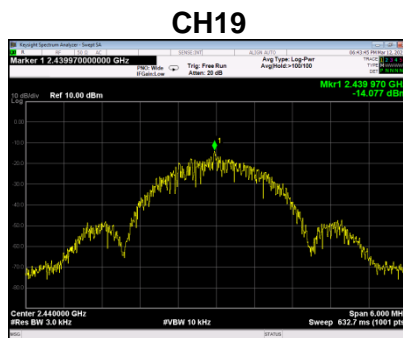
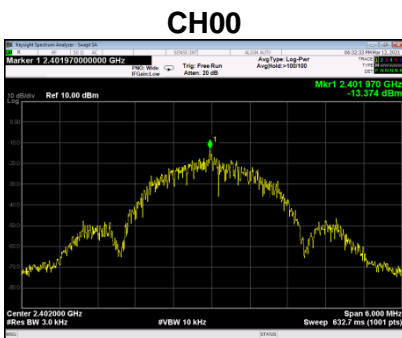

9 FREQUENCY STABILITY MEASUREMENT

9.1 LIMIT

RSS-Gen			
Section	Test Item	Limit	Frequency Range (MHz)
RSS-Gen 6.11	Frequency Stability	Specified in the user's manual	2402-2480

9.2 TEST PROCEDURE

- a. The EUT was directly connected to the spectrum analyzer and antenna output port as show in the block diagram below.
- b. Spectrum Setting:

Spectrum Parameter	Setting
Attenuation	Auto
Span Frequency	Entire absence of modulationemissionsbandwidth
RBW	10 kHz
VBW	10kHz
Sweep Time	Auto

9.3 MEASUREMENT INSTRUMENTS LIST

Item	Kind of Equipment	Manufacturer	Type No.	Serial No.	Calibrated until
1	Spectrum analyzer	KEYSIGHT	N9010A	MY55150427	2021/05/24
2	Attenuator	Mini-Circuits	BW-S10W2	101109	N/A
3	RF Cable	Mi-cable	C10-01-01-1	100309	N/A
4	Temperature conditioning	Guan Jian.HTH1000	-20-130°C	GJ1000-10D001	N/A
5	DC Power Supply	G.KE	IPR-10010D	010931954	N/A

9.4 TEST SETUP

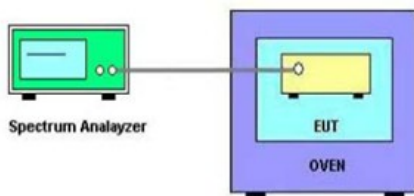

9.5 EUT OPERATION CONDITIONS

The EUT was programmed to be in continuously transmitting mode.

9.6 TEST RESULTS

	Temperature vs. Frequency Stability	
Voltage	Temperature	Measurement Frequency (MHz)
3V	(°C)	2402
	-20	2401.990
	25	2401.990
	50	2401.990
2.1V	25	2401.990
Max. Deviation (MHz)		-0.010
Max. Deviation (ppm)		-4.16

Note: 2.1V is the end point voltage, and products below 2.1V will cease working.

END OF TEST REPORT