



# KILO<sup>®</sup>

KILO3000BDX™ 10x42 mm RANGEFINDING BINOCULAR  
WITH BALLISTIC DATA XCHANGE™

OWNERS MANUAL



**SIG SAUER<sup>®</sup>**

## TABLE OF CONTENTS

Introduction . . . . .	3
Contents . . . . .	4
Key Features . . . . .	5
Product Identification . . . . .	6
Operation . . . . .	18
Display Information . . . . .	24
Changing Modes of Operation . . . . .	25
Programming Sequence . . . . .	26
Frequently Asked Questions (FAQs) . . . . .	43
Specifications . . . . .	46
SIG SAUER® Electro-Optics Infinite Guarantee™ . . . . .	53

This manual is available in the following languages: French, Spanish, German, Italian, Portuguese, Russian, Afrikaans, Swedish, and Norwegian. Please visit [sigsauer.com](http://sigsauer.com) for Owners Manual downloads , or download to your Smart device with the SIG BDX App.

## INTRODUCTION

Congratulations on the purchase of your SIG SAUER® Laser Rangefinder. The KILO3000BDX™ is part of a new, advanced family of rangefinders from SIG SAUER that feature Low Energy Bluetooth, embedded Applied Ballistics Ultralight and supports Applied Ballistics External with the free downloadable SIG™ BDX App as part of SIG SAUER's new Ballistic Data Xchange™ technology.

Compact form  
factor

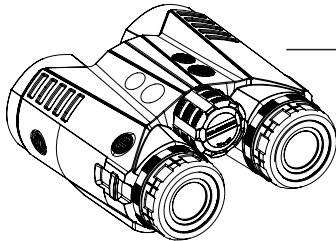

Scan mode refreshes at  
ultra-fast 4x/second

Twist eyecups for individualized,  
custom fit

**CONTENTS:**

- KILO3000BDX™ Rangefinding Binocular
- CR2 Battery (1)
- Premium Binocular Harness / Carry Pouch
- Quick Start Guide

## KEY FEATURES:

- SIG SAUER'S Patent Pending Ballistic Data Xchange™ Technology utilizes low energy Bluetooth with embedded Applied Ballistics Ultralight (ABU), supports Applied Ballistics External (ABE/ABX) and works with the free BDX™ App to sync custom gun profiles and environmental conditions to your KILO® and pair your KILO to any BDX enabled riflescope. ABU provides ballistic solutions out to 800 yards while ABE/ABX supports any distance and works with external devices with AB Elite.
- 10x42 mm monocular with SpectraCoat™ anti-reflection coatings for superior light transmission and optical clarity.
- Revolutionary Lightwave™ DSP Technology for the fastest and longest distance rangefinder engine.
- HyperScan provides 4 range updates per second in scan mode while RangeLock reports the last range result when ranging distant targets.
- Features line of sight or angle modified range. Units in yards or meters to tenth Y/M resolution.
- Projected, segmented OLED display for daytime and low light use.
- Lumatic™ Display automatically calibrates display brightness to changing ambient light conditions.
- Compact, aluminum housing and eyecups with dual diopter adjustment.
- Rangefinder configuration can now be done through the free SIG BDX™ App.
- Displays windage and elevation within KILO HUD for every target that is scanned

**PRODUCT IDENTIFICATION:**

A - Power/Range Button

B - Eyecup / Diopter Focus Adjustment

C - Mode Button

D - Harness Attachment Point

E - Battery Compartment

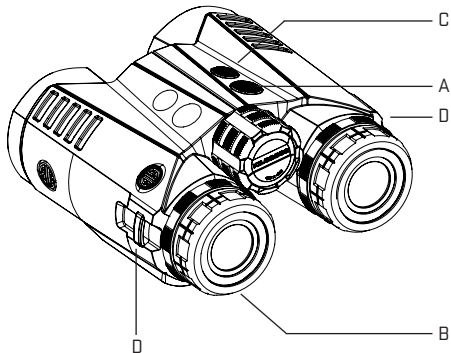
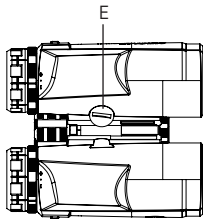

## LIGHTWAVE™ DSP TECHNOLOGY

SIG SAUER's proprietary Lightwave DSP engine leverages HyperScan – an advanced power management technique that provides the fastest refresh rate in scan mode (4 times per second) even at distances up to a mile. Our DSP engine uses the latest generation field programmable gate array (FPGA) running sophisticated signal processing algorithms to reduce false positives while finding weak or distant targets.

## RANGING ACCURACY, RESOLUTION AND MAXIMUM RANGES

The KILO3000BDX™ provides line of sight or angle modified range information accurate to  $\pm 0.5$  yards or meters out to 500 yards;  $\pm 1$  yard from 500 - 1000 yards and  $\pm 2$  yards beyond 1000 yards. Range is displayed in 0.1 yard or meter resolution.

RANGING PERFORMANCE IN HYPERSCAN MODE			
	Reflective	Trees	Deer
KILO3000BDX™	Up to 5,000 yds	Up to 2,000 yds	Up to 1,500 yds

## **SIG SAUER BALLISTIC DATA XCHANGE (BDX)**

SIG SAUER's Patent Pending BDX system takes the guesswork out of determining the proper range and ballistics solution for hitting your target with the first round. Low Energy Bluetooth combined with an embedded ballistic calculator (Applied Ballistics Ultralight) allows the user to configure up to 25 bullet profiles on the free BDX App and sync to your KILO. Line of sight range, elevation and wind hold information is calculated instantly and displayed based on the active profile. When combined with one of SIG SAUER's BDX enabled riflescopes, the user ranges a target and the firing solution is instantly shared with the BDX rifle scope where the holdover dot is selectively illuminated.

BDX also works with external devices such as the Kestrel 5700 and Garmin Foretrex with AB Elite on board. When the KILO is paired with a Kestrel or Foretrex, complete ballistic solutions will be transmitted back to the KILO and linked to any BDX enabled rifle scope for holdover solutions out to any distance.



## GENERAL OPERATION

Your rangefinder provides 4 modes of operation: AMR, LOS, ABU and ABE/ABX. AMR and LOS will be explained on the next page. When ABU is selected the user can pair the KILO with a nearby smartphone where the BDX App should already be installed. The user configures a bullet profile in the app, which is actively synced with a paired rangefinder. For example, the user downloads and installs the BDX App, selects a 0.308 caliber bullet and chooses a Barnes LRXBT 200 gr bullet – this profile is selected and saved in real-time. The user will then configure the muzzle velocity, zero range, temperature and altitude within the BDX App.

Applied Ballistics External (ABE/ABX) allows the KILO to be paired with an external Kestrel Elite or Garmin Foretrex for more precise ballistic solutions beyond 800 yds. AB Elite includes support for Coriolis, spin drift and other factors while providing custom drag curves for the most accurate ballistic solutions in the industry.

## **APPLIED BALLISTICS ULTRALIGHT (ABU)**

Your rangefinder has an embedded ballistics solver developed by Sig Sauer, Applied Ballistics and nVisti. By pairing your KILO with the free BDX App you can enter custom ballistics information for up to 25 bullet profiles and sync one at a time to your KILO. The active ballistic profile is now saved on your KILO, and when in ABU mode, will provide an accurate ballistic solution out to 800 yards maximum. The LOS range and angle of incline will be displayed for 2 seconds, then the elevation holdover value and finally the windage hold. This range and holdover information will continue to be displayed for 30 seconds or longer depending upon the timeout setting in the BDX App.

Wind direction and wind speed can also be configured within the App. The smartphone will actively sync all inputs with the KILO, and the KILO can then be used without a smartphone. BDX with ABU provides a firing solution out to a maximum of 800 yards. For users that require more precision or will be shooting further than 800 yards, the KILO3000BDX also support AB External which allows you to pair with an external device such as the Kestrel Elite. When in ABU or ABE/ABX mode, paired and bonded with a BDX enabled sight the Bluetooth icon will be visible and will flash when a new ballistic solution is calculated – which confirms your BDX enabled sight received the new holdover information.

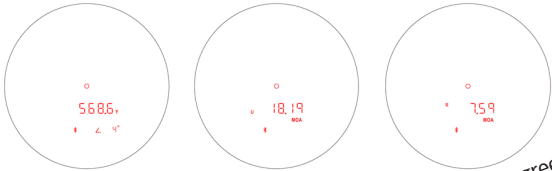

Line of Sight (LOS) range of 568.6 yards at 4 degrees incline



Example: LOS range = 568.6 yards with 0.308 Barnes  
Elevation adjustment = 18.19 MOA Up  
Windage adjustment = 7.59 MOA Right

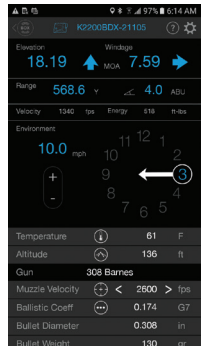

## **APPLIED BALLISTICS EXTERNAL (ABE/ABX)**

For long distance / precision shooters your KILO supports Applied Ballistics External. ABE/ABX allows the KILO to be paired with an external device with embedded Applied Ballistics Elite. This includes products such as the Kestrel 5700 Elite and Garmin Foretrex 701. ABE/ABX is compatible with SIG SAUER's BDX system in that ballistic solutions can be passed on to BDX enabled sights such as the SIERRA3 family of riflescopes.

ABE/ABX works by pairing the Kestrel or Foretrex to the KILO. While actively paired, the KILO sends the Line of Sight range and angle of incline / decline to the external device. The external device then samples the local environmental conditions such as wind speed, wind direction, temperature, pressure and humidity and calculates a complete ballistic solution based on the custom bullet profile selected in the external device. This precise ballistic solution is then passed back to the KILO and displayed on the internal OLED display. The firing solution is also passed along to any actively paired and bonded BDX enabled sights.

The advantage of ABE/ABX is that it provides a complete ballistic solution taking into account wind and other environmental conditions, as well as Coriolis and spin drift and pulls from the AB Custom Drag Curve database.

## **MODES OF OPERATION - ANGLE MODIFIED RANGE (AMR) AND LINE OF SIGHT (LOS)**

Angle modified range is the equivalent horizontal range to the target and is comparable to the “horizontal leg” of a triangle. AMR is also known as “rifleman’s rule” and uses the LOS range and angle of incline to calculate the horizontal distance the projectile travels between shooter and target. AMR is very accurate for shorter distances (i.e. < 400 yards) and archery.

Line of sight is the range to the target independent of angle. It is comparable to the “hypotenuse” of a triangle. When ranging in LOS mode, the distance is displayed in addition to the angle of incline. This method is preferred for those long range shooters and hunters wanting to use the LOS range and angle of incline to calculate a very precise holdover using a ballistic calculator smartphone application and/or wind measurement device.

For example, if the rangefinder is in LOS mode the line of sight range of 500 yards would be displayed along with the angle of -30 (degrees decline). Use LOS in combination with a ballistic calculator to calculate an exact holdover in minutes of angle or milliradians.

If the rangefinder is in AMR mode the angle modified range of 433.0 yards would be displayed. This is the equivalent horizontal range and can be used in combination with a ballistic / holdover reticle or with the SIG Ballistic Turret SBT™ dial.

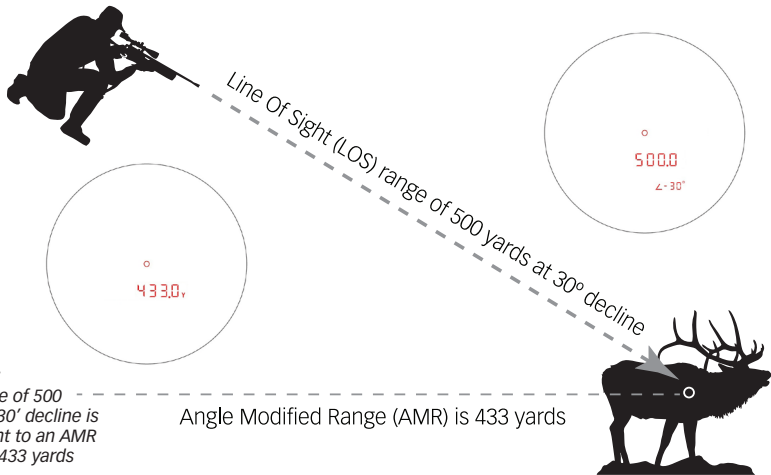

*Example:  
LOS range of 500  
yards at 30' decline is  
equivalent to an AMR  
range of 433 yards*

Angle Modified Range (AMR) is 433 yards

## LUMATIC™ OLED DISPLAY

The KILO3000BDX™ has the most advanced display on the market. Our OLED display has the largest dynamic range providing for high brightness in bright sunlight or snow conditions, yet will dim down to near night vision levels at dusk and dawn. No other display offers this adaptive ability to prevent your pupil from constricting in low light causing you to no longer be able to see your target. A small, ambient light sensor (ALS) is located in the objective of the rangefinder and samples the ambient light condition of the target image. The ALS samples and updates the brightness instantaneously to always provide the right amount of contrast against your target image.



*Display in Bright Light*



*Display in Dark Light*

## PROJECTED, SEGMENTED ORGANIC LIGHT EMITTING DIODE (OLED) DISPLAY

- A – Circle center aiming feature
- B – 5 Character alphanumeric displays
- C – Range unit of measure
- D – Holdover unit of measure
- E – Angle of incline / decline or holdover value
- F – Ranging mode (AMR or LOS)
- G – Battery status indicator
- H – Bluetooth indicator
- I – Target mode (BEST or LAST)
- J – Elevation hold and wind directional indicator
- K – BDX mode indicator (ABU or ABX )

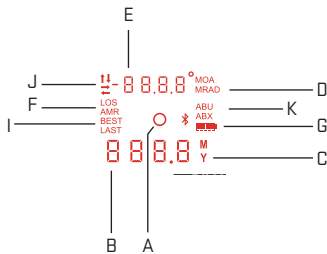



 **WARNING****SAFETY AND OPERATION PROCEDURES**

The KILO is classified as a Class 1M product.

- Do not press the RANGE button while aiming at the human eye or while looking into the transmitting optics on the objective side.
- Do not leave the KILO within reach of small children.
- Do not take the product apart or modify the product in any way to expose internal electronics that might cause damage or electric shock.
- Do not use any other power source other than a CR2 battery or equivalent.

## OPERATION

The KILO3000BDX is designed to get you up and running without the typical complexity of buried menus and programming modes. The binocular comes out of box in the following configuration and can also be configured with the free BDX App:

- (a) Angle Modified Range (equivalent horizontal range)
- (b) Best Target (rangefinder returns the best or most likely target, not the first or last)
- (c) Illumination control (AUTO)
- (d) Aiming Circle
- (e) Units of Measure in Yards

## SET UP

### Installing the Battery

Remove the battery cap by turning the cap in a counter-clockwise direction. Insert (1) CR2 Primary Lithium battery positive side first. The (-) terminal should be facing out. Place the cap onto the (-) battery terminal and reinstall the battery cap by turning the cap in the clockwise direction.

**⚠ CAUTION** - Be careful to not cross-thread the cap.

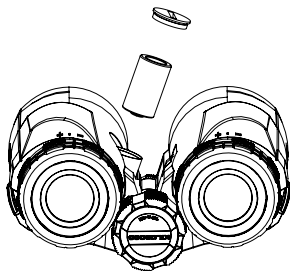

After installation of the battery and depressing the RANGE button, the status of the rangefinder is displayed:

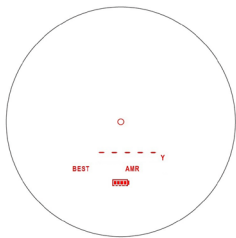

## ATTACHING THE HARNESS

Attach the harness to the binocular by taking the small connector straps and looping them through the attachment points on both sides of the binocular. Next connect the shoulder straps to the upper buckles on the binocular pouch and place over your head. Connect the lower back straps to the lower buckles on the binocular pouch and adjust straps to a comfortable fit.

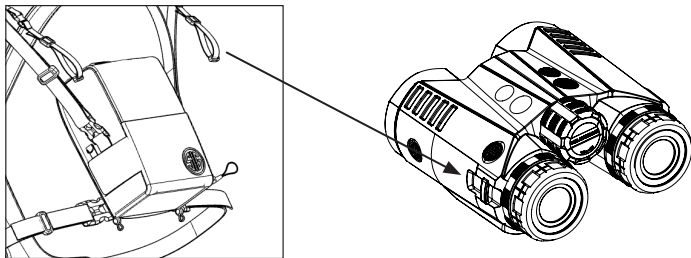

## DIOPTER ADJUSTMENT

The KILO3000 features two diopter adjustments. One for the internal OLED display (right) and one for distant targets (left). Press the RANGE button to turn on the bino - the display should be visible in the right channel. Closing your left eye and adjust the diopter on the right channel to focus the display. Next, locate a distant target with your binocular using the center focus knob to bring the target image into focus using your right eye. Now, while viewing the same distant target while the OLED display is in focus, open your left eye and adjust the left diopter adjustment to bring the target image into focus with your right eye. While adjusting either diopter adjustments you should use the same distant target for adjustment and should avoid adjusting the center focus wheel.

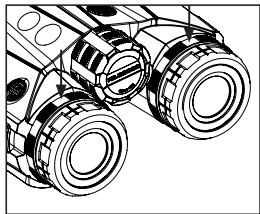

## EYECUP ADJUSTMENT

The KIL03000 features dual eyecups with 3 position detents for individual adjustment. Each eyecup rotates approximately 90 degrees counter clockwise for three different adjustment heights. For users with glasses, the cups will usually remain fully bottomed out. For users without eyeglasses or to minimize glare adjust the eyecups for best image and eye relief by rotating the cups counter clockwise to one of the three positions

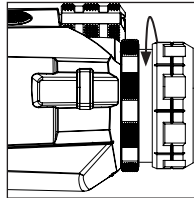
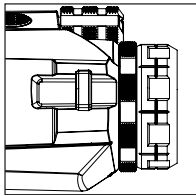

## DISPLAY INFORMATION

The display shows you the center aiming circle, the unit of measure (Y), Angle Modified Range mode (AMR) and the remaining battery status. The display will remain active for up to 30 seconds or whatever timeout has been set within in the SIG BDX App. You can then press the RANGE button to determine range to target.

If you press the RANGE button while the rangefinder is off and continue to hold the RANGE button down, the rangefinder will automatically switch into SCAN mode within 1 second.

After determining the distance to the target, the rangefinder will continue to display the center aiming circle and range data for 30 seconds – and only the range data. All other information is not shown after initial wakeup to prevent clutter in the field of view.

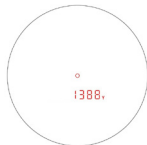

**Display when ranging**

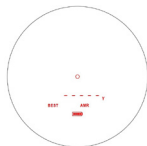

**Display at initial wakeup**



## **HYPERSCAN MODE**

While the rangefinders support single button push ranging operation, it is highly recommended that you push and hold the RANGE button down to activate HyperScan mode. This mode allows you to scan targets at 4X/second which significantly improves ranging performance at extreme distances. As the ranging distances are updated very quickly in HyperScan mode, once you release the RANGE button the last acquired distance will be displayed. When in HyperScan mode ranging distant targets, the display may update between no result and a distant range - by using RangeLock technology the rangefinder will report the last range result when the RANGE button is released.

## **CHANGING MODES OF OPERATION**

The rangefinder ships with the most common modes already configured. However, you can access and change the following features:

- Line of Sight (LOS), Angle Modified Range (AMR), Applied Ballistics Ultralight (ABU) or ABE/ABX
- Best or Last Target
- Display Brightness (AUTO + 3 Low, 3 Medium and 3 High)
- Units of Measure (Y or M)

## RANGEFINDER CONFIGURATION – PROGRAMMING SEQUENCE

**Note – the rangefinder can more easily be programmed and configured by using the free Sig BDX App.**

### **1. Mode Selection (AMR, LOS, ABU or ABE/ABX)**

To enter programming mode, press and release the RANGE button to wakeup the rangefinder. Once the display is visible, press and hold the MODE button for 2 seconds – then release the MODE button and the current selection will be flashing (AMR is the default setting). You can switch between AMR, LOS, ABU or ABE/ABX by pressing and releasing the RANGE button. Confirm your selection by pressing and releasing the MODE button which will save your setting and index to the next setting for configuration. If you do not press and release the MODE button the rangefinder will save your selection and turn off. If the user intends to use a calculated ballistic solution, the rangefinder must be in ABU or ABE/ABX mode. Instructions for downloading and configuring the BDX App on your smartphone will be detailed later in the instructions.

## 2. Target Selection (BEST or LAST)

BEST or LAST should be flashing (BEST is the default setting). You can toggle between BEST or LAST by pressing and releasing the RANGE button. Confirm your selection by pressing and releasing the MODE button which will save your setting and index to the next setting for configuration. If you do not press and release the MODE button the rangefinder will save your selection and turn off. BEST Target can be used for most situations, however, when hunting through foliage or in high grass the LAST Target is recommended.

## 3. Display Brightness

Display Brightness (Lumatic OLED Display) – AUTO will be used in most cases which leverages the ambient light sensor located in the objective of the rangefinder. This sensor samples the ambient light conditions and automatically adjusts the display to the local environment. You can change this to 9 individual settings: LOW 1 – 3, MED 1-3 and HI 1-3. Note – if you accidentally leave the unit on Setting LOW 1 you may not be able to see the display. If this occurs, go into a dark environment and change the illumination setting.

#### **4. Unit of Measure Selection (Y or M)**

Your current selection will be flashing (Yards is default). You can toggle between Y or M by pressing and releasing the RANGE button. Confirm your selection by pressing and releasing the MODE button which will save your setting and index to the next setting for configuration. If you do not press and release the MODE button the rangefinder will save your selection and turn off.

## BALLISTICS DATA XCHANGE – DOWNLOADING AND CONFIGURING THE FREE BDX APP

In this section you will download the BDX App, pair the App with your KILO and create a custom bullet profile.

### 1. Turn Bluetooth on

Check in Settings on your Android or iOS device to make sure that Bluetooth is on. If Bluetooth is off, switch it on.

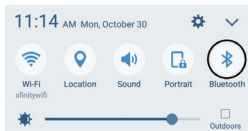
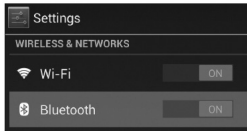

## 2. Download the BDX App from the App Store / Google Play Store

Go to the App Store or the Google Play store and download the SIG SAUER BDX App. Search for the word SIG SAUER or BDX.

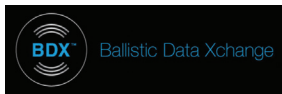

### 3. Launch the free SIG SAUER BDX App and Pair with your KILO (Enter your PIN code)

On your smartphone, open the BDX App, click on PAIRING, turn on your KILO by pressing and releasing the RANGE button and then press "Scan for Devices" on the App. Your KILO should be listed below the KILO icon and "Select Device". Your rangefinder ID should be listed in white letters. Touch the ID in white. (continued on next page)

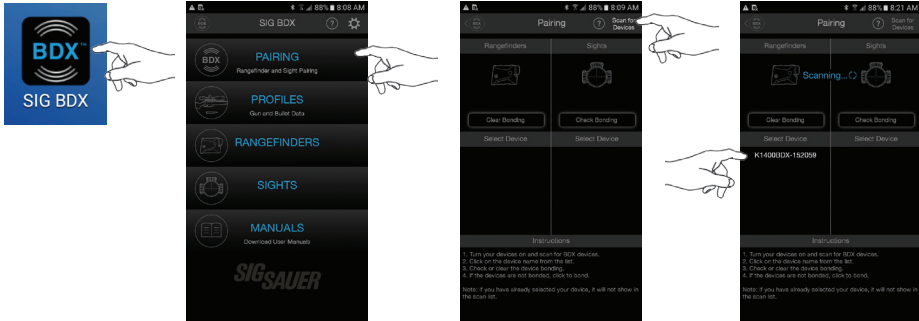

Make sure your KILO stays on during the pairing process by periodically pressing and releasing the RANGE button. You will be prompted to look through your KILO for a PIN number. Type this PIN number into the open dialogue box within the App. The PIN in your KILO and the PIN entered on your smartphone must match. Press OK to complete the pairing operation. You will now see your KILO ID in blue listed below the KILO icon. You can now exit this screen. If you enter the incorrect PIN code you can restart this process over again. If you encounter any problems during this process close your App and let the KILO time out; restart the process over.

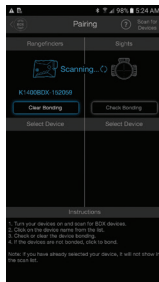
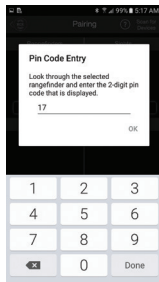
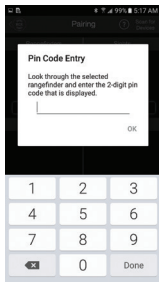



### 3a. Updating your KILO to the latest software during Pairing

You may be prompted to update the software on your KILO. These software updates are mandatory and allow Sig Sauer to ensure that your BDX App and KILO perform optimally. Most updates take less than 1 minute. Ensure that your KILO is turned on and that your smartphone has at least 25% battery life remaining before installing any software updates. For best operation be sure to keep your smartphone awake during the entire installation process.

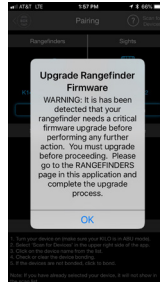
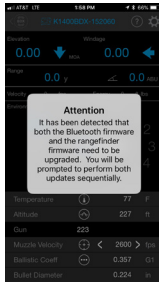

## 4. Configure up to 25 custom bullet profiles

The BDX App allows you to create and modify up to 25 profiles. From the home screen of the App touch PROFILES. Only one profile can be active at any time and is denoted by the BDX Icon in blue to the right of the screen. The BDX App comes with one default 0.308 profile. You can edit this profile by touching "Profile 1" or create a new one by touching the "New Profile" in the upper right corner of the App. Next, touch LIBRARY then select a caliber and bullet manufacturer. On the Gun Profiles page you can rename the profile by touching on the "Custom Gun 1" and typing in a new name.

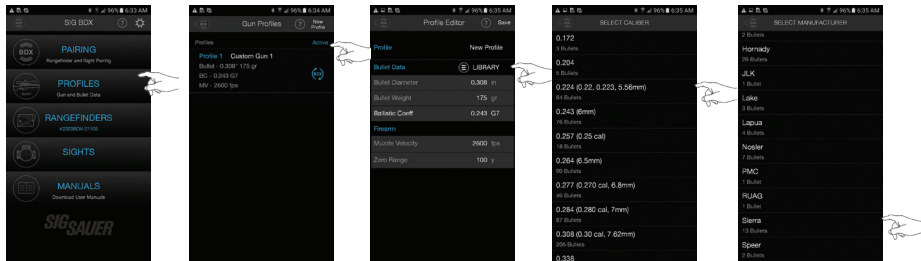

After selecting a bullet manufacturer, select the actual bullet you intend to use. Once selected you will return to the Gun Profile page where you will need to click on the sync icon to the right to activate this profile. In this example the new profile is called ".223 Sierra" – be sure to activate this profile.

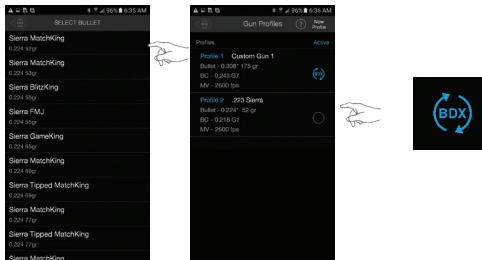

## RANGEFINDER HEADS-UP DISPLAY (HUD)

From the home screen of your BDX App select RANGEFINDERS to display the HUD. The HUD displays all range, environmental and ballistic information and allows you to configure your KILO.

### KILO ID and Status

Grey = disconnected / Blue = connected

<i>Back to Home Screen</i>		<i>Help and Settings menu</i>
<i>Elevation data</i>		<i>Windage data</i>
<i>Range to target and unit of measure</i>		<i>Angle of include and Mode of Operation</i>
<i>Bullet velocity at target range</i>		<i>Bullet energy at target range</i>
<i>Wind speed</i>		<i>Wind direction</i>
<i>Ambient temperature</i>		<i>Local altitude</i>
<i>Active gun profile</i>		<i>Muzzle velocity and MV Calibration</i>
<i>Ballistic coefficient</i>		<i>Bullet diameter</i>
<i>Bullet weight</i>		

## KILO SETTINGS

From the Settings menu you can fully configure the following:

1. Mode of Operation (LOS, AMR, ABU or ABE/ABX)
2. Target Mode (BEST or LAST)
3. Unit of Measure (Yards or Meters)
4. Sleep Timeout (30, 60, 120 or 180 seconds)
5. Holdover / Sight unit of Measure (MOA or MILS)

You can toggle all fields by simply touching the letters in white. Your KILO must be turned on and paired. To save your settings touch the BDX icon in the upper left corner of the display. This will save your settings. You can also access the help menu by clicking on the “?” icon in the upper right of the screen.

Note – The KILO will not range when the Settings menu is open and active.

Note – The rangefinder must be in ABU mode to calculate Real time ballistic solutions and send them to the SIG BDX Riflescope with Bluetooth.

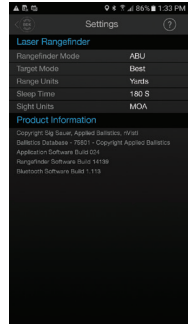

## TEMPERATURE AND ALTITUDE

Once your KILO is paired and actively synced with your smartphone, when you enter the RANGEFINDER HUD screen your smartphone will automatically pull the local temperature and altitude from the closest weather station. If you are not in cell range you can manually update both temperature and altitude by touching on the white numbers in each field and manually updating these environmental conditions.

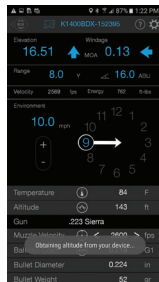
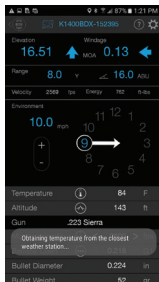

## MUZZLE VELOCITY (MV) CALIBRATION

The most important input for calculating accurate Applied Ballistics solutions is getting your MV correct. You need to either chronograph your firearm or use the embedded MV Calibration routine built into the BDX App. To use the MV Calibration routine make sure your scope is zeroed (i.e. at 100 yards) and verify that the BDX App is showing zero holdover values at the zero distance by ranging the target at the zero range and verifying the your holds are in fact zero

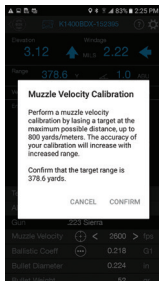
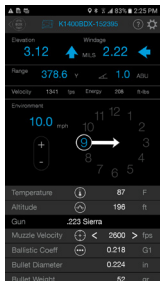

Use the MV Calibration routine at the farthest distance you intend to shoot. The greater the distance the more accurate the MV calculation will be. In this example the target was at 378 yards. Confirm your max target range.

Note – ABU only provides ballistic solutions out to 800 yards maximum.

## MUZZLE VELOCITY (MV) CALIBRATION (continued)

Now enter the elevation offset between point of impact and point of aim and select CONFIRM. In this example the 3 shot group was 7 inches low. A new MV of 2477 fps was calculated. Select YES to confirm and this MV will now be used for ballistic solutions going forward. See the confirmation dialogue box in the image below right.

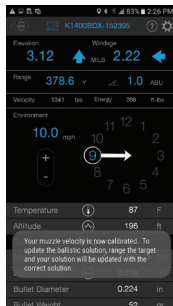
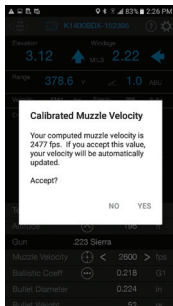
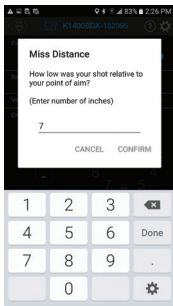



## CONFIGURING GLOBAL SETTINGS IN THE BDX APP

From the Home Screen of the BDX App you can configure Global Settings. Any field that is in white can be changed by touching on the unit of measure and toggling between values. The help menu is available to assist you. Global Settings include:

1. Range Unit (Y, M)
2. Wind Speed Unit (mph, m/s, kph)
3. Muzzle Velocity Unit (fps, m/s)
4. Bullet Diameter Unit (inches, cm)
5. Bullet Weight Unit (grains, grams)
6. Temperature Units (F / C)
7. Altitude Units (feet, meters)
8. Sight Units (MOA, MILS)
9. Clear Saved Device List

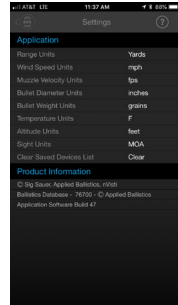
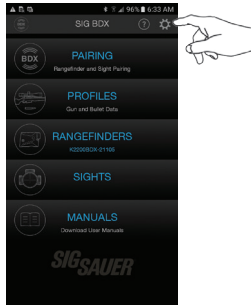

## PAIRING A KESTREL 5700 ELITE WITH THE KILO3000BDX

Using the RANGE / MODE buttons or the BDX App, put the KILO in ABE/ABX mode. This allows the KILO to be seen by the Kestrel. ABE will be displayed in the KILO. AB External will be displayed in the App. Close the BDX App.

Next, turn on your Kestrel. Follow the instructions for the Kestrel to turn on the Bluetooth radio and connect devices to the Kestrel (<https://kestrelinstruments.com/support/manuals-and-downloads>). On the Kestrel, open the Options Menu and select BLUETOOTH, set BLUETOOTH ON. Next, set CONCT to DEVICE. Then, scroll down and select the KILO - the KILO must be turned on and in ABE/ABX mode. You should see K3000BDX-12345 listed on the Kestrel. Select and exit the menu.

Your Kestrel is now paired to your KILO. Note - the BDX App will no longer work properly when a Kestrel is actively paired to the KILO. However, if your KILO was previously paired and bonded with a SIERRA3 or other BDX enabled sight this link will be maintained.

When actively paired with the Kestrel you will now be able to range targets and receive accurate ballistic holdover solutions displayed on the Kestrel and within the KILO.

## FREQUENTLY ASKED QUESTIONS (FAQ):

**Q: I can't get the display to focus.**

A: You need to adjust the diopter ring to your vision. Rotate the eyecup / diopter ring in either direction until the display comes into sharp focus.

**Q: I can't seem to range very far past trees or animals.**

A: Your KILO will perform differently based on changes in ambient conditions such as bright sunlight or snow, rain or fog, temperature and the reflectivity of the target being ranged. For example, at dusk and dawn your rangefinder may be able to range trees at over 1000 yards but in bright sunlight may only achieve 500 yards. If your KILO will not range at least 400 yards under normal conditions (fog and rain excluded) please contact customer service. Your product may have fallen out of alignment.

**Q: I can't get my KILO to pair with the BDX App on my smartphone.**

A: Delete the BDX App from your smartphone. Download and reinstall on your phone. Make sure you have a fresh battery in your KILO. Relaunch the App, turn on your KILO and repeat the Pairing instructions in this manual.

**Q: I can't locate the BDX App on the Apple or Android Stores.**

A: Search for Sig Sauer or BDX at the store.

**Q: My battery drains too fast.**

A: Most rangefinders will provide over 4000 individual range calculations using a fresh CR2 primary lithium battery. Your KILO exceeds this specification. When heavily using SCAN mode the battery may appear to drain faster since your KILO is ranging 4x per second in HyperScan mode. This is normal operation but you should keep a spare CR2 battery when heading out to remote locations.

**Q: My ballistic solution in the HUD and displayed in the KILO is always off a few inches.**

A: For accurate ballistic solutions make sure you have updated the temperature and altitude within the App to your current location, you have the correct bullet caliber (diameter) and weight selected, your zero distance is correct and that your muzzle velocity is correct. Using the MV Calibration routine provides the most accurate MV and will improve the accuracy of the ballistic calculator. It is always best to use the MV Calibration routine at the farthest distance you intend to shoot. Calibrating at 500 yards will yield a better MV than calibrating at 200 yards.

**Q: My blue LED on the power selector ring on my SIERRA3 will not turn on.**

A: Look through your SIERRA3. You most likely have the Digital Ballistic Reticle turned ON. Go into your BDX App, select the SIGHTS page and turn the Ballistic Reticle OFF.

This product has been tested and found to comply with the limits for a Class B digital device, pursuant to Part 15 of the FCC Rules. The equipment generates, uses and can radiate radio frequency energy and,

---

**Q: When using AB External on my KILO I can no longer see the rangefinder information on the HUD in the BDX App.**

A: If your KILO and a Kestrel are actively paired (sending / receiving information) the BDX App cannot be connected and paired to your KILO at the same time.

**Q: My KILO is set to AB External but isn't displaying holdover information.**

A: To display a complete ballistic solution your KILO must be actively paired with a Kestrel. No holdover information is displayed unless the Kestrel and KILO are both on and actively paired.

**Q: The rangefinder HUD in the BDX App is sluggish when using my KILO in AB External mode (Kestrel is not paired to the KILO)**

A: AB External mode on your KILO was designed to be used directly with a Kestrel with AB Elite on board. This communications protocol is relatively slow and does not respond quickly as compared to using AB Ultralight. AB Ultralight resides on your KILO and is much faster for calculating ballistic solutions out to 800 yards.

**Q: My KILO and Kestrel are paired but I am not getting anything but zero's for elevation and wind holds.**

A: You need to setup at least one custom bullet profile on your Kestrel. See the Kestrel instructions for setting up a bullet profile.

## KILO3000BDX™ 10x42 mm SPECIFICATIONS

<b>Magnification</b>	10x		
<b>Objective Clear Aperture</b>	42 mm		
<b>Close Focus Distance</b>	20 ft		
<b>Eye Relief</b>	18 mm		
<b>Angular (FOV)</b>	6.1 degrees		
<b>FOV @ 1000yds</b>	320 ft		
<b>Laser Divergence</b>	1.5 x .06 MRAD		
<b>Range Response Time</b>	0.25 seconds		
<b>Scanning</b>	Yes		
<b>Range Resolution Under 100 yds</b>	.1 yds		
<b>Max Range (Class 1M)</b>	Reflective up to 5,000 yds	Trees up to 2,000 yds	Deer up to 1,500 yds
<b>Weight with Battery</b>	31 oz		

 **WARNING**



**WARNING:** CANCER AND REPRODUCTIVE HARM

[www.P65Warnings.ca.gov](http://www.P65Warnings.ca.gov)

A – 5 in / 127 mm  
B – 5.75 in / 146 mm  
C – 2.5 in / 63.5 mm

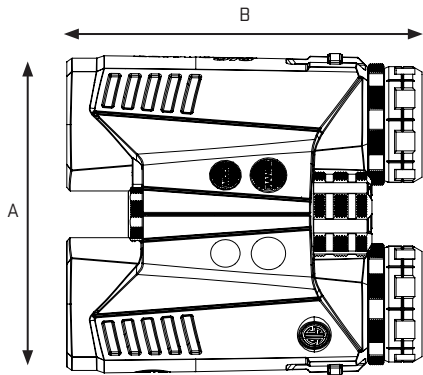
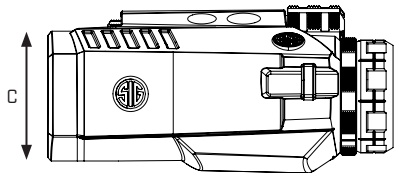



**! DANGER**

**CLASS 1M LASER PRODUCT. INVISIBLE LASER RADIATION. DO NOT VIEW DIRECTLY WITH OPTICAL INSTRUMENTS (BINOCULARS OR TELESCOPES).**

This product complies with IEC 60825-1: 2014-05 Ed 3.0 and complies with FDA performance standards for laser products except for deviations pursuant to Laser Notice No. 50, dated June 24, 2007.

FCC ID:2AP8SK301MR

IC:24032-K301MR

P p < 41.4W,  $\lambda = 905 \text{ nm}$ , t = 22 ns



if not installed and used in accordance with these instructions, may cause harmful interference to radio communications. However, there is no guarantee that interference will not occur in a particular installation. If this product does cause interference to radio or television reception the user is encouraged to try to correct the interference by one or more of the following

- Reorient or relocate the receiving antenna
- Increase the separation between this product and the receiver
- Connect the equipment to an alternative outlet or receiver
- Consult a technician.

Shielded interference cable must be used with the equipment in order to comply with the limits for a digital device pursuant to Subpart B of Part 15 of FCC Rules.

Specifications and designs are subject to change without any notice or obligation on the part of the manufacturer.

## CAUTION

Use of controls or adjustments or performance of procedures other than those specified herein may result in hazardous radiation exposure. Changes or modifications not expressly approved by the party responsible for compliance could void the user's authority to operate the equipment.



# LASER APERTURE

## FCC STATEMENT:

This device complies with Part 15 of the FCC rules.

Operation is subject to the following two conditions:

- This device may not cause harmful interference, and
- This device must accept any interference received, including interference that may cause undesired operation.

Changes or modifications not expressly approved by the party responsible for compliance could void your authority to operate the equipment.

### NOTE:

This equipment has been tested and found to comply with the limits for a Class B digital device, pursuant to Part 15

of the FCC Rules. These limits are designed to provide reasonable protection against harmful interference in a residential installation.

This equipment generates uses and can radiate radio frequency energy and, if not installed and used in accordance with the instructions, may cause harmful interference to radio communications. However, there is no guarantee that interference will not occur in a particular installation. If this equipment does cause harmful interference to radio or television reception, which can be determined by turning the equipment off and on, the user is encouraged to try to correct the interference by one or more of the following measures:

- Reorient or relocate the receiving antenna.
- Increase the separation between the equipment and receiver.

- Connect the equipment into an outlet on a circuit different from that to which the receiver is connected.
- Consult the dealer or an experienced radio/TV technician for help.

## **INDUSTRY CANADA:**

This device contains licence-exempt transmitter(s)/receiver(s) that comply with Innovation, Science and Economic Development Canada's licence-exempt RSS(s). Operation is subject to the following two conditions:

- This device may not cause interference, and
- This device must accept any interference, including interference that may cause undesired operation of the device.

Ce dispositif contient un (S) émetteur (S)/ récepteur (S) exempté (S) de licence L'innovation, la Science et l'économie RSS(S) exempté (S) de licence de développement Canada.L'exploitation est Sous réserve des deux conditions suivantes:

- l'appareil ne doit pas produire de brouillage, et
- l'utilisateur de l'appareil doit accepter tout brouillage radio électrique subi, même si le brouillage est susceptible d'empêcher le fonctionnement

The device meets the exemption from the routine evaluation limits in section 2.5 of RSS 102 and compliance with RSS-102 RF exposure, users can obtain Canadian information on RF exposure and compliance.



## **SIG SAUER Electro-Optics Infinite Guarantee™**

SIG SAUER has manufactured the most rugged, dependable high-performance firearms for over two centuries. Our heritage of design, engineering and precision-manufactured quality predates the existence of any other optics company worldwide. We understand the importance of quality in the line of fire, at the shooting range or on your next hunt. SIG SAUER Electro-Optics had to earn the right to wear that badge and the Infinite Guarantee has your back, forever. Period.

We will repair or replace your SIG SAUER product in the event it becomes damaged or defective, at no charge to you. If we cannot repair your product, we will replace it with a product in perfect working order of equal or better physical condition. It doesn't matter how it happened, whose fault it was, or where you purchased it.

### **SIG SAUER Infinite Guarantee™**

- Unlimited Lifetime Guarantee
- Fully Transferable
- No Warranty Card Required
- No Receipt Required
- No Time Limit Applies
- No Charge

If you ever have a problem, no matter the cause, we promise to take care of you when it counts. Please note that our Infinite Guarantee does not provide coverage for intentional damage, misuse, cosmetic damage that does not affect the performance of the optic, loss, theft or unauthorized repair or modification. Excludes electronic components.



### **SIG SAUER Electronic & Tritium Component Limited 5-Year Warranty**

For components not included under the SIG SAUER® Infinite Guarantee™, this warranty covers any defects in materials and workmanship in the electronic and Tritium components of illuminated riflescopes/sights, pistol sights, electronic sights, flashlights, lasers, binoculars, spotting scopes, and rangefinders. This warranty lasts for five years from the date of manufacture. If, during that five-year period, these products are found to have electronic or Tritium component defects in materials or workmanship, SIG SAUER will repair your product, at no charge to you. If we cannot repair your product, we will replace it with a product in perfect working order of equal or better physical condition.



**FOR PRODUCT SERVICE ON THIS MODEL, PLEASE CALL 603-610-3000**

27100 SW Parkway Avenue, Wilsonville, Oregon 97070 USA