

FCC CERTIFICATION TEST REPORT

For
FCC ID:2AP8SK301M
IC: 24032-K301M

Report Reference No.: 18EEAS11050 21
A2LA Cert. No: 4893.01
IC Registration Number.....: 11033A
Date of issue: 2018-12-20
Testing Laboratory: DongGuan ShuoXin Electronic Technology Co., Ltd.
Address: Zone A, 1F, No. 6, XinGang Road YuanGang Street, XinAn District, ChangAn Town, DongGuan City, Guangdong, China

Applicant's name.....: Sig Sauer, Inc.
Address.....: 27100 SW Parkway Avenue, Wilsonville, Oregon 97070, USA
Manufacturer.....: SINTAI OPTICAL (SHENZHEN) CO., LTD.

Test specification:

Test item description.....: Laser range finder
Trade Mark.....: N/A
Model/Type reference: KILO3000BDX
Ratings: I/P: DC 3V From Battery
O/P: --

Responsible Engineer :

Smile Wang

Authorized Signatory:



King Wang

TABLE OF CONTENTS

TEST REPORT DECLARE	3
1. Summary of test Standards and results.....	4
2. General test information	5
2.1. Accretations	5
2.2. Description of EUT	5
2.3. Accessories of EUT	6
2.4. Assistant equipment used for test	6
2.5. Block diagram of EUT configuration for test	6
2.6. Test environment conditions	6
2.7. Measurement uncertainty	7
3. 6dB Bandwidth and 99% Occupied Bandwidth	8
3.1. Test equipment.....	8
3.2. Block diagram of test setup	8
3.3. Limits.....	8
3.4. Test Procedure	8
3.5. Test Result	8
3.6. Original test data	9
4. Maximum Peak Output Power.....	11
4.1. Test equipment.....	11
4.2. Block diagram of test setup	11
4.3. Limits.....	11
4.4. Test Procedure	11
4.5. Test Result.....	11
4.6 Original test data	12
5. Power Spectral Density	14
5.1. Test equipment.....	14
5.2. Block diagram of test setup	14
5.3. Limits.....	14
5.4. Test Procedure	15
5.5. Test Result.....	15
5.6. Original test data	16
6. Spurious Emissions.....	18
6.1. Test equipment.....	18
6.2. Block diagram of test setup	18
6.3. Limit.....	20

6.4. Test Procedure	21
6.5. Test result.....	22
7. 100 kHz Bandwidth of Frequency Band Edge	35
7.1. Test equipment.....	35
7.2. Block diagram of test setup	35
7.3. Limit.....	35
7.4. Test Procedure	36
7.5. Test result.....	36
8. Antenna Requirements.....	41
8.1. Limit.....	41
8.2. Result.....	41

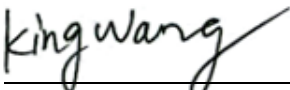
TEST REPORT DECLARE

Applicant	:	Sig Sauer, Inc
Address	:	27100 SW Parkway Avenue, Wilsonville, Oregon 97070, USA
Equipment under Test	:	Laser range finder
Test Model No	:	KILO3000BDX
Manufacturer	:	SINTAI OPTICAL (SHENZHEN) CO., LTD.
Address	:	Qiwei Ind Sec, 1st, 2nd, & 3rd Bldg. Li-Song-Lang Industrial Zone, Bao'an District, Gong-Ming Town, Shenzhen, Guangdong, P.R. China

Test Standard Used: FCC:FCC Rules and Regulations Part 15 Subpart C (15.247)

Test procedure used: ANSI C63.10:2013,KDB 558074 D01 15.247 Meas Guidance v05

We Declare:

The equipment described above is tested by DongGuan ShuoXin Electronic Technology Co., Ltd. and in the configuration tested the equipment complied with the standards specified above. The test results are contained in this test report and DongGuan ShuoXin Electronic Technology Co., Ltd. is assumed of full responsibility for the accuracy and completeness of these tests.

After test and evaluation, our opinion is that the equipment provided for test compliance with the requirement of the above FCC standards.

Report No:	18EEAS11050 21		
Date of Test:	2018-11-19 To 2018-12-17	Date of Report:	2018-12-20

Note: This report applies to above tested sample only. This report shall not be reproduced in parts without written approval of DongGuan ShuoXin Electronic Technology Co., Ltd.

1. SUMMARY OF TEST STANDARDS AND RESULTS

The EUT have been tested according to the applicable standards as referenced below.

Description of Test Item	Standard	Results
6dB Bandwidth and 99% Occupied Bandwidth	FCC:15.247(a)(2)	PASS
Peak Output Power	FCC:15.247(b)(3)	PASS
Power Spectral Density	FCC:15.247(e)	PASS
Spurious Emissions at Antenna Port	FCC:15.247(d)	PASS
Spurious Emissions	FCC:15.205,15.209,15.247(d)	PASS
100 kHz Bandwidth of Frequency Band Edge	FCC:15.247(d)	PASS
AC Line Conducted Emissions	FCC:15.207	N/A
Antenna requirement	FCC:15.203	PASS

2. GENERAL TEST INFORMATION

2.1. Accreditations

The measuring facility of laboratories has been authorized or registered by the following approval agencies.

A2LA Cert. No : 4893.01 and IC Registration Number: 11033A

2.2. Description of EUT

EUT* Name	:	Laser range finder
Model Number	:	KILO3000BDX
Trade Mark	:	N/A
EUT function description	:	Please reference user manual of this device
Power supply	:	DC 3V Battery
Radio Specification	:	BLE
Operation frequency	:	2402 MHz -2480MHz
Modulation	:	GFSK
Antenna Type	:	Ceramic Antenna, Maximum PK gain: 1 dBi
Date of Receipt	:	2018/11/19
Sample Type	:	Series production
Software version	:	30140
Hardware version	:	KILO3000DBX_10x42 Binocular_BT_V0_20180727

Note: EUT is the ab. of equipment under test.

Channle information:							
CH	Frequency	CH	Frequency	CH	Frequency	CH	Frequency
0	2402	10	2422	20	2442	30	2462
1	2404	11	2424	21	2444	31	2464
2	2406	12	2426	22	2446	32	2466
3	2408	13	2428	23	2448	33	2468
4	2410	14	2430	24	2450	34	2470
5	2412	15	2432	25	2452	35	2472
6	2414	16	2434	26	2454	36	2474
7	2416	17	2436	27	2456	37	2476
8	2418	18	2438	28	2458	38	2478
9	2420	19	2440	29	2460	39	2480

2.3. Accessories of EUT

Description of Accessories	Manufacturer	Model number or Type	Other
/	/	/	/

2.4. Assistant equipment used for test

Description of Assistant equipment	Manufacturer	Model number or Type	Other
Notebook	ACER	MS2367	32807810766

2.5. Block diagram of EUT configuration for test

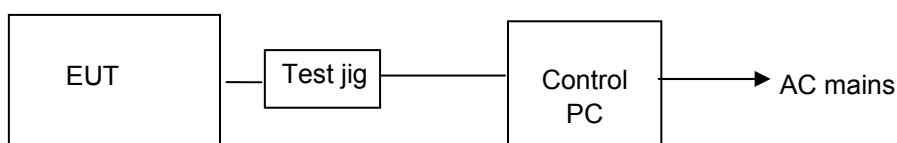

EUT was connected to control to a special test jig provided by manufacturer which has a USB connector to Notebook, and the Notebook will run a special test software to control EUT work in Continuous TX mode, and select test channel, wireless mode and data rate. New battery is used during all test. "BLE" provided by manufacturer to control EUT work in test mode as blow table.

Mode	Channel	Frequency (MHz)
BLE	Low :CH1	2402
	Middle: CH19	2440
	High: CH39	2480

2.6. Test environment conditions

During the measurement the environmental conditions were within the listed ranges:

Temperature range:	21-25°C
Humidity range:	40-75%
Pressure range:	86-106kPa

2.7. Measurement uncertainty

Test Item	Uncertainty
Uncertainty for Conduction emission test (9kHz-150kHz)	3.7 dB
Uncertainty for Conduction emission test (150kHz-30MHz)	3.3 dB
Uncertainty for Radiation Emission test (30MHz-200MHz)	4.60 dB (Polarize: V)
	4.60 dB (Polarize: H)
Uncertainty for Radiation Emission test (200MHz-1GHz)	6.10 dB (Polarize: V)
	5.08 dB (Polarize: H)
Uncertainty for Radiation Emission test (1GHz-6GHz)	5.01 dB (Polarize: V)
	5.01 dB (Polarize: H)
Uncertainty for Radiation Emission test (6GHz-18GHz)	5.26 dB (Polarize: V)
	5.26 dB (Polarize: H)
Uncertainty for Radiation Emission test (18GHz-40GHz)	5.06 dB (Polarize: V)
	5.06 dB (Polarize: H)
Uncertainty for radio frequency	$\pm 0.048\text{kHz}$
Uncertainty for conducted RF Power	$\pm 0.32\text{dB}$

Note: This uncertainty represents an expanded uncertainty expressed at approximately the 95% confidence level using a coverage factor of k=2.

3. 6DB BANDWIDTH AND 99% OCCUPIED BANDWIDTH

3.1. Test equipment

Item	Equipment	Manufacturer	Model No.	Serial No.	Cal Due.	Cal. Interval
1	Spectrum analyzer	KEYSIGHT	N9010A	MY55150427	2019/05/25	1 Year
2	Attenuator	Mini-Circuits	BW-S10W2	101109	2018/12/17	1 Year
3	RF Cable	Micable	C10-01-01-1	100309	2018/12/17	1 Year

3.2. Block diagram of test setup

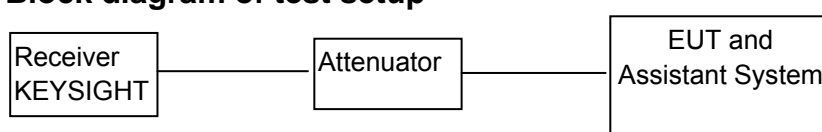

3.3. Limits

For direct sequence systems, the minimum 6dB bandwidth shall be at least 500 KHz

3.4. Test Procedure

- (1) Check the calibration of the measuring instrument using either an internal calibrator or a known signal from an external generator.
- (2) Position the EUT without connection to measurement instrument. Turn on the EUT and connect it to measurement instrument. Then set it to any one convenient frequency within its operating range. Set a reference level on the measuring instrument equal to the highest peak value.
- (3) Measure the frequency difference of two frequencies that were attenuated 6 dB from the reference level. Record the frequency difference as the emission bandwidth.
- (4) Repeat above procedures until all frequencies measured were complete.

3.5. Test Result

EUT Set Mode	CH or Frequency	6 dB bandwidth	99% dB bandwidth	Limt	Conclusion
		Result (MHz)	Result (MHz)		
BLE	CH0	0.701	1.069	>500KHz	PASS
	CH19	0.693	1.072	>500KHz	PASS
	CH39	0.696	1.076	>500KHz	PASS

3.6. Original test data

CH0

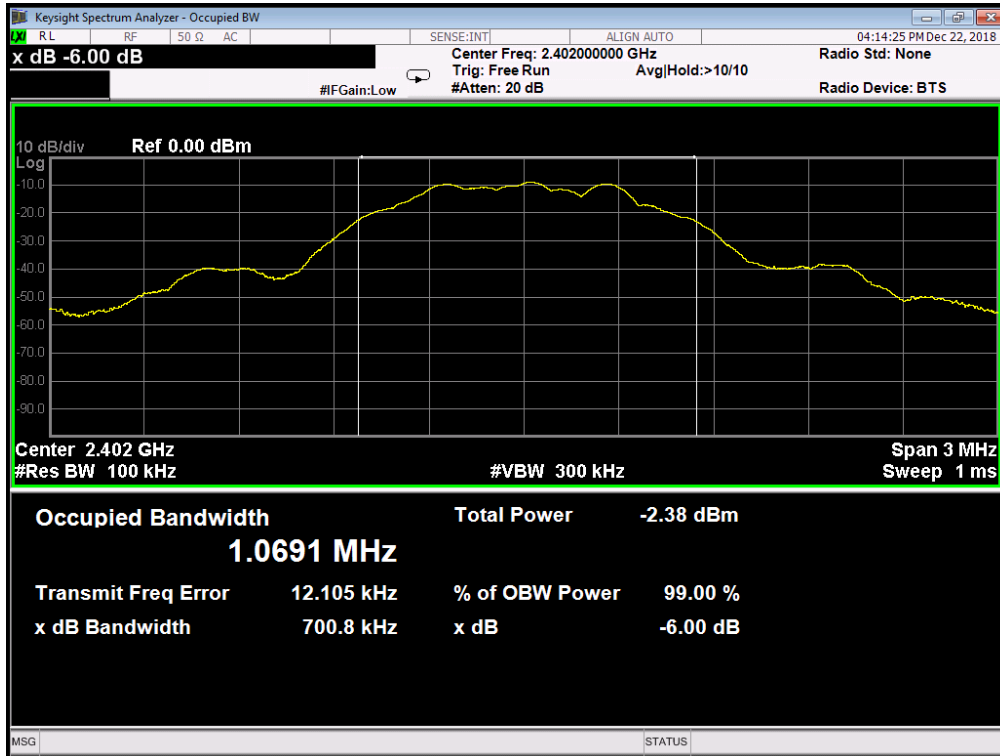

CH19

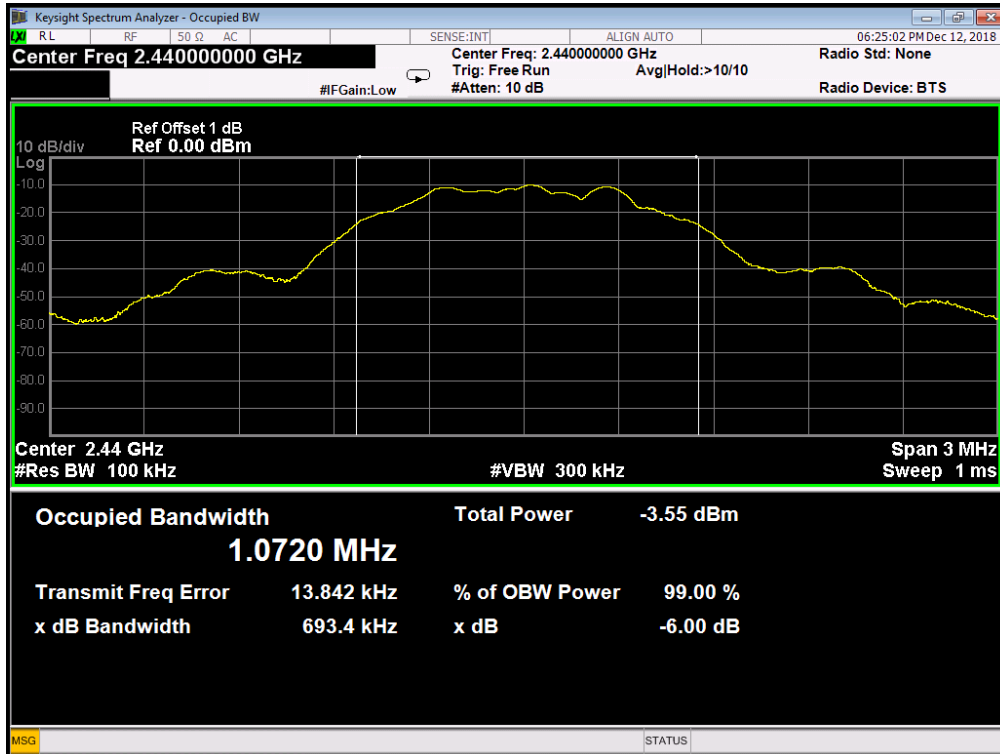

CH39

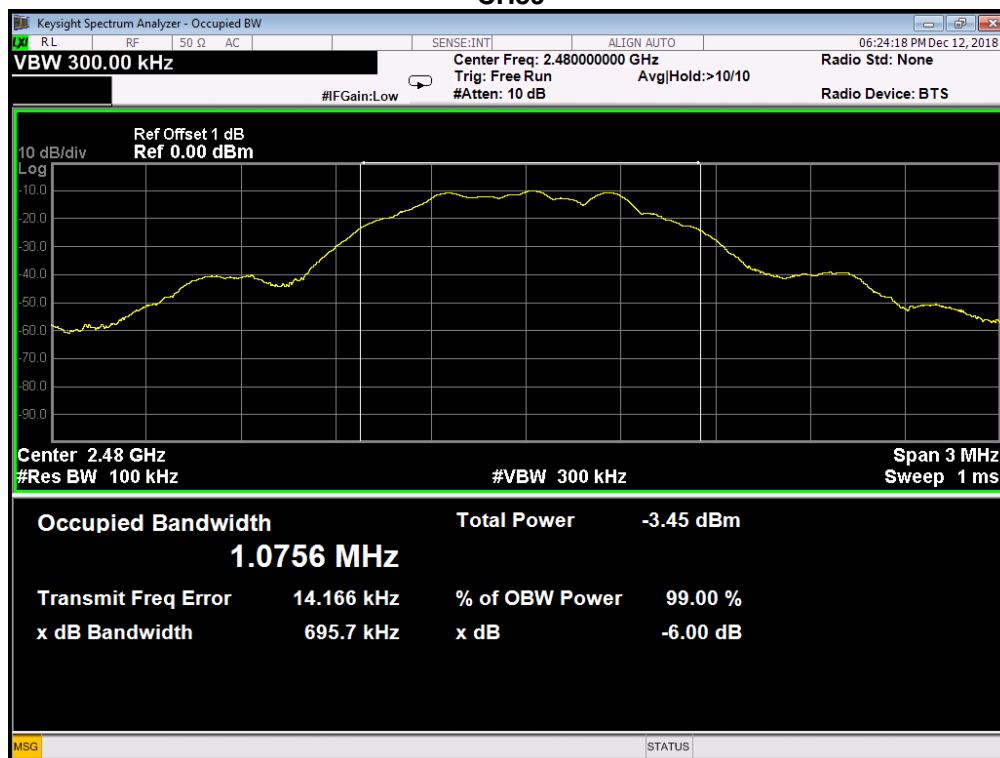

4. MAXIMUM PEAK OUTPUT POWER

4.1. Test equipment

Item	Equipment	Manufacturer	Model No.	Serial No.	Cal Due.	Cal. Interval
1	Spectrum analyzer	KEYSIGHT	N9010A	MY55150427	2019/05/25	1 Year
2	Attenuator	Mini-Circuits	BW-S10W2	101109	2018/12/17	1 Year
3	RF Cable	Micable	C10-01-01-1	100309	2018/12/17	1 Year

4.2. Block diagram of test setup

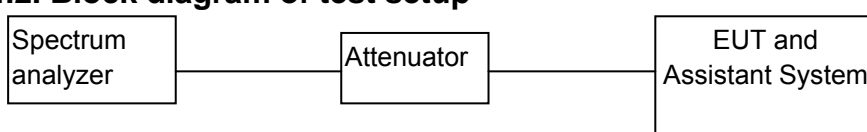

4.3. Limits

For systems using digital modulation in the 902-928 MHz, 2400-2483.5 MHz bands: 1 Watt. If transmitting antennas of directional gain greater than 6 dBi are used, the conducted output power from the intentional radiator shall be reduced below the stated values as appropriate, by the amount in dB that the directional gain of the antenna exceeds 6 dBi.

4.4. Test Procedure

- (1) Configure EUT and assistant system according clause 2.4 and 3.2
- (2) Connect EUT's antenna output to spectrum analyzer by RF cable.
- (3) Configure EUT work in test mode as stated in clause 2.4.
- (4) Set the spectrum analyzer as follows:

GFSK	RBW:	3MHz
	VBW:	8MHz
Span		≥ 3 x DTS bandwidth
Detector Mode:		Peak
Sweep time:		auto
Trace mode		Max hold

4.5. Test Result

EUT Set Mode	Limit(Peak)	Conclusion	CH	Result(dBm)
				Peak
BLE	30dBm	PASS	CH0	-10.118
			CH19	-10.005
			CH39	-9.943

4.6 Original test data

CH0

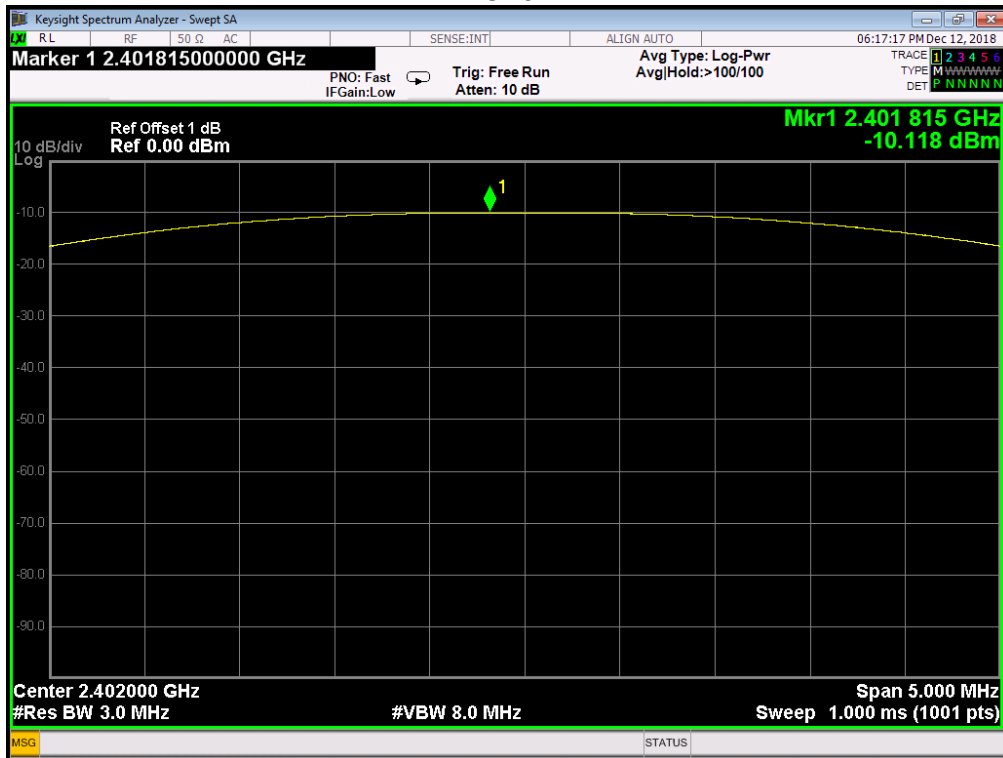

CH19

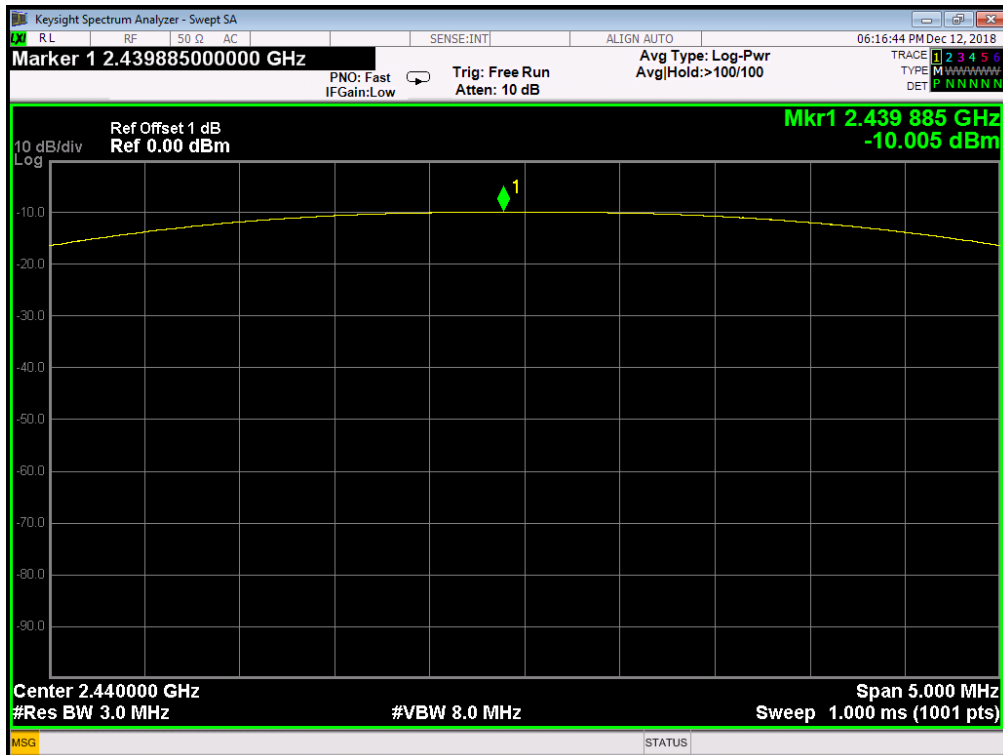

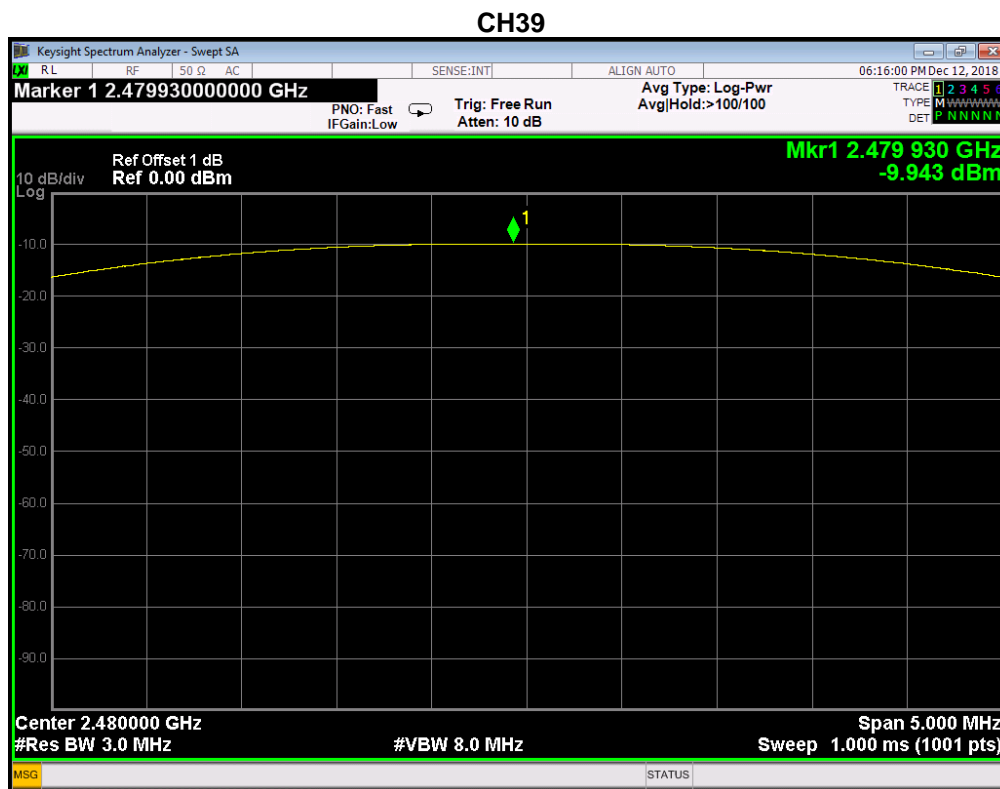

5. POWER SPECTRAL DENSITY

5.1. Test equipment

Item	Equipment	Manufacturer	Model No.	Serial No.	Cal Due.	Cal. Interval
1	Spectrum analyzer	KEYSIGHT	N9010A	MY55150427	2019/05/25	1 Year
2	Attenuator	Mini-Circuits	BW-S10W2	101109	2018/12/17	1 Year
3	RF Cable	Micable	C10-01-01-1	100309	2018/12/17	1 Year

5.2. Block diagram of test setup

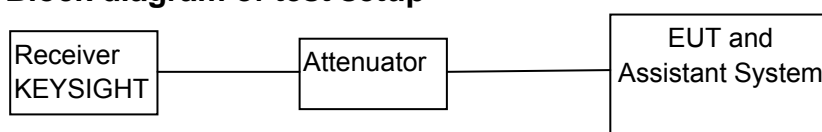

5.3. Limits

For digitally modulated systems, the power spectral density conducted from the intentional radiator to the antenna shall not be greater than 8dBm in any 3 kHz band during any time interval of continuous transmission.

5.4. Test Procedure

1. Check the calibration of the measuring instrument using either an internal calibrator or a known signal from an external generatorl.
2. Position the EUT was set without connection to measurement instrument. Turn on the EUT and connect its antenna terminal to measurement instrument via a low loss cable. Then set it to any one measured frequency within its operating range, and make sure the instrument is operated in its linear range
3. According to KDB 558074 D01 DTS Meas Guidance v05, set the RBW = 3 kHz, VBW = 10 kHz, Set the span to 1.5 times the DTS channel bandwidth.
4. Use the peak marker function to determine the maximum power level in any 3 kHz band segment within the fundamental EBW

5.5. Test Result

EUT Set Mode	CH or Frequency	Result	Limit: <dBm/3KHz	Conclusion
BLE	CH0	-26.967	8	PASS
	CH19	-26.833	8	PASS
	CH39	-26.881	8	PASS

5.6. Original test data

CH0

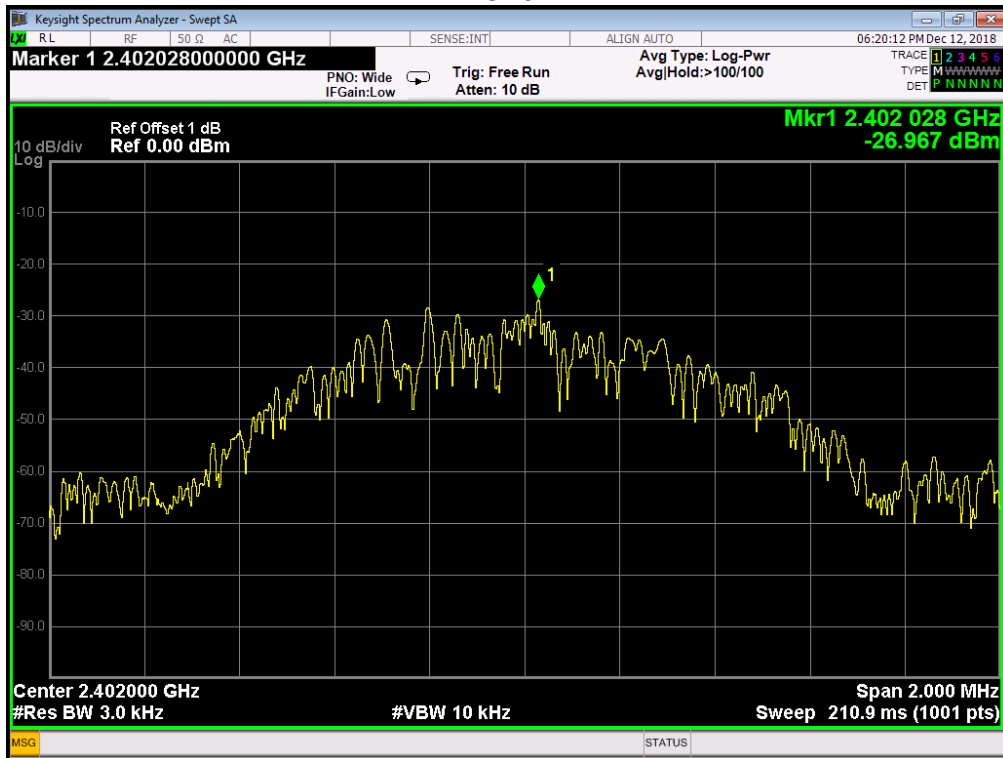

CH19

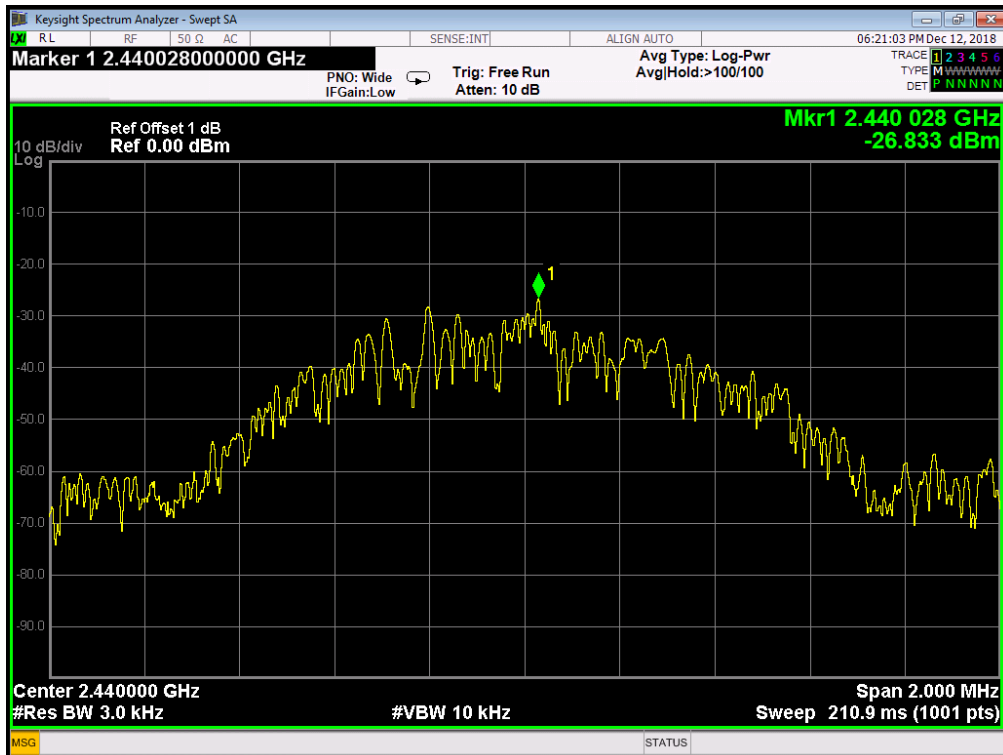

CH39

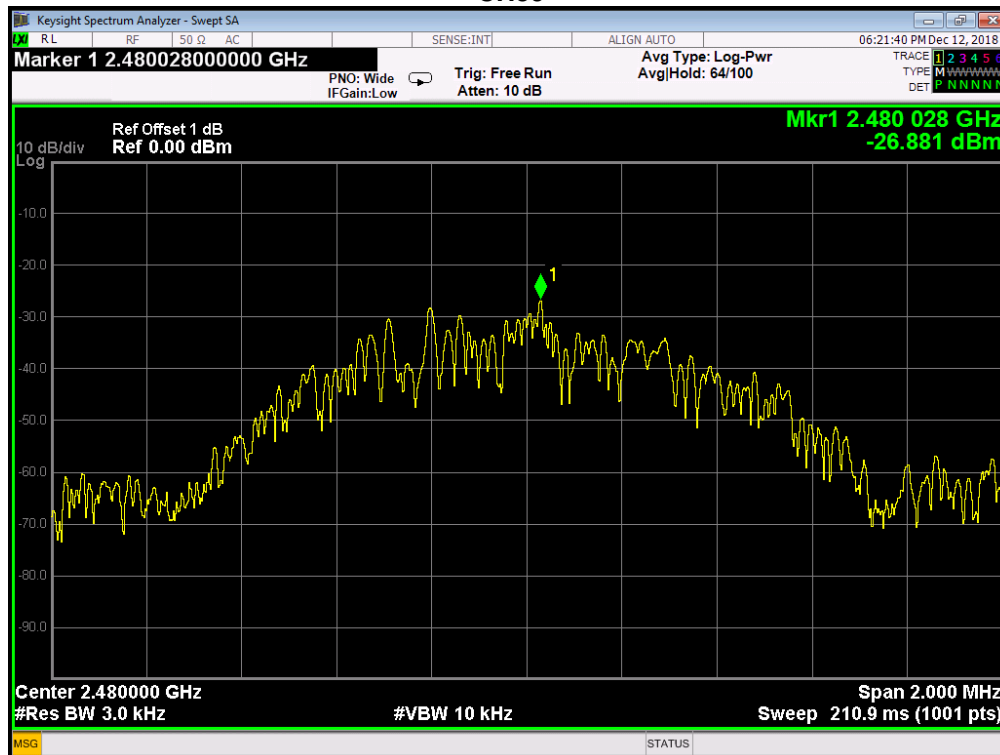

6. SPURIOUS EMISSIONS

6.1. Test equipment

Item	Equipment	Manufacturer	Model No.	Serial No.	Cal Due.	Cal. Interval
1	EMI Test Receiver	R&S	ESCI	101307	2018/12/17	1 Year
2	Spectrum Analyzer	Agilent	E4407B	US40240708	2019/07/03	1 Year
3	Spectrum analyzer	R&S	FSU	1166.1660.26	2018/12/17	1 Year
4	Loop antenna	TESEQ	HLA6120	20129	2018/12/17	1 Year
5	Trilog Broadband Antenna	Schwarzbeck	VULB9163	9163-462	2018/12/17	1 Year
6	Double Ridged Horn Antenna	Schwarzbeck	BBHA9120D	9120D 1065	2018/12/17	1 Year
7	Horn Antenna	Schwarzbeck	BBHA 9170	9170 1248	2018/12/17	1 Year
8	Pre-amplifier	A.H.	PAM-1840VH	562	2018/12/17	1 Year
9	Pre-amplifier	R&S	AFS33-18002 650-30-8P-44	SEL0080	2018/12/17	1 Year
10	Pre-Amplifier	HP	8449B	3274A06298	2018/12/17	1 Year
11	RF Cable	R&S	R01	10403	2018/12/17	1 Year
12	RF Cable	R&S	R02	10512	2018/12/17	1 Year
13	Measurement Software	Farad	EZ-EMC (Ver.ATT-03A)	N/A	N/A	N/A

6.2. Block diagram of test setup

In 3m Anechoic Chamber Test Setup Diagram for below 1GHz

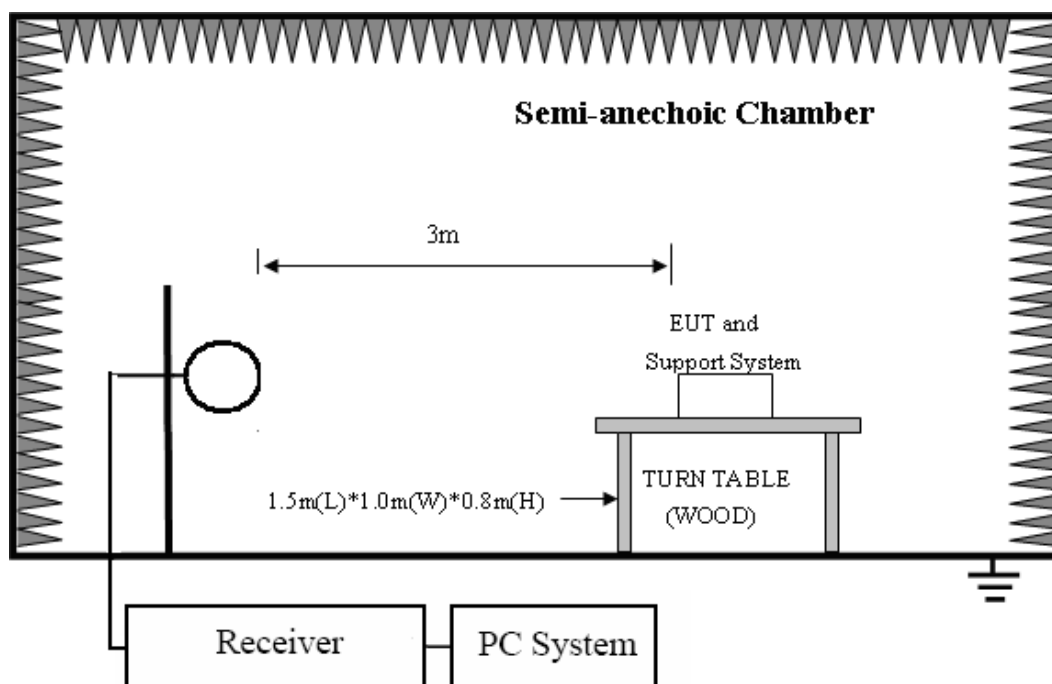

In 3m Anechoic Chamber Test Setup Diagram for 30MHz-1GHz

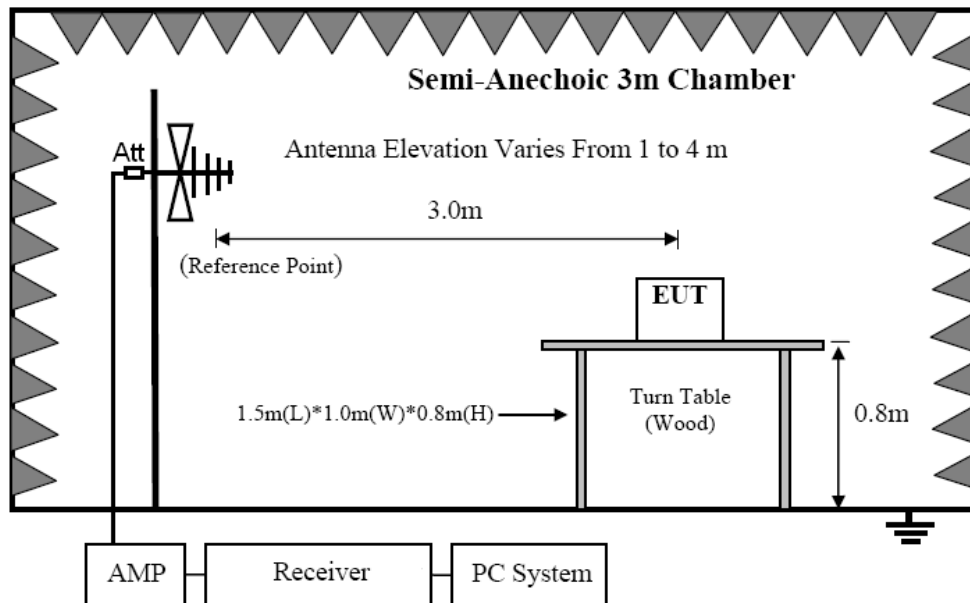

In 3m Anechoic Chamber Test Setup Diagram for frequency above 1GHz

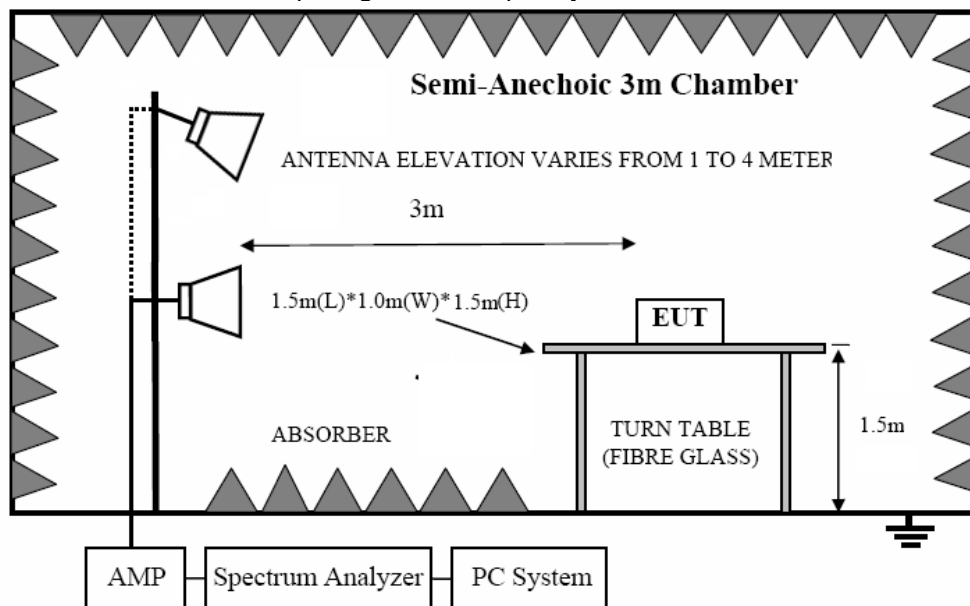

Note: For harmonic emissions test a appropriate high pass filter was inserted in the input port of AMP.

6.3. Limit

6.3.1 FCC 15.205 Restricted frequency band

MHz	MHz	MHz	GHz
0.090 - 0.110	16.42 - 16.423	399.9 - 410	4.5 - 5.15
¹ 0.495 - 0.505	16.69475 - 16.69525	608 - 614	5.35 - 5.46
2.1735 - 2.1905	16.80425 - 16.80475	960 - 1240	7.25 - 7.75
4.125 - 4.128	25.5 - 25.67	1300 - 1427	8.025 - 8.5
4.17725 - 4.17775	37.5 - 38.25	1435 - 1626.5	9.0 - 9.2
4.20725 - 4.20775	73 - 74.6	1645.5 - 1646.5	9.3 - 9.5
6.215 - 6.218	74.8 - 75.2	1660 - 1710	10.6 - 12.7
6.26775 - 6.26825	108 - 121.94	1718.8 - 1722.2	13.25 - 13.4
6.31175 - 6.31225	123 - 138	2200 - 2300	14.47 - 14.5
8.291 - 8.294	149.9 - 150.05	2310 - 2390	15.35 - 16.2
8.362 - 8.366	156.52475 - 156.52525	2483.5 - 2500	17.7 - 21.4
8.37625 - 8.38675	156.7 - 156.9	2690 - 2900	22.01 - 23.12
8.41425 - 8.41475	162.0125 - 167.17	3260 - 3267	23.6 - 24.0
12.29 - 12.293	167.72 - 173.2	3332 - 3339	31.2 - 31.8
12.51975 - 12.52025	240 - 285	3345.8 - 3358	36.43 - 36.5
12.57675 - 12.57725	322 - 335.4	3600 - 4400	(²)

6.3.2 FCC 15.209 Limit

FREQUENCY MHz	DISTANCE Meters	FIELD STRENGTHS LIMIT	
		$\mu\text{V}/\text{m}$	$\text{dB}(\mu\text{V})/\text{m}$
30 ~ 88	3	100	40.0
88 ~ 216	3	150	43.5
216 ~ 960	3	200	46.0
960 ~ 1000	3	500	54.0
Above 1000	3	74.0 $\text{dB}(\mu\text{V})/\text{m}$ (Peak) 54.0 $\text{dB}(\mu\text{V})/\text{m}$ (Average)	

6.3.3 Limit for this EUT

The radiated emission tests were performed in the 3 meters test site, using the setup accordance with the ANSI C63.10:2013. The specification used was the FCC 15.209, and FCC 15.247 limits.

6.4. Test Procedure

- (1) EUT was placed on a non-metallic table, 80 cm above the ground plane inside a semi-anechoic chamber.
- (2) Setup EUT and assistant system according clause 2.4 and 8.2
- (3) Test antenna was located 3m from the EUT on an adjustable mast. Below pre-scan procedure was first performed in order to find prominent radiated emissions.
 - (a) Change work frequency or channel of device if practicable.
 - (b) Change modulation type of device if practicable.
 - (c) Change power supply range from 85% to 115% of the rated supply voltage
 - (d) Rotated EUT though three orthogonal axes to determine the attitude of EUT arrangement produces highest emissions
- (4) Spectrum frequency from 9MHz to 25GHz (tenth harmonic of fundamental frequency) was investigated, and no any obvious emission were detected from 9KHz to 30MHz and 18GHz to 25GHz, so below final test was performed with frequency range from 30MHz to 18GHz.
- (5) For final emissions measurements at each frequency of interest, the EUT were rotated and the antenna height was varied between 1m and 4m in order to maximize the emission. Measurements in both horizontal and vertical polarities were made and the data was recorded. In order to find the maximum emission, the relative positions of equipments and all of the interface cables were changed according to ANSI C63.10 2013 on Radiated Emission test.
- (6) For emissions from 30MHz to 1GHz, Quasi-Peak values were measured with EMI Receiver and the bandwidth of Receiver is 120 KHz.
- (7) For emissions above 1GHz, both Peak and Average level were measured with Spectrum Analyzer, and the RBW is set at 1MHz, VBW is set at 3MHz for Peak measure, Detector is at PK; RBW is set at 1MHz, VBW is set at 3MHz for Average measure, Detector is at RMS.

6.5. Test result

Below 30M

EUT:	Laser range finder	Model No.:	KILO3000BDX
Temperature:	24℃	Relative Humidity:	55%
Distance:	3m	Test Power:	DC 3V
Polarization:	--	Test Result:	Pass
Test Mode:	Keeping TX mode	Test By:	Smile

Freq. (MHz)	Reading (dBuV/m)	Limit (dBuV/m)	Margin (dB)	State P/F
--	--	--	--	P
--	--	--	--	P

Note:

The amplitude of spurious emissions which are attenuated by more than 20dB below the permissible value has no need to be reported.

Distance extrapolation factor = $20 \log (\text{specific distance}/\text{test distance})(\text{dB})$;

Limit line = specific limits(dBuv) + distance extrapolation factor

Between 30M – 1000 MHz

EUT:	Laser range finder	Model No.:	KILO3000BDX
Temperature:	24°C	Relative Humidity:	55%
Distance:	3m	Test Power:	DC 3V
Polarization:	Vertical	Test Result:	Pass
Test Time:	2018-12-11	Test By:	Blue
Standard:	(RE)FCC PART 15 class B 3m		
Test Mode:	Keeping TX Mdoe		
Note:			

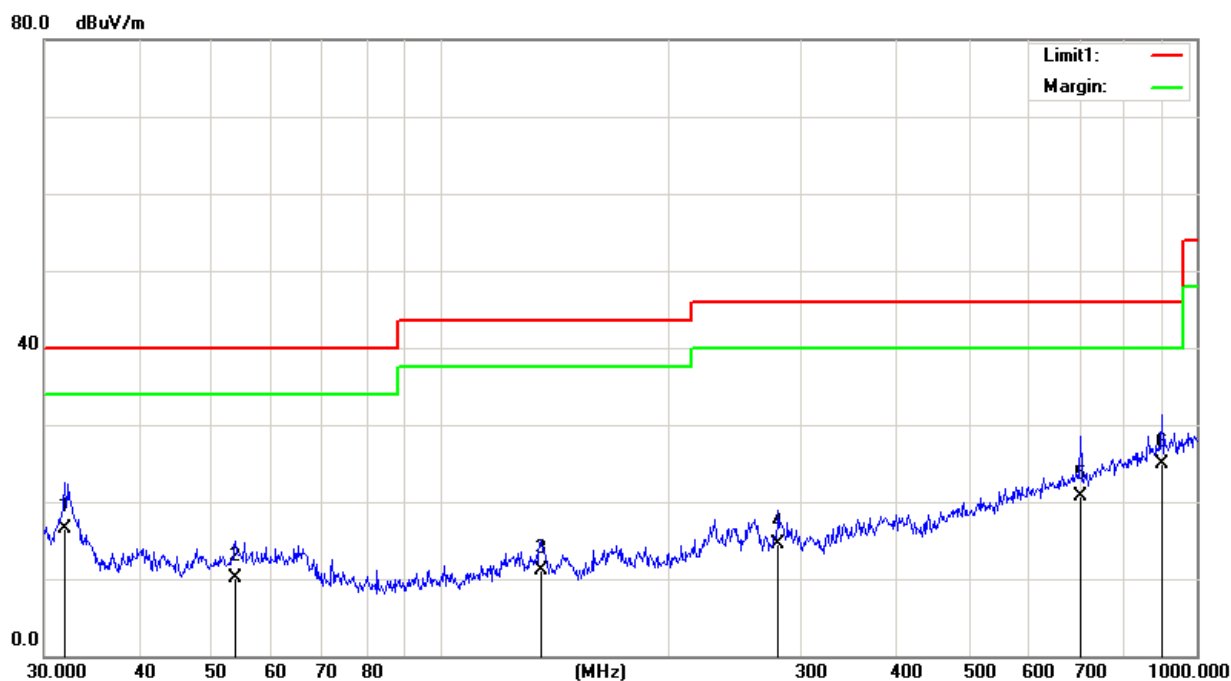

No.	Frequency (MHz)	Reading (dBuV/m)	Correct Factor(dB/m)	Result (dBuV/m)	Limit (dBuV/m)	Margin (dB)	Remark
1	31.9545	29.10	-12.54	16.56	40.00	-23.44	QP
2	53.6931	23.31	-13.11	10.20	40.00	-29.80	QP
3	135.9822	24.02	-12.96	11.06	43.50	-32.44	QP
4	280.0237	21.29	-6.84	14.45	46.00	-31.55	QP
5	701.7609	23.17	-2.52	20.65	46.00	-25.35	QP
6	900.1473	24.04	0.84	24.88	46.00	-21.12	QP

The test result is calculated as the following:

- (1) Result = Reading + Correct Factor
- (2) Correct Factor = Antenna Factor + Cable Loss – Amplifier Gain + Attenuator
- (3) Margin = Result - Limit

EUT:	Laser range finder	Model No.:	KILO3000BDX
Temperature:	24°C	Relative Humidity:	55%
Distance:	3m	Test Power:	DC 3V
Polarization:	Horizontal	Test Result:	Pass
Test Time:	2018-12-11	Test By:	Blue
Standard:	(RE)FCC PART 15 class B 3m		
Test Mode:	Keeping TX Mdoe		
Note:			

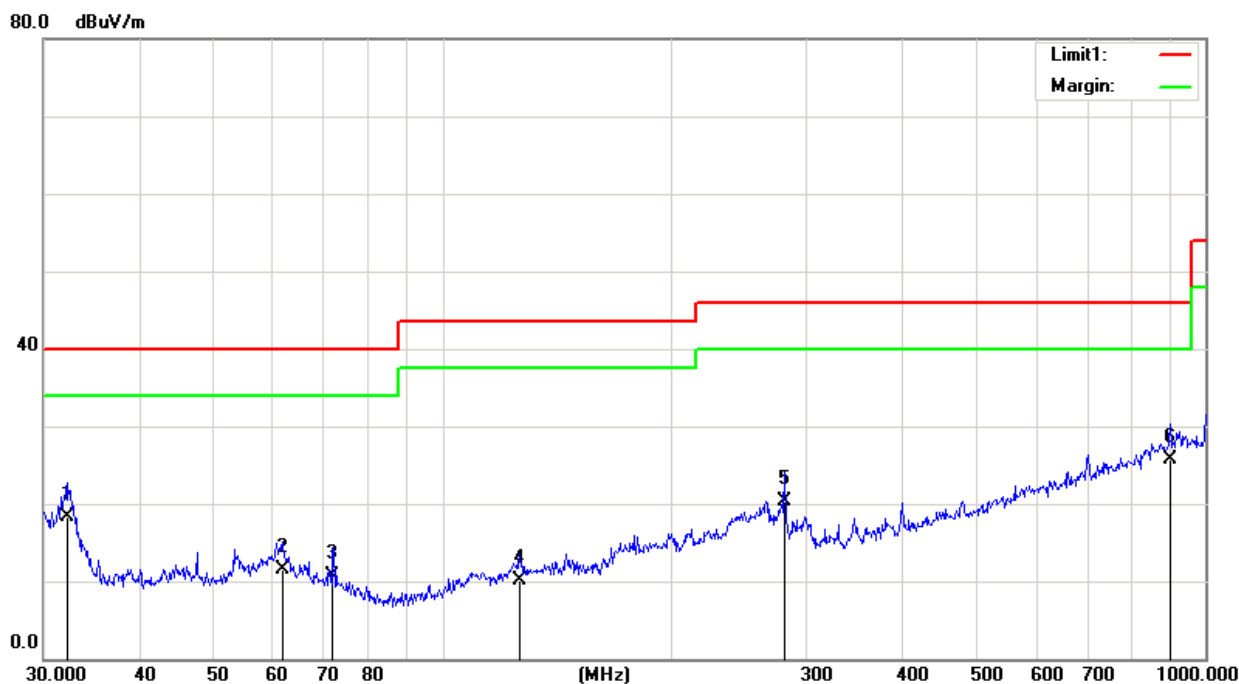

No.	Frequency (MHz)	Reading (dBuV/m)	Correct Factor(dB/m)	Result (dBuV/m)	Limit (dBuV/m)	Margin (dB)	Remark
1	32.1794	32.51	-14.19	18.32	40.00	-21.68	QP
2	61.7781	27.71	-16.26	11.45	40.00	-28.55	QP
3	71.8319	27.36	-16.74	10.62	40.00	-29.38	QP
4	126.3285	23.69	-13.49	10.20	43.50	-33.30	QP
5	281.0074	26.79	-6.42	20.37	46.00	-25.63	QP
6	900.1472	23.84	1.81	25.65	46.00	-20.35	QP

The test result is calculated as the following:

- (1) Result = Reading + Correct Factor
- (2) Correct Factor = Antenna Factor + Cable Loss – Amplifier Gain + Attenuator
- (3) Margin = Result - Limit

Between 1000M – 26500 MHz

EUT:	Laser range finder	Model No.:	KILO3000BDX
Temperature:	24°C	Relative Humidity:	55%
Distance:	3m	Test Power:	DC 3V
Polarization:	Vertical	Test Result:	Pass
Test Time:	2018-12-12	Test By:	Blue
Standard:	FCC PART 15.247		
Test Mode:	TX		
Note:	2402MHz		

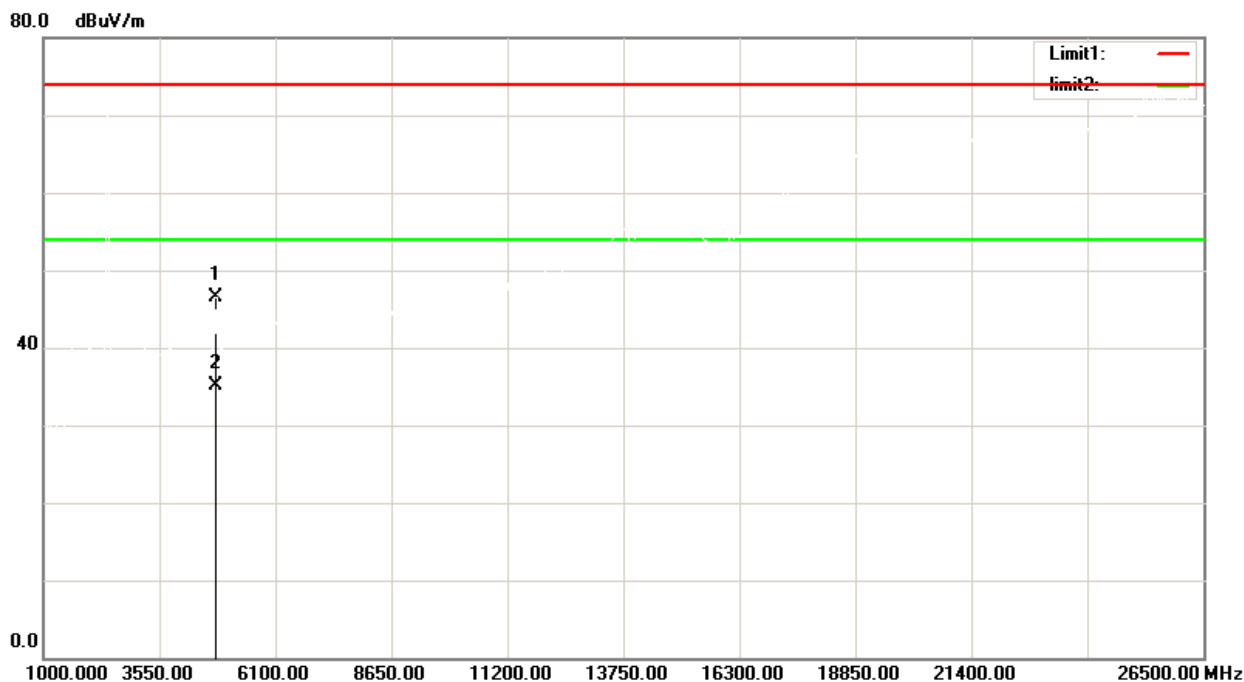

No.	Frequency (MHz)	Reading (dBuV/m)	Correct Factor(dB/m)	Result (dBuV/m)	Limit (dBuV/m)	Margin (dB)	Remark
1	4804.050	57.29	-10.79	46.50	74.00	-27.50	peak
2	4804.050	45.81	-10.79	35.02	54.00	-18.98	AVG

The test result is calculated as the following:

- (1) Result = Reading + Correct Factor
- (2) Correct Factor = Antenna Factor + Cable Loss – Amplifier Gain
- (3) Margin = Result - Limit

EUT:	Laser range finder	Model No.:	KILO3000BDX
Temperature:	24°C	Relative Humidity:	55%
Distance:	3m	Test Power:	DC 3 V
Polarization:	Horizontal	Test Result:	Pass
Test Time:	2018-12-12	Test By:	Blue
Standard:	FCC PART 15.247		
Test Mode:	TX		
Note:	2402MHz		

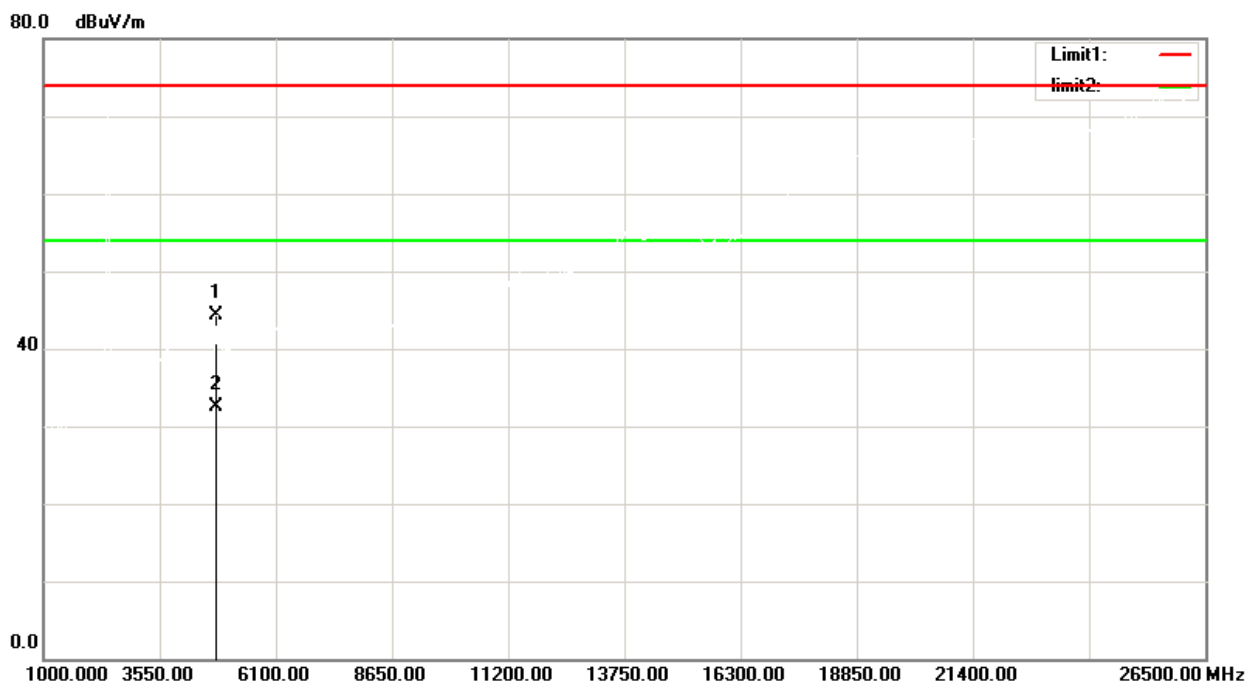

No.	Frequency (MHz)	Reading (dBuV/m)	Correct Factor(dB/m)	Result (dBuV/m)	Limit (dBuV/m)	Margin (dB)	Remark
1	4804.000	55.01	-10.79	44.22	74.00	-29.78	peak
2	4804.000	43.37	-10.79	32.58	54.00	-21.42	AVG

The test result is calculated as the following:

- (1) Result = Reading + Correct Factor
- (2) Correct Factor = Antenna Factor + Cable Loss – Amplifier Gain
- (3) Margin = Result - Limit

EUT:	Laser range finder	Model No.:	KILO3000BDX
Temperature:	24°C	Relative Humidity:	55%
Distance:	3m	Test Power:	DC 3V
Polarization:	Vertical	Test Result:	Pass
Test Time:	2018-12-12	Test By:	Blue
Standard:	FCC PART 15.247		
Test Mode:	TX		
Note:	2440MHz		

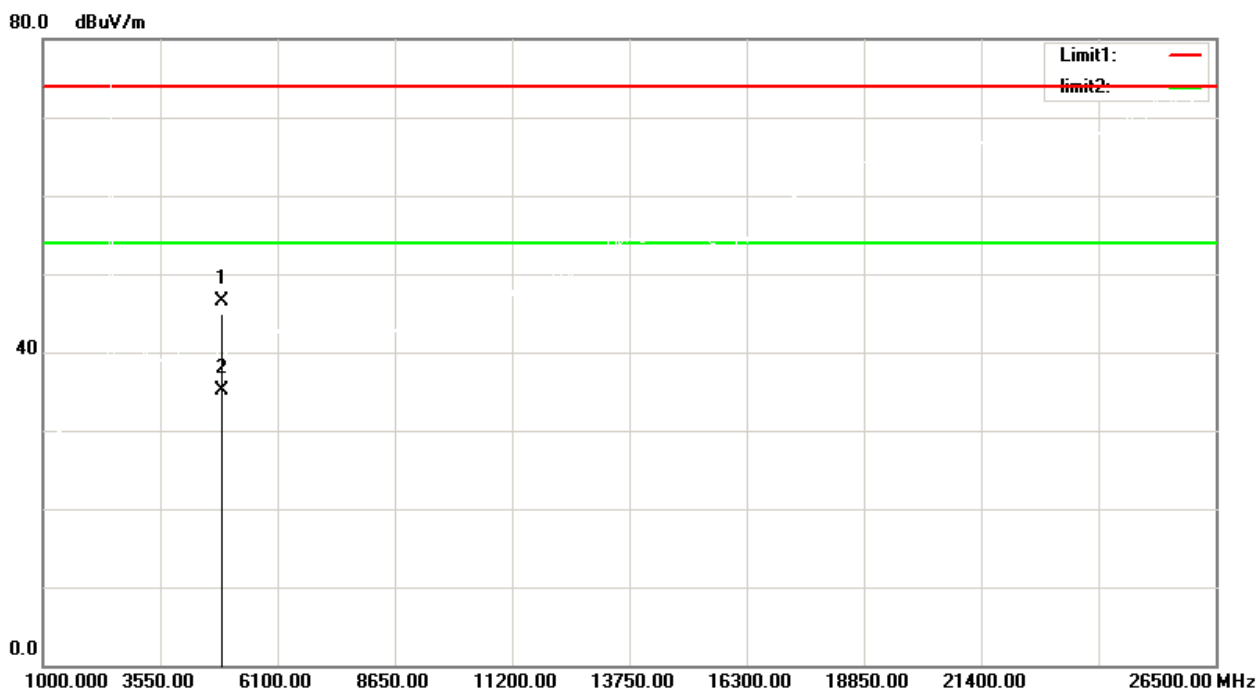

No.	Frequency (MHz)	Reading (dBuV/m)	Correct Factor(dB/m)	Result (dBuV/m)	Limit (dBuV/m)	Margin (dB)	Remark
1	4880.000	56.88	-10.44	46.44	74.00	-27.56	peak
2	4880.000	45.61	-10.44	35.17	54.00	-18.83	AVG

The test result is calculated as the following:

- (1) Result = Reading + Correct Factor
- (2) Correct Factor = Antenna Factor + Cable Loss – Amplifier Gain
- (3) Margin = Result - Limit

EUT:	Laser range finder	Model No.:	KILO3000BDX
Temperature:	24°C	Relative Humidity:	55%
Distance:	3m	Test Power:	DC 3V
Polarization:	Horizontal	Test Result:	Pass
Test Time:	2018-12-12	Test By:	Blue
Standard:	FCC PART 15.247		
Test Mode:	TX		
Note:	2440MHz		

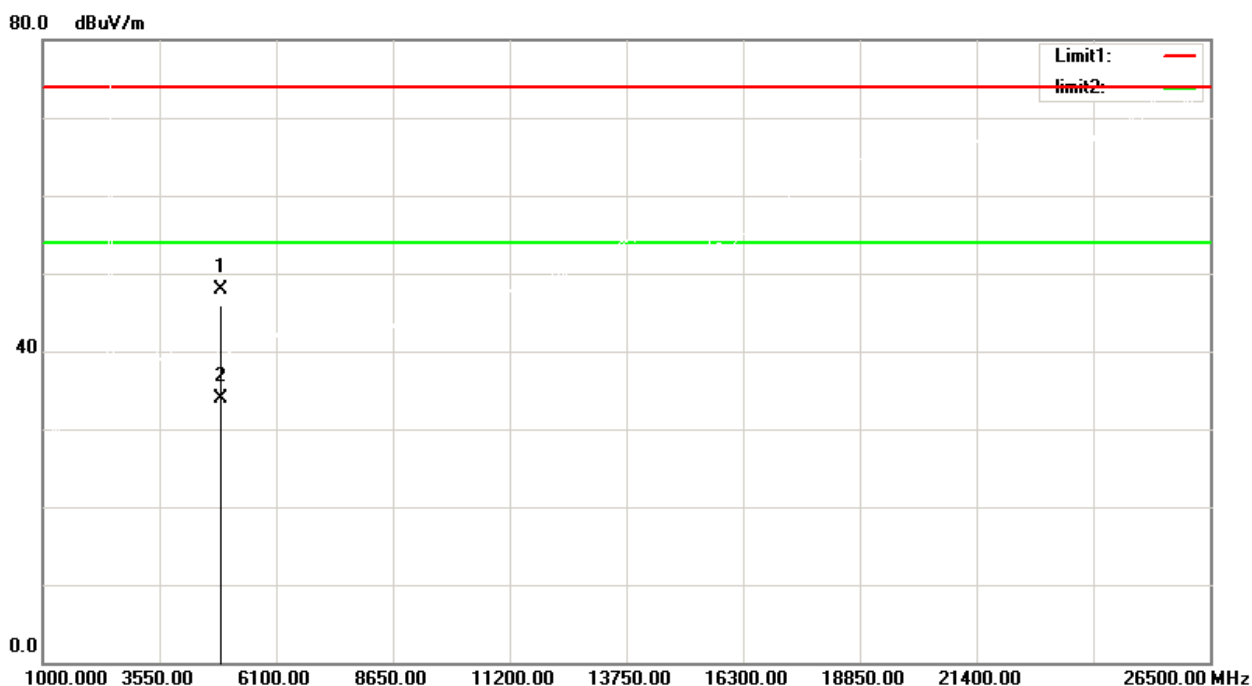

No.	Frequency (MHz)	Reading (dBuV/m)	Correct Factor(dB/m)	Result (dBuV/m)	Limit (dBuV/m)	Margin (dB)	Remark
1	4880.050	58.29	-10.44	47.85	74.00	-26.15	peak
2	4880.050	44.41	-10.44	33.97	54.00	-20.03	AVG

The test result is calculated as the following:

- (1) Result = Reading + Correct Factor
- (2) Correct Factor = Antenna Factor + Cable Loss – Amplifier Gain
- (3) Margin = Result - Limit

EUT:	Laser range finder	Model No.:	KILO3000BDX
Temperature:	24°C	Relative Humidity:	55%
Distance:	3m	Test Power:	DC 3V
Polarization:	Vertical	Test Result:	Pass
Test Time:	2018-12-12	Test By:	Blue
Standard:	FCC PART 15.247		
Test Mode:	TX		
Note:	2480MHz		

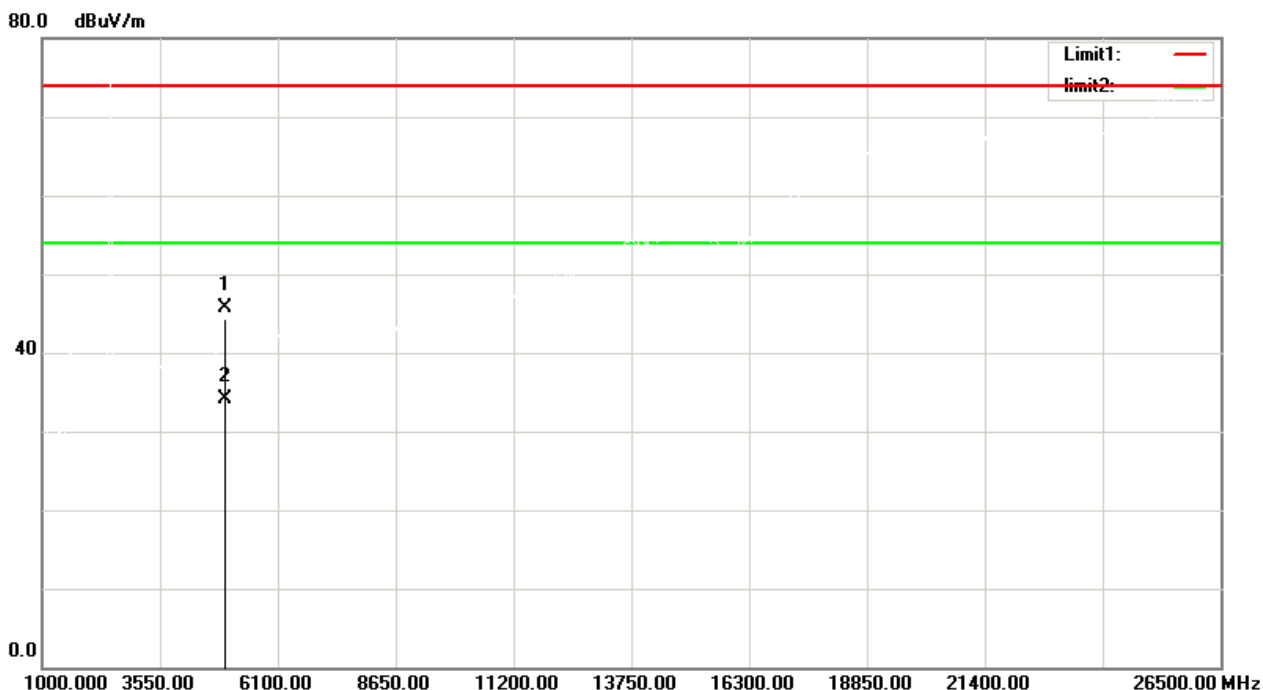

No.	Frequency (MHz)	Reading (dBuV/m)	Correct Factor(dB/m)	Result (dBuV/m)	Limit (dBuV/m)	Margin (dB)	Remark
1	4960.050	55.86	-10.08	45.78	74.00	-28.22	peak
2	4960.050	44.14	-10.08	34.06	54.00	-19.94	AVG

The test result is calculated as the following:

- (1) Result = Reading + Correct Factor
- (2) Correct Factor = Antenna Factor + Cable Loss – Amplifier Gain
- (3) Margin = Result - Limit

EUT:	Laser range finder	Model No.:	KILO3000BDX
Temperature:	24°C	Relative Humidity:	55%
Distance:	3m	Test Power:	DC 3V
Polarization:	Horizontal	Test Result:	Pass
Test Time:	2018-12-12	Test By:	Blue
Standard:	FCC PART 15.247		
Test Mode:	TX		
Note:	2480MHz		

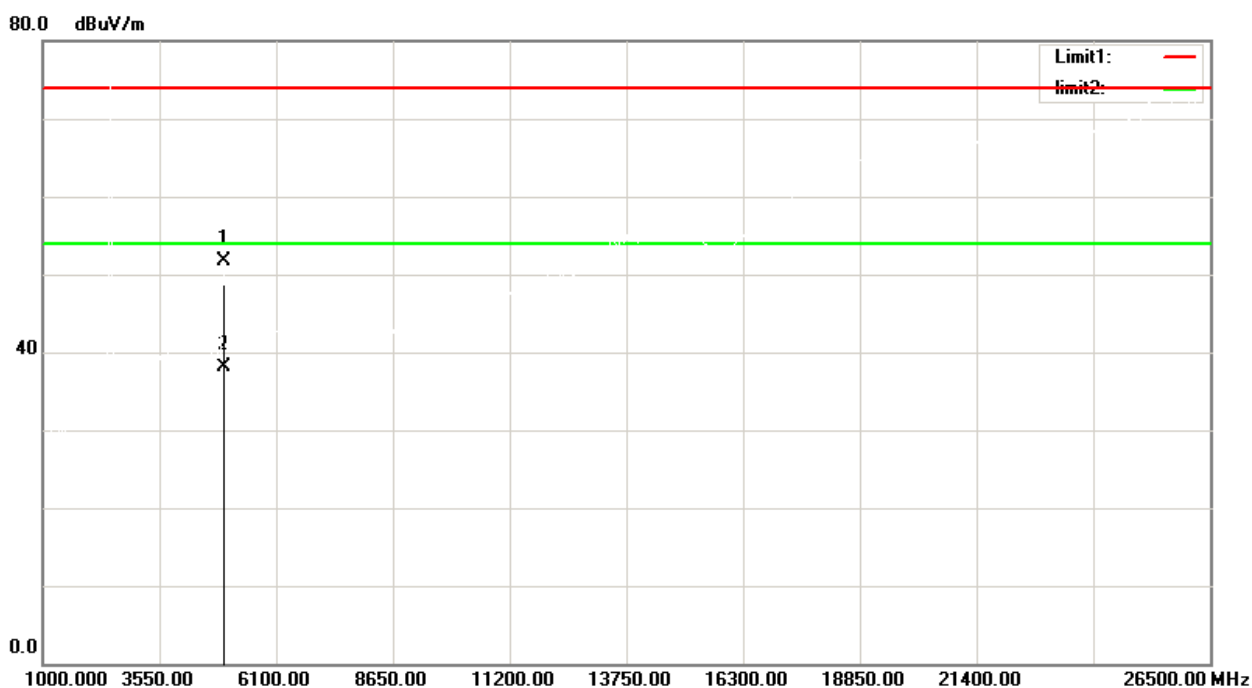

No.	Frequency (MHz)	Reading (dBuV/m)	Correct Factor(dB/m)	Result (dBuV/m)	Limit (dBuV/m)	Margin (dB)	Remark
1	4960.050	61.87	-10.08	51.79	74.00	-22.21	peak
2	4960.050	48.22	-10.08	38.14	54.00	-15.86	AVG

The test result is calculated as the following:

- (1) Result = Reading + Correct Factor
- (2) Correct Factor = Antenna Factor + Cable Loss – Amplifier Gain
- (3) Margin = Result - Limit

Radiated band edge:

EUT:	Laser range finder	Model No.:	KILO3000BDX
Temperature:	24°C	Relative Humidity:	55%
Distance:	3m	Test Power:	DC 3V
Polarization:	Vertical	Test Result:	Pass
Test Time:	2018-12-12	Test By:	Blue
Standard:	FCC PART 15.247		
Test Mode:	TX		
Note:	2402MHz		

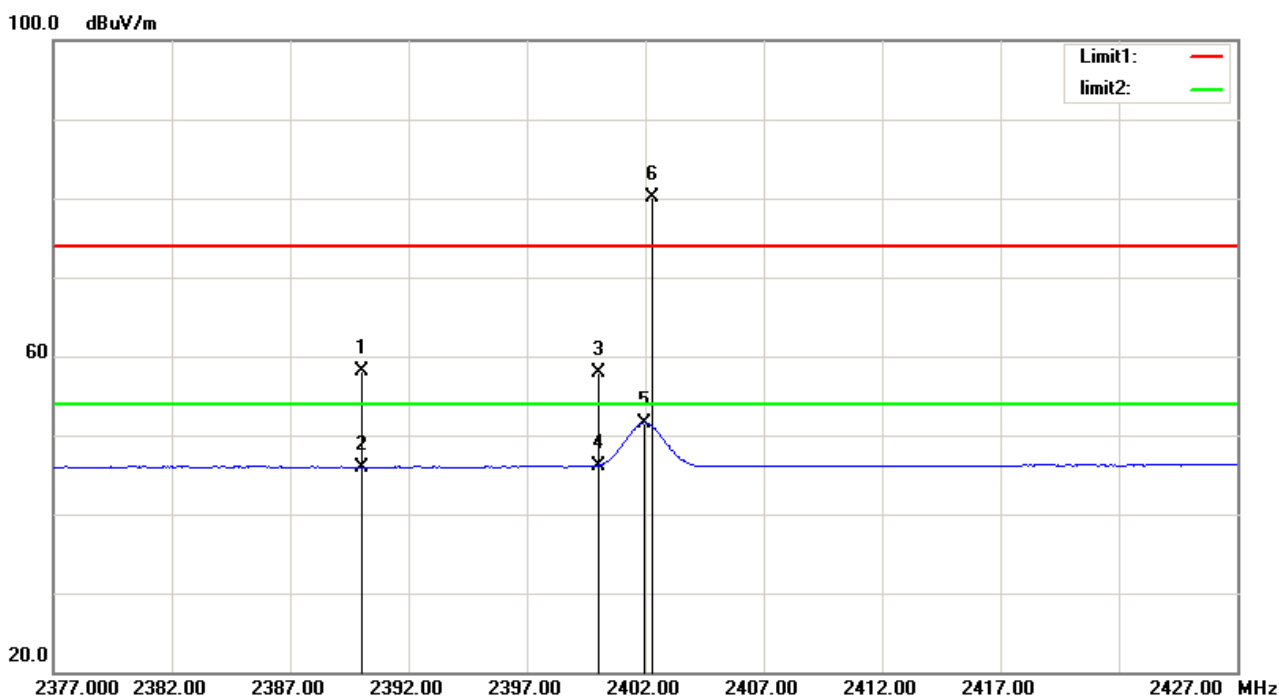

No.	Frequency (MHz)	Reading (dBuV/m)	Correct Factor(dB/m)	Result (dBuV/m)	Limit (dBuV/m)	Margin (dB)	Remark
1	2390.000	27.19	30.85	58.04	74.00	-15.96	peak
2	2390.000	15.08	30.85	45.93	54.00	-8.07	AVG
3	2400.000	26.97	30.87	57.84	74.00	-16.16	peak
4	2400.000	15.32	30.87	46.19	54.00	-7.81	AVG
5	2401.950	20.73	30.87	51.60			AVG
6	2402.300	49.21	30.87	80.08			peak

The test result is calculated as the following:

- (1) Result = Reading + Correct factor
- (2) Correct Factor = Antenna Factor + Cable Loss
- (3) Margin = Result - Limit

EUT:	Laser range finder	Model No.:	KILO3000BDX
Temperature:	24°C	Relative Humidity:	55%
Distance:	3m	Test Power:	DC 3V
Polarization:	Horizontal	Test Result:	Pass
Test Time:	2018-12-12	Test By:	Blue
Standard:	FCC PART 15.247		
Test Mode:	TX		
Note:	2402MHz		

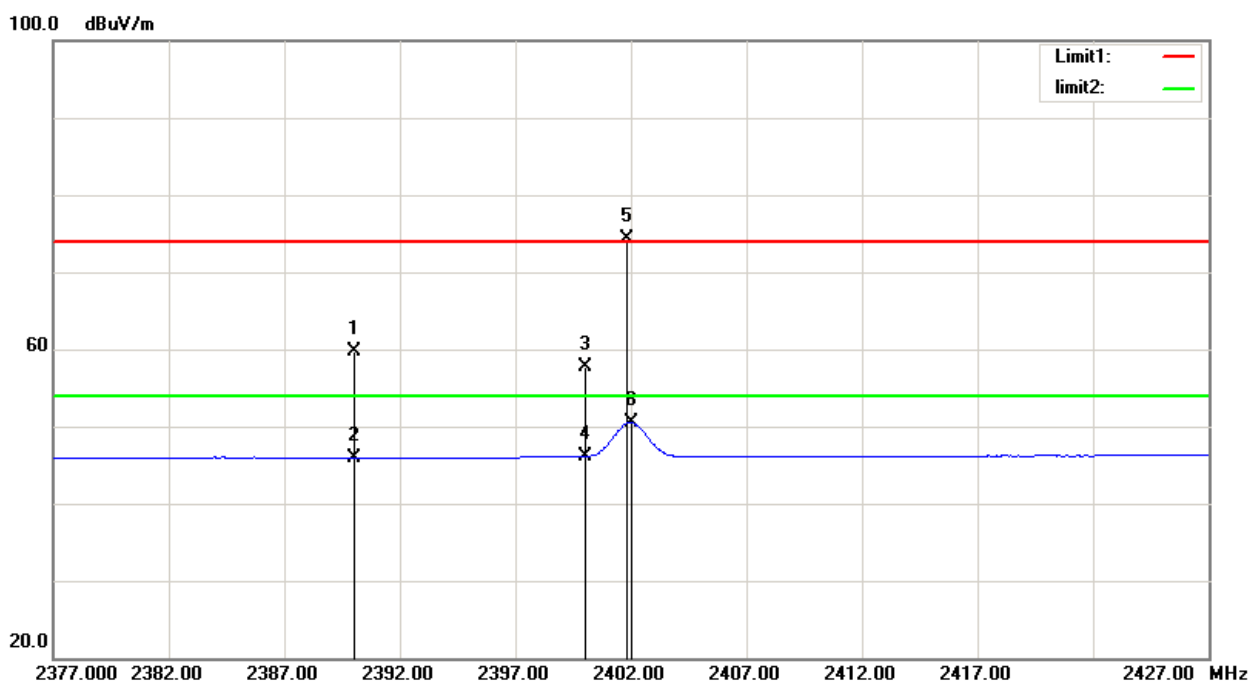

No.	Frequency (MHz)	Reading (dBuV/m)	Correct Factor(dB/m)	Result (dBuV/m)	Limit (dBuV/m)	Margin (dB)	Remark
1	2390.000	28.94	30.85	59.79	74.00	-14.21	peak
2	2390.000	15.11	30.85	45.96	54.00	-8.04	AVG
3	2400.000	26.81	30.87	57.68	74.00	-16.32	peak
4	2400.000	15.22	30.87	46.09	54.00	-7.91	AVG
5	2401.800	43.47	30.87	74.34			peak
6	2402.000	19.65	30.87	50.52			AVG

The test result is calculated as the following:

- (1) Result = Reading + Correct Factor
- (2) Correct Factor = Antenna Factor + Cable Loss
- (3) Margin = Result - Limit

EUT:	Laser range finder	Model No.:	KILO3000BDX
Temperature:	24°C	Relative Humidity:	55%
Distance:	3m	Test Power:	DC 3V
Polarization:	Vertical	Test Result:	Pass
Test Time:	2018-12-12	Test By:	Blue
Standard:	FCC PART 15.247		
Test Mode:	TX		
Note:	2480MHz		

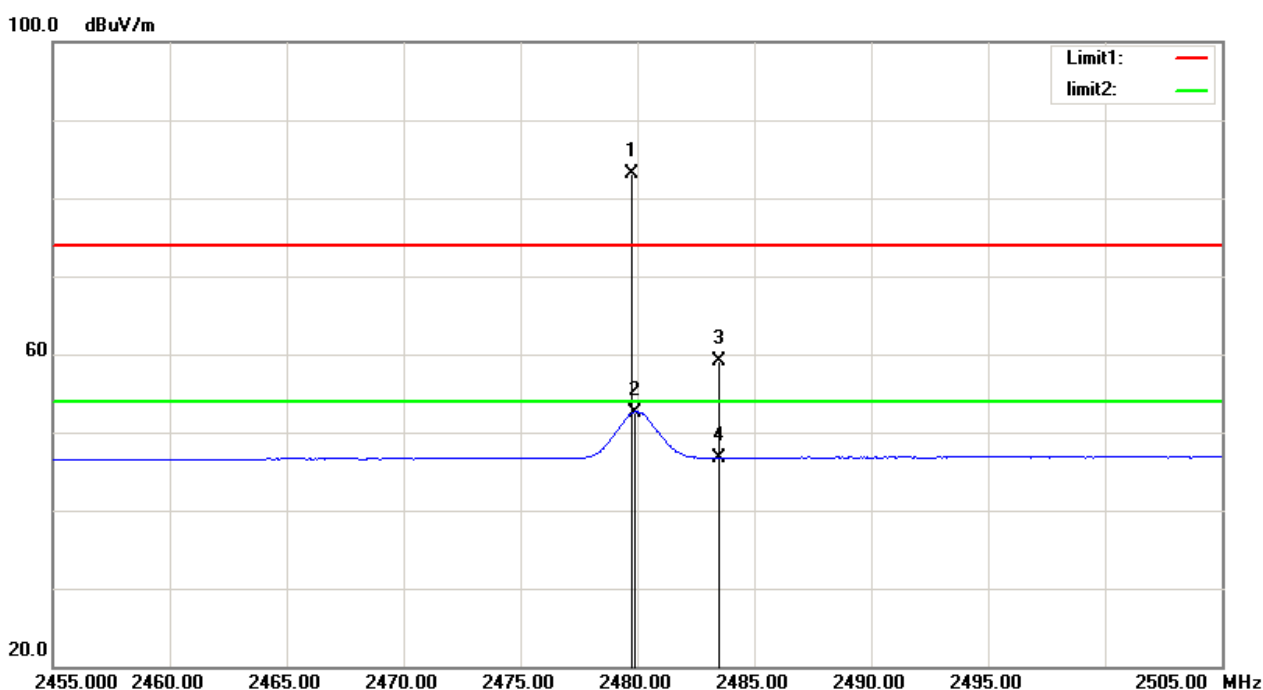

No.	Frequency (MHz)	Reading (dBuV/m)	Correct Factor(dB/m)	Result (dBuV/m)	Limit (dBuV/m)	Margin (dB)	Remark
1	2479.750	52.14	31.06	83.20			peak
2	2479.900	21.54	31.06	52.60			AVG
3	2483.500	28.12	31.07	59.19	74.00	-14.81	peak
4	2483.500	15.66	31.07	46.73	54.00	-7.27	AVG

The test result is calculated as the following:

- (1) Result = Reading + Correct Factor
- (2) Correct Factor = Antenna Factor + Cable Loss
- (3) Margin = Result - Limit

EUT:	Laser range finder	Model No.:	KILO3000BDX
Temperature:	24°C	Relative Humidity:	55%
Distance:	3m	Test Power:	DC 3 V
Polarization:	Horizontal	Test Result:	Pass
Test Time:	2018-12-12	Test By:	Blue
Standard:	FCC PART 15.247		
Test Mode:	TX		
Note:	2480MHz		

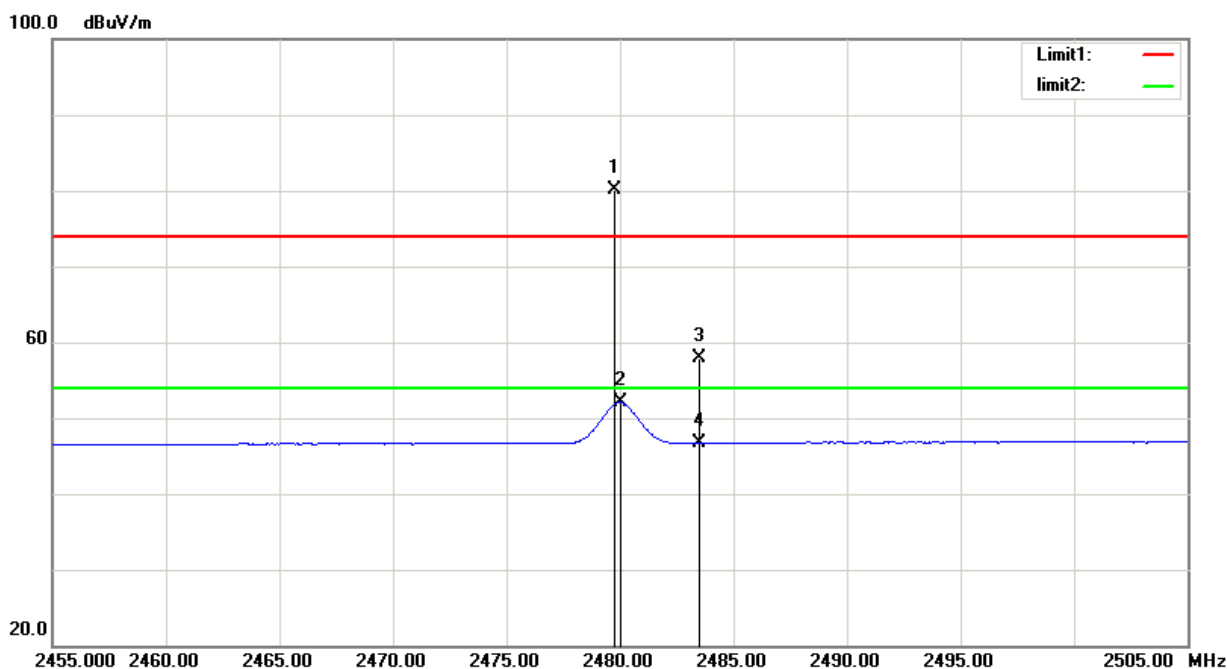

No.	Frequency (MHz)	Reading (dBuV/m)	Correct Factor(dB/m)	Result (dBuV/m)	Limit (dBuV/m)	Margin (dB)	Remark
1	2479.750	49.00	31.06	80.06			peak
2	2480.000	21.02	31.06	52.08			AVG
3	2483.500	26.83	31.07	57.90	74.00	-16.10	peak
4	2483.500	15.64	31.07	46.71	54.00	-7.29	AVG

The test result is calculated as the following:

- (1) Result = Reading + Correct Factor
- (2) Correct Factor = Antenna Factor + Cable Loss
- (3) Margin = Result - Limit

7. 100 KHZ BANDWIDTH OF FREQUENCY BAND EDGE

7.1. Test equipment

Item	Equipment	Manufacturer	Model No.	Serial No.	Cal Due.	Cal. Interval
1	Spectrum analyzer	KEYSIGHT	N9010A	MY55150427	2019/05/25	1 Year
2	Attenuator	Mini-Circuits	BW-S10W2	101109	2018/12/17	1 Year
3	RF Cable	Micable	C10-01-01-1	100309	2018/12/17	1 Year

7.2. Block diagram of test setup

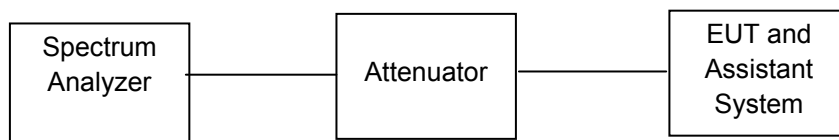

7.3. Limit

In any 100 kHz bandwidth outside the frequency band in which the spread spectrum or digitally modulated intentional radiator is operating, the radio frequency power that is produced by the intentional radiator shall be at least 20 dB below that in the 100 kHz bandwidth within the band that contains the highest level of the desired power, based on either an RF conducted or a radiated measurement, provided the transmitter demonstrates compliance with the peak conducted power limits. If the transmitter complies with the conducted power limits based on the use of RMS averaging over a time interval, as permitted under paragraph (b)(3) of this section, the attenuation required under this paragraph shall be 30 dB instead of 20 dB. Attenuation below the general limits specified in §15.209(a) is not required. In addition, radiated emissions which fall in the restricted bands, as defined in §15.205(a), must also comply with the radiated emission limits specified in §15.209(a) (see §15.205(c)).

7.4. Test Procedure

1. Check the calibration of the measuring instrument using either an internal calibrator or a known signal from an external generator.
2. Remove the antenna from the EUT and then connect to a low loss RF cable from the antenna port to a EMI test receiver, then turn on the EUT and make it operate in transmitting mode. Then set it to Low Channel and High Channel within its operating range, and make sure the instrument is operated in its linear range.
3. Set both RBW and VBW of spectrum analyzer to 100 kHz with a convenient frequency span including 100 kHz bandwidth from band edge.
4. Measure the highest amplitude appearing on spectral display and set it as a reference level. Plot the graph with marking the highest point and edge frequency.
5. Repeat above procedures until all measured frequencies were complete.

7.5. Test result

Frequency Band	Delta Peak to band emission (dBc)	>Limit (dBc)	Result
BLE Mode			
2400	49.551	20	Pass
2483.5	53.276	20	Pass

BLE

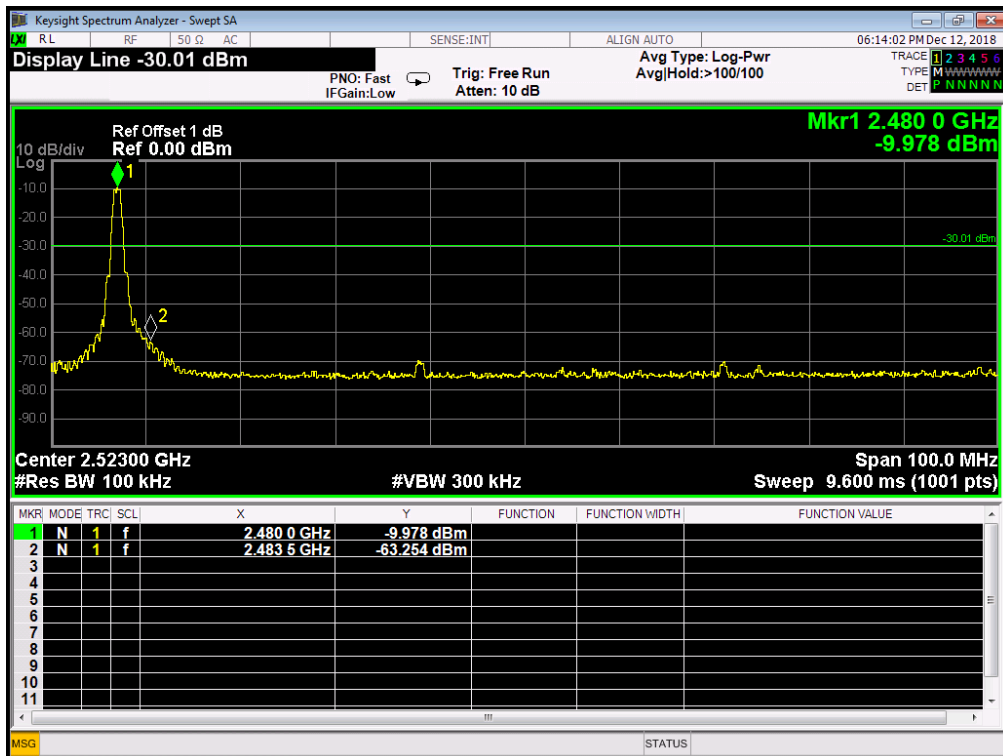
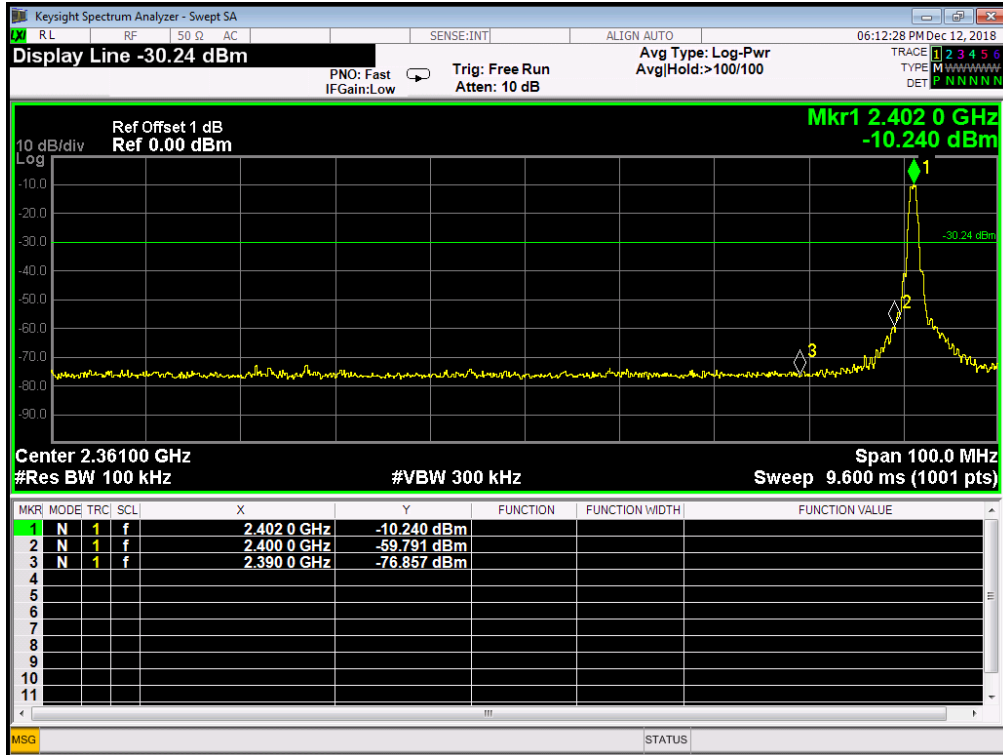

BLE 2402MHz

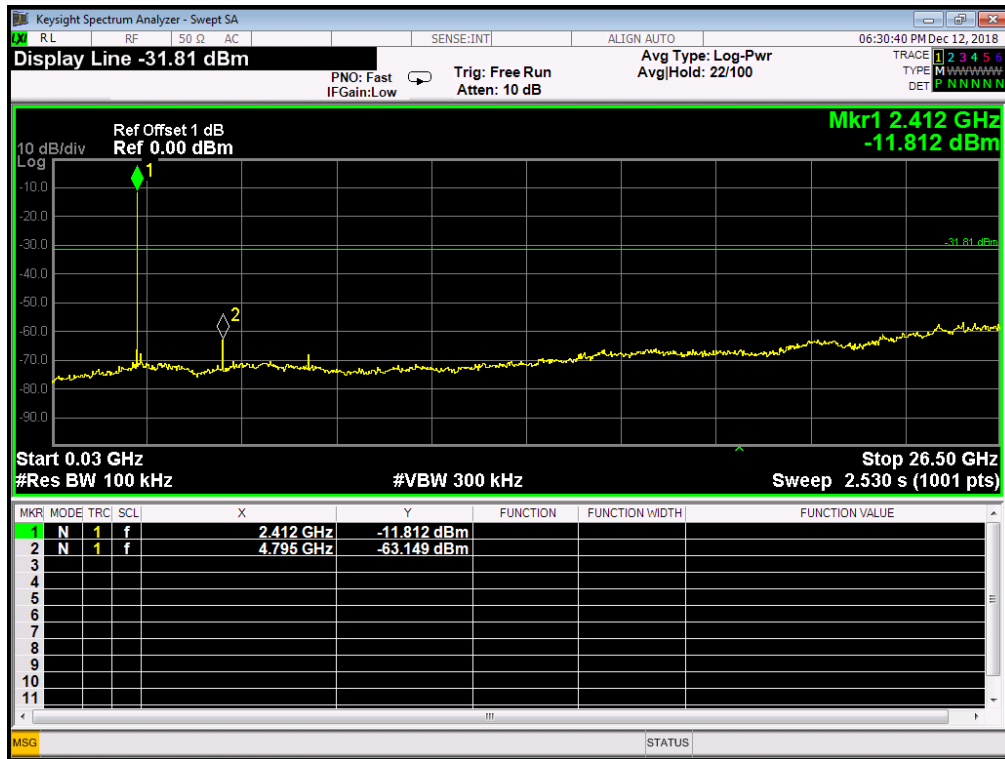

Conducted Emission

BLE 2440MHz

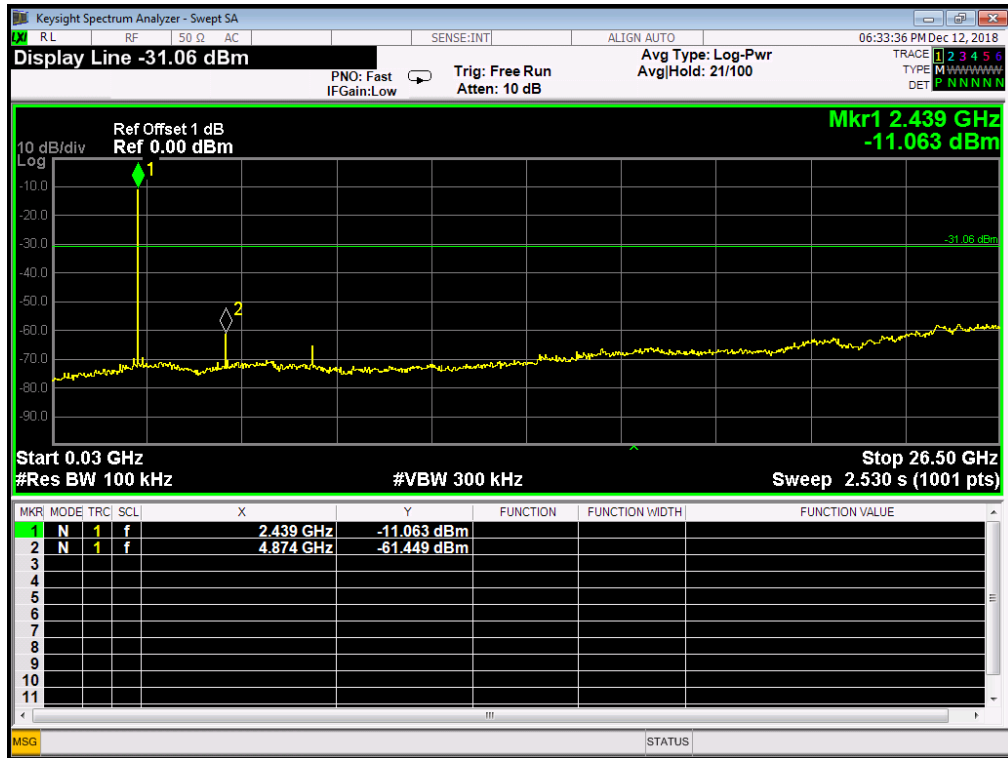

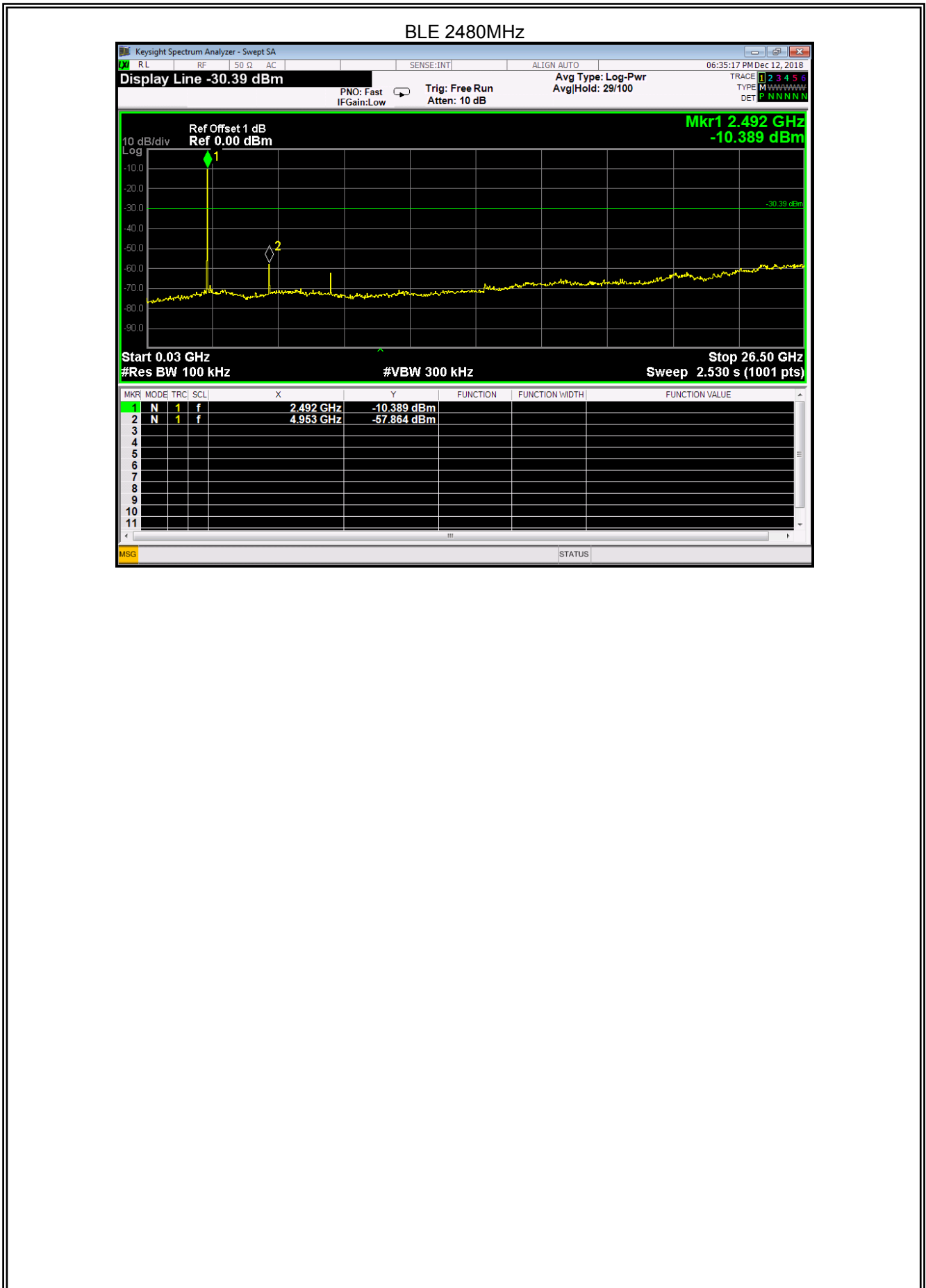

8. ANTENNA REQUIREMENTS

8.1. Limit

For intentional device, according to FCC 47 CFR Section 15.203, an intentional radiator shall be designed to ensure that no antenna other than that furnished by the responsible party shall be used with the device. And according to FCC 47 CFR Section 15.247 (b), if transmitting antennas of directional gain greater than 6dBi are used, the power shall be reduced by the amount in dB that the directional gain of the antenna exceeds 6dBi.

8.2. Result

The EUT antenna is permanent attached antenna. It comply with the standard requirement.

END OF REPORT