



# KILO<sup>®</sup>

KILO1600BDX™ 6x22 mm LASER RANGEFINDER  
WITH BALLISTIC DATA XCHANGE™



OWNERS MANUAL

**SIG SAUER<sup>®</sup>**

## TABLE OF CONTENTS

Introduction . . . . .	3
Contents . . . . .	4
Key Features . . . . .	5
Product Identification . . . . .	6
Operation . . . . .	17
Display Information . . . . .	21
Changing Modes of Operation . . . . .	22
Programming Sequence . . . . .	23
Frequently Asked Questions (FAQs) . . . . .	38
Specifications . . . . .	40
SIG SAUER® Electro-Optics Infinite Guarantee™ . . . . .	48

This manual is available in the following languages: French, Spanish, German, Italian, Portuguese, Russian, Afrikaans, Swedish, and Norwegian. Please visit [sigsauer.com](http://sigsauer.com) for Owners Manual downloads , or download to your Smart device with the SIG BDX App.

## INTRODUCTION

Congratulations on the purchase of your SIG SAUER® Laser Rangefinder. Your KILO® is one of the most compact, advanced and simple to use rangefinders on the market. All of Sig Sauer's rangefinders feature the fastest digital signal processing engine while streamlining the user interface for a no hassle, out of box experience.

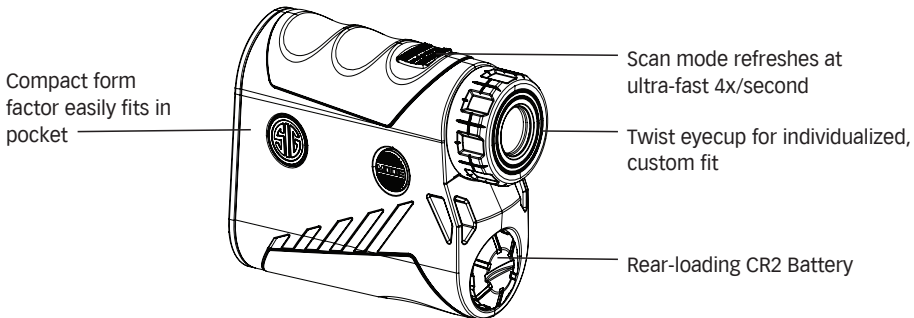

**CONTENTS:**

- KILO1600BDX™ Digital Laser Rangefinder
- CR2 Battery (1)
- Premium Padded Ballistic Nylon Case
- Lanyard
- Quick Start Guide

## KEY FEATURES:

- SIG SAUER'S Patent Pending Ballistic Data Xchange™ Technology utilizes, low energy Bluetooth with embedded Applied Ballistics Ultralight and the free BDX™ App to sync custom gun profiles and environmental conditions to your KILO® and pair your KILO to any BDX enabled riflescope or sight for shots out to 800 yards.
- 6x22 mm monocular with SpectraCoat™ anti-reflection coatings for superior light transmission and optical clarity.
- Revolutionary Lightwave™ DSP Technology for the fastest and longest distance rangefinder engine.
- HyperScan provides 4 range updates per second in scan mode while RangeLock reports the last range result when ranging distant targets.
- Features line of sight or angle modified range. Units in yards or meters to tenth Y/M resolution.
- Projected, segmented transparent OLED display for daytime and low light use.
- Lumatic™ Display automatically calibrates display brightness to changing ambient light conditions.
- Compact, aluminum housing and eyecup with integral diopter adjustment.
- Simplified user interface with RANGE and MODE buttons only.
- Rangefinder configuration can now be done through the free SIG BDX™ App.
- Displays windage and elevation within KILO HUD for every target that is scanned.

**PRODUCT IDENTIFICATION:**

A- Power/Range Button

B- Eyecup / Diopter Focus Adjustment

C- Mode Button

D- Battery Compartment

E- Lanyard

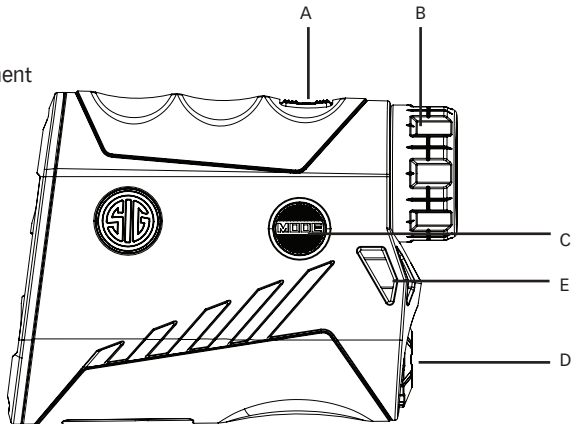

## LIGHTWAVE™ DSP TECHNOLOGY

SIG SAUER's proprietary Lightwave DSP engine leverages HyperScan – an advanced power management technique that provides the fastest refresh rate in scan mode (4 times per second) even at distances up to a mile. Our DSP engine uses the latest generation field programmable gate array (FPGA) running sophisticated signal processing algorithms to reduce false positives while finding weak or distant targets.

## RANGING ACCURACY, RESOLUTION AND MAXIMUM RANGES

The KILO1600BDX™ provides line of sight or angle modified range information accurate to  $\pm 0.5$  yards or meters out to 500 yards;  $\pm 1$  yard from 500 - 1000 yards and  $\pm 2$  yards beyond 1000 yards. Range is displayed in 0.1 yard or meter resolution.

RANGING PERFORMANCE IN HYPERSCAN MODE			
	Reflective	Trees	Deer
<b>KILO1600BDX</b>	Up to 2,000 yds	Up to 1,200 yds	Up to 1,000 yds

## **SIG SAUER BALLISTIC DATA XCHANGE (BDX)**

SIG SAUER's Patent Pending BDX system takes the guesswork out of determining the proper range and ballistics solution for hitting your target with the first round. Low Energy Bluetooth combined with an embedded ballistic calculator (Applied Ballistics Ultralight) allows the user to configure up to 25 bullet profiles on the free BDX App and sync to your KILO. Line of sight range, elevation and wind hold information is calculated instantly and displayed based on the active profile. When combined with one of SIG SAUER's BDX enabled riflescopes, the user ranges a target and the firing solution is instantly shared with the BDX rifle scope where the holdover dot is selectively illuminated.



## GENERAL OPERATION

Your rangefinder provides 3 modes of operation: AMR, LOS and ABU. AMR and LOS will be explained on the next page. When ABU is selected the user can pair the KILO with a nearby smartphone where the BDx App should already be installed. The user configures a bullet profile in the app, which is actively synced with a paired rangefinder. For example, the user downloads and installs the BDx App, selects a 0.308 caliber bullet and chooses a Barnes LRXBT 200 gr bullet – this profile is selected and saved in real-time. The user will then configure the muzzle velocity, zero range, temperature and altitude within the BDx App.

## **APPLIED BALLISTICS ULTRALIGHT (ABU)**

Your rangefinder has an embedded ballistics solver developed by Sig Sauer, Applied Ballistics and nVisti. By pairing your KILO with the free BDX App you can enter custom ballistics information for up to 25 bullet profiles and sync one at a time to your KILO. The active ballistic profile is now saved on your KILO, and when in ABU mode, will provide an accurate ballistic solution out to 800 yards maximum. The LOS range and angle of incline will be displayed for 2 seconds, then the elevation holdover value and finally the windage hold. This range and holdover information will continue to be displayed for 30 seconds or longer depending upon the timeout setting in the BDX App.

Wind direction and wind speed can also be configured within the App. The smartphone will actively sync all inputs with the KILO and the KILO can then be used without a smartphone. BDX provides a firing solution out to a maximum of 800 yards. Custom drag curves are not provided within the BDX App. For users that require more precision or will be shooting further than 800 yards, the KILO2400ABS with Applied Ballistics Elite is the preferred solution. When in ABU mode, paired and bonded with a BDX enabled sight the Bluetooth icon will be visible and will flash when a new ballistic solution is calculated – which confirms your BDX enabled sight received the new holdover information.

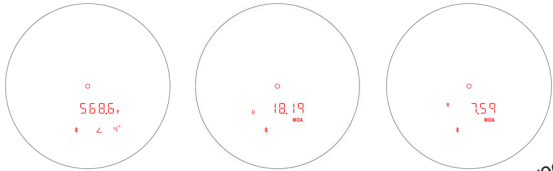

Line of Sight (LOS) range of 568.6 yards at 4 degrees incline



Example: LOS range = 568.6 yards with 0.308 Barnes  
Elevation adjustment = 18.19 MOA Up  
Windage adjustment = 7.59 MOA Right

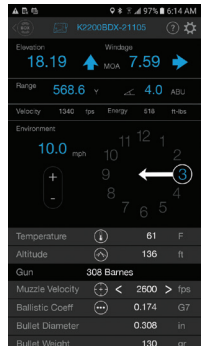

## **MODES OF OPERATION - ANGLE MODIFIED RANGE (AMR) AND LINE OF SIGHT (LOS)**

Angle modified range is the equivalent horizontal range to the target and is comparable to the “horizontal leg” of a triangle. AMR is also known as “rifleman’s rule” and uses the LOS range and angle of incline to calculate the horizontal distance the projectile travels between shooter and target. AMR is very accurate for shorter distances (i.e. < 400 yards) and archery.

Line of sight is the range to the target independent of angle. It is comparable to the “hypotenuse” of a triangle. When ranging in LOS mode, the distance is displayed in addition to the angle of incline. This method is preferred for those long range shooters and hunters wanting to use the LOS range and angle of incline to calculate a very precise holdover using a ballistic calculator smartphone application and/or wind measurement device.

For example, if the rangefinder is in LOS mode the line of sight range of 500 yards would be displayed along with the angle of -30 (degrees decline). Use LOS in combination with a ballistic calculator to calculate an exact holdover in minutes of angle or milliradians.

If the rangefinder is in AMR mode the angle modified range of 433.0 yards would be displayed. This is the equivalent horizontal range and can be used in combination with a ballistic / holdover reticle or with the SIG Ballistic Turret SBT™ dial.

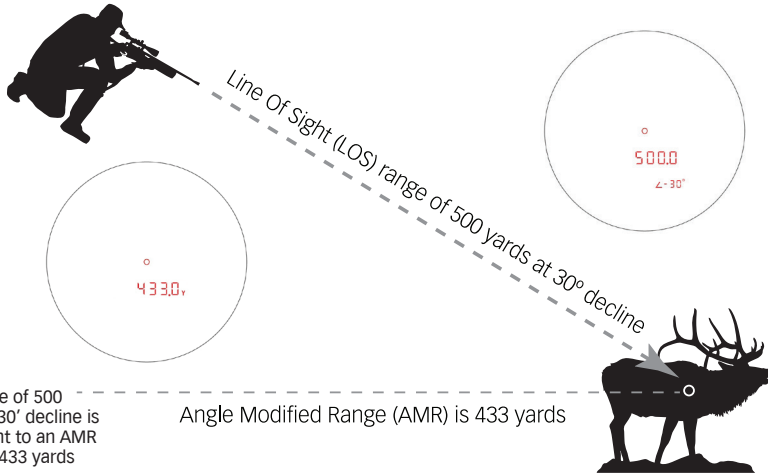

Example:  
LOS range of 500  
yards at 30' decline is  
equivalent to an AMR  
range of 433 yards

## LUMATIC™ OLED DISPLAY

The KILO1600BDX™ has the most advanced display on the market. Our transparent OLED display has the largest dynamic range providing for high brightness in bright sunlight or snow conditions, yet will dim down to near night vision levels at dusk and dawn. No other display offers this adaptive ability to prevent your pupil from constricting in low light causing you to no longer be able to see your target. A small, ambient light sensor (ALS) is located in the objective of the rangefinder and samples the ambient light condition of the target image. The ALS samples and updates the brightness instantaneously to always provide the right amount of contrast against your target image.



Display in Bright Light



Display in Dark Light

## TRANSPARENT ORGANIC LIGHT EMITTING DIODE DISPLAY (T-OLED)

The KILO1600BDX™ rangefinder features a T-OLED display for superior performance in any ambient light environment.

- A – Circle center aiming feature
- B – Holdover Directional indicators (Up, Down, Left or Right)
- C – Target Selection: BEST or LAST target
- D – Low Energy Bluetooth indicator (on with ABU)
- E – Battery Status indicator
- F – Angle of incline / decline
- G – Mode Selection: LOS, AMR, ABU
- H – Holdover Unit of Measure: MOA, MIL or IN (on with ABU)
- I – Range Unit of Measure: Y or M
- J – 5 Character alphanumeric digits for range and holdover information

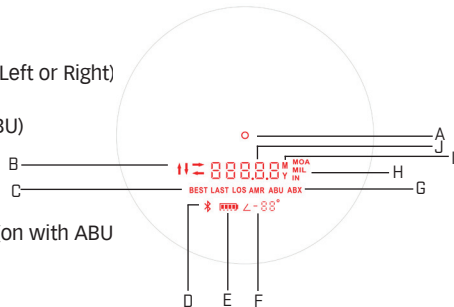

**! WARNING**

**Safety and Operation Procedures**

The KILO is classified as a Class 3R.

- Do not press the RANGE button while aiming at the human eye or while looking into the transmitting optics on the objective side.
- Do not leave the KILO within reach of small children.
- Do not take the product apart or modify the product in any way to expose internal electronics that might cause damage or electric shock.
- Do not use any other power source other than a CR2 battery or equivalent.



## OPERATION

The KILO1600BDX is designed to get you up and running without the typical complexity of buried menus and programming modes. The rangefinders come out of box in the following configuration and can also be configured with the free BDX App:

- (a) Angle Modified Range (equivalent horizontal range)
- (b) Best Target (rangefinder returns the best or most likely target, not the first or last)
- (c) Illumination control (AUTO)
- (d) Units of Measure in Yards

## SET UP

### Installing the Battery

Remove the battery cap by turning the cap in a counter-clockwise direction. Insert (1) CR2 Primary Lithium battery (-) terminal side first. The (+) terminal should be facing out. Place the cap onto the (+) battery terminal and reinstall the battery cap by turning the cap in the clockwise direction.

**⚠ CAUTION** - Be careful to not cross-thread the cap.

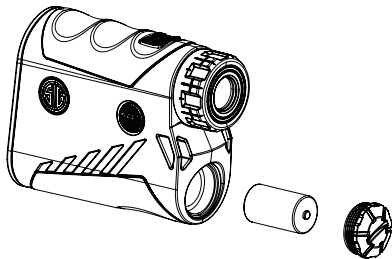

After installation of the battery and depressing the RANGE button, the status of the rangefinder is displayed:

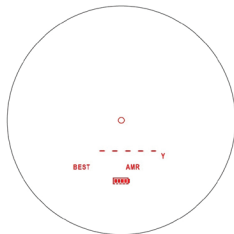

### Installing the Lanyard

Install the lanyard loop through the lanyard attachment point. Pass the lanyard back through the loop for secure attachment.

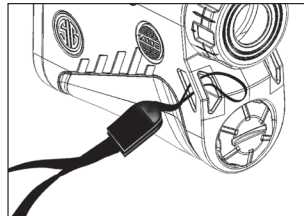

## Diopter Adjustment

The diopter or focus adjustment is integral to the eyecup. The focus adjustment is used to bring the display into sharp focus along with the target image. The diopter adjustment can turn clockwise or counter-clockwise depending upon the user's prescription

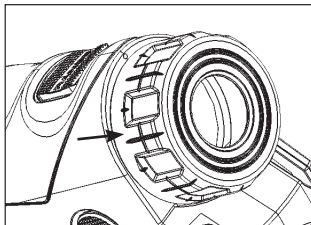

## DISPLAY INFORMATION

The display shows you the center aiming circle, the unit of measure (Y), Angle Modified Range mode (AMR) and the remaining battery status. The display will remain active for up to 30 seconds , or whatever timeout has been set within in the SIG BDX App. You can then press the RANGE button to determine range to target.

If you press the RANGE button while the rangefinder is off and continue to hold the RANGE button down, the rangefinder will automatically switch into SCAN mode within 1 second.

After determining the distance to the target, the rangefinder will continue to display the center aiming circle and range data for 30 seconds – and only the range data. All other information is not shown after initial wakeup to prevent clutter in the field of view.



**Display at initial wakeup**



**Display when ranging**

## HyperScan MODE

While the rangefinders support single button push ranging operation, it is highly recommended that you push and hold the RANGE button down to activate HyperScan mode. This mode allows you to scan targets at 4X/second which significantly improves ranging performance at extreme distances. As the ranging distances are updated very quickly in HyperScan mode, once you release the RANGE button the last acquired distance will be displayed. When in HyperScan mode ranging distant targets, the display may update between no result and a distant range - by using RangeLock technology the rangefinder will report the last range result when the RANGE button is released.

## CHANGING MODES OF OPERATION

The rangefinder ships with the most common modes already configured. However, you can access and change the following features:

- Line of Sight (LOS), Angle Modified Range (AMR) or Applied Ballistics Ultralight (ABU)
- Best or Last Target
- Display Brightness (AUTO + 3 Low, 3 Medium and 3 High)
- Units of Measure (Y or M)

## RANGEFINDER CONFIGURATION – PROGRAMMING SEQUENCE

**Note – the rangefinder can more easily be programmed and configured by using the free Sig BDX App.**

### 1. Mode Selection (AMR, LOS or ABU)

To enter programming mode, press and release the RANGE button to wakeup the rangefinder. Once the display is visible, press and hold the MODE button for 2 seconds – then release the MODE button and the current selection will be flashing (AMR is the default setting). You can switch between AMR, LOS or ABU by pressing and releasing the RANGE button. Confirm your selection by pressing and releasing the MODE button which will save your setting and index to the next setting for configuration. If you do not press and release the MODE button the rangefinder will save your selection and turn off. If the user intends to use a calculated ballistic solution, the rangefinder must be in ABU mode. Instructions for downloading and configuring the BDX App on your smartphone will

be detailed later in the instructions.

## **2. Target Selection (BEST or LAST)**

BEST or LAST should be flashing (BEST is the default setting). You can toggle between BEST or LAST by pressing and releasing the RANGE button. Confirm your selection by pressing and releasing the MODE button which will save your setting and index to the next setting for configuration. If you do not press and release the MODE button the rangefinder will save your selection and turn off. BEST Target can be used for most situations, however, when hunting through foliage or in high grass the LAST Target is recommended.

## **3. Display Brightness**

Display Brightness (Lumatic OLED Display) – AUTO will be used in most cases which leverages the ambient light sensor located in the objective of the rangefinder. This sensor samples the ambient light conditions and automatically adjusts the display to the local environment. You can change this to 9 individual settings: LOW 1 – 3, MED 1-3 and HI 1-3. Note – if you accidentally leave the unit on Setting LOW 1 you may not be able to see the display. If this occurs, go into a dark environment and



change the illumination setting.

#### **4. Unit of Measure Selection (Y or M)**

Your current selection will be flashing (Yards is default). You can toggle between Y or M by pressing and releasing the RANGE button. Confirm your selection by pressing and releasing the MODE button which will save your setting and index to the next setting for configuration. If you do not press and release the MODE button the rangefinder will save your selection and turn off.

## DIGITAL BALLISTICS XCHANGE – DOWNLOADING AND CONFIGURING THE FREE BDX APP

In this section you will download the BDX App, pair the App with your KILO and create a custom bullet profile.

### 1. Turn Bluetooth on

Check in Settings on your Android or iOS device to make sure that Bluetooth is on. If Bluetooth is off, switch it on.

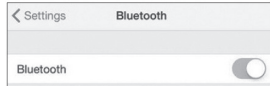
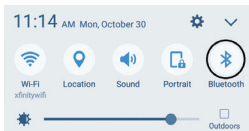
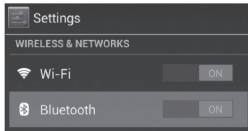

## 2. Download the BDX App from the App Store / Google Play Store

Go to the App Store or the Google Play store and download the SIG SAUER BDX App. Search for the



word SIG SAUER or BDX.

### 3. Launch the free SIG SAUER BDX App and Pair with your KILO (Enter your PIN code)

On your smartphone, open the BDX App, click on PAIRING, turn on your KILO by pressing and releasing the RANGE button and then press "Scan for Devices" on the App. Your KILO should be listed below the KILO icon and "Select Device". Your rangefinder ID should be listed in white letters.

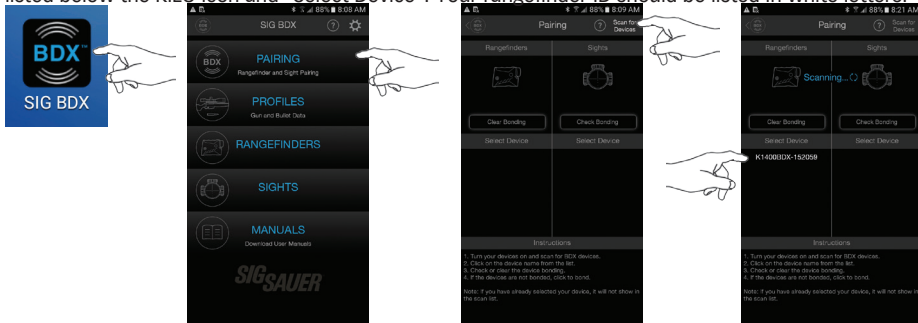

Make sure your KILO stays on during the pairing process by periodically pressing and releasing the RANGE button. You will be prompted to look through your KILO for a PIN number. Type this PIN number into the open dialogue box within the App. The PIN in your KILO and the PIN entered on your smartphone must match. Press OK to complete the pairing operation. You will now see your KILO ID in blue listed below the KILO icon. You can now exit this screen. If you enter the incorrect PIN code you can restart this process over again. If you encounter any problems during this process close your

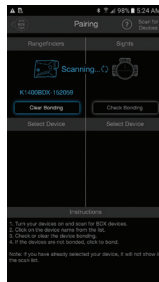
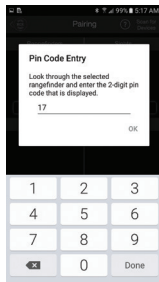
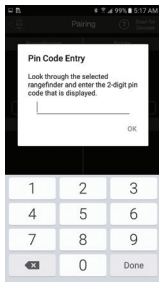

Touch the ID in white. (continued on next page)

### 3a. Updating your KILO to the latest software during Pairing

You may be prompted to update the software on your KILO. These software updates are mandatory and allow Sig Sauer to ensure that your BDX App and KILO perform optimally. Most updates take less than 1 minute. Ensure that your KILO is turned on and that your smartphone has at least 25% battery life remaining before installing any software updates. For best operation be sure to keep your smartphone a

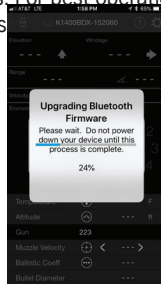
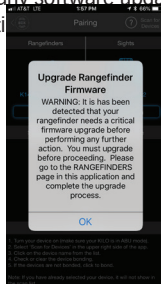
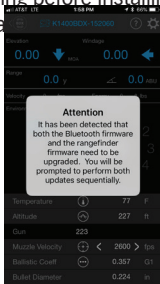

App and let the KILO time out; restart the process over.

#### 4. Configure up to 25 custom bullet profiles

The BDX App allows you to create and modify up to 25 profiles. From the home screen of the App touch PROFILES. Only one profile can be active at any time and is denoted by the BDX Icon in blue to the right of the screen. The BDX App comes with one default 0.308 profile. You can edit this profile by touching "Profile 1" or create a new one by touching the "New Profile" in the upper right corner of the App. Next, touch LIBRARY then select a caliber and bullet manufacturer. On the Gun Profiles

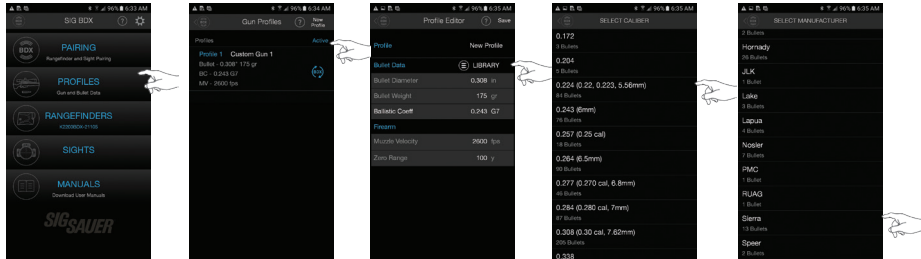

page you can rename the profile by touching on the “Custom Gun 1” and typing in a new name.

After selecting a bullet manufacturer, select the actual bullet you intend to use. Once selected you will return to the Gun Profile page where you will need to click on the sync icon to the right to activate this profile. In this example the new profile is called “.223 Sierra” – be sure to activate this profile.

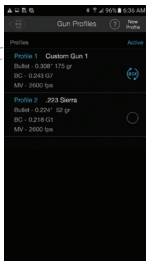
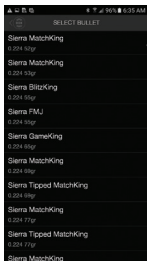



## RANGEFINDER HEADS-UP DISPLAY (HUD)

From the home screen of your BDX App select RANGEFINDERS to display the HUD. The HUD displays all range, environmental and ballistic information and allows you to configure your KILO.

### KILO ID and Status

Grey = disconnected / Blue = connected

Back to Home Screen		Help and Settings menu
Elevation data		Windage data
Range to target and unit of measure		Angle of include and Mode of Operation
Bullet velocity at target range		Bullet energy at target range
Wind speed		Wind direction
Ambient temperature		Local altitude
Active gun profile		Muzzle velocity and MV Calibration
Ballistic coefficient		Bullet diameter
Bullet weight		

## KILO SETTINGS

From the Settings menu you can fully configure the following:

1. Rangefinder Mode (AMR, LOS or ABU)
2. Target Mode (BEST or LAST)
3. Display Brightness (AUTO or 1 – 9 manual)
4. Range Units (Yards or Meters)
5. Sleep Time (30, 60, 120 or 180 seconds)
6. Sight Units (MOA or MIL)

You can toggle all fields by simply touching the letters in white. Your KILO must be turned on and paired. To save your settings touch the BDX icon in the upper left corner of the display. This will save your settings. You can also access the help menu by clicking on the “?” icon in the upper right of the screen.

Note – The KILO will not range when the Settings menu is open and active.

Note – The rangefinder must be in ABU mode to calculate Real time ballistic solutions and send them to the SIG BDX Riflescope with Bluetooth.

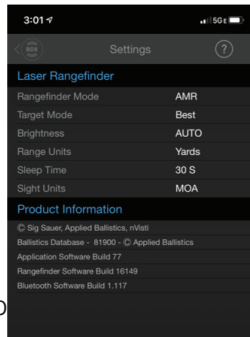

## TEMPERATURE AND ALTITUDE

Once your KILO is paired and actively synced with your smartphone, when you enter the RANGEFINDER HUD screen your smartphone will automatically pull the local temperature and altitude from the closest weather station. If you are not in cell range you can manually update both temperature and altitude by touching on the white numbers in each field and manually updating these environmental conditions.

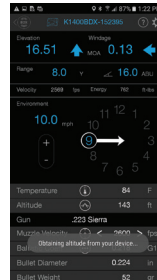
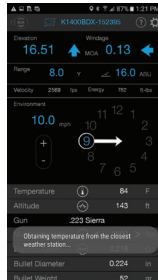
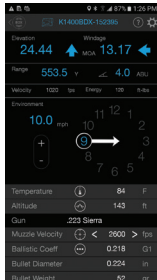

## MUZZLE VELOCITY (MV) CALIBRATION

The most important input for calculating accurate Applied Ballistics solutions is getting your MV correct. You need to either chronograph your firearm or use the embedded MV Calibration routine built into the BDX App. To use the MV Calibration routine make sure your scope is zeroed (i.e. at 100 yards) and verify that the BDX App is showing zero holdover values at the zero distance by ranging the target at the zero range and verifying the your holds are in fact zero

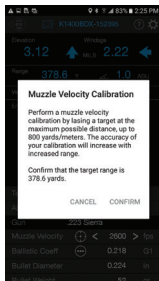

Use the MV Calibration routine at the farthest distance you intend to shoot. The greater the distance the more accurate the MV calculation will be. In this example the target was at 378 yards. Confirm your max target range.

Note – ABU only provides ballistic solutions out to 800 yards maximum.

## MUZZLE VELOCITY (MV) CALIBRATION (continued)

After performing a 3 shot group, note if your point of impact was high or low relative to your point of aim. If your group was high, select High. If low, select Low. If POA = POI, then cancel the muzzle calibration. If your group was high or low, then select the unit of offset in MILS, MOA, Inches or Centimeters and finally input the amount of offset or miss.

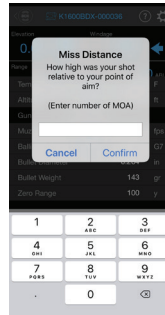
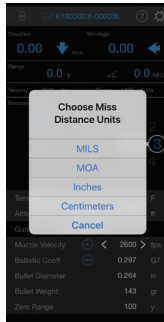
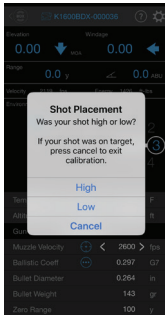

## MUZZLE VELOCITY (MV) CALIBRATION (continued)

After entering the amount of offset the app will calculate a new MV. Confirm the calculated (calibrated) MV and the new MV value will be saved in your bullet profile. In this example the miss was high by 4 inches which computed to an MV of 2799 fps.

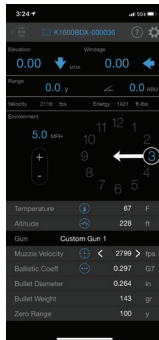
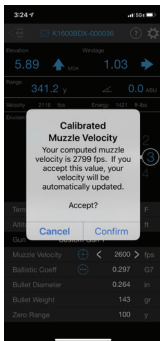

## CONFIGURING GLOBAL SETTINGS IN THE BDX APP

From the Home Screen of the BDX App you can configure Global Settings. Any field that is in white can be changed by touching on the unit of measure and toggling between two values. The help menu is available to assist you. Global Settings include:

1. Range Unit (Y, M)
2. Wind Speed Unit (mph, m/s, kph)
3. Muzzle Velocity Unit (fps, m/s)
4. Bullet Diameter Unit (inches, cm)
5. Bullet Weight Unit (grains, grams)
6. Temperature Units (F / C)
7. Altitude Units (feet, meters)
8. Sight Units (MOA, MILS)
9. Clear Saved Device List
10. BDX Offers and More

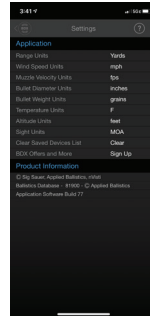
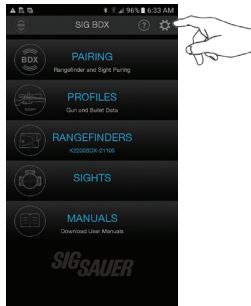

## FREQUENTLY ASKED QUESTIONS (FAQ):

**Q: I can't get the display to focus.**

A: You need to adjust the diopter ring to your vision. Rotate the eyecup / diopter ring in either direction until the display comes into sharp focus.

**Q: I can't seem to range very far past trees or animals.**

A: Your KILO will perform differently based on changes in ambient conditions such as bright sunlight or snow, rain or fog, temperature and the reflectivity of the target being ranged. For example, at dusk and dawn your rangefinder may be able to range trees at over 1000 yards but in bright sunlight may only achieve 500 yards. If your KILO will not range at least 400 yards under normal conditions (fog and rain excluded) please contact customer service. Your product may have fallen out of alignment.

**Q: I can't get my KILO to pair with the BDX App on my smartphone.**

A: Delete the BDX App from your smartphone. Download and reinstall on your phone. Make sure you have a fresh battery in your KILO. Relaunch the App, turn on your KILO and repeat the Pairing instructions in this manual.



**Q: I can't locate the BDX App on the Apple or Android Stores.**

A: Search for Sig Sauer or BDX at the store.

**Q: My battery drains too fast.**

A: Most rangefinders will provide over 4000 individual range calculations using a fresh CR2 primary lithium battery. Your KILO exceeds this specification. When heavily using SCAN mode the battery may appear to drain faster since your KILO is ranging 4x per second in HyperScan mode. This is normal operation but you should keep a spare CR2 battery when heading out to remote locations.

**Q: My ballistic solution in the HUD and displayed in the KILO is always off a few inches.**

A: For accurate ballistic solutions make sure you have updated the temperature and altitude within the App to your current location, you have the correct bullet caliber (diameter) and weight selected, your zero distance is correct and that your muzzle velocity is correct. Using the MV Calibration routine provides the most accurate MV and will improve the accuracy of the ballistic calculator. It is always best to use the MV Calibration routine at the farthest distance you intend to shoot. Calibrating at 500 yards will yield a better MV than calibrating at 200 yards.

**Q: My blue LED on the power selector ring on my SIERRA3 will not turn on.**

A: Look through our SIERRA3. You most likely have the Digital Ballistic Reticle turned on. Go into your BDX App, select the SIGHTS page and turn the Ballistic Reticle OFF.

## KILO1600BDX™ 6x22 mm SPECIFICATIONS

<b>Magnification</b>	6x		
<b>Objective Clear Aperture</b>	22 mm		
<b>Exit Pupil</b>	3.7 mm		
<b>Eye Relief</b>	17 mm		
<b>Angular (FOV)</b>	6°		
<b>FOV @ 100yds</b>	34.18 ft		
<b>Laser Divergence</b>	4.00 x 0.2 MRAD		
<b>Range Response Time</b>	.25 sec		
<b>Scanning</b>	Yes		
<b>Range Resolution Under 100 yds</b>	.1 yds		
<b>Max Range</b>	Reflective up to 2,000 yds	Trees up to 1,200 yds	Deer up to 1,000 yds
<b>Weight with Battery</b>	5 oz / 140 g		

 **WARNING**



**WARNING:** CANCER AND REPRODUCTIVE HARM

[www.P65Warnings.ca.gov](http://www.P65Warnings.ca.gov)

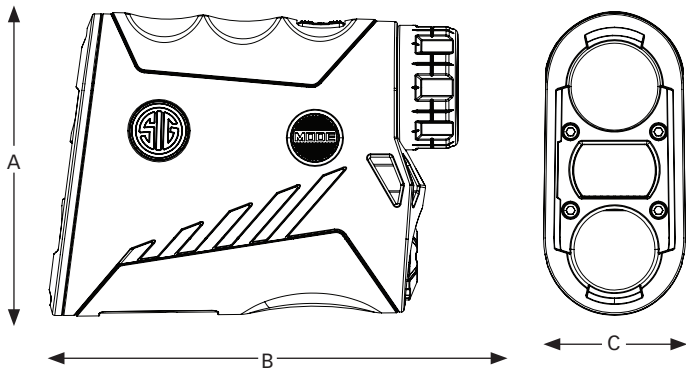

A – 3 in / 76 mm  
B – 4.3 in / 109 mm  
C – 1.4 in / 36 mm

**! DANGER****CLASS 3R LASER PRODUCT INVISIBLE LASER RADIATION - AVOID DIRECT EYE EXPOSURE**

Complies with FDA performance standards for laser products except for conformance with IEC 60825-1 Ed.3., as described in Laser Notice 56, dated May 8, 2019.

$P_o < 23W, \lambda = 905 \text{ nm}, t = 22 \text{ ns}$



This product has been tested and found to comply with the limits for a Class B digital device, pursuant to Part 15 of the FCC Rules. The equipment generates, uses and can radiate radio frequency energy and, if not installed and used in accordance with these instructions, may cause harmful interference to radio communications. However, there is no guarantee that interference will not occur in a particular installation. If this product does cause interference to radio or television reception the user is encouraged to try to correct the interference by one or more of the following:

- Reorient or relocate the receiving antenna
- Increase the separation between this product and the receiver
- Connect the equipment to an alternative outlet or receiver
- Consult a technician.

Shielded interference cable must be used with the equipment in order to comply with the limits for a digital device pursuant to Subpart B of Part 15 of FCC Rules.

Specifications and designs are subject to change without any notice or obligation on the part of the



Use of controls or adjustments or performance of procedures other than those specified herein may result in hazardous radiation exposure. Changes or modifications not expressly approved by the party responsible for compliance could void the user's authority to operate the equipment.



# LASER APERTURE

## FCC STATEMENT:

This device complies with Part 15 of the FCC rules.

Operation is subject to the following two conditions:

- This device may not cause harmful interference, and
- This device must accept any interference received, including interference that may cause undesired operation.

Changes or modifications not expressly approved by the party responsible for compliance could void your authority to operate the equipment.

### NOTE:

This equipment has been tested and found to comply with the limits for a Class B digital device, pursuant to Part 15

of the FCC Rules. These limits are designed to provide reasonable protection against harmful interference in a residential installation.

This equipment generates uses and can radiate radio frequency energy and, if not installed and used in accordance with the instructions, may cause harmful interference to radio communications. However, there is no guarantee that interference will not occur in a particular installation. If this equipment does cause harmful interference to radio or television reception, which can be determined by turning the equipment off and on, the user is encouraged to try to correct the interference by one or more of the following measures:

- Reorient or relocate the receiving antenna.
- Increase the separation between the equipment and

receiver.

- Connect the equipment into an outlet on a circuit different from that to which the receiver is connected.
- Consult the dealer or an experienced radio/TV technician for help.

## **INDUSTRY CANADA:**

This device contains licence-exempt transmitter(s)/receiver(s) that comply with Innovation, Science and Economic Development Canada's licence-exempt RSS(s). Operation is subject to the following two conditions:

- This device may not cause interference, and
- This device must accept any interference, including interference that may cause undesired operation of the device.

Ce dispositif contient un (S) émetteur (S)/ récepteur (S) exempté (S) de licence L'innovation, la Science et l'économie RSS(S) exempté (S) de licence de développement Canada.L'exploitation est Sous réserve des deux conditions suivantes:

- l'appareil ne doit pas produire de brouillage, et
- l'utilisateur de l'appareil doit accepter tout brouillage radio électrique subi, même si le brouillage est susceptible d'en compromettre le fonctionnement

The device meets the exemption from the routine evaluation limits in section 2.5 of RSS 102 and compliance with RSS-102 RF exposure, users can obtain Canadian information on RF exposure and compliance.





## **SIG SAUER Electro-Optics Infinite Guarantee™**

SIG SAUER has manufactured the most rugged, dependable high-performance firearms for over two centuries. Our heritage of design, engineering and precision-manufactured quality predates the existence of any other optics company worldwide. We understand the importance of quality in the line of fire, at the shooting range or on your next hunt. SIG SAUER Electro-Optics had to earn the right to wear that badge and the Infinite Guarantee has your back, forever. Period.

We will repair or replace your SIG SAUER product in the event it becomes damaged or defective, at no charge to you. If we cannot repair your product, we will replace it with a product in perfect working order of equal or better physical condition. It doesn't matter how it happened, whose fault it was, or where you purchased it.

### **SIG SAUER Infinite Guarantee™**

- Unlimited Lifetime Guarantee
- Fully Transferable
- No Warranty Card Required
- No Receipt Required
- No Time Limit Applies
- No Charge

If you ever have a problem, no matter the cause, we promise to take care of you when it counts. Please note that our Infinite Guarantee does not provide coverage for intentional damage, misuse, cosmetic damage that does not affect the performance of the optic, loss, theft or unauthorized repair or modification. Excludes electronic components.



### **SIG SAUER Electronic & Tritium Component Limited 5-Year Warranty**

For components not included under the SIG SAUER® Infinite Guarantee™, this warranty covers any defects in materials and workmanship in the electronic and Tritium components of illuminated riflescopes/sights, pistol sights, electronic sights, flashlights, lasers, binoculars, spotting scopes, and rangefinders. This warranty lasts for five years from the date of manufacture. If, during that five-year period, these products are found to have electronic or Tritium component defects in materials or workmanship, SIG SAUER will repair your product, at no charge to you. If we cannot repair your product, we will replace it with a product in perfect working order of equal or better physical condition.



**FOR PRODUCT SERVICE ON THIS MODEL, PLEASE CALL 603-610-3000**

27100 SW Parkway Avenue, Wilsonville, Oregon 97070 USA