



SAR TEST REPORT

For

WHOOOP INTERNATIONAL TRADING LIMITED

10.1 inch Quad Core 4G Tablet PC

Test Model:R10

Prepared for : WHOOP INTERNATIONAL TRADING LIMITED
Address : Flat-B 8/F Chong Gming Building 72 Cheung Sha Wan Road, Kowloon, Hong Kong

Prepared by : Shenzhen LCS Compliance Testing Laboratory Ltd.
Address : 101, 201 Bldg A & 301 Bldg C, Juji Industrial Park Yabianxueziwei, Shajing Street, Baoan District, Shenzhen, 518000, China

Date of receipt of test sample : Nov. 09, 2023
Number of tested samples : 1
Sample number : A231129057-1
Serial number : Prototype
Date of Test : Nov 13, 2023~ Nov 21, 2023
Date of Report : Dec 04, 2023





SAR TEST REPORT

Report Reference No.....:	LCSA11293034E
Date Of Issue.....:	Dec 04, 2023
Testing Laboratory Name	Shenzhen LCS Compliance Testing Laboratory Ltd.
Address.....:	101, 201 Bldg A & 301 Bldg C, Juji Industrial Park Yabianxueziwei, Shajing Street, Baoan District, Shenzhen, 518000, China
Testing Location/ Procedure	Full application of Harmonised standards <input checked="" type="checkbox"/> Partial application of Harmonised standards <input type="checkbox"/> Other standard testing method <input type="checkbox"/>
Applicant's Name.....:	WHOOP INTERNATIONAL TRADING LIMITED
Address.....:	Flat-B 8/F Chong Gming Building 72 Cheung Sha Wan Road, Kowloon, Hong Kong
Test Specification:	
Standard.....:	IEEE Std C95.1, 2019/IEEE Std 1528™-2013/FCC Part 2.1093
Test Report Form No.:	LCSEMC-1.0
TRF Originator.....:	Shenzhen LCS Compliance Testing Laboratory Ltd.
Master TRF	Dated 2011-03
Shenzhen LCS Compliance Testing Laboratory Ltd. All rights reserved.	
This publication may be reproduced in whole or in part for non-commercial purposes as long as the Shenzhen LCS Compliance Testing Laboratory Ltd. is acknowledged as copyright owner and source of the material. Shenzhen LCS Compliance Testing Laboratory Ltd. takes no responsibility for and will not assume liability for damages resulting from the reader's interpretation of the reproduced material due to its placement and context.	
Test Item Description.....:	10.1 inch Quad Core 4G Tablet PC
Trade Mark.....:	ROVER
Test Model	R10
Operation Frequency.....:	GSM 850/PCS1900,WCDMA Band II/V/IV; LTE Band 2/4/5/12/66; WLAN2.4G, WLAN5.2G,WLAN5.3G,WLAN5.6G,WLAN5.8G Bluetooth5.0
Ratings	Rated Voltage:3.8V Charge Limit Voltage:4.35 V Capacity: 5100mAh
Result	Positive

Compiled by:

Supervised by:

Approved by:

Jayzhan

Cary Luo

Gavin Liang

Jay Zhan / File administrators

Cary Luo / Technique principal

Gavin Liang / Manager





SAR -- TEST REPORT

Test Report No. : LCSA11293034E

Dec 04, 2023
Date of issue

Type / Model.....	: R10
EUT.....	: 10.1 inch Quad Core 4G Tablet PC
Applicant	: WHOOP INTERNATIONAL TRADING LIMITED
Address.....	: Flat-B 8/F Chong Gming Building 72 Cheung Sha Wan Road, Kowloon, Hong Kong
Telephone.....	: /
Fax.....	: /
Manufacturer	: Shenzhen Teleone Technology Co.,Ltd
Address.....	: Tower B 5/F, Shanshui Building, Nanshan Yungu Innovation Industry Park, 4093 Liuxian Avenue, Shenzhen, China
Telephone.....	: /
Fax.....	: /
Factory	: /
Address.....	: /
Telephone.....	: /
Fax.....	: /

Test Result	Positive
--------------------	-----------------

The test report merely corresponds to the test sample.
It is not permitted to copy extracts of these test result without the written permission of the test laboratory.





Revision History

Revision	Issue Date	Revision Content	Revised By
000	Dec 04, 2023	Initial Issue	---





TABLE OF CONTENTS

- 1. TEST STANDARDS AND TEST DESCRIPTION.....6**
 - 1.1. TEST STANDARDS6
 - 1.2. TEST DESCRIPTION6
 - 1.3. GENERAL REMARKS6
 - 1.4. PRODUCT DESCRIPTION6
 - 1.5. STATEMENT OF COMPLIANCE9
- 2. TEST ENVIRONMENT10**
 - 2.1. TEST FACILITY10
 - 2.2. ENVIRONMENTAL CONDITIONS10
 - 2.3. SAR LIMITS10
 - 2.4. EQUIPMENTS USED DURING THE TEST11
- 3. SAR MEASUREMENTS SYSTEM CONFIGURATION12**
 - 3.1. SAR MEASUREMENT SET-UP12
 - 3.2. OPENSAR E-FIELD PROBE SYSTEM13
 - 3.3. PHANTOMS14
 - 3.4. DEVICE HOLDER15
 - 3.5. SCANNING PROCEDURE15
 - 3.6. DATA STORAGE AND EVALUATION17
 - 3.7. POSITION OF THE WIRELESS DEVICE IN RELATION TO THE PHANTOM18
 - 3.8. TISSUE DIELECTRIC PARAMETERS FOR HEAD AND BODY PHANTOMS20
 - 3.9. TISSUE EQUIVALENT LIQUID PROPERTIES20
 - 3.10. SYSTEM CHECK21
 - 3.11. SAR MEASUREMENT PROCEDURE24
 - 3.12. POWER REDUCTION26
 - 3.13. POWER DRIFT26
- 4. TEST CONDITIONS AND RESULTS27**
 - 4.1. CONDUCTED POWER RESULTS27
 - 4.2. TRANSMIT ANTENNAS AND SAR MEASUREMENT POSITION46
 - 4.3. SAR MEASUREMENT RESULTS47
 - 4.2. SIMULTANEOUS TX SAR CONSIDERATIONS52
 - 4.4. 4.4.1 INTRODUCTION52
 - 4.5. SAR MEASUREMENT VARIABILITY55
 - 4.5. GENERAL DESCRIPTION OF TEST PROCEDURES56
 - 4.6. MEASUREMENT UNCERTAINTY (450MHZ-6GHZ)56
 - 4.7. SYSTEM CHECK RESULTS57
 - 4.8. SAR TEST GRAPH RESULTS66
- 5. CALIBRATION CERTIFICATES81**
 - 5.1. PROBE-EPG0376 CALIBRATION CERTIFICATE81
 - 5.2. SID750 DIPOLE CALIBRATION CERTIFICATE92
 - 5.3. SID835 DIPOLE CALIBRATION CERTIFICATE103
 - 5.4. SID1800 DIPOLE CALIBRATION CERTIFICATE114
 - 5.5. SID1900 DIPOLE CALIBRATION CERTIFICATE125
 - 5.6. SID2450 DIPOLE CALIBRATION CERTIFICATE136
 - 5.7. SID5-6G DIPOLE CALIBRATION CERTIFICATE147
- 6. SAR SYSTEM PHOTOGRAPHS160**
- 7. SETUP PHOTOGRAPHS161**
- 8. EUT PHOTOGRAPHS162**





1. TEST STANDARDS AND TEST DESCRIPTION

1.1. Test Standards

[IEEE Std C95.1, 2019](#): IEEE Standard for Safety Levels with Respect to Human Exposure to Electric, Magnetic, and Electromagnetic Fields, 0 Hz to 300 GHz. It specifies the maximum exposure limit of 1.6 W/kg as averaged over any 1 gram of tissue for portable devices being used within 20 cm of the user in the uncontrolled environment.

[IEEE Std 1528™-2013](#): IEEE Recommended Practice for Determining the Peak Spatial-Average Specific Absorption Rate (SAR) in the Human Head from Wireless Communications Devices: Measurement Techniques.

[FCC Part 2.1093](#): Radiofrequency Radiation Exposure Evaluation: Portable Devices

[KDB447498 D01 General RF Exposure Guidance](#) : Mobile and Portable Device RF Exposure Procedures and Equipment Authorization Policies

[KDB865664 D01 SAR Measurement 100 MHz to 6 GHz](#) : SAR Measurement Requirements for 100 MHz to 6 GHz

[KDB865664 D02 RF Exposure Reporting](#): RF Exposure Compliance Reporting and Documentation

Considerations

[KDB 616217 D04 SAR for laptop and tablets v01r02](#): SAR Evaluation procedures for umpc mini-tablet devices

[KDB248227 D01 802.11 Wi-Fi SAR](#): SAR GUIDANCE FOR IEEE 802.11 (Wi-Fi) TRANSMITTERS

1.2. Test Description

The EUT battery must be fully charged and checked periodically during the test to ascertain uniform power . And Test device is identical prototype.

1.3. General Remarks

Date of receipt of test sample	:	Nov. 09, 2023
Testing commenced on	:	Nov. 13, 2023
Testing concluded on	:	April 21, 2023

1.4. Product Description

The WHOOP INTERNATIONAL TRADING LIMITED's Model: 10.1 inch Quad Core 4G Tablet PC or the "EUT" as referred to in this report; more general information as follows, for more details, refer to the user's manual of the EUT.

General Description	
Product Name:	10.1 inch Quad Core 4G Tablet PC
Model/Type reference:	R10
Hardware Version:	J866B_610&310_D4F_V1.0
Software Version:	ROVER_R10_13_V01_20231201
Power supply:	Rated Voltage: 3.8V Charge Limit Voltage: 4.35 V Capacity: 5100mAh
<i>The EUT is 10.1 inch Quad Core 4G Tablet PC. It is equipped with GSM 850/PCS1900, WCDMA Band II/V/IV; LTE Band 2/4/5/12/66; Bluetooth, WiFi 2.4G, WiFi 5.2G, WiFi 5.3G, WiFi 5.5G, WiFi 5.8G . For more information see the following datasheet,</i>	
Technical Characteristics	
GSM	
Support Band:	<input type="checkbox"/> GSM 900 (EU-Band) <input type="checkbox"/> DCS 1800 (EU-Band) <input checked="" type="checkbox"/> GSM 850 (U.S.-Band) <input checked="" type="checkbox"/> PCS 1900 (U.S.-Band)
Release Version:	R99
GPRS Class	Class 12
EGPRS Class	Class 12
Modulation Type:	GMSK for GSM/GPRS; GMSK/8PSK for EGPRS
Antenna Description:	PIFA Antenna -1.30dBi (max.) For GSM 850 0.53dBi (max.) For PCS 1900
UMTS	





Support Band:	<input checked="" type="checkbox"/> WCDMA Band II (U.S.-Band) <input checked="" type="checkbox"/> WCDMA Band V (U.S.-Band) <input checked="" type="checkbox"/> WCDMA Band IV (U.S.-Band) <input type="checkbox"/> WCDMA Band I (EU-Band) <input type="checkbox"/> WCDMA Band VIII (EU-Band)
Release Version:	R8
Modulation Type:	QPSK,16QAM
Antenna Description:	PIFA Antenna 0.53dBi (max.) For WCDMA Band II -1.30dBi (max.) For WCDMA Band V -0.96dBi (max.) For WCDMA Band IV
LTE	
Support Band:	<input checked="" type="checkbox"/> E-UTRA Band 2(U.S.-Band) <input checked="" type="checkbox"/> E-UTRA Band 4(U.S.-Band) <input checked="" type="checkbox"/> E-UTRA Band 5(U.S.-Band) <input checked="" type="checkbox"/> E-UTRA Band 12(U.S.-Band) <input checked="" type="checkbox"/> E-UTRA Band 66(U.S.-Band)
Power Class:	Class 3
LTE Release Version:	R9
Modulation Type:	QPSK/16QAM
Antenna Description:	PIFA Antenna 0.53dBi (max.) For E-UTRA Band 2 0.96dBi (max.) For E-UTRA Band 4 -1.30dBi (max.) For E-UTRA Band 5 -2.69dBi (max.) For E-UTRA Band 12 0.96dBi (max.) For E-UTRA Band 66
Bluetooth	
Frequency Range:	2402MHz-2480MHz
Bluetooth Version:	V5.0
Bluetooth Channel Number:	79 channels for Bluetooth V5.0 (DSS) 40 channels for Bluetooth V5.0 (DTS)
Bluetooth Channel Spacing:	1MHz for Bluetooth V5.0 (DSS) 2MHz for Bluetooth V5.0 (DTS)
Bluetooth Modulation Type:	GFSK, $\pi/4$ -DQPSK, 8-DPSK for Bluetooth V5.0(DSS) GFSK for Bluetooth V5.0 (DTS)
Antenna Description:	PIFA Antenna, 1.18dBi(Max.)
2.4G WLAN	
Frequency Range:	2412 – 2462 MHz
Channel Number:	11 Channels for 20MHz bandwidth (2412~2462MHz)
Modulation Type	IEEE 802.11b: DSSS (CCK, DQPSK, DBPSK) IEEE 802.11g: OFDM (64QAM, 16QAM, QPSK, BPSK) IEEE 802.11n: OFDM (64QAM, 16QAM, QPSK, BPSK)
Channel Spacing:	5MHz
Antenna Description:	PIFA Antenna, 1.18dBi(Max.)
5.2G WLAN	
Frequency Range	5180MHz~5250MHz
Channel Number	WLAN 802.11a/n20/n40/ac20/ac40/ac80: 5150 ~ 5250 MHz
Modulation Type	IEEE 802.11a/n20/ac20/n40/ac40/ac80: : OFDM (64QAM, 16QAM, QPSK, BPSK)
Antenna Description	PIFA Antenna, 1.49dBi(Max.)
5.3G WLAN	
Frequency Range	5250 ~ 5350 MHz
Channel Number	WLAN 802.11a/n20/n40/ac20/ac40/ac80: 5250 ~ 5350 MHz
Modulation Type	IEEE 802.11a/n20/ac20/n40/ac40/ac80: OFDM (64QAM, 16QAM, QPSK, BPSK)
Antenna Description	PIFA Antenna, 1.49dBi(Max.)
5.6G WLAN	
Frequency Range	5470 ~ 5725 MHz
Channel Number	WLAN 802.11a/n20/n40/ac20/ac40/ac80: 5470 ~ 5725 MHz





Modulation Type	IEEE 802.11a/n20/ac20/n40/ac40/ac80: OFDM (64QAM, 16QAM, QPSK, BPSK)
Antenna Description	PIFA Antenna, 1.49dBi(Max.)
5.8G WLAN	
Frequency Range	5725 ~ 5850 MHz
Channel Number	WLAN 802.11a/n20/n40/ac20/ac40/ac80: 5725 ~ 5850 MHz
Modulation Type	IEEE 802.11a/n20/ac20/n40/ac40/ac80/ac160: OFDM (64QAM, 16QAM, QPSK, BPSK)
Antenna Description	PIFA Antenna, 1.49dBi(Max.)
GPS function:	Support and only RX
FM function:	Support and only RX





1.5. Statement of Compliance

The maximum of results of SAR found during testing for 10.1 inch Quad Core 4G Tablet PCare follows:

<Highest Reported standalone SAR Summary>

Classment Class	Frequency Band	Body-worn (Report SAR _{1-g} (W/kg) (Separation Distance 0mm)
		PCE
	GSM1900	0.811
	WCDMA Band II	0.435
	WCDMA Band IV	0.527
	WCDMA Band V	0.443
	LTE Band 2	0.695
	LTE Band 4	0.612
	LTE Band 5	0.278
	LTE Band 12	0.209
	LTE Band 66	0.615
DTS	WIFI2.4G	0.336
NII	WIFI 5.2G	0.196
	WIFI 5.3G	0.218
	WIFI 5.5G	0.232
	WIFI 5.8G	0.216

This device is in compliance with Specific Absorption Rate (SAR) for general population/uncontrolled exposure limits (1.6 W/kg) specified in FCC 47 CFR part 2 (2.1093) and ANSI/IEEE C95.1-2005, and had been tested in accordance with the measurement methods and procedures specified in IEEE 1528-2013.

<Highest Reported simultaneous SAR Summary>

Exposure Position	Classment Class	Body-worn (Report SAR _{1-g} (W/kg)	Highest Reported Simultaneous Transmission SAR _{1-g} (W/kg)
Body-worn (hotspot open)	PCE	0.980	1.316
	DTS	0.336	





2. TEST ENVIRONMENT

2.1. Test Facility

The test facility is recognized, certified, or accredited by the following organizations:

Site Description
SAR Lab. : NVLAP Accreditation Code is 600167-0.
FCC Designation Number is CN5024.
CAB identifier is CN0071.
CNAS Registration Number is L4595.
Test Firm Registration Number: 254912.

2.2. Environmental conditions

During the measurement the environmental conditions were within the listed ranges:

Temperature:	18-25 ° C
Humidity:	40-65 %
Atmospheric pressure:	950-1050mbar

2.3. SAR Limits

EXPOSURE LIMITS	FCC Limit (1g Tissue)	
	SAR (W/kg)	
	(General Population / Uncontrolled Exposure Environment)	(Occupational / Controlled Exposure Environment)
Spatial Average(averaged over the whole body)	0.08	0.4
Spatial Peak(averaged over any 1 g of tissue)	1.6	8.0
Spatial Peak(hands/wrists/feet/anklesaveraged over 10 g)	4.0	20.0

Population/Uncontrolled Environments are defined as locations where there is the exposure of individual who have no knowledge or control of their exposure.

Occupational/Controlled Environments are defined as locations where there is exposure that may be incurred by people who are aware of the potential for exposure (i.e. as a result of employment or occupation).





2.4. Equipments Used during the Test

Item	Equipment	Manufacturer	Model No.	Serial No.	Cal Date	Due Date
1	PC	Lenovo	G5005	MY42081102	N/A	N/A
2	SAR Measurement system	SATIMO	4014_01	SAR_4014_01	N/A	N/A
3	Signal Generator	Agilent	E4438C	MY49072627	2023-06-09	2024-06-08
4	S-parameter Network Analyzer	Agilent	8753ES	US38432944	2023-06-09	2024-06-08
5	Wideband Radio Communication Tester	R&S	CMW500	103818-1	2023-10-25	2024-10-24
6	E-Field PROBE	MVG	SSE2	SN 25/22 EPG0376	2023-06-22	2024-06-21
7	DIPOLE 750	SATIMO	SID 750	SN 30/14 DIP 0G750-302	2021-09-29	2024-09-28
8	DIPOLE 835	SATIMO	SID 835	SN 07/14 DIP 0G835-303	2021-09-29	2024-09-28
9	DIPOLE 1800	SATIMO	SID 1800	SN 07/14 DIP 1G800-301	2021-09-29	2024-09-28
10	DIPOLE 1900	SATIMO	SID 1900	SN 38/18 DIP 1G900-466	2021-09-22	2024-09-21
11	DIPOLE 2450	SATIMO	SID 2450	SN 07/14 DIP 2G450-306	2021-09-29	2024-09-28
12	DIPOLE 2600	SATIMO	SID 2600	SN 38/18 DIP 2G600-468	2021-09-22	2024-09-21
13	DIPOLE 5000-6000	MVG	SWG5500	SN 49/16 WGA 43	2021-09-22	2024-09-21
14	COMOSAR OPENCoaxial Probe	SATIMO	OCPG 68	SN 40/14 OCPG68	2023-10-25	2024-10-24
16	Communication Antenna	SATIMO	ANTA57	SN 39/14 ANTA57	2023-10-25	2024-10-24
17	FEATURE PHONEPOSITIONING DEVICE	SATIMO	MSH98	SN 40/14 MSH98	N/A	N/A
18	DUMMY PROBE	SATIMO	DP60	SN 03/14 DP60	N/A	N/A
19	SAM PHANTOM	SATIMO	SAM117	SN 40/14 SAM117	N/A	N/A
20	Liquid measurement Kit	HP	85033D	3423A03482	N/A	N/A
21	Power meter	Agilent	E4419B	MY45104493	2023-10-25	2024-10-24
22	Power meter	Agilent	E4419B	MY45100308	2023-10-25	2024-10-24
23	Power sensor	Agilent	E9301H	MY41495616	2023-10-25	2024-10-24
24	Power sensor	Agilent	E9301H	MY41495234	2023-10-25	2024-10-24
25	Directional Coupler	MCLI/USA	4426-20	03746	2023-06-09	2024-06-08

Note:

- 1) Per KDB865664D01 requirements for dipole calibration, the test laboratory has adopted three year extended calibration interval. Each measured dipole is expected to evaluate with following criteria at least on annual interval.
 - a) There is no physical damage on the dipole;
 - b) System check with specific dipole is within 10% of calibrated values;
 - c) The most recent return-loss results,measured at least annually,deviates by no more than 20% from the previous measurement;
 - d) The most recent measurement of the real or imaginary parts of the impedance, measured at least annually is within 5Ω from the previous measurement.
- 2) Network analyzer probe calibration against air, distilled water and a shorting block performed before measuring liquid parameters.



Shenzhen LCS Compliance Testing Laboratory Ltd.

Add: 101, 201 Bldg A & 301 Bldg C, Juji Industrial Park Yabianxueziwei, Shajing Street, Baoan District, Shenzhen, 518000, China

Tel: +(86) 0755-82591330 | E-mail: webmaster@lcs-cert.com | Web: www.lcs-cert.com

Scan code to check authenticity

3. SAR MEASUREMENTS SYSTEM CONFIGURATION

3.1. SAR Measurement Set-up

The OPENSAR system for performing compliance tests consist of the following items:

A standard high precision 6-axis robot (KUKA) with controller and software.

KUKA Control Panel (KCP)

A dosimetric probe, i.e., an isotropic E-field probe optimized and calibrated for usage in tissue simulating liquid. The probe is equipped with a Video Positioning System(VPS).

The stress sensor is composed with mechanical and electronic when the electronic part detects a change on the electro-mechanical switch,It sends an "Emergency signal" to the robot controller that to stop robot's moves

A computer operating Windows XP.

OPENSAR software

Remote control with teaches pendant and additional circuitry for robot safety such as warning lamps, etc.

The SAM phantom enabling testing left-hand right-hand and body usage.

The Position device for handheld EUT

Tissue simulating liquid mixed according to the given recipes .

System validation dipoles to validate the proper functioning of the system.

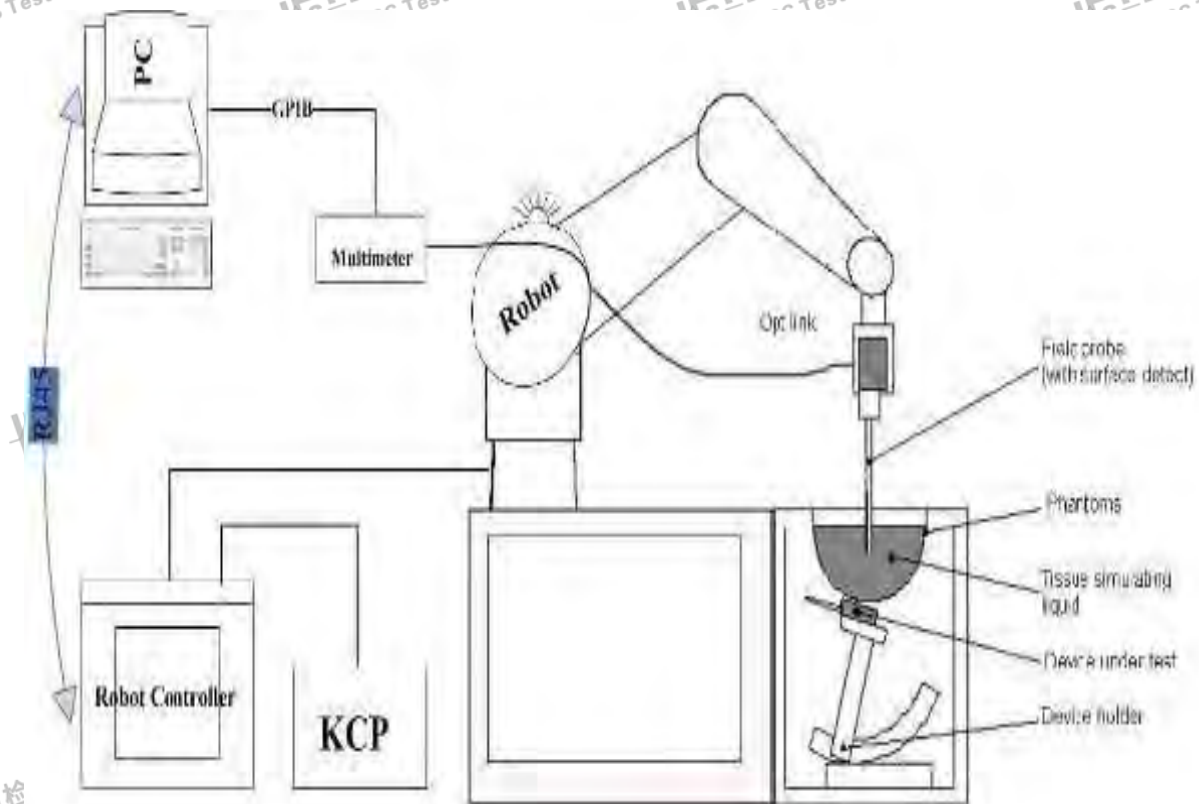



3.2. OPENSAR E-field Probe System

The SAR measurements were conducted with the dosimetric probe EPGO376(manufactured by SATIMO), designed in the classical triangular configuration and optimized for dosimetric evaluation.

Probe Specification

Construction Symmetrical design with triangular core
Interleaved sensors
Built-in shielding against static charges
PEEK enclosure material (resistant to organic solvents, e.g., DGBE)

Calibration ISO/IEC 17025 calibration service available.

Frequency	450 MHz to 6 GHz; Linearity:0.25dB(450 MHz to 6GHz)
Directivity	0.25 dB in HSL (rotation around probe axis) 0.5 dB in tissue material (rotation normal to probe axis)
Dynamic Range	0.01W/kg to > 100 W/kg; Linearity: 0.25 dB
Dimensions	Overall length: 330 mm (Tip: 16mm) Tip diameter: 5 mm (Body: 8 mm) Distance from probe tip to sensor centers: 2.5 mm
Application	General dosimetry up to 6 GHz Dosimetry in strong gradient fields Compliance tests of Mobile Phones

Isotropic E-Field Probe

The isotropic E-Field probe has been fully calibrated and assessed for isotropicity, and boundary effect within a controlled environment. Depending on the frequency for which the probe is calibrated the method utilized for calibration will change.

The E-Field probe utilizes a triangular sensor arrangement as detailed in the diagram below:



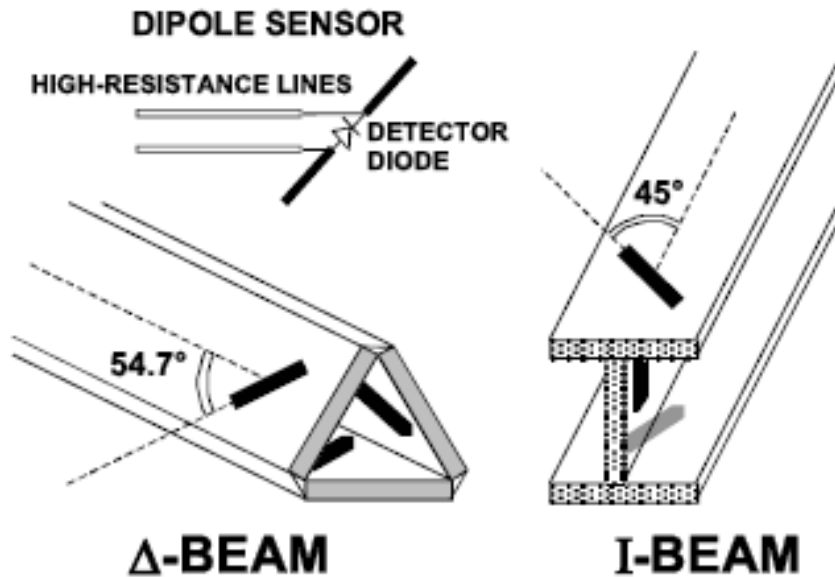

3.3. Phantoms

The SAM Phantom SAM117 is constructed of a fiberglass shell integrated in a wooden table. The shape of the shell is in compliance with the specification set in IEEE P1528 and CENELEC ER10209-1, ER10209-2:2010. The phantom enables the dosimetric evaluation of left and right hand phone usage as well as body mounted usage at the flat phantom region. A cover prevents the evaporation of the liquid. Reference markings on the Phantom allow the complete setup of all predefined phantom positions and measurement grids by manually teaching three points in the robot.

System checking was performed using the flat section, whilst Head SAR tests used the left and right head profile sections. Body SAR testing also used the flat section between the head profiles.

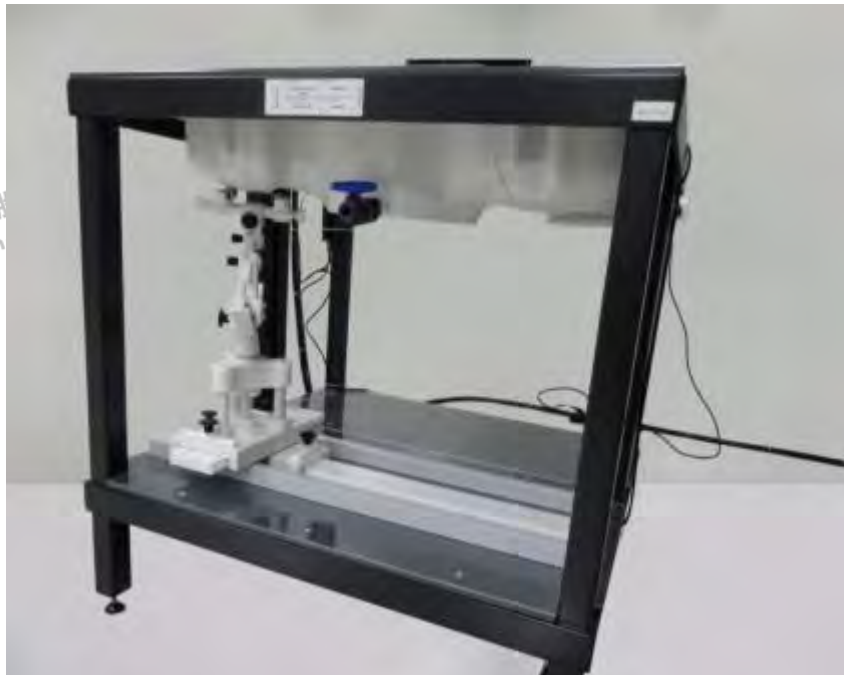

SAM Twin Phantom



3.4. Device Holder

In combination with the Generic Twin Phantom SAM117, the Mounting Device enables the rotation of the mounted transmitter in spherical coordinates whereby the rotation points is the ear opening. The devices can be easily, accurately, and repeatedly positioned according to the FCC and CENELEC specifications. The device holder can be locked at different phantom locations (left head, right head, flat phantom).



Device holder supplied by SATIMO

3.5. Scanning Procedure

The procedure for assessing the peak spatial-average SAR value consists of the following steps

Power Reference Measurement

The reference and drift jobs are useful jobs for monitoring the power drift of the device under test in the batch process. Both jobs measure the field at a specified reference position, at a selectable distance from the phantom surface. The reference position can be either the selected section's grid reference point or a user point in this section. The reference job projects the selected point onto the phantom surface, orients the probe perpendicularly to the surface, and approaches the surface using the selected detection method.

Area Scan

The Area Scan is used as a fast scan in two dimensions to find the area of high field values before running a detailed measurement around the hot spot. Before starting the area scan a grid spacing of 15 mm x 15 mm is set. During the scan the distance of the probe to the phantom remains unchanged. After finishing area scan, the field maxima within a range of 2 dB will be ascertained.

	≤ 3 GHz	> 3 GHz
Maximum distance from closest measurement point (geometric center of probe sensors) to phantom surface	5 mm ± 1 mm	$\frac{1}{2} \cdot \delta \cdot \ln(2)$ mm ± 0.5 mm
Maximum probe angle from probe axis to phantom surface normal at the measurement location	30° ± 1°	20° ± 1°
Maximum area scan spatial resolution: Δx_{Area} , Δy_{Area}	≤ 2 GHz: ≤ 15 mm 2 – 3 GHz: ≤ 12 mm	3 – 4 GHz: ≤ 12 mm 4 – 6 GHz: ≤ 10 mm
	When the x or y dimension of the test device, in the measurement plane orientation, is smaller than the above, the measurement resolution must be ≤ the corresponding x or y dimension of the test device with at least one measurement point on the test device.	





Zoom Scan

Zoom Scans are used to estimate the peak spatial SAR values within a cubic averaging volume containing 1 g and 10 g of simulated tissue. The default Zoom Scan is done by 7x7x7 points within a cube whose base is centered around the maxima found in the preceding area scan.

Maximum zoom scan spatial resolution: $\Delta x_{Zoom}, \Delta y_{Zoom}$		≤ 2 GHz: ≤ 8 mm 2 – 3 GHz: ≤ 5 mm*	3 – 4 GHz: ≤ 5 mm* 4 – 6 GHz: ≤ 4 mm*
Maximum zoom scan spatial resolution, normal to phantom surface	uniform grid: $\Delta z_{Zoom}(n)$	≤ 5 mm	3 – 4 GHz: ≤ 4 mm 4 – 5 GHz: ≤ 3 mm 5 – 6 GHz: ≤ 2 mm
	graded grid	$\Delta z_{Zoom}(1)$: between 1 st two points closest to phantom surface	≤ 4 mm
		$\Delta z_{Zoom}(n>1)$: between subsequent points	$\leq 1.5 \cdot \Delta z_{Zoom}(n-1)$ mm
Minimum zoom scan volume	x, y, z	≥ 30 mm	3 – 4 GHz: ≥ 28 mm 4 – 5 GHz: ≥ 25 mm 5 – 6 GHz: ≥ 22 mm
<p>Note: δ is the penetration depth of a plane-wave at normal incidence to the tissue medium; see IEEE Std 1528-2013 for details.</p> <p>* When zoom scan is required and the <i>reported</i> SAR from the <i>area scan based 1-g SAR estimation</i> procedures of KDB Publication 447498 is ≤ 1.4 W/kg, ≤ 8 mm, ≤ 7 mm and ≤ 5 mm zoom scan resolution may be applied, respectively, for 2 GHz to 3 GHz, 3 GHz to 4 GHz and 4 GHz to 6 GHz.</p>			





Power Drift measurement

The drift job measures the field at the same location as the most recent reference job within the same procedure, and with the same settings. The drift measurement gives the field difference in dB from the reading conducted within the last reference measurement. Several drift measurements are possible for one reference measurement. This allows a user to monitor the power drift of the device under test within a batch process. In the properties of the Drift job, the user can specify a limit for the drift and have OPENSAR software stop the measurements if this limit is exceeded.

3.6. Data Storage and Evaluation

Data Storage

The OPENSAR software stores the acquired data from the data acquisition electronics as raw data (in microvolt readings from the probe sensors), together with all necessary software parameters for the data evaluation (probe calibration data, liquid parameters and device frequency and modulation data) in measurement files. The software evaluates the desired unit and format for output each time the data is visualized or exported. This allows verification of the complete software setup even after the measurement and allows correction of incorrect parameter settings. For example, if a measurement has been performed with a wrong crest factor parameter in the device setup, the parameter can be corrected afterwards and the data can be re-evaluated.

The measured data can be visualized or exported in different units or formats, depending on the selected probe type ([V/m], [A/m], [°C], [mW/g], [mW/cm²], [dBrel], etc.). Some of these units are not available in certain situations or show meaningless results, e.g., a SAR output in a lossless media will always be zero. Raw data can also be exported to perform the evaluation with other software packages.

Data Evaluation

The OPENSAR software automatically executes the following procedures to calculate the field units from the microvolt readings at the probe connector. The parameters used in the evaluation are stored in the configuration modules of the software:

- Probe parameters: - Sensitivity Normi, ai0, ai1, ai2
- Conversion factor ConvFi
- Diode compression point Dcpi
- Device parameters: - Frequency f
- Crest factor cf
- Media parameters: - Conductivity σ
- Density ρ

These parameters must be set correctly in the software. They can be found in the component documents or they can be imported into the software from the configuration files issued for the OPENSAR components. In the direct measuring mode of the multimeter option, the parameters of the actual system setup are used. In the scan visualization and export modes, the parameters stored in the corresponding document files are used.

The first step of the evaluation is a linearization of the filtered input signal to account for the compression characteristics of the detector diode. The compensation depends on the input signal, the diode type and the DC-transmission factor from the diode to the evaluation electronics. If the exciting field is pulsed, the crest factor of the signal must be known to correctly compensate for peak power. The formula for each channel can be given as:

$$V_i = U_i + U_i^2 \cdot \frac{cf}{dcp_i}$$

- With V_i = compensated signal of channel i ($i = x, y, z$)
- U_i = input signal of channel i ($i = x, y, z$)
- cf = crest factor of exciting field
- dcp_i = diode compression point

From the compensated input signals the primary field data for each channel can be evaluated:

E – fieldprobes : $E_i = \sqrt{\frac{V_i}{Norm_i \cdot ConvF}}$

H – fieldprobes : $H_i = \sqrt{V_i \cdot \frac{a_{i0} + a_{i1}f + a_{i2}f^2}{f}}$

- With V_i = compensated signal of channel i ($i = x, y, z$)
- Norm_i = sensor sensitivity of channel i ($i = x, y, z$)



- [mV/(V/m)²] for E-field Probes
- ConvF = sensitivity enhancement in solution
- a_{ij} = sensor sensitivity factors for H-field probes
- f = carrier frequency [GHz]
- E_i = electric field strength of channel i in V/m
- H_i = magnetic field strength of channel i in A/m

The RSS value of the field components gives the total field strength (Hermitian magnitude):

$$E_{tot} = \sqrt{E_x^2 + E_y^2 + E_z^2}$$

The primary field data are used to calculate the derived field units.

$$SAR = E_{tot}^2 \cdot \frac{\sigma}{\rho \cdot 1'000}$$

with SAR = local specific absorption rate in mW/g

- E_{tot} = total field strength in V/m
- σ = conductivity in [mho/m] or [Siemens/m]
- ρ = equivalent tissue density in g/cm³

Note that the density is normally set to 1 (or 1.06), to account for actual brain density rather than the density of the simulation liquid.

3.7. Position of the wireless device in relation to the phantom

General considerations

This standard specifies two handset test positions against the head phantom – the “cheek” position and the “tilt” position.

The power flow density is calculated assuming the excitation field as a free space field

$$P_{(pwe)} = \frac{E_{tot}^2}{3770} \text{ or } P_{(pwe)} = H_{tot}^2 \cdot 37.7$$

Where P_{pwe} = Equivalent power density of a plane wave in mW/cm²

E_{tot} = total electric field strength in V/m

H_{tot} = total magnetic field strength in A/m

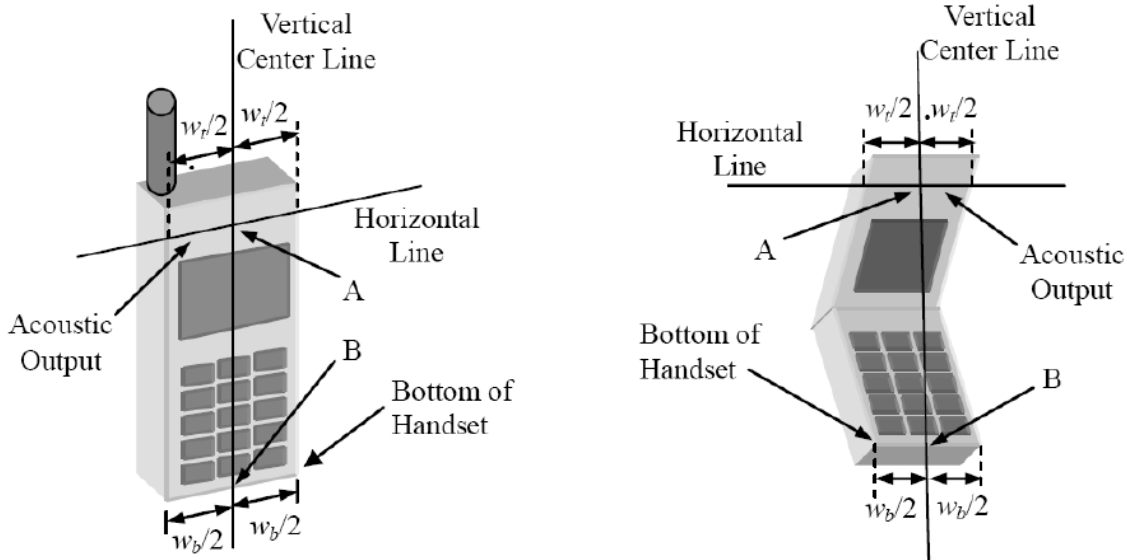

W_t Width of the handset at the level of the acoustic

W_b Width of the bottom of the handset

A Midpoint of the width w_t of the handset at the level of the acoustic output

B Midpoint of the width w_b of the bottom of the handset

Picture 1-a Typical “fixed” case handset Picture 1-b Typical “clam-shell” case handset



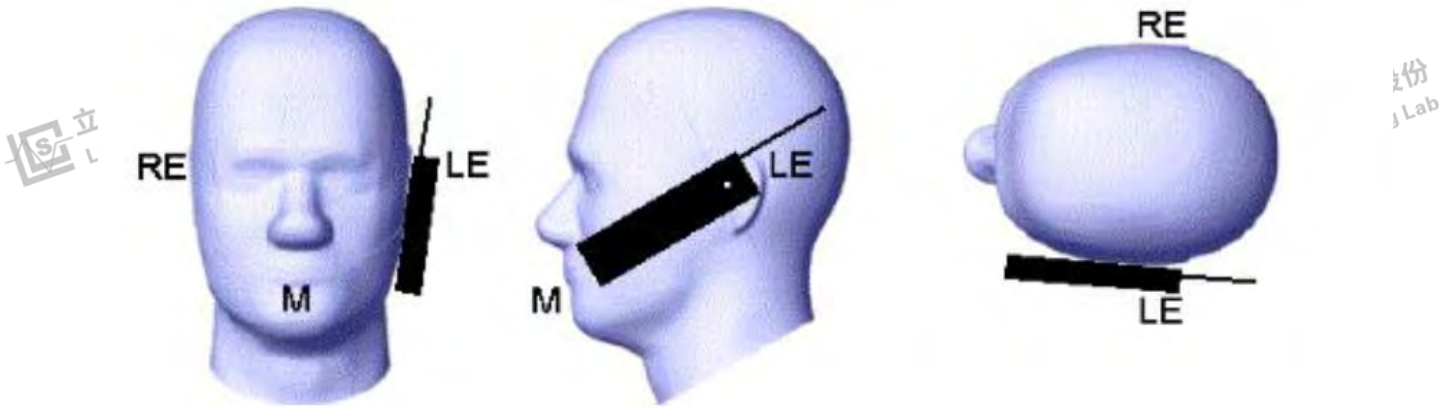

Picture 2 Cheek position of the wireless device on the left side of SAM

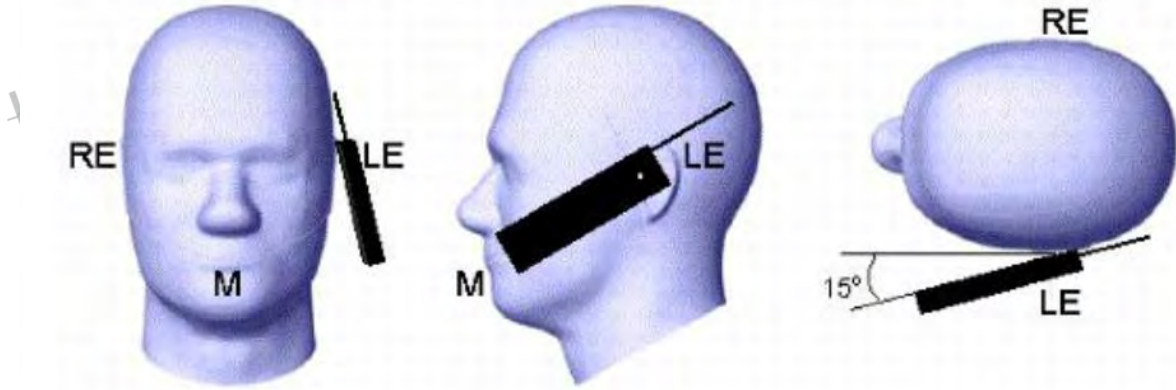

Picture 3 Tilt position of the wireless device on the left side of SAM

For body SAR test we applied to FCC KDB941225, KDB447498, KDB248227, KDB648654;





3.8. Tissue Dielectric Parameters for Head and Body Phantoms

The liquid is consisted of water, salt, Glycol, Sugar, Preventol and Cellulose. The liquid has previously been proven to be suited for worst-case. It's satisfying the latest tissue dielectric parameters requirements proposed by the KDB865664.

The composition of the tissue simulating liquid

Ingredient (% Weight)	750MHz		835MHz		1800 MHz		1900 MHz		2450MHz		2600MHz		5000MHz	
	Head	Body	Head	Body	Head	Body	Head	Body	Head	Body	Head	Body	Head	Body
Water	39.28	51.3	41.45	52.5	54.5	40.2	54.9	40.4	62.7	73.2	60.3	71.4	65.5	78.6
Preventol	0.10	0.10	0.10	0.10	0.00	0.00	0.00	0.00	0.00	0.00	0.00	0.00	0.00	0.00
HEC	1.00	1.00	1.00	1.00	0.00	0.00	0.00	0.00	0.00	0.00	0.00	0.00	0.00	0.00
DGBE	0.00	0.00	0.00	0.00	45.33	59.31	44.92	59.10	36.80	26.70	39.10	28.40	0.00	0.00
Triton X-100	0.00	0.00	0.00	0.00	0.00	0.00	0.00	0.00	0.00	0.00	0.00	0.00	17.2	10.7

Target Frequency (MHz)	Head	
	ϵ_r	σ (S/m)
450	43.5	0.87
750	41.9	0.89
835	41.5	0.90
900	41.5	0.97
1450	40.5	1.20
1640	40.2	1.31
1800	40.0	1.40
1900	40.0	1.40
2000	40.0	1.40
2450	39.2	1.80
2600	39.0	1.96
3000	38.5	2.40
5200	36.0	4.66
5300	35.9	4.76
5600	35.55	5.07
5800	35.3	5.27

3.9. Tissue equivalent liquid properties

Dielectric Performance of Head and Body Tissue Simulating Liquid

Test Engineer: Jerry hu									
Tissue Type	Measured Frequency (MHz)	Target Tissue		Measured Tissue				Liquid Temp.	Test Data
		σ	ϵ_r	σ	Dev.	ϵ_r	Dev.		
750H	750	0.89	41.9	0.87	-2.25%	41.2	-1.67%	20.1	11/13/2023
835H	835	0.9	41.5	0.94	4.44%	41.6	0.24%	20.1	11/13/2023
1800H	1800	1.4	40	1.41	0.71%	39.8	-0.50%	21.3	11/15/2023
1900H	1900	1.4	40	1.44	2.86%	40.98	2.45%	21.3	11/15/2023
2450H	2450	1.8	39.2	1.85	2.78%	38.9	-0.77%	22.1	11/17/2023
5200H	5200	4.66	36	4.88	4.72%	35.4	-1.67%	22.4	11/21/2023
5300H	5300	4.76	35.9	4.71	-1.05%	34.8	-3.06%	22.4	11/21/2023
5600H	5600	5.07	35.55	4.95	-2.37%	34.7	-2.39%	22.4	11/21/2023
5800H	5800	5.27	35.3	5.41	2.66%	35.9	1.70%	22.4	11/21/2023



3.10. System Check

The purpose of the system check is to verify that the system operates within its specifications at the device test frequency. The system check is simple check of repeatability to make sure that the system works correctly at the time of the compliance test;

System check results have to be equal or near the values determined during dipole calibration with the relevant liquids and test system ($\pm 10\%$).

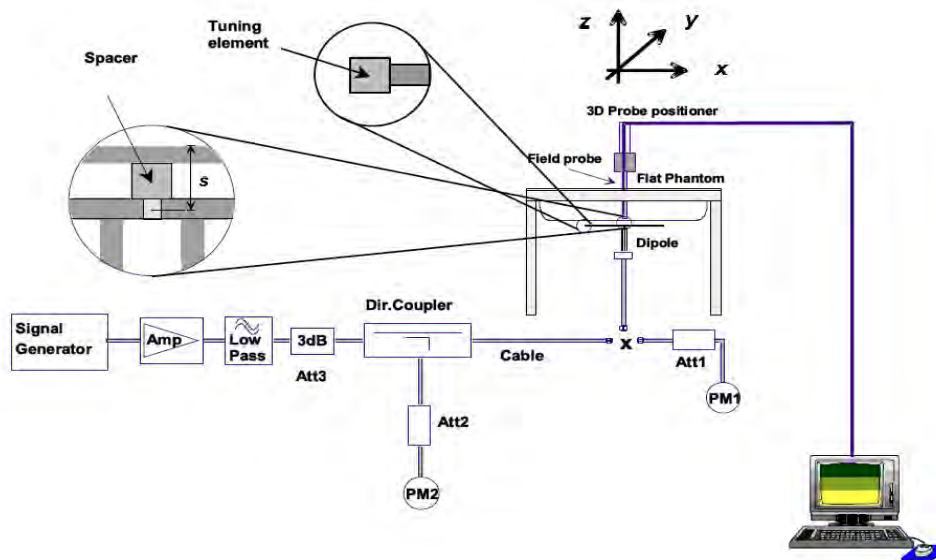

The output power on dipole port must be calibrated to 20 dBm (100mW) before dipole is connected.



Photo of Dipole Setup





Justification for Extended SAR Dipole Calibrations

Referring to KDB 865664D01V01r04, if dipoles are verified in return loss (<-20dB, within 20% of prior calibration), and in impedance (within 5 ohm of prior calibration), the annual calibration is not necessary and the calibration interval can be extended. While calibration intervals not exceed 3 years.

SID750 SN 07/14 DIP 0G750-302 Extend Dipole Calibrations

Date of Measurement	Return-Loss (dB)	Delta (%)	Real Impedance (ohm)	Delta (ohm)	Imaginary Impedance (ohm)	Delta (ohm)
2021-09-29	-34.80		50.7		1.6	
2022-09-29	-34.35	-1.29	51.2	0.5	1.5	-0.1
2023-09-29	-34.42	-1.09	51.3	0.4	1.5	-0.1

SID835 SN 07/14 DIP 0G835-303 Extend Dipole Calibrations

Date of Measurement	Return-Loss (dB)	Delta (%)	Real Impedance (ohm)	Delta (ohm)	Imaginary Impedance (ohm)	Delta (ohm)
2021-09-29	-24.49		54.9		2.8	
2022-09-29	-24.17	-1.31	54.5	-0.4	2.6	-0.2
2023-09-29	-24.20	-1.18	54.2	-0.7	2.5	-0.3

SID1800 SN 30/14 DIP 1G800-301 Extend Dipole Calibrations

Date of Measurement	Return-Loss (dB)	Delta (%)	Real Impedance (ohm)	Delta (ohm)	Imaginary Impedance (ohm)	Delta (ohm)
2021-09-29	-20.26		43.1		6.9	
2022-09-29	-20.13	-0.64	42.9	-0.2	6.7	-0.2
2023-09-29	-20.15	-0.54	42.8	-0.3	6.6	-0.3

SID1900 SN 38/18 DIP 1G900-466 Extend Dipole Calibrations

Date of Measurement	Return-Loss (dB)	Delta (%)	Real Impedance (ohm)	Delta (ohm)	Imaginary Impedance (ohm)	Delta (ohm)
2021-09-22	-26.43		50.5		4.7	
2022-09-22	-26.33	-0.38	50.2	-0.3	4.5	-0.2
2023-09-22	-26.40	-0.11	50.1	-0.4	4.6	-0.1

SID2450 SN 07/14 DIP 2G450-306 Extend Dipole Calibrations

Date of Measurement	Return-Loss (dB)	Delta (%)	Real Impedance (ohm)	Delta (ohm)	Imaginary Impedance (ohm)	Delta (ohm)
2021-09-29	-25.59		44.7		-1.1	
2022-09-29	-25.68	0.35	44.8	0.1	-1.0	0.1
2023-09-29	-25.70	0.43	44.5	-0.2	-1.1	0.0

SID2600 SN 38/18 DIP 2G600-468 Extend Dipole Calibrations

Date of Measurement	Return-Loss (dB)	Delta (%)	Real Impedance (ohm)	Delta (ohm)	Imaginary Impedance (ohm)	Delta (ohm)
2021-09-22	-29.14		49.2		3.4	
2022-09-22	-29.12	-0.07	49.1	-0.1	3.2	-0.2
2023-09-22	-29.10	-0.07	49.2	0.0	3.3	-0.1

SID5200 SN 49/16 DIP WGA43 Extend Dipole Calibrations

Date of Measurement	Return-Loss (dB)	Delta (%)	Real Impedance (ohm)	Delta (ohm)	Imaginary Impedance (ohm)	Delta (ohm)
2021-09-22	-8.59		19.38		13.50	
2022-09-22	-8.62	0.35	19.25	-0.13	13.47	-0.03
2023-09-22	-8.63	0.47	19.26	-0.12	13.45	-0.05





SID5400 SN 49/16 DIP WGA43 Extend Dipole Calibrations

Date of Measurement	Return-Loss (dB)	Delta (%)	Real Impedance (ohm)	Delta (ohm)	Imaginary Impedance (ohm)	Delta (ohm)
2021-09-22	-10.58		77.13		1.81	
2022-09-22	-10.55	0.28	77.15	0.02	1.74	-0.07
2023-09-22	-10.54	0.09	77.12	-0.03	1.08	-0.01

SID5600 SN 49/16 DIP WGA43 Extend Dipole Calibrations

Date of Measurement	Return-Loss (dB)	Delta (%)	Real Impedance (ohm)	Delta (ohm)	Imaginary Impedance (ohm)	Delta (ohm)
2021-09-22	-13.39		30.95		7.75	
2022-09-22	-13.35	0.30	30.91	-0.04	7.72	-0.03
2023-09-22	-13.34	0.07	30.92	-0.03	7.70	-0.05

SID5800 SN 49/16 DIP WGA43 Extend Dipole Calibrations

Date of Measurement	Return-Loss (dB)	Delta (%)	Real Impedance (ohm)	Delta (ohm)	Imaginary Impedance (ohm)	Delta (ohm)
2021-09-22	-11.37		54.79		25.47	
2022-09-22	-11.42	0.44	54.68	-0.11	25.26	-0.21
2023-09-22	-11.44	0.62	54.80	0.10	25.28	-0.19

Mixture Type	Frequency (MHz)	Power	SAR _{1g} (W/Kg)	SAR _{10g} (W/Kg)	Drift (%)	1W Target		Difference percentage		Liquid Temp	Date
						SAR _{1g} (W/Kg)	SAR _{10g} (W/Kg)	1g	10g		
Head	750	100 mW	0.834	0.577	1.42	8.38	5.53	0.48%	4.34%	20.1	11/13/2023
		Normalize to 1 Watt	8.34	5.77							
Head	835	100 mW	0.966	0.624	-0.55	9.6	6.2	0.63%	0.65%	20.1	11/13/2023
		Normalize to 1 Watt	9.66	6.24							
Head	1800	100 mW	3.944	2.055	1.62	38.13	20.2	3.44%	1.73%	21.3	11/15/2023
		Normalize to 1 Watt	39.44	20.55							
Head	1900	100 mW	4.102	2.105	-0.51	39.7	20.5	3.32%	2.68%	21.3	11/15/2023
		Normalize to 1 Watt	41.02	21.05							
Head	2450	100 mW	5.332	2.51	-0.08	53.89	24.15	1.24%	3.93%	22.1	11/17/2023
		Normalize to 1 Watt	53.22	25.1							
Head	5200	100 mW	16.442	5.512	-3.02	165.77	57.2	0.81%	3.64%	22.4	11/21/2023
		Normalize to 1 Watt	164.42	55.12							
Head	5300	100 mW	16.852	5.752	2.11	167.2	57.39	0.79%	0.24%	22.4	11/21/2023
		Normalize to 1 Watt	168.52	57.53							
Head	5600	100 mW	17.115	5.847	0.25	175.65	59.48	2.56%	1.70%	22.4	11/21/2023
		Normalize to 1 Watt	171.15	58.47							
Head	5800	100 mW	18.254	5.971	-1.25	181.2	61.5	0.74%	2.91%	22.4	11/21/2023
		Normalize to 1 Watt	182.54	59.71							





3.11. SAR measurement procedure

The measurement procedures are as follows:

3.11.1 Conducted power measurement

- For WWAN power measurement, use base station simulator connection with RF cable, at maximum power in each supported wireless interface and frequency band.
- Read the WWAN RF power level from the base station simulator.
- For WLAN/BT power measurement, use engineering software to configure EUT WLAN/BT continuously Transmission, at maximum RF power in each supported wireless interface and frequency band.
- Connect EUT RF port through RF cable to the power meter, and measure WLAN/BT output power.

3.11.2 WIFI Test Configuration

The SAR measurement and test reduction procedures are structured according to either the DSSS or OFDM transmission mode configurations used in each standalone frequency band and aggregated band. For devices that operate in exposure configurations that require multiple test positions, additional SAR test reduction may be applied. The maximum output power specified for production units, including tune-up tolerance, are used to determine initial SAR test requirements for the 802.11 transmission modes in a frequency band. SAR is measured using the highest measured maximum output power channel for the initial test configuration. SAR measurement and test reduction for the remaining 802.11 modes and test channels are determined according to measured or specified maximum output power and reported SAR of the initial measurements. The general test reduction and SAR measurement approaches are summarized in the following:

- The maximum output power specified for production units are determined for all applicable 802.11 transmission modes in each standalone and aggregated frequency band. Maximum output power is measured for the highest maximum output power configuration(s) in each frequency band according to the default power measurement procedures.
- For OFDM transmission configurations in the 2.4 GHz and 5 GHz bands, an "initial test configuration" is first determined for each standalone and aggregated frequency band according to the maximum output power and tune-up tolerance specified for production units.
 - When the same maximum power is specified for multiple transmission modes in a frequency band, the largest channel bandwidth, lowest order modulation, lowest data rate and lowest order 802.11a/g/n/ac mode is used for SAR measurement, on the highest measured output power channel in the initial test configuration, for each frequency band.
 - SAR is measured for OFDM configurations using the initial test configuration procedures. Additional frequency band specific SAR test reduction may be considered for individual frequency bands
 - Depending on the reported SAR of the highest maximum output power channel tested in the initial test configuration, SAR test reduction may apply to subsequent highest output channels in the initial test configuration to reduce the number of SAR measurements.
- The Initial test configuration does not apply to DSSS. The 2.4 GHz band SAR test requirements and 802.11b DSSS procedures are used to establish the transmission configurations required for SAR measurement.
- An "initial test position" is applied to further reduce the number of SAR tests for devices operating in next to the ear, UMPC mini-tablet or hotspot mode exposure configurations that require multiple test positions.
 - SAR is measured for 802.11b according to the 2.4 GHz DSSS procedure using the exposure condition established by the initial test position.
 - SAR is measured for 2.4 GHz and 5 GHz OFDM configurations using the initial test configuration. 802.11b/g/n operating modes are tested independently according to the service requirements in each frequency band. 802.11b/g/n modes are tested on the maximum average output channel.
- The Initial test position does not apply to devices that require a fixed exposure test position. SAR is measured in a fixed exposure test position for these devices in 802.11b according to the 2.4 GHz DSSS procedure or in 2.4 GHz and 5 GHz OFDM configurations using the initial test configuration procedures.
- The "subsequent test configuration" procedures are applied to determine if additional SAR measurements are required for the remaining OFDM transmission modes that have not been tested in the initial test configuration. SAR test exclusion is determined according to reported SAR in the initial test configuration and maximum output power specified or measured for these other OFDM configurations.

2.4 GHz and 5GHz SAR Procedures

Separate SAR procedures are applied to DSSS and OFDM configurations in the 2.4 GHz band to simplify DSSS test requirements. For 802.11b DSSS SAR measurements, DSSS SAR procedure applies to fixed exposure test position and initial test position procedure applies to multiple exposure test positions. When SAR measurement is required for an OFDM configuration, the initial test configuration, subsequent test configuration and initial test



Shenzhen LCS Compliance Testing Laboratory Ltd.

Add: 101, 201 Bldg A & 301 Bldg C, Juji Industrial Park Yabianxueziwei, Shajing Street, Baoan District, Shenzhen, 518000, China

Tel: +(86) 0755-82591330 | E-mail: webmaster@lcs-cert.com | Web: www.lcs-cert.com

Scan code to check authenticity



position procedures are applied. The SAR test exclusion requirements for 802.11g/n OFDM configurations are described in section 5.2.2.

1. 802.11b DSSS SAR Test Requirements

SAR is measured for 2.4 GHz 802.11b DSSS using either a fixed test position or, when applicable, the initial test position procedure. SAR test reduction is determined according to the following:

- a. When the reported SAR of the highest measured maximum output power channel (section 3.1) for the exposure configuration is ≤ 0.8 W/kg, no further SAR testing is required for 802.11b DSSS in that exposure configuration.
- b. When the reported SAR is > 0.8 W/kg, SAR is required for that exposure configuration using the next highest measured output power channel. When any reported SAR is > 1.2 W/kg, SAR is required for the third channel; i.e., all channels require testing.

1. 2.4 GHz 802.11g/n OFDM SAR Test Exclusion Requirements

When SAR measurement is required for 2.4 GHz 802.11g/n OFDM configurations, the measurement and test reduction procedures for OFDM are applied (section 5.3). SAR is not required for the following 2.4 GHz OFDM conditions.

- a. When KDB Publication 447498 SAR test exclusion applies to the OFDM configuration
- b. When the highest reported SAR for DSSS is adjusted by the ratio of OFDM to DSSS specified maximum output power and the adjusted SAR is ≤ 1.2 W/kg.

2. SAR Test Requirements for OFDM Configurations

When SAR measurement is required for 802.11 a/g/n/ac OFDM configurations, each standalone and frequency aggregated band is considered separately for SAR test reduction. When the same transmitter and antenna(s) are used for U-NII-1 and U-NII-2A bands, additional SAR test reduction applies. When band gap channels between U-NII-2C band and 5.8 GHz U-NII-3 or §15.247 band are supported, the highest maximum output power transmission mode configuration and maximum output power channel across the bands must be used to determine SAR test reduction, according to the initial test configuration and subsequent test configuration requirements.²⁰ In applying the initial test configuration and subsequent test configuration procedures, the 802.11 transmission configuration with the highest specified maximum output power and the channel within a test configuration with the highest measured maximum output power should be clearly distinguished to apply the procedures.

3. OFDM Transmission Mode SAR Test Configuration and Channel Selection Requirements

The initial test configuration for 2.4 GHz and 5 GHz OFDM transmission modes is determined by the 802.11 configuration with the highest maximum output power specified for production units, including tune-up tolerance, in each standalone and aggregated frequency band. SAR for the initial test configuration is measured using the highest maximum output power channel determined by the default power measurement procedures (section 4). When multiple configurations in a frequency band have the same specified maximum output power, the initial test configuration is determined according to the following steps applied sequentially.

- a. The largest channel bandwidth configuration is selected among the multiple configurations with the same specified maximum output power.
- b. If multiple configurations have the same specified maximum output power and largest channel bandwidth, the lowest order modulation among the largest channel bandwidth configurations is selected.
- c. If multiple configurations have the same specified maximum output power, largest channel bandwidth and lowest order modulation, the lowest data rate configuration among these configurations is selected.
- d. When multiple transmission modes (802.11a/g/n/ac) have the same specified maximum output power, largest channel bandwidth, lowest order modulation and lowest data rate, the lowest order 802.11 mode is selected; i.e., 802.11a is chosen over 802.11n then 802.11ac or 802.11g is chosen over 802.11n.

After an initial test configuration is determined, if multiple test channels have the same measured maximum output power, the channel chosen for SAR measurement is determined according to the following. These channel selection procedures apply to both the initial test configuration and subsequent test configuration(s), with respect to the default power measurement procedures or additional power measurements required for further SAR test reduction. The same procedures also apply to subsequent highest output power channel(s) selection.

- a. Channels with measured maximum output power within $\frac{1}{4}$ dB of each other are considered to have the same maximum output.
- b. When there are multiple test channels with the same measured maximum output power, the channel closest to mid-band frequency is selected for SAR measurement.
- c. When there are multiple test channels with the same measured maximum output power and equal separation from mid-band frequency; for example, high and low channels or two mid-band channels, the higher frequency (number) channel is selected for SAR measurement.

Initial Test Configuration Procedures

An initial test configuration is determined for OFDM transmission modes according to the channel bandwidth, modulation and data rate combination(s) with the highest maximum output power specified for production units in each standalone and aggregated frequency band. SAR is measured using the highest measured maximum



Shenzhen LCS Compliance Testing Laboratory Ltd.

Add: 101, 201 Bldg A & 301 Bldg C, Juji Industrial Park Yabianxueziwei, Shajing Street, Baoan District, Shenzhen, 518000, China

Tel: +(86) 0755-82591330 | E-mail: webmaster@lcs-cert.com | Web: www.lcs-cert.com

Scan code to check authenticity



output power channel. For configurations with the same specified or measured maximum output power, additional transmission mode and test channel selection procedures are required (see section 5.3.2). SAR test reduction of subsequent highest output test channels is based on the reported SAR of the initial test configuration. For next to the ear, hotspot mode and UMC mini-tablet exposure configurations where multiple test positions are required, the initial test position procedure is applied to minimize the number of test positions required for SAR measurement using the initial test configuration transmission mode.²³ For fixed exposure conditions that do not have multiple SAR test positions, SAR is measured in the transmission mode determined by the initial test configuration. When the reported SAR of the initial test configuration is > 0.8 W/kg, SAR measurement is required for the subsequent next highest measured output power channel(s) in the initial test configuration until the reported SAR is ≤ 1.2 W/kg or all required channels are tested.

4. Subsequent Test Configuration Procedures

SAR measurement requirements for the remaining 802.11 transmission mode configurations that have not been tested in the initial test configuration are determined separately for each standalone and aggregated frequency band, in each exposure condition, according to the maximum output power specified for production units. The initial test position procedure is applied to next to the ear, UMPC mini-tablet and hotspot mode configurations. When the same maximum output power is specified for multiple transmission modes, the procedures in section 5.3.2 are applied to determine the test configuration. Additional power measurements may be required to determine if SAR measurements are required for subsequent highest output power channels in a subsequent test configuration. The subsequent test configuration and SAR measurement procedures are described in the following.

- a. When SAR test exclusion provisions of KDB Publication 447498 are applicable and SAR measurement is not required for the initial test configuration, SAR is also not required for the next highest maximum output power transmission mode subsequent test configuration(s) in that frequency band or aggregated band and exposure configuration.
- b. When the highest reported SAR for the initial test configuration (when applicable, include subsequent highest output channels), according to the initial test position or fixed exposure position requirements, is adjusted by the ratio of the subsequent test configuration to initial test configuration specified maximum output power and the adjusted SAR is ≤ 1.2 W/kg, SAR is not required for that subsequent test configuration.
- c. The number of channels in the initial test configuration and subsequent test configuration can be different due to differences in channel bandwidth. When SAR measurement is required for a subsequent test configuration and the channel bandwidth is smaller than that in the initial test configuration, all channels in the subsequent test configuration that overlap with the larger bandwidth channel tested in the initial test configuration should be used to determine the highest maximum output power channel. This step requires additional power measurement to identify the highest maximum output power channel in the subsequent test configuration to determine SAR test reduction.
 - 1). SAR should first be measured for the channel with highest measured output power in the subsequent test configuration.
 - 2). SAR for subsequent highest measured maximum output power channels in the subsequent test configuration is required only when the reported SAR of the preceding higher maximum output power channel(s) in the subsequent test configuration is > 1.2 W/kg or until all required channels are tested.
 - a) For channels with the same measured maximum output power, SAR should be measured using the channel closest to the center frequency of the larger channel bandwidth channel in the initial test configuration.
 - d. SAR measurements for the remaining highest specified maximum output power OFDM transmission mode configurations that have not been tested in the initial test configuration (highest maximum output) or subsequent test configuration(s) (subsequent next highest maximum output power) is determined by applying the subsequent test configuration procedures in this section to the remaining configurations according to the following:
 - 1) replace "subsequent test configuration" with "next subsequent test configuration" (i.e., subsequent next highest specified maximum output power configuration)
 - 2) replace "initial test configuration" with "all tested higher output power configurations."

3.12. Power Reduction

The product without any power reduction.

3.13. Power Drift

To control the output power stability during the SAR test, SAR system calculates the power drift by measuring the E-field at the same location at the beginning and at the end of the measurement for each test position. This ensures that the power drift during one measurement is within 5%.



Shenzhen LCS Compliance Testing Laboratory Ltd.

Add: 101, 201 Bldg A & 301 Bldg C, Juji Industrial Park Yabianxueziwei, Shajing Street, Baoan District, Shenzhen, 518000, China

Tel: +(86) 0755-82591330 | E-mail: webmaster@lcs-cert.com | Web: www.lcs-cert.com

Scan code to check authenticity



4. TEST CONDITIONS AND RESULTS

4.1. Conducted Power Results

According KDB 447498 D01 General RF Exposure Guidance v06 Section 4.1 2) states that "Unless it is specified differently in the published RF exposure KDB procedures, these requirements also apply to test reduction and test exclusion considerations. Time-averaged maximum conducted output power applies to SAR and, as required by § 2.1091(c), time-averaged ERP applies to MPE. When an antenna port is not available on the device to support conducted power measurement, such as FRS and certain Part 15 transmitters with built-in integral antennas, the maximum output power allowed for production units should be used to determine RF exposure test exclusion and compliance."

<GSM Conducted Power>

General Note:

1. Per KDB 447498 D01v06, the maximum output power channel is used for SAR testing and for further SAR test reduction.
2. According to October 2013TCB Workshop, for GSM / GPRS / EGPRS, the number of time slots to test for SAR should correspond to the highest frame-average maximum output power configuration, considering the possibility of e.g. 3rd party VoIP operation for head and body-worn SAR testing, the EUT was set in GPRS (4Tx slot) for GSM850/GSM1900 band due to their highest frame-average power.
3. For hotspot mode SAR testing, GPRS should be evaluated, therefore the EUT was set in GPRS (4 Tx slots) for GSM850/GSM1900 band due to its highest frame-average power.

Conducted power measurement results for GSM850/PCS1900

GSM 850	Tune-up	Burst Conducted power (dBm)			Division Factors	Tune-up	Average power (dBm)			
		Channel/Frequency(MHz)					Channel/Frequency(MHz)			
	Max	128/824.2	190/836.6	251/848.8	Max	128/824.2	190/836.6	251/848.8		
GSM	25.00	24.78	24.03	24.53	-9.03dB	15.97	15.75	15.00	15.50	
GPRS (GMSK)	1TX slot	24.50	24.40	24.38	24.37	-9.03dB	15.47	18.38	18.36	18.35
	2TX slot	24.50	24.21	24.20	24.16	-6.02dB	18.48	19.95	19.94	19.90
	3TX slot	24.50	24.02	23.97	23.94	-4.26dB	20.24	21.01	20.96	20.93
	4TX slot	25.00	24.56	24.67	24.75	-3.01dB	21.99	15.53	15.64	15.72
EGPRS (8PSK)	1TX slot	25.00	24.35	24.45	24.57	-9.03dB	15.97	18.33	18.43	18.55
	2TX slot	24.50	24.15	24.21	24.37	-6.02dB	18.48	19.89	19.95	20.11
	3TX slot	24.50	23.81	23.95	24.16	-4.26dB	20.24	20.80	20.94	21.15
	4TX slot	24.50	24.40	24.38	24.37	-3.01dB	21.49	18.38	18.36	18.35
GSM 1900	Tune-up	Burst Conducted power (dBm)			Division Factors	Tune-up	Average power (dBm)			
		Channel/Frequency(MHz)					Channel/Frequency(MHz)			
	Max	512/1850.2	661/1880	810/1909.8	Max.	512/1850.2	661/1880	810/1909.8		
GSM	17.5	18.15	18.07	17.90	-9.03dB	8.47	9.12	9.04	8.87	
GPRS (GMSK)	1TX slot	17.5	18.04	18.00	17.80	-9.03dB	8.47	12.02	11.98	11.78
	2TX slot	17.0	17.96	17.89	17.64	-6.02dB	10.98	13.70	13.63	13.38
	3TX slot	17.0	17.82	17.75	17.56	-4.26dB	12.74	14.81	14.74	14.55
	4TX slot	17.5	18.10	18.07	17.87	-3.01dB	14.49	9.07	9.04	8.84
EGPRS (8PSK)	1TX slot	17.5	18.04	17.97	17.78	-9.03dB	8.47	12.02	11.95	11.76
	2TX slot	17.0	17.94	17.85	17.66	-6.02dB	10.98	13.68	13.59	13.40
	3TX slot	17.0	17.82	17.73	17.53	-4.26dB	12.74	14.81	14.72	14.52
	4TX slot	17.5	18.04	18.00	17.80	-3.01dB	14.49	12.02	11.98	11.78

Notes:

1. Division Factors

To average the power, the division factor is as follows:

1TX-slot = 1 transmit time slot out of 8 time slots=> conducted power divided by (8/1) => -9.00dB

2TX-slots = 2 transmit time slots out of 8 time slots=> conducted power divided by (8/2) => -6.00dB

3TX-slots = 3 transmit time slots out of 8 time slots=> conducted power divided by (8/3) => -4.26dB



Shenzhen LCS Compliance Testing Laboratory Ltd.

Add: 101, 201 Bldg A & 301 Bldg C, Juji Industrial Park Yabianxueziwei, Shajing Street, Baoan District, Shenzhen, 518000, China

Tel: +(86) 0755-82591330 | E-mail: webmaster@lcs-cert.com | Web: www.lcs-cert.com

Scan code to check authenticity



4TX-slots = 4 transmit time slots out of 8 time slots=> conducted power divided by (8/4) => -3.00dB
2. According to the conducted power as above, the GPRS measurements are performed with 4Txslot for GPRS850 and 2Txslot GPRS1900.

<UMTS Conducted Power>

The following tests were conducted according to the test requirements outlines in 3GPP TS 34.121 specification. A summary of these settings are illustrated below:

HSDPA Setup Configuration:

- a. The EUT was connected to Base Station CMW500 referred to the Setup Configuration.
- b. The RF path losses were compensated into the measurements.
- c. A call was established between EUT and Base Station with following setting:
 - i. Set Gain Factors (β_c and β_d) and parameters were set according to each
 - ii. Specific sub-test in the following table, C10.1.4, quoted from the TS 34.121
 - iii. Set RMC 12.2Kbps + HSDPA mode.
 - iv. Set Cell Power = -86 dBm
 - v. Set HS-DSCH Configuration Type to FRC (H-set 1, QPSK)
 - vi. Select HSDPA Uplink Parameters
 - vii. Set Delta ACK, Delta NACK and Delta CQI = 8
 - viii. Set Ack-Nack Repetition Factor to 3
 - ix. Set CQI Feedback Cycle (k) to 4 ms
 - x. Set CQI Repetition Factor to 2
 - xi. Power Ctrl Mode = All Up bits
- d. The transmitted maximum output power was recorded.

Table C.10.1.4: β values for transmitter characteristics tests with HS-DPCCH

Sub-test	β_c	β_d	β_d (SF)	β_c/β_d	β_{HS} (Note 1, Note 2)	CM (dB) (Note 3)	MPR (dB) (Note 3)
1	2/15	15/15	64	2/15	4/15	0.0	0.0
2	12/15 (Note 4)	15/15 (Note 4)	64	12/15 (Note 4)	24/15	1.0	0.0
3	15/15	8/15	64	15/8	30/15	1.5	0.5
4	15/15	4/15	64	15/4	30/15	1.5	0.5

Note 1: $\Delta_{ACK}, \Delta_{NACK}$ and $\Delta_{CQI} = 30/15$ with $\beta_{HS} = 30/15 * \beta_c$.
Note 2: For the HS-DPCCH power mask requirement test in clause 5.2C, 5.7A, and the Error Vector Magnitude (EVM) with HS-DPCCH test in clause 5.13.1A, and HSDPA EVM with phase discontinuity in clause 5.13.1AA, Δ_{ACK} and $\Delta_{NACK} = 30/15$ with $\beta_{HS} = 30/15 * \beta_c$, and $\Delta_{CQI} = 24/15$ with $\beta_{HS} = 24/15 * \beta_c$.
Note 3: CM = 1 for $\beta_c/\beta_d = 12/15, \beta_{HS}/\beta_c = 24/15$. For all other combinations of DPDCCH, DPCCH and HS-DPCCH the MPR is based on the relative CM difference. This is applicable for only UEs that support HSDPA in release 6 and later releases.
Note 4: For subtest 2 the β_c/β_d ratio of 12/15 for the TFC during the measurement period (TF1, TF0) is achieved by setting the signalled gain factors for the reference TFC (TF1, TF1) to $\beta_c = 11/15$ and $\beta_d = 15/15$.

Setup Configuration

HSUPA Setup Configuration:

- a. The EUT was connected to Base Station R&S CMW500 referred to the Setup Configuration.
- b. The RF path losses were compensated into the measurements.
- c. A call was established between EUT and Base Station with following setting * :
 - i. Call Configs = 5.2B, 5.9B, 5.10B, and 5.13.2B with QPSK
 - ii. Set the Gain Factors (β_c and β_d) and parameters (AG Index) were set according to each specific sub-test in the following table, C11.1.3, quoted from the TS 34.121
 - iii. Set Cell Power = -86 dBm
 - iv. Set Channel Type = 12.2k + HSPA
 - v. Set UE Target Power
 - vi. Power Ctrl Mode= Alternating bits
 - vii. Set and observe the E-TFCl
 - viii. Confirm that E-TFCl is equal to the target E-TFCl of 75 for sub-test 1, and other subtest's E-TFCl



d. The transmitted maximum output power was recorded.

Table C.11.1.3: β values for transmitter characteristics tests with HS-DPCCH and E-DCH

Sub-test	β_c	β_d	β_d (SF)	β_c/β_d	β_{HS} (Note 1)	β_{ec}	β_{ed} (Note 5) (Note 6)	β_{ed} (SF)	β_{ed} (Codes)	CM (dB) (Note 2)	MPR (dB) (Note 2)	AG Index (Note 6)	E-TFCI
1	11/15 (Note 3)	15/15 (Note 3)	64	11/15 (Note 3)	22/15	209/25	1309/225	4	1	1.0	0.0	20	75
2	6/15	15/15	64	6/15	12/15	12/15	94/75	4	1	3.0	2.0	12	67
3	15/15	9/15	64	15/9	30/15	30/15	β_{ed1} : 47/15 β_{ed2} : 47/15	4	2	2.0	1.0	15	92
4	2/15	15/15	64	2/15	4/15	2/15	56/75	4	1	3.0	2.0	17	71
5	15/15 (Note 4)	15/15 (Note 4)	64	15/15 (Note 4)	30/15	24/15	134/15	4	1	1.0	0.0	21	81

Note 1: $\Delta_{ACK}, \Delta_{NACK}$ and $\Delta_{CQI} = 30/15$ with $\beta_{hs} = 30/15 * \beta_c$.

Note 2: CM = 1 for $\beta_c/\beta_d = 12/15, \beta_{hs}/\beta_c = 24/15$. For all other combinations of DPDCH, DPCCH, HS-DPCCH, E-DPDCH and E-DPCCH the MPR is based on the relative CM difference.

Note 3: For subtest 1 the β_c/β_d ratio of 11/15 for the TFC during the measurement period (TF1, TF0) is achieved by setting the signalled gain factors for the reference TFC (TF1, TF1) to $\beta_c = 10/15$ and $\beta_d = 15/15$.

Note 4: For subtest 5 the β_c/β_d ratio of 15/15 for the TFC during the measurement period (TF1, TF0) is achieved by setting the signalled gain factors for the reference TFC (TF1, TF1) to $\beta_c = 14/15$ and $\beta_d = 15/15$.

Note 5: In case of testing by UE using E-DPDCH Physical Layer category 1, Sub-test 3 is omitted according to TS25.306 Table 5.1g.

Note 6: β_{ed} can not be set directly, it is set by Absolute Grant Value.

General Note

1. Per KDB 941225 D01, RMC 12.2kbps setting is used to evaluate SAR. If AMR 12.2kbps power is < 0.25dB higher than RMC 12.2kbps, SAR tests with AMR 12.2kbps can be excluded.
2. By design, AMR and HSDPA/HSUPA RF power will not be larger than RMC 12.2kbps, detailed information is included in Tune-up Procure exhibit.
3. It is expected by the manufacturer that MPR for some HSDPA/HSUPA subtests may differ from the specification of 3GPP, according to the chipset implementation in this model. The implementation and expected deviation are detailed in tune-up procedure exhibit.

Conducted Power Measurement Results(WCDMA Band II/ IV/V)

Item	band	WCDMA Band II result (dBm)			WCDMA Band IV result (dBm)			WCDMA Band V result (dBm)		
		Channel/Frequency(MHz)			Channel/Frequency(MHz)			Channel/Frequency(MHz)		
	sub-test	9262/1852.4	9400/1880	9538/1907.6	1312/1712.6	1413/1740	1513/1752.4	4132/826.4	4182/836.4	4233/846.6
RMC	12.2kbps	11.40	11.94	11.67	12.03	12.79	12.60	14.30	14.96	14.60
HSDPA	Sub -Test 1	11.58	11.19	10.96	12.00	11.60	11.40	14.22	13.91	13.64
	Sub -Test 2	10.84	11.58	11.62	11.38	12.94	12.55	13.50	14.85	14.64
	Sub -Test 3	11.31	11.26	11.79	12.29	12.01	12.58	14.32	14.56	14.49
	Sub -Test 4	11.48	10.98	10.96	12.27	12.07	11.57	14.30	13.97	14.23
HSUPA	Sub -Test 1	11.43	11.49	11.10	11.85	11.87	11.67	14.15	14.20	13.90
	Sub -Test 2	11.47	11.32	11.78	11.89	11.72	12.48	14.17	14.13	14.72
	Sub -Test 3	11.86	11.64	11.80	12.65	12.45	12.69	14.84	14.49	14.84
	Sub -Test 4	11.83	11.73	11.77	12.45	12.27	12.48	14.63	14.47	14.52
	Sub -Test 5	11.41	11.78	11.72	12.23	12.48	12.17	14.20	14.52	14.24

Note: When the maximum output power and tune-up tolerance specified for production WCDMA units in a secondary mode is $\leq 1/2$ dB higher than the primary mode (RMC12.2kbps) or when the highest reported SAR of the primary mode is scaled by the ratio of specified maximum output power and tune-up tolerance of secondary to primary mode and the adjusted SAR is ≤ 1.2 W/kg, SAR measurement is not required for the secondary mode.





LTE Band2

BW (MHz)	Frequency (MHz)	RB Configuration		Average Power [dBm]	
		Size	Offset	QPSK	16QAM
1.4	1850.7	1	0	12.68	11.91
		1	3	12.9	12.13
		1	5	12.7	11.93
		3	0	12.67	12.03
		3	2	12.75	12.1
		3	3	12.69	12.03
		6	0	11.86	11.12
	1880.0	1	0	12.91	12.2
		1	3	13.09	12.38
		1	5	12.82	12.14
		3	0	13.02	12.34
		3	2	13.07	12.4
		3	3	12.97	12.3
		6	0	12.09	11.26
	1909.3	1	0	12.42	11.38
		1	3	12.56	11.51
		1	5	12.24	11.19
		3	0	12.44	11.73
		3	2	12.47	11.75
		3	3	12.32	11.63
		6	0	11.55	10.8
3	1851.5	1	0	12.62	12.21
		1	7	12.83	12.42
		1	14	12.64	12.24
		8	0	11.85	11.05
		8	4	11.9	11.09
		8	7	11.86	11.05
		15	0	11.92	11.05
	1880.0	1	0	13.05	12.35
		1	7	13.15	12.44
		1	14	12.84	12.15
		8	0	12.18	11.14
		8	4	12.18	11.14
		8	7	12.08	11.03
		15	0	12.18	11.11
	1908.5	1	0	12.81	11.8
		1	7	12.76	11.74
		1	14	12.3	11.26
		8	0	11.79	10.97
		8	4	11.72	10.89
		8	7	11.52	10.7
		15	0	11.76	10.92
5	1852.5	1	0	12.3	12.02
		1	12	12.83	12.58
		1	24	12.34	12.06
		12	0	11.74	10.84
		12	6	11.9	11
		12	13	11.77	10.87
		25	0	11.84	10.88





10	1880.0	1	0	12.76	12.25
		1	12	13.11	12.56
		1	24	12.4	11.9
		12	0	12.11	11.03
		12	6	12.16	11.09
		12	13	11.91	10.83
		25	0	12.09	11.07
	1907.5	1	0	12.93	12.4
		1	12	12.87	12.35
		1	24	11.89	11.36
		12	0	12.08	11.22
		12	6	11.96	11.08
		12	13	11.53	10.65
		25	0	11.89	10.98
15	1855.0	1	0	12.59	11.61
		1	24	12.96	12.06
		1	49	13.5	12.49
		25	0	11.91	11.11
		25	12	12.11	11.24
		25	25	12.43	11.53
		50	0	12.29	11.38
	1880.0	1	0	13.08	12.79
		1	24	13.12	12.68
		1	49	12.94	12.66
		25	0	12.34	11.3
		25	12	12.24	11.22
		25	25	12.24	11.18
		50	0	12.36	11.31
1905.0	1	0	14.01	13.27	
	1	24	13.6	12.88	
	1	49	12.72	11.98	
	25	0	13.05	12.15	
	25	12	12.71	11.78	
	25	25	12.27	11.36	
	50	0	12.73	11.87	
15	1857.5	1	0	12.89	12.45
		1	37	13.06	12.65
		1	74	13.77	13.33
		37	0	12.12	11.21
		37	18	12.21	11.32
		37	38	12.59	11.68
		75	0	12.45	11.49
	1880.0	1	0	13.49	12.79
		1	37	13.08	12.35
		1	74	12.75	12.05
		37	0	12.5	11.49
		37	18	12.17	11.2
		37	38	12.01	10.99
		75	0	12.31	11.23
1902.5	1	0	14.02	13.16	
	1	37	13.8	12.99	
	1	74	12.33	11.47	
	37	0	13.16	12.21	
	37	18	12.83	11.87	
	37	38	12.16	11.23	
		75	0	12.75	11.87





20	1860.0	1	0	13.5	12.87
		1	49	13.47	12.89
		1	99	14.68	14.05
		50	0	12.51	11.7
		50	25	12.65	11.83
		50	50	13.24	12.44
		100	0	12.96	12.07
	1880.0	1	0	14.15	13.53
		1	49	13.14	12.48
		1	99	13.41	12.79
		50	0	12.87	11.73
		50	25	12.31	11.22
		50	50	12.29	11.14
	1900.0	100	0	12.64	11.52
		1	0	13.7	12.98
		1	49	14.08	13.42
		1	99	12.74	12.01
		50	0	13.2	12.33
		50	25	13.09	12.22
		50	50	12.63	11.77
		100	0	12.95	12.07





LTE Band4

BW (MHz)	Frequency (MHz)	RB Configuration		Average Power [dBm]	
		Size	Offset	QPSK	16QAM
1.4	1710.7	1	0	12.92	11.99
		1	3	13.12	12.19
		1	5	12.88	11.96
		3	0	12.87	12.09
		3	2	12.93	12.15
		3	3	12.86	12.07
	1732.5	6	0	11.9	11.11
		1	0	12.51	11.66
		1	3	12.77	11.91
		1	5	12.61	11.78
		3	0	12.65	11.85
		3	2	12.74	11.95
		3	3	12.7	11.92
		6	0	11.65	10.8
	1754.3	1	0	12.96	11.72
		1	3	13.12	11.88
		1	5	12.85	11.61
		3	0	12.97	12.08
		3	2	13.02	12.12
		3	3	12.91	12.03
	3	1711.5	6	0	11.92
1			0	12.79	12.26
1			7	12.93	12.4
1			14	12.64	12.12
8			0	11.92	10.95
8			4	11.92	10.96
1732.5		8	7	11.84	10.88
		15	0	11.91	10.98
		1	0	12.48	11.62
		1	7	12.83	11.97
		1	14	12.76	11.92
		8	0	11.59	10.59
1753.5		8	4	11.7	10.69
		8	7	11.75	10.73
		15	0	11.75	10.67
		1	0	13.2	11.98
		1	7	13.25	12.02
		1	14	12.92	11.68
5	1712.5	8	0	12.1	11.14
		8	4	12.07	11.11
		8	7	11.94	10.98
		15	0	12.07	11.18
		1	0	12.45	12.1
		1	12	12.86	12.48
	1732.5	1	24	12.17	11.82
		12	0	11.77	10.8
		12	6	11.85	10.88
		12	13	11.62	10.66
1732.5	25	0	11.75	10.74	
	1	0	12	11.34	
	1	12	12.79	12.1	
	1	24	12.48	11.83	
		12	0	11.44	10.38





10	1752.5	12	6	11.71	10.64
		12	13	11.7	10.64
		25	0	11.64	10.63
		1	0	12.96	12.27
		1	12	13.28	12.56
		1	24	12.51	11.82
		12	0	12.16	11.25
		12	6	12.19	11.28
		12	13	11.91	10.99
		25	0	12.11	11.1
10	1715.0	1	0	12.32	11.87
		1	24	12.38	11.82
		1	49	12.29	11.84
		25	0	11.51	10.5
		25	12	11.42	10.42
		25	25	11.41	10.4
	1732.5	50	0	11.47	10.43
		1	0	11.92	11.16
		1	24	12.77	11.89
		1	49	13.38	12.63
		25	0	11.43	10.41
		25	12	11.77	10.73
	1750.0	25	25	12.21	11.18
		50	0	11.88	10.88
		1	0	13.36	12.29
		1	24	13.52	12.29
		1	49	13.3	12.21
		25	0	12.49	11.53
15	1717.5	25	12	12.42	11.47
		25	25	12.42	11.46
		50	0	12.49	11.49
		1	0	12.64	12.06
		1	37	12.09	11.52
		1	74	12.17	11.6
	1732.5	37	0	11.5	10.49
		37	18	11.19	10.2
		37	38	11.17	10.15
		75	0	11.35	10.29
		1	0	12.08	11.14
		1	37	12.73	11.87
	1747.5	1	74	13.39	12.48
		37	0	11.38	10.42
		37	18	11.71	10.74
		37	38	12.14	11.18
		75	0	11.84	10.77
		1	0	13.64	12.65
20	1720.0	1	37	13.61	12.64
		1	74	13.17	12.18
		37	0	12.66	11.66
		37	18	12.52	11.52
		37	38	12.39	11.39
		75	0	12.56	11.61
		1	0	12.86	12.08
		1	49	11.93	11.24
		1	99	12.71	11.93
		50	0	11.41	10.43





立讯检测股份 LCS Testing Lab		50	25	11.05	10.07
		50	50	11.27	10.29
		100	0	11.34	10.31
	1732.5	1	0	12.4	11.52
		1	49	12.81	12.01
		1	99	13.85	12.98
		50	0	11.5	10.45
		50	25	11.82	10.77
		50	50	12.39	11.34
		100	0	12	10.97
		1745.0	1	0	13.94
	1		49	13.72	12.89
	1		99	13.77	12.92
	50		0	12.82	11.9
	50		25	12.68	11.76
	50		50	12.74	11.81
	100		0	12.83	11.86





LTE Band5

BW (MHz)	Frequency (MHz)	RB Configuration		Average Power [dBm]	
		Size	Offset	QPSK	16QAM
1.4	824.7	1	0	15.02	14.05
		1	3	15.21	14.24
		1	5	14.93	13.97
		3	0	15.01	14.18
		3	2	15.06	14.24
		3	3	14.96	14.12
	836.5	6	0	13.93	13.12
		1	0	15.45	14.54
		1	3	15.64	14.75
		1	5	15.37	14.48
		3	0	15.55	14.71
		3	2	15.61	14.78
		3	3	15.5	14.67
		6	0	14.4	13.67
	848.3	1	0	14.96	13.77
		1	3	15.19	14
		1	5	14.92	13.72
		3	0	15.03	14.19
		3	2	15.1	14.26
		3	3	15.01	14.19
	3	825.5	6	0	13.97
1			0	14.92	14.31
1			7	14.98	14.38
1			14	14.66	14.05
8			0	13.93	12.94
8			4	13.93	12.94
836.5		8	7	13.82	12.84
		15	0	13.87	12.93
		1	0	15.45	14.54
		1	7	15.6	14.76
		1	14	15.36	14.47
		8	0	14.49	13.56
		8	4	14.53	13.6
847.5		8	7	14.44	13.51
		15	0	14.44	13.49
	1	0	14.89	13.71	
	1	7	15.25	14.07	
	1	14	14.97	13.77	
	8	0	13.96	12.95	
	8	4	14.04	13.04	
5	826.5	8	7	14.02	13.02
		15	0	13.98	13.07
		1	0	14.59	14.1
		1	12	14.92	14.46
		1	24	14.14	13.66
		12	0	13.79	12.8
	836.5	12	6	13.82	12.84
		12	13	13.5	12.52
		25	0	13.63	12.6
		1	0	15.01	14.27
836.5	1	12	15.64	14.9	
	1	24	14.94	14.21	
	12	0	14.35	13.39	





立讯检测股份 LCS Testing Lab	846.5	12	6	14.51	13.54
		12	13	14.28	13.32
		25	0	14.33	13.42
		1	0	14.63	13.93
		1	12	15.04	14.35
		1	24	14.59	13.9
		12	0	13.85	12.87
		12	6	14.01	13.04
		12	13	13.92	12.94
		25	0	13.87	12.85
立讯检测股份 LCS Testing Lab	829.0	1	0	15.28	14.67
		1	24	15.27	14.63
		1	49	15.54	14.93
		25	0	14.3	13.38
		25	12	14.26	13.34
		25	25	14.4	13.48
		50	0	14.33	13.41
	836.5	1	0	14.99	14.11
		1	24	15.66	14.71
		1	49	15.11	14.24
		25	0	14.37	13.43
		25	12	14.51	13.58
		25	25	14.47	13.54
		50	0	14.4	13.5
	844.0	1	0	15.5	14.29
		1	24	15.01	13.82
		1	49	15.13	13.91
		25	0	14.19	13.15
		25	12	13.96	12.93
		25	25	13.98	12.93
		50	0	14.06	13.03





LTE Band12

BW (MHz)	Frequency (MHz)	RB Configuration		Average Power [dBm]	
		Size	Offset	QPSK	16QAM
1.4	699.7	1	0	19.45	18.21
		1	3	19.62	18.4
		1	5	19.34	18.12
		3	0	19.47	18.59
		3	2	19.52	18.65
		3	3	19.41	18.6
	707.5	6	0	18.37	17.63
		1	0	19.51	18.54
		1	3	19.72	18.75
		1	5	19.59	18.64
		3	0	19.48	18.65
		3	2	19.56	18.72
		3	3	19.54	18.7
		6	0	18.46	17.69
	715.3	1	0	18.85	17.94
		1	3	18.95	18.05
		1	5	18.76	17.88
		3	0	18.89	18.07
		3	2	18.91	18.1
		3	3	18.84	18.03
	3	700.5	6	0	17.74
1			0	19.44	18.81
1			7	19.46	18.85
1			14	18.84	18.23
8			0	18.43	17.52
8			4	18.37	17.46
707.5		8	7	18.11	17.19
		15	0	18.23	17.39
		1	0	19.28	18.39
		1	7	19.55	18.67
		1	14	19.68	18.82
		8	0	18.36	17.39
714.5		8	4	18.46	17.49
		8	7	18.56	17.59
		15	0	18.47	17.47
		1	0	18.95	17.76
		1	7	19.02	17.82
		1	14	18.75	17.54
5	701.5	8	0	17.82	16.9
		8	4	17.83	16.92
		8	7	17.75	16.84
		15	0	17.78	16.96
		1	0	19.13	18.37
		1	12	19.14	18.41
	707.5	1	24	18.16	17.43
		12	0	18.22	17.34
		12	6	18.09	17.22
		12	13	17.6	16.69
		25	0	17.9	16.96
		1	0	18.82	18.36
	707.5	1	12	19.53	19.08
		1	24	19.61	19.16
		12	0	18.21	17.27





立讯检测股份 LCS Testing Lab	713.5	12	6	18.49	17.56
		12	13	18.62	17.68
		25	0	18.44	17.43
		1	0	18.81	18.08
		1	12	19.00	18.29
		1	24	18.38	17.66
		12	0	17.95	16.98
		12	6	17.94	16.97
		12	13	17.66	16.69
		25	0	17.81	16.91
立讯检测股份 LCS Testing Lab	704	1	0	19.76	19.14
		1	24	19.13	18.54
		1	49	20.01	19.42
		25	0	18.4	17.45
		25	12	18.22	17.29
		25	25	18.57	17.62
		50	0	18.5	17.51
	707.5	1	0	18.75	17.86
		1	24	19.44	18.56
		1	49	20.08	19.22
		25	0	18.14	17.14
		25	12	18.56	17.59
		25	25	19.06	18.06
		50	0	18.62	17.65
	711.0	1	0	18.6	17.39
		1	24	19.46	18.24
		1	49	19.16	17.94
		25	0	18.11	17.13
		25	12	18.33	17.39
		25	25	18.24	17.29
50		0	18.16	17.19	





LTE Band66

BW (MHz)	Frequency (MHz)	RB Configuration		Average Power [dBm]		
		Size	Offset	QPSK	16QAM	
1.4	1710.7	1	0	13.44	12.5	
		1	3	13.63	12.7	
		1	5	13.4	12.47	
		3	0	13.43	12.61	
		3	2	13.49	12.67	
		3	3	13.41	12.59	
	1732.5	6	0	12.41	11.7	
		1	0	14.08	13.18	
		1	3	14.32	13.42	
		1	5	14.02	13.15	
		3	0	14.17	13.39	
		3	2	14.24	13.47	
	1754.3	3	3	14.11	13.36	
		6	0	13.13	12.33	
		1	0	13.3	12.09	
		1	3	13.49	12.28	
		1	5	13.25	12.03	
		3	0	13.34	12.48	
	3	1711.5	3	2	13.39	12.54
			3	3	13.3	12.45
			6	0	12.33	11.58
			1	0	13.32	12.76
			1	7	13.46	12.9
			1	14	13.17	12.61
1732.5		8	0	12.4	11.55	
		8	4	12.42	11.56	
		8	7	12.33	11.47	
		15	0	12.4	11.54	
		1	0	14.13	13.29	
		1	7	14.3	13.45	
1753.5		1	14	14.07	13.25	
		8	0	13.18	12.19	
		8	4	13.19	12.2	
		8	7	13.14	12.15	
		15	0	13.22	12.19	
		1	0	13.3	12.12	
5		1712.5	1	7	13.53	12.34
			1	14	13.28	12.08
			8	0	12.25	11.38
			8	4	12.31	11.43
			8	7	12.27	11.4
			15	0	12.34	11.54
	1732.5	1	0	12.99	12.56	
		1	12	13.39	12.99	
		1	24	12.71	12.28	
		12	0	12.26	11.39	
		12	6	12.35	11.48	
		12	13	12.11	11.25	
1732.5	25	0	12.23	11.31		
	1	0	13.72	13.08		
	1	12	14.25	13.59		
	1	24	13.67	13.04		
	12	0	13.07	12.06		





	1752.5	12	6	13.19	12.17
		12	13	13.02	12
		25	0	13.13	12.15
		1	0	12.8	12.07
		1	12	13.4	12.72
		1	24	12.88	12.17
		12	0	12.07	11.27
		12	6	12.28	11.46
		12	13	12.15	11.34
		25	0	12.22	11.3
10	1715.0	1	0	12.83	12.27
		1	24	12.84	12.34
		1	49	12.8	12.25
		25	0	11.96	11.06
		25	12	11.9	10.96
		25	25	11.87	10.97
	1732.5	50	0	11.96	11.04
		1	0	13.81	13.08
		1	24	14.25	13.4
		1	49	14.29	13.56
		25	0	13.14	12.13
		25	12	13.24	12.24
	1750.0	25	25	13.37	12.35
		50	0	13.29	12.33
		1	0	13.19	11.91
		1	24	13.31	12.12
		1	49	13.7	12.41
		25	0	12.12	11.3
15	1717.5	25	12	12.22	11.36
		25	25	12.44	11.61
		50	0	12.36	11.51
		1	0	13.09	12.58
		1	37	12.56	12.05
		1	74	12.63	12.12
	1732.5	37	0	12.01	11.06
		37	18	11.7	10.75
		37	38	11.69	10.73
		75	0	11.88	10.89
		1	0	14.05	13.19
		1	37	14.2	13.35
	1747.5	1	74	13.98	13.14
		37	0	13.22	12.25
		37	18	13.19	12.26
		37	38	13.18	12.21
		75	0	13.21	12.21
		1	0	13.14	12.2
20	1720.0	1	37	12.73	11.83
		1	74	12.94	12
		37	0	11.98	11.02
		37	18	11.75	10.81
		37	38	11.8	10.84
		75	0	11.96	11.05
		0	13.48	12.87	
		1	49	12.53	11.92
		1	99	13.35	12.73
		50	0	12.11	11.17





1732.5	50	25	11.72	10.79
	50	50	11.98	11.05
	100	0	12.07	11.1
	1	0	14.52	13.74
	1	49	14.3	13.51
	1	99	14.34	13.56
	50	0	13.43	12.36
	50	25	13.28	12.26
	50	50	13.35	12.28
	100	0	13.39	12.36
1745.0	1	0	13.9	13.09
	1	49	12.93	12.17
	1	99	13.3	12.48
	50	0	12.38	11.49
	50	25	11.95	11.1
	50	50	11.99	11.11
	100	0	12.24	11.29





<WLAN 2.4GHz Conducted Power>

Mode	Channel	Frequency (MHz)	Average Output Power (dBm)
IEEE 802.11b	1	2412	5.84
	6	2437	7.48
	11	2462	6.56
IEEE 802.11g	1	2412	5.29
	6	2437	7.09
	11	2462	5.71
IEEE 802.11n HT20	1	2412	5.85
	6	2437	7.72
	11	2462	6.53

Note: SAR is not required for the following 2.4 GHz OFDM conditions as the highest reported SAR for DSSS is adjusted by the ratio of OFDM to DSSS specified maximum output power and the adjusted SAR is ≤ 1.2 W/kg.

<WLAN 5.2G Conducted Power>

Mode	Channel	Frequency (MHz)	Average Conducted Output Power(dBm)
IEEE 802.11a	36	5180	6.00
	40	5200	6.84
	48	5240	6.24
IEEE 802.11n HT20	36	5180	6.73
	40	5200	7.13
	48	5240	6.47
IEEE 802.11n HT40	38	5190	6.98
	46	5230	6.49
802.11ac-VHT20	36	5180	6.69
	40	5200	7.06
	48	5240	6.53
802.11ac-VHT40	38	5190	6.99
	46	5230	6.41
802.11ac-VHT80	42	5210	6.74

<WLAN 5.3G Conducted Power>

Mode	Channel	Frequency (MHz)	Average Conducted Output Power(dBm)
IEEE 802.11a	52	5260	6.39
	60	5300	6.47
	64	5320	6.09
IEEE 802.11n HT20	52	5260	6.62
	60	5300	6.81
	64	5320	6.56
IEEE 802.11n HT40	54	5270	6.19
	62	5310	6.66
802.11ac-VHT20	52	5260	6.56
	60	5300	6.77
	64	5320	6.36
802.11ac-VHT40	54	5270	6.31
	62	5310	6.53
802.11ac-VHT80	58	5290	6.75





<WLAN 5.6G Conducted Power>

Mode	Channel	Frequency (MHz)	Average Conducted Output Power(dBm)
IEEE 802.11a	100	5500	6.65
	116	5580	5.12
	140	5700	5.41
IEEE 802.11n HT20	100	5500	6.91
	116	5580	5.33
	140	5700	5.66
IEEE 802.11n HT40	102	5510	7.06
	110	5550	6.14
	134	5670	5.26
802.11ac-VHT20	100	5500	7.03
	116	5580	5.47
	140	5700	5.67
802.11ac-VHT40	102	5510	7.00
	110	5550	6.11
	134	5670	5.32
802.11ac-VHT80	106	5530	6.52
	122	5610	5.09

<WLAN 5.8GHz Conducted Power>

Mode	Channel	Frequency (MHz)	Average Conducted Output Power(dBm)
IEEE 802.11a	149	5745	5.62
	157	5785	6.12
	165	5825	5.29
IEEE 802.11n HT20	149	5745	5.92
	157	5785	6.53
	165	5825	5.61
IEEE 802.11n HT40	151	5755	5.79
	159	5795	6.42
802.11ac-VHT20	149	5745	5.93
	157	5785	6.52
	165	5825	5.6
802.11ac-VHT40	151	5755	5.79
	159	5795	6.44
802.11ac-VHT80	155	5775	5.93





<BT Conducted Power>

Mode	channel	Frequency (MHz)	Conducted AVG output power (dBm)
GFSK-BLE(1Mbps)	0	2402	5.13
	19	2440	6.59
	39	2480	4.39
GFSK-BLE(2Mbps)	0	2402	5.21
	19	2440	6.64
	39	2480	4.47
GFSK	0	2402	5.83
	39	2441	6.47
	78	2480	4.68
π/4-DQPSK	0	2402	5.24
	39	2441	5.94
	78	2480	4.09
8DPSK	0	2402	5.16
	39	2441	5.87
	78	2480	4.01

Per KDB 447498 D01v06, the 1-g and 10-g SAR test exclusion thresholds for 100 MHz to 6 GHz at test separation distances ≤ 50 mm are determined by:

$$[(\text{max. power of channel, including tune-up tolerance, mW}) / (\text{min. test separation distance, mm})] \cdot [\sqrt{f(\text{GHz})}] \leq 3.0$$

for 1-g SAR and ≤ 7.5 for 10-g extremity SAR

- f(GHz) is the RF channel transmit frequency in GHz
- Power and distance are rounded to the nearest mW and mm before calculation
- The result is rounded to one decimal place for comparison

Bluetooth Tune up Power (dBm)	Separation Distance (mm)	Frequency (GHz)	Exclusion Thresholds
7	5	2.44	1.57

Per KDB 447498 D01v06, when the minimum test separation distance is < 5 mm, a distance of 5 mm is applied to determine SAR test exclusion. The test exclusion threshold is 1.57 < 3.0, SAR testing is not required.



4.2. Transmit Antennas and SAR Measurement Position

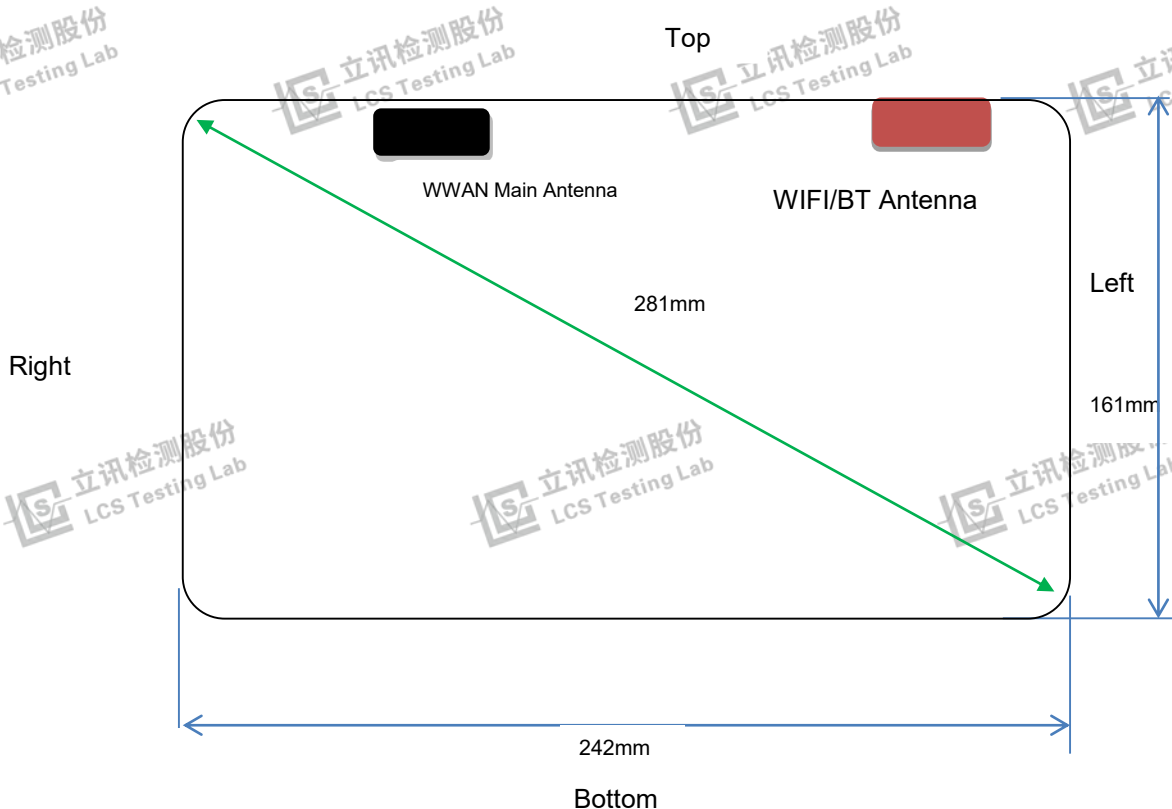

Rear View

Antenna information:

WLAN/BT Antenna	WLAN/BT TX/RX
WWAN Main Antenna	GSM/UMTS/LTE TX/RX

Note:

- 1). Per KDB648474 D04, because the overall diagonal distance of this devices is 286mm>160mm, it is considered as "TABLET PC" device.
- 2). Per KDB648474 D04, 10-g extremity SAR is not required when Body-Worn mode 1-g reported SAR < 1.2 W/Kg.
- 3). According to the KDB941225 D06 Hot Spot SAR v02, the edges with less than 25 mm distance to the antennas need to be tested for SAR.
- 4). Per KDB 616217 D04, The antennas in tablets are typically located near the back (bottom) surface and/or along the edges of the devices; therefore, SAR evaluation is required for these configurations. Exposures from antennas through the front (top) surface of the displaysection of a full-size tablet, away from the edges, are generally limited to the user's hands.

Distance of The Antenna to the EUT surface and edge (mm)

Antennas	Back	Top Side	Bottom Side	Left Side	Right Side
WWAN	<5	<5	150	125	170
BT/WLAN	<5	<5	150	50	150

Positions for SAR tests; Hotspot mode

Antennas	Back	Top Side	Bottom Side	Left Side	Right Side
WWAN	Yes	Yes	No	No	No
BT/WLAN	Yes	Yes	No	No	No

General Note: Referring to KDB 941225 D06 v02, When the overall device length and width are ≥9cm*5cm, the test distance is 10mm, SAR must be measured for all sides and surfaces with a transmitting antenna located with 25mm from that surface or edge.



4.3. SAR Measurement Results

The calculated SAR is obtained by the following formula:

$$\text{Reported SAR} = \text{Measured SAR} * 10^{(P_{\text{target}} - P_{\text{measured}})/10}$$

$$\text{Scaling factor} = 10^{(P_{\text{target}} - P_{\text{measured}})/10}$$

$$\text{Reported SAR} = \text{Measured SAR} * \text{Scaling factor}$$

Where

P_{target} is the power of manufacturing upper limit;

P_{measured} is the measured power;

Measured SAR is measured SAR at measured power which including power drift)

Reported SAR which including Power Drift and Scaling factor

Duty Cycle

Test Mode	Duty Cycle
GPRS850	1:2
GPRS1900	1:4
UMTS	1:1
LTE	1:1
WLAN2450	1:1
5G WLAN	1:1

4.4.1 SAR Results

SAR Values [GSM 850]

Ch.	Freq. (MHz)	Time slots	Test Position	Conducted Power (dBm)	Maximum Allowed Power (dBm)	Power Drift (%)	Scaling Factor	SAR _{1-g} results(W/kg)		Graph Results
								Measured	Reported	
measured / reported SAR numbers - Body (hotspot open, distance 10mm)										
128	824.2	4Txslots	Rear	24.56	25	-2.74	1.107	0.789	0.873	
190	836.6	4Txslots	Rear	24.67	25	1.34	1.079	0.784	0.846	
251	848.8	4Txslots	Rear	24.75	25	-1.79	1.059	0.925	0.980	Plot 1
251	848.8	4Txslots	Top	24.75	25	1.98	1.059	0.466	0.494	

Remark:

- The value with blue color is the maximum SAR Value of each test band.
- The frame average of GPRS (4Tx slots) higher than GSM and sample can support VoIP function, tested at GPRS (4Tx slots) mode for head.
- Per FCC KDB Publication 447498 D01, if the reported (scaled) SAR measured at the middle channel or highest output power channel for each test configuration is ≤ 0.8 W/kg then testing at the other channels is optional for such test configuration(s).

SAR Values [GSM 1900]

Ch.	Freq. (MHz)	time slots	Test Position	Conducted Power (dBm)	Maximum Allowed Power (dBm)	Power Drift (%)	Scaling Factor	SAR _{1-g} results(W/kg)		Graph Results
								Measured	Reported	
measured / reported SAR numbers - Body (hotspot open, distance 10mm)										
512	1850.2	4Txslots	Rear	18.10	18.5	-2.20	1.096	0.74	0.811	Plot 2
512	1850.2	4Txslots	Top	18.10	18.5	1.77	1.096	0.512	0.561	

Remark:

- The value with blue color is the maximum SAR Value of each test band.
- The frame average of GPRS (4Tx slots) higher than GSM and sample can support VoIP function, tested at GPRS (4Tx slots) mode for head.
- Per FCC KDB Publication 447498 D01, if the reported (scaled) SAR measured at the middle channel or highest output power channel for each test configuration is ≤ 0.8 W/kg then testing at the other channels is optional for such test configuration(s).



**SAR Values [WCDMA Band II]**

Ch.	Freq. (MHz)	Channel Type	Test Position	Conducted Power (dBm)	Maximum Allowed Power (dBm)	Power Drift (%)	Scaling Factor	SAR _{1-g} results(W/kg)		Graph Results
								Measured	Reported	
measured / reported SAR numbers - Body (hotspot open, distance 10mm)										
9400	1880	RMC*	Rear	11.94	12	-2.79	1.014	0.429	0.435	Plot 3
9400	1880	RMC*	Top	11.94	12	2.07	1.014	0.311	0.315	

Remark:

1. The value with blue color is the maximum SAR Value of each test band.
2. Per FCC KDB Publication 447498 D01, if the reported (scaled) SAR measured at the middle channel or highest output power channel for each test configuration is ≤ 0.8 W/kg then testing at the other channels is optional for such test configuration(s).
3. RMC* - RMC 12.2kbps mode;

SAR Values [WCDMA Band IV]

Ch.	Freq. (MHz)	Channel Type	Test Position	Conducted Power (dBm)	Maximum Allowed Power (dBm)	Power Drift (%)	Scaling Factor	SAR _{1-g} results(W/kg)		Graph Results
								Measured	Reported	
measured / reported SAR numbers - Body (hotspot open, distance 10mm)										
1413	1740	RMC*	Rear	12.79	13	-1.92	1.050	0.502	0.527	Plot 4
1413	1740	RMC*	Top	12.79	13	2.86	1.050	0.331	0.347	

Remark:

1. The value with blue color is the maximum SAR Value of each test band.
2. Per FCC KDB Publication 447498 D01, if the reported (scaled) SAR measured at the middle channel or highest output power channel for each test configuration is ≤ 0.8 W/kg then testing at the other channels is optional for such test configuration(s).
3. RMC* - RMC 12.2kbps mode;

SAR Values [WCDMA Band V]

Ch.	Freq. (MHz)	Channel Type	Test Position	Conducted Power (dBm)	Maximum Allowed Power (dBm)	Power Drift (%)	Scaling Factor	SAR _{1-g} results(W/kg)		Graph Results
								Measured	Reported	
measured / reported SAR numbers - Body (hotspot open, distance 10mm)										
4183	836.6	RMC*	Rear	14.96	15	-3.55	1.009	0.439	0.443	Plot 5
4183	836.6	RMC*	Top	14.96	15	2.24	1.009	0.311	0.314	

Remark:

1. The value with blue color is the maximum SAR Value of each test band.
2. Per FCC KDB Publication 447498 D01, if the reported (scaled) SAR measured at the middle channel or highest output power channel for each test configuration is ≤ 0.8 W/kg then testing at the other channels is optional for such test configuration(s).

SAR Values [LTE Band 2]

Ch.	Freq. (MHz)	Channel Type (10M)	Test Position	Conducted Power (dBm)	Maximum Allowed Power (dBm)	Power Drift (%)	Scaling Factor	SAR _{1-g} results(W/kg)		Graph Results
								Measured	Reported	
measured / reported SAR numbers - Body (hotspot open, distance 10mm)										
18700	1860	1RB	Rear	14.68	15	2.20	1.076	0.646	0.695	Plot 6
18700	1860	1RB	Top	14.68	15	-1.74	1.076	0.522	0.562	
18700	1860	50%RB	Rear	13.24	13.5	0.32	1.062	0.585	0.621	
18700	1860	50%RB	Top	13.24	13.5	0.76	1.062	0.488	0.518	



**SAR Values [LTE Band 4]**

Ch.	Freq. (MHz)	Channel Type (10M)	Test Position	Conducted Power (dBm)	Maximum Allowed Power (dBm)	Power Drift (%)	Scaling Factor	SAR _{1-g} results(W/kg)		Graph Results
								Measured	Reported	
measured / reported SAR numbers - Body (hotspot open, distance 10mm)										
20300	1745	1RB	Rear	13.94	14	1.19	1.014	0.604	0.612	Plot 7
20300	1745	1RB	Top	13.94	14	-0.61	1.014	0.544	0.552	
20300	1745	50%RB	Rear	12.82	13	2.00	1.042	0.577	0.601	
20300	1745	50%RB	Top	12.82	13	2.41	1.042	0.489	0.510	

SAR Values [LTE Band 5]

Ch.	Freq. (MHz)	Channel Type (10M)	Test Position	Conducted Power (dBm)	Maximum Allowed Power (dBm)	Power Drift (%)	Scaling Factor	SAR _{1-g} results(W/kg)		Graph Results
								Measured	Reported	
measured / reported SAR numbers - Body (hotspot open, distance 10mm)										
20525	836.5	1RB	Rear	15.66	16	0.04	1.081	0.257	0.278	Plot 8
20525	836.5	1RB	Top	15.66	16	-3.84	1.081	0.188	0.203	
20525	836.5	50%RB	Rear	14.51	15.00	-3.33	1.119	0.241	0.270	
20525	836.5	50%RB	Top	14.51	15.00	-0.77	1.119	0.175	0.196	

SAR Values [LTE Band 12]

Ch.	Freq. (MHz)	Channel Type (20M)	Test Position	Conducted Power (dBm)	Maximum Allowed Power (dBm)	Power Drift (%)	Scaling Factor	SAR _{1-g} results(W/kg)		Graph Results
								Measured	Reported	
measured / reported SAR numbers - Body (hotspot open, distance 10mm)										
23095	707.5	1RB	Rear	20.08	20.5	2.82	1.102	0.190	0.209	Plot 9
23095	707.5	1RB	Top	20.08	20.5	-3.95	1.102	0.147	0.162	
23095	707.5	50%RB	Rear	19.06	19.5	3.18	1.107	0.174	0.193	
23095	707.5	50%RB	Top	19.06	19.5	-2.48	1.107	0.133	0.147	

SAR Values [LTE Band 66]

Ch.	Freq. (MHz)	Channel Type (20M)	Test Position	Conducted Power (dBm)	Maximum Allowed Power (dBm)	Power Drift (%)	Scaling Factor	SAR _{1-g} results(W/kg)		Graph Results
								Measured	Reported	
measured / reported SAR numbers - Body (hotspot open, distance 10mm)										
132422	1755	1RB	Rear	14.52	15	-2.32	1.117	0.551	0.615	Plot 10
132422	1755	1RB	Top	14.52	15	2.15	1.117	0.484	0.541	
132422	1755	50%RB	Rear	13.43	13.5	-1.14	1.016	0.532	0.541	
132422	1755	50%RB	Top	13.43	13.5	1.21	1.016	0.436	0.443	

Remark:

- The value with blue color is the maximum SAR Value of each test band.
- Per FCC KDB Publication 447498 D01, if the reported (scaled) SAR measured at the middle channel or highest output power channel for each test configuration is ≤ 0.8 W/kg then testing at the other channels is optional for such test configuration(s).

SAR Values [WIFI2.4G]

Ch.	Freq. (MHz)	Service	Test Position	Conducted Power (dBm)	Maximum Allowed Power (dBm)	Power Drift (%)	Scaling Factor	SAR _{1-g} results(W/kg)		Graph Results
								Measured	Reported	
measured / reported SAR numbers - Body (hotspot open, distance 10mm) <SIM1>										
6	2437	802.11b	Rear	7.48	7.5	1.33	1.005	0.334	0.336	Plot 11
6	2437	802.11b	Top	7.48	7.5	3.86	1.005	0.321	0.322	



**SAR Values [WIFI5.2G]**

Ch.	Freq. (MHz)	Service	Test Position	Conducted Power (dBm)	Maximum Allowed Power (dBm)	Power Drift (%)	Scaling Factor	SAR _{1-g} results(W/kg)		Graph Results
								Measured	Reported	
measured / reported SAR numbers - Body (hotspot open, distance 10mm) <SIM1>										
40	5200	802.11 n-HT20	Rear	7.13	7.5	-2.13	1.089	0.180	0.196	Plot 12
40	5200	802.11 n-HT20	Top	7.13	7.5	-3.85	1.089	0.145	0.158	

SAR Values [WIFI5.3G]

Ch.	Freq. (MHz)	Service	Test Position	Conducted Power (dBm)	Maximum Allowed Power (dBm)	Power Drift (%)	Scaling Factor	SAR _{1-g} results(W/kg)		Graph Results
								Measured	Reported	
measured / reported SAR numbers - Body (hotspot open, distance 10mm) <SIM1>										
60	5300	802.11 n-HT20	Rear	6.81	7	-0.70	1.045	0.209	0.218	Plot 13
60	5300	802.11 n-HT20	Top	6.81	7	-0.37	1.045	0.158	0.165	

SAR Values [WIFI5.6G]

Ch.	Freq. (MHz)	Service	Test Position	Conducted Power (dBm)	Maximum Allowed Power (dBm)	Power Drift (%)	Scaling Factor	SAR _{1-g} results(W/kg)		Graph Results
								Measured	Reported	
measured / reported SAR numbers - Body (hotspot open, distance 10mm) <SIM1>										
102	5510	802.11 n-HT40	Rear	7.06	7.5	0.83	1.107	0.210	0.232	Plot 14
102	5510	802.11 n-HT40	Top	7.06	7.5	1.16	1.107	0.155	0.172	

SAR Values [WIFI5.8G]

Ch.	Freq. (MHz)	Service	Test Position	Conducted Power (dBm)	Maximum Allowed Power (dBm)	Power Drift (%)	Scaling Factor	SAR _{1-g} results(W/kg)		Graph Results
								Measured	Reported	
measured / reported SAR numbers - Body (hotspot open, distance 10mm) <SIM1>										
157	5785	802.11 n-HT20	Rear	6.53	7	-2.81	1.114	0.194	0.216	Plot 15
157	5785	802.11 n-HT20	Top	6.53	7	-2.21	1.114	0.142	0.158	

Remark:

1. The value with blue color is the maximum SAR Value of each test band.
2. Per FCC KDB Publication 447498 D01, if the reported (scaled) SAR measured at the middle channel or highest output power channel for each test configuration is ≤ 0.8 W/kg then testing at the other channels is optional for such test configuration(s).





4.4.2 Standalone SAR Test Exclusion Considerations and Estimated SAR

Per KDB447498 requires when the standalone SAR test exclusion of section 4.3.1 is applied to an antenna that transmits simultaneously with other antennas, the standalone SAR must be estimated according to the following to determine simultaneous transmission SAR test exclusion;

• (max. power of channel, including tune-up tolerance, mW)/(min. test separation distance, mm) • [√ f(GHz)/x] W/kg for test separation distances ≤ 50 mm;
where x = 7.5 for 1-g SAR, and x = 18.75 for 10-g SAR.

•0.4 W/kg for 1-g SAR and 1.0 W/kg for 10-g SAR, when the test separation distances is > 50 mm
Per FCC KD B447498 D01, simultaneous transmission SAR test exclusion may be applied when the sum of the 1-g SAR for all the transmitting antenna in a specific a physical test configuration is ≤1.6 W/Kg. When the sum is greater than the SAR limit, SAR test exclusion is determined by the SAR to peak location separation ratio.

$$\text{Ratio} = \frac{(SAR_1 + SAR_2)^{1.5}}{(\text{peak location separation, mm})} < 0.04$$

Estimated stand alone SAR					
Communication system	Frequency (MHz)	Configuration	Maximum Power (dBm)	Separation Distance (mm)	Estimated SAR _{1-g} (W/kg)
Bluetooth*	2440	Body-worn	7.0	5	0.209

Remark:

1. Bluetooth*- Including Lower power Bluetooth
2. Maximum average power including tune-up tolerance;
3. When the minimum test separation distance is < 5 mm, a distance of 5 mm is applied to determine SAR test exclusion
4. Body as body use distance is 10mm from manufacturer declaration of user manual





4.2 Simultaneous TX SAR Considerations

4.4.4.1 Introduction

Simultaneous transmission SAR test exclusion is determined for each operating configuration and exposure condition according to the reported standalone SAR of each applicable simultaneous transmitting antenna. The device has 4 antennas, WWAN main antenna, WWAN diversity antenna(RX only), and WiFi/BT antenna supports 2.4Wi-Fi and BT. The 2 TX antennas can always transmit simultaneously. The work mode combination is showed as below table.;

Application Simultaneous Transmission information:

Combination No.	Mode
1	WWAN+WIFI
2	WWAN+BT





4.4.2 Evaluation of Simultaneous SAR

Head Exposure Conditions

Simultaneous transmission SAR for WiFi and GSM

Test Position	GSM850 Reported SAR1-g (W/kg)	GSM1900 Reported SAR1-g (W/kg)	WiFi2.4G Reported SAR1-g (W/kg)	WiFi5.2G Reported SAR1-g (W/kg)	WiFi5.3G Reported SAR1-g (W/kg)	WiFi5.6G Reported SAR1-g (W/kg)	WiFi5.8G Reported SAR1-g (W/kg)	MAX. ΣSAR1-g (W/kg)	SAR1-g Limit (W/kg)	Peak location separation ratio	Simut Meas. Required
Rear	0.980	0.811	0.336	0.196	0.218	0.232	0.216	1.316	1.6	no	no
Top	0.494	0.561	0.322	0.158	0.165	0.172	0.158	0.893	1.6	no	no

Simultaneous transmission SAR for WiFi and UMTS

Test Position	UMTS Band II Reported SAR1-g (W/kg)	UMTS Band IV Reported SAR1-g (W/kg)	UMTS Band V Reported SAR1-g (W/kg)	WiFi2.4G Reported SAR1-g (W/kg)	WiFi5.2G Reported SAR1-g (W/kg)	WiFi5.3G Reported SAR1-g (W/kg)	WiFi5.6G Reported SAR1-g (W/kg)	WiFi5.8G Reported SAR1-g (W/kg)	MAX. ΣSAR1-g (W/kg)	SAR1-g Limit (W/kg)	Peak location separation ratio	Simut Meas. Required
Rear	0.435	0.527	0.443	0.336	0.196	0.218	0.232	0.216	0.863	1.6	no	no
Top	0.315	0.347	0.314	0.322	0.158	0.165	0.172	0.158	0.669	1.6	no	no

SAR for WiFi and LTE

Reported SAR1-g(W/kg)	Test Position	
	Rear	Top
LTE Band2	0.695	0.518
LTE Band4	0.612	0.510
LTE Band5	0.278	0.196
LTE Band12	0.209	0.162
LTE Band66	0.615	0.541
WiFi2.4G	0.336	0.322
WiFi5.2G	0.196	0.158
WiFi5.3G	0.218	0.165
WiFi5.6G	0.232	0.172
WiFi5.8G	0.216	0.158
MAX. ΣSAR1-g (W/kg)	0.927	0.713
SAR1-g Limit (W/kg)	1.6	1.6
Peak location separation ratio	no	no
Simut Meas. Required	no	no



**Simultaneous transmission SAR for BT and GSM**

Test Position	GSM850 Reported SAR1-g (W/kg)	GSM1900 Reported SAR1-g (W/kg)	BT Estimated SAR1-g (W/kg)	MAX. Σ SAR1-g (W/kg)	SAR1-g Limit (W/kg)	Peak location separation ratio	Simut Meas. Required
Rear	0.980	0.811	0.209	1.189	1.6	no	no
Top	0.494	0.561	0.209	0.770	1.6	no	no

Simultaneous transmission SAR for BT and UMTS

Test Position	UMTS Band II Reported SAR1-g (W/kg)	UMTS Band IV Reported SAR1-g (W/kg)	UMTS Band V Reported SAR1-g (W/kg)	BT Estimated SAR1-g (W/kg)	MAX. Σ SAR1-g (W/kg)	SAR1-g Limit (W/kg)	Peak location separation ratio	Simut Meas. Required
Rear	0.435	0.527	0.443	0.209	0.736	1.6	no	no
Top	0.315	0.347	0.314	0.209	0.556	1.6	no	no

Simultaneous transmission SAR for BT and LTE

Reported SAR1-g(W/kg)	Test Position	
	Rear	Top
LTE Band2	0.695	0.518
LTE Band4	0.612	0.510
LTE Band5	0.278	0.196
LTE Band12	0.209	0.162
LTE Band66	0.615	0.541
BT Estimated SAR1-g (W/kg)	0.209	0.209
MAX. Σ SAR1-g (W/kg)	0.904	0.750
SAR1-g Limit (W/kg)	1.6	1.6
Peak location separation ratio	no	no
Simut Meas. Required	no	no

Note:

1. The WiFi and BT share same antenna, so cannot transmit at same time.
2. The value with block color is the maximum values of standalone
3. The value with blue color is the maximum values of Σ SAR1-g





4.5 SAR Measurement Variability

According to KDB865664, Repeated measurements are required only when the measured SAR is ≥ 0.80 W/kg. If the measured SAR value of the initial repeated measurement is < 1.45 W/kg with $\leq 20\%$ variation, only one repeated measurement is required to reaffirm that the results are not expected to have substantial variations, which may introduce significant compliance concerns. A second repeated measurement is required only if the measured result for the initial repeated measurement is within 10% of the SAR limit and vary by more than 20%, which are often related to device and measurement setup difficulties. The following procedures are applied to determine if repeated measurements are required. The same procedures should be adapted for measurements according to extremity and occupational exposure limits by applying a factor of 2.5 for extremity exposure and a factor of 5 for occupational exposure to the corresponding SAR thresholds.¹⁹ The repeated measurement results must be clearly identified in the SAR report. All measured SAR, including the repeated results, must be considered to determine compliance and for reporting according to KDB 690783. Repeated measurement is not required when the original highest measured SAR is < 0.80 W/kg; steps 2) through 4) do not apply.

- 1) When the original highest measured SAR is ≥ 0.80 W/kg, repeat that measurement once.
- 2) Perform a second repeated measurement only if the ratio of largest to smallest SAR for the original and first repeated measurements is > 1.20 or when the original or repeated measurement is ≥ 1.45 W/kg ($\sim 10\%$ from the 1-g SAR limit).
- 3) Perform a third repeated measurement only if the original, first or second repeated measurement is ≥ 1.5 W/kg and the ratio of largest to smallest SAR for the original, first and second repeated measurements is > 1.20 .
- 4) Perform a third repeated measurement only if the original, first or second repeated measurement is ≥ 1.5 W/kg and the ratio of largest to smallest SAR for the original, first and second repeated measurements is > 1.20 .

Frequency Band (MHz)	Air Interface	RF Exposure Configuration	Test Position	Repeated SAR (yes/no)	Highest Measured SAR _{1-g} (W/Kg)	First Repeated	
						Measured SAR _{1-g} (W/Kg)	Largest to Smallest SAR Ratio
750	LTE Band 12	Standalone	Body-Rear	no	0.209	n/a	n/a
835	GSM 850	Standalone	Body-Rear	yes	0.980	0.991	0.989
	WCDMA Band V	Standalone	Body-Rear	no	0.443	n/a	n/a
1800	LTE Band 5	Standalone	Body-Rear	no	0.278	n/a	n/a
	WCDMA Band IV	Standalone	Body-Rear	no	0.527	n/a	n/a
	LTE Band 4	Standalone	Body-Rear	no	0.612	n/a	n/a
1900	LTE Band 66	Standalone	Body-Rear	no	0.615	n/a	n/a
	GSM 1900	Standalone	Body-Rear	no	0.811	0.815	0.995
	WCDMA Band II	Standalone	Body-Rear	no	0.435	n/a	n/a
5200	LTE Band 2	Standalone	Body-Rear	no	0.695	n/a	n/a
	2.4GWLAN	Standalone	Body-Rear	no	0.336	n/a	n/a
5280	5.2GWLAN	Standalone	Body-Rear	no	0.196	n/a	n/a
5600	5.3GWLAN	Standalone	Body-Rear	no	0.218	n/a	n/a
5800	5.5GWLAN	Standalone	Body-Rear	no	0.232	n/a	n/a
	5.8GWLAN	Standalone	Body-Rear	no	0.216	n/a	n/a

Remark:

1. Second Repeated Measurement is not required since the ratio of the largest to smallest SAR for the original and first repeated measurement is not > 1.20 or 3 (1-g or 10-g respectively)





4.5. General description of test procedures

1. The DUT is tested using CMU 200 communications testers as controller unit to set test channels and maximum output power to the DUT, as well as for measuring the conducted peak power.
2. Test positions as described in the tables above are in accordance with the specified test standard.
3. Tests in body position were performed in that configuration, which generates the highest time based averaged output power (see conducted power results).
4. Tests in head position with GSM were performed in voice mode with 1 timeslot unless GPRS/EGPRS/DTM function allows parallel voice and data traffic on 2 or more timeslots.
5. UMTS was tested in RMC mode with 12.2 kbit/s and TPC bits set to 'all 1'.
6. WiFi was tested in 802.11b/g/n mode with 1 Mbit/s and 6 Mbit/s. According to KDB 248227 the SAR testing for 802.11g/n is not required since When the highest reported SAR for DSSS is adjusted by the ratio of OFDM to DSSS specified maximum output power and the adjusted SAR is ≤ 1.2 W/kg.
7. Required WiFi test channels were selected according to KDB 248227
8. According to FCC KDB pub 248227 D01, When there are multiple test channels with the same measured maximum output power, the channel closest to mid-band frequency is selected for SAR measurement and when there are multiple test channels with the same measured maximum output power and equal separation from mid-band frequency; for example, high and low channels or two mid-band channels, the higher frequency (number) channel is selected for SAR measurement.
9. According to FCC KDB pub 941225 D06 this device has been tested with 10 mm distance to the phantom for operation in WiFi hot spot mode.
10. Per FCC KDB pub 941225 D06 the edges with antennas within 2.5 cm are required to be evaluated for SAR to cover WiFi hot spot function.
11. According to IEEE 1528 the SAR test shall be performed at middle channel. Testing of top and bottom channel is optional.
12. According to KDB 447498 D01 testing of other required channels within the operating mode of a frequency band is not required when the reported 1-g or 10-g SAR for the mid-band or highest output power channel is:
 - ≤ 0.8 W/kg or 2.0 W/kg, for 1-g or 10-g respectively, when the transmission band is ≤ 100 MHz
 - ≤ 0.6 W/kg or 1.5 W/kg, for 1-g or 10-g respectively, when the transmission band is between 100 MHz and 200 MHz
 - ≤ 0.4 W/kg or 1.0 W/kg, for 1-g or 10-g respectively, when the transmission band is ≥ 200 MHz
13. IEEE 1528-2003 require the middle channel to be tested first. This generally applies to wireless devices that are designed to operate in technologies with tight tolerances for maximum output power variations across channels in the band.
14. Per KDB648474 D04 require when the reported SAR for a body-worn accessory, measured without a headset connected to the handset, is < 1.2 W/kg.
15. Per KDB648474 D04 require when the separation distance required for body-worn accessory testing is larger than or equal to that tested for hotspot mode, using the same wireless mode test configuration for voice and data, such as UMTS and Wi-Fi, and for the same surface of the phone, the hotspot mode SAR data may be used to support body-worn accessory SAR compliance for that particular configuration (surface)
16. 10-g extremity SAR is required only for the surfaces and edges with hotspot mode 1-g SAR > 1.2 W/kg.
17. Per KDB648474 D04 require for phablet SAR test considerations. For Mobile Phones with a display diagonal dimension > 15.0 cm or an overall diagonal dimension > 16.0 cm, When hotspot mode applies, 10-g extremity SAR is required only for the surfaces and edges with hotspot mode 1-g reported SAR > 1.2 W/kg.
18. 10-g extremity SAR is required only for the surfaces and edges with hotspot mode 1-g SAR > 1.2 W/kg.

4.6. Measurement Uncertainty (450MHz-6GHz)

Not required as SAR measurement uncertainty analysis is required in SAR reports only when the highest measured SAR in a frequency band is ≥ 1.5 W/kg for 1-g SAR according to KDB865664D01.



Shenzhen LCS Compliance Testing Laboratory Ltd.

Add: 101, 201 Bldg A & 301 Bldg C, Juji Industrial Park Yabianxueziwei, Shajing Street, Baoan District, Shenzhen, 518000, China

Tel: +(86) 0755-82591330 | E-mail: webmaster@lcs-cert.com | Web: www.lcs-cert.com

Scan code to check authenticity

4.7. System Check Results

Test mode:750MHz(Head)
 Product Description:Validation
 Model:Dipole SID750
 E-Field Probe: SSE2(SN 25/22 EPGO376)
 Test Date: Nov. 13, 2023

Medium(liquid type)	HSL_750
Frequency (MHz)	750.0000
Relative permittivity (real part)	41.2
Conductivity (S/m)	0.87
Input power	100mW
Crest Factor	1.0
Conversion Factor	1.69
Variation (%)	1.020000
SAR 10g (W/Kg)	0.577251
SAR 1g (W/Kg)	0.834225
SURFACE SAR	VOLUME SAR

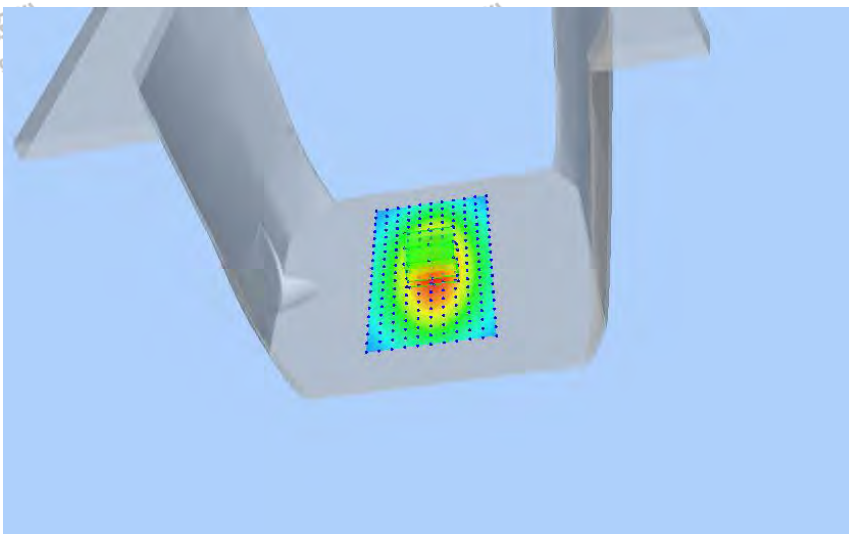
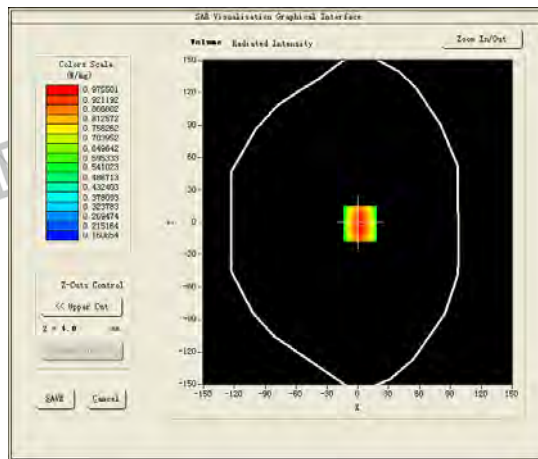
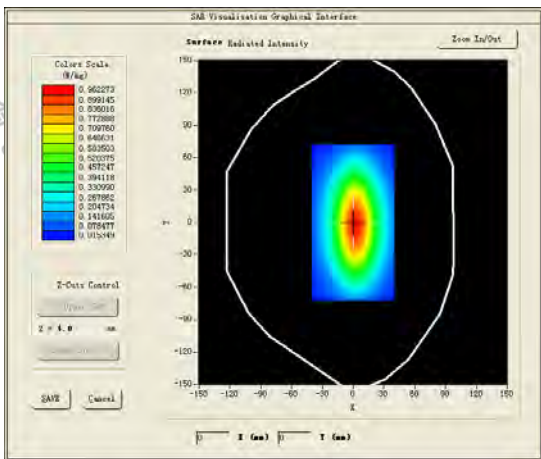

Test mode:835MHz(Head)
 Product Description:Validation
 Model:Dipole SID835
 E-Field Probe:SSE2(SN 25/22 EPGO376)
 Test Date: Nov. 13, 2023

Medium(liquid type)	HSL 850
Frequency (MHz)	835.0000
Relative permittivity (real part)	41.60
Conductivity (S/m)	0.94
Input power	100mW
Crest Factor	1.0
Conversion Factor	1.75
Variation (%)	2.780000
SAR 10g (W/Kg)	0.624431
SAR 1g (W/Kg)	0.966150

SURFACE SAR

VOLUME SAR

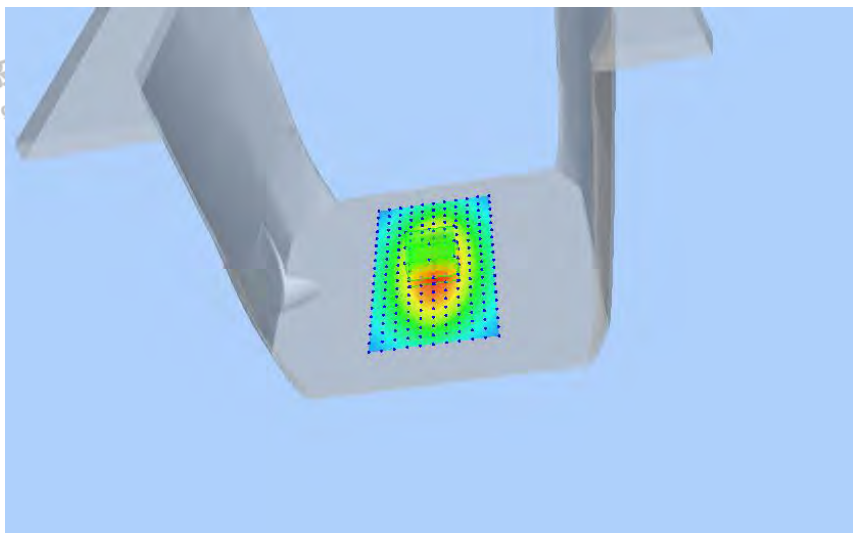
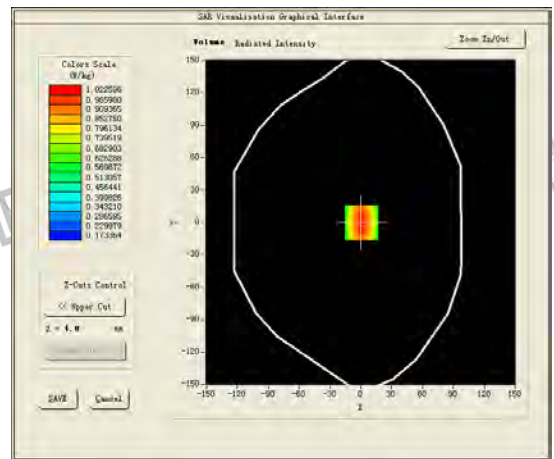
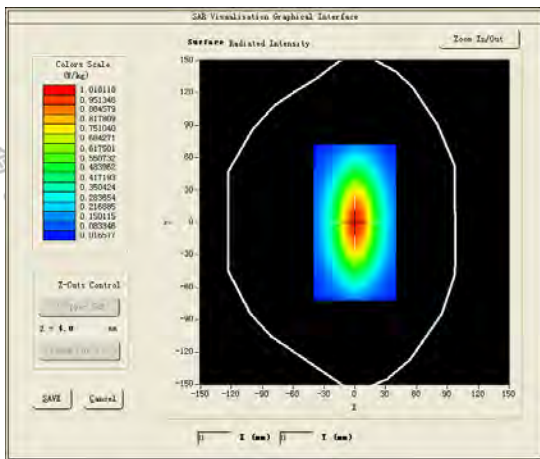

Test mode:1800MHz(Head)
 Product Description:Validation
 Model :Dipole SID1800
 E-Field Probe:SSE2(SN 25/22 EPGO376)
 Test Date: Nov. 15, 2023

Medium(liquid type)	HSL_1800
Frequency (MHz)	1800.0000
Relative permittivity (real part)	39.80
Conductivity (S/m)	1.41
Input power	100mW
Crest Factor	1.0
Conversion Factor	2.09
Variation (%)	1.740000
SAR 10g (W/Kg)	2.055413
SAR 1g (W/Kg)	3.944251

SURFACE SAR

VOLUME SAR

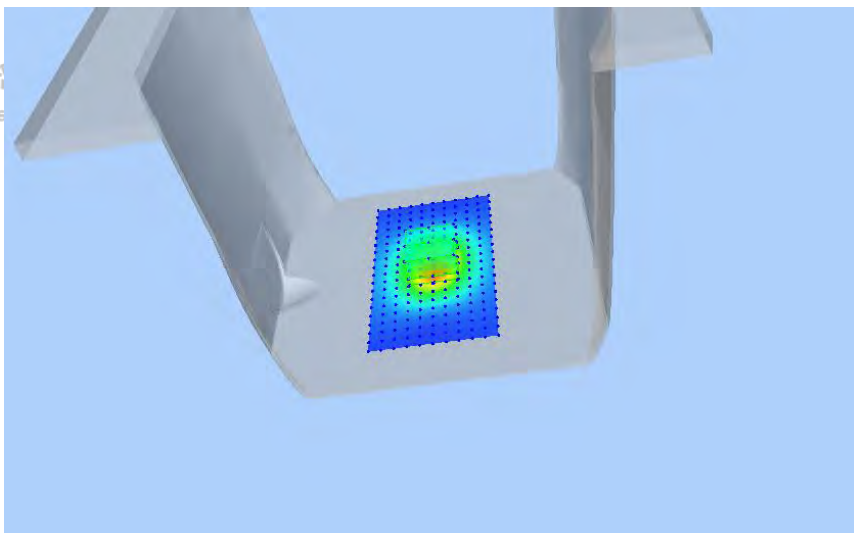
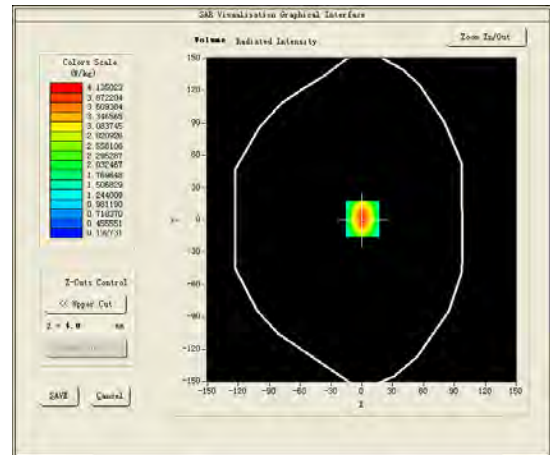
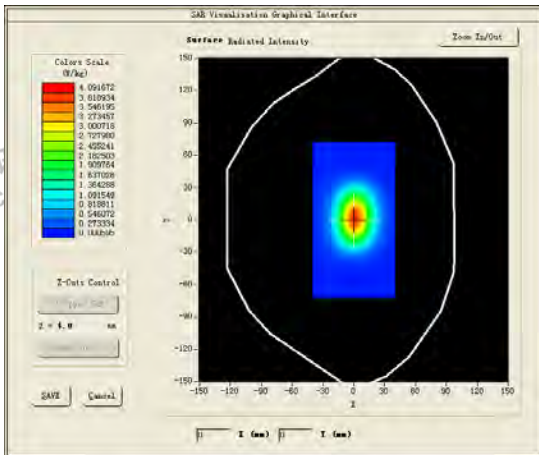

Test mode:1900MHz(Head)
 Product Description:Validation
 Model :Dipole SID1900
 E-Field Probe: SSE2(SN 25/22 EPGO376)
 Test Date: Nov. 15, 2023

Medium(liquid type)	HSL_1900
Frequency (MHz)	1900.0000
Relative permittivity (real part)	40.98
Conductivity (S/m)	1.44
Input power	100mW
Crest Factor	1.0
Conversion Factor	2.14
Variation (%)	-1.280000
SAR 10g (W/Kg)	2.104721
SAR 1g (W/Kg)	4.102354

SURFACE SAR

VOLUME SAR

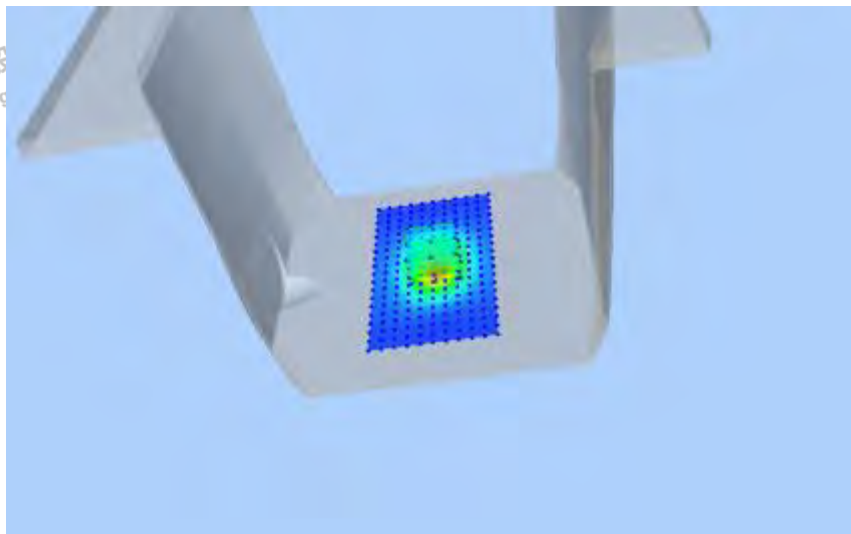
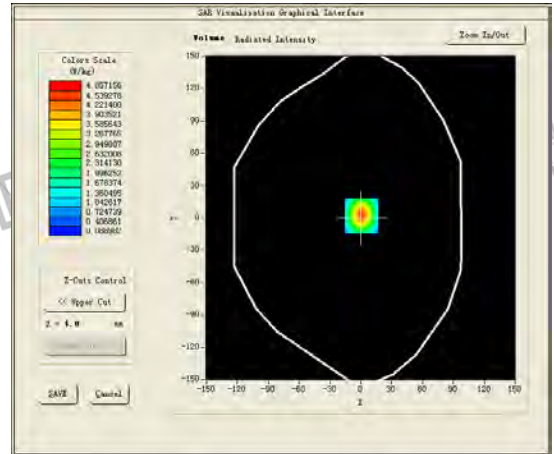
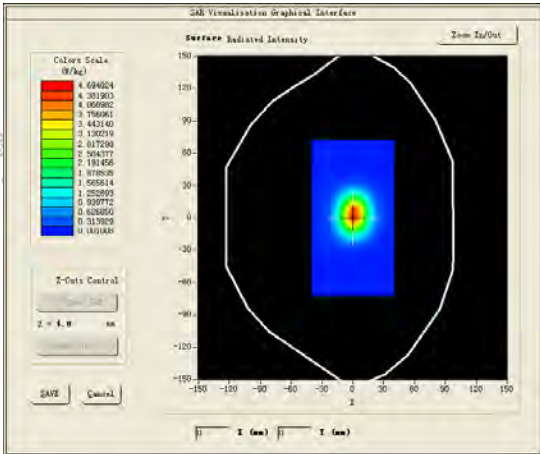

Test mode:2450MHz(Head)
 Product Description:Validation
 Model:Dipole SID2450
 E-Field Probe:SSE2(SN 25/22 EPGO376)
 Test Date: Nov. 17, 2023

Medium(liquid type)	HSL_2450
Frequency (MHz)	2450.0000
Relative permittivity (real part)	38.90
Conductivity (S/m)	1.85
Input power	100mW
Crest Factor	1.0
Conversion Factor	2.60
Variation (%)	-0.320000
SAR 10g (W/Kg)	2.511258
SAR 1g (W/Kg)	5.331584

SURFACE SAR

VOLUME SAR

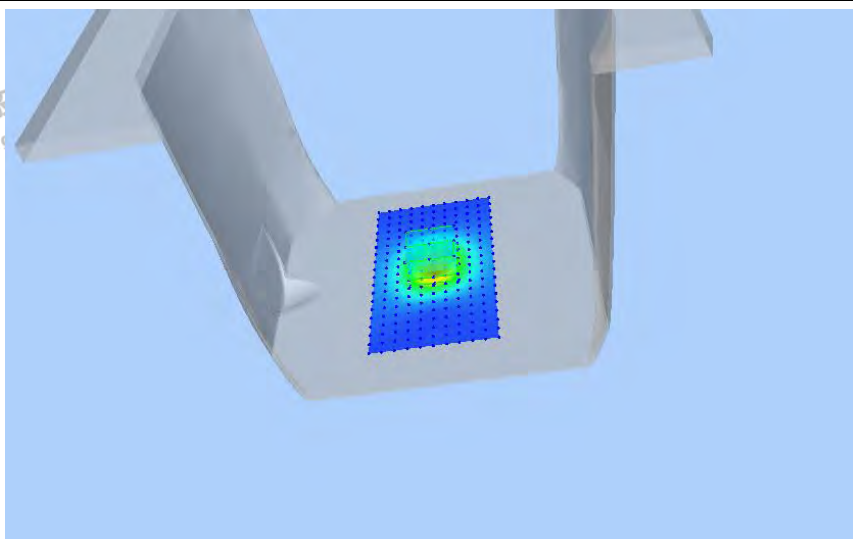
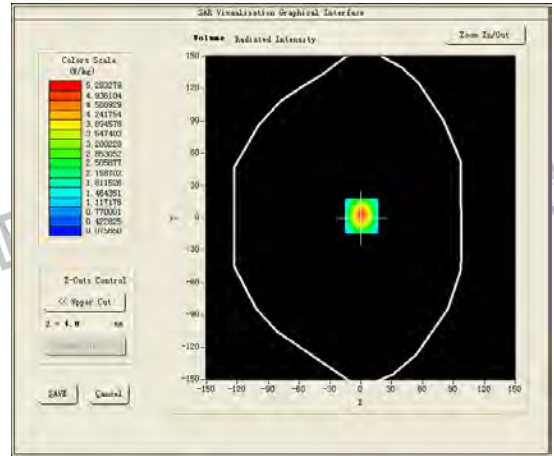
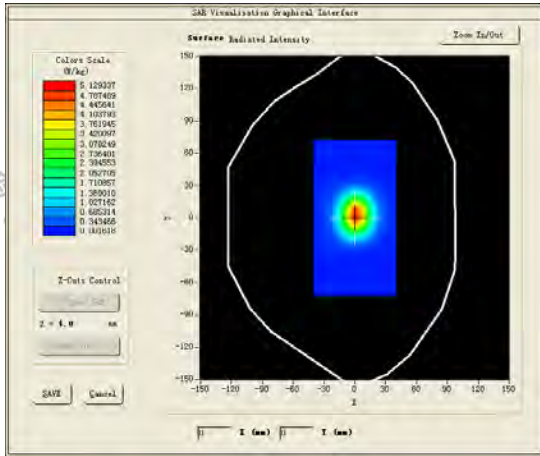



Test mode:5200MHz(Head)
 Product Description:Validation
 Model:Dipole SWG5500
 E-Field Probe: SSE2(SN 25/22_EPGO376)
 Test Date: Nov. 21, 2023

Medium(liquid type)	HSL_5000
Frequency (MHz)	5200.0000
Relative permittivity (real part)	35.40
Conductivity (S/m)	4.88
Input power	100mW
Crest Factor	1.0
Conversion Factor	1.85
Variation (%)	-3.110000
SAR 10g (W/Kg)	5.511824
SAR 1g (W/Kg)	16.442147

SURFACE SAR

VOLUME SAR

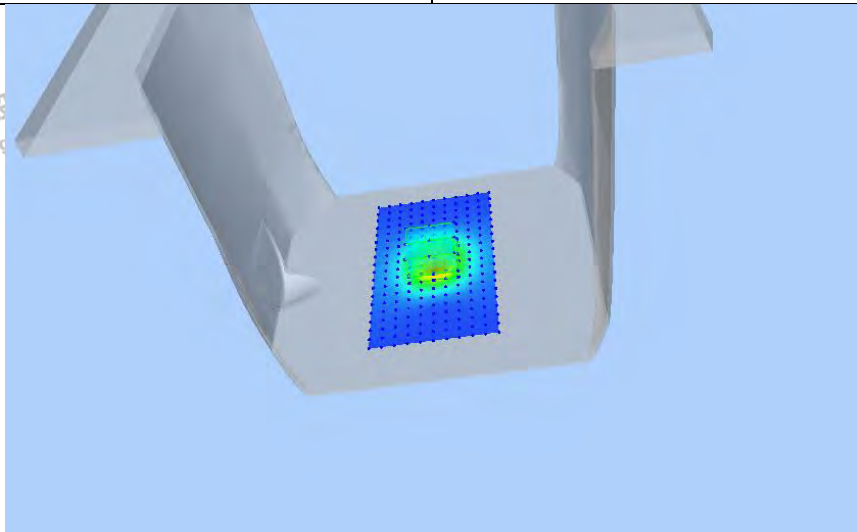
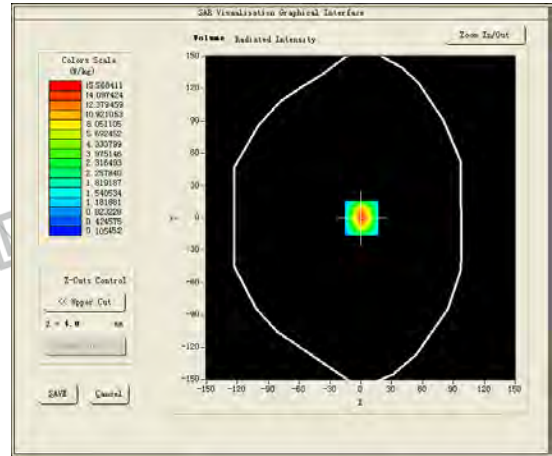
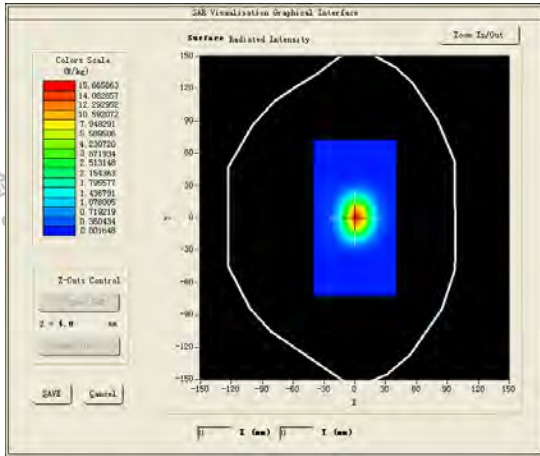

Test mode:5300MHz(Head)
 Product Description:Validation
 Model:Dipole SWG5500
 E-Field Probe: SSE2(SN 25/22 EPGO376)
 Test Date: Nov. 21, 2023

Medium(liquid type)	HSL_5000
Frequency (MHz)	5280.0000
Relative permittivity (real part)	34.80
Conductivity (S/m)	4.71
Input power	100mW
Crest Factor	1.0
Conversion Factor	2.07
Variation (%)	3.890000
SAR 10g (W/Kg)	5.751721
SAR 1g (W/Kg)	16.852147
SURFACE SAR	VOLUME SAR

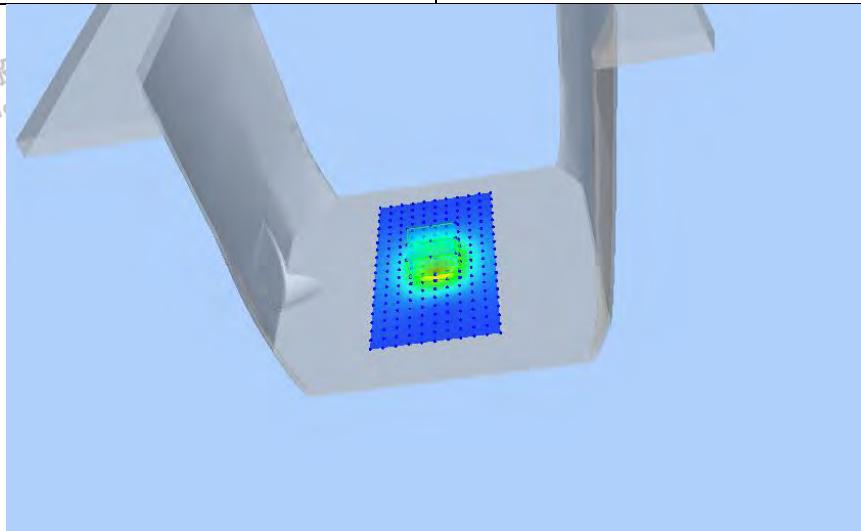
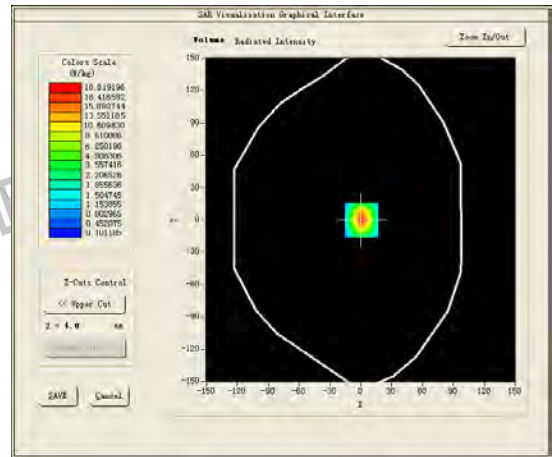
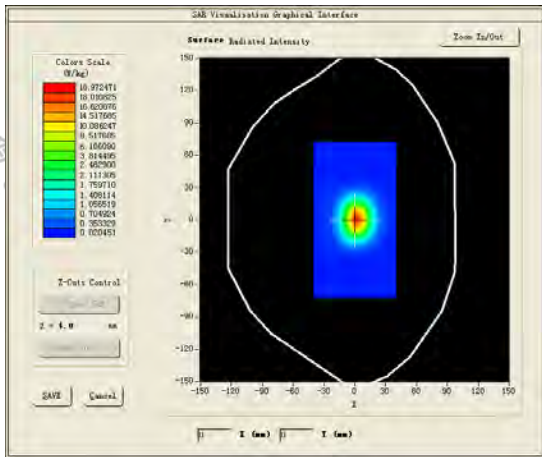

Test mode:5500MHz(Head)
 Product Description:Validation
 Model:Dipole SWG5500
 E-Field Probe: SSE2(SN 25/22 EPGO376)
 Test Date: Nov. 21, 2023

Medium(liquid type)	HSL_5000
Frequency (MHz)	5600.0000
Relative permittivity (real part)	34.70
Conductivity (S/m)	4.95
Input power	100mW
Crest Factor	1.0
Conversion Factor	2.19
Variation (%)	1.000000
SAR 10g (W/Kg)	5.847258
SAR 1g (W/Kg)	17.115224

SURFACE SAR

VOLUME SAR

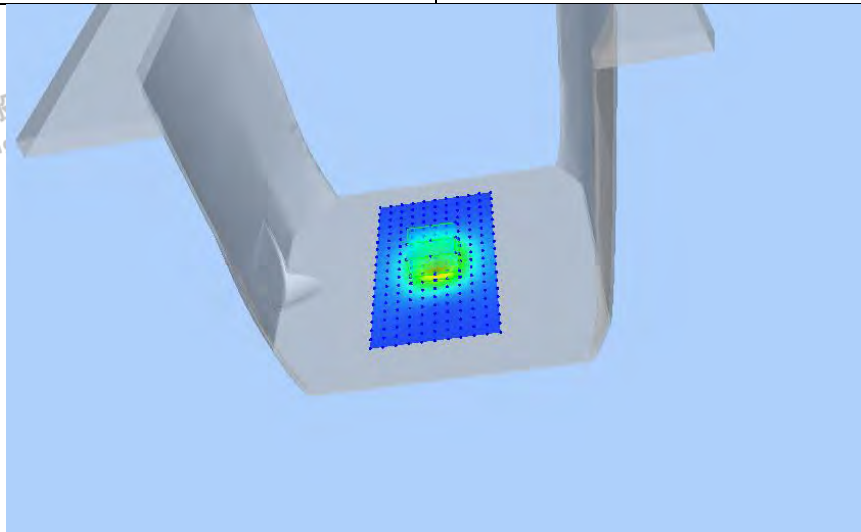
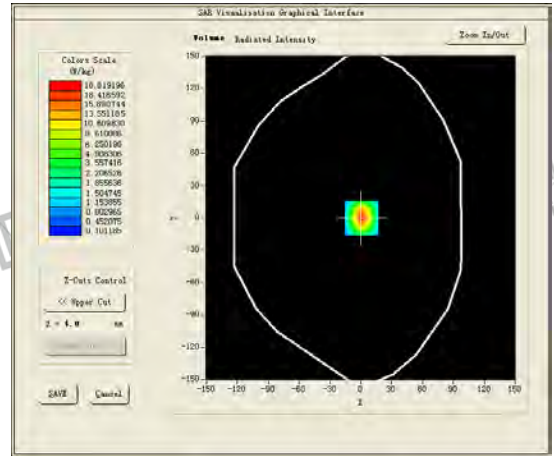
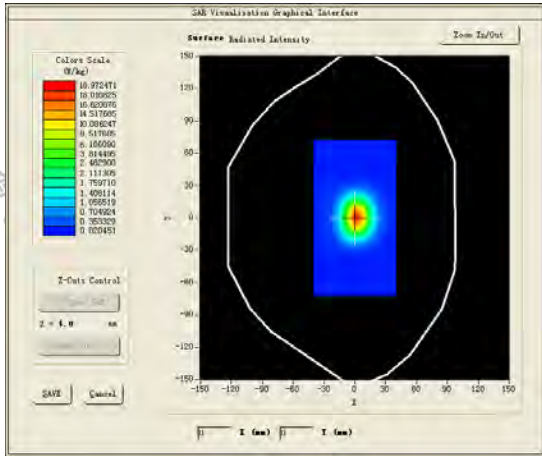

Test mode:5800MHz(Head)
 Product Description:Validation
 Model:Dipole SWG5500
 E-Field Probe: SSE2(SN 25/22 EPGO376)
 Test Date: Nov. 21, 2023

Medium(liquid type)	HSL_5000
Frequency (MHz)	5800.0000
Relative permittivity (real part)	35.90
Conductivity (S/m)	5.41
Input power	100mW
Crest Factor	1.0
Conversion Factor	2.01
Variation (%)	-1.960000
SAR 10g (W/Kg)	5.970145
SAR 1g (W/Kg)	18.254336
SURFACE SAR	VOLUME SAR

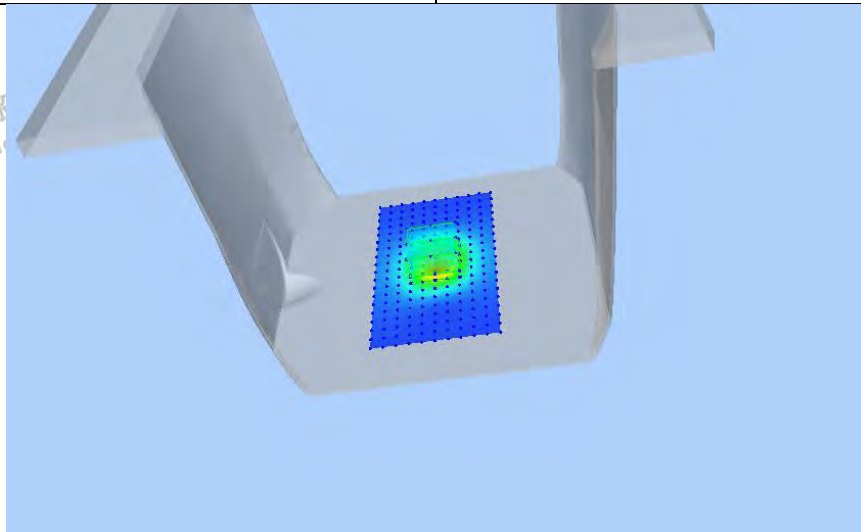
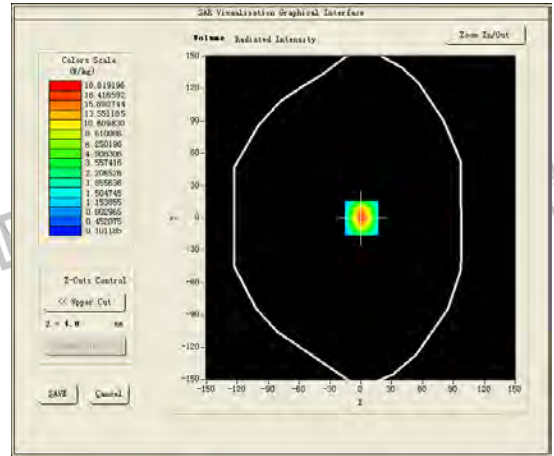
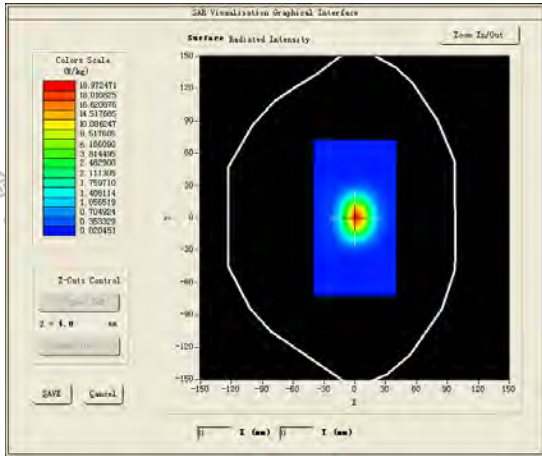

4.8 SAR Test Graph Results

SAR plots for the highest measured SAR in each exposure configuration, wireless mode and frequency band combination according to FCC KDB 865664 D02;

#1

Test Mode: GSM850MHZ, Low channel(Body Rear Side)

Product Description: 10.1 inch Quad Core 4G Tablet PC

Model: R10

Test Date: Nov. 13, 2023

Medium(liquid type)	HSL 835
Frequency (MHz)	848.8000
Relative permittivity (real part)	41.6
Conductivity (S/m)	0.94
E-Field Probe	SN 25/22 EPGO376
Crest Factor	2.0
Conversion Factor	1.75
Sensor	4mm
Area Scan	dx=15mm dy=15mm
Zoom Scan	5x5x7,dx=8mm dy=8mm dz=5mm
Variation (%)	-0.180000
SAR 10g (W/Kg)	0.497389
SAR 1g (W/Kg)	0.924617
SURFACE SAR	VOLUME SAR

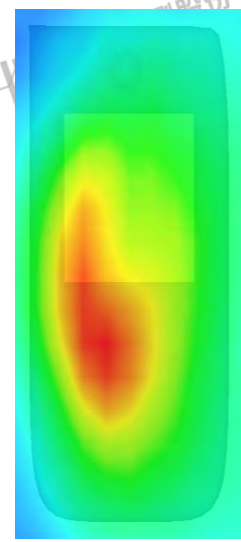
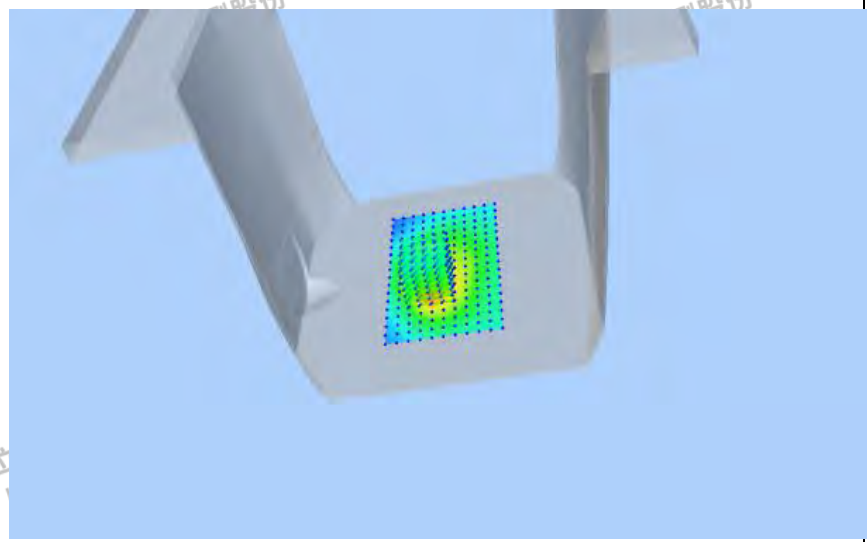
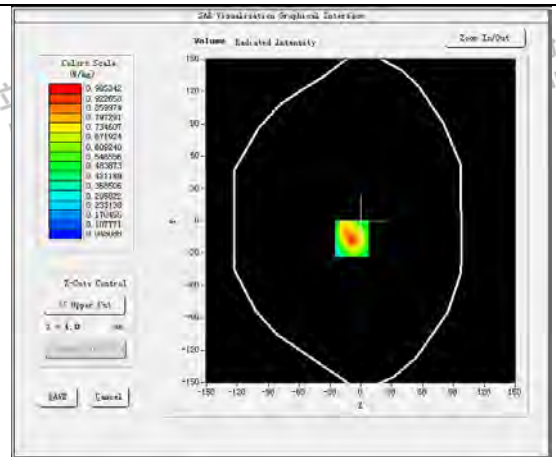
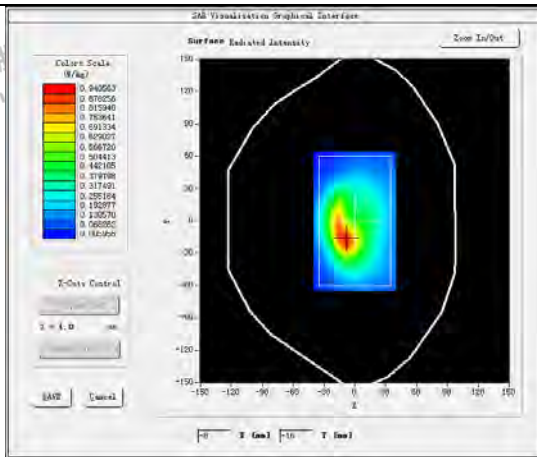

#2

Test Mode: GPRS1900MHz, Low channel(Body Rear Side)

Product Description: 10.1 inch Quad Core 4G Tablet PC

Model: R10

Test Date: Nov. 15, 2023

Medium(liquid type)	HSL_1900
Frequency (MHz)	1950.2000
Relative permittivity (real part)	40.98
Conductivity (S/m)	1.44
E-Field Probe	SN 25/22 EPGO376
Crest Factor	2.0
Conversion Factor	2.14
Sensor	4mm
Area Scan	dx=15mm dy=15mm
Zoom Scan	5x5x7,dx=8mm dy=8mm dz=5mm
Variation (%)	2.250000
SAR 10g (W/Kg)	0.364755
SAR 1g (W/Kg)	0.739860

SURFACE SAR

VOLUME SAR

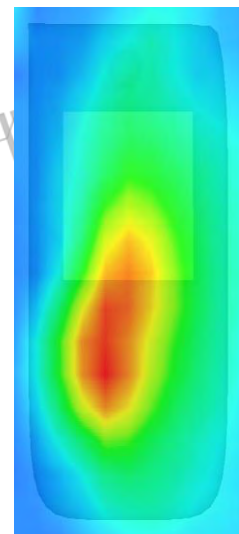
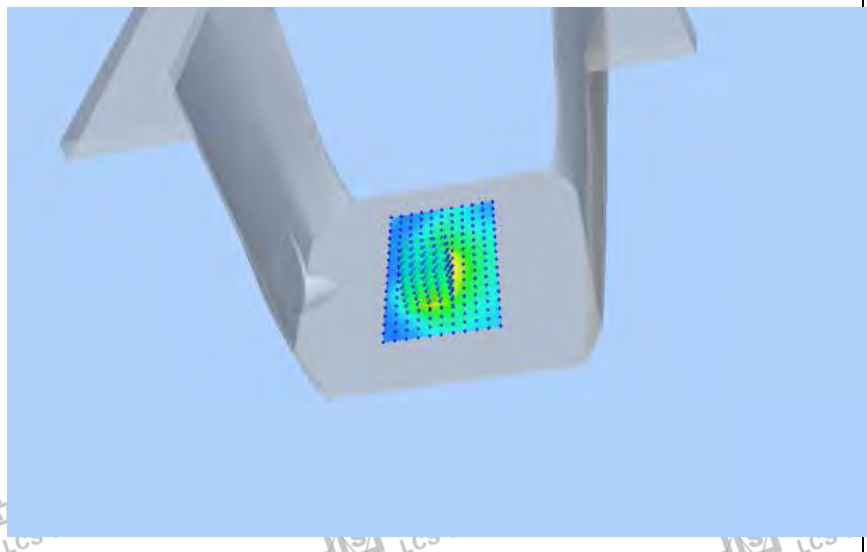
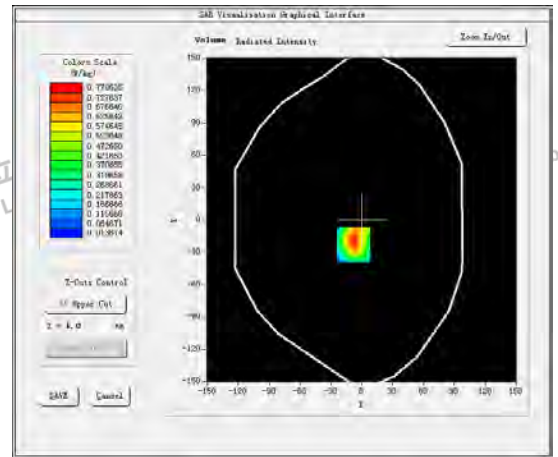
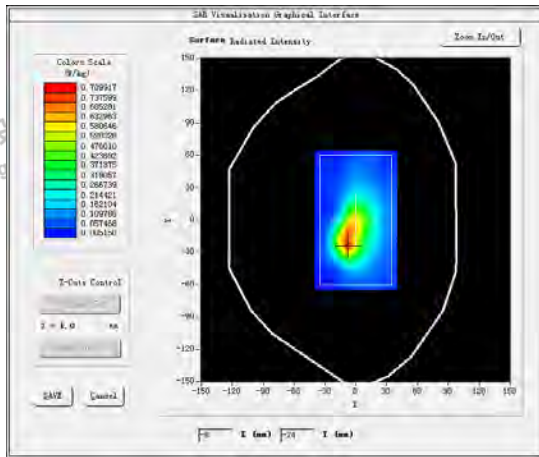

#3

Test Mode: WCDMA Band II, Mid channel(Body Rear Side)

Product Description: 10.1 inch Quad Core 4G Tablet PC

Model: R10

Test Date: Nov. 15, 2023

Medium(liquid type)	HSL_1900
Frequency (MHz)	1880.0000
Relative permittivity (real part)	40.98
Conductivity (S/m)	1.44
E-Field Probe	SN 25/22 EPGO376
Crest Factor	1.0
Conversion Factor	1.75
Sensor	4mm
Area Scan	dx=15mm dy=15mm
Zoom Scan	5x5x7,dx=8mm dy=8mm dz=5mm
Variation (%)	-0.230000
SAR 10g (W/Kg)	0.212340
SAR 1g (W/Kg)	0.428762
SURFACE SAR	VOLUME SAR

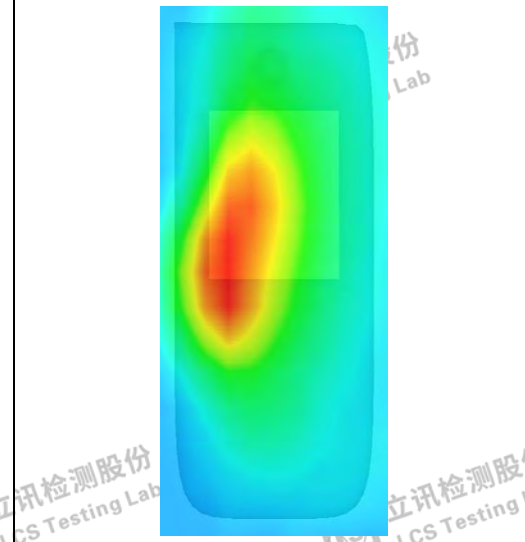
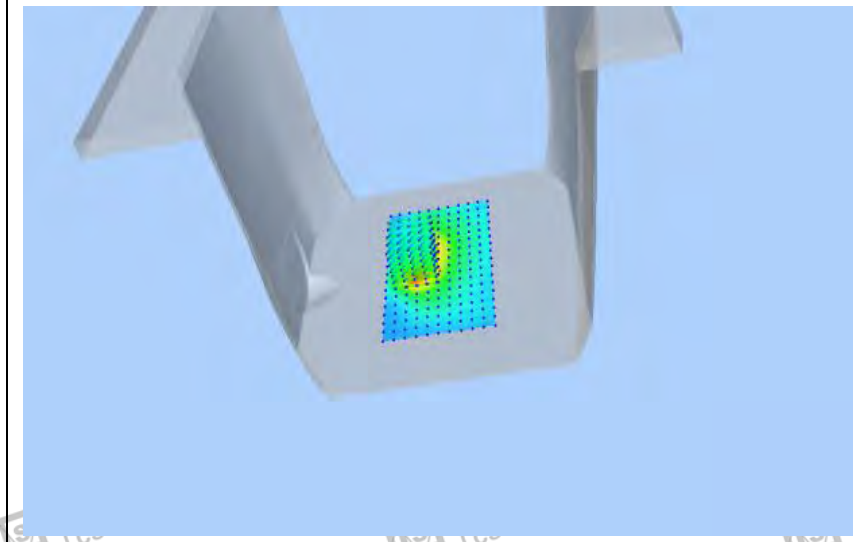
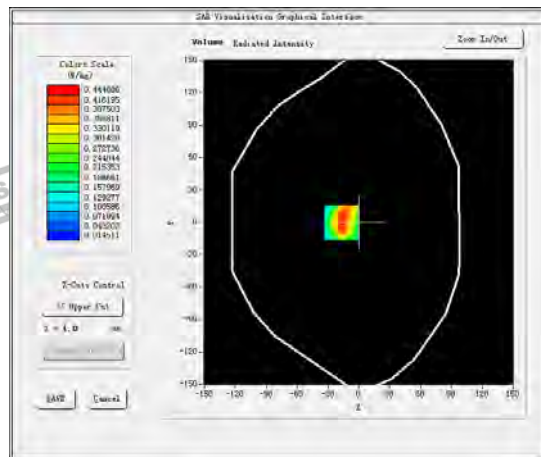
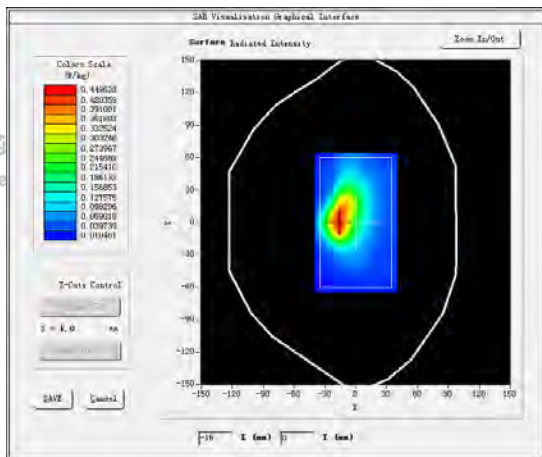

#4

Test Mode: WCDMA Band IV, Mid channel (Body Rear Side)

Product Description: 10.1 inch Quad Core 4G Tablet PC

Model: R10

Test Date: Nov. 15, 2023

Medium (liquid type)	HSL_1800
Frequency (MHz)	1740.0000
Relative permittivity (real part)	39.80
Conductivity (S/m)	1.41
E-Field Probe	SN 25/22 EPGO376
Crest Factor	1.0
Conversion Factor	2.14
Sensor	4mm
Area Scan	dx=15mm dy=15mm
Zoom Scan	5x5x7, dx=8mm dy=8mm dz=5mm
Variation (%)	-0.380000
SAR 10g (W/Kg)	0.262427
SAR 1g (W/Kg)	0.502449
SURFACE SAR	VOLUME SAR

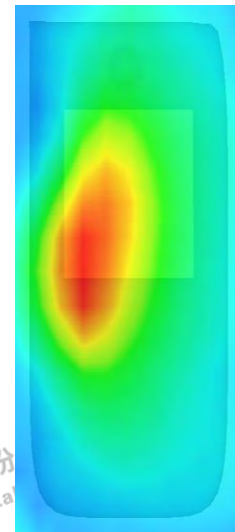
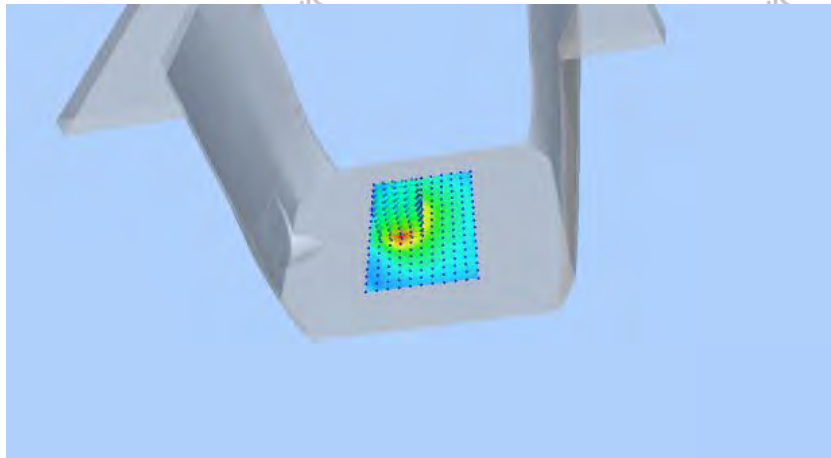
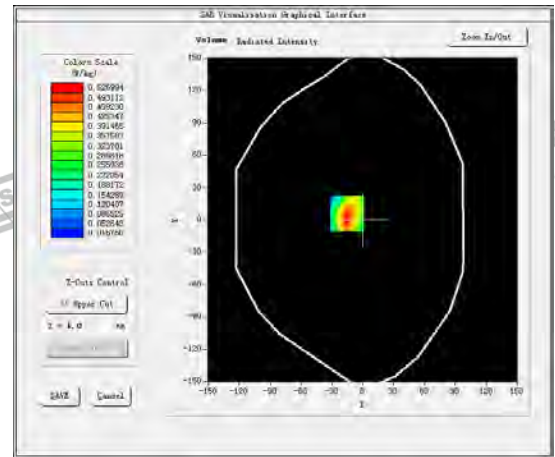
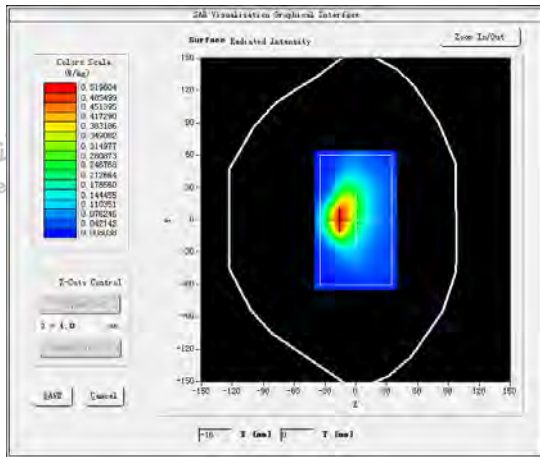

#5

Test Mode: WCDMA Band V, Mid channel (Body Rear Side)

Product Description: 10.1 inch Quad Core 4G Tablet PC

Model: R10

Test Date: Nov. 13, 2023

Medium (liquid type)	HSL_835
Frequency (MHz)	836.4000
Relative permittivity (real part)	41.60
Conductivity (S/m)	0.94
E-Field Probe	SN 25/22 EPGO376
Crest Factor	1.0
Conversion Factor	2.14
Sensor	4mm
Area Scan	dx=15mm dy=15mm
Zoom Scan	5x5x7, dx=8mm dy=8mm dz=5mm
Variation (%)	-0.380000
SAR 10g (W/Kg)	0.243557
SAR 1g (W/Kg)	0.439484
SURFACE SAR	VOLUME SAR

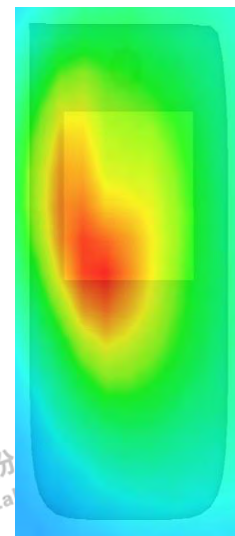
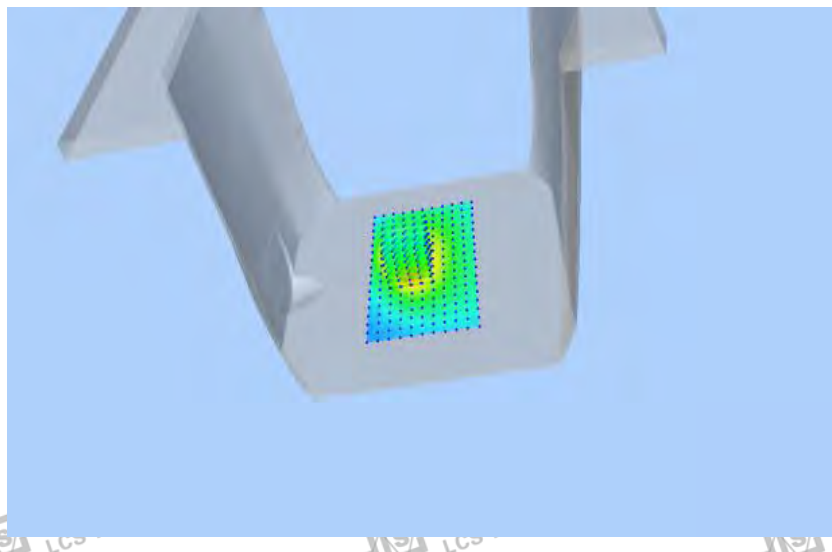
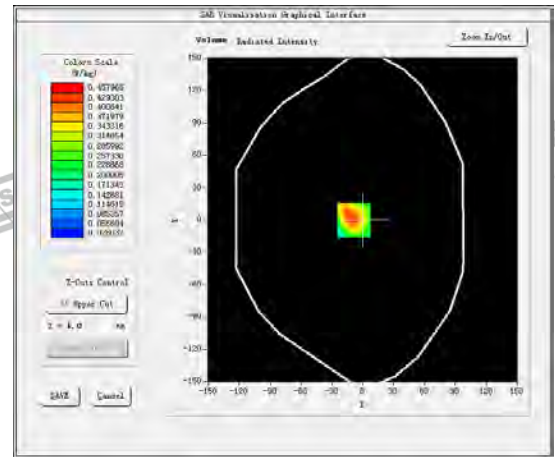
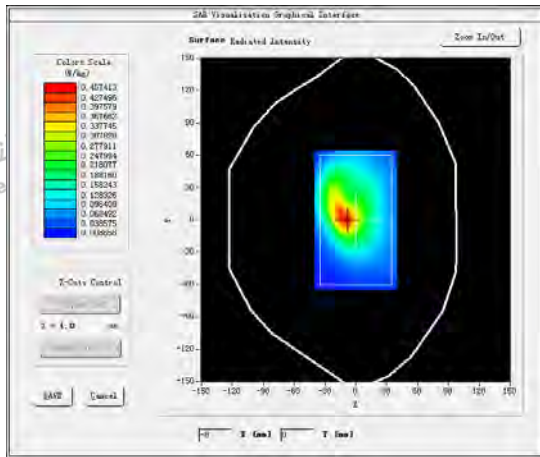

#6

Test Mode: LTE Band 2, 1RB, Low channel(Body Rear Side)

Product Description: 10.1 inch Quad Core 4G Tablet PC

Model: R10

Test Date: Nov. 13, 2023

Medium(liquid type)	HSL_1900
Frequency (MHz)	1860.0000
Relative permittivity (real part)	40.98
Conductivity (S/m)	1.44
E-Field Probe	SN 25/22 EPGO376
Crest Factor	1.0
Conversion Factor	2.14
Sensor	4mm
Area Scan	dx=15mm dy=15mm
Zoom Scan	5x5x7,dx=8mm dy=8mm dz=5mm
Variation (%)	-0.100000
SAR 10g (W/Kg)	0.324016
SAR 1g (W/Kg)	0.645879

SURFACE SAR

VOLUME SAR

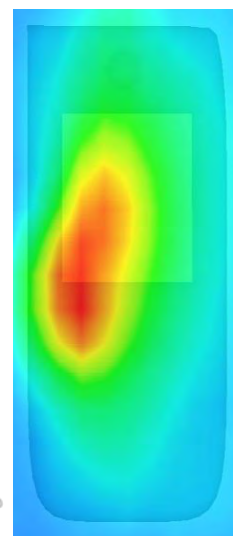
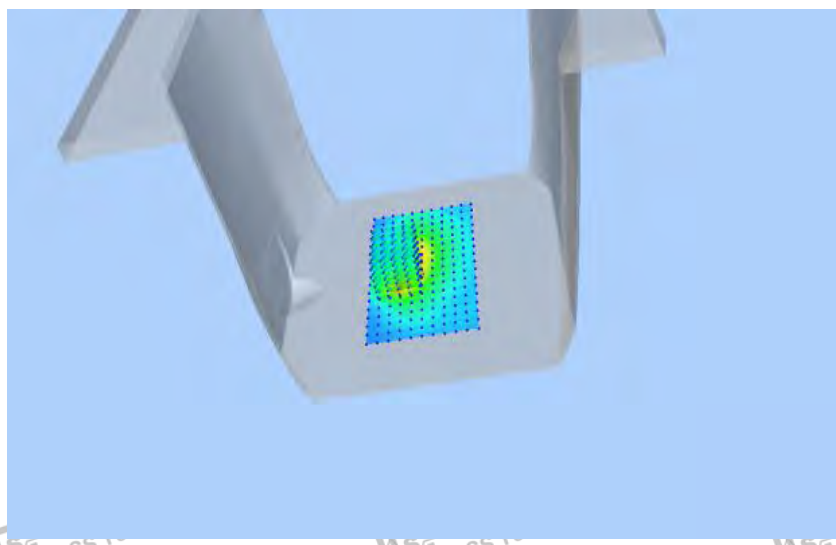
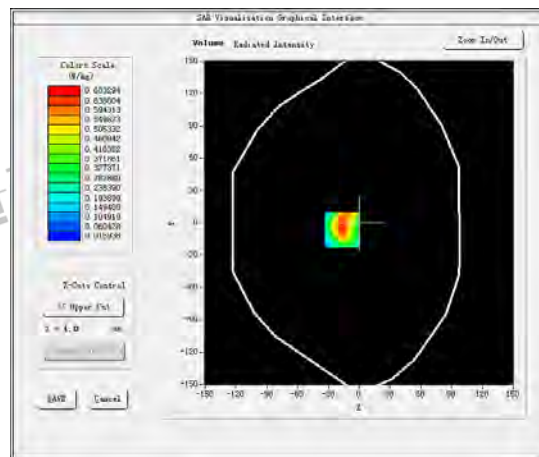
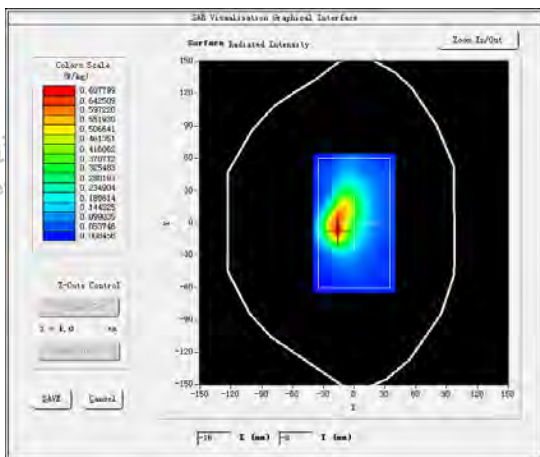

#7

Test Mode: LTE Band 4, 1RB, High channel(Body Rear Side)

Product Description: 10.1 inch Quad Core 4G Tablet PC

Model: R10

Test Date: Nov. 15, 2023

Medium(liquid type)	HSL_1800
Frequency (MHz)	1745.0000
Relative permittivity (real part)	39.50
Conductivity (S/m)	1.41
E-Field Probe	SN 25/22 EPGO376
Crest Factor	1.0
Conversion Factor	2.09
Sensor	4mm
Area Scan	dx=15mm dy=15mm
Zoom Scan	5x5x7,dx=8mm dy=8mm dz=5mm
Variation (%)	0.340000
SAR 10g (W/Kg)	0.313290
SAR 1g (W/Kg)	0.604164

SURFACE SAR

VOLUME SAR

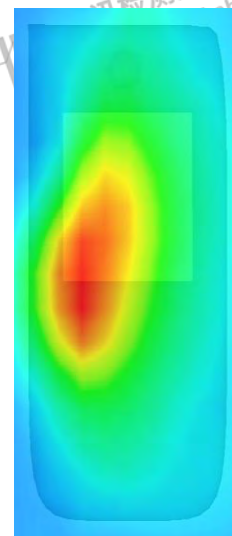
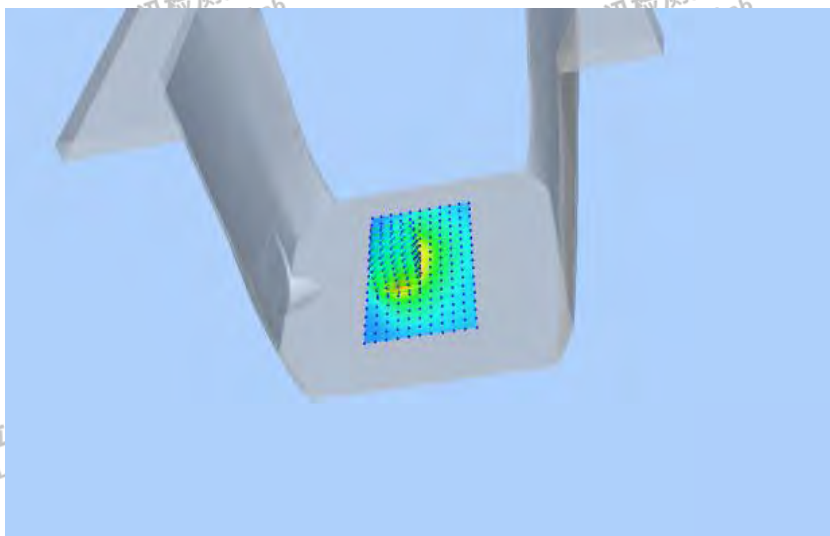
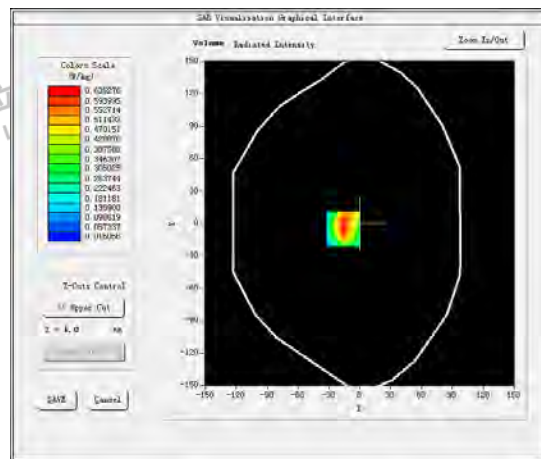
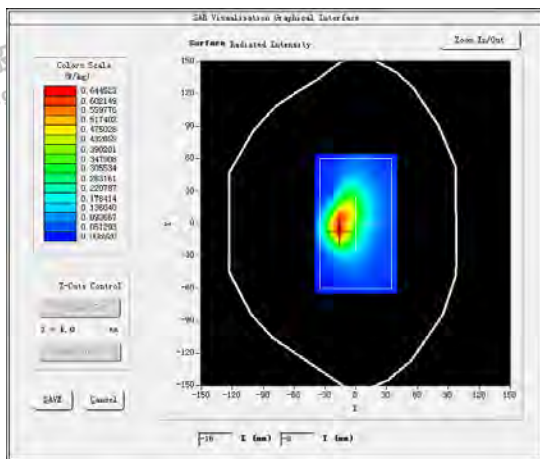

#8

Test Mode: LTE Band 5, 1RB, Mid channel(Body Rear Side)

Product Description: 10.1 inch Quad Core 4G Tablet PC

Model: R10

Test Date: Nov. 13, 2023

Medium(liquid type)	HSL_835
Frequency (MHz)	836.5000
Relative permittivity (real part)	41.60
Conductivity (S/m)	0.94
E-Field Probe	SN 25/22 EPGO376
Crest Factor	1.0
Conversion Factor	1.75
Sensor	4mm
Area Scan	dx=15mm dy=15mm
Zoom Scan	5x5x7,dx=8mm dy=8mm dz=5mm
Variation (%)	-0.230000
SAR 10g (W/Kg)	0.144957
SAR 1g (W/Kg)	0.256668
SURFACE SAR	VOLUME SAR

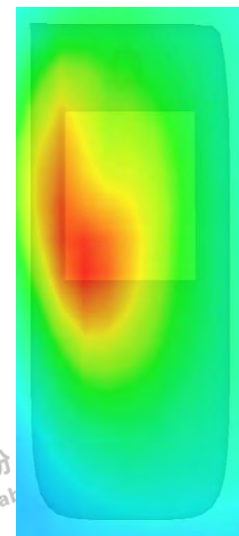
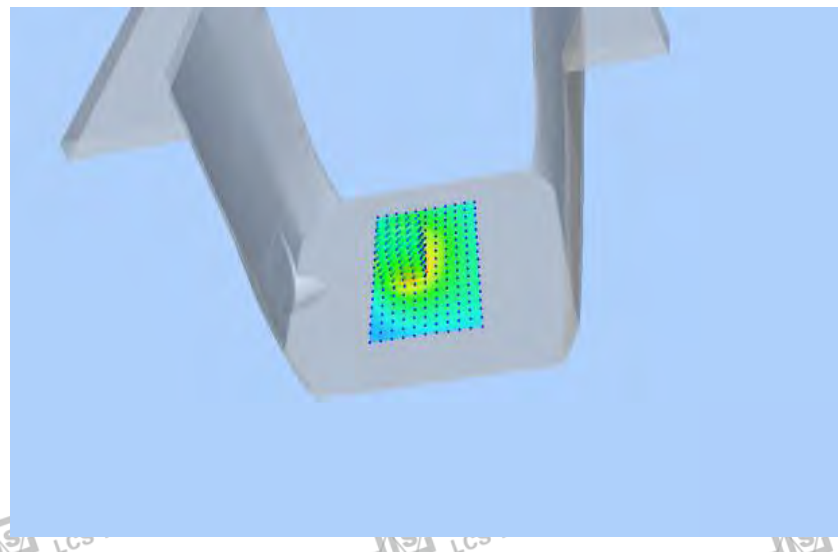
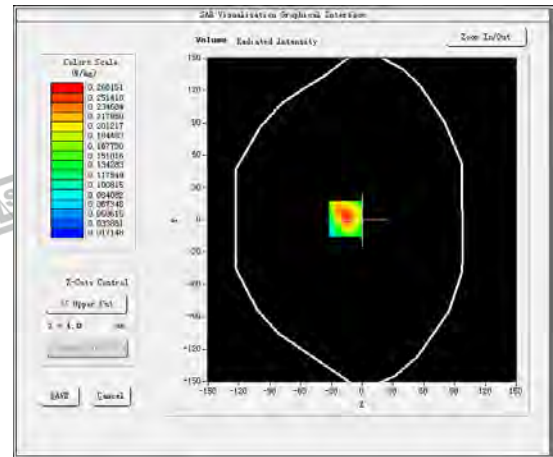
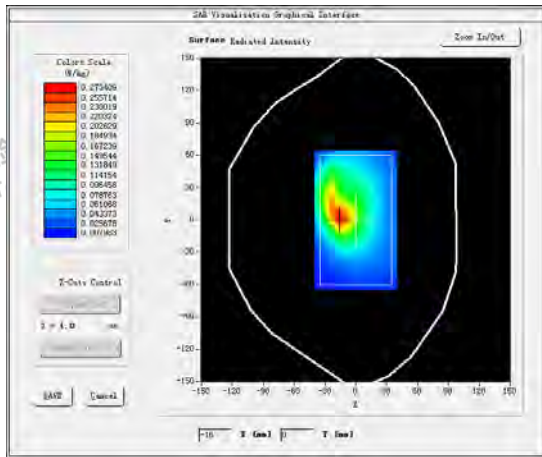

#9

Test Mode: LTE Band 12, 1RB, Mid channel (Body Rear Side)

Product Description: 10.1 inch Quad Core 4G Tablet PC

Model: R10

Test Date: Nov. 13, 2023

Medium(liquid type)	HSL_750
Frequency (MHz)	707.5000
Relative permittivity (real part)	41.20
Conductivity (S/m)	0.87
E-Field Probe	SN 25/22 EPGO376
Crest Factor	1.0
Conversion Factor	1.69
Sensor	4mm
Area Scan	dx=15mm dy=15mm
Zoom Scan	5x5x7,dx=8mm dy=8mm dz=5mm
Variation (%)	-0.280000
SAR 10g (W/Kg)	0.105921
SAR 1g (W/Kg)	0.189538
SURFACE SAR	VOLUME SAR

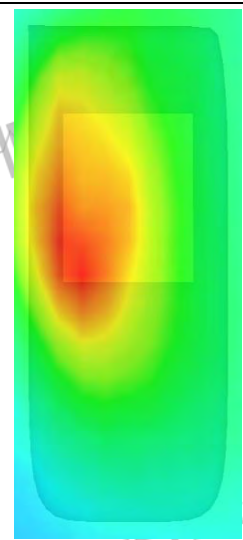
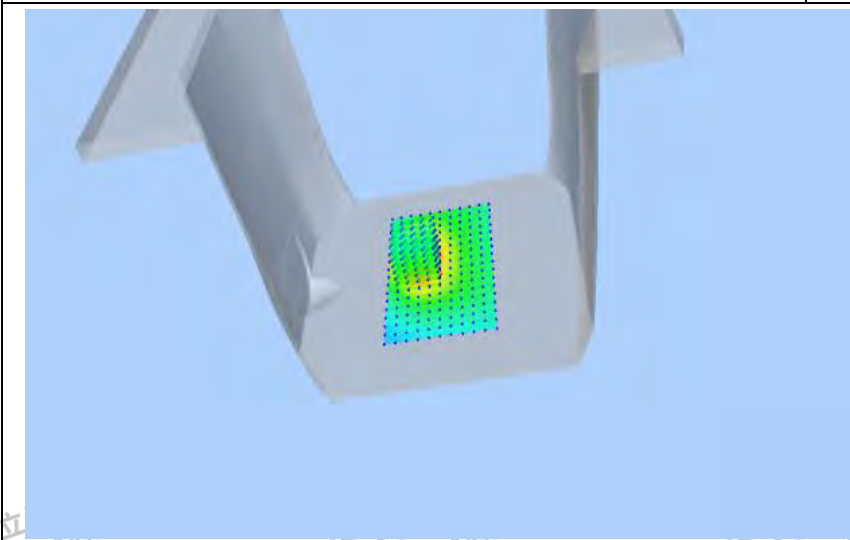
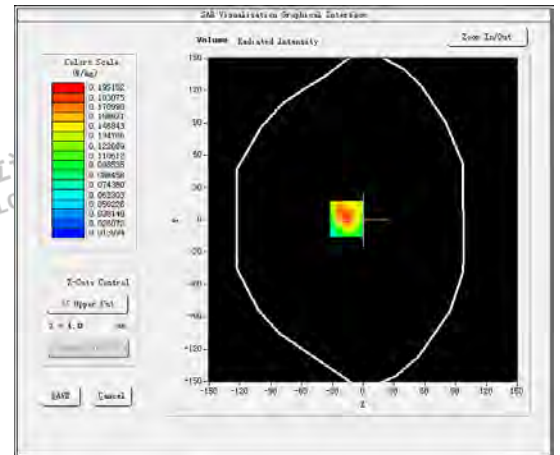
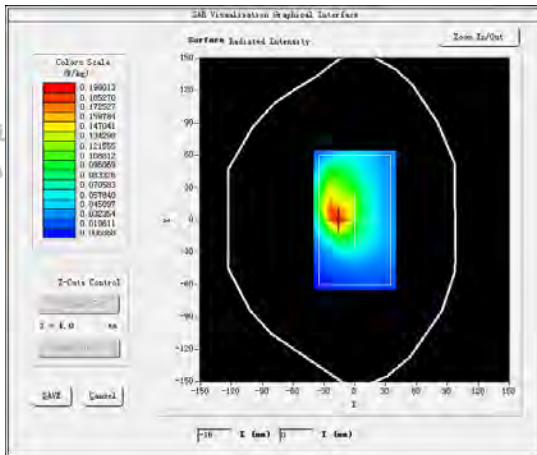

#10

Test Mode: LTE Band 66, 1RB, Mid channel(Body Rear Side)

Product Description: 10.1 inch Quad Core 4G Tablet PC

Model: R10

Test Date: Nov. 15, 2023

Medium(liquid type)	HSL_1800
Frequency (MHz)	1732.5000
Relative permittivity (real part)	39.80
Conductivity (S/m)	1.41
E-Field Probe	SN 25/22 EPGO376
Crest Factor	1.0
Conversion Factor	2.39
Sensor	4mm
Area Scan	dx=12mm dy=12mm
Zoom Scan	7x7x7,dx=5mm dy=5mm dz=5mm
Variation (%)	-0.010000
SAR 10g (W/Kg)	0.286124
SAR 1g (W/Kg)	0.550520
SURFACE SAR	VOLUME SAR

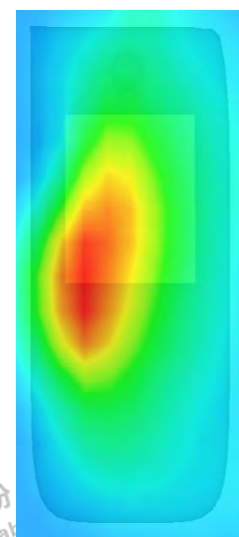
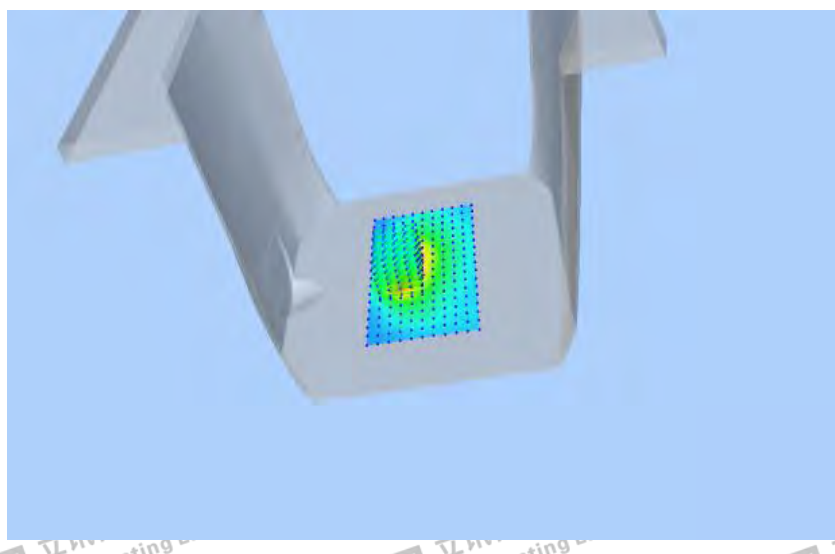
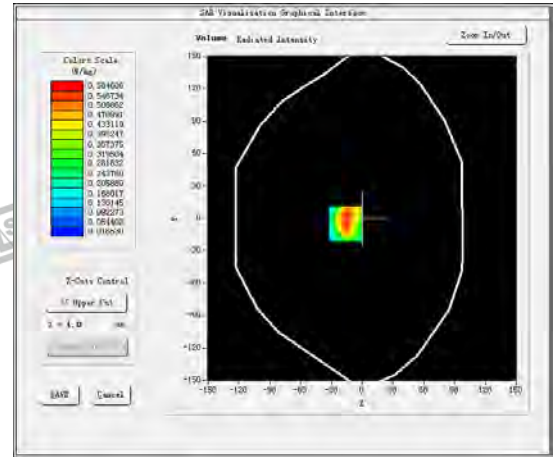
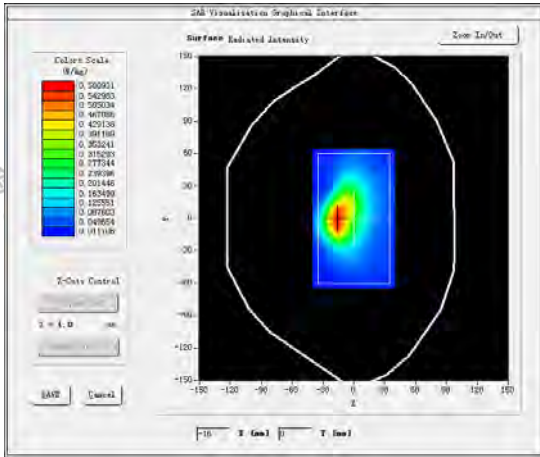

#11

Test Mode: 802.11b (WiFi2.4G), Mid channel (Body Rear Side)

Product Description: 10.1 inch Quad Core 4G Tablet PC

Model: R10

Test Date: Nov. 17, 2023

Medium(liquid type)	HSL_2450
Frequency (MHz)	2437.0000
Relative permittivity (real part)	38.90
Conductivity (S/m)	1.85
E-Field Probe	SN 25/22 EPGO376
Crest Factor	1.0
Conversion Factor	2.60
Sensor	4mm
Area Scan	dx=12mm dy=12mm
Zoom Scan	7x7x7,dx=5mm dy=5mm dz=5mm
Variation (%)	-0.590000
SAR 10g (W/Kg)	0.150289
SAR 1g (W/Kg)	0.334038

SURFACE SAR

VOLUME SAR

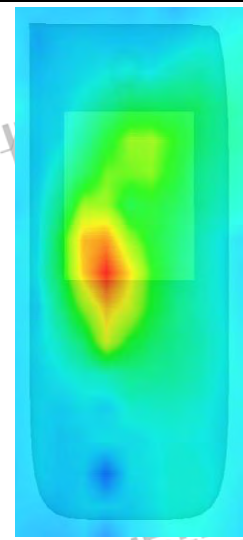
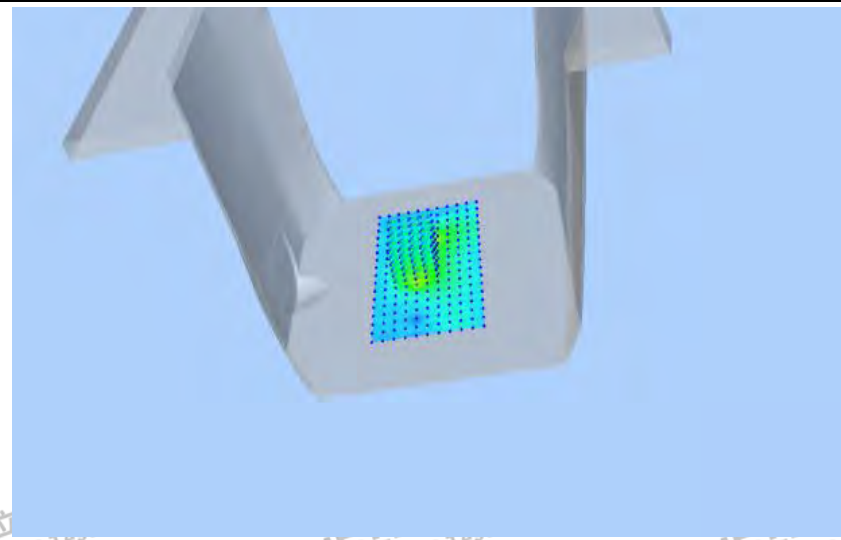
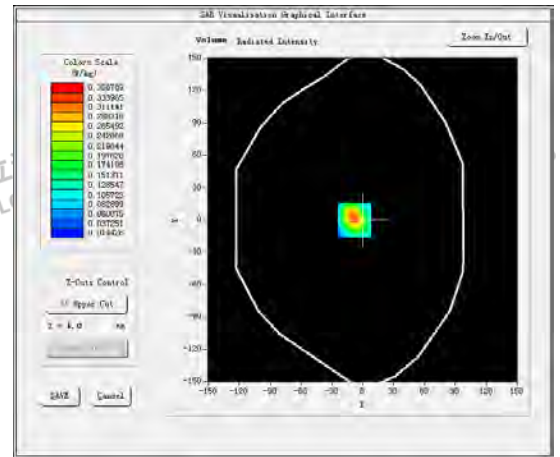
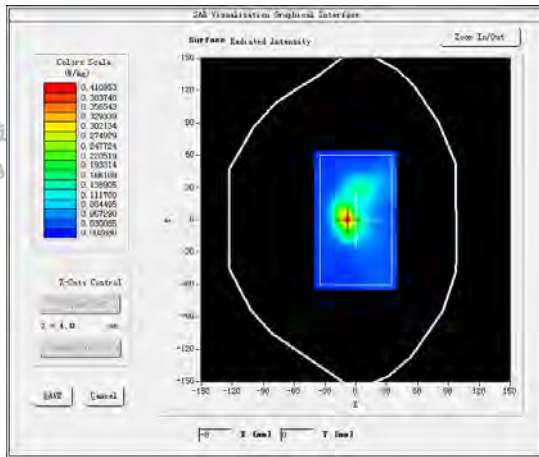

#12

Test Mode: 802.11 n-HT20 (WiFi5.2G), Mid channel(Body Rear Side)

Product Description: 10.1 inch Quad Core 4G Tablet PC

Model: R10

Test Date: Nov. 21, 2023

Medium(liquid type)	HSL_5200
Frequency (MHz)	5190.0000
Relative permittivity (real part)	35.40
Conductivity (S/m)	4.88
E-Field Probe	SN 25/22 EPGO376
Crest Factor	1.0
Conversion Factor	1.85
Sensor	4mm
Area Scan	dx=10mm dy=10mm
Zoom Scan	7x7x7,dx=4mm dy=4mm dz=2mm
Variation (%)	0.250000
SAR 10g (W/Kg)	0.105921
SAR 1g (W/Kg)	0.179538

SURFACE SAR

VOLUME SAR

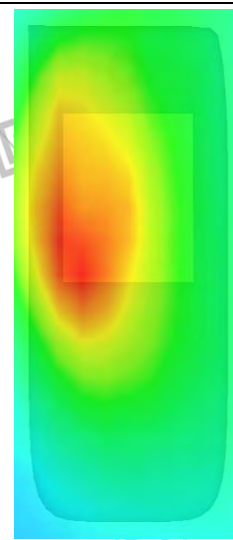
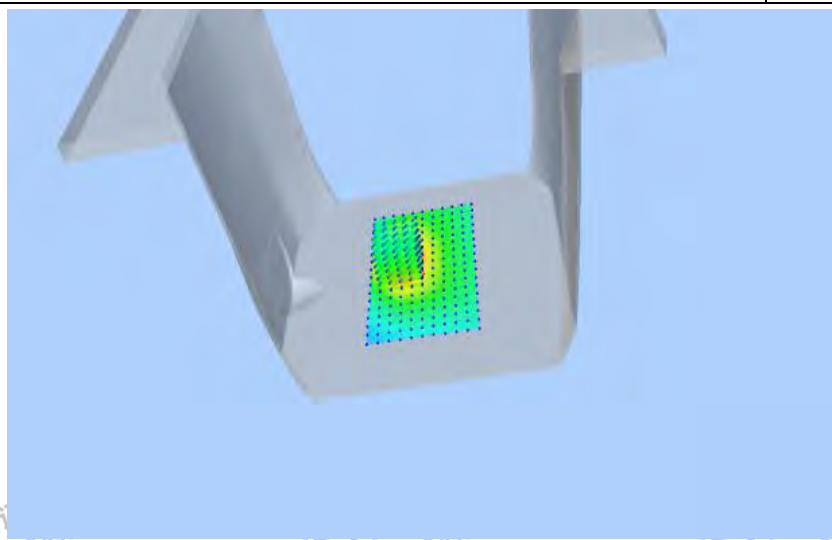
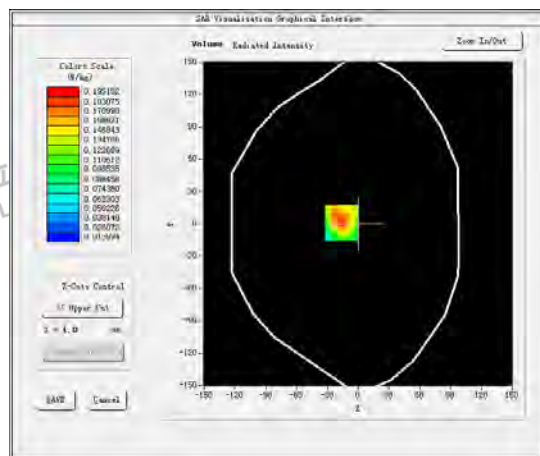
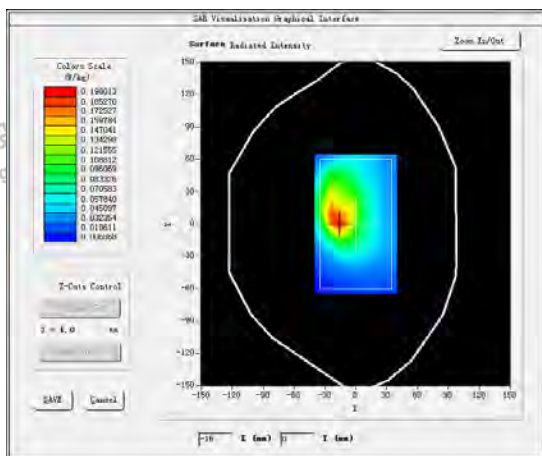

#13

Test Mode: 802.11 n-HT20 (WiFi5.3G), Mid channel(Body Rear Side)
 Product Description: 10.1 inch Quad Core 4G Tablet PC
 Model: R10
 Test Date: Nov. 21, 2023

Medium(liquid type)	HSL_5300
Frequency (MHz)	5300.0000
Relative permittivity (real part)	34.80
Conductivity (S/m)	4.71
E-Field Probe	SN 25/22 EPGO376
Crest Factor	1.0
Conversion Factor	1.85
Sensor	4mm
Area Scan	dx=10mm dy=10mm
Zoom Scan	7x7x7,dx=4mm dy=4mm dz=2mm
Variation (%)	0.250000
SAR 10g (W/Kg)	0.081177
SAR 1g (W/Kg)	0.209070

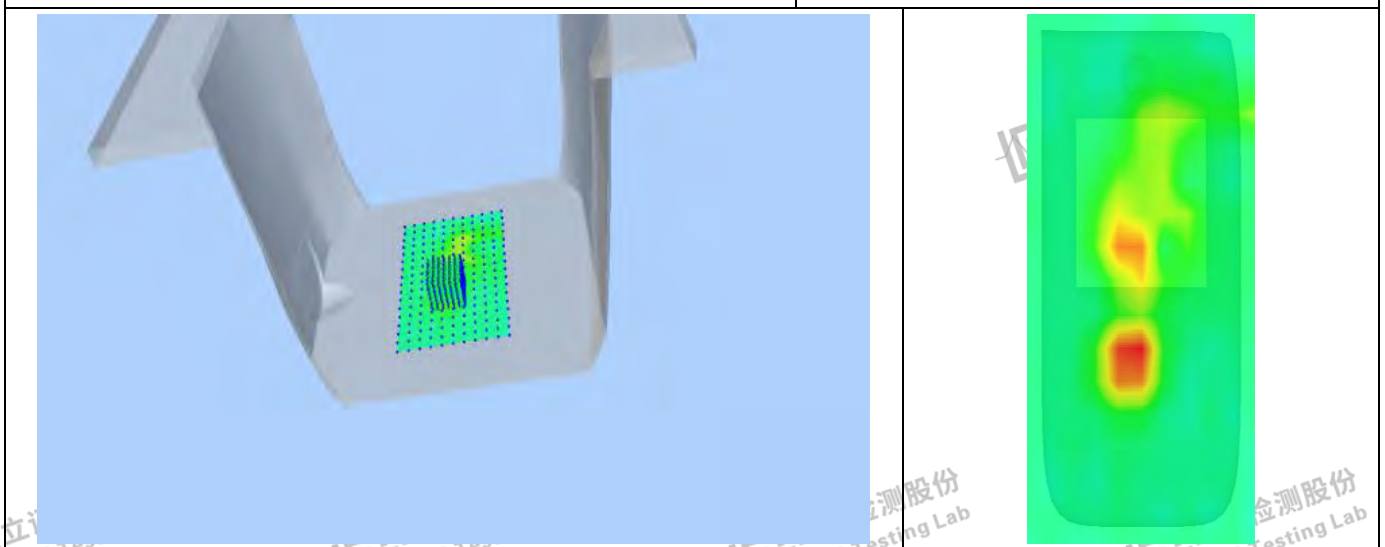
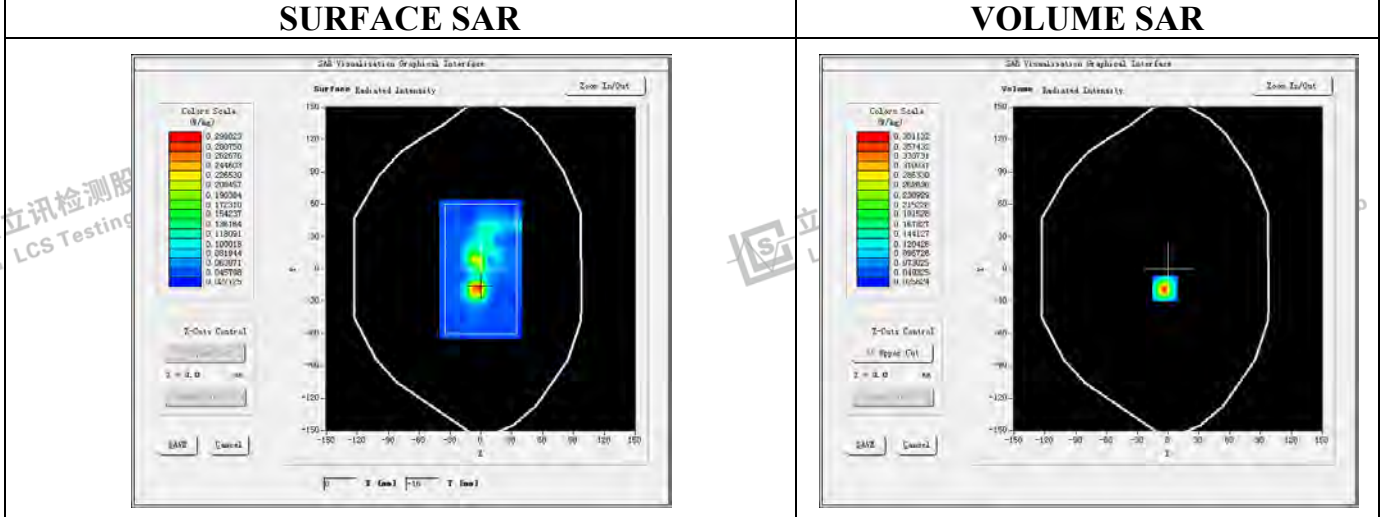

#14

Test Mode: 802.11 n-HT40 (WiFi5.6G), Low channel(Body Rear Side)

Product Description: 10.1 inch Quad Core 4G Tablet PC

Model: R10

Test Date: Nov. 21, 2023

Medium(liquid type)	HSL_5600
Frequency (MHz)	5510.0000
Relative permittivity (real part)	34.70
Conductivity (S/m)	4.95
E-Field Probe	SN 25/22 EPGO376
Crest Factor	1.0
Conversion Factor	1.85
Sensor	4mm
Area Scan	dx=10mm dy=10mm
Zoom Scan	7x7x7,dx=4mm dy=4mm dz=2mm
Variation (%)	0.250000
SAR 10g (W/Kg)	0.080834
SAR 1g (W/Kg)	0.210869

SURFACE SAR

VOLUME SAR

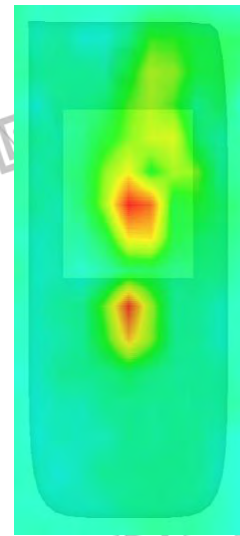
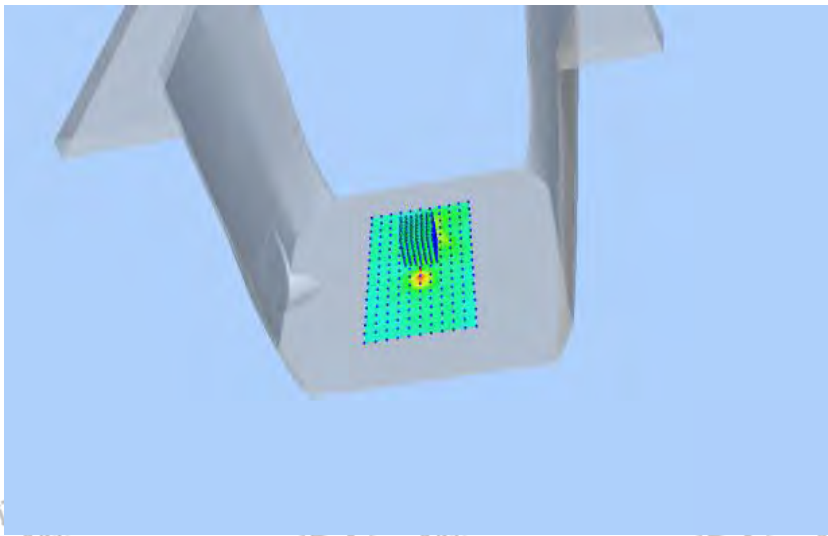
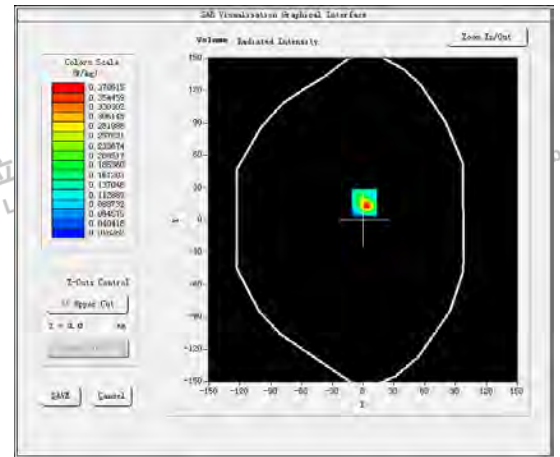
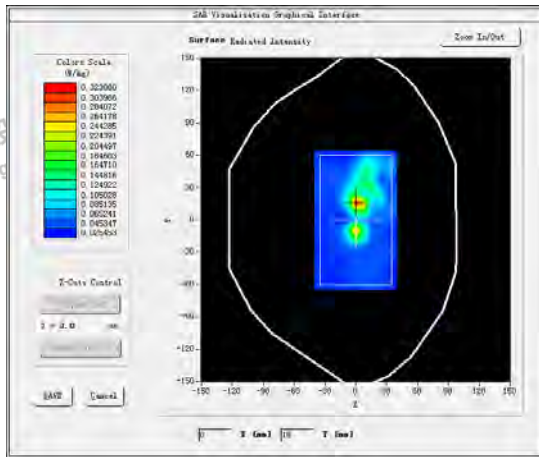

#15

Test Mode: 802.11ac-VHT20 (WiFi5.8G), Mid channel(Body Rear Side)

Product Description: 10.1 inch Quad Core 4G Tablet PC

Model: R10

Test Date: Nov. 21, 2023

Medium(liquid type)	HSL_5800
Frequency (MHz)	5785.0000
Relative permittivity (real part)	35.90
Conductivity (S/m)	5.41
E-Field Probe	SN 25/22 EPGO376
Crest Factor	1.0
Conversion Factor	2.01
Sensor	4mm
Area Scan	dx=10mm dy=10mm
Zoom Scan	7x7x7,dx=4mm dy=4mm dz=2mm
Variation (%)	-2.570000
SAR 10g (W/Kg)	0.089234
SAR 1g (W/Kg)	0.193701

SURFACE SAR

VOLUME SAR

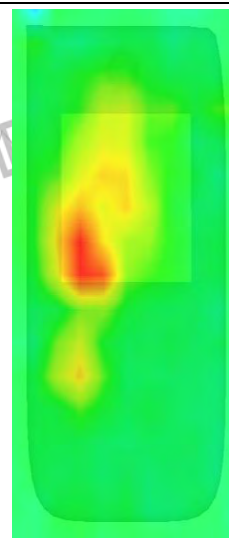
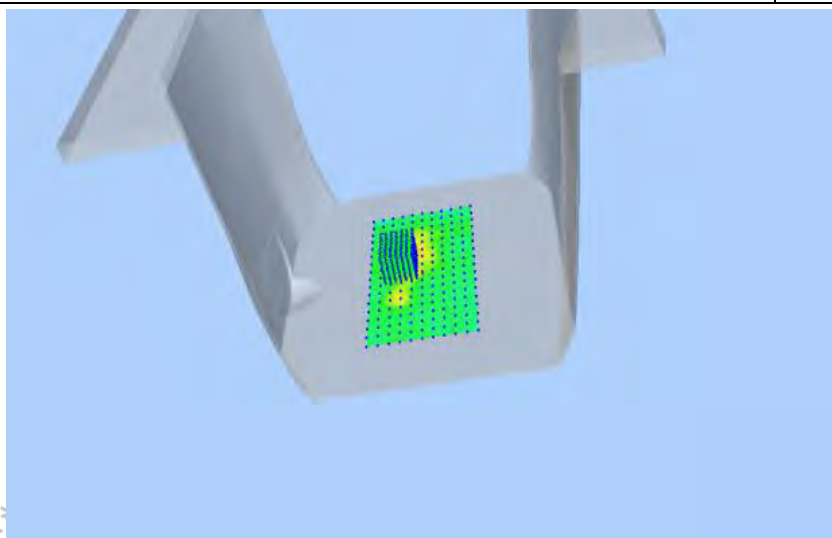
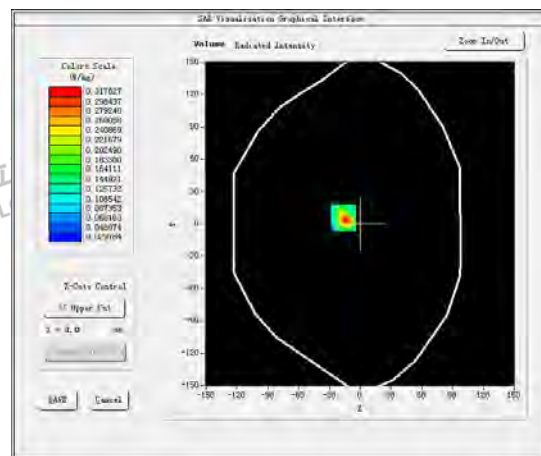
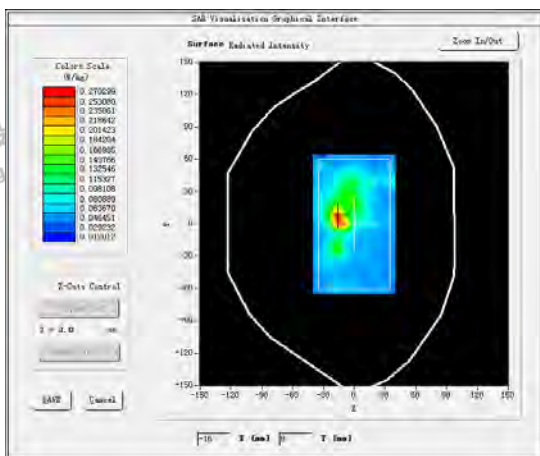



5. CALIBRATION CERTIFICATES

5.1 Probe-EPGO376 Calibration Certificate



COMOSAR E-Field Probe Calibration Report

Ref: ACR.180.4.42.BES.A

SHENZHEN LCS COMPLIANCE TESTING LABORATORY LTD.

1F., XINGYUAN INDUSTRIAL PARK, TONGDA ROAD, BAO'AN BLVD

BAO'AN DISTRICT, SHENZHEN, GUANGDONG, CHINA

MVG COMOSAR DOSIMETRIC E-FIELD PROBE

SERIAL NO.: SN 25/22 EPGO376

Calibrated at MVG

Z.I. de la pointe du diable

Technopôle Brest Iroise – 295 avenue Alexis de Rochon

29280 PLOUZANE - FRANCE

Calibration date: 06/22/2023



Accreditations #2-6792

Scope available on www.cofrac.fr

The use of the Cofrac brand and the accreditation references is prohibited from any reproduction.

Summary:

This document presents the method and results from an accredited COMOSAR Dosimetric E-Field Probe calibration performed at MVG, using the CALIPROBE test bench, for use with a MVG COMOSAR system only. The test results covered by accreditation are traceable to the International System of Units (SI).

