

Radio Test Report

Report No.: CTA231114012W04

Issued for

WHOOOP INTERNATIONAL TRADING LIMITED

Flat-B 8/F Chong Gming Building 72 Cheung Sha Wan Road,
Kowloon, Hong Kong

Product Name: 10.1 inch Quad Core 4G Tablet PC

Brand Name: ROVER

Model Name: R10

Series Model(s): N/A

FCC ID: 2AP7LTAB10US

Test Standards: FCC Part 15.247

Any reproduction of this document must be done in full. No single part of this document may be reproduced without permission from CTA, all test data presented in this report is only applicable to presented test sample.



TEST REPORT

Applicant's Name : WHOOP INTERNATIONAL TRADING LIMITED
Address : Flat-B 8/F Chong Gming Building 72 Cheung Sha Wan Road,
Kowloon, Hong Kong
Manufacturer's Name : Shenzhen Teleone Technology Co.,Ltd
Address : Tower B 5/F, Shanshui Building, Nanshan Yungu Innovation Industry
Park, 4093 Liuxian Avenue, Shenzhen, China

Product Description

Product Name : 10.1 inch Quad Core 4G Tablet PC
Brand Name : ROVER
Model Name : R10
Series Model(s) : N/A
Test Standards : FCC Part 15.247
Test Procedure : ANSI C63.10-2013

This device described above has been tested by CTA, the test results show that the equipment under test (EUT) is in compliance with the FCC requirements. And it is applicable only to the tested sample identified in the report.

This report shall not be reproduced except in full, without the written approval of CTA, this document only be altered or revised by CTA, personal only, and shall be noted in the revision of the document.

Date of Test..... :

Date of receipt of test item : 29 Mar. 2023
Date (s) of performance of tests : 29 Mar. 2023 ~ 28 Oct. 2023
Date of Issue : 28 Oct. 2023
Test Result : **Pass**

Testing Engineer :

Zoey Cao

(Zoey Cao)

Technical Manager :

Amy Wen

(Amy Wen)

Authorized Signatory :

Eric Wang

(Eric Wang)

Table of Contents

Page

1. SUMMARY OF TEST RESULTS	6
1.1 TEST FACTORY	7
1.2 MEASUREMENT UNCERTAINTY	7
2. GENERAL INFORMATION	8
2.1 GENERAL DESCRIPTION OF THE EUT	8
2.2 DESCRIPTION OF THE TEST MODES	10
2.3 TEST SOFTWARE AND POWER LEVEL	10
2.4 BLOCK DIAGRAM SHOWING THE CONFIGURATION OF SYSTEM TESTED	11
2.5 DESCRIPTION OF NECESSARY ACCESSORIES AND SUPPORT UNITS	12
2.6 EQUIPMENTS LIST FOR ALL TEST ITEMS	13
3. EMC EMISSION TEST	15
3.1 CONDUCTED EMISSION MEASUREMENT	15
3.2 RADIATED EMISSION MEASUREMENT	19
4. CONDUCTED SPURIOUS & BAND EDGE EMISSION	30
4.1 LIMIT	30
4.2 TEST PROCEDURE	30
4.3 DEVIATION FROM STANDARD	30
4.4 TEST SETUP	30
4.5 EUT OPERATION CONDITIONS	30
4.6 TEST RESULTS	30
5. POWER SPECTRAL DENSITY TEST	31
5.1 LIMIT	31
5.2 TEST PROCEDURE	31
5.3 DEVIATION FROM STANDARD	31
5.4 TEST SETUP	31
5.5 EUT OPERATION CONDITIONS	31
5.6 TEST RESULTS	31
6. BANDWIDTH TEST	32
6.1 LIMIT	32
6.2 TEST PROCEDURE	32
6.3 DEVIATION FROM STANDARD	32
6.4 TEST SETUP	32
6.5 EUT OPERATION CONDITIONS	32

Table of Contents	Page
6.6 TEST RESULTS	32
7. PEAK OUTPUT POWER TEST	33
7.1 LIMIT	33
7.2 TEST PROCEDURE	33
7.3 DEVIATION FROM STANDARD	33
7.4 TEST SETUP	34
7.5 EUT OPERATION CONDITIONS	34
7.6 TEST RESULTS	34
8. ANTENNA REQUIREMENT	35
8.1 STANDARD REQUIREMENT	35
8.2 EUT ANTENNA	35
APPENDIX 1-TEST DATA	36
1. DUTY CYCLE	36
2. MAXIMUM AVERAGE CONDUCTED OUTPUT POWER	42
3. MAXIMUM PEAK CONDUCTED OUTPUT POWER	48
4. -6DB BANDWIDTH	54
5. MAXIMUM POWER SPECTRAL DENSITY LEVEL	60
6. BAND EDGE	66
7. CONDUCTED RF SPURIOUS EMISSION	73
APPENDIX 2-PHOTOS OF TEST SETUP	83

Revision History

Rev.	Issue Date	Report No.	Effect Page	Contents
00	28 Oct. 2023	CTA231114012W04	ALL	Initial Issue

1. SUMMARY OF TEST RESULTS

Test procedures according to the technical standards:
KDB 558074 D01 15.247 Meas Guidance v05r02.

FCC Part 15.247, Subpart C			
Standard Section	Test Item	Judgment	Remark
15.207	Conducted Emission	PASS	--
15.247 (a)(2)	6dB Bandwidth	PASS	--
15.247 (b)(3)	Output Power	PASS	--
15.209	Radiated Spurious Emission	PASS	--
15.247 (d)	Conducted Spurious & Band Edge Emission	PASS	--
15.247 (e)	Power Spectral Density	PASS	--
15.205	Restricted Band Edge Emission	PASS	--
Part 15.247(d)/ part 15.209(a)	Band Edge Emission	PASS	--
15.203	Antenna Requirement	PASS	--

NOTE:

- (1) 'N/A' denotes test is not applicable in this Test Report.
- (2) All tests are according to ANSI C63.10-2013.

1.1 TEST FACTORY

Shenzhen CTA Testing Technology Co., Ltd.
Room 106, Building 1, Yibaolai Industrial Park, Qiaotou Community, Fuhai Street, Bao'an District, Shenzhen, China

FCC test Firm Registration Number: 517856

IC test Firm Registration Number: 27890

A2LA Certificate No.: 6534.01

IC CAB ID: CN0127

1.2 MEASUREMENT UNCERTAINTY

The reported uncertainty of measurement $y \pm U$, where expanded uncertainty U is based on a standard uncertainty multiplied by a coverage factor of $k=2$, providing a level of confidence of approximately 95 %.

Test	Range	Measurement Uncertainty
Radiated Emission	30~1000MHz	4.06 dB
Radiated Emission	1~18GHz	5.14 dB
Radiated Emission	18-40GHz	5.38 dB
Conducted Disturbance	0.15~30MHz	2.14 dB
Output Peak power	30MHz~18GHz	0.55 dB
Power spectral density	/	0.57 dB
Spectrum bandwidth	/	1.1%
Radiated spurious emission (30MHz-1GHz)	30~1000MHz	4.10 dB
Radiated spurious emission (1GHz-18GHz)	1~18GHz	4.32 dB
Radiated spurious emission (18GHz-40GHz)	18-40GHz	5.54 dB

2. GENERAL INFORMATION

2.1 GENERAL DESCRIPTION OF THE EUT

Product Name	10.1 inch Quad Core 4G Tablet PC	
Brand Name	ROVER	
Model Name	R10	
Series Model(s)	N/A	
Model Difference	N/A	
Product Description	The EUT is a 10.1 inch Quad Core 4G Tablet PC	
	Operation Frequency:	802.11b/g/n 20: 2412~2462 MHz
	Modulation Type:	802.11b(DSSS):CCK,DQPSK,DBPSK 802.11g(OFDM):BPSK,QPSK,16-QAM,64-QAM 802.11n(OFDM):BPSK,QPSK,16-QAM,64-QAM
	Bit Rate of Transmitter:	802.11b:11/5.5/2/1 Mbps 802.11g:54/48/36/24/18/12/9/6Mbps 802.11n(20MHz): 65/58.5/52/39/26/19.5/13/6.5Mbps
	Number of Channel:	802.11b/g/n20: 11CH
	Antenna Type:	PIFA
	Antenna Gain (dBi):	1.18dBi
Channel List	Please refer to the Note 3.	
Adapter	Input: AC 100-240V 0.3A 50/60Hz Output: DC 5V 1500mA	
Battery	Rated Voltage:3.8V Charge Limit Voltage:4.35 V Capacity: 5100mAh	
Hardware version number	J866B_610&310_D4F_V1.0	
Software version number	ROVER_R10_13_V01_20231201	
Connecting I/O Port(s)	Please refer to the Note 1.	

Note:

1. For a more detailed features description, please refer to the manufacturer's specifications or the User Manual.
2. The antenna information refer the manufacturer provide report, applicable only to the tested sample identified in the report. Due to the incorrect antenna information, a series of problems such as the accuracy of the test results will be borne by the customer.

3.

Operation Frequency of channel	
802.11b/g/n(20MHz)	
Channel	Frequency
01	2412
02	2417
03	2422
04	2427
05	2432
06	2437
07	2442
08	2447
09	2452
10	2457
11	2462

Note:

In section 15.31(m), regards to the operating frequency range over 10 MHz, the Lowest frequency, the middle frequency, and the highest frequency of channel were selected to perform the test, and the selected channel see below:

Carrier Frequency Channel

2.4GHz Test Frequency:

For 802.11b/g/n (HT20)	
Channel	Freq.(MHz)
01	2412
06	2437
11	2462

2.2 DESCRIPTION OF THE TEST MODES

Each of these EUT operation mode(s) or test configuration mode(s) mentioned above was evaluated respectively.

Worst Mode	Description	Data Rate
Mode 1	TX IEEE 802.11b CH1	1 Mbps
Mode 2	TX IEEE 802.11b CH6	1 Mbps
Mode 3	TX IEEE 802.11 b CH11	1 Mbps
Mode 4	TX IEEE 802.11g CH1	6 Mbps
Mode 5	TX IEEE 802.11g CH6	6 Mbps
Mode 6	TX IEEE 802.11g CH11	6 Mbps
Mode 7	TX IEEE 802.11n HT20 CH1	MCS 0
Mode 8	TX IEEE 802.11n HT20 CH6	MCS 0
Mode 9	TX IEEE 802.11n HT20 CH11	MCS 0

Note:

- (1) The measurements are performed at all Bit Rate of Transmitter, the worst data was reported.
- (2) We have be tested for all avaiable U.S. voltage and frequencies(For 120V,50/60Hz and 240V, 50/60Hz) for which the device is capable of operation, and the worst case of 120V /60Hz is shown in the report.
- (3) The battery is fully-charged during the radited and RF conducted test.

AC Conducted Emission

Test Case	
AC Conducted Emission	Mode10: Keeping WIFI TX

2.3 TEST SOFTWARE AND POWER LEVEL

During testing channel & power controlling software provided by the customer was used to control the operating channel as well as the output power level.

RF Function	Type	Mode Or Modulation type	ANT Gain(dBi)	Power Class	Software For Testing
WIFI(2.4G)	2.4G WIFI	802.11b	1.18	12	Engineering mode
		802.11g		12	
		802.11n(HT20)		12	

2.4 BLOCK DIAGRAM SHOWING THE CONFIGURATION OF SYSTEM TESTED

Radiation Test Set

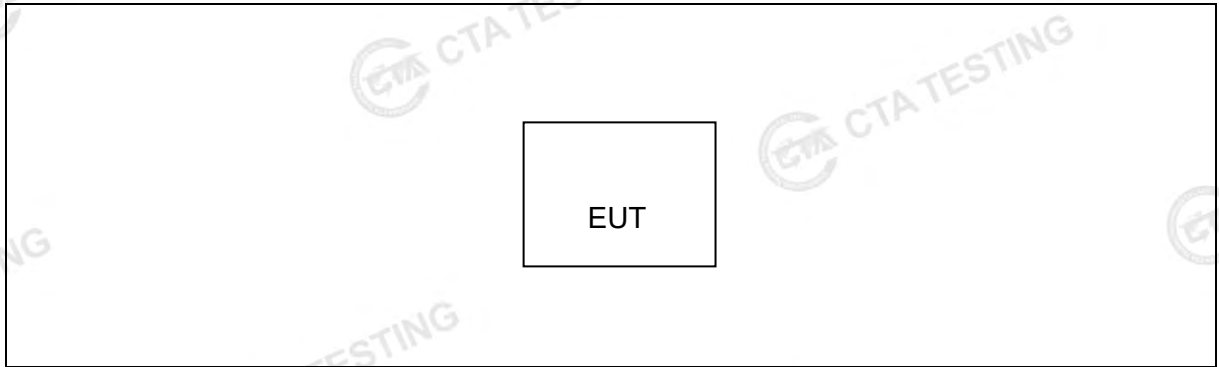

Conduction Test Set

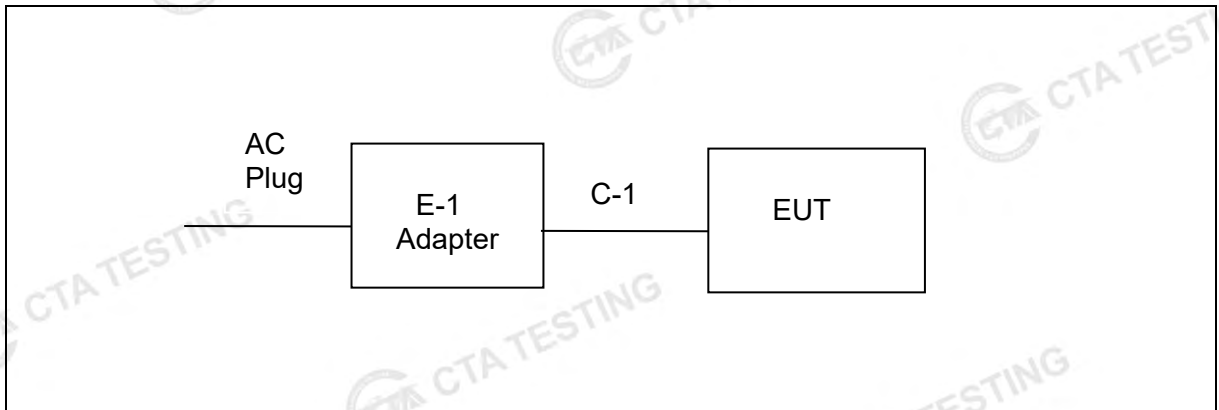

2.5 DESCRIPTION OF NECESSARY ACCESSORIES AND SUPPORT UNITS

The EUT has been tested as an independent unit together with other necessary accessories or support units. The following support units or accessories were used to form a representative test configuration during the tests.

Necessary accessories

Item	Equipment	Mfr/Brand	Model/Type No.	Length	Note
E-1	Adapter	N/A	YMK-12W050150	N/A	N/A
C-1	USB Cable	N/A	N/A	95cm	NO

Support units

Item	Equipment	Mfr/Brand	Model/Type No.	Length	Note
N/A	N/A	N/A	N/A	N/A	N/A

Note:

- (1) For detachable type I/O cable should be specified the length in cm in 『Length』 column.
- (2) “YES” is means “with core”; “NO” is means “without core”.

2.6 EQUIPMENTS LIST FOR ALL TEST ITEMS

Test Equipment	Manufacturer	Model No.	Equipment No.	Calibration Date	Calibration Due Date
LISN	R&S	ENV216	CTA-308	2023/08/02	2024/08/01
LISN	R&S	ENV216	CTA-314	2023/08/02	2024/08/01
EMI Test Receiver	R&S	ESPI	CTA-307	2023/08/02	2024/08/01
EMI Test Receiver	R&S	ESCI	CTA-306	2023/08/02	2024/08/01
Spectrum Analyzer	Agilent	N9020A	CTA-301	2023/08/02	2024/08/01
Spectrum Analyzer	R&S	FSP	CTA-337	2023/08/02	2024/08/01
Vector Signal generator	Agilent	N5182A	CTA-305	2023/08/02	2024/08/01
Analog Signal Generator	R&S	SML03	CTA-304	2023/08/02	2024/08/01
WIDEBAND RADIO COMMUNICATION TESTER	CMW500	R&S	CTA-302	2023/08/02	2024/08/01
Temperature and humidity meter	Chigo	ZG-7020	CTA-326	2023/08/02	2024/08/01
Ultra-Broadband Antenna	Schwarzbeck	VULB9163	CTA-310	2023/10/17	2024/10/16
Horn Antenna	Schwarzbeck	BBHA 9120D	CTA-309	2023/10/13	2024/10/12
Loop Antenna	Zhinan	ZN30900C	CTA-311	2023/10/17	2024/10/16
Horn Antenna	Beijing Hangwei Dayang	OBH100400	CTA-336	2021/08/07	2024/08/06
Amplifier	Schwarzbeck	BBV 9745	CTA-312	2023/08/02	2024/08/01
Amplifier	Taiwan chengyi	EMC051845B	CTA-313	2023/08/02	2024/08/01
Directional coupler	NARDA	4226-10	CTA-303	2023/08/02	2024/08/01
High-Pass Filter	XingBo	XBLBQ-GTA18	CTA-402	2023/08/02	2024/08/01
High-Pass Filter	XingBo	XBLBQ-GTA27	CTA-403	2023/08/02	2024/08/01
Automated filter bank	Tonscend	JS0806-F	CTA-404	2023/08/02	2024/08/01
Power Sensor	Agilent	U2021XA	CTA-405	2023/08/02	2024/08/01
Amplifier	Schwarzbeck	BBV9719	CTA-406	2023/08/02	2024/08/01

Test Equipment	Manufacturer	Model No.	Version number	Calibration Date	Calibration Due Date
EMI Test Software	Tonscend	TS@JS32-RE	5.0.0.2	N/A	N/A
EMI Test Software	Tonscend	TS@JS32-CE	5.0.0.1	N/A	N/A
RF Test Software	Tonscend	TS@JS1120-3	3.1.65	N/A	N/A
RF Test Software	Tonscend	TS@JS1120	3.1.46	N/A	N/A

3. EMC EMISSION TEST

3.1 CONDUCTED EMISSION MEASUREMENT

3.1.1 POWER LINE CONDUCTED EMISSION LIMITS

The radio frequency voltage that is conducted back onto the AC power line on any frequency or frequencies, within the band 150 kHz to 30 MHz, shall not exceed the limits in the following table.

FREQUENCY (MHz)	Conducted Emission limit (dBuV)	
	Quasi-peak	Average
0.15 -0.5	66 - 56 *	56 - 46 *
0.50 -5.0	56.00	46.00
5.0 -30.0	60.00	50.00

Note:

- (1) The tighter limit applies at the band edges.
- (2) The limit of “ * ” marked band means the limitation decreases linearly with the logarithm of the frequency in the range.

The following table is the setting of the receiver

Receiver Parameters	Setting
Attenuation	10 dB
Start Frequency	0.15 MHz
Stop Frequency	30 MHz
IF Bandwidth	9 kHz

3.1.2 TEST PROCEDURE

- The EUT is 0.8 m from the horizontal ground plane and 0.4 m from the vertical ground plane with EUT being connected to the power mains through a line impedance stabilization network (LISN). All other support equipments are powered from additional LISN(s). The LISN provides 50 Ohm/ 50uH of coupling impedance for the measuring instrument.
- Interconnecting cables that hang closer than 40 cm to the ground plane shall be folded back and forth in the center forming a bundle 30 to 40 cm long.
- I/O cables that are not connected to a peripheral shall be bundled in the center. The end of the cable may be terminated, if required, using the correct terminating impedance. The overall length shall not exceed 1 m.
- LISN is at least 80 cm from the nearest part of EUT chassis.
- For the actual test configuration, please refer to the related Item –EUT Test Photos.

3.1.3 TEST SETUP

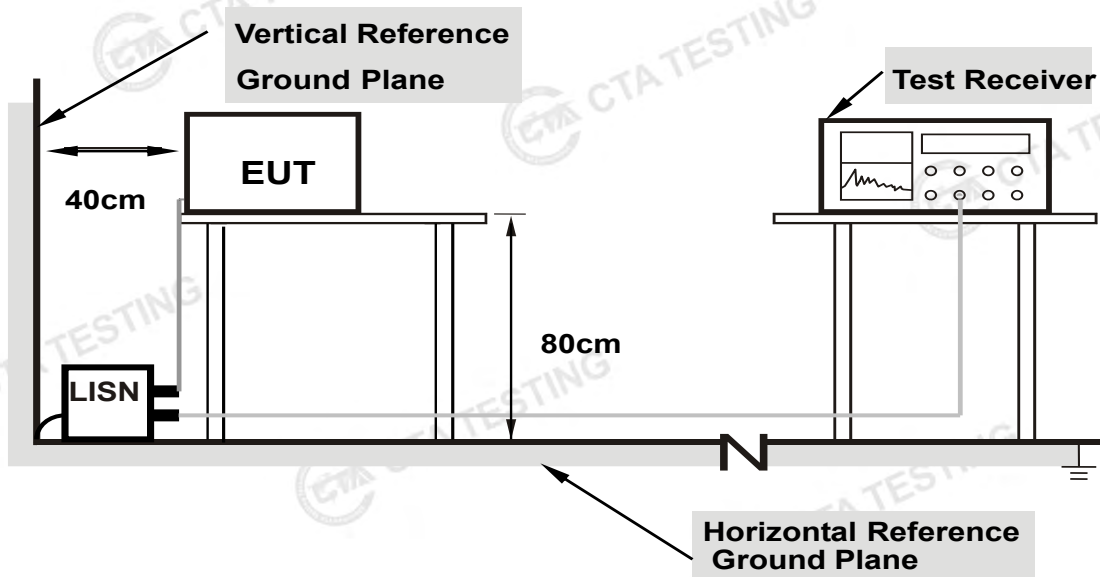

Note: 1. Support units were connected to second LISN.

2. Both of LISNs (AMN) are 80 cm from EUT and at least 80 cm from other units and other metal planes support units.

3.1.4 EUT OPERATING CONDITIONS

The EUT was configured for testing in a typical fashion (as a customer would normally use it). The EUT has been programmed to continuously transmit during test. This operating condition was tested and used to collect the included data.

3.1.5 TEST RESULT

Temperature:	25.5(C)	Relative Humidity:	43%RH
Test Voltage:	AC 120V/60Hz	Phase:	L
Test Mode:	Mode 10		

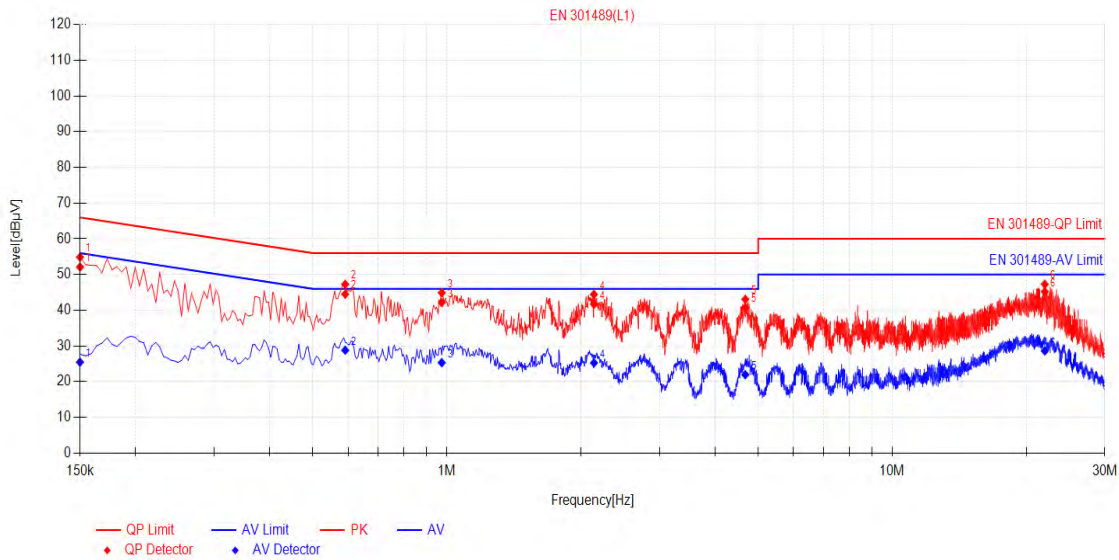

Final Data List											
NO.	Freq. [MHz]	Factor [dB]	QP Reading [dBµV]	QP Value [dBµV]	QP Limit [dBµV]	QP Margin [dB]	AV Reading [dBµV]	AV Value [dBµV]	AV Limit [dBµV]	AV Margin [dB]	Verdict
1	0.15	10.50	41.60	52.10	66.00	13.90	14.96	25.46	56.00	30.54	PASS
2	0.591	10.50	33.99	44.49	56.00	11.51	18.32	28.82	46.00	17.18	PASS
3	0.9735	10.50	31.65	42.15	56.00	13.85	14.82	25.32	46.00	20.68	PASS
4	2.139	10.50	31.19	41.69	56.00	14.31	14.76	25.26	46.00	20.74	PASS
5	4.677	10.50	30.21	40.71	56.00	15.29	11.47	21.97	46.00	24.03	PASS
6	22.0055	10.50	34.69	45.19	60.00	14.81	18.11	28.61	50.00	21.39	PASS

Note: 1). QP Value (dBµV) = QP Reading (dBµV) + Factor (dB)

2). Factor (dB) = insertion loss of LISN (dB) + Cable loss (dB)

3). QPMargin (dB) = QP Limit (dBµV) - QP Value (dBµV)

4). AVMargin (dB) = AV Limit (dBµV) - AV Value (dBµV)

Temperature:	25.5(C)	Relative Humidity:	43%RH
Test Voltage:	AC 120V/60Hz	Phase:	N
Test Mode:	Mode 10		

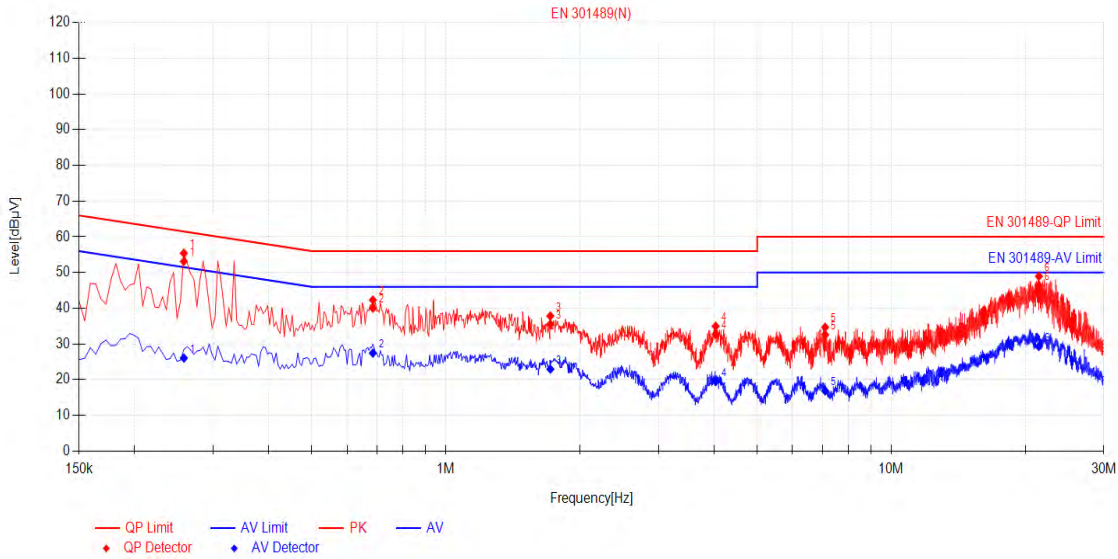

Final Data List											
NO.	Freq. [MHz]	Factor [dB]	QP Reading [dBµV]	QP Value [dBµV]	QP Limit [dBµV]	QP Margin [dB]	AV Reading [dBµV]	AV Value [dBµV]	AV Limit [dBµV]	AV Margin [dB]	Verdict
1	0.258	10.50	42.63	53.13	61.50	8.37	15.55	26.05	51.50	25.45	PASS
2	0.6855	10.50	29.52	40.02	56.00	15.98	16.95	27.45	46.00	18.55	PASS
3	1.716	10.50	25.04	35.54	56.00	20.46	12.45	22.95	46.00	23.05	PASS
4	4.0335	10.50	22.26	32.76	56.00	23.24	9.00	19.50	46.00	26.50	PASS
5	7.107	10.50	22.07	32.57	60.00	27.43	6.34	16.84	50.00	33.16	PASS
6	21.453	10.50	35.94	46.44	60.00	13.56	18.81	29.31	50.00	20.69	PASS

Note: 1). QP Value (dBµV) = QP Reading (dBµV) + Factor (dB)

2). Factor (dB) = insertion loss of LISN (dB) + Cable loss (dB)

3). QPMargin (dB) = QP Limit (dBµV) - QP Value (dBµV)

4). AVMargin (dB) = AV Limit (dBµV) - AV Value (dBµV)

3.2 RADIATED EMISSION MEASUREMENT

3.2.1 RADIATED EMISSION LIMITS

In any 100 kHz bandwidth outside the operating frequency band. In case the emission fall within the Restricted band specified on Part15.205(a)&209(a) limit in the table and according to ANSI C63.10-2013 below has to be followed.

LIMITS OF RADIATED EMISSION MEASUREMENT (0.009MHz - 1000MHz)

Frequencies (MHz)	Field Strength (micorvolts/meter)	Measurement Distance (meters)
0.009~0.490	2400/F(KHz)	300
0.490~1.705	24000/F(KHz)	30
1.705~30.0	30	30
30~88	100	3
88~216	150	3
216~960	200	3
Above 960	500	3

LIMITS OF RADIATED EMISSION MEASUREMENT (1000MHz-25GHz)

FREQUENCY (MHz)	(dBuV/m) (at 3M)	
	PEAK	AVERAGE
Above 1000	74	54

Notes:

- (1) The limit for radiated test was performed according to FCC PART 15C.
- (2) The tighter limit applies at the band edges.
- (3) Emission level (dBuV/m)=20log Emission level (uV/m).

LIMITS OF RESTRICTED FREQUENCY BANDS

FREQUENCY (MHz)	FREQUENCY (MHz)	FREQUENCY (MHz)	FREQUENCY (GHz)
0.090-0.110	16.42-16.423	399.9-410	4.5-5.15
0.495-0.505	16.69475-16.69525	608-614	5.35-5.46
2.1735-2.1905	16.80425-16.80475	960-1240	7.25-7.75
4.125-4.128	25.5-25.67	1300-1427	8.025-8.5
4.17725-4.17775	37.5-38.25	1435-1626.5	9.0-9.2
4.20725-4.20775	73-74.6	1645.5-1646.5	9.3-9.5
6.215-6.218	74.8-75.2	1660-1710	10.6-12.7
6.26775-6.26825	108-121.94	1718.8-1722.2	13.25-13.4
6.31175-6.31225	123-138	2200-2300	14.47-14.5
8.291-8.294	149.9-150.05	2310-2390	15.35-16.2
8.362-8.366	156.52475-156.52525	2483.5-2500	17.7-21.4
8.37625-8.38675	156.7-156.9	2690-2900	22.01-23.12
8.41425-8.41475	162.0125-167.17	3260-3267	23.6-24.0
12.29-12.293	167.72-173.2	3332-3339	31.2-31.8
12.51975-12.52025	240-285	3345.8-3358	36.43-36.5
12.57675-12.57725	322-335.4	3600-4400	Above 38.6
13.36-13.41			

For Radiated Emission

Spectrum Parameter	Setting
Attenuation	Auto
Detector	Peak/QP/AV
Start Frequency	9 KHz/150KHz(Peak/QP/AV)
Stop Frequency	150KHz/30MHz(Peak/QP/AV)
RB / VB (emission in restricted band)	200Hz (From 9kHz to 0.15MHz)/ 9KHz (From 0.15MHz to 30MHz); 200Hz (From 9kHz to 0.15MHz)/ 9KHz (From 0.15MHz to 30MHz)

Spectrum Parameter	Setting
Attenuation	Auto
Detector	Peak/QP
Start Frequency	30 MHz(Peak/QP)
Stop Frequency	1000 MHz (Peak/QP)
RB / VB (emission in restricted band)	120 KHz / 300 KHz

Spectrum Parameter	Setting
Attenuation	Auto
Detector	Peak/AV
Start Frequency	1000 MHz(Peak/AV)
Stop Frequency	10th carrier hamonic(Peak/AV)
RB / VB (emission in restricted band)	1 MHz / 3 MHz(Peak) 1 MHz/1/T MHz(AVG)

For Restricted band

Spectrum Parameter	Setting
Detector	Peak/AV
Start/Stop Frequency	Lower Band Edge: 2310 to 2430 MHz Upper Band Edge: 2445 to 2500 MHz
RB / VB	1 MHz / 3 MHz(Peak) 1 MHz/1/T MHz(AVG)

Receiver Parameter	Setting
Start ~ Stop Frequency	9kHz~90kHz / RB 200Hz for PK & AV
Start ~ Stop Frequency	90kHz~110kHz / RB 200Hz for QP
Start ~ Stop Frequency	110kHz~490kHz / RB 200Hz for PK & AV
Start ~ Stop Frequency	490kHz~30MHz / RB 9kHz for QP
Start ~ Stop Frequency	30MHz~1000MHz / RB 120kHz for QP

3.2.2 TEST PROCEDURE

- a. The measuring distance at 3 m shall be used for measurements at frequency 0.009MHz up to 1GHz, and above 1GHz.
- b. The EUT was placed on the top of a rotating table 0.8 m (above 1GHz is 1.5 m) above the ground at a 3 m anechoic chamber test site. The table was rotated 360 degree to determine the position of the highest radiation.
- c. The height of the equipment shall be 0.8 m (above 1GHz is 1.5 m); the height of the test antenna shall vary between 1 m to 4 m. Horizontal and vertical polarization of the antenna are set to make the measurement.
- d. The initial step in collecting conducted emission data is a spectrum analyzer peak detector mode pre-scanning the measurement frequency range. Significant peaks are then marked and QuasiPeak detector mode will be re-measured.
- e. If the Peak Mode measured value is compliance with and lower than Quasi Peak Mode Limit, the EUT shall be deemed to meet QP Limits and no additional QP Mode measurement was performed.
- f. For the actual test configuration, please refer to the related Item –EUT Test Photos.

Note:

Both horizontal and vertical antenna polarities were tested and performed pretest to three orthogonal axis. The worst case emissions were reported.

3.2.3 TEST SETUP

(A) Radiated Emission Test-Up Frequency Below 30MHz

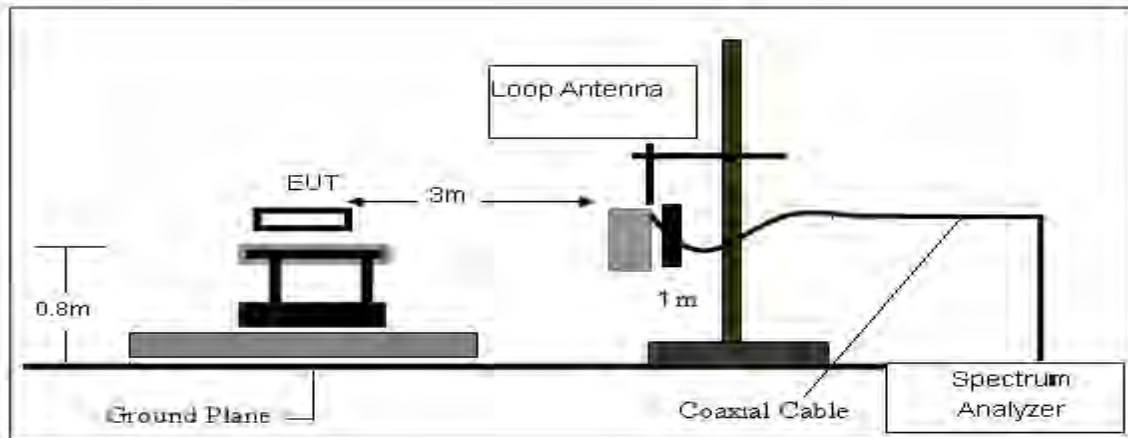

(B) Radiated Emission Test-Up Frequency 30MHz~1GHz

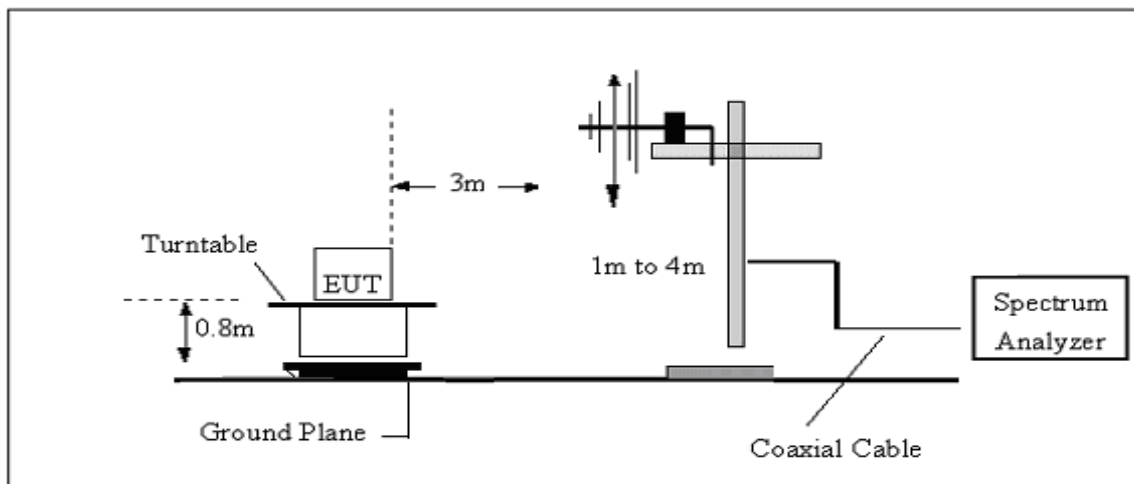

(C) Radiated Emission Test-Up Frequency Above 1GHz

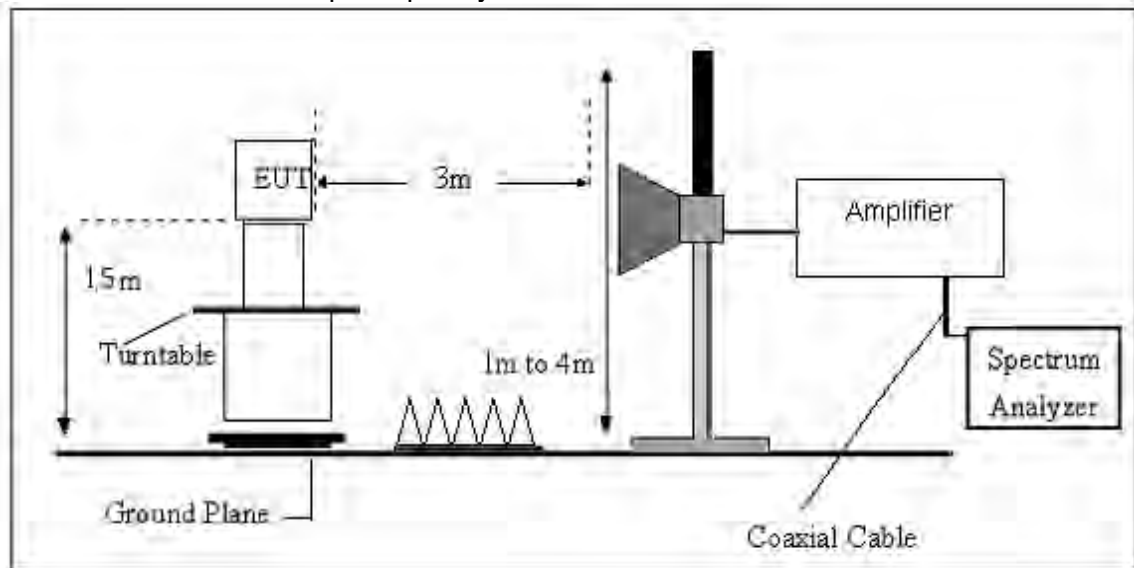

3.2.4 EUT OPERATING CONDITIONS

Please refer to section 3.1.4 of this report.

3.2.5 FIELD STRENGTH CALCULATION

The field strength is calculated by adding the Antenna Factor and Cable Factor and subtracting the Amplifier Gain and Duty Cycle Correction Factor (if any) from the measured reading. The basic equation with a sample calculation is as follows:

$$FS = RA + AF + CL - AG$$

Where

FS = Field Strength

CL = Cable Attenuation Factor (Cable Loss)

RA = Reading Amplitude

AG = Amplifier Gain

AF = Antenna Factor

For example

Frequency (MHz)	FS (dB μ V/m)	RA (dB μ V/m)	AF (dB)	CL (dB)	AG (dB)	Factor (dB)
300	40	58.1	12.2	1.6	31.9	-18.1

$$\text{Factor} = \text{AF} + \text{CL} - \text{AG}$$

3.2.6 TEST RESULT

9KHz-30MHz

Temperature:	23.1(C)	Relative Humidity:	60%RH
Test Voltage:	DC 3.8V	Polarization:	--
Test Mode:	TX Mode		

Freq.	Reading	Limit	Margin	State	Test Result
(MHz)	(dBuV/m)	(dBuV/m)	(dB)	P/F	
--	--	--	--	--	PASS
--	--	--	--	--	PASS

Note:

The amplitude of spurious emissions which are attenuated by more than 20dB below the permissible value has no need to be reported.

Distance extrapolation factor = $40 \log(\text{specific distance}/\text{test distance})$ (dB);

Limit line = specific limits(dBuv) + distance extrapolation factor.

(30MHz - 1000MHz)

Temperature:	23.1(C)	Relative Humidity:	60%RH
Test Voltage:	DC 3.8V	Phase:	Horizontal
Test Mode:	Mode 1/2/3/4/5/6/7/8/9 (Mode 8 worst mode)		

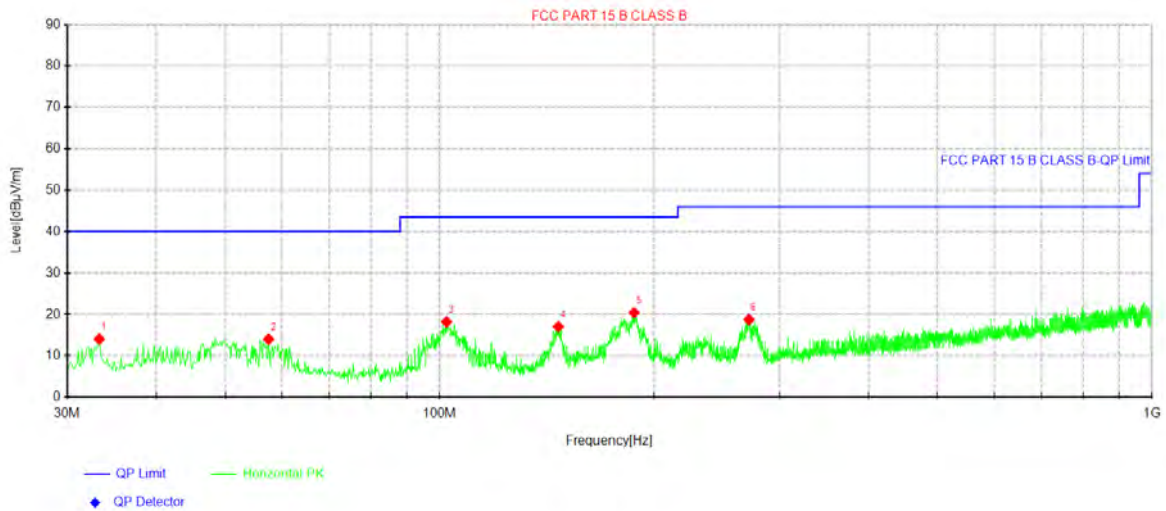

Suspected Data List									
NO.	Freq. [MHz]	Reading [dBµV]	Level [dBµV/m]	Factor [dB/m]	Limit [dBµV/m]	Margin [dB]	Height [cm]	Angle [°]	Polarity
1	33.2738	32.25	14.09	-18.16	40.00	25.91	100	171	Horizontal
2	57.5238	31.71	14.03	-17.68	40.00	25.97	100	25	Horizontal
3	102.265	36.69	18.22	-18.47	43.50	25.28	100	204	Horizontal
4	146.763	38.81	17.04	-21.77	43.50	26.46	100	253	Horizontal
5	187.503	40.48	20.41	-20.07	43.50	23.09	100	114	Horizontal
6	271.772	36.45	18.76	-17.69	46.00	27.24	100	293	Horizontal

Note:1).Level (dBµV/m)= Reading (dBµV)+ Factor (dB/m)

2). Factor(dB/m)=Antenna Factor (dB/m) + Cable loss (dB) - Pre Amplifier gain (dB)

3). Margin(dB) = Limit (dBµV/m) - Level (dBµV/m)

4). All modes have been tested,only show the worst case.

Temperature:	23.1(C)	Relative Humidity:	60%RH
Test Voltage:	DC 3.8V	Phase:	Vertical
Test Mode:	Mode 1/2/3/4/5/6/7/8/9 (Mode 8 worst mode)		

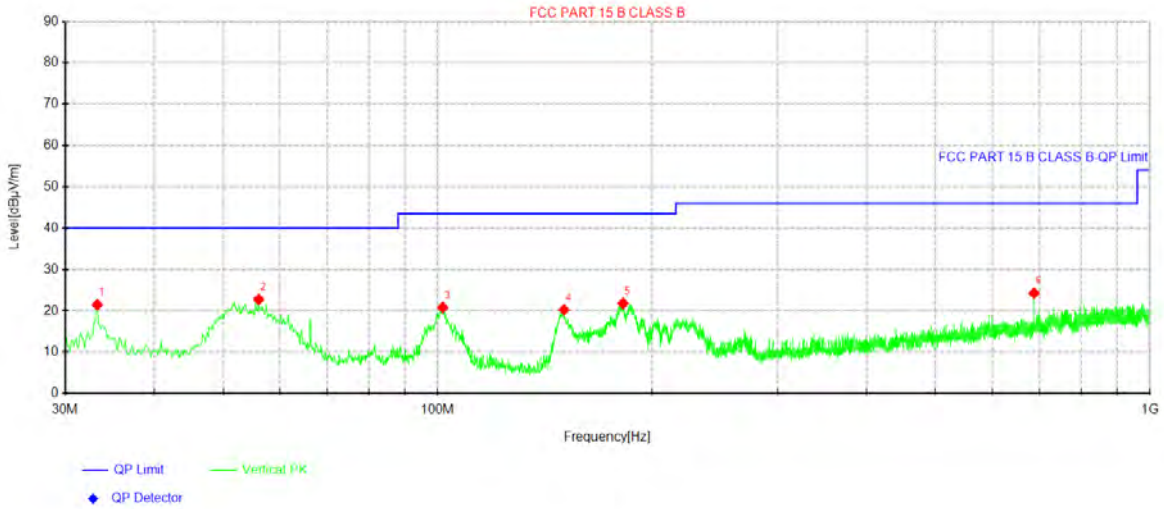

Suspected Data List									
NO.	Freq. [MHz]	Reading [dBµV]	Level [dBµV/m]	Factor [dB/m]	Limit [dBµV/m]	Margin [dB]	Height [cm]	Angle [°]	Polarity
1	33.2738	39.65	21.49	-18.16	40.00	18.51	100	284	Vertical
2	56.0688	40.11	22.75	-17.36	40.00	17.25	100	187	Vertical
3	101.658	39.25	20.81	-18.44	43.50	22.69	100	131	Vertical
4	150.401	41.99	20.24	-21.75	43.50	23.26	100	237	Vertical
5	182.047	42.20	21.79	-20.41	43.50	21.71	100	203	Vertical
6	687.538	36.02	24.28	-11.74	46.00	21.72	100	91	Vertical

Note:1). Level (dBµV/m) = Reading (dBµV) + Factor (dB/m)

2). Factor (dB/m) = Antenna Factor (dB/m) + Cable loss (dB) - Pre Amplifier gain (dB)

3). Margin (dB) = Limit (dBµV/m) - Level (dBµV/m)

4). All modes have been tested, only show the worst case.

(1000MHz-25GHz) Spurious emission Requirements

802.11 n(HT20)

Frequency (MHz)	Meter Reading (dBμV)	Amplifier (dB)	Loss (dB)	Antenna Factor (dB/m)	Corrected Factor (dB)	Emission Level (dBμV/m)	Limits (dBμV/m)	Margin (dB)	Detector Type	Comment
Low Channel (802.11n20/2412 MHz)										
3264.86	61.97	44.70	6.70	28.20	-9.80	52.17	74.00	-21.83	PK	Vertical
3264.86	51.67	44.70	6.70	28.20	-9.80	41.87	54.00	-12.13	AV	Vertical
3264.85	62.03	44.70	6.70	28.20	-9.80	52.23	74.00	-21.77	PK	Horizontal
3264.85	50.71	44.70	6.70	28.20	-9.80	40.91	54.00	-13.09	AV	Horizontal
4824.41	59.26	44.20	9.04	31.60	-3.56	55.70	74.00	-18.30	PK	Vertical
4824.41	49.81	44.20	9.04	31.60	-3.56	46.25	54.00	-7.75	AV	Vertical
4824.32	58.89	44.20	9.04	31.60	-3.56	55.33	74.00	-18.67	PK	Horizontal
4824.32	50.11	44.20	9.04	31.60	-3.56	46.55	54.00	-7.45	AV	Horizontal
5359.78	48.14	44.20	9.86	32.00	-2.34	45.80	74.00	-28.20	PK	Vertical
5359.78	39.56	44.20	9.86	32.00	-2.34	37.22	54.00	-16.78	AV	Vertical
5359.65	47.83	44.20	9.86	32.00	-2.34	45.49	74.00	-28.51	PK	Horizontal
5359.65	39.49	44.20	9.86	32.00	-2.34	37.14	54.00	-16.86	AV	Horizontal
7235.91	54.91	43.50	11.40	35.50	3.40	58.31	74.00	-15.69	PK	Vertical
7235.91	44.30	43.50	11.40	35.50	3.40	47.70	54.00	-6.30	AV	Vertical
7235.95	53.54	43.50	11.40	35.50	3.40	56.94	74.00	-17.06	PK	Horizontal
7235.95	44.18	43.50	11.40	35.50	3.40	47.58	54.00	-6.42	AV	Horizontal
Middle Channel (802.11n20/2437 MHz)										
3264.80	61.78	44.70	6.70	28.20	-9.80	51.98	74.00	-22.02	PK	Vertical
3264.80	51.12	44.70	6.70	28.20	-9.80	41.32	54.00	-12.68	AV	Vertical
3264.67	61.76	44.70	6.70	28.20	-9.80	51.96	74.00	-22.04	PK	Horizontal
3264.67	50.25	44.70	6.70	28.20	-9.80	40.45	54.00	-13.55	AV	Horizontal
4874.47	59.48	44.20	9.04	31.60	-3.56	55.92	74.00	-18.08	PK	Vertical
4874.47	49.35	44.20	9.04	31.60	-3.56	45.79	54.00	-8.21	AV	Vertical
4874.54	58.17	44.20	9.04	31.60	-3.56	54.61	74.00	-19.39	PK	Horizontal
4874.54	49.95	44.20	9.04	31.60	-3.56	46.39	54.00	-7.61	AV	Horizontal
5359.61	49.18	44.20	9.86	32.00	-2.34	46.83	74.00	-27.17	PK	Vertical
5359.61	39.31	44.20	9.86	32.00	-2.34	36.97	54.00	-17.03	AV	Vertical
5359.76	47.79	44.20	9.86	32.00	-2.34	45.45	74.00	-28.55	PK	Horizontal
5359.76	38.66	44.20	9.86	32.00	-2.34	36.31	54.00	-17.69	AV	Horizontal
7310.80	54.15	43.50	11.40	35.50	3.40	57.55	74.00	-16.45	PK	Vertical
7310.80	44.72	43.50	11.40	35.50	3.40	48.12	54.00	-5.88	AV	Vertical
7310.85	54.01	43.50	11.40	35.50	3.40	57.41	74.00	-16.59	PK	Horizontal
7310.85	43.57	43.50	11.40	35.50	3.40	46.97	54.00	-7.03	AV	Horizontal

High Channel (802.11n20/2462 MHz)										
3264.64	61.47	44.70	6.70	28.20	-9.80	51.67	74.00	-22.33	PK	Vertical
3264.64	51.48	44.70	6.70	28.20	-9.80	41.68	54.00	-12.32	AV	Vertical
3264.86	62.16	44.70	6.70	28.20	-9.80	52.36	74.00	-21.64	PK	Horizontal
3264.86	51.33	44.70	6.70	28.20	-9.80	41.53	54.00	-12.47	AV	Horizontal
4924.29	59.42	44.20	9.04	31.60	-3.56	55.86	74.00	-18.14	PK	Vertical
4924.29	50.52	44.20	9.04	31.60	-3.56	46.96	54.00	-7.04	AV	Vertical
4924.54	58.94	44.20	9.04	31.60	-3.56	55.38	74.00	-18.62	PK	Horizontal
4924.54	49.82	44.20	9.04	31.60	-3.56	46.26	54.00	-7.74	AV	Horizontal
5359.72	49.42	44.20	9.86	32.00	-2.34	47.08	74.00	-26.92	PK	Vertical
5359.72	38.95	44.20	9.86	32.00	-2.34	36.61	54.00	-17.39	AV	Vertical
5359.86	47.99	44.20	9.86	32.00	-2.34	45.64	74.00	-28.36	PK	Horizontal
5359.86	39.41	44.20	9.86	32.00	-2.34	37.07	54.00	-16.93	AV	Horizontal
7385.93	53.95	43.50	11.40	35.50	3.40	57.35	74.00	-16.65	PK	Vertical
7385.93	44.34	43.50	11.40	35.50	3.40	47.74	54.00	-6.26	AV	Vertical
7385.87	53.86	43.50	11.40	35.50	3.40	57.26	74.00	-16.74	PK	Horizontal
7385.87	44.18	43.50	11.40	35.50	3.40	47.58	54.00	-6.42	AV	Horizontal

Remark:

- Factor = Antenna Factor + Cable Loss – Pre-amplifier.
- Scan with 802.11b, 802.11g, 802.11n (HT-20), 802.11n (HT-40) the worst case is 802.11 n(HT20).
Emission Level = Reading + Factor
Margin = Emission Level-Limit
- The frequency emission of peak points that did not show above the forms are at least 20dB below the limit, the frequency emission is mainly from the environment noise.

3.2.6 TEST RESULTS(Band edge Requirements)

802.11 n(HT20)

Frequency	Meter Reading	Amplifier	Loss	Antenna Factor	Corrected Factor	Emission Level	Limits	Margin	Detector	Comment
(MHz)	(dB μ V)	(dB)	(dB)	(dB/m)	(dB)	(dB μ V/m)	(dB μ V/m)	(dB)	Type	
2390.00	66.50	43.80	4.91	25.90	-12.99	53.51	74.00	-20.49	PK	Vertical
2390.00	52.56	43.80	4.91	25.90	-12.99	39.57	54.00	-14.43	AV	Vertical
2390.00	65.46	43.80	4.91	25.90	-12.99	52.47	74.00	-21.53	PK	Horizontal
2390.00	53.41	43.80	4.91	25.90	-12.99	40.42	54.00	-13.58	AV	Horizontal
2483.50	65.72	43.80	5.12	25.90	-12.78	52.94	74.00	-21.06	PK	Vertical
2483.50	52.46	43.80	5.12	25.90	-12.78	39.68	54.00	-14.32	AV	Vertical
2483.50	65.05	43.80	5.12	25.90	-12.78	52.27	74.00	-21.73	PK	Horizontal
2483.50	52.70	43.80	5.12	25.90	-12.78	39.92	54.00	-14.08	AV	Horizontal

Note: 802.11b, 802.11g, 802.11n (HT-20), 802.11n (HT-40) mode all have been tested, the worst case is 802.11 n(HT20), only show the worst case.

4. CONDUCTED SPURIOUS & BAND EDGE EMISSION

4.1 LIMIT

According to FCC section 15.247(d), in any 100kHz bandwidth outside the frequency band in which the spread spectrum or digitally modulated intentional radiator is operating, the radio frequency power that is produced by the intentional radiator shall be at least 20dB below that in the 100kHz bandwidth within the band that contains the highest level of the desired power, based on either an RF conducted or a radiated measurement.

4.2 TEST PROCEDURE

Spectrum Parameter	Setting
Detector	Peak
Start/Stop Frequency	30 MHz to 10th carrier harmonic
RB / VB (emission in restricted band)	100 KHz/300 KHz
Trace-Mode:	Max hold

For Band edge

Spectrum Parameter	Setting
Detector	Peak
Start/Stop Frequency	Lower Band Edge: 2300 to 2432 MHz Upper Band Edge: 2442 to 2500 MHz
RB / VB (emission in restricted band)	100 KHz/300 KHz
Trace-Mode:	Max hold

4.3 DEVIATION FROM STANDARD

No deviation.

4.4 TEST SETUP



The EUT is connected to the Spectrum Analyzer; the RF load attached to the EUT antenna terminal is 50Ohm; the path loss as the factor is calibrated to correct the reading.

Make the measurement with the spectrum analyzer's resolution bandwidth (RBW) = 100 kHz. In order to make an accurate measurement, set the span greater than RBW.

4.5 EUT OPERATION CONDITIONS

Please refer to section 3.1.4 of this report.

4.6 TEST RESULTS

Note: The test data please refer to APPENDIX 1.

5. POWER SPECTRAL DENSITY TEST

5.1 LIMIT

FCC Part15.247 , Subpart C				
Section	Test Item	Limit	Frequency Range (MHz)	Result
15.247(e)	Power Spectral Density	≤ 8 dBm (RBW ≥ 3 KHz)	2400-2483.5	PASS

5.2 TEST PROCEDURE

1. Set analyzer center frequency to DTS channel center frequency.
2. Set the span to 1.5 times the DTS channel bandwidth.
3. Set the $100 \text{ kHz} \geq \text{RBW} \geq 3 \text{ kHz}$.
4. Set the $\text{VBW} \geq 3 \times \text{RBW}$.
5. Detector = peak.
6. Sweep time = auto couple.
7. Trace mode = max hold.
8. Allow trace to fully stabilize.
9. Use the peak marker function to determine the maximum amplitude level.
10. If measured value exceeds limit, reduce RBW (no less than 3 kHz) and repeat.

5.3 DEVIATION FROM STANDARD

No deviation.

5.4 TEST SETUP



5.5 EUT OPERATION CONDITIONS

Please refer to section 3.1.4 of this report.

5.6 TEST RESULTS

Note: The test data please refer to APPENDIX 1.

6. BANDWIDTH TEST

6.1 LIMIT

FCC Part15.247,Subpart C				
Section	Test Item	Limit	Frequency Range (MHz)	Result
15.247(a)(2)	Bandwidth	$\geq 500\text{KHz}$ (6dB bandwidth)	2400-2483.5	PASS

6.2 TEST PROCEDURE

The automatic bandwidth measurement capability of an instrument may be employed using the X dB bandwidth mode with X set to 6 dB, if the functionality described above (i.e., RBW = 100 kHz, VBW \geq 3RBW, peak detector with maximum hold) is implemented by the instrumentation function. When using this capability, care shall be taken so that the bandwidth measurement is not influenced by any intermediate power nulls in the fundamental emission that might be ≥ 6 dB.

6.3 DEVIATION FROM STANDARD

No deviation.

6.4 TEST SETUP



6.5 EUT OPERATION CONDITIONS

Please refer to section 3.1.4 of this report.

6.6 TEST RESULTS

Note: The test data please refer to APPENDIX 1.

7. PEAK OUTPUT POWER TEST

7.1 LIMIT

FCC Part15.247,Subpart C				
Section	Test Item	Limit	Frequency Range (MHz)	Result
15.247(b)(3)	Output Power	1 watt or 30dBm	2400-2483.5	PASS

7.2 TEST PROCEDURE

One of the following procedures may be used to determine the maximum peak conducted output power of a DTS EUT.

RBW \geq DTS bandwidth

The following procedure shall be used when an instrument with a resolution bandwidth that is greater than the DTS bandwidth is available to perform the measurement:

- Set the RBW \geq DTS bandwidth.
- Set VBW \geq [3 \times RBW].
- Set span \geq [3 \times RBW].
- Sweep time = auto couple.
- Detector = peak.
- Trace mode = max hold.
- Allow trace to fully stabilize.
- Use peak marker function to determine the peak amplitude level.

Integrated band power method:

The following procedure can be used when the maximum available RBW of the instrument is less than the

DTS bandwidth:

- Set the RBW = 1 MHz.
- Set the VBW \geq [3 \times RBW].
- Set the span \geq [1.5 \times DTS bandwidth].
- Detector = peak.
- Sweep time = auto couple.
- Trace mode = max hold.
- Allow trace to fully stabilize.
- Use the instrument's band/channel power measurement function with the band limits set equal to the DTS bandwidth edges (for some instruments, this may require a manual override to select the peak detector). If the instrument does not have a band power function, then sum the spectrum levels (in linear power units) at intervals equal to the RBW extending across the DTS channel bandwidth.

PKPM1 Peak power meter method:

The maximum peak conducted output power may be measured using a broadband peak RF power meter. The power meter shall have a video bandwidth that is greater than or equal to the DTS bandwidth and shall use a fast-responding diode detector.

7.3 DEVIATION FROM STANDARD

No deviation.

7.4 TEST SETUP



7.5 EUT OPERATION CONDITIONS

Please refer to section 3.1.4 of this report.

7.6 TEST RESULTS

Note: The test data please refer to APPENDIX 1.

8. ANTENNA REQUIREMENT

8.1 STANDARD REQUIREMENT

15.203 requirement: For intentional device, according to 15.203: an intentional radiator shall be designed to ensure that no antenna other than that furnished by the responsible party shall be used with the device.

8.2 EUT ANTENNA

The EUT antenna is PIFA Antenna. It comply with the standard requirement.

APPENDIX 1-TEST DATA

1. Duty Cycle

Condition	Mode	Frequency (MHz)	Duty Cycle (%)	Correction Factor (dB)	1/T (kHz)
NVNT	b	2412	92.82	0.32	1.36
NVNT	b	2437	93.89	0.27	1.36
NVNT	b	2462	93.95	0.27	1.36
NVNT	g	2412	68.71	1.63	8.56
NVNT	g	2437	68.82	1.62	8.55
NVNT	g	2462	68.9	1.62	8.55
NVNT	n20	2412	70.22	1.54	8
NVNT	n20	2437	70.22	1.54	8
NVNT	n20	2462	70.22	1.54	8

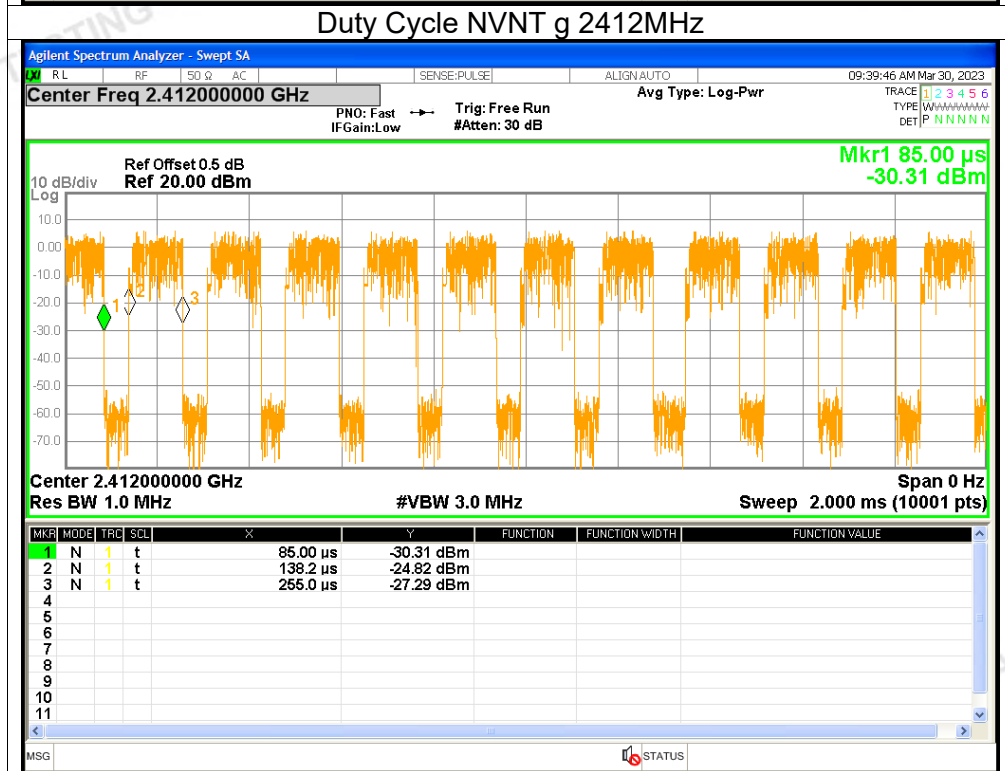
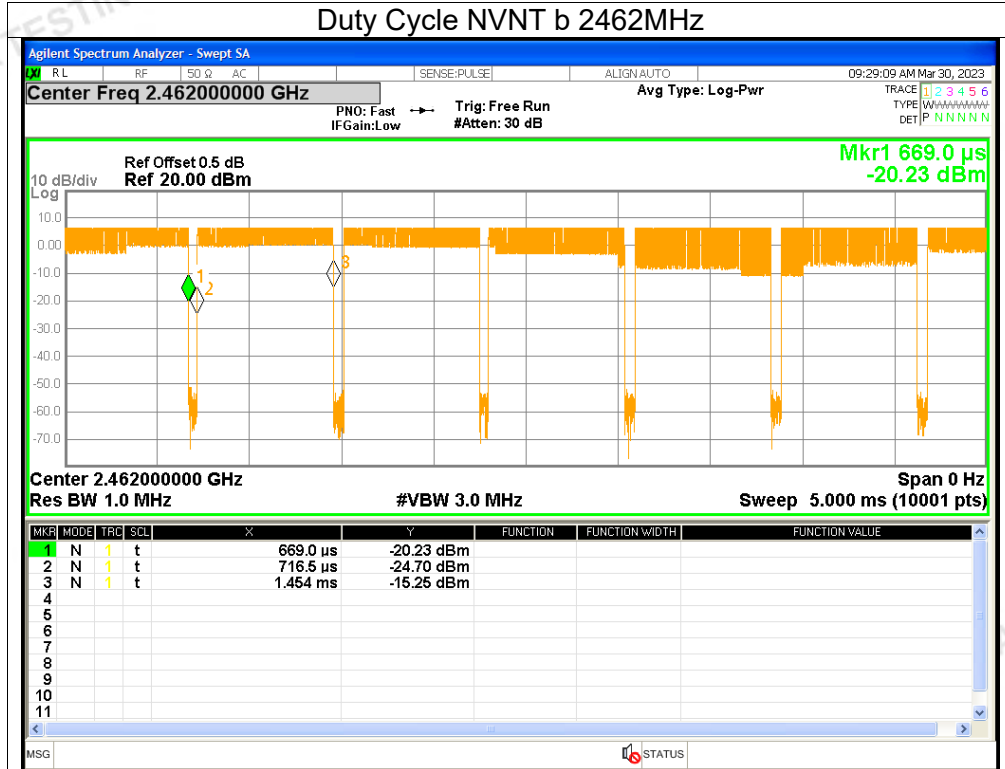

2. Maximum Average Conducted Output Power

Condition	Mode	Frequency (MHz)	Conducted Power (dBm)	Duty Factor (dB)	Total Power (dBm)	Limit (dBm)	Verdict
NVNT	b	2412	11.74	0.32	12.06	<=30	Pass
NVNT	b	2437	13.02	0.27	13.29	<=30	Pass
NVNT	b	2462	12.04	0.27	12.31	<=30	Pass
NVNT	g	2412	9.88	1.63	11.51	<=30	Pass
NVNT	g	2437	10.92	1.62	12.54	<=30	Pass
NVNT	g	2462	9.96	1.62	11.58	<=30	Pass
NVNT	n20	2412	10.3	1.54	11.84	<=30	Pass
NVNT	n20	2437	11.25	1.54	12.79	<=30	Pass
NVNT	n20	2462	10.24	1.54	11.78	<=30	Pass

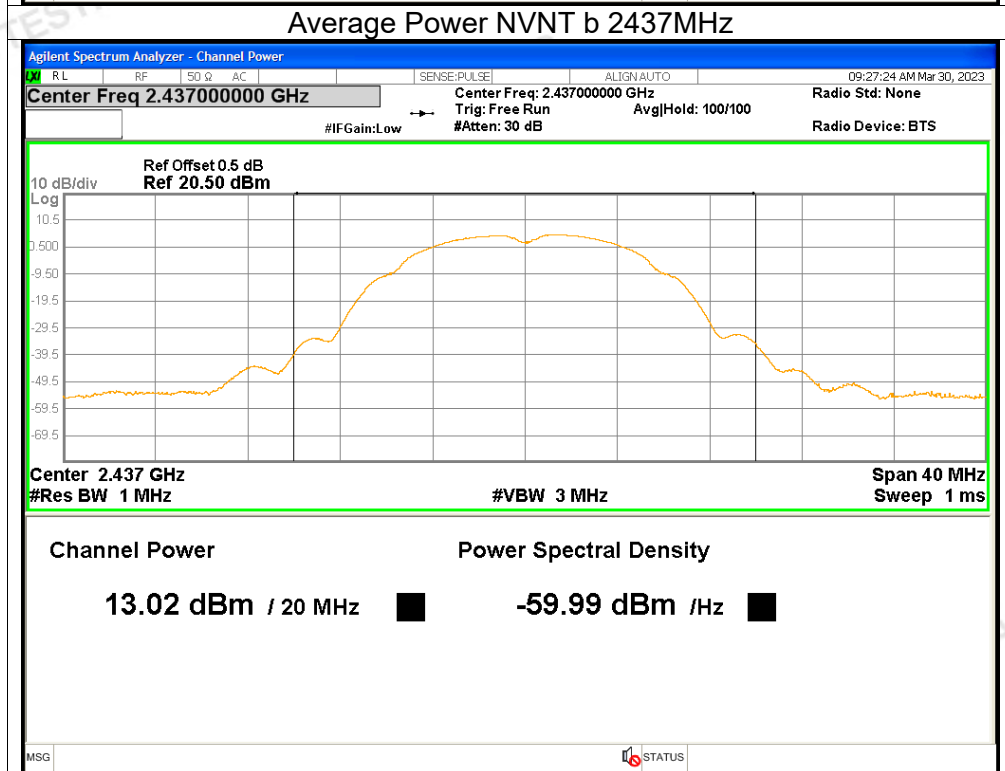
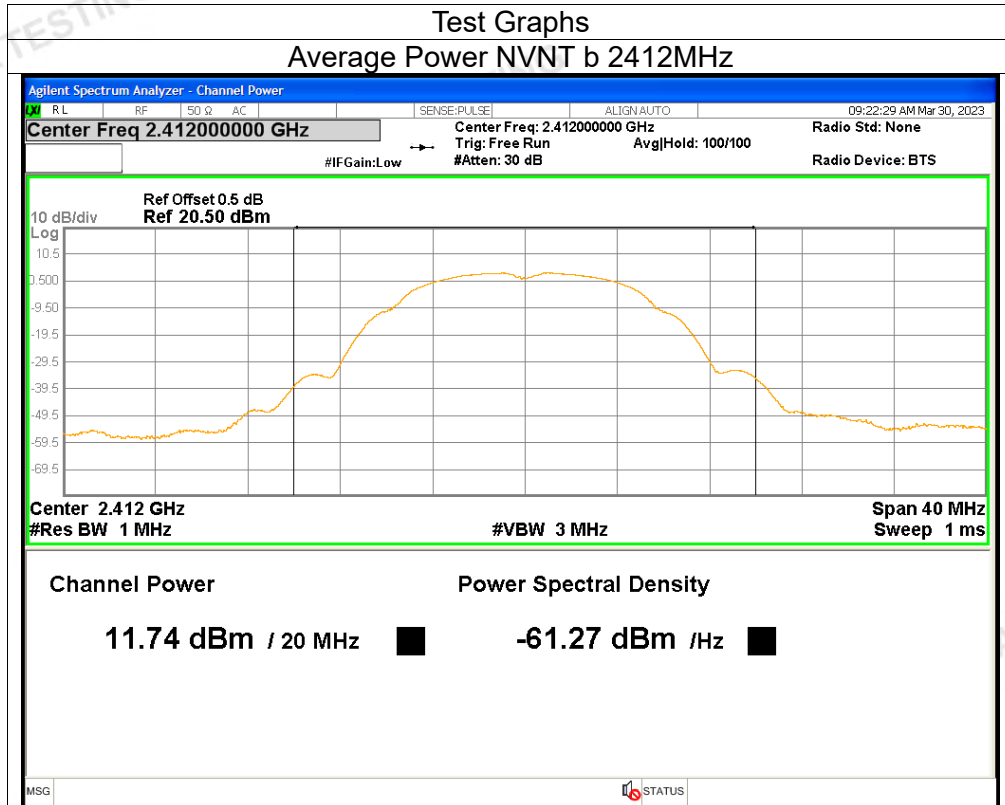

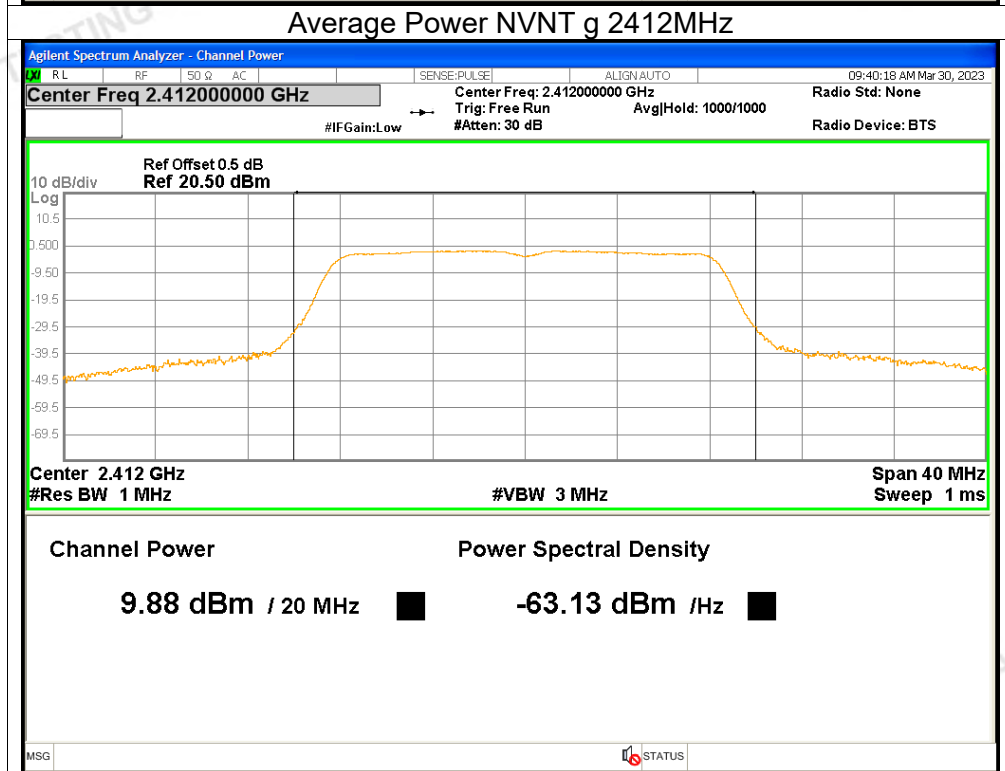
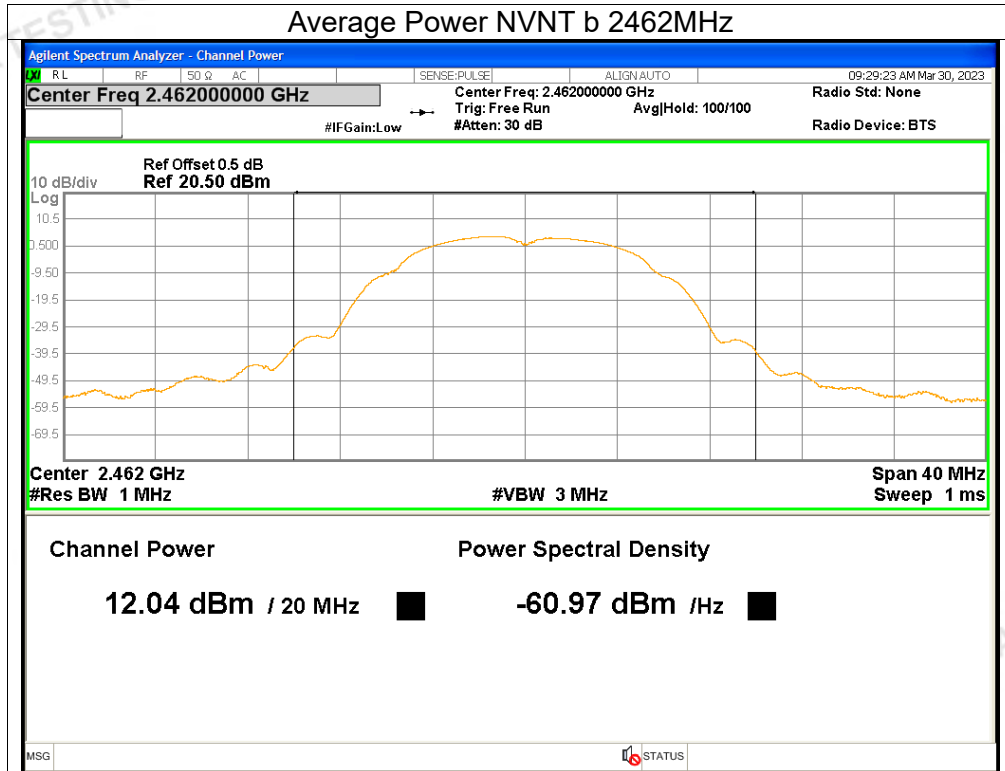

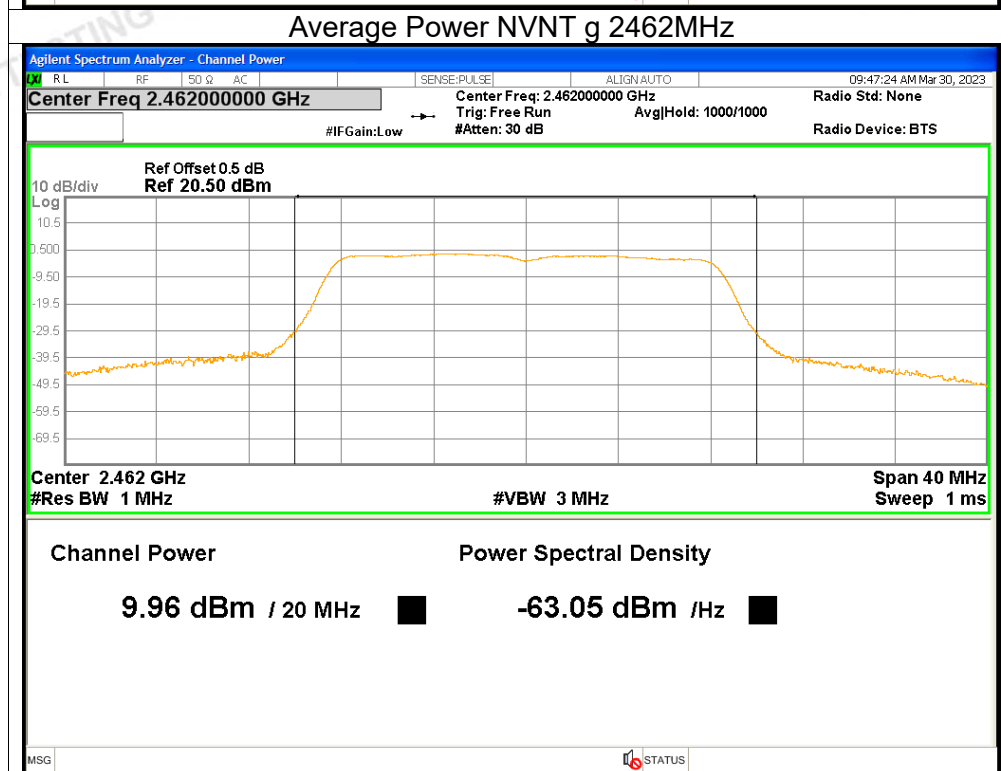
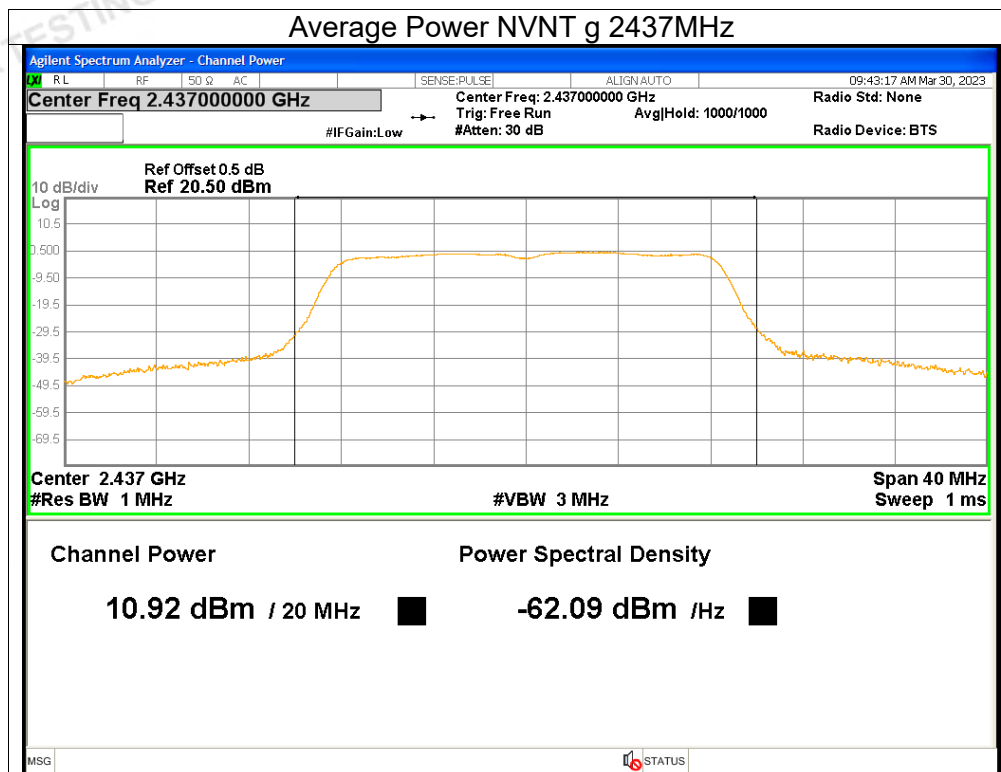

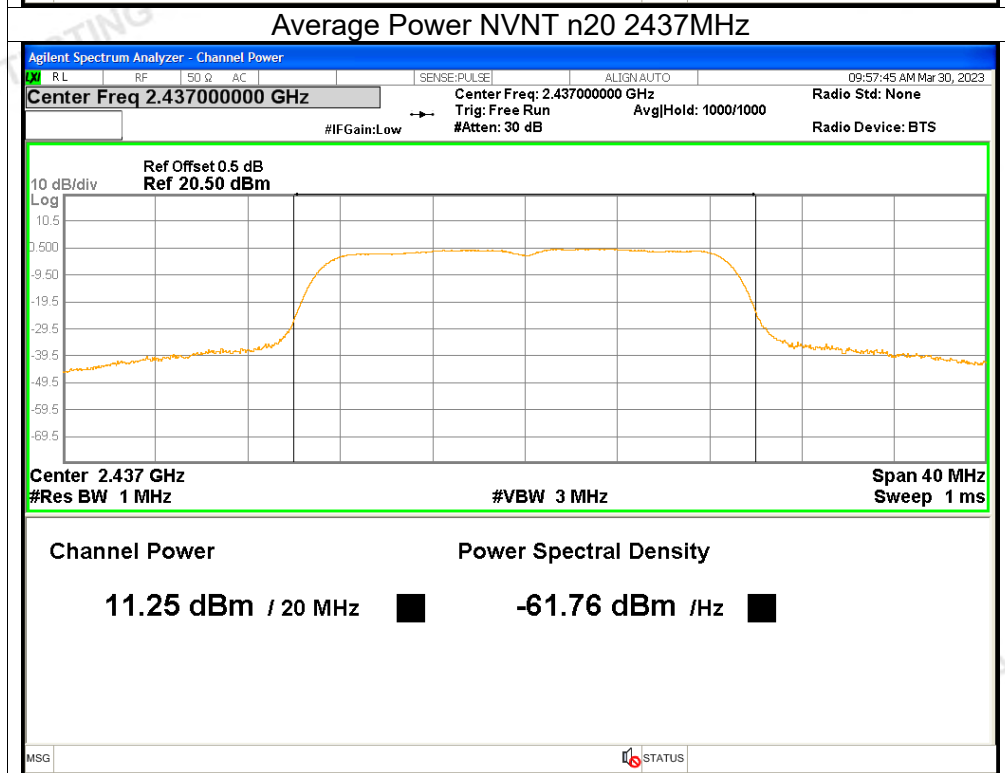
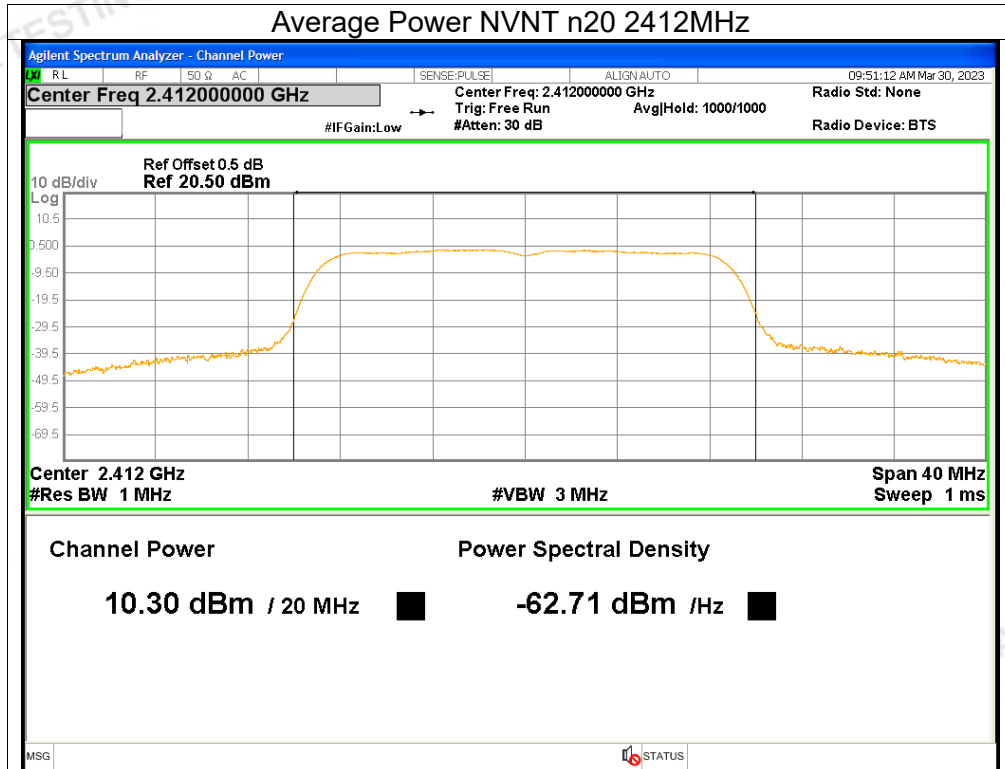

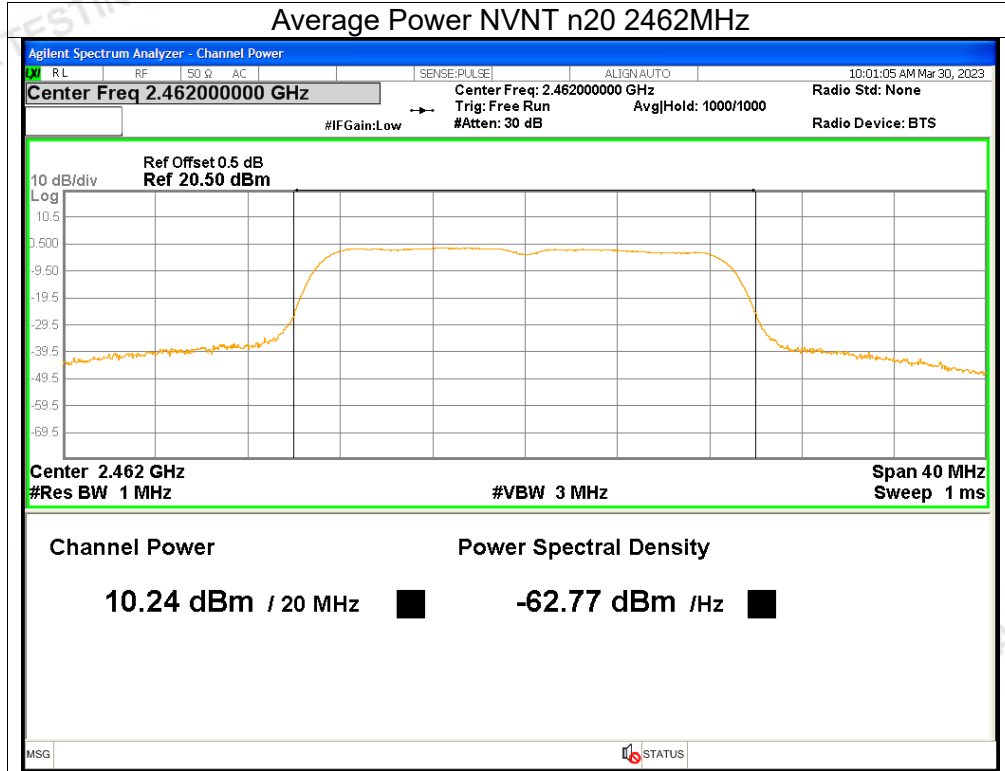

3. Maximum Peak Conducted Output Power

Condition	Mode	Frequency (MHz)	Conducted Power (dBm)	Limit (dBm)	Verdict
NVNT	b	2412	14.94	<=30	Pass
NVNT	b	2437	15.89	<=30	Pass
NVNT	b	2462	14.84	<=30	Pass
NVNT	g	2412	19.51	<=30	Pass
NVNT	g	2437	20.55	<=30	Pass
NVNT	g	2462	19.63	<=30	Pass
NVNT	n20	2412	19.9	<=30	Pass
NVNT	n20	2437	20.85	<=30	Pass
NVNT	n20	2462	19.86	<=30	Pass

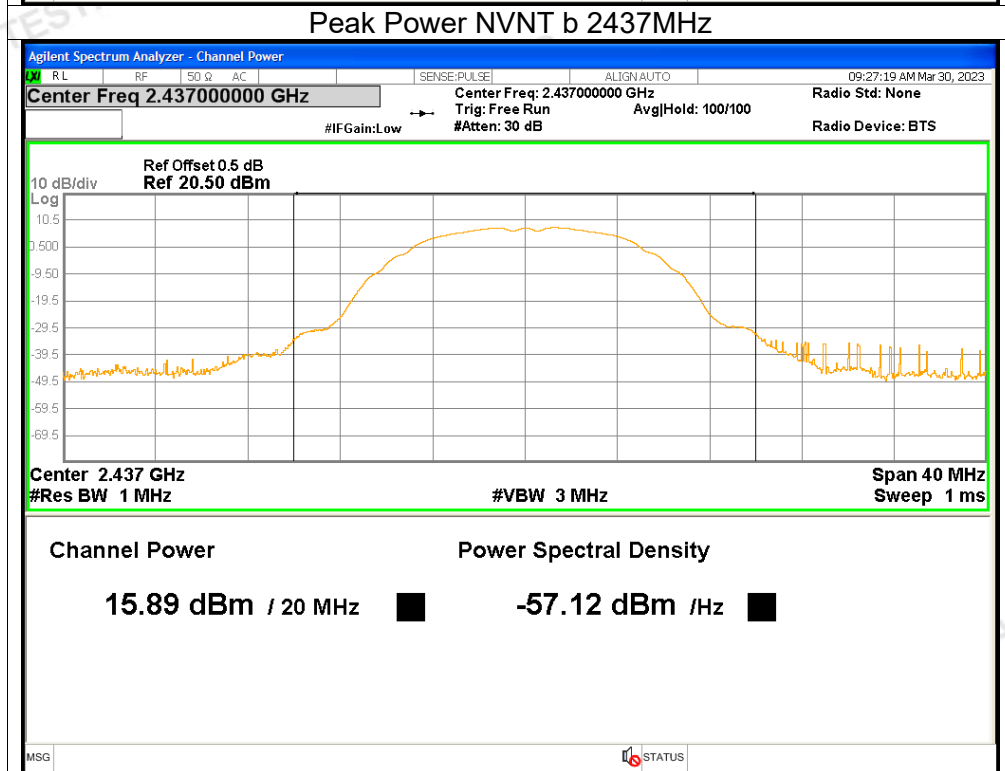
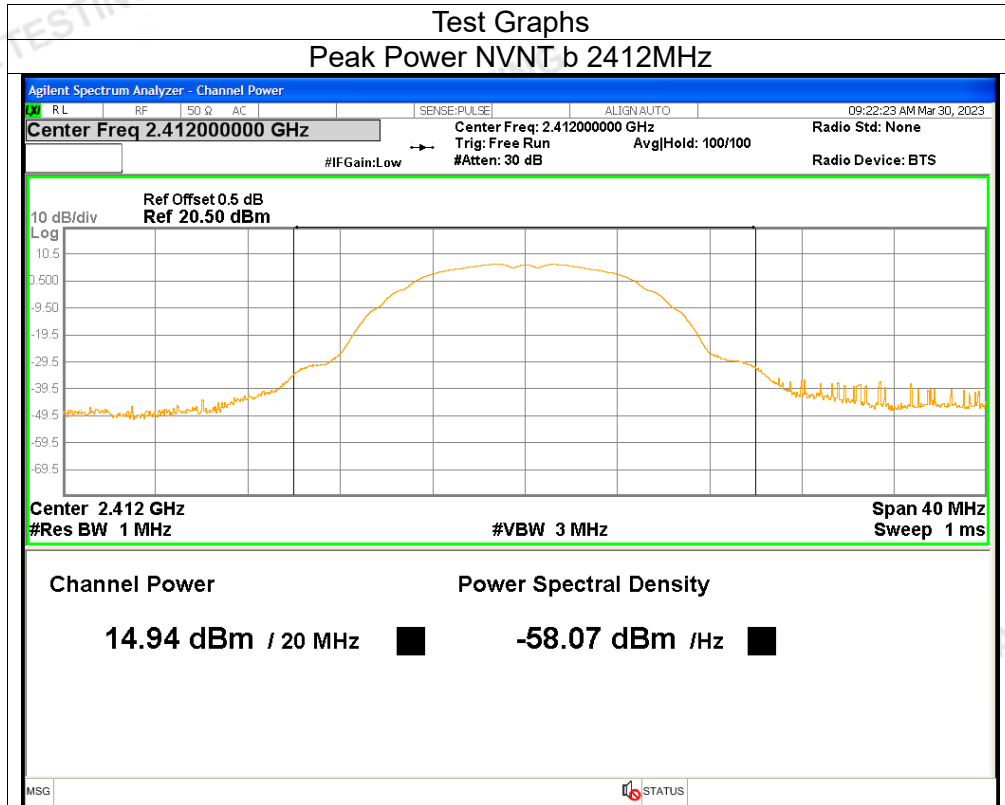

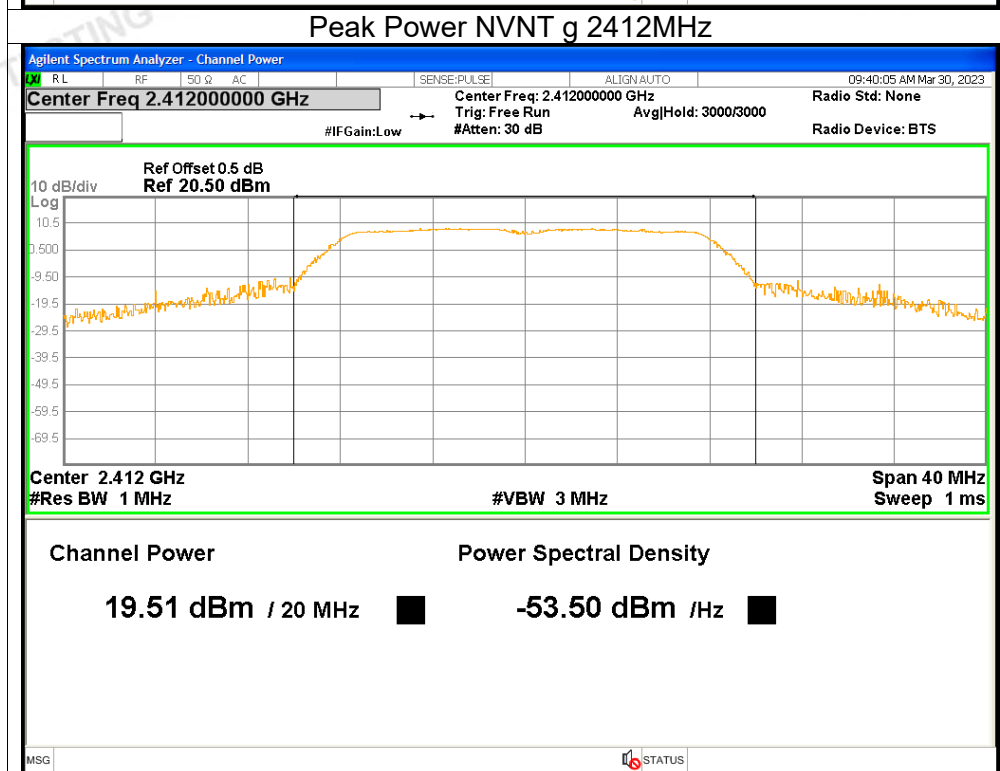
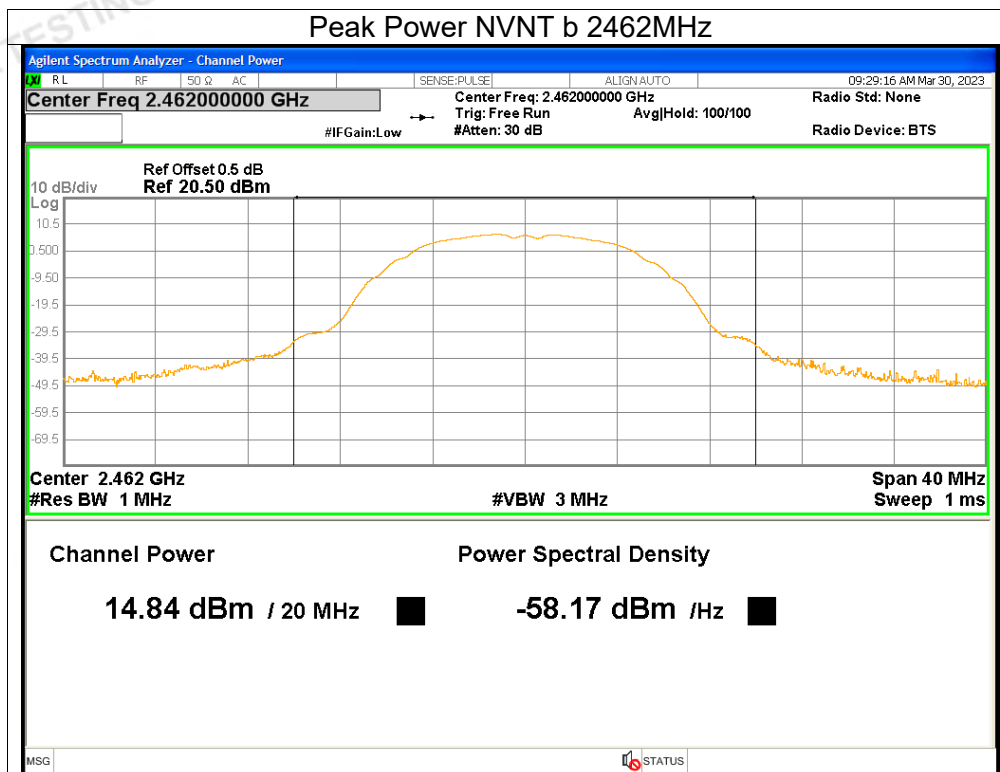

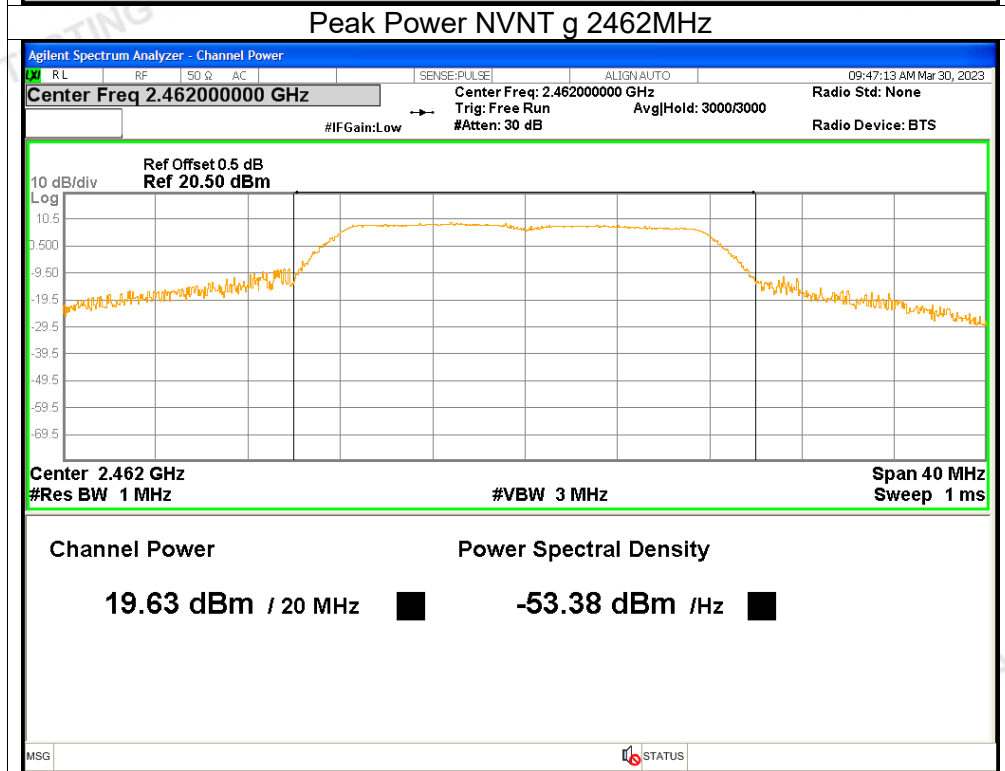
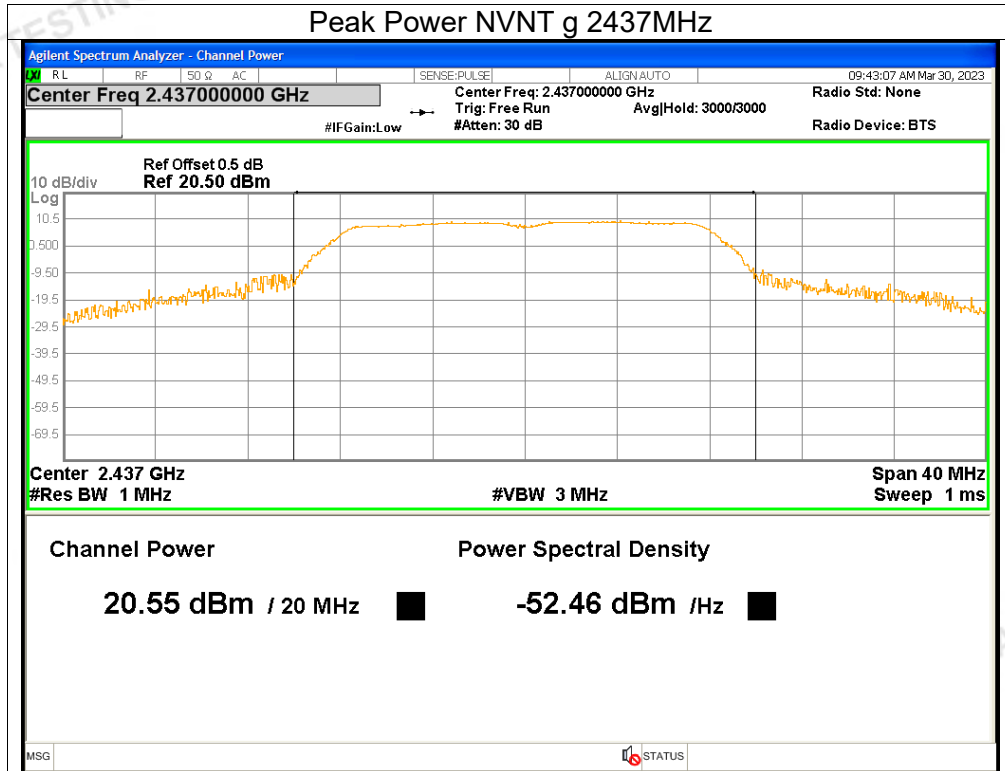

Peak Power NVNT n20 2412MHz

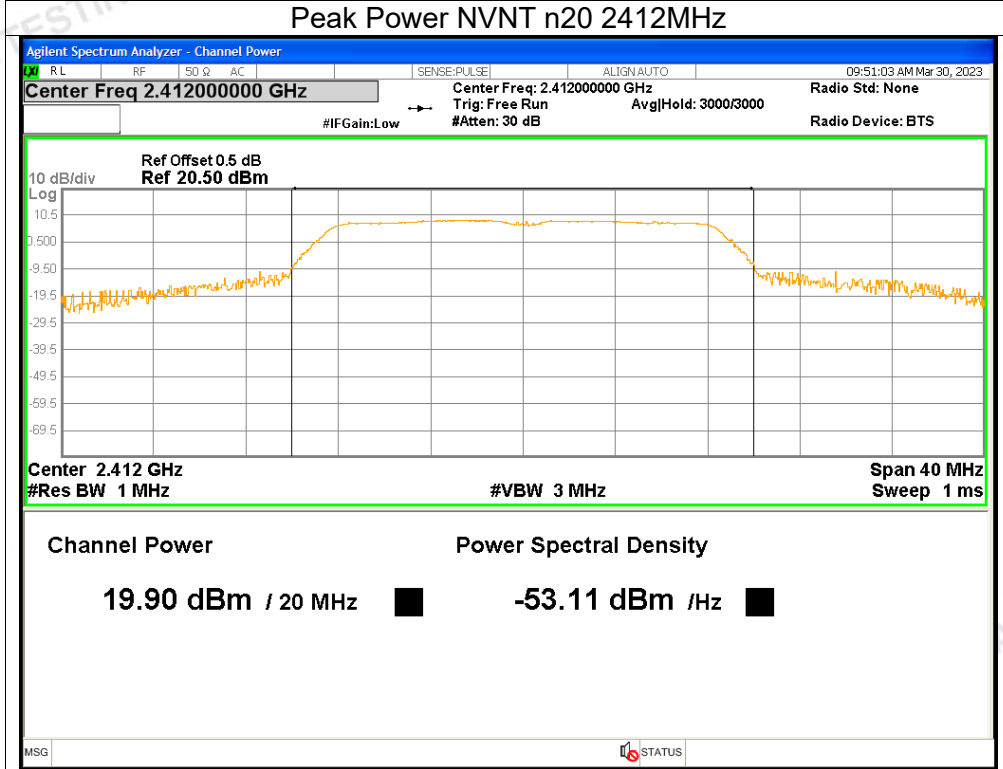

Peak Power NVNT n20 2437MHz

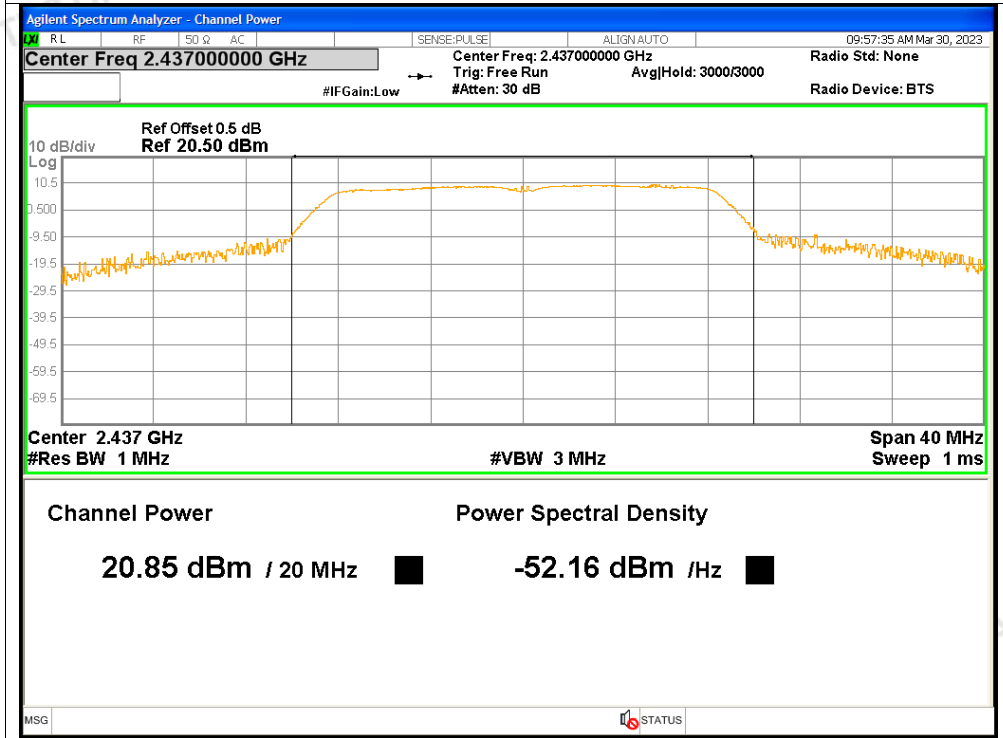

Peak Power NVNT n20 2462MHz

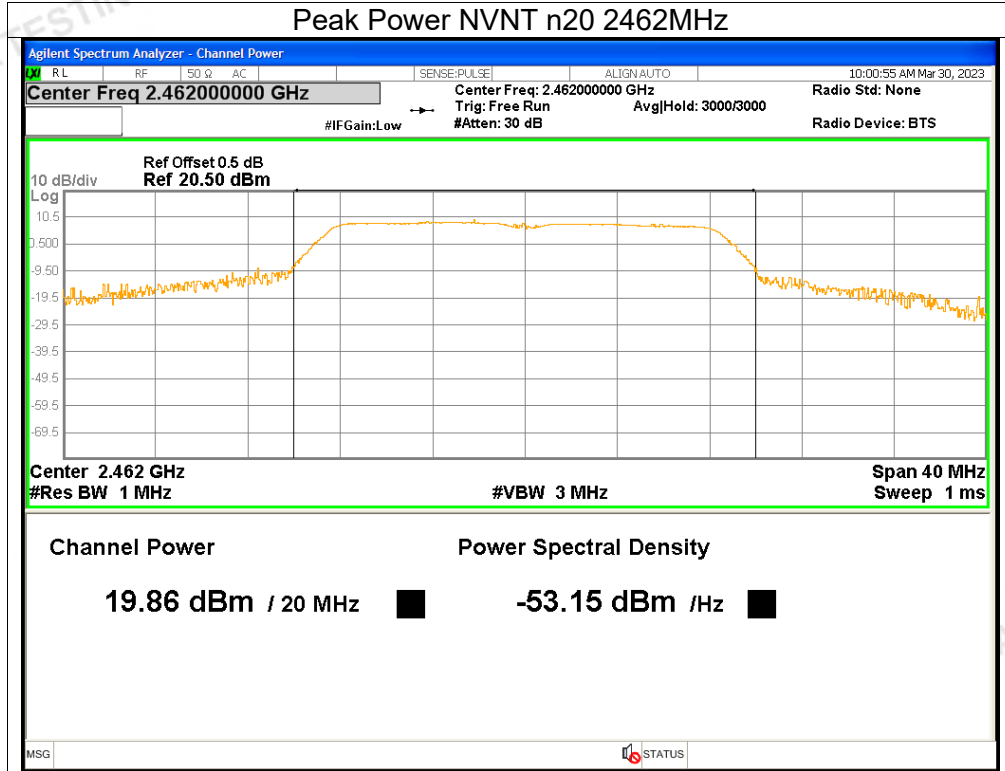

4. -6dB Bandwidth

Condition	Mode	Frequency (MHz)	-6 dB Bandwidth (MHz)	Limit -6 dB Bandwidth (MHz)	Verdict
NVNT	b	2412	8.4952	>=0.5	Pass
NVNT	b	2437	8.5482	>=0.5	Pass
NVNT	b	2462	8.5764	>=0.5	Pass
NVNT	g	2412	16.2768	>=0.5	Pass
NVNT	g	2437	16.0317	>=0.5	Pass
NVNT	g	2462	16.0703	>=0.5	Pass
NVNT	n20	2412	16.8162	>=0.5	Pass
NVNT	n20	2437	16.4435	>=0.5	Pass
NVNT	n20	2462	16.9371	>=0.5	Pass

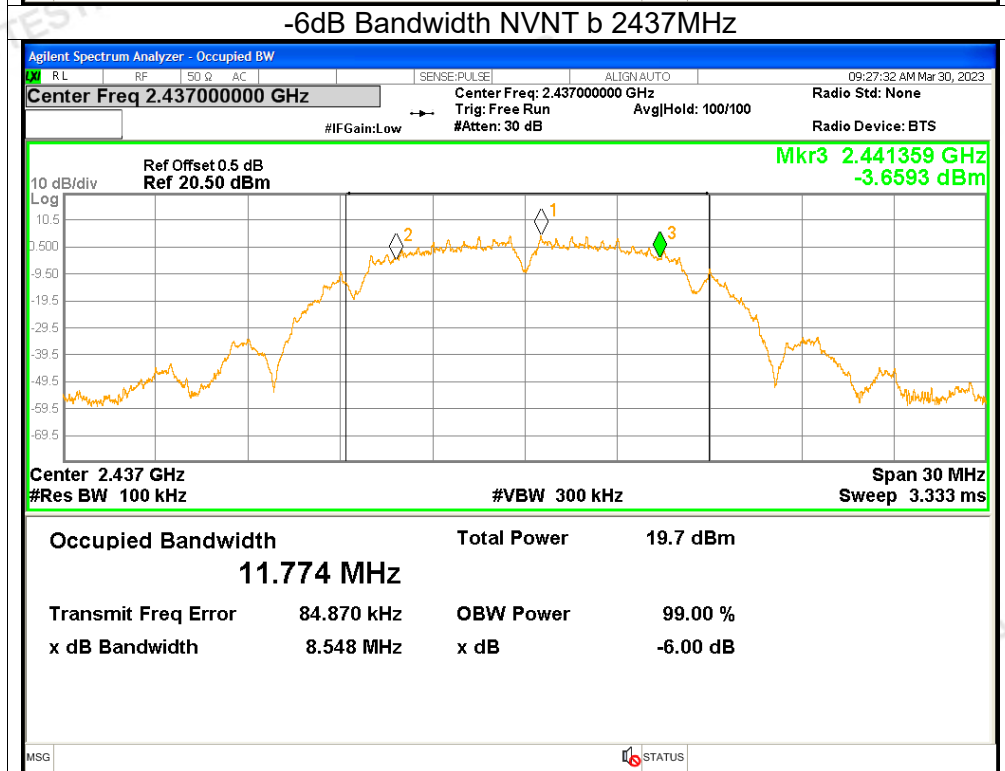
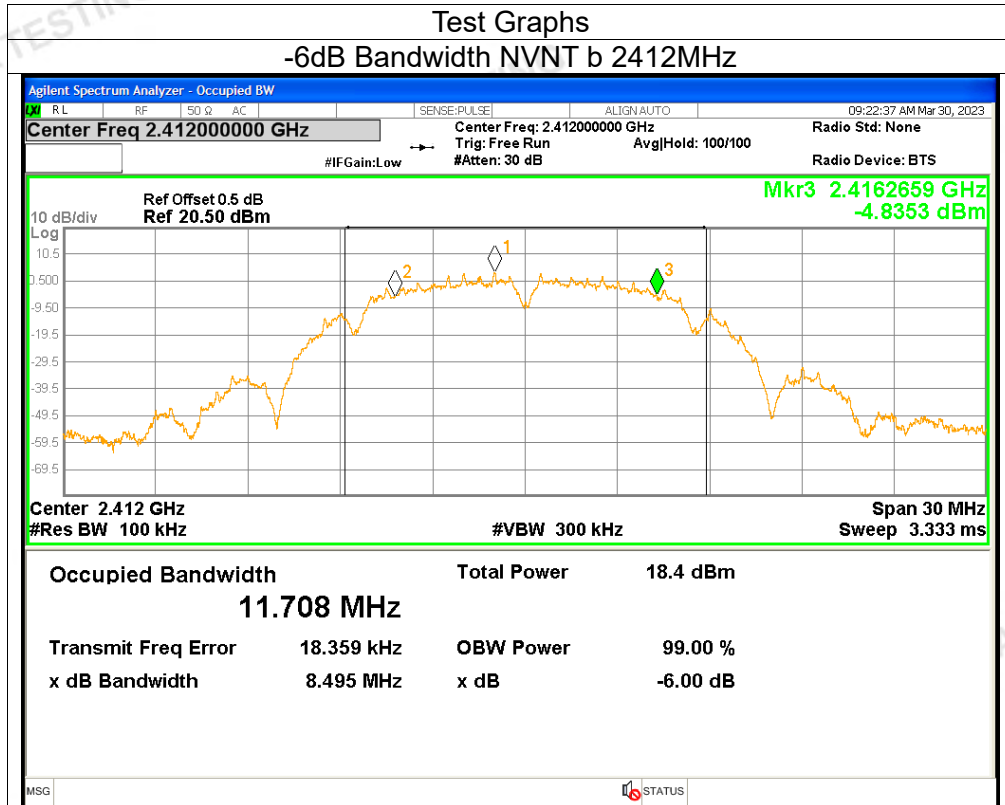

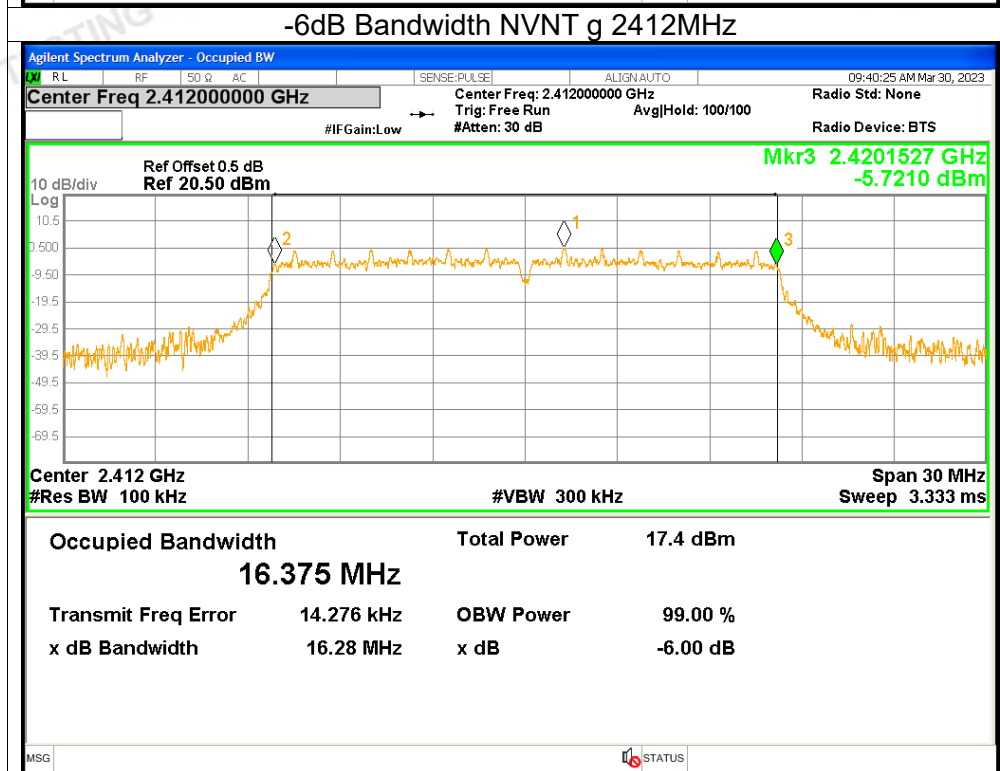
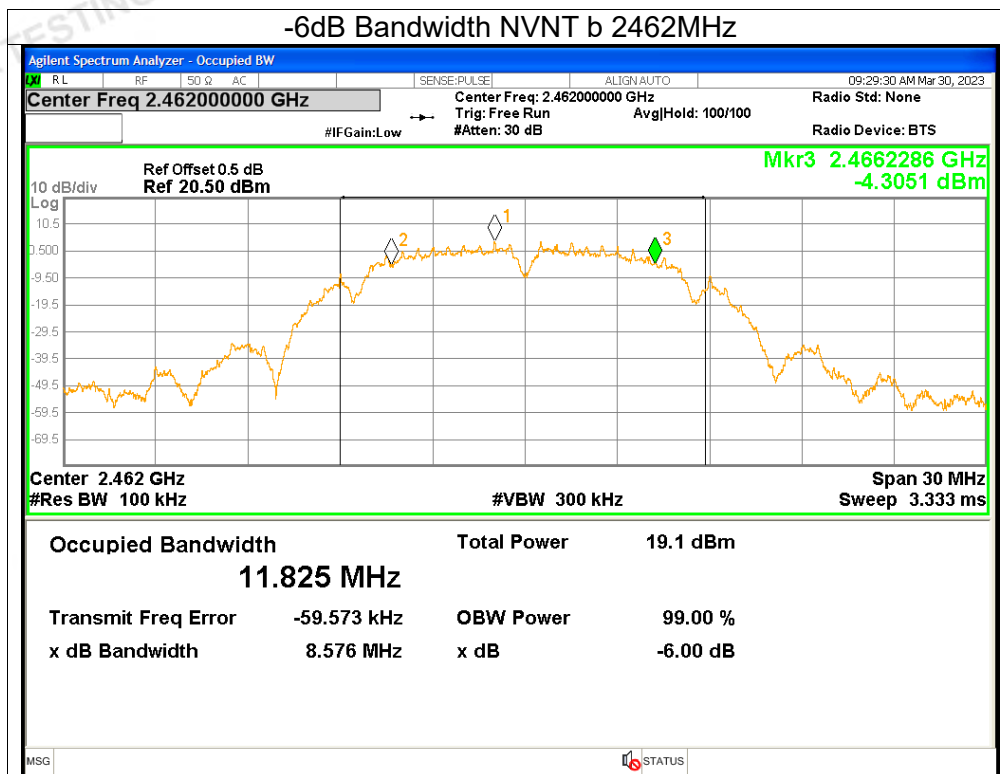

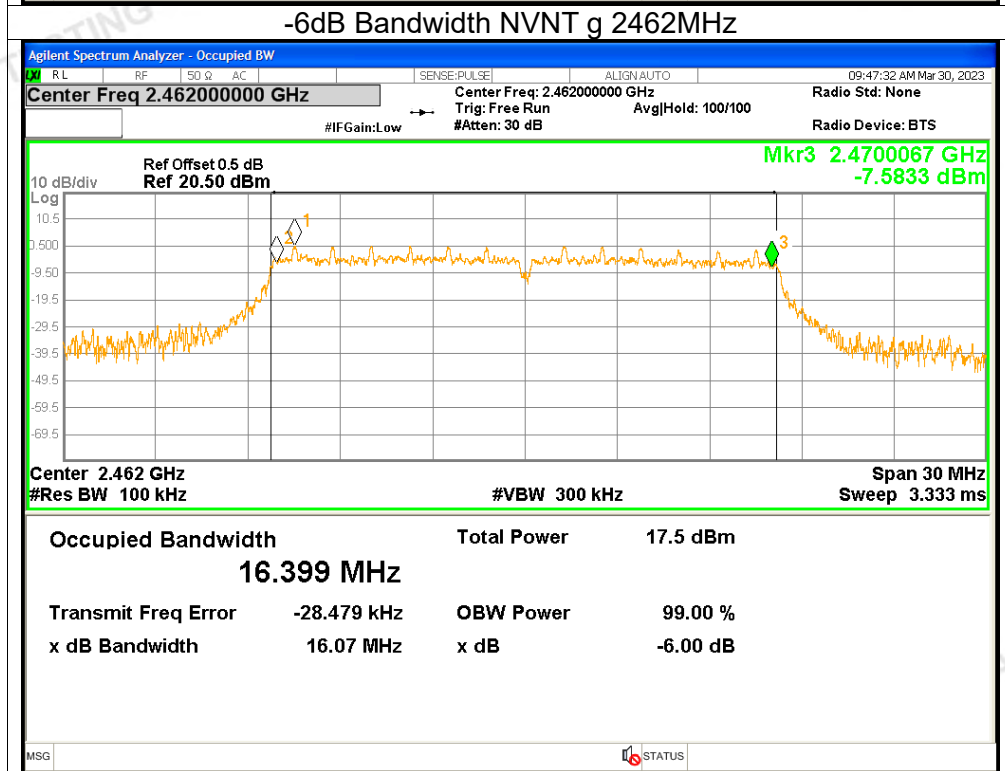
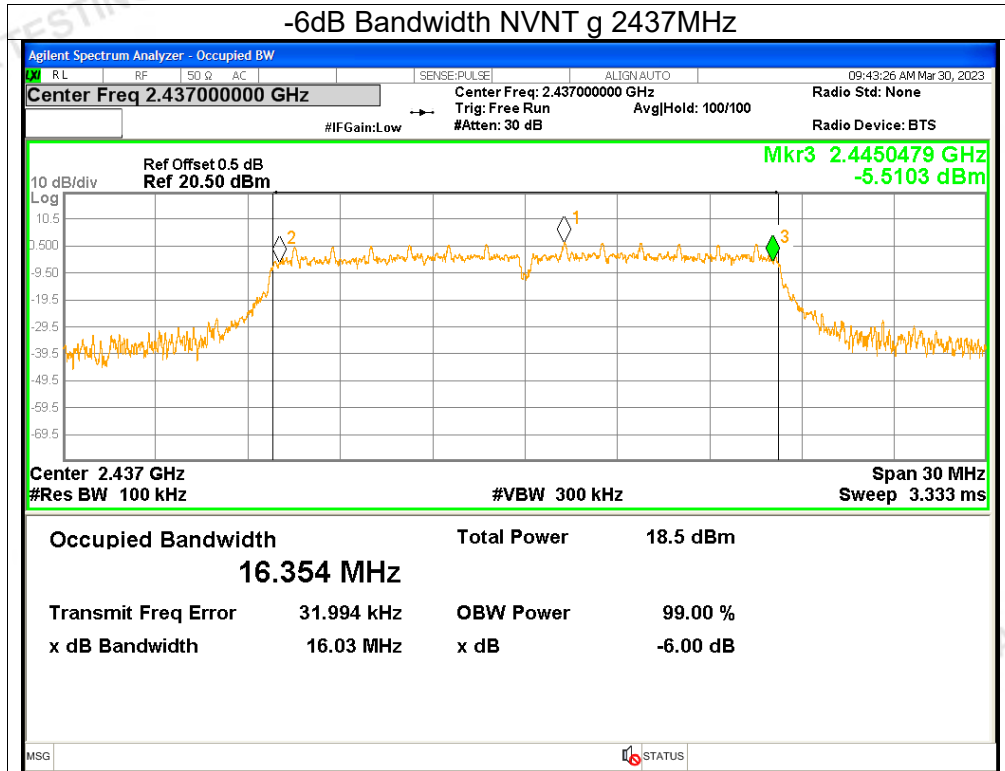

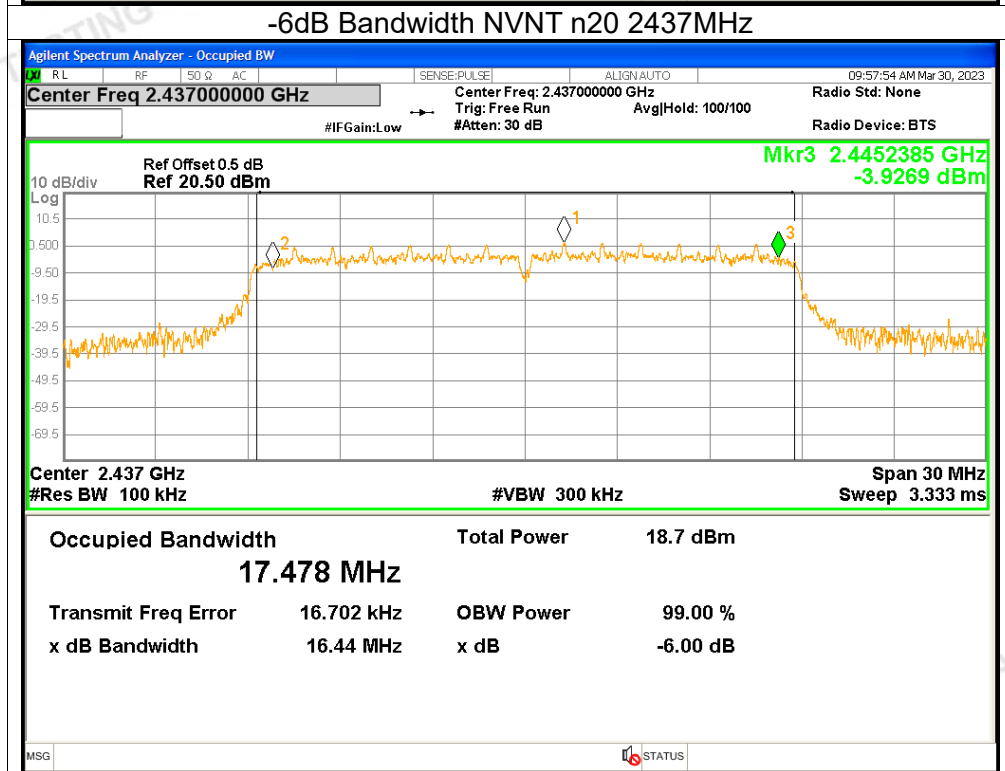
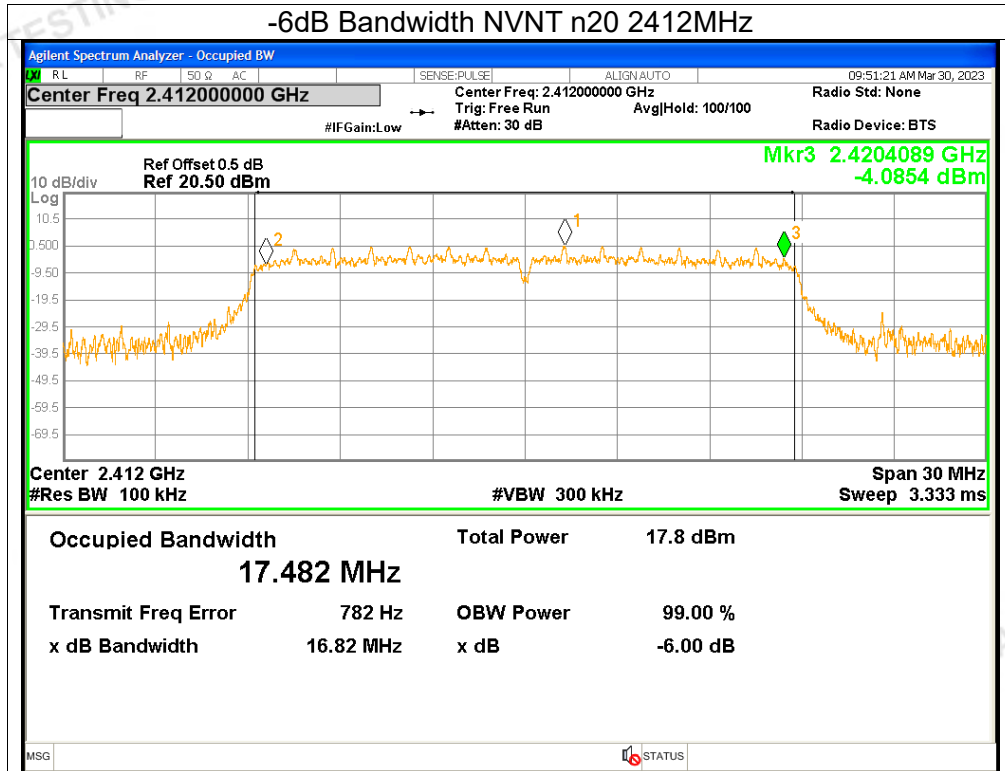

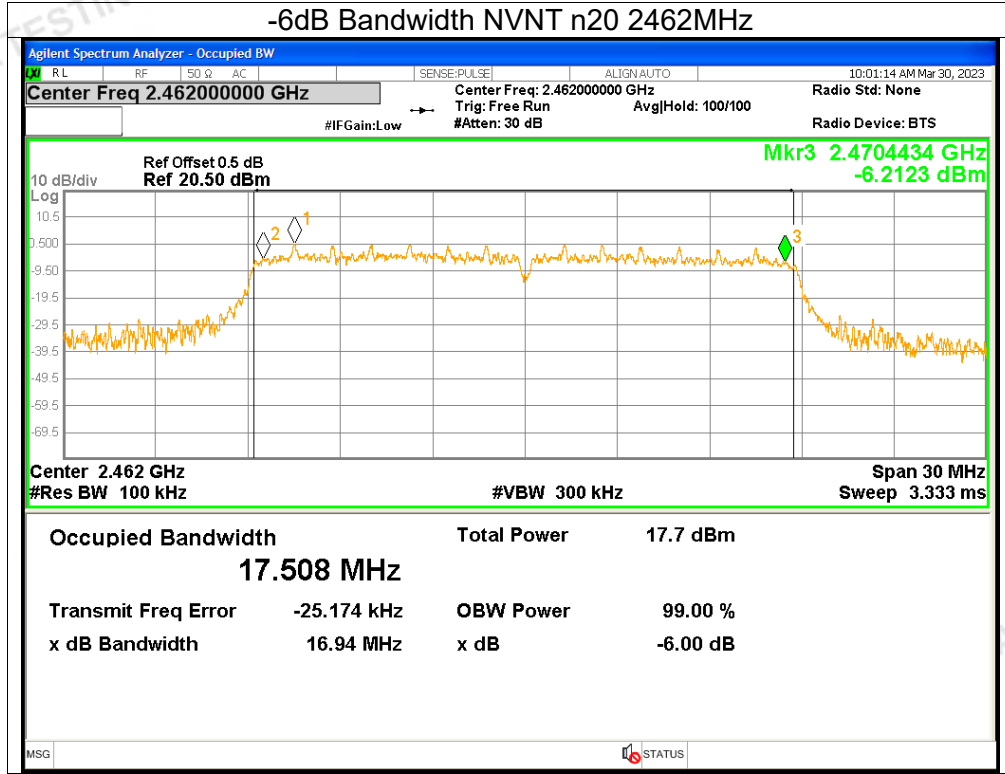

5. Maximum Power Spectral Density Level

Condition	Mode	Frequency (MHz)	PSD (dBm/3kHz)	Limit (dBm/3kHz)	Verdict
NVNT	b	2412	-10.81	<=8	Pass
NVNT	b	2437	-9.6	<=8	Pass
NVNT	b	2462	-10.24	<=8	Pass
NVNT	g	2412	-14.13	<=8	Pass
NVNT	g	2437	-10.23	<=8	Pass
NVNT	g	2462	-14.37	<=8	Pass
NVNT	n20	2412	-13.67	<=8	Pass
NVNT	n20	2437	-12.05	<=8	Pass
NVNT	n20	2462	-13.35	<=8	Pass

Test Graphs PSD NVNT b 2412MHz

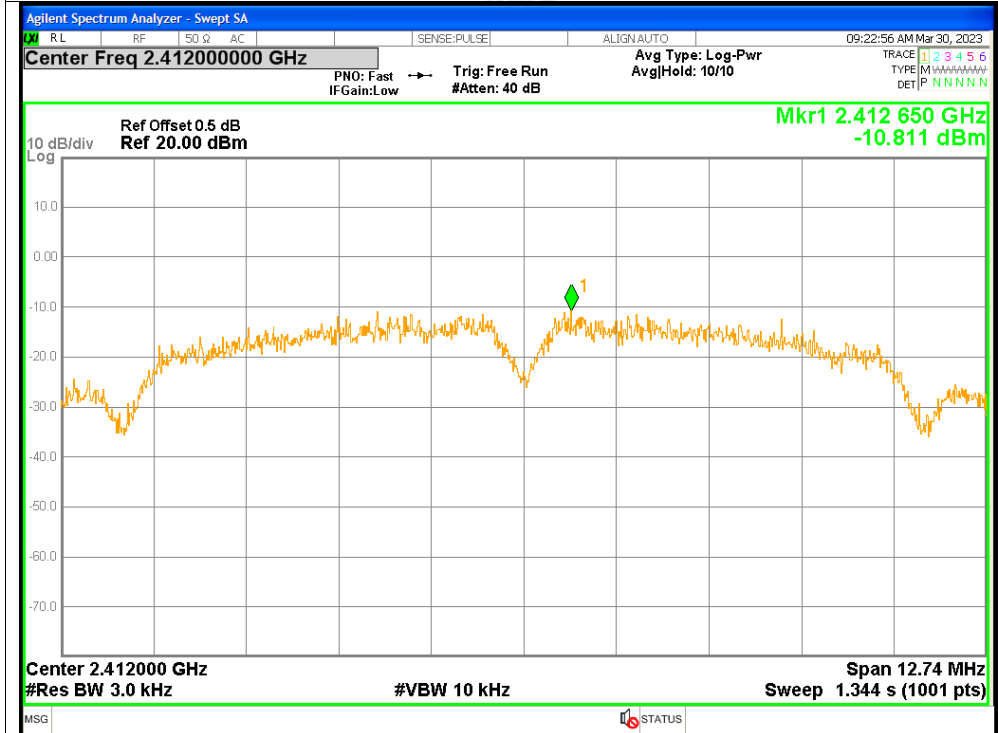

PSD NVNT b 2437MHz

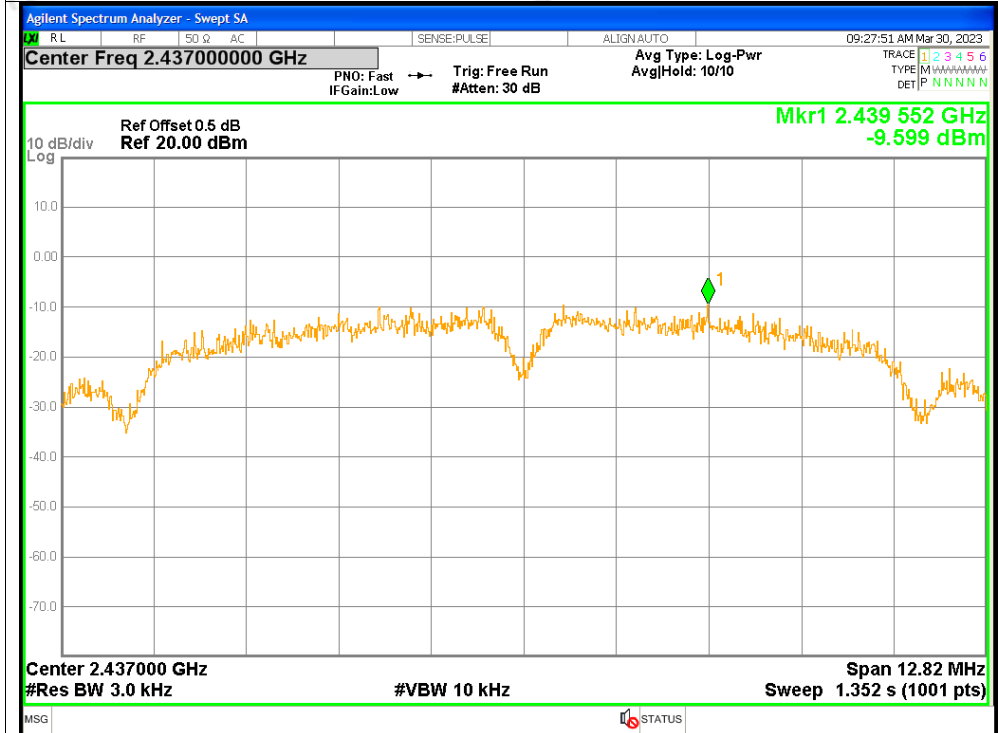

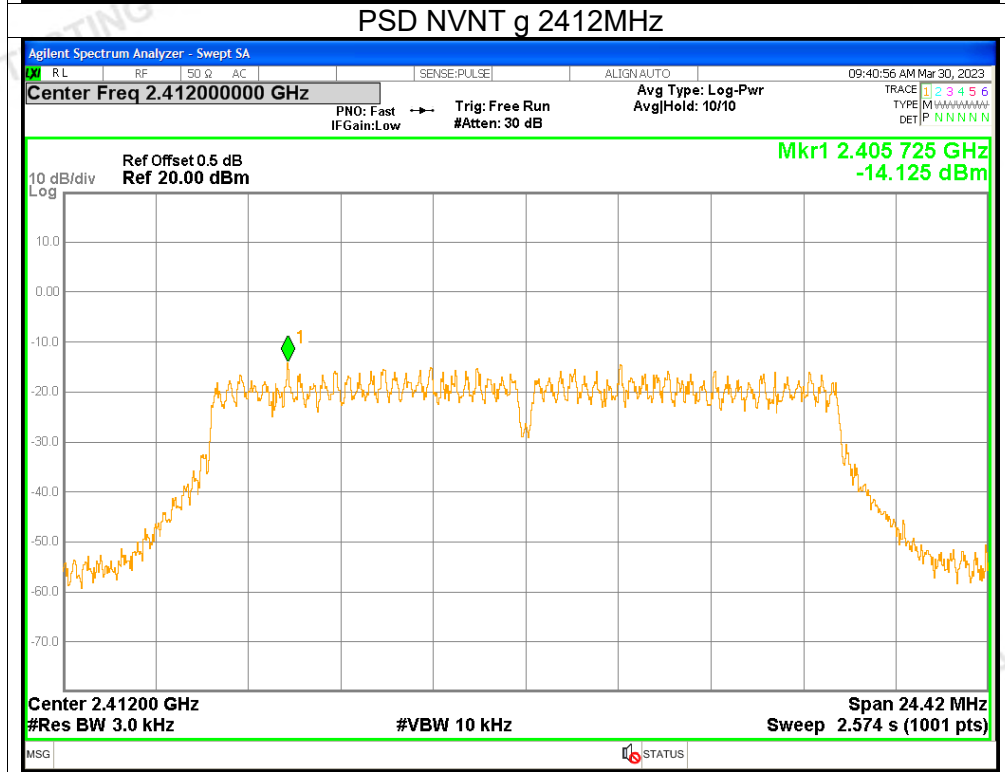
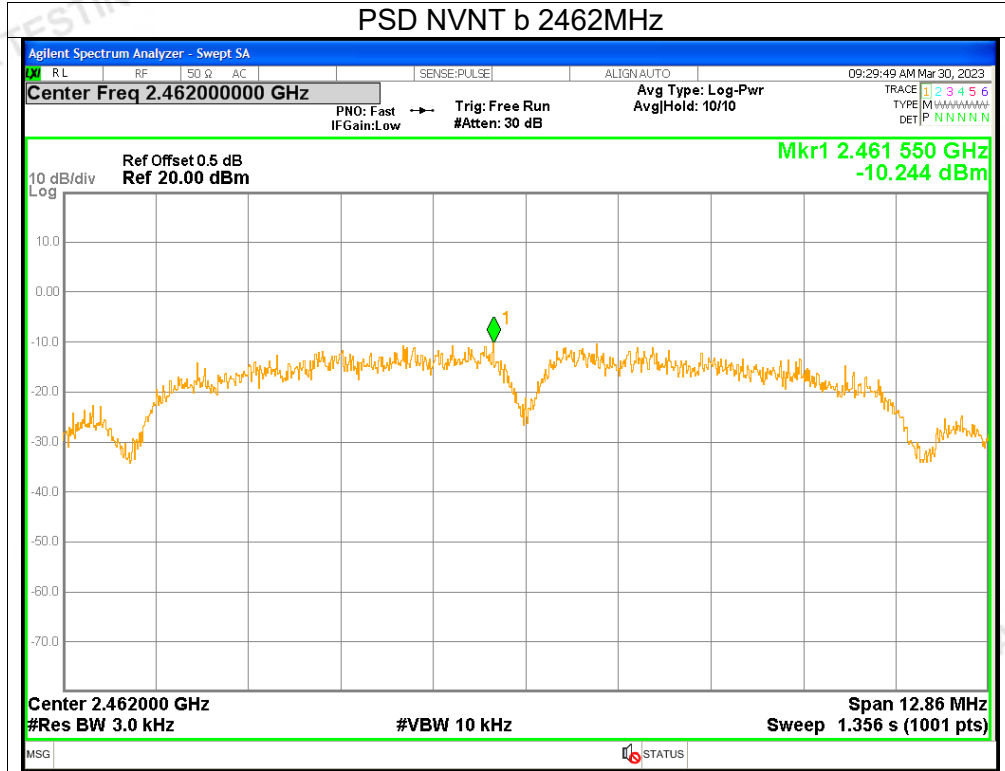

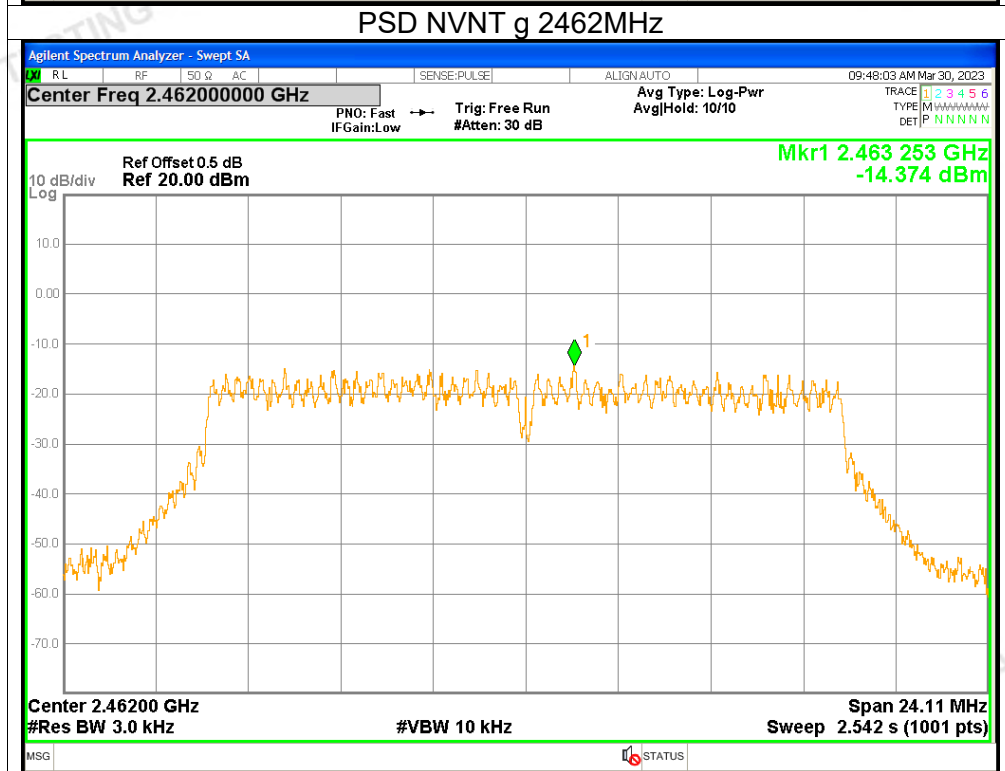
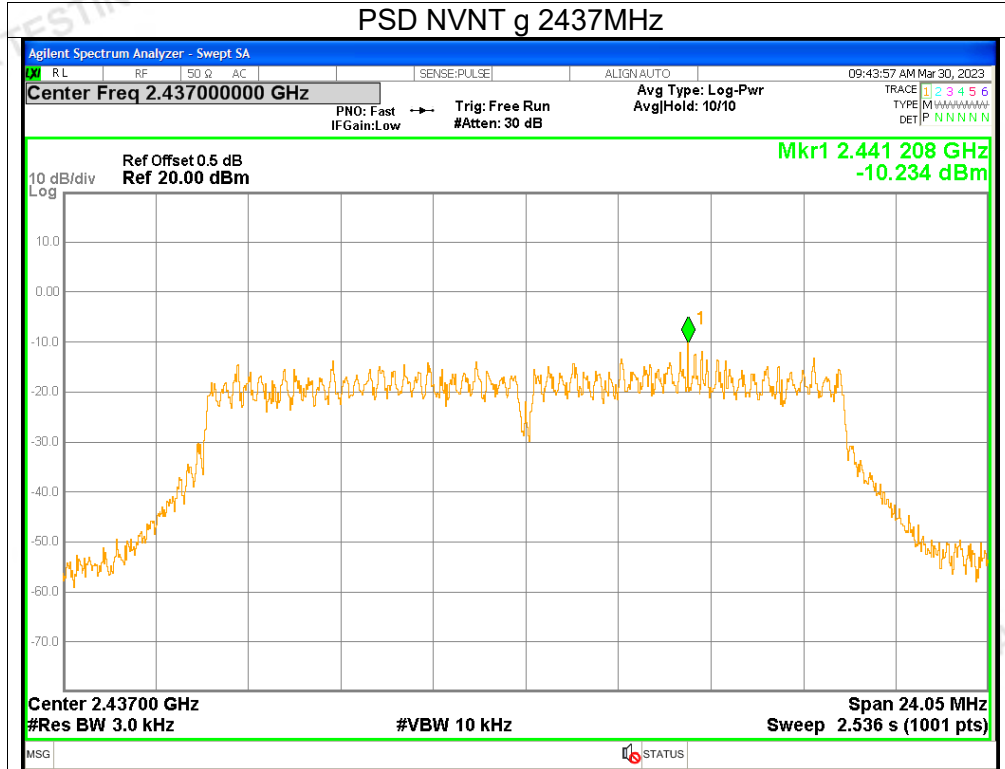

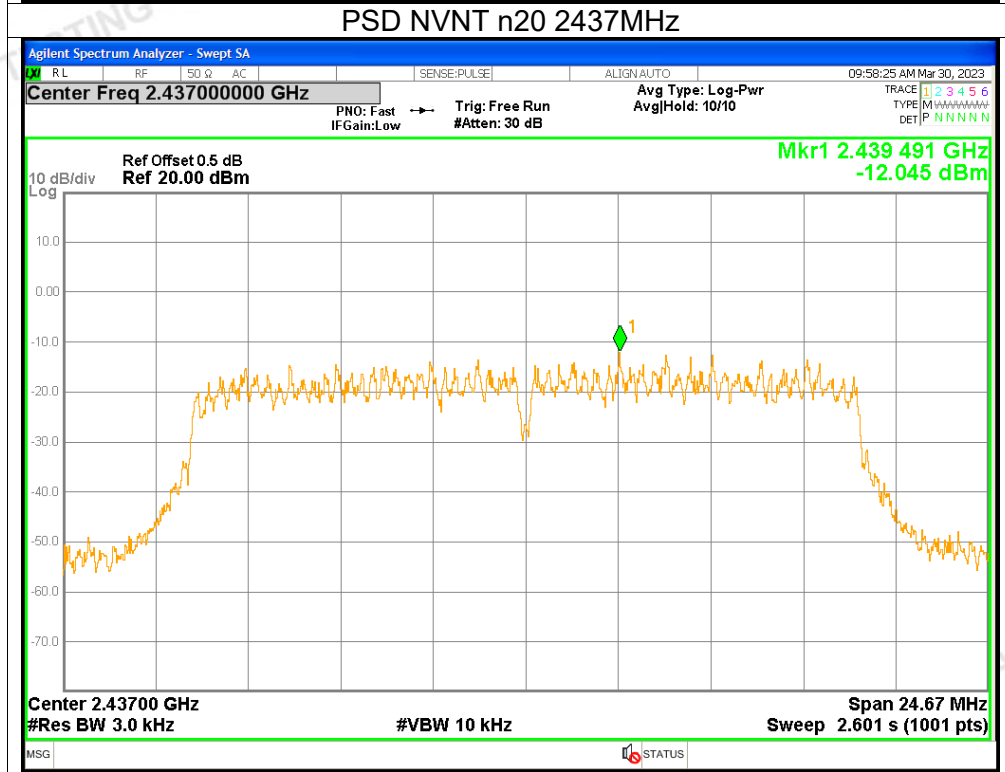
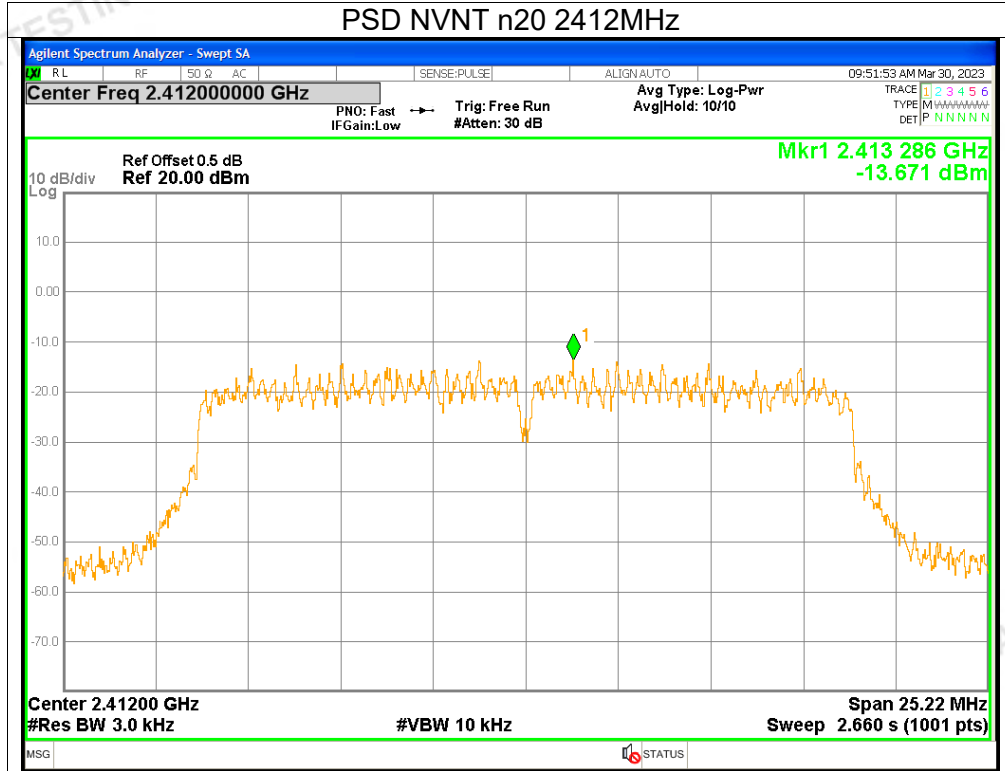

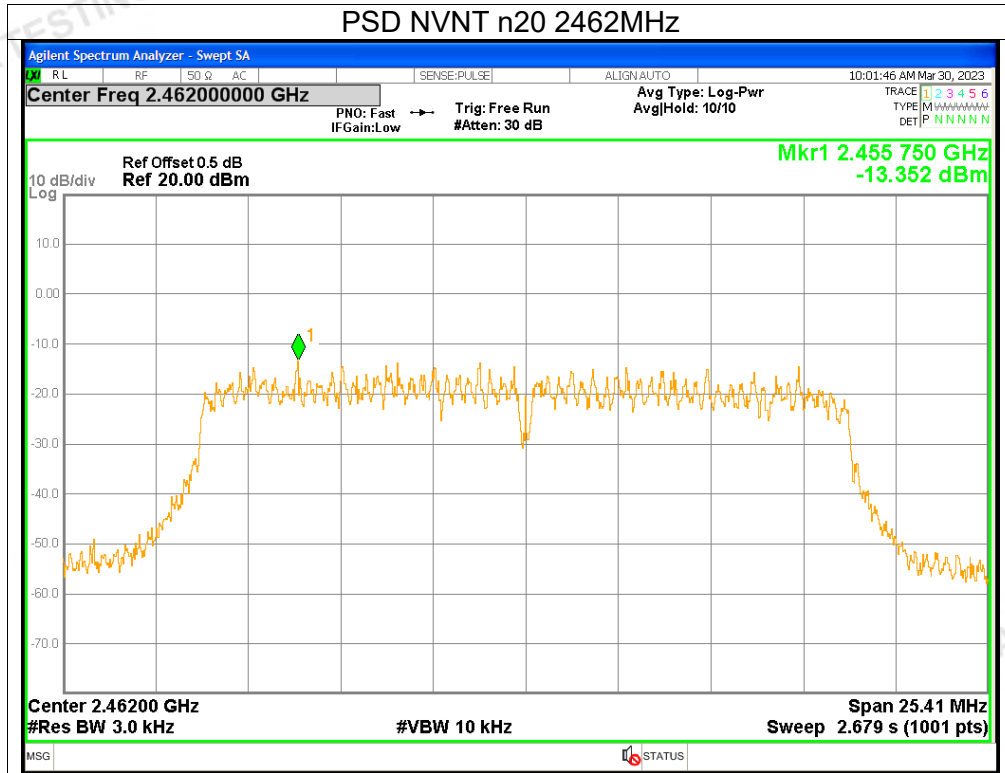

6. Band Edge

Condition	Mode	Frequency (MHz)	Max Value (dBc)	Limit (dBc)	Verdict
NVNT	b	2412	-50.86	<=-20	Pass
NVNT	b	2462	-62.99	<=-20	Pass
NVNT	g	2412	-30.66	<=-20	Pass
NVNT	g	2462	-43.68	<=-20	Pass
NVNT	n20	2412	-29.61	<=-20	Pass
NVNT	n20	2462	-42.3	<=-20	Pass

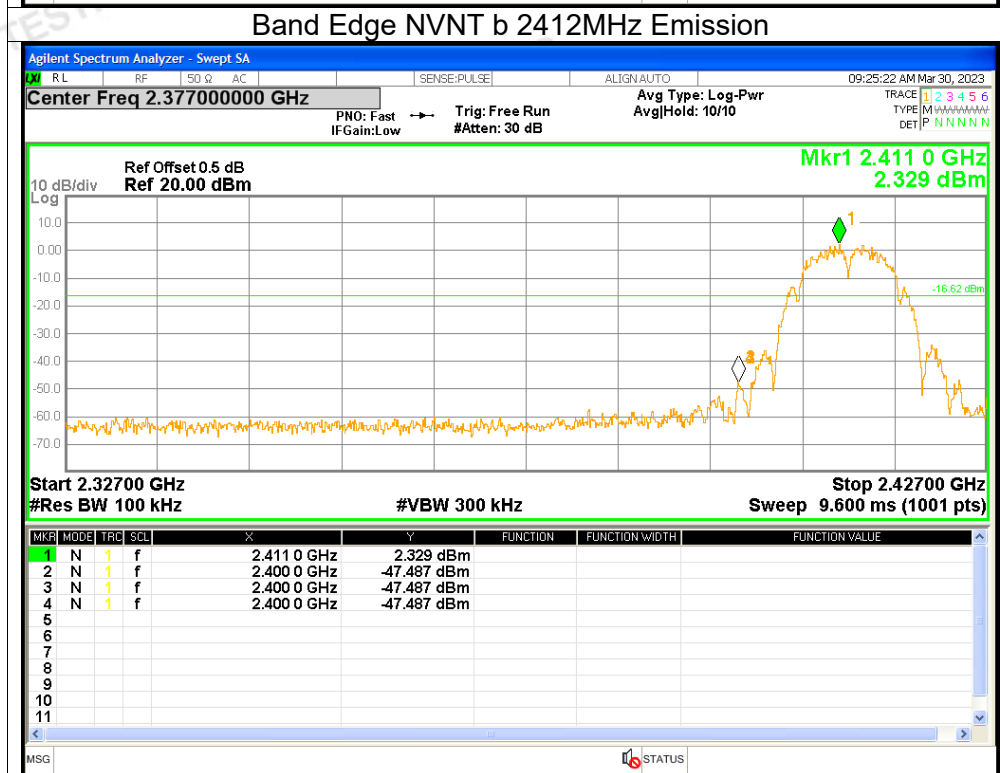
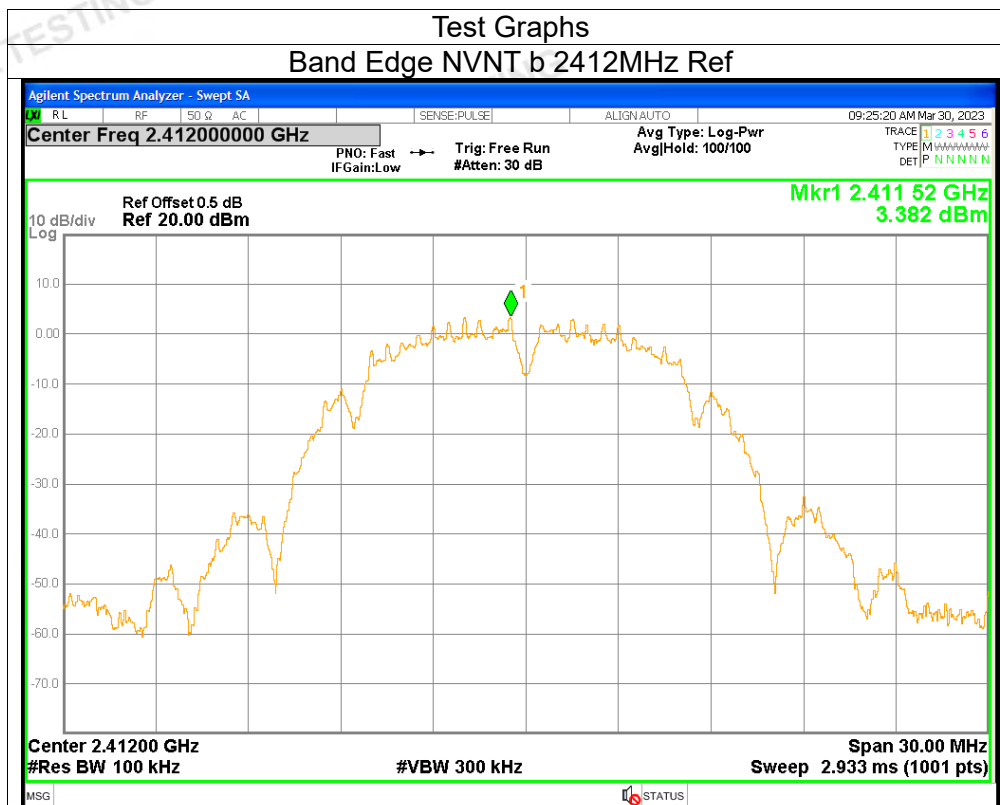

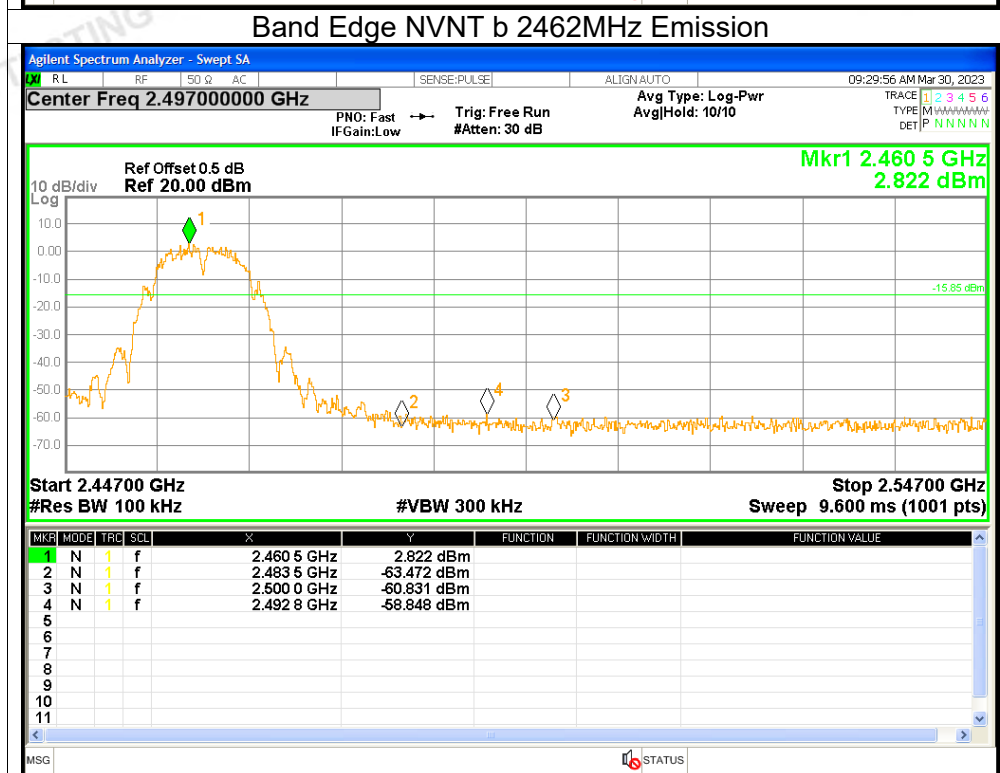
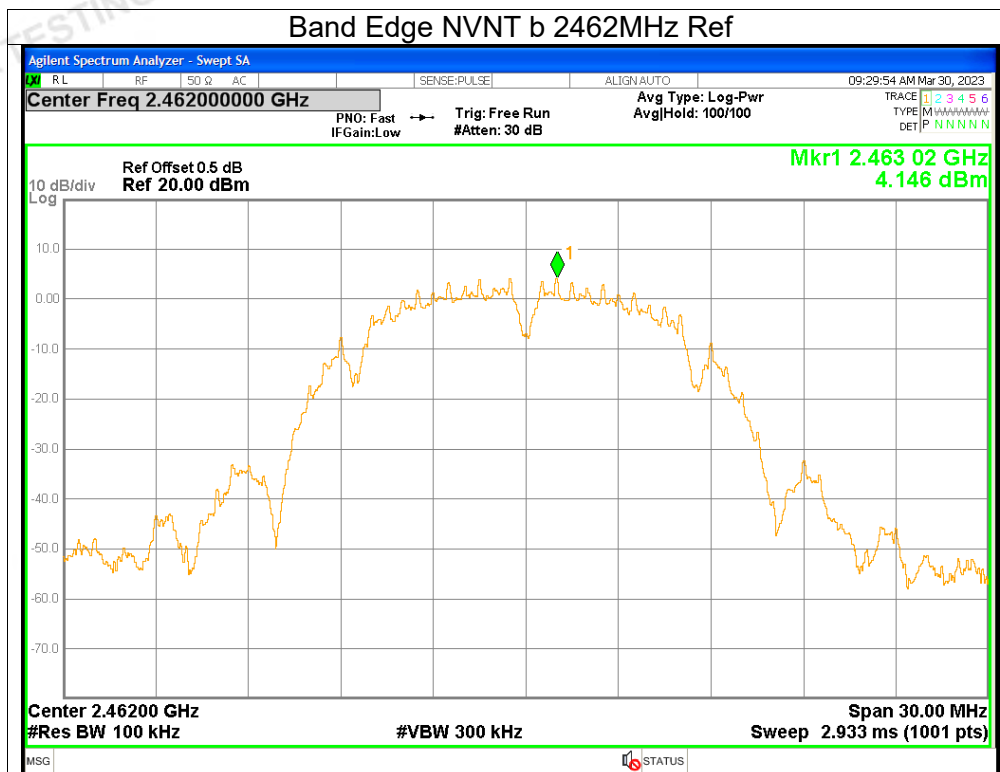

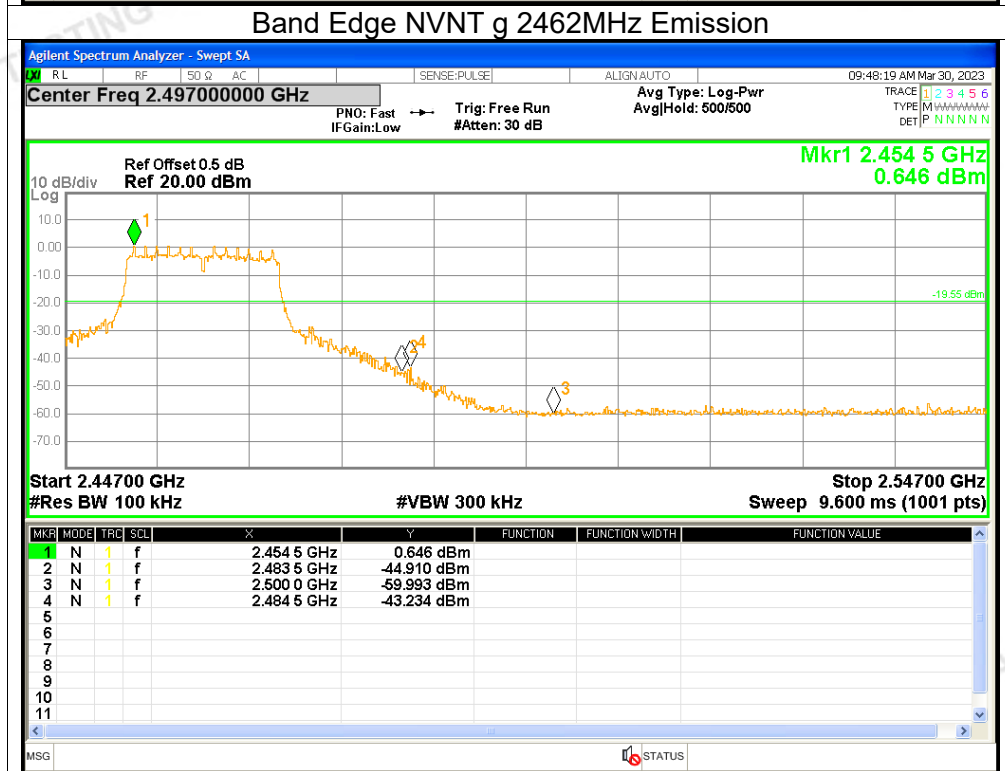
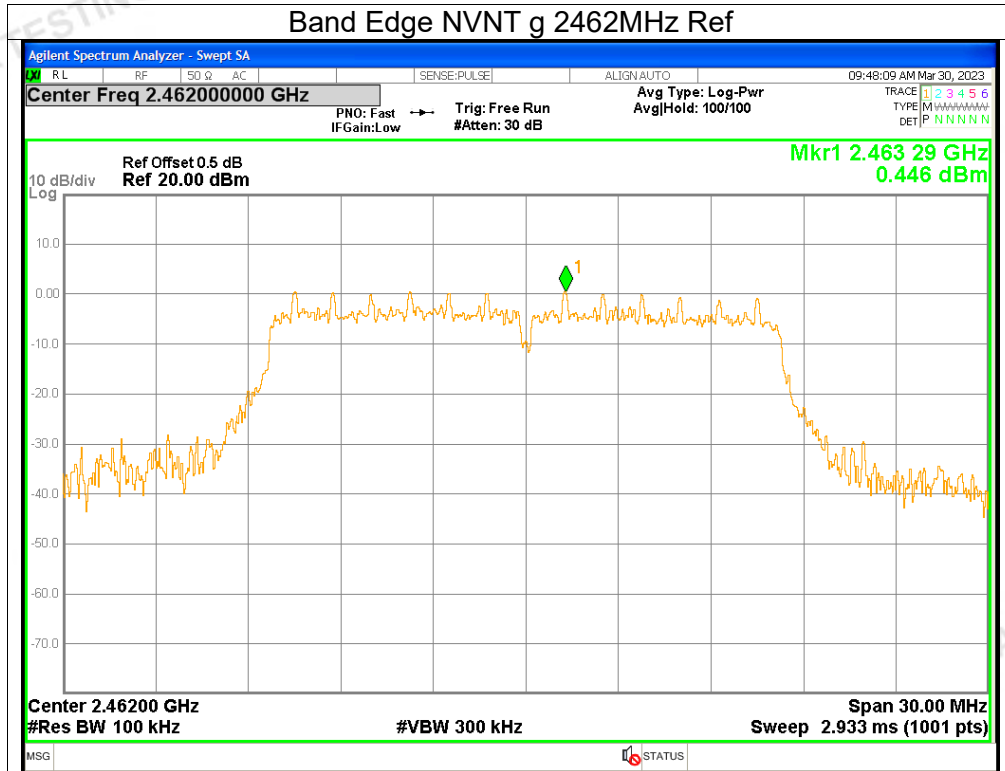

7. Conducted RF Spurious Emission

Condition	Mode	Frequency (MHz)	Max Value (dBc)	Limit (dBc)	Verdict
NVNT	b	2412	-49.57	<=-20	Pass
NVNT	b	2437	-51.82	<=-20	Pass
NVNT	b	2462	-50.51	<=-20	Pass
NVNT	g	2412	-46.9	<=-20	Pass
NVNT	g	2437	-47.88	<=-20	Pass
NVNT	g	2462	-47.5	<=-20	Pass
NVNT	n20	2412	-47.77	<=-20	Pass
NVNT	n20	2437	-48.28	<=-20	Pass
NVNT	n20	2462	-46.19	<=-20	Pass

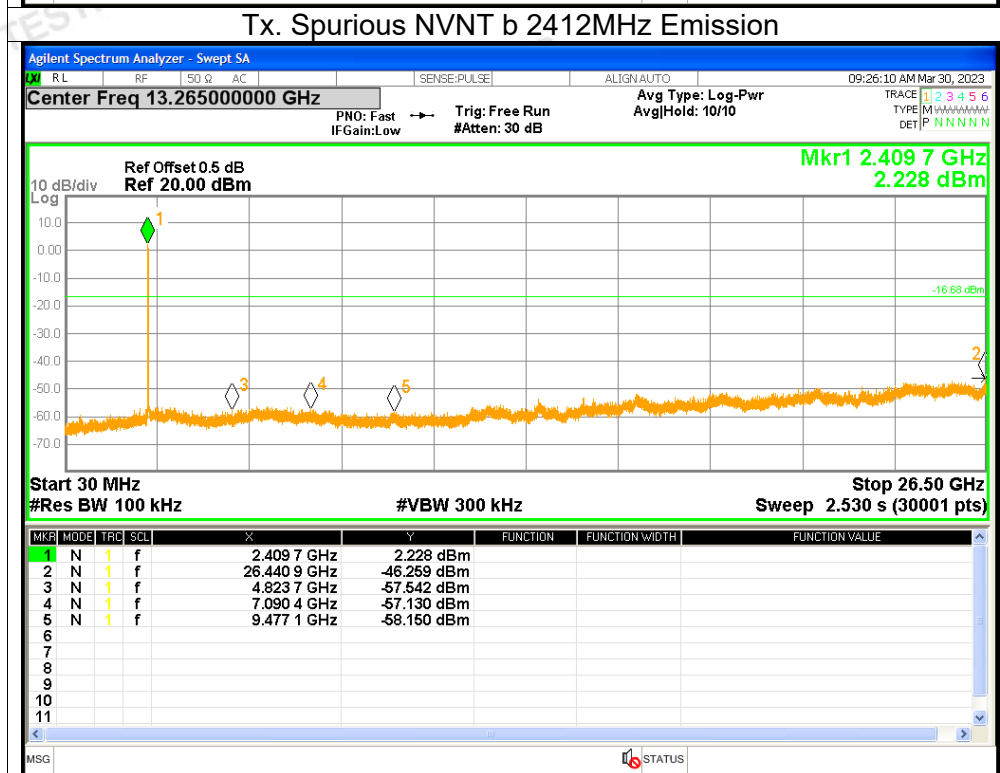
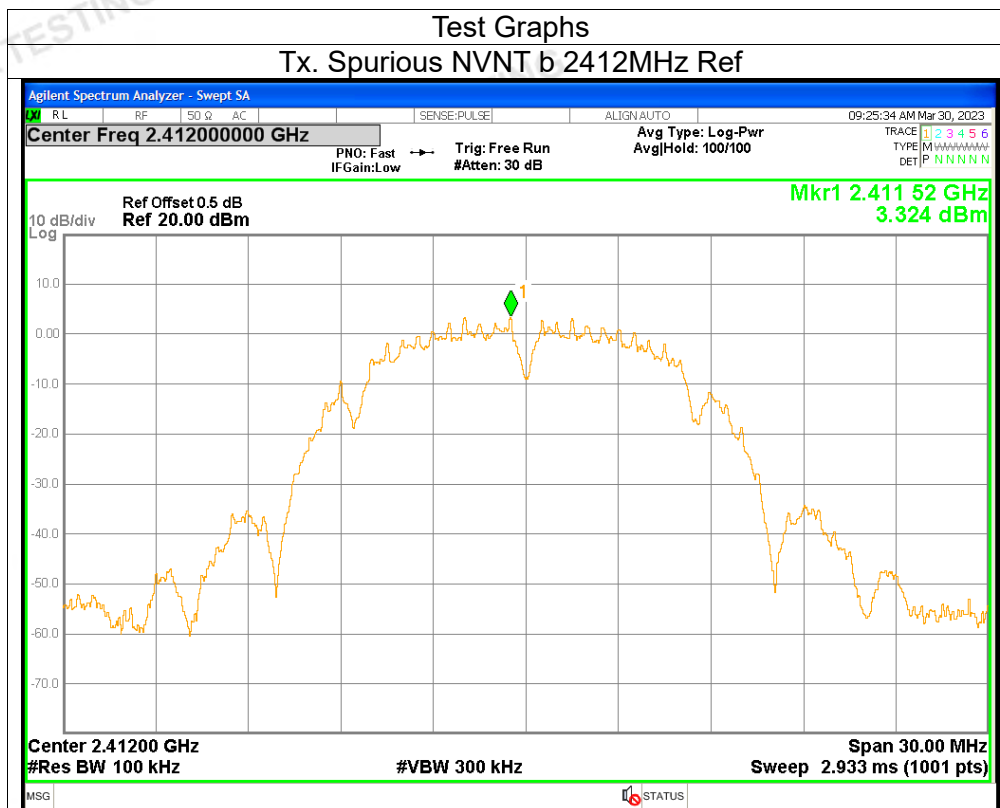

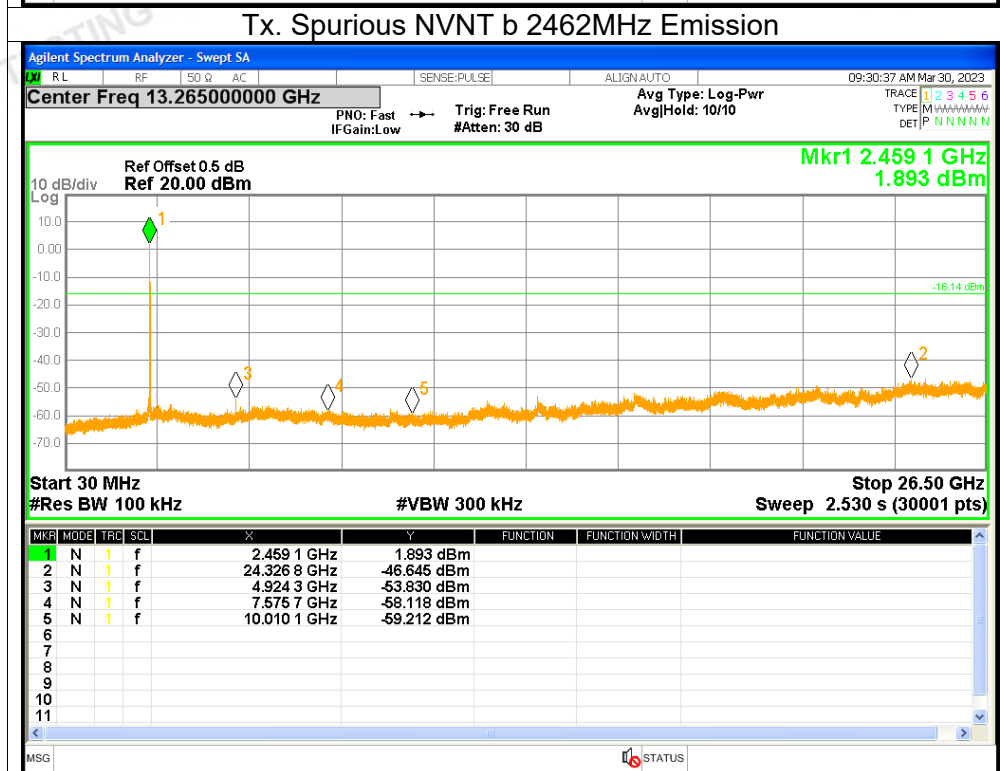
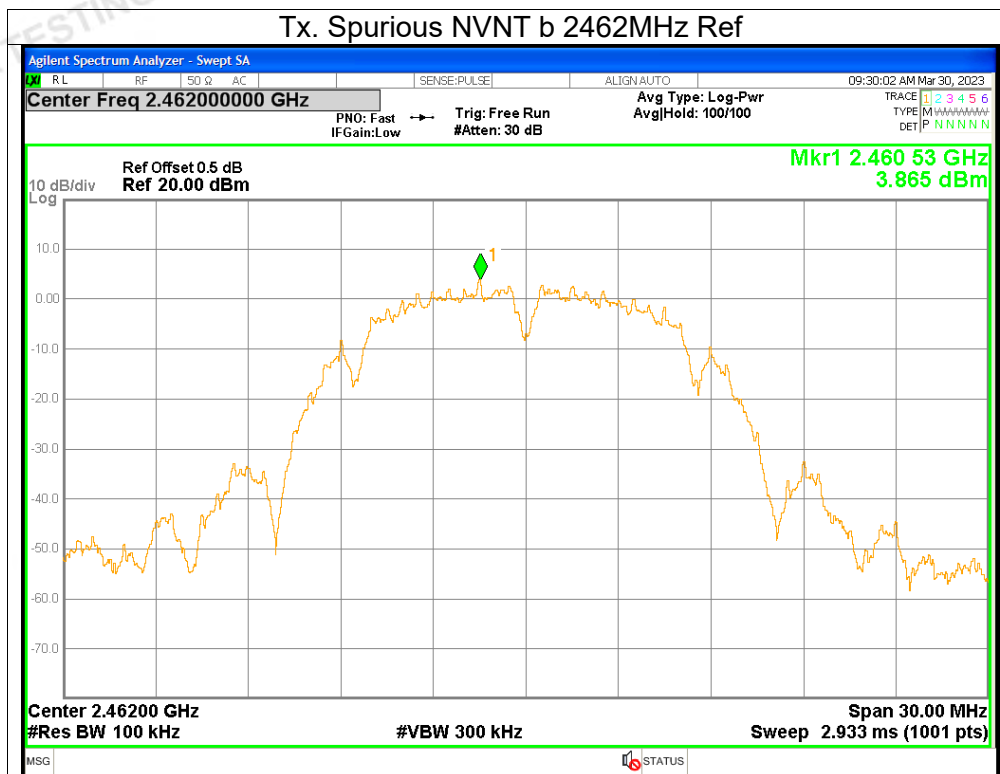

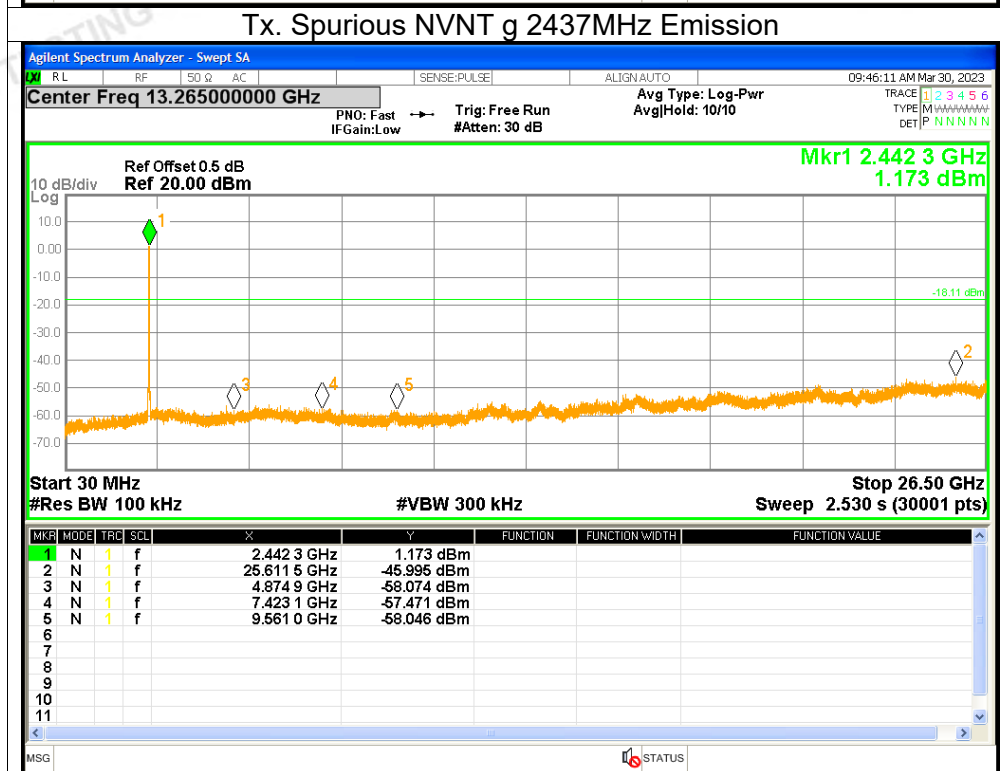
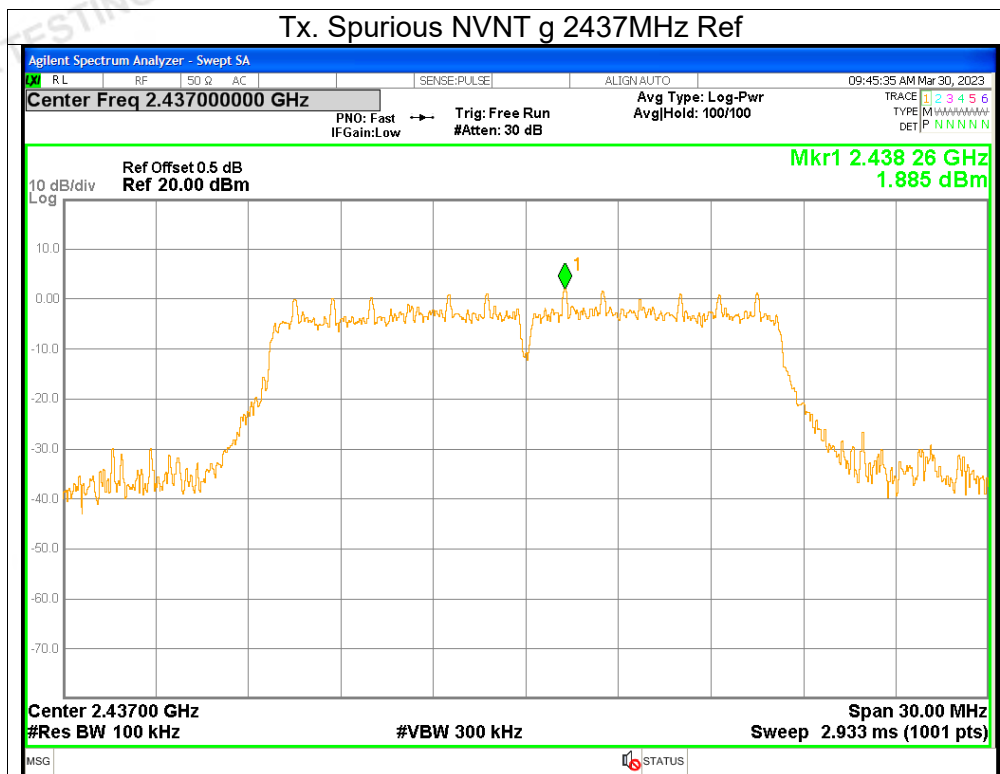

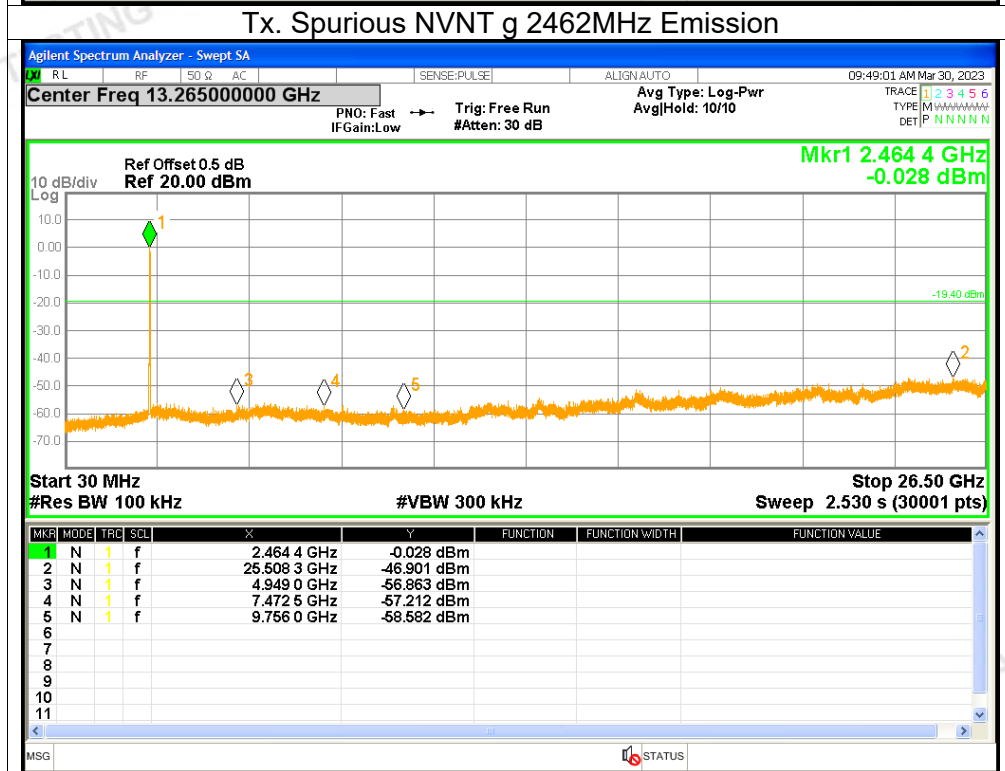
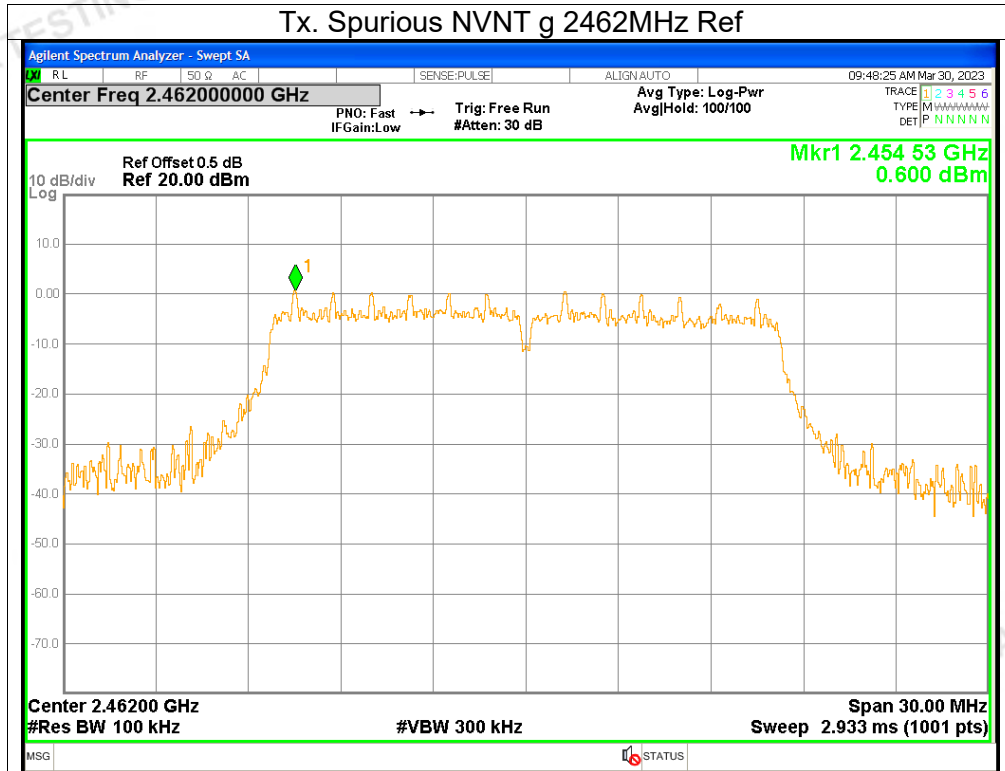

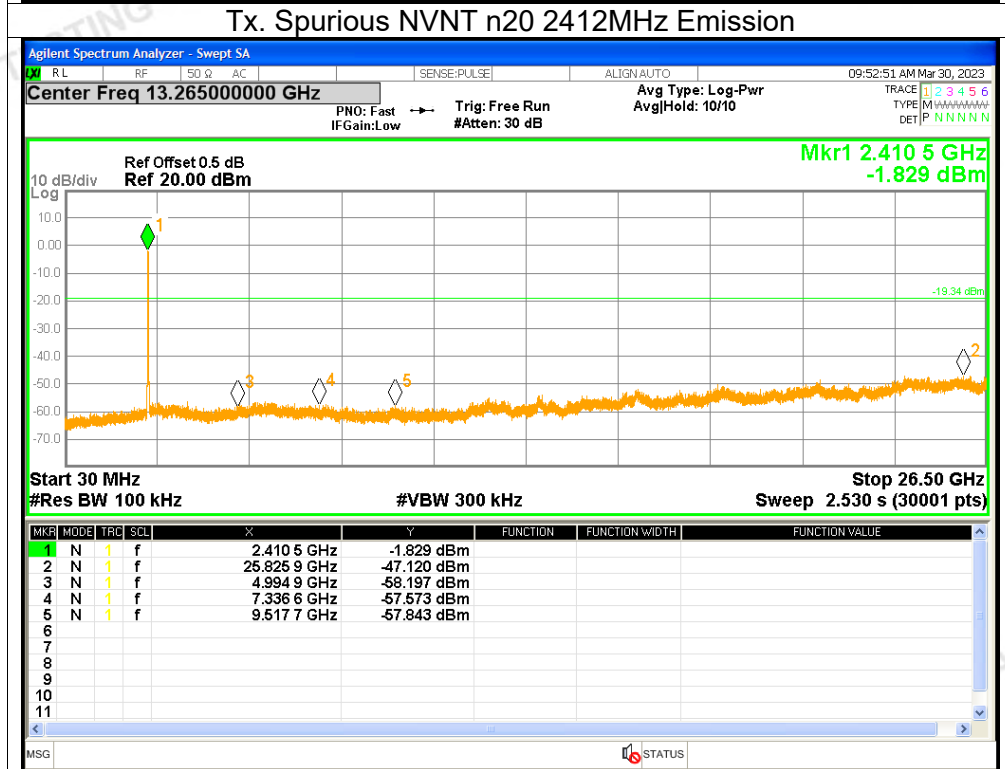
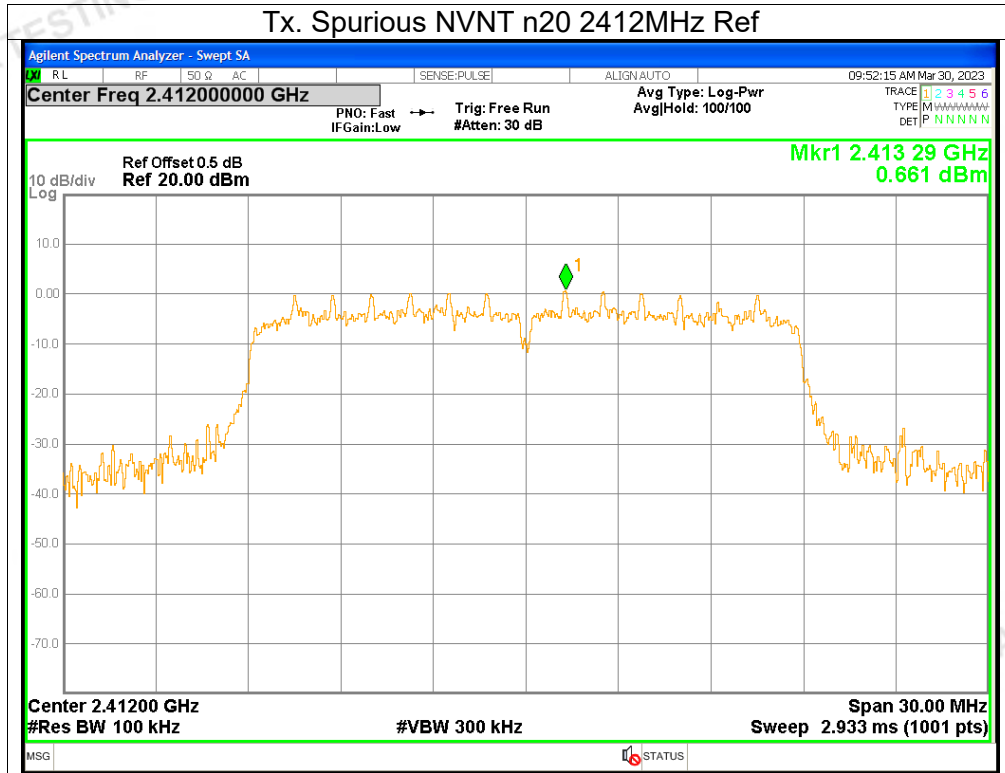

APPENDIX 2-PHOTOS OF TEST SETUP

Note: See test photos in setup photo document for the actual connections between Product and support equipment.

*****END OF THE REPORT*****